



Economic Impact Analysis of the Refractory Product Manufacturing NESHAP - Final Rule

EPA 452/R-03-004
February 2003

**Economic Impact Analysis of the Refractory Product
Manufacturing NESHAP - Final Rule**

Final Report

U.S. Environmental Protection Agency
Office of Air Quality Planning and Standards
Air Quality Strategies and Standards Division
Innovative Strategies and Economics Group
Research Triangle Park, North Carolina

CONTENTS

<u>Section</u>		<u>Page</u>
	Executive Summary	ES-1
1	Introduction	1-1
	1.1 Introduction	1-1
	1.2 Organization of this Report	1-2
2	Industry Profile	2-1
	2.1 The Supply Side	2-1
	2.1.1 Production Process, Inputs, and Outputs	2-1
	2.1.1.1 Machines Used in the Production Process	2-4
	2.1.1.2 Final Commodities	2-8
	2.1.1.3 Emissions and Controls in Refractory Manufacturing	2-10
	2.1.1.4 Inputs to Production of Refractory Products	2-10
	2.1.2 Types of Products	2-12
	2.1.3 Costs of Production	2-12
	2.1.3.1 Cost Data	2-12
	2.2 Industry Organization	2-17
	2.2.1 Refractory Manufacturing Facilities	2-17
	2.2.1.1 Refractories Database Facilities	2-17
	2.2.1.2 Facility Location	2-17
	2.2.2 Capacity Utilization	2-25
	2.2.3 Industry Concentration and Market Structure	2-27
	2.2.3.1 Measures of Industry Concentration	2-28
	2.2.3.2 Market Structure	2-29
	2.2.3.3 Small Businesses that Own Refractory Facilities	2-29
	2.2.4 Current Trends in the Refractory Industry	2-33
	2.3 The Demand Side	2-33
	2.3.1 Product Characteristics	2-34
	2.3.2 Uses and Consumers	2-34
	2.3.3 Substitution Possibilities in Consumption	2-37
	2.4 Markets	2-37
	2.4.1 Market Data	2-37

	2.4.1.1	Domestic Production	2-38
	2.4.1.2	International Trade	2-38
	2.4.2	Market Prices	2-40
	2.4.3	Industry Trends	2-40
3		Engineering Cost Analysis	3-1
	3.1	Overview of Emissions from Refractory Manufacturing	3-1
	3.2	Compliance Cost Estimates	3-2
	3.2.1	Emission Control Costs	3-4
	3.2.2	Compliance Testing Costs	3-5
	3.2.3	Monitoring, Recordkeeping, and Reporting Costs	3-5
	3.2.4	Total Annualized Costs	3-5
4		Economic Impact Analysis: Methods and Results	4-1
	4.1	Markets Affected by the Proposed NESHAP	4-1
	4.2	Conceptual Approach	4-2
	4.2.1	Producer Characterization	4-2
	4.2.2	Consumer Characterization	4-3
	4.2.3	Foreign Trade	4-4
	4.2.4	Baseline and With-Regulation Equilibrium	4-5
	4.2.4.1	Bricks and Shapes Market	4-5
	4.2.4.2	Monolithics and RCF Markets	4-6
	4.3	Economic Impact Results	4-6
	4.3.1	Market-Level Impacts	4-7
	4.3.2	Industry-Level Impacts	4-7
	4.3.2.1	Facility Closures and Changes in Employment	4-8
	4.3.3	Social Cost	4-9

5	Small Business Impacts	5-1
5.1	Identify Small Entities	5-1
5.2	Economic Analysis	5-2
5.3	Assessment	5-3
	References	R-1
	Appendix A: Overview of Refractories Market Model	A-1
	Appendix B: Economic Welfare Impacts on Refractory Industry	B-1

LIST OF FIGURES

<u>Number</u>		<u>Page</u>
2-1a	Refractory Manufacturing Process Flow Diagram	2-2
2-1b	Specific Production Processes	2-3
2-2	Mixing and Kneading Machines	2-5
2-3	Vacuum Press (Friction, Hydraulic Press)	2-6
2-4	Friction Press (A), and Hydraulic Screw Press (B)	2-6
2-5	Vibrating Press	2-6
2-6	Cross Section of CIP	2-6
2-7	Tunnel Kiln	2-7
2-8	Round Kiln with Downdraft	2-8
2-9	Shuttle Kiln	2-8
2-10	Clay and Nonclay Refractory Manufacturers' Expenditures	2-13
2-11	Location of Refractory Manufacturing Facilities	2-26
2-12	Historical Refractory Production Trends	2-38
4-1	Supply Curve for a Representative Directly Affected Facility	4-3
4-2	Market Equilibrium for Bricks and Shapes Refractories without and with Regulation	4-4

LIST OF TABLES

<u>Number</u>		<u>Page</u>
2-1	Types and Descriptions of Refractories Produced	2-9
2-2	Types and Characteristics of Raw Materials used in Refractory Manufacture Type	2-11
2-3	Labor, Material, and New Capital Expenditures for Clay Refractory Manufacturers (NAICS 327124) (\$10 ⁶)	2-14
2-4	Labor, Material, and New Capital Expenditures for Nonclay Refractory Manufacturers (NAICS 327125) (\$10 ⁶)	2-15
2-5	Costs of Materials Used in Refractory Production and Manufacture	2-16
2-6	Selected Refractory Manufacturers, by Type	2-18
2-7	Number of Refractory Manufacturing Facilities by State	2-25
2-8	Full Production Capacity Utilization Rates for Clay and Nonclay Refractories: Fourth Quarters 1993 through 1998	2-27
2-9	Market Concentration Measures for SIC 3255 Clay Refractory Manufacturing and SIC 3297 Nonclay Refractory Manufacturing	2-28
2-10	Characteristics of Small Businesses in the Refractory Industry	2-30
2-11	Characteristics and Types of Refractories	2-35
2-12	Steel and Nonferrous Production (10 ³ Metric Tons)	2-37
2-13	Production of Refractories: 1977–1998 (\$10 ⁶)	2-39
2-14	Exports and Imports of Refractories: 1993–1999 (\$10 ⁶ 1998)	2-40
2-15	Average Price for Refractory Products (\$/ton)	2-41
3-1	Summary of Revised Annual Compliance Costs for Refractory Products Manufacturing NESHAP	3-3
4-1	Market-Level Impacts: 1998	4-7
4-2	Industry-Level Impacts: 1998	4-8
4-3	Distributional Impacts Across Facilities: 1998	4-9
4-4	Distribution of Social Costs: 1998	4-10
5-1	Summary of SBREFA Screening Analysis: 1998	5-2
5-2	Small Business Impacts: 1998	5-3

EXECUTIVE SUMMARY

The U.S. Environmental Protection Agency's (EPA's) Office of Air Quality Planning and Standards (OAQPS) has developed National Emission Standards for Hazardous Air Pollutants (NESHAP) under Section 112 of the 1990 Clean Air Act for the refractory manufacturing industry. This economic impact analysis (EIA) of the NESHAP for the refractory products manufacturing industry provides information about the estimated costs and economic impacts of the final rule. This section presents a summary of the costs of complying with the NESHAP and the estimated economic impacts resulting from these costs.

ES.1 Costs of Compliance

Out of 147 facilities producing refractory products, the Agency has identified eight refractory manufacturing facilities as possible major sources of HAPs. Of these eight, six are projected to incur emissions control costs to comply with the NESHAP and the other two are projected to incur only recordkeeping and reporting costs. Five facilities are estimated to incur costs to install and operate emissions control capital equipment. Based on the model, EPA expects the sixth facility will close its operation because the costs of control will exceed revenue. The capital costs of control technology range from \$383,400 to \$1.37 million and total \$4.6 million. The total annualized costs of the NESHAP are \$2.31 million, including \$655,700 in annualized capital costs; \$1,419,400 in annual operating and maintenance costs for emissions controls; and \$239,100 in monitoring, recordkeeping, and reporting costs. Among the facilities incurring costs, the total annualized costs range from \$1,200 to \$677,600 and average \$289,275 per facility.

ES.2 Estimated Economic Impacts of the Refractories NESHAP

EPA used a simulation model of the market for refractory products to estimate impacts of the NESHAP, including changes in market prices and quantities for refractory products; changes in costs, revenues, profits, and output for refractory manufacturers; and impacts on companies owning refractory manufacturing facilities, including impacts on small businesses.

EPA estimates that the price for refractory products will be essentially unchanged, and the quantity of refractory products produced domestically will decrease by less than 0.3 percent. One refractory manufacturing facility is projected to become unprofitable and shut down under the rule unless it chooses to become a nonmajor source by altering its production processes. Overall, eight facilities incurring compliance costs are projected to become less profitable and reduce their output, while 139 facilities not incurring costs are projected to remain

as profitable as without the rule. Overall, the net effect of the rule is to decrease the industry's profit. Despite a single facility closure, output and employment are projected to decline only slightly as a result of the rule. EPA estimates the social cost of the rule (computed as described in Appendix B) to be \$2.09 million, representing entirely a loss in industry profitability.

For its analysis, EPA defined small businesses as those with 750 employees or fewer. EPA estimates that 56 of the 76 companies owning refractory manufacturing facilities may be small businesses. Three of the facilities incurring compliance costs are owned by small businesses, but none of them is projected to incur costs exceeding 1 percent of sales. Thus, the Agency does not project any significant adverse economic impacts for small businesses as a result of the rule.

SECTION 1 INTRODUCTION

1.1 Introduction

A refractory is a material that retains its shape and chemical identity when subjected to high temperatures and is used in applications that require extreme resistance to heat. Specifically, refractories must be able to withstand temperatures above 538°C (1000°F). Refractories are mechanically strong and heat resistant to withstand rapid temperature change and corrosion and erosion by molten metal, glass, slag, and hot gas. Refractories are used in kilns, furnaces, boilers, incinerators, and other applications.

Section 112 of the Clean Air Act lists 189 hazardous air pollutants (HAPs) and requires EPA to develop a list of categories of industries that emit HAPs. Section 112 then states that every major source of HAPs emissions will be required to reduce emissions to levels that are equivalent to the average of the top 12 percent of the best performers. The Act defines major sources as those facilities that emit or have the potential to emit at least 10 tons per year of any single HAP or at least 25 tons per year of any combination of HAPs.

Refractory products manufacturing facilities have been identified as sources of several HAPs. The specific types and quantities of HAPs emitted from any particular facility are largely a function of the types of raw materials used and how those materials are processed. Many processes are used to produce refractory products. These processes can emit phenol, formaldehyde, methanol, and ethylene glycol, depending on the type of resin used. When used as binders or additives in the production of nonresin-bonded refractory shapes, ethylene glycol and methanol also are emitted from shape dryers and kilns. Pitch-bonded refractory heated pitch storage tanks, shape dryers, and kilns emit polycyclic organic matter (POM). The heated pitch storage tanks, shape preheaters, defumers, and coking ovens used to produce pitch-impregnated refractories also emit POM. Hydrogen fluoride (HF) and hydrochloric acid (HCl) are emitted from kilns that are used to fire clay refractory products. Exposure to these substances has been demonstrated to cause adverse health effects such as irritation of lung, skin, and mucous membranes; effects on the central nervous system; and damage to the liver, kidneys, and skeleton. Formaldehyde and POM have also been listed as probable human carcinogens. EPA estimates that, of 147 refractory manufacturing facilities currently in operation, eight facilities may be major sources of HAPs. The Agency estimates that six of the eight major sources of HAPs will incur incremental costs to comply with the NESHAP, beyond recordkeeping costs.

Emissions are treated as a free good but have a cost to society. These externalities include emission effects on humans and ecosystems. Environmental regulations such as this NESHAP reduce these externalities and attempt to assign some of the costs of the pollution to

the polluter. The major sources of HAPs in the refractory products industry that incur costs to reduce emissions will face economic consequences. The economic impacts to these eight facilities will also affect the prices and quantities of refractories in the industry's market. This report evaluates the economic impacts associated with the NESHAP and reports estimated changes in price, production, profitability of facilities, and impacts to sensitive subsectors of the market, such as small businesses and foreign trade.

1.2 Organization of this Report

This EIA report is organized as follows. Section 2 provides a detailed description of the production process for refractories, with discussion of individual refractory products, inputs, costs of production, demand, industry organization, and market structure for the refractories industry. Section 3 describes the estimated costs of complying with the NESHAP. Section 4 discusses the economic impact analysis methodology and presents the results of the analysis. Section 5 presents the results of analyses to assess the impacts of the rule on small businesses. Appendix A describes the methodology in detail and Appendix B describes computation of social cost.

SECTION 2

INDUSTRY PROFILE

In this section, we provide a summary profile of the refractory products industry in the United States, including the technical and economic aspects of the industry that must be addressed in the economic impact analysis. Section 2.1 provides an overview of the production processes and the resulting types of refractory products. Section 2.2 summarizes the organization of the U.S. refractory products industry, including a description of U.S. manufacturing plants, the companies that own these plants, and the markets for refractory products. Finally, Section 2.3 presents historical data on the refractory product industry, including U.S. production and consumption and foreign trade.

2.1 The Supply Side

Estimating the economic impacts associated with the options to regulate the refractory manufacturing industry requires characterizing the industry. This section describes the production process and inputs to and outputs of this process. In addition, characterizing the supply side of the industry involves describing various types of refractory products, by-products, and input substitution possibilities. This section also describes costs of production and economies of scale.

2.1.1 *Production Process, Inputs, and Outputs*

The manufacturing process for refractories depends on the particular combination of chemical compounds and minerals used to produce a specified level of thermal stability, corrosion resistance, thermal expansion, and other qualities. Refractory manufacturing involves four processes: raw material processing, forming, firing, and final processing. Figure 2-1a illustrates the basic refractory manufacturing process, and Figure 2-1b depicts specific production processes for various refractory products. The production of refractories begins with processing raw material. Raw material processing involves crushing and grinding raw materials, classifying by size, calcining, and drying. The processed raw materials may then be dry-mixed with other minerals and chemical compounds, packaged, and shipped as product.

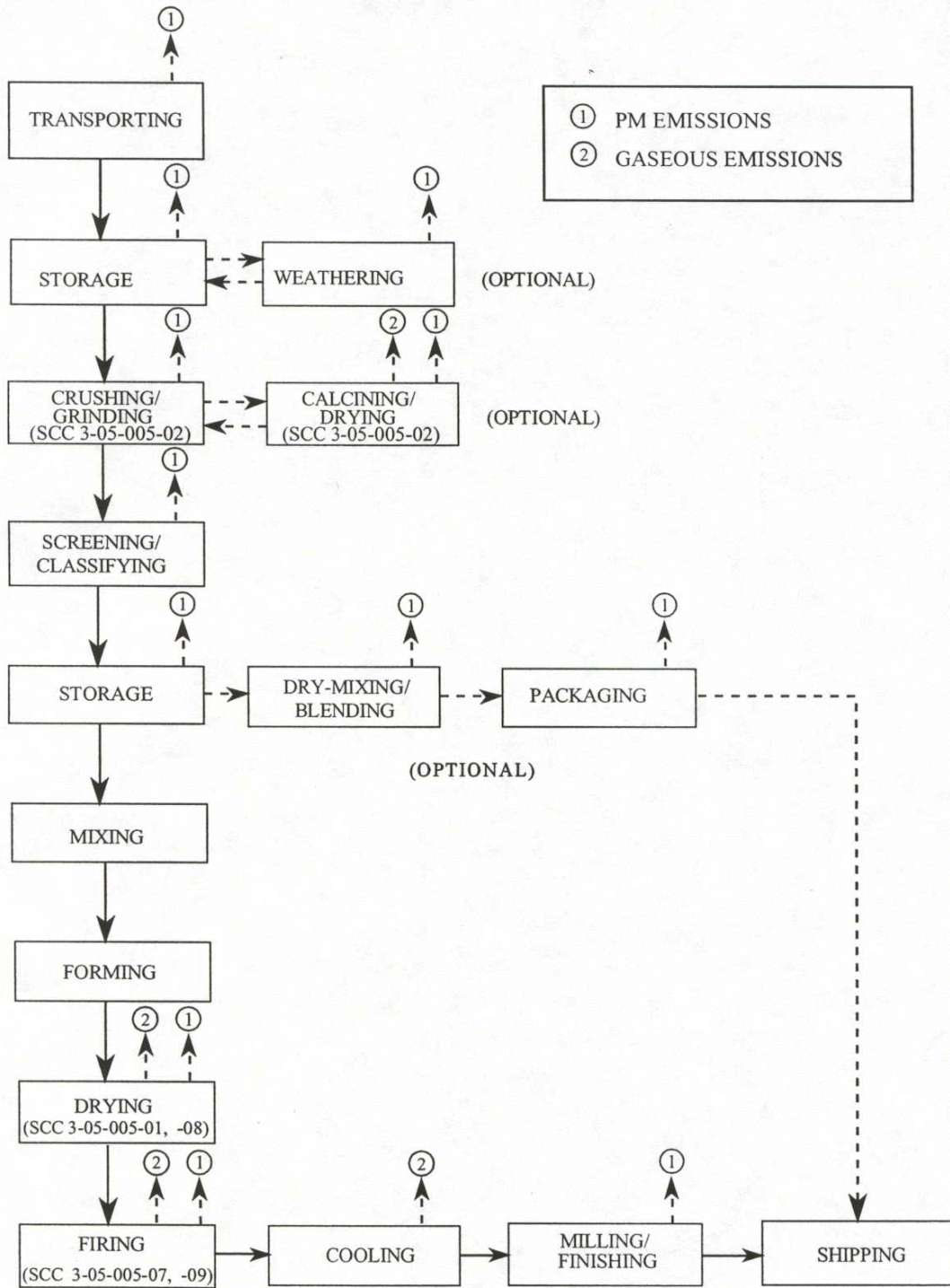

Figure 2-1a. Refractory Manufacturing Process Flow Diagram

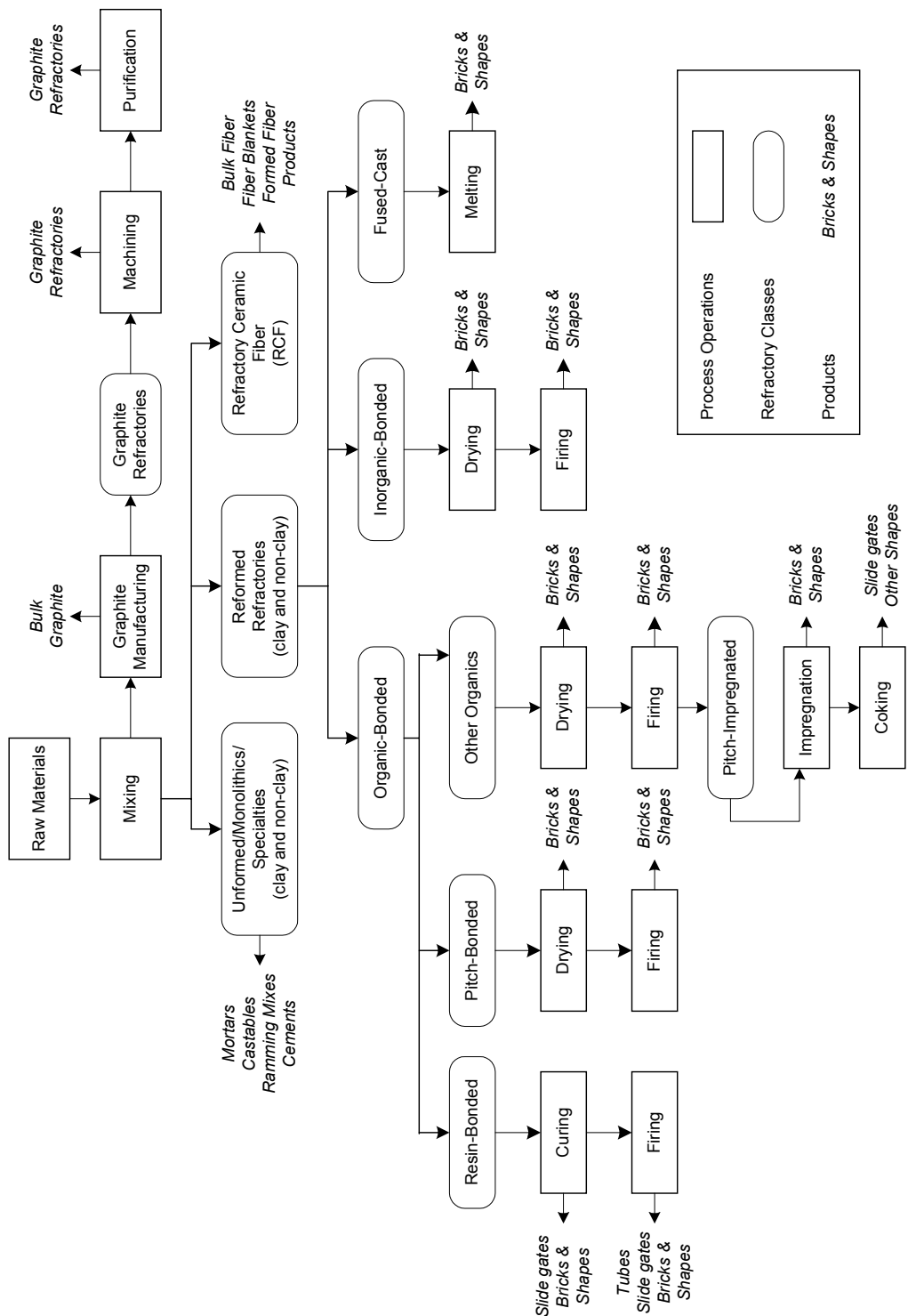

Figure 2-1b. Specific Production Processes

Following the mixing process, the raw materials are formed into desired shapes. Liquids are added to the dry raw materials to facilitate adhesion in the pressing/forming phase. After the refractory is formed, the material is fired. Firing involves heating the refractory material to high temperatures in a periodic batch or continuous tunnel kiln to form a ceramic bond. This process gives the raw materials their refractory properties. The final processing stage includes milling, grinding, and sandblasting the finished product. For some products, final processing may also include impregnation with tar and pitch and product packaging (EPA, 1994; The Technical Association of Refractories, Japan, 1998).

2.1.1.1 Machines Used in the Production Process

Several types of machines are used to produce refractories: mixing/kneading machines, presses, and kilns.

Mixing/Kneading Machines. Figure 2-2 illustrates different machines used to mix or knead refractory products. There are two types of mixing and kneading machines: fixed vessel and driven vessel. Mixing homogenizes more than two types of bulk materials, and kneading machines make a uniform coating layer. Mixing and kneading machines are equipped with mixing blades or muller wheels. Heating, cooling, or de-airing equipment may also be applied to the vessel. Mixing and kneading machines are used for manufacturing shaped and unshaped refractories. Unshaped refractories, however, are not processed any further (The Technical Association of Refractories, Japan, 1998).

Presses. Refractory pressing machines are broadly categorized into three groups: impact and static, vibrating, and cold isostatic press. Choosing between the three groups of presses largely depends on the type of raw materials used.

- C Impact and Static Presses: Figure 2-3 illustrates a friction and a hydraulic screw press, two types of impact presses. Figure 2-4 is a diagram of a hydraulic screw press, a type of static press. Impact and static presses are typically equipped with a vacuum deaerator. Impact presses have a higher allowable maximum compacting force than static presses. However, static presses are finding increasing application in the production of sophisticated refractories such as submerged nozzles and shrouds and in the production of industrial ceramics. Bricks formed with static presses are flat, uniform, and compact (The Technical Association of Refractories, Japan, 1998).

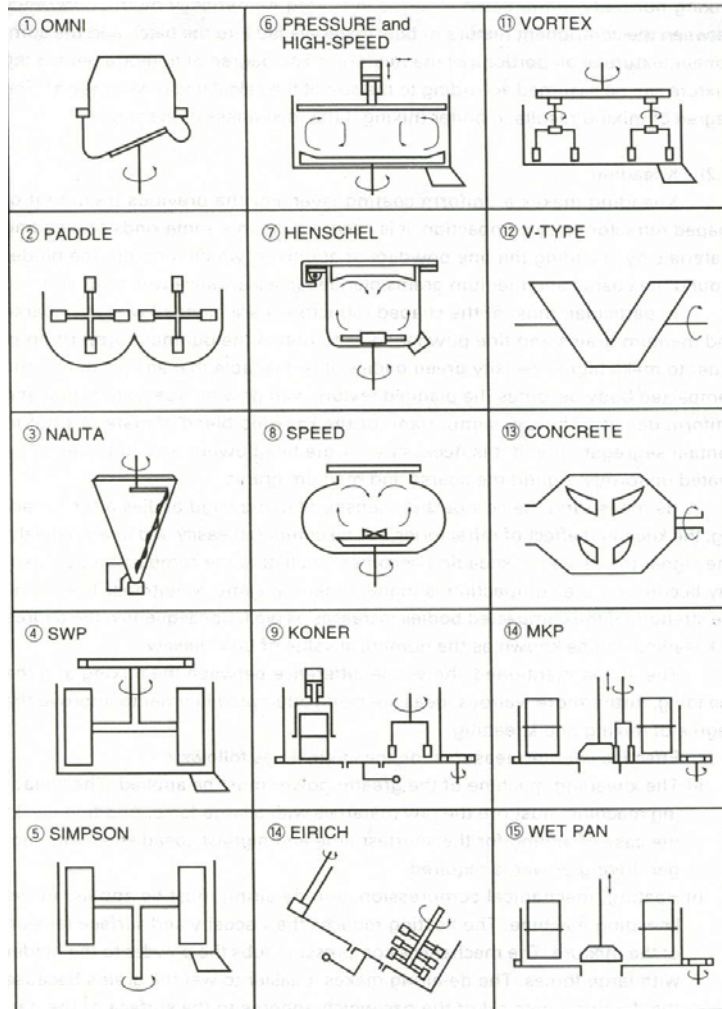

Figure 2-2. Mixing and Kneading Machines

- C Vibrating Press: Vibrating presses, shown in Figure 2-5, are classified into two types: air cylinder type and hydraulic cylinder. The vibrator in the air cylinder type is attached to the table, and the air cylinder compacts the material. The hydraulic vibrating press is constructed with the hydraulic pulse generator attached to the pressure block, and the hydraulic cylinder compacts the material. Vibrating presses are typically used for the compaction of complexly shaped refractories (The Technical Association of Refractories, Japan, 1998).
- C Cold Isostatic Press (CIP): A CIP, illustrated in Figure 2-6, is a molding device that provides homogeneous hydrostatic pressure over the entire surface of a

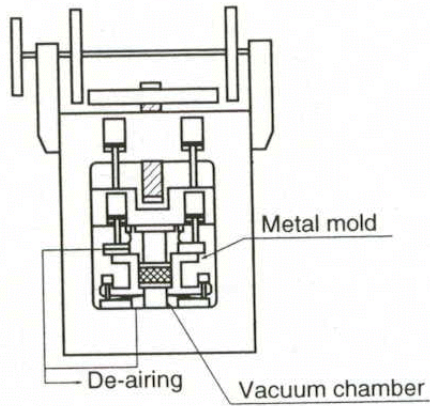

Figure 2-3. Vacuum Press (Friction, Hydraulic Press)

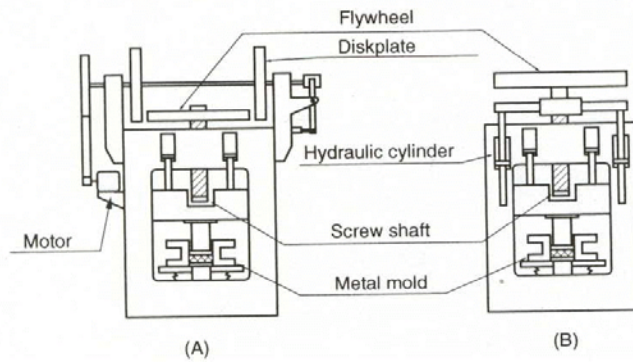

Figure 2-4. Friction Press (A), and Hydraulic Screw Press (B)

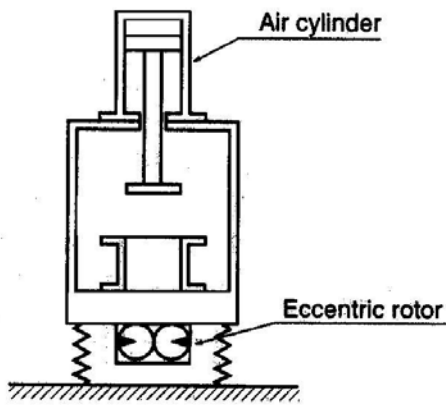

Figure 2-5. Vibrating Press

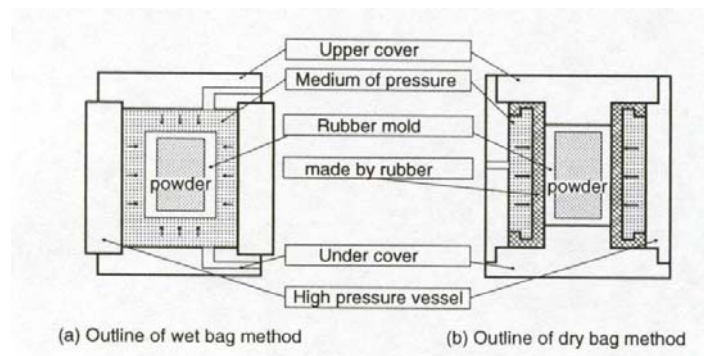

Figure 2-6. Cross Section of CIP

rubber mold filled with powder. This method, also referred to as a hydrostatic press or a rubber press method, is a materials processing technique in which fluid pressure is applied to a powder part at ambient temperature to compact it into a predetermined shape. The powder part is consolidated into a dense compacted shape. Water or oil is usually used as the presser medium. CIPs are based on either the wet bag method, where the mold is placed in pressurized liquid, or the dry bag method, in which the mold does not touch the pressurized liquid. High pressurized molding provides uniform density, which leads to a reduction of internal stresses; the elimination of cracks, strains, and laminations; the ability to make complex shapes; and the ability to press more than one shape at the same time (The Technical Association of Refractories, Japan, 1998).

Kilns. Refractories are fired to develop the materials' refractory properties. The unfired ("green") refractories pass through a heat treatment, which results in a thermally stable refractory and or crystallization. The industry uses three types of kilns:

- C Tunnel Kiln: In a tunnel kiln, refractory products consecutively pass through preheating, firing, and cooling zones (see Figure 2-7). The combustion gas from the firing zone is typically used to preheat the refractories. Heat can be recovered from cooling fired refractories and reused as combustion air. Approximately 80 percent of shaped refractories are fired in tunnel kilns (The Technical Association of Refractories, Japan, 1998).

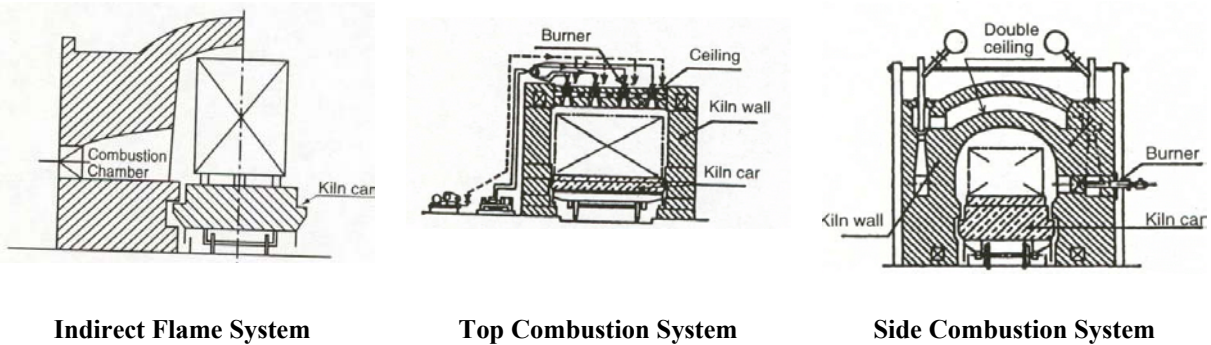

Figure 2-7. Tunnel Kiln

- C Round Periodic Kilns: Round periodic kilns are typically used to fire silica bricks. Figure 2-8 is a diagram of a round periodic kiln. These kilns can be used to fire large refractory products that cannot be fired in a tunnel kiln and can easily accommodate changes in production (The Technical Association of Refractories, Japan, 1998).
- C Shuttle Kilns: As illustrated in Figure 2-9, the design of a shuttle kiln resembles the firing zone of a tunnel kiln. Shuttle kilns effectively store heat and are used to fire fireclay and specialty bricks (The Technical Association of Refractories, Japan, 1998).

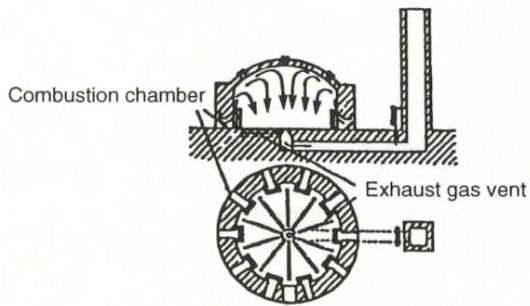

Figure 2-8. Round Kiln with Downdraft System

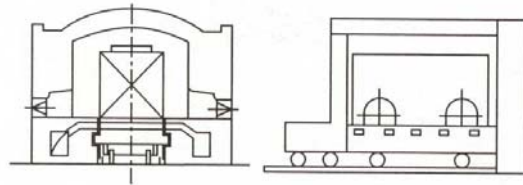

Figure 2-9. Shuttle Kiln

2.1.1.2 Final Commodities

Refractories are manufactured in two forms—shaped objects and unshaped, and unshaped refractories come in granulated or plastic compositions. Briefly described here, shaped and unshaped refractories are the two broad categories of refractories. Section 2.2 contains more information on the types of refractory products.

Shaped Refractories. Preshaped refractories include bricks, shapes, and crucibles. Shaped refractories are pre-fired to exhibit their ceramic characteristics. Table 2-1 lists each type of shaped refractory and a description of its use.

Unshaped Refractories. The unshaped products include mortars, gunning mixes, castables (refractory concrete), ramming mixes, and plastics. Unshaped refractories are often referred to as “monolithics.” The manufacture of unshaped refractories differs slightly from shaped refractories. Unshaped refractories typically do not go through a firing process until they reach the final consumer. These unshaped refractories can be installed by spraying, casting, molding, or ramming. Table 2-1 lists each type of refractory and a description of its use.

Table 2-1. Types and Descriptions of Refractories Produced

Kind	Definition
Shaped Refractories	
Bricks	Refractories that have shapes and are used to line furnaces, kilns, glass tanks, incinerators, etc.
Insulating firebrick	Low thermal conductivity firebrick.
Unshaped Refractories (Monolithic)	
Mortar	Materials for bonding bricks in a lining. The three types of mortar—heat-setting, air-setting, and hydraulic-setting—have different setting mechanisms.
Castables	Refractories for which raw materials and hydraulic-setting cement are mixed. They are formed by casting and used to line furnaces, kilns, etc.
Plastics	Refractories in which raw materials and plastic materials are mixed with water. Plastic refractories are roughly formed, sometimes with chemical additives.
Gunning mixes	Refractories that are sprayed on the surface by a gun.
Ramming mixes	Granular refractories that are strengthened by gunning formulation of a ceramic bond after heating. Ramming mixes have less plasticity and are installed by an air rammer.
Slinger mixes	Refractories installed by a slinger machine.
Patching materials/coating materials	Refractories with properties similar to refractory mortar. However, patching materials have controlled grain size for easy patching or coating.
Lightweight castables	Refractories in which porous lightweight materials and hydraulic cement are mixed. They are mixed with water and formed by casting. Lightweight castables are used to line furnaces, kilns, etc.
Fibrous Materials	
Ceramic fiber	Man-made fibrous refractory materials. There are several different types of ceramic fiber, including blanket, felt, module, vacuum form, rope, loose fiber, etc.

Source: The Technical Association of Refractories, Japan. 1998. *Refractories Handbook*. Tokyo: The Technical Association of Refractories, Japan.

2.1.1.3 *Emissions and Controls in Refractory Manufacturing*

Refractory products manufacturing facilities are sources of several HAPs. At most refractory product manufacturing facilities, the primary sources of HAP emissions are the thermal process units, such as dryers, curing ovens, and kilns. The specific types and quantities of HAPs emitted from any particular facility are largely a function of the types of raw materials used and how those materials are processed. Among others, thermal process units used to produce resin-bonded, pitch-bonded, and pitch-impregnated bricks and shapes may be sources of HAP emissions. Resin-bonded refractory curing ovens and kilns can emit phenol, formaldehyde, methanol, and ethylene glycol, depending on the type of resin used. When used as binders or additives in the production of nonresin-bonded refractory shapes, ethylene glycol and methanol also are emitted from shape dryers and kilns. Pitch-bonded refractory heated pitch storage tanks, shape dryers, and kilns emit POM. The heated pitch storage tanks, shape preheaters, defumers, and coking ovens used to produce pitch-impregnated refractories also emit POM. HF and HCl are emitted from kilns that are used to fire clay refractory products.

2.1.1.4 *Inputs to Production of Refractory Products*

The inputs in the production process for refractories include general inputs, such as labor, capital, and raw materials such as clay and nonclay materials. Two specific raw material inputs are discussed below.

Clays. Clay is composed mainly of fine particles of hydrous aluminum silicates and other minerals and is plastic when moist but hard when fired. In 1998, approximately 3.09 million tons (Mt) of clays were used in the manufacture of refractories. Table 2-2 lists different clays used in refractory products and their characteristics. Fireclay is the predominant clay used in firebrick; bentonite, in foundry sand; common clay, in refractory mortar and cement; and kaolin, in calcine, grog, high alumina brick, kiln furniture, and plug, tap, and wad (Virta, 1998).

Table 2-2. Types and Characteristics of Raw Materials used in Refractory Manufacture

Type	Characteristics
Clay Refractories	
Fireclay	Consists of kaolinite ($\text{Al}_2\text{O}_3 \cdot 2\text{SiO}_2 \cdot 2\text{H}_2\text{O}$) and minor amount of other clay materials. Fireclay refractories can be low, medium, high, or super-duty based on their resistance to high temperature or refractoriness. Fireclay refractories are used to produce bricks, insulating refractories, and two types of ladle brick.
High-alumina	Composed of bauxite or other raw materials that contain 50 to 87.5 percent alumina. High-alumina refractories are generally multipurpose, offering resistance to chipping and higher volume stability. High-alumina refractories are used to produce brick and insulating refractories.
Nonclay Refractories	
Basic	Produced from a composition of dead-burned magnesite, dolomite, chrome ore, and small amounts of other minerals. Basic refractories can be further subdivided into magnesia, dolomite, chrome, and combination bricks. Basic refractories are typically used to line kilns used to make bricks.
Extra-high alumina	Made predominately from bauxite or alumina (Al_2O_3), extra-high alumina refractories contain from 87.5 to 100 percent alumina and offer good volume stability. They are typically poured into special shapes using a fused casting process.
Mullite	Made from kyanite, sillimanite, andalusite, bauxite, or mixtures of alumina silicate materials; mullite refractories are about 70% alumina. They maintain a low level of impurities and high resistance to loading in high temperatures.
Silica	Silica refractories are characterized by a high coefficient of thermal expansion between room temperature and 500°C (930°F). Silica brick is available in three grades: super-duty (low alumina and alkali), regular, and coke oven quality. Silica compositions can be used for hot patching, shrouds, and bricks.
Silicon carbide	Produced by the reaction of sand and coke in an electric furnace, silicon carbide refractories are used to make special shapes, such as kiln furniture, to support ceramicware as it is fired in kilns. It has high thermal conductivity, good load bearing characteristics at high temperatures, and good resistance to changes in temperatures.
Zircon	Containing zirconium silicate ($\text{ZrO}_2 \cdot \text{SiO}_2$), zircon refractories maintain good volume stability for extended periods or exposure to high temperatures. Zircon refractories are widely used for glass tank construction.

Nonclays. Nonclay refractories are composed of alumina, mullite, chromite, magnesite, silica, silicon carbide, zircon, and other nonclays. Table 2-2 lists various minerals used in the production of nonclay refractories, the type of refractory produced, and characteristics of the refractory.

2.1.2 *Types of Products*

As noted earlier, Table 2-1 lists the different forms of refractories and describes them briefly. Refractories are generally categorized as either clay or nonclay products. To further classify the products, refractories are labeled as acidic or basic. Refractories are typically produced as shaped refractories, unshaped refractories, and fibrous materials. Shaped refractories include bricks, shapes, and crucibles. Bricks and shapes are formed by mixing raw materials with water and/or other binders and pressing or molding the mixture into a desired shape.¹ Crucibles are ceramic containers used for melting metal. Unshaped refractories, also called monolithics, are unformed products that are dried to form a unified structure after application. These refractories can be used as mortars, plastics, ramming mixes, castables, and gunning mixes. Monolithic refractories are applied by either pouring, pumping, troweling, or gunning (spraying).

2.1.3 *Costs of Production*

In the production process, the costs incurred by refractory manufacturers include labor, materials, and capital. This section provides data on these costs and discusses economies of scale.

2.1.3.1 *Cost Data*

Between 1994 and 1998, on average clay refractory manufacturers spent more than 70 percent of expenditures on input materials and nonclay refractory producers spent almost 64 percent. Figure 2-10 illustrates the percentage breakdown of refractory manufacturing expenditures by refractory type. Tables 2-3 and 2-4 also provide expenditures in dollars for wages, materials, and new capital from 1977 to 1998 in both current and 1997 dollars. Costs of materials include all raw materials, containers, scrap, and supplies used in production, repair, or maintenance during the year, as well as the cost of all electricity and fuel consumed. Costs are included for materials whether they are purchased from outside the company or transferred from within the company. New capital expenditures include permanent additions and alterations to

¹Refractory bricks and shapes can be formed by a variety of methods, including hand molding, air ramming, pressing, extruding, or casting.

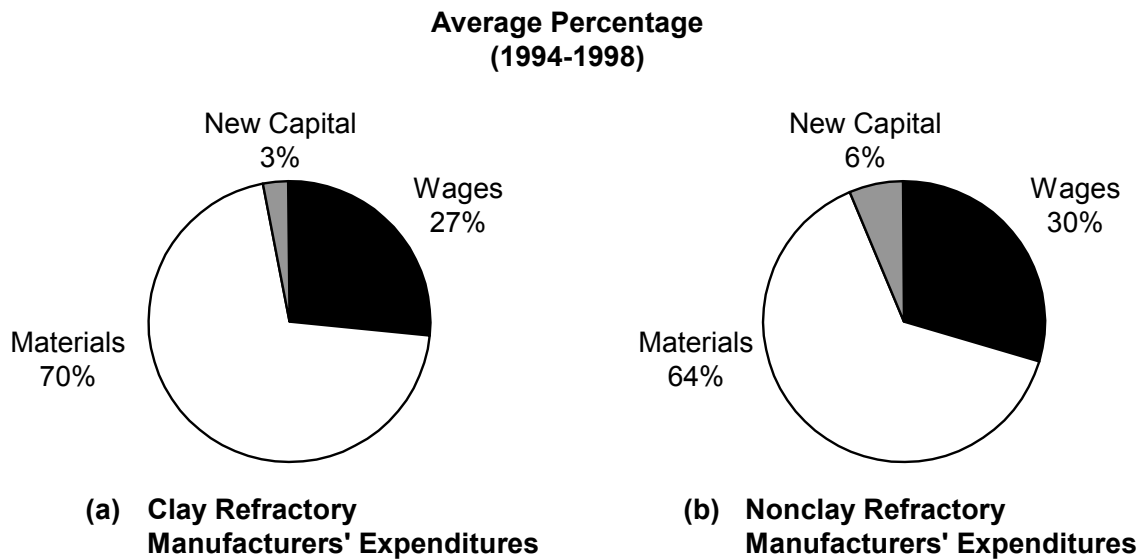

Figure 2-10. Clay and Nonclay Refractory Manufacturers' Expenditures

facilities and machinery and equipment used for expanding plant capacity or replacing existing machinery.

These tables show that the cost of materials is by far the greatest cost to refractory producers. Refractory producers spend as much as two and a half times more on materials than they do on labor. For 1998, the *Annual Survey of Manufactures* reported that the clay refractory industry spent \$31.6 million and the nonclay refractory industry spent \$52.7 million on energy, almost 6 and 8 percent, respectively, of the total materials cost for that year. Energy costs for manufacturers of refractory bricks and shapes are generally greater than energy costs for manufacturers of monolithic refractories because of the energy-intensive nature of operations that require using forming equipment, curing ovens, shape and coking ovens, pitch and brick pre-heaters, dryers, and kilns. Table 2-5 contains a more detailed breakdown of the costs of materials used in producing and manufacturing refractory materials.

Table 2-3. Labor, Material, and New Capital Expenditures for Clay Refractory Manufacturers (NAICS 327124)^a (\$10⁶)

Year	Wages		Materials		New Capital	
	Current	1997	Current	1997	Current	1997
1977	146.8	224.30	296.8	453.48	20.0	30.56
1978	171.8	254.08	364.6	539.21	23.1	34.16
1979	191.5	273.16	384.7	548.74	29.4	41.94
1980	183.6	253.02	363.1	500.39	31.5	43.41
1981	199.6	266.09	410.6	547.37	36.1	48.12
1982	155.2	204.68	339.0	447.07	21.2	27.96
1983	147.1	191.19	358.5	465.94	12.0	15.60
1984	176.6	226.17	438.2	561.20	22.0	28.18
1985	166.8	211.69	397.5	504.47	22.1	28.05
1986	160.4	202.68	412.6	521.36	15.8	19.96
1987	150.2	188.05	387.5	485.15	11.7	14.65
1988	160.0	193.46	401.7	485.70	14.0	16.93
1989	176.7	207.39	451.3	529.69	11.9	13.97
1990	168.8	196.28	475.3	552.68	15.2	17.67
1991	166.0	191.22	464.8	535.40	18.5	21.31
1992	183.8	196.57	452.8	484.27	24.6	26.31
1993	163.9	180.42	377.0	415.00	7.2	7.93
1994	179.0	191.44	494.0	528.33	16.5	17.65
1995	199.0	205.37	510.3	526.63	16.6	17.13
1996	196.4	200.88	510.7	522.34	18.6	19.02
1997	210.0	210.42	566.0	567.13	30.1	30.16
1998	201.8	201.80	536.5	536.50	25.6	25.60

^a Prices were deflated using the producer price index (PPI) from the Bureau of Labor Statistics. 2001. <<http://146.142.4.24/cgi-bin/surveymost>>.

Sources: U.S. Department of Commerce, Bureau of the Census. 1994b. *1992 Census of Manufactures, Industry Series—Cement and Structural Clay Products*. Washington, DC: Government Printing Office.
U.S. Department of Commerce, Bureau of the Census. 1995. *1993 Annual Survey of Manufactures*. M93(AS)-1. Washington, DC: Government Printing Office.
U.S. Department of Commerce, Bureau of the Census. 1996a. *1994 Annual Survey of Manufactures*. M94(AS)-1. Washington, DC: Government Printing Office.
U.S. Department of Commerce, Bureau of the Census. 1997. *1995 Annual Survey of Manufactures*. M95(AS)-1. Washington, DC: Government Printing Office.
U.S. Department of Commerce, Bureau of the Census. 1998. *1996 Annual Survey of Manufactures*. M96(AS)-1. Washington, DC: Government Printing Office.
U.S. Department of Commerce, Bureau of the Census. 1999b. *1997 Census of Manufactures, Industry Series—Manufacturing: Clay Refractory Manufacturing*. Washington, DC: Government Printing Office.
U.S. Department of Commerce, Bureau of the Census. 2000. *1998 Annual Survey of Manufactures*. M98(AS)-1. Washington, DC: Government Printing Office.

Table 2-4. Labor, Material, and New Capital Expenditures for Nonclay Refractory Manufacturers (NAICS 327125)^a (\$10⁶)

Year	Wages		Materials		New Capital	
	Current	1997	Current	1997	Current	1997
1977	134.3	205.20	336.4	513.99	37.1	56.69
1978	162.7	240.62	434.9	643.17	43.1	63.74
1979	172.5	246.05	434.6	619.91	24.4	34.80
1980	177.4	244.47	482.3	664.66	47.2	65.05
1981	196.5	261.95	484.7	646.15	69.7	92.92
1982	148.4	195.71	343.3	452.74	48.5	63.96
1983	129.5	168.31	312.8	406.55	20.8	27.03
1984	147.5	188.90	347.1	444.53	24.7	31.63
1985	152.0	192.90	369.2	468.55	32.5	41.25
1986	162.7	205.59	372.1	470.19	13.7	17.31
1987	202.5	253.53	443.5	555.26	16.3	20.41
1988	209.6	253.43	470.7	569.12	18.0	21.76
1989	232.6	273.00	480.4	563.85	36.3	42.61
1990	239.9	278.96	499.0	580.24	30.3	35.23
1991	241.3	277.95	500.6	576.64	26.5	30.53
1992	249.2	266.52	541.4	579.03	44.9	48.02
1993	279.3	307.45	578.8	637.14	62.5	68.80
1994	247.6	264.81	562.5	601.59	41.1	43.96
1995	274.9	283.70	588.3	607.13	35.9	37.05
1996	278.6	284.95	574.0	587.09	42.7	43.67
1997	288.4	288.98	621.3	622.54	88.8	88.98
1998	307.1	307.10	650.9	650.90	96.8	96.80

^a Prices were deflated using the producer price index (PPI) from the Bureau of Labor Statistics. 2001. <<http://146.142.4.24/cgi-bin/surveymost>>.

Sources: U.S. Department of Commerce, Bureau of the Census. 1994a. *1992 Census of Manufactures, Industry Series—Abrasive, Asbestos, and Miscellaneous Mineral Products*. Washington, DC: Government Printing Office.
U.S. Department of Commerce, Bureau of the Census. 1995. *1993 Annual Survey of Manufactures*. M93(AS)-1. Washington, DC: Government Printing Office.
U.S. Department of Commerce, Bureau of the Census. 1996a. *1994 Annual Survey of Manufactures*. M94(AS)-1. Washington, DC: Government Printing Office.
U.S. Department of Commerce, Bureau of the Census. 1997. *1995 Annual Survey of Manufactures*. M95(AS)-1. Washington, DC: Government Printing Office.
U.S. Department of Commerce, Bureau of the Census. 1998. *1996 Annual Survey of Manufactures*. M96(AS)-1. Washington, DC: Government Printing Office.
U.S. Department of Commerce, Bureau of the Census. 1999c. *1997 Census of Manufactures, Industry Series—Manufacturing: Nonclay Refractory Manufacturing*. Washington, DC: Government Printing Office.
U.S. Department of Commerce, Bureau of the Census. 2000. *1998 Annual Survey of Manufactures*. M98(AS)-1. Washington, DC: Government Printing Office.

Table 2-5. Costs of Materials Used in Refractory Production and Manufacture^a

Material	1997		1992	
	Delivered Cost (\$10 ⁶)	Percentage of Material Costs	Delivered Cost (\$10 ⁶)	Percentage of Material Costs
Clay NAICS 327124				
Materials, ingredients, containers, and supplies	35.2	6.22	26.7	6.55
Clay, ceramic, and refractory minerals	284	50.18	209	51.26
Dead-burned magnesia or magnesite	6.9	1.22	8.4	2.05
Refractories, clay or nonclay	90.8	16.04	79.6	19.52
Other stone, clay, glass, and concrete products	4.4	0.78	5.2	1.28
Industrial chemicals	6.5	1.15	2.2	0.53
All other materials and components, parts, containers, and supplies	65.1	11.50	76.8	18.83
Nonclay NAICS 327125				
Materials, ingredients, containers, and supplies	50.4	8.11	65.4	11.12
Clay, ceramic, and refractory minerals	224.2	36.09	156.2	26.58
Dead-burned magnesia or magnesite	38.7	6.23	59.1	10.05
Refractories, clay or nonclay	NA	NA	65.6	11.16
Other stone, clay, glass, and concrete products	NA	NA	NA	NA
Industrial chemicals	21.4	3.44	21.1	3.58
All other materials and components, parts, containers, and supplies	73.9	11.89	75.3	12.82

NA = Not available.

^a Prices were deflated using the producer price index (PPI) from the Bureau of Labor Statistics. 2001. <<http://146.142.4.24/cgi-bin/srgate>>.

Source: U.S. Department of Commerce, Bureau of the Census. 1999b. *1997 Census of Manufactures, Industry Series—Manufacturing: Clay Refractory Manufacturing*. Washington, DC: Government Printing Office.

2.2 Industry Organization

This section examines the organization of the U.S. refractory industry, including plant location and production characteristics, commercial and captive producers, firm characteristics, market structure, and degree of integration. Understanding the industry's organization helps determine how it will be affected by complying with the refractory production NESHAP.

2.2.1 Refractory Manufacturing Facilities

A facility is a site of land with a plant and equipment that combine inputs (mineral products, organic and inorganic liquids, fuel and labor) to produce an output (refractory products). Companies that own these facilities are legal business entities that conduct transactions and make decisions that affect the facility. The terms "facility," "establishment," and "plant" are synonymous in this analysis and refer to the physical location where products are manufactured. Likewise, the terms "company" and "firm" are used interchangeably to refer to the legal business entity that owns one or more facilities. This section presents information on the companies that own refractory plants.

2.2.1.1 Refractories Database Facilities

Table 2-6 presents a list of 117 refractory manufacturers obtained from a publicly available financial database, including the location of the facility, its estimated sales volume in millions of dollars, and its employment. This list includes many of the facilities potentially affected by the refractory products NESHAP but does not correspond precisely to the set of facilities EPA believes may be affected, because data on those facilities were provided to EPA in confidential questionnaire responses. EPA's data indicate that the United States has 147 refractory manufacturing facilities.

2.2.1.2 Facility Location

Census data indicate that refractory materials are produced in 37 states. Table 2-7 lists the number of refractory facilities in the 50 states and Puerto Rico, based on the *Census of Manufactures*. The leading refractory-producing states are Pennsylvania and Ohio, which also contain a large number of steel mills. Figure 2-11 illustrates the distribution of the refractory-producing facilities in the United States, together with the location of plants in the

Table 2-6. Selected Refractory Manufacturers, by Type

Company	Location	Sales (\$10 ⁶)	Employment	Company Type	Owning Company	Sales (\$10 ⁶)	Employment
Clay							
Able Supply Co.	Houston, TX	NA	NA	NA	NA	NA	NA
Alsey Refractories Co.	Alsey, IL	10 to 20	20 to 49	Private			
B&B Refractories, Inc.	Santa Fe Springs, CA	2.5 to 5	10 to 19	Private			
Bay State Crucible Co.	Taunton, MA	5 to 10	20 to 49	Private			
Bloom Engineering Co., Inc.	Pittsburgh, PA	38	187	Subsidiary	Sterling Industries PLC, England	NA	NA
BNZ Materials, Inc.	Littleton, CO	25	150	Private			
Carpenter EPG Certech, Inc.	Wilkes Barre, PA	14	150	Subsidiary	Carpenter Technology Corp.	1,000	5,324
Carpenter Technology Corp.	Reading, PA	1,000	5,324	Public			
Ceradyne, Inc.	Costa Mesa, CA	26	300	Private			
Certech, Inc.	Wood Ridge, NJ	62	758	Subsidiary	Carpenter Technology Corp.	1,000	5,324
CFB Industries, Inc.	Chicago, IL	23	176	Private			
Christy Refractories Co. LLC	St. Louis, MO	14	80	Private			
Clay City Pipe	Uhrichsville, OH	14	200	Private			
Cooperheat-MQS, Inc.	Houston, TX	120	1,200	Private			
ER Advanced Ceramics, Inc.	East Palestine, OH	NA	NA	NA	NA	NA	NA
Ernhart Glass Manufacturing, Inc.	Owensville, NJ	NA	NA	NA	NA	NA	NA
Fels Refractories, Inc.	Edison, NJ	1 to 2.5	NA	Private			
Ferro Corp.	Cleveland, OH	331	6,693	Public			
Freeport Area Enterprises, Inc.	Freeport, PA	10	150	Private			
Freeport Brick Co.	Creighton, PA	NA	NA	NA	NA	NA	NA

(continued)

Table 2-6. Selected Refractory Manufacturers, by Type (continued)

Company	Location	Sales		Company		Sales	
		(\$10 ⁶)	Employment	Type	Owning Company	(\$10 ⁶)	Employment
Clay (continued)							
Global Industrial Technologies, Inc.	Dallas, TX	142	4,262	Public			
Green AP Refractories, Inc.	Mexico, MO	25	300	Subsidiary	RHI AG	1,580	14,500
Heater Specialists, Inc.	Tulsa, OK	17	160	Private			
Holland Manufacturing Corp.	Dolton, IL	2.5 to 5	20 to 49	NA	NA	NA	NA
Howmet Corp.	Whitehall, MI	1,300	10,350	Subsidiary	Cordant Technologies, Inc.	2,513	17,200
Industrial Ceramic Products, Inc.	Columbus, OH	NA	NA	NA	NA	NA	NA
Industrial Product International	Englewood, CO	1 to 2.5	5 to 9	Private			
Inland Enterprise, Inc.	Avon, OH	14	100	Private			
Insul Co., Inc.	East Palestine, OH	15	77	Private			
International Chimney Corp.	Williamsville, NY	18	140	Private			
Louisville Firebrick Works	Graham, KY	NA	NA	NA	NA	NA	NA
Martin Marietta Magnesia Specialties, Inc.	Raleigh, NC			Subsidiary	Martin Marietta Materials, Inc.	1,057	570
Maryland Refractories Co.	Irondale, OH	1 to 2.5	NA	Private			
Mono Ceramics, Inc.	Benton Harbor, MI	11	45	Subsidiary	Monocon International Refractories, England	NA	NA
Morganite Crucible, Inc.	North Haven, CT	15	75	Subsidiary	Morgan Crucible Co. PLC, England	1,394	16,885
Mt. Savage Firebrick Co.	Frostburg, MD	NA	NA	NA	NA	NA	NA
National Refractories & Minerals Corp.	Livermore, CA	115	600	Subsidiary	National Refractory Holding Co., Inc.	NA	810
New Castle Refractories	Massillon, OH	14	122	Subsidiary	Dixon Ticonderoga	115	1,354

(continued)

Table 2-6. Selected Refractory Manufacturers, by Type (continued)

Company	Location	Sales (\$10 ⁶)	Employment	Company Type	Owning Company	Sales (\$10 ⁶)	Employment
Clay (continued)							
North America Refractories Co.	Cleveland, OH	331	1,500	Subsidiary	Didier-Werke AG, Germany	448.5	NA
P-G Industries, Inc.	Pueblo, CO	12	160	Private			
Plibrico Co.	Oak Hill, OH	10 to 20	20 to 40	Private			
Porvair Corp.	Hendersonville, NC	18	200	Private			
Premier Refractories, Inc.	King of Prussia, PA	64	778	Private			
Premier Refractories International, Inc.	King of Prussia, PA	90	900	Subsidiary	Alpine Group, Inc.	1,370	6,600
Pryotech, Inc.	Spokane, WA	45	650	Private			
Refco, Inc.	Boylston, MA	34	88	Subsidiary	Industrial Distribution Group, Inc.	273	1,200
Refractories Sales and Service Co., Inc.	Bessemer, AL	NA	NA	NA	NA	NA	NA
Reno Refractories, Inc.	Morris, AL	16	85	Private			
Resco Products, Inc.	Norristown, PA	50	500	Private			
RHI Refractories America	Pittsburgh, PA	NA	NA	NA	RHI Refractories AG	1,580	14,500
Riverside Clay Co., Inc.	Pell City, AL	15	100				
Riverside Refractories, Inc.	Pell City, AL	14	100	Subsidiary	Riverside Clay Co., Inc.	15	100
Rutland Products	Jacksonville, FL	NA	NA	NA	NA	NA	NA
Servsteel, Inc.	Morgan, PA						
SGL Carbon Corp.	Charlotte, NC	255	1,891	Subsidiary	SGL Aktiengesellschaft, Germany		
Shenango Refractories, Inc.	New Castle, PA	5 to 10	20 to 49	Private			
Sterling Industries of Delaware, Inc.	Pittsburgh, PA	57	312	Subsidiary	Sterling Industries PLC, England		
The Nock and Son Co.	Oak Hill, OH	2.5 to 5	10 to 19	Private			

(continued)

Table 2-6. Selected Refractory Manufacturers, by Type (continued)

Company	Location	Sales (\$10 ⁶)	Employment	Company Type	Owning Company	Sales (\$10 ⁶)	Employment
Clay (continued)							
The Whitacre-Greer Fire Proofing Co.	Alliance, OH	5 to 10	NA	Private			
Thermal Ceramics, Inc.	Augusta, GA	138	1,200	Subsidiary	Morgan Crucible Co. PLC, England	1,394	16,885
Thorley Refractories, Inc.	Southgate, CA	5 to 10	20 to 49	Private			
Transit Mix Concrete Co., Inc.	Colorado Springs, CO	25	210	Subsidiary	Continental Materials Corp., Delaware	NA	NA
TYK America, Inc.	Clairton, PA	37	122	Subsidiary	TYK Corp., Japan	133.5	NA
Unifrax Corp.	Niagara Falls, NY	85	285	Subsidiary	Kirkland Capital Partners LP	90	808
Universal Refractories, Inc.	Wampum, PA	24	130	Private			
Utah Refractories Co.	Lehi, UT	NA	NA	NA	NA	NA	NA
Wahl Refractories, Inc.	Fremont, OH	17	68	Subsidiary	Thermatex Corp.	10	148
Zero Refractories, Inc.	Taylor MI	0.5	1 to 4	Private			
Nonclay							
Advanced Ceramics Corp.	Cleveland, OH	25 to 50	NA	Private			
Advanced Ceramics International, Inc.	Cleveland, OH	21	175	Private			
Allied Mineral Products, Inc.	Columbus, OH	56	240	Private			
Alpine Group, Inc.	New York, NY	1,370	6,600	Public			
Aluminum Company of America (ALCOA)	Pittsburgh, PA	15,300	103,500	Public			
AMPAC	Amsterdam, NY	13	100	Private			
B S C Holding, Inc.	Shawnee Mission, KS	23	15	Private			
Baker Holding Co., Inc.	York, PA	190	1,300	Public			
Baker JE Co.	York, PA	190	1,050	Subsidiary	Baker Holding Co., Inc.	190	1,300
Bartley Crucible & Refractories, Inc.	Trenton, NJ	NA	NA	NA	NA	NA	NA

(continued)

Table 2-6. Selected Refractory Manufacturers, by Type (continued)

Company	Location	Sales (\$10 ⁶)	Employment	Company Type	Owning Company	Sales (\$10 ⁶)	Employment
Nonclay (continued)							
Bethlehem Advanced Materials Corp.	Knoxville, TN	14	110	Subsidiary	The Bethlehem Corp.	14	117
Blash Precision Ceramics, Inc. (Texas United)	Houston, TX	63	515	Private			
BNZ Materials, Inc.	Zelienople, PA	1 to 2.5	5 to 9	private			
CCPI, Inc.	Blanchester, OH	25 to 50	NA	private			
Cercom, Inc.	Vista, CA	11	76	Private			
Certech, Inc.	Streetsboro, OH	62	758	Subsidiary	Carpenter Technology Corp.	1,000	5,324
CFB Industries, Inc.	Chicago, IL	23	176	Private			
Chicago Firebrick Co., Inc.	Chicago, IL	18	58	Private			
Coors Porcelain Co., Inc.	Chicago, IL	304	2,900	Subsidiary	ACX Technologies, Inc.	988	5,600
Dixon Ticonderoga Co., Inc.	Lake Mary, FL	85	1,562	Public			
ETS Schaefer Corp.	Macedonia, OH	13	195	Subsidiary	Alumitech, Inc.	21	210
Foseco, Inc.	Cleveland, OH	71	500	Subsidiary	Foseco Holding BV, Netherlands		
Global Industrial Technologies, Inc.	Dallas, TX	142	4,262	Public			
Harbison-Walker Refractories Co.	Pittsburgh, PA	263	1,615	Subsidiary	RHI AG	1,580	14,500
Insul Co., Inc.	East Palestine, OH	15	77	Private			
JW Hicks, Inc.	Merrellville, IN	5 to 10	20 to 49	NA	NA	NA	NA
Magneco, Inc.	Addison, IL	19	150	Subsidiary	Magneco/Metrel, Inc.	34	
Martin Marietta Magnesia Specialties, Inc.	Raleigh, NC			Subsidiary	Martin Marietta Materials, Inc.	1,057	570
Minco Acquisition Corp.	Midway, TN	21	170	Private			
Minco, Inc.	Midway, TN	15	135	Subsidiary	Minco Acquisition Corp.	21	170
Minerals Technologies, Inc.	New York, NY	609	2,260	Public			
Minteq International, Inc.	New York, NY	205	1,800	Subsidiary	Minerals Technologies, Inc.	609	2,260

(continued)

Table 2-6. Selected Refractory Manufacturers, by Type (continued)

Company (continued)	Location	Sales (\$10 ⁶)		Employment		Company Type	Owning Company	Sales (\$10 ⁶)		Employment
Mitsubishi Cement Corp.	Ontario, CA	74	619	NA	619	Subsidiary	Mitsubishi Materials Corp., Japan	9,354	6,556	
Mixed Mineral Products, Inc.	Columbus, OH	NA	NA	NA	NA	NA	NA	NA	NA	
Monofrax, Inc.	Falconer, NY	50 to 100	250 to 499			Private				
Morganite Crucible, Inc.	North Haven, CT	15	75			Subsidiary	Morgan Crucible Co. PLC, England	1,394	16,885	
National Refractories & Minerals Corp.	Livermore, CA	115	600			Subsidiary	National Refractory Holding Co., Inc.			
New Castle Refractories	Massillon, OH	14	122			Subsidiary	Dixon Ticonderoga	115	1,354	
Newport Sand & Gravel Co., Inc.	Newport, NH	13	100			Private				
North American Refractories Co.	Cleveland, OH	331	1,500			Subsidiary	Didier-Werke AG, Germany	NA	NA	
Norton Co., Inc.	Worcester, MA	1,500	9,000			Subsidiary	Saint-Gobain, France	23,113	165,000	
Osrarnsylvania, Inc.	Danvers, MA	5,200	13,000			Subsidiary	Siemens Corp.			
Osrarnsylvania Products, Inc.	Danvers, MA	1,800	1,100			Subsidiary	Siemens Corp.			
Pell Industries	Grove City, PA	5 to 10	20 to 49			Private				
Prefromix Technologies LTD	Warren, OH	10	75			Private				
Premier Refractories International, Inc.	King of Prussia, PA	90	900			Subsidiary	Alpine Group, Inc.	1,370	6,600	
Premier Services, Inc.	Bettsville, OH	NA	NA	NA	NA	NA	NA	NA	NA	
Pyrotek Inc.	Spokane, WA	50 to 100	NA			Private				
Rex Roto Corp.	Fowlerville, MI	14	80			Private				

(continued)

Table 2-6. Selected Refractory Manufacturers, by Type (continued)

Company	Location	Sales (\$10 ⁶)	Employment	Company Type	Owning Company	Sales (\$10 ⁶)	Employment
Nonclay (continued)							
Saint-Gobain Advanced Materials Corp.	Louisville, KY	533	3,300	Subsidiary	Norton Co., Inc.		
Selee Corp.	Hendersonville, NC	5	190	Subsidiary	Porvair PLC, England		
Silicon Carbide Products, Inc.	Elmira, NY	1 to 2.5	5 to 9	Private			
Spar, Inc.	Jacksonville, FL	NA	NA	NA	NA	NA	NA
Thermatec Corp. (Thermalite)	Fremont, OH	10	148	Private			
TYK America, Inc.	Clairton, PA	37	122	Subsidiary	TYK Corp., Japan	133.5	NA
UCAR Carbon Co.	Danbury, CT	105	1,506	Subsidiary	UCAR International, Inc.	947	4,952
Universal Refractories, Inc.	Wampum, PA	24	130	Private			
Varsal Instruments, Inc.	Warminster, PA	15	224	Private			
Vesuvius Crucible Co.	Champaign, IL	400	2,500	Subsidiary	Cookson Group PLC, England	3,011	17,101
Vesuvius USA Corp.	Champaign, IL	400	1,600	Subsidiary	Cookson Group PLC, England	3,011	17,101
Wulfrath Refractories, Inc.	Tarentum, PA	22	115	Private			
Zircar Products, Inc.	Florida, NY	12	85	Private			
Zircoa, Inc.	Solon, OH	20	140	Subsidiary	Didier-Werke AG, Germany	448.5	4,717

NA = Not available.

Source: Dun & Bradstreet. 2000. *D&B Million Dollar Directory*. Series 2000. Bethlehem, PA: Dun & Bradstreet, Inc.

Note: The data used to analyze company impacts of the NESHAP are similar but not identical to these data. The actual data used include confidential survey responses and thus cannot be made public.

Table 2-7. Number of Refractory Manufacturing Facilities by State

State	Number of Refractory Plants	
	Clay (NAICS 327124)	Nonclay (NAICS 327125)
Alabama	8	
California	10	6
Georgia	5	4
Illinois	7	7
Indiana		7
Kentucky		6
Maryland	4	
Michigan		7
Missouri	9	3
New York		3
New Jersey		7
North Carolina		2
Ohio	27	24
Pennsylvania	30	22
Texas	7	
West Virginia		3
Totals	107	101

Source: U.S. Department of Commerce, Bureau of the Census. 1999a. *1997 Census of Manufactures*. Washington, DC: Government Printing Office.

industries that are the major consumers of refractory products. States with a large number of refractory plants typically also have substantial numbers of iron and steel, cement, and/or nonferrous metal plants, indicating that refractory plant location may depend at least in part on customer location. This is likely to be particularly true for unfired shaped refractories, because they have not undergone firing and are somewhat fragile and thus difficult to transport successfully.

2.2.2 Capacity Utilization

Capacity utilization indicates how well the current facilities meet demand, which can be measured by the capacity utilization rate. A capacity utilization rate is the ratio of actual production volumes to full-capacity production volumes. For example, if an industry is

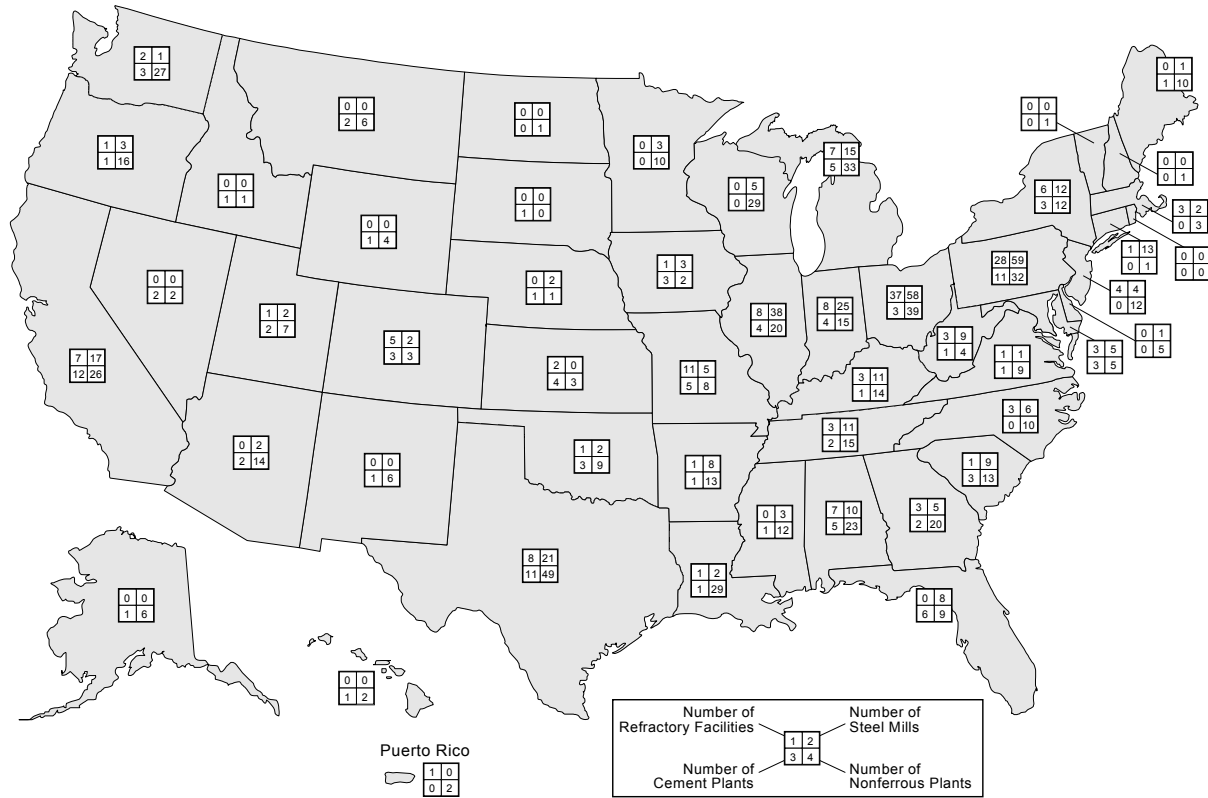

Figure 2-11. Location of Refractory Manufacturing Facilities

producing as much output as possible without adding new floor space for equipment, the capacity utilization rate would be 100 percent. On the other hand, if under the same constraints the industry were only producing 75 percent of its maximum possible output, the capacity utilization rate would be 75 percent. On an industry basis, capacity utilization is highly variable from year to year depending on economic conditions. It is also variable on a company-by-company basis depending not only on economic conditions, but also on the company’s strategic position, within its particular industry. While some plants may have idle production lines or empty floor space, others need additional space or capacity.

Table 2-8 lists the capacity utilization rates for clay and nonclay refractory manufacturers for 1993 through 1998. Reduction in the demand for refractory replacements parts led to lower capacity utilization rates throughout this time period. Nonclay refractories,

Table 2-8. Full Production Capacity Utilization Rates for Clay and Nonclay Refractories: Fourth Quarters 1993 through 1998

	Clay (NAICS 327125)	Nonclay (NAICS 327125)
1993	75	71
1994	80	75
1995	63	81
1996	61	82
1997	49	78
1998	54	72

Source: U.S. Department of Commerce, Bureau of the Census. 1999d. *1998 Survey of Plant Capacity*. Washington, DC: Government Printing Office.

which include specialty refractory products, have seen increased demand, allowing that part of the industry to maintain an approximately 70 percent capacity utilization rate.

2.2.3 Industry Concentration and Market Structure

Market structure, which characterizes the level and type of competition among refractory producers, determines the behavior of producers and consumers in the industry, including their power to influence market price. If an industry is perfectly competitive, then the individual producers have little market power; they are not able to influence the price of the outputs they sell or the inputs they purchase. Perfectly competitive industries have large numbers of firms, the products sold are undifferentiated, and the entry and exit of firms are unrestricted.

Conversely, imperfectly competitive industries or markets are characterized by a smaller number of firms, differentiated products, and restricted entry or exit. Product differentiation can occur both from differences in product attributes and quality and from brand name recognition of products. Entry and exit of firms are restricted in industries when government regulates entry (e.g., through licenses or permits), when one firm owns the entire stock of critical input, or when a single firm is able to supply the entire market.

When compared across industries, firms in industries with fewer firms, more product differentiation, and restricted entry are more likely to have the power to influence the price they receive for a product by reducing output below perfectly competitive levels. At the extreme, a single monopolistic firm may supply the entire market and hence set the price of the output. On the input market side, firms may be able to influence the price they pay for an input if few firms, both from within and outside the industry, use that input.

2.2.3.1 Measures of Industry Concentration

To assess the competitiveness of an industry, economists often estimate four-firm concentration ratios (CR4), eight-firm concentration ratios (CR8), and Herfindahl-Hirschman indexes (HHI) for the subject market or industry. The CR4s and CR8s measure the percentage of sales accounted for by the top four and eight firms in the industry. The HHIs are the sums of the squared market shares of firms in the industry. Table 2-9 provides concentration ratios for the refractory industry.

Table 2-9. Market Concentration Measures for SIC 3255 Clay Refractory Manufacturing and SIC 3297 Nonclay Refractory Manufacturing

Measure	Value	
	Clay	Nonclay
Herfindahl-Hirschmann Index (HHI)	578	527
Four-firm concentration ratio (CR4)	40	36
Eight-firm concentration ratio (CR8)	62	58
Number of companies	95	102
Number of facilities	145	142
Value of shipments	886.8	1,203.8

Source: U.S. Department of Commerce, Bureau of the Census. 1996b. *Concentration Ratios in Manufacturing*. MC92-S-2. Washington, DC: Government Printing Office. Available at <<http://www.census.gov/mcd/mancen/download/mc92cr.sum>>.

Unfortunately, there is no objective criterion for determining market structure based on the values of these concentration ratios. However, there are criteria for determining market structure based on the HHIs for use in merger analyses, which are provided in the 1992 Department of Justice's Horizontal Merger Guidelines (U.S. Department of Justice and the Federal Trade Commission, 1992). According to these criteria, industries with HHIs below 1,000 are considered unconcentrated (i.e., more competitive), and those with HHIs between 1,000 and 1,800 are considered moderately concentrated (i.e., moderately competitive). Firms in less-concentrated industries are more likely to be price takers, while firms in more-concentrated industries are more likely to be able to influence market prices. These measures of market concentration can be computed using four-digit Standard Industrial Classification (SIC) codes based on U.S. Bureau of the Census data (U.S. Department of Commerce, 1993). Based on the HHI criteria, the refractory industry is not concentrated, and, therefore, competitive in structure. These indices are measures of concentration of the industry at the national level.

2.2.3.2 *Market Structure*

The majority of products of the refractories industry are used as inputs for the steel industry. The relatively small numbers of steel companies that are prominent users of refractory products may result in the buyers maintaining some measure of control over the input price (monopsony or oligopsony).

A monopsony occurs when a firm is the sole purchaser of an input. The monopsonist has the market power in the input market and can reduce the price paid without losing all input. An oligopsony is characterized by the presence of a few large buyers (even though there may also be many small buyers of insignificant size). In oligopsony, large firms are aware of their competitors for purchasing inputs and determine their purchasing price and quantity based on their expectations of their competitors' behavior. Although there may be some degree of market power exerted by steel companies on the demand side of the refractories market, our analysis treats the markets for refractory products as competitive.

2.2.3.3 *Small Businesses that Own Refractory Facilities*

To determine the possible impacts on small businesses, both clay and nonclay refractory manufacturers are categorized as small or large using the Small Business Administration (SBA) general size definitions (SBA, 1998). For clay refractory manufacturers, a small company has 500 or fewer employees. For nonclay refractory manufacturers, small is defined as having 750 or fewer employees.

Table 2-10 lists the employment and sales data for small companies that are owners of refractory-producing facilities. Again as in Table 2-6, these data are based on information available from publicly available sources. EPA's database provides information on company size, and its analysis of small business impacts is based on the best data currently available

Table 2-10. Characteristics of Small Businesses in the Refractory Industry

Company	Location	Sales (\$10⁶)	Employment	Organization Type
Able Supply Co.	Houston, TX	NA	NA	NA
Alsey Refractories Co.	Alsey, IL	10 to 20	20 to 49	Private
B&B Refractories Inc.	Santa Fe Springs, CA	2.5 to 5	10 to 19	NA
Bay State Crucible Co.	Taunton, MA	5 to 10	20 to 49	NA
Ceradyne Inc.	Costa Mesa, CA	26	300	Private
Christy Refractories Co. LLC	St. Louis, MO	14	80	Private
Clay City Pipe ^a	Uhrichsville, OH	14	200	Private
ER Advanced Ceramics Inc.	East Palestine, OH	NA	NA	NA
Ermhart Glass Manufacturing Inc.	Owensville, NJ	NA	NA	NA
Fels Refractories Inc.	Edison, NJ	1 to 2.5	NA	Private
Freeport Area Enterprises Inc. ^a	Freeport, PA	10	150	Private
Freeport Brick Co.	Creighton, PA	NA	NA	NA
Heater Specialists, Inc. ^a	Tulsa, OK	17	160	Private
Holland Manufacturing Corp.	Dolton, IL	25 to 5	20 to 49	Private
Industrial Ceramic Products Inc.	Columbus, OH	NA	NA	NA
Industrial Product International	Englewood, CO	1 to 2.5	5 to 9	Private
Inland Enterprise Inc.	Avon, OH	14	100	Private
International Chimney Corp. ^a	Williamsville, NY	18	140	Private
Louisville Firebrick Works	Graham, KY	NA	NA	NA
Maryland Refractories Co.	Irondale, OH	1 to 2.5	NA	Private
Mt. Savage Firebrick Co.	Frostburg, MD	NA	NA	NA
P-G Industries Inc.	Pueblo, CO	12	160	Private
Plibrico Co.	Oak Hill, OH	10 to 20	20 to 49	NA
Porvair PLC	United Kingdom	88.2	658	Public
Refractories Sales and Service Co. Inc.	Bessemer, AL	NA	NA	NA
Reno Refractories Inc.	Morris, AL	16	85	Private
Resco Refractories, Inc.	Norristown, PA	50	500	Private
Riverside Clay Co. Inc.	Pell City, AL	15	100	NA
Rutland Products	Jacksonville, FL	NA	NA	NA

(continued)

Table 2-10. Characteristics of Small Businesses in the Refractory Industry (continued)

Company	Location	Sales (\$10⁶)	Employment	Organization Type
Servsteel Inc.	Morgan, PA			
Shenango Refractories, Inc.	New Castle, PA	5 to 10	20 to 49	Private
Nock and Son Co., The	Oak Hill, OH	2.5 to 5	10 to 19	Private
Whitacre-Greer Fire Proofing Co., The	Alliance, OH	5 to 10	NA	Private
Thorley Refractories Inc.	Southgate, CA	5 to 10	20 to 49	Private
Utah Refractories Co.	Lehi, UT	NA	NA	NA
Zero Refractories, Inc.	Taylor MI	0.5 to 1	1 to 4	Private
BNZ Materials Inc.	Littleton, CO	25	150	Private
CFB Industries Inc. ^a	Chicago, IL	23	176	Private
Insul Co. Inc.	East Palestine, OH	15	77	Private
Pyrotek Inc. ^a	Spokane, WA	50 to 100	NA	Private
Thermatex Corp. (Thermalite)	Fremont, OH	10	148	Private
Universal Refractories Inc.	Wampum, PA	24	130	Private
Advanced Ceramics ^a International Inc.	Cleveland, OH	21	175	Private
Allied Mineral Products Inc.	Columbus, OH	56	240	Private
Alumitech Inc. ^a	Canada	77	447	Public
AMPAC ^a	Amsterdam, NY	13	100	Private
B S C Holding Inc. ^a	Shawnee Mission, KS	23	15	Private
Bartley Crucible & Refractories, Inc.	Trenton, NJ	NA	NA	NA
Blash Precision Ceramics, Inc. (Texas United)	Houston, TX	63	515	Private
CCPI Inc.	Blanchester, OH	25 to 50	NA	Private
Cercom Inc. ^a	Vista, CA	11	76	Private
Chicago Firebrick Co. Inc. ^a	Chicago, IL	18	58	Private
JW Hicks Inc.	Merrellville, IN	5 to 10	20 to 49	Private
Magneco/Metrel Inc.	Addison, IL	34	150	Private
Minco Acquisition Corp. ^a	Midway, TN	21	170	Private

(continued)

Table 2-10. Characteristics of Small Businesses in the Refractory Industry (continued)

Company	Location	Sales (\$10⁶)	Employment	Organization Type
Mixed Mineral Products Inc. ^a	Columbus, OH	NA	NA	NA
Monofrax Inc. ^a	Falconer, NY	50 to 100	250 to 499	Private
Newport Sand & Gravel Co. Inc. ^a	Newport, NH	13	100	Private
Pell Industries	Grove City, PA	5 to 10	20 to 49	Private
Prefromix Technologies LTD ^a	Warren, OH	10	75	Private
Premier Services, Inc.	Bettsville, OH	NA	NA	NA
Rex Roto Corp.	Fowlerville, MI	14	80	Private
Silicon Carbide Products Inc.	Elmira, NY	1 to 2.5	5 to 9	NA
Spar, Inc.	Jacksonville, FL	NA	NA	NA
Bethlehem Corporation, The ^a	Easton, PA	14	117	Private
Varsal Instruments Inc. ^a	Warminster, PA	15	224	Private
Wulfrath Refractories Inc.	Tarentum, PA	22	115	Private
Zircar Products Inc.	Florida, NY	12	85	Private

^a These companies were listed by Ward's Business Directory under the NAICS codes 327124 and 32712. However, they were not linked to a facility in the database. These companies are ignored in the remaining small business analysis.

about the size of companies owning refractory products manufacturing facilities, including both questionnaire responses and publicly available information. To avoid revealing confidential questionnaire data, however, we present only the publicly available data in this section. Data on employment and sales for many of these companies are difficult to acquire from public sources, because they are privately held. Publicly available data suggest that a total of 56 small businesses own 71 facilities that produce refractory products. These are shown in Table 2-10.

In its analysis of small business impacts, EPA has chosen to use a small business size criterion of 750 employees regardless of the primary North American Industry Classification System (NAICS) code of the company. EPA made this decision because some companies in the industry produce both clay and nonclay refractories, making it difficult to assign such companies to a single NAICS code. Using the higher 750 employee small business criterion for all affected companies may overstate the number of small businesses affected by the rule. EPA has obtained company employment and sales data from potentially regulated facilities, some of which are confidential. Based on this information and a small business size criterion of 750 employees, EPA has identified 56 small businesses that are potentially affected by the NESHAP, out of a total of 76 companies owning refractory manufacturing facilities.

2.2.4 Current Production Trends in the Refractory Industry

To remain competitive, refractory manufacturers have continued to improve raw materials and manufacturing and testing processes. The trend toward increased lining life in most applications has reduced the costs of repair and replacement to refractory consumers. Improvements in the production process of steel, glass, and petrochemicals in combination with improvements in refractory products and linings have culminated to reduce the amount of refractory consumption. Recently, the basic oxygen steelmaking furnace linings have exceeded 20,000 heats. The glass industry has experienced increased time between repairs in glass furnaces from every 4 years to 13 years, with little or no preventative maintenance (Sheppard, 2000; *Ceramic Industry*, 2000). From 1998 to 1999, the refractory industry reported a 6 percent decline in production and a 12 percent decline in turnover (DHAN, 1999).

Because of improved quality of refractory products, increased life span of refractory products, and the availability of cheaper refractory imports, the steel industry has decreased consumption of refractories from 25 to 30 kg per ton of steel to 10 kg in Japan and the United States (Semler, 2000). Other consumers of refractory products, including the petroleum industry and concrete industry, are following the steel industry's pattern of reducing consumption of refractories.

2.3 The Demand Side

Estimating the economic impacts of the regulation on the refractory manufacturing industry requires characterizing various aspects of the demand for refractory products. This section describes the product characteristics desired by end users; the uses for refractories, including use in the glass, metal, and electronics industries; and possible substitutes for refractories.

2.3.1 *Product Characteristics*

Because the quality and characteristics of refractories vary considerably, consumers often employ chemical and physical tests to ensure that the refractories purchased meet their requirements. The American Society for Testing and Materials (ASTM) provides specifications and tests for various kinds and uses of refractory products. Depending on the intended end use, consumers may test refractories for thermal conductivity, resistance to abrasion and corrosion, permeability, oxidation resistance, pyrometric cone equivalence, and other characteristics (ASM International, 1987).

Most refractory products are sold as preformed shapes. However, they are also available in special purpose clays; bonding mortars; monolithic, plastic refractories; ramming mixes; and gunning mixes. A variety of processed refractory grains and powders are also produced (DHAN, 1999). From the physical form, refractory products can be further classified into oxide bricks, nonoxide bricks, and composites. Table 2-11 lists types of oxide, nonoxide, and composite refractories; their characteristics; and their applications.

2.3.2 *Uses and Consumers*

Principle end-use markets for refractory products include the iron and steel, cement, and nonferrous metal industries. The steel industry consumes the largest percentage of refractories, estimated between 50 and 80 percent of the refractory production (Semler, 2000).² Table 2-12 presents metric ton production of raw steel and nonferrous metals for the period 1994 to 1999. Refractory products are used in the steel industry to line coke ovens, blast furnaces, blast furnace stoves, basic oxygen vessels, electric furnaces, open-hearth furnaces, and other heat-related manufacturing equipment (ASM International, 1987). As described above, refractory products are used by steel, cement, and nonferrous metals producers. Refractory products manufacturing facilities are typically located close to their consumers (see map in Figure 2-11).

²The U.S. International Trade Commission (USITC) estimated consumption of the steel industry at over 50 percent, and DHAN estimated it at 75 percent.

Table 2-11. Characteristics and Types of Refractories

Refractory Type	General Characteristics	Application
Oxide Bricks		
Silica	High strength at high temperatures, residual expansion, low specific gravity, high expansion coefficient at low temperatures, low expansion coefficient at high temperatures	Glass tank crown, copper refining furnace, electric arc furnace roof
Fused silica	Low thermal expansion coefficient, high thermal shock resistance, low thermal conductivity, low specific gravity, low specific heat	Coke oven, hot stove, soaking pit, glass tank crown
Chamotte (fireclay)	Low thermal expansion coefficient, low thermal conductivity, low specific gravity, low specific heat, low strength at high temperatures, less slag penetration	Ladle, runner, sleeve, coke oven, annealing furnace, blast furnace hot stove, reheating furnace, soaking pit
Alumina	High refractoriness, high mechanical strength, high slag resistance, high specific gravity, relatively high thermal conductivity	Hot stove, stopper head, sleeve, soaking pit cover, reheating furnace, glass tank, high-temperature kiln
High alumina	High refractoriness, high mechanical strength, high slag resistance, high specific gravity, relatively high thermal conductivity	Slide gate, aluminum melting furnace, skid rail, ladle, incinerator, reheating furnace hearth, skid rail, ladle, incinerator
Roseki	Low thermal expansion coefficient, high thermal shock resistance, low thermal conductivity, low specific gravity, low specific heat	Ladle, runner, sleeve, coke oven, annealing furnace, blast furnace hot stove, reheating furnace, soaking pit
Zircon	High thermal shock resistance, high slag resistance, high specific gravity	Ladle, nozzle, stopper head, sleeve
Zirconia	High melting point, low wettability against molten metal, low thermal conductivity, high corrosion resistance, high specific gravity	Nozzle for continuous casting, glass tank, high-temperature furnace, crucible
Alumina zirconia silica	High slag resistance, high corrosion resistance against molten glass	Glass tank, incinerator, ladle, nozzle for continuous casting
Lime	High slag resistance, low hydration resistance	Special refining surface
Magnesia	High refractoriness, relatively low strength at high temperature, high basic slag resistance, low thermal shock resistance, low durability at high humidity	Hot-metal mixer, secondary refining vessel, rotary kiln, checker chamber of glass tank, electric arc furnace
Magnesia-chrome	High refractoriness, high refractoriness under load, high basic slag resistance, relatively good thermal shock resistance (low MgO bricks), high strength at high temperature (direct bonded and fusion cast)	Hot-metal mixer, electric arc furnace, secondary refining vessel, nonferrous refining furnace, rotary cement kiln, lime and dolomite kiln, copper furnace, ladle, checker chamber for glass tank, slag line of electric arc furnace, degasser for copper, nonferrous smelter

(continued)

Table 2-11. Characteristics and Types of Refractories (continued)

Refractory Type	General Characteristics	Application
Oxide Bricks (continued)		
Chrome	High refractoriness, low strength at high temperature, low thermal resistance	Buffer brick between acid and basic brick
Dolomite	High refractoriness, high refractoriness under load, high basic slag resistance, low durability in high humidity, high thermal expansion coefficient	Basic oxygen furnace, electric arc furnace, secondary refining vessel, rotary cement kiln
Spinel	High thermal shock resistance, high strength at high temperatures, high slag resistance	Rotary cement kiln, ladle
Nonoxide Bricks		
Carbon	High refractoriness, high slag resistance, low oxidation resistance	Blast furnace hearth, electric arc furnace
Silicon carbide	High refractoriness, high strength at high temperature, high thermal conductivity, high thermal shock resistance, reduced oxidation resistance at high temperature, high slag resistance	Kiln furniture, incinerator, blast furnace
Silicon carbide-graphite	High refractoriness, high strength at high temperature, high thermal conductivity, high thermal shock resistance	Incinerator
Silicon nitride	High strength, high thermal shock resistance, relatively high oxidation resistance	Kiln furniture, blast furnace
Composite		
Silicon carbide Containing	High corrosion resistance against low iron oxide, high strength at high temperatures, high thermal shock resistance	Ladle, blast furnace, electric arc, torpedo ladle, iron ladle
Magnesia-carbon	High slag resistance, high thermal shock resistance	Basic oxygen furnace, electric arc furnace, ladle
Alumina-carbon	High refractoriness, high thermal shock resistance, high corrosion resistance	Submerged entry nozzle, slide gate

Source: The Technical Association of Refractories, Japan. 1998. *Refractories Handbook*. Tokyo: The Technical Association of Refractories, Japan.

2.3. Table 2-12. Steel and Nonferrous Production (10³ Metric Tons)

<i>Su</i>	Year	Raw Steel Production	Nonferrous
<i>bsti</i>	1994	91,300	11,216
<i>tuti</i>	1995	95,200	13,606
<i>on</i>	1996	94,700	11,608
<i>Pos</i>	1997	98,500	14,501
<i>sibi</i>	1998	98,700	14,811
<i>liti</i>	1999	95,300	15,215

Source: U.S. Department of Commerce, and International Trade Administration. 1999. *U.S. Industry & Trade Outlook 2000*. New York: The McGraw-Hill Companies and U.S. Department of Commerce.

Although there is no direct substitute for refractories, industries that use refractory products have reduced the amount of the product consumed. Since the 1980s, the steel industry has closed inefficient facilities and modernized remaining plants. The industry developed and implemented technologies, such as the basic oxygen furnace (BOF), that significantly reduced the amount of refractories used per ton of steel (USITC, 1994; DHAN, 1999). Also, the refractory industry has made significant strides in developing more durable refractories. These two factors have reduced the overall consumption of refractory materials.

2.4 Markets for Refractory Products

This section provides data on domestic production, domestic consumption, imports, exports of refractories, and gross margin growth in prices. It also discusses trends and projections for the refractory industry.

2.4.1 Market Data

This section provides data on volumes of refractory products produced and consumed in the United States, the quantities imported and exported, and prices. Figure 2-12 illustrates historic trends in refractory production.

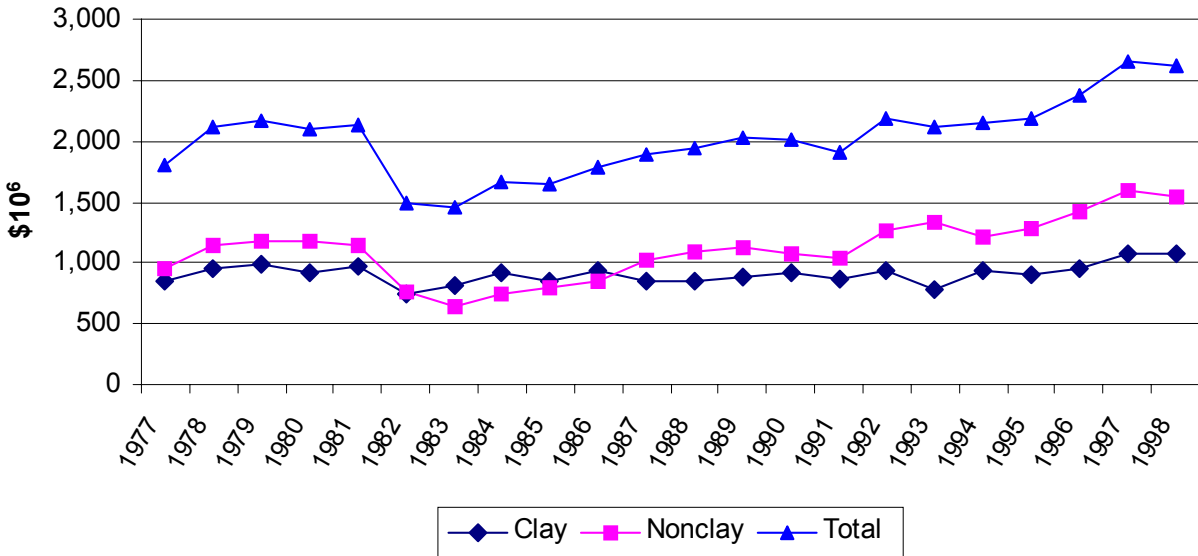

Figure 2-12. Historical Refractory Production Trends

Note: All financial figures are adjusted for inflation using the producer price index available from the U.S. Bureau of Labor.

2.4.1.1 Domestic Production

During the last two decades, the refractory industry has been affected by declining demand per production of steel for traditional refractory products, such as bricks and shapes, and customer requirements for higher-quality special refractories. Accounting for nearly 40 percent of all shipments, bricks and shapes are the principal forms of refractory products produced in the United States (USITC, 1993). Table 2-13 illustrates the values of domestically produced clay and nonclay refractories from 1977 to 1998 in both current and 1998 dollars.

2.4.1.2 International Trade

As indicated in Table 2-14, international trade is not a major component of the U.S. market for refractory products. In 1999, refractory exports accounted for a little over 16 percent of shipped refractory products. Nations with significant iron, steel, cement, and nonferrous metal industries, including the United States, Europe, and Japan, are the major world markets for refractory products. From 1988 to 1992, Canada was the leading importer

Table 2-13. Production of Refractories: 1977–1998 (\$10⁶)

Year	Clay		Nonclay		Total	
	Current	1998	Current	1998	Current	1998
1977	607.2	848.9	680.2	950.9	1,287.4	1,799.8
1978	717.3	956.4	864.2	1,152.3	1,581.5	2,108.7
1979	776.9	983.5	934.9	1,183.5	1,711.8	2,167.0
1980	761.6	922.4	975.9	1,182.0	1,737.5	2,104.4
1981	864.2	976.0	1020.9	1,153.0	1,885.1	2,129.0
1982	670.3	738.4	691.0	761.2	1,361.3	1,499.5
1983	745.5	813.8	588.9	642.9	1,334.4	1,456.7
1984	868.6	920.1	701.4	743.0	1,570.0	1,663.1
1985	803.0	849.2	755.3	798.7	1,558.3	1,647.9
1986	843.5	931.4	768.5	848.6	1,612.0	1,780.0
1987	788.2	851.2	954.5	1,030.8	1,742.7	1,882.1
1988	836.7	851.0	1,078.1	1,096.5	1,914.8	1,947.5
1989	906.3	892.5	1,113.3	1,130.3	2,019.6	2,022.8
1990	922.9	927.0	1,077.6	1,082.4	2,000.5	2,009.5
1991	850.4	872.6	1,009.2	1,035.5	1,859.6	1,908.1
1992	886.8	930.6	1,203.5	1,263.0	2,090.3	2,193.6
1993	758.0	784.6	1,282.2	1,327.1	2,040.2	2,111.7
1994	938.8	929.5	1,232.2	1,220.0	2,171.0	2,149.5
1995	958.2	896.2	1,370.4	1,281.7	2,328.6	2,178.0
1996	977.3	953.6	1,459.4	1,424.0	2,436.7	2,377.6
1997	1,101.6	1,072.9	1,631.2	1,588.7	2,732.8	2,661.6
1998	1,082.8	1,082.8	1,535.8	1,535.8	2,618.6	2,618.6

Sources: U.S. Department of Commerce, Bureau of the Census. 1994b. *1992 Census of Manufactures, Industry Series—Cement and Structural Clay Products*. Washington, DC: Government Printing Office.

U.S. Department of Commerce, Bureau of the Census. 1995. *1993 Annual Survey of Manufactures*. M93(AS)-1. Washington, DC: Government Printing Office.

U.S. Department of Commerce, Bureau of the Census. 1996a. *1994 Annual Survey of Manufactures*. M94(AS)-1. Washington, DC: Government Printing Office.

U.S. Department of Commerce, Bureau of the Census. 1997. *1995 Annual Survey of Manufactures*. M95(AS)-1. Washington, DC: Government Printing Office.

U.S. Department of Commerce, Bureau of the Census. 1998. *1996 Annual Survey of Manufactures*. M96(AS)-1. Washington, DC: Government Printing Office.

U.S. Department of Commerce, Bureau of the Census. 1999b. *1997 Census of Manufactures, Industry Series—Manufacturing: Clay Refractory Manufacturing*. Washington, DC: Government Printing Office.

U.S. Department of Commerce, Bureau of the Census. 2000. *1998 Annual Survey of Manufactures*. M98(AS)-1. Washington, DC: Government Printing Office.

Table 2-14. Exports and Imports of Refractories: 1993–1999 (\$10⁶ 1998)

Year	Exports			Imports			Apparent Consumption		
	Clay	Nonclay	Total	Clay	Nonclay	Total	Clay	Nonclay	Total
1993	72.8	251.9	324.7	28.8	177.7	206.5	740.3	1,065.2	1,805.5
1994	62.1	262.9	325.5	26.4	183.7	210.1	843.3	992.8	1,836.1
1995	76.8	298.0	374.8	33.2	198.6	231.8	873.8	1,045.6	1,919.3
1996	71.7	314.7	386.4	27.0	211.1	238.2	856.9	1,077.4	1,934.3
1997	81.8	290.1	372.0	27.8	248.3	275.9	863.5	1,197.5	2,061.0
1998	59.6	278.9	338.6	30.9	225.1	256.0	942.0	1,113.3	2,055.3
1999	53.2	287.4	340.6	104.0	218.7	323.2	934.5	989.0	1,923.6

Source: U.S. Department of Commerce, Bureau of the Census. 1993–1999. *Current Industrial Reports: Refractories*. MA 32C. Available at <<http://www.census.gov/industry/ma32c97>>.

of U.S. refractory products, with over 38 percent of all exports, followed by Mexico. Emerging foreign markets for the United States include India, China, and other countries in Central and South America. Japan and Canada are the top suppliers of imports to the United States (USITC, 1994). Recently, exports of refractory products have fallen and imports of refractory products have increased.

2.4.2 Market Prices

Table 2-15 lists average prices for refractory products for 1989, 1993, and 1998. Monolithic refractory prices have decreased 2 percent and bricks and shapes have increased 4.8 percent since 1993. Most refractory products are typically used in kilns and ovens and are engineered for a particular use. Price is typically based on the consumer's requirements.

2.4.3 Industry Trends

In the last decade, the refractory industry has experienced significant restructuring. Two large conglomerates, RHI and Vesuvius, dominated refractories markets (Sheppard, 2000). In 1999, Alpine Group sold its Premier Refractories unit to Cookson Group of the U.K., and Global Industrial Technologies (parent of Harbison-Walker Refractories) was acquired by RHI AG (formerly Radex Heraklith Industriebeteiligungs) of Austria. Other leading refractory producers are Allied Mineral Products, Baker Refractories, Minerals

Table 2-15. Average Price for Refractory Products^a (\$/ton)

Form	1989		1993		1998
	Current	1998	Current	1998	Current
Monolithics	451	526	491	544	533
Bricks and shapes	709	826	782	866	910
Other ^b	394	459	442	490	497

^a Prices were deflated using the producer price index (PPI) from the Bureau of Labor Statistics. 2001.
<<http://146.142.4.24/cgi-bin/surveymost>>.

^b Other refractory forms consist of ceramic fibers and refractory raw materials that are supplied in lump or ground form used to manufacture refractories “in-house.”

Source: Freedonia Group. September 1999. “Refractories in the United States to 2003.” Profound WorldSearch
<<http://www.profound.com>>

Technologies (via MINTEQ), Morgan Crucible, National Refractories Holding Co., Resco Products, and Compagnie de Saint-Gobain.

In recent years, consumption of domestically produced refractory products has declined somewhat, as a result of several compounding trends. First, the quality of refractory products has increased, resulting in longer life and fewer replacements. Thus, the tons of refractory products consumed per ton of steel produced have declined somewhat. In addition, imports of refractory products have increased approximately 57 percent from 1993 to 1999, so a smaller share of the refractory products consumed domestically are produced domestically.

SECTION 3

ENGINEERING COST ANALYSIS

Control measures implemented to comply with the MACT standard will result in higher production costs for affected refractory facilities. The engineering analysis computed estimates of these compliance costs (annual capital, operating, testing, monitoring, reporting and record keeping) for each affected facility under baseline economic conditions. These estimates serve as key inputs to the economic model.³ The following section presents a brief overview of emissions from refractory products manufacturing and the estimated costs refractory products manufacturers are projected to incur to comply with the rule. More detailed information is provided in technical memoranda (Marinshaw and Fields, 2003a and 2003b).

3.1 Overview of Emissions from Refractory Manufacturing

Refractory products manufacturing facilities are sources of several HAPs. The specific types and quantities of HAPs emitted from any particular facility are largely a function of the types of raw materials used and how those materials are processed. Resin-bonded refractory curing ovens and kilns can emit phenol, formaldehyde, methanol, and ethylene glycol, depending on the type of resin used. When used as binders or additives in the production of nonresin-bonded refractory shapes, ethylene glycol and methanol also are emitted from shape dryers and kilns. Pitch-bonded refractory heated pitch storage tanks, shape dryers, and kilns emit POM. The heated pitch storage tanks, shape preheaters, defumers, and coking ovens used to produce pitch-impregnated refractories also emit POM. HF and HCl are emitted from kilns that are used to fire clay refractory products.

Section 112 of the Clean Air Act lists 189 HAPs and defines major sources as those facilities that emit or have the potential to emit at least 10 tons per year of any single HAP or at least 25 tons per year of any combination of HAPs. Area sources are those with potential uncontrolled emissions of less than 10 tons per year of any HAPs and less than 25 tons per year of combined HAPs. Synthetic area sources are area sources that would be major sources if existing controls at those facilities were not in place. In other words, synthetic area sources are those sources whose uncontrolled HAP emissions exceed the major source thresholds of 10 tons per year of a single HAP or 25 tons per year of combined HAPs. Synthetic area sources are of particular significance because those facilities are included in the MACT floor analysis for existing sources, whereas “true” area sources are not included in the floor determinations and are not subject to the requirements of the rule.

³In the market model, the engineering cost inputs are expressed per unit of refractory product (\$/ton) and used to shift the refractory supply functions in the market model to predict the response in price and production levels. Details can be found in Section 4 and Appendix A.

Based on the HAP emission estimates within the refractory products manufacturing industry five facilities emit at least 10 tons per year of a single HAP and two other facilities emit more than 8.5 tons/yr of a single HAP. In view of the uncertainties in emission estimation techniques, these two facilities also could be major sources. One facility is a considered major source for co-located process operations. The Agency estimates that, of the 147 refractory products manufacturing facilities currently in operation in this source category, 133 are area sources, eight are major sources, and six are synthetic area sources.

The Agency estimates that of the eight major sources two emit major amounts of HF emissions and HCl emissions resulting from clay calcining and/or clay refractory manufacturing and are not expected to be subject to the rule (because only new clay kilns, and not existing kilns, would be subject to substantive requirements of the rule for reducing HF and HCl). New kilns used to fire chromium refractories would similarly be subject only to new source MACT and would not be required to control existing sources for reducing chromium emissions from kilns.

Therefore, six existing major sources would have costs associated with compliance with the standard for organic HAPs, in addition to two facilities required to do recordkeeping and reporting. Costs for these facilities are shown in Table 3-1.

3.2 Compliance Cost Estimates

Sources of emissions at refractory manufacturing facilities that are covered by the NESHAP for refractory manufacturing are

- C new kilns that fire chromium refractories and clay refractories and
- C heated processes that emit organic HAPs at new and existing sources, including
 - curing ovens, drying ovens (shape dryers), and kilns used at refractory product manufacturing facilities that are major sources emitting organic HAPs from the affected sources, and

Table 3-1. Summary of Estimated Annual Compliance Costs for Refractory Products Manufacturing NESHAP

Plant ID	Initial Capital Cost (\$)	Control Costs										Annualized Record-keeping Cost (\$/yr)	Annualized Total Cost (\$/yr)
		Annualized Capital Cost (\$/yr)	Annual Overhead Cost (\$/yr)	Annual Taxes, Ins., Admin. Cost (\$/yr)	Annual Maintenance Material Cost (\$/yr)	Annual Energy Cost (\$/yr)	Annual Labor Cost (\$/yr)	Total Annualized Control Costs (\$/yr)	Annual Testing Cost (\$/yr)	Annualized Monitoring Cost (\$/yr)			
R004	\$1,115,200	\$158,800	\$15,600	\$44,600	\$10,300	\$376,000	\$15,700	\$621,000	\$31,800	\$16,800	\$8,000	\$88,000	\$677,600
R012	\$1,368,200	\$194,800	\$48,300	\$54,700	\$31,900	\$222,200	\$48,600	\$600,500	\$36,500	\$8,000	\$8,000	\$88,000	\$653,000
R027	\$944,100	\$134,400	\$8,500	\$37,800	\$5,600	\$72,700	\$8,600	\$267,600	\$14,400	\$4,800	\$8,000	\$88,000	\$294,800
R065	\$383,400	\$54,600	\$12,400	\$15,300	\$8,200	\$179,600	\$12,500	\$282,600	\$4,600	\$1,600	\$8,000	\$88,000	\$296,800
R111	\$0	\$0	\$0	\$0	\$0	\$0	\$0	\$0	\$0	\$0	\$1,200	\$1,200	\$1,200
R126	\$0	\$0	\$0	\$0	\$0	\$0	\$0	\$0	\$0	\$0	\$1,200	\$1,200	\$1,200
R128	\$0	\$0	\$0	\$0	\$0	\$50,200	\$0	\$50,200	\$36,300	\$12,800	\$8,000	\$88,000	\$107,300
R178	\$794,100	\$113,100	\$19,900	\$31,800	\$13,100	\$55,300	\$20,000	\$253,200	\$16,300	\$4,800	\$8,000	\$88,000	\$282,300
Total	\$4,605,000	\$655,700	\$104,700	\$184,200	\$69,100	\$956,000	\$105,400	\$2,075,100	\$139,900	\$48,800	\$50,400	\$504,400	\$2,314,200

- brick preheaters, pitch working tanks, defumers, and coking ovens used at pitch-impregnated refractory manufacturing facilities.

As noted above, HAPs that EPA has identified as being emitted from refractory manufacturing facilities include chromium, HF, HCl, phenol, POM, ethylene glycol, methanol, and formaldehyde.

The costs associated with improved emissions control are estimated based on what each plant may have to do to control organic HAP emissions. Controlled sources include thermal process units (i.e, dryers, curing ovens, kilns, coking ovens, defumers, and heated pitch storage tanks) that emit one or more organic HAPs. As shown in Table 3-1, the Agency estimates the nationwide costs of the rule are \$2.31 million. EPA estimates that initial capital costs will total \$4.6 million. These capital costs, annualized over a period of 20 years at a 7 percent rate of interest, result in annualized capital costs of approximately \$655,700. The total annualized costs include these annualized capital costs, \$1,419,400 of annual overhead, administrative, and operating and maintenance costs for emissions controls, and \$239,100 of testing, monitoring, recordkeeping, and reporting costs. Among the six facilities incurring control costs, the total annualized costs range from \$1,200 to \$677,600 and average \$289,300.

3.2.1 Emission Control Costs

Emission control costs include the costs of purchasing and installing emission control capital equipment and operating and maintenance costs including the costs of labor, materials, and energy to operate the controls, and any associated costs such as administrative costs, insurance, or taxes associated with the emission controls. Five facilities are projected to incur capital emissions control costs under the refractories NESHAP, ranging from \$383,400 to \$1.37 million. Because the cost of this capital equipment is a large lump-sum expenditure, companies typically finance the cost over a period of years. Thus, EPA estimates the annualized capital costs of the rule by annualizing the lump-sum capital costs over a period of 20 years at a 7 percent discount rate. The annualized capital costs range from \$54,600 to \$194,800. Among the annual emissions control costs, the highest costs are associated with incremental energy required to operate the controls. Energy control costs range from \$50,200 to \$376,000 per year and total \$956,000. Total annualized emission control costs for the refractories NESHAP range from \$50,200 to \$621,000 and total \$2.08 million, which is 90 percent of the total annualized costs of the rule. Of this total, \$1.42 million represent annual operating and maintenance costs of the controls (61 percent of the rule's total costs), and \$655,700 represent the annualized cost of the control equipment (28 percent of the rule's total annualized costs).

3.2.2 Compliance Testing Costs

Affected thermal process sources of organic HAP can demonstrate compliance with either the 20 ppmvd THC limit (testing for THC at the outlet of the control device or in the stack using Method 25A) or the 95 percent THC reduction limit (testing for THC at the control device inlet and outlet using Method 25A). The compliance test must be repeated every 5 years.

Testing costs were annualized over a 5-year period using a 7 percent discount rate. Testing costs at the six refractory manufacturing facilities incurring control costs range from \$4,600 per year to \$36,500 per year and total \$139,900 or 6 percent of the total annualized costs of the regulation.

3.2.3 Monitoring, Recordkeeping, and Reporting Costs

Monitoring costs include the cost of installing and operating a system to measure and record control device operating temperatures on a continuous basis. System components include a thermocouple and a data acquisition system. Annualized costs were computed assuming a data acquisition system life of 15 years, a thermocouple life of 2 years, and a 7 percent discount rate. Monitoring costs for facilities incurring control costs range from \$1,600 to \$16,800 and total \$48,800 or 2 percent of the rule's total annualized costs. Annual reporting and recordkeeping costs were estimated using Standard Form 83 and were considered one-time costs annualized over a 5-year period at a 7 percent discount rate. Recordkeeping and reporting costs are estimated to range from \$1,200 to \$8,000 for facilities incurring costs. Overall, the \$50,400 recordkeeping and reporting costs represent 2.2 percent of the rule's total annualized costs.

3.2.4 Total Annualized Costs

Summing all categories of costs together, the six refractory manufacturing facilities are projected to incur total annualized costs ranging from \$1,200 to \$677,600. Total annualized costs for the rule are estimated to be \$2,314,200.

SECTION 4

ECONOMIC IMPACT ANALYSIS: METHODS AND RESULTS

The underlying objective of the EIA is to evaluate the effect of the regulation on the welfare of affected stakeholders and society in general. Although the engineering cost analysis presented in Section 3 does represent an estimate of the respective plants' resources required to comply with the regulation under baseline economic conditions, the analysis does not account for the fact that the regulations may cause the economic conditions to change. For instance, producers may elect to discontinue production rather than comply, thereby reducing market supply. Moreover, the control costs may be passed along to other parties through various economic exchanges (such as price increases). The purpose of this section is to develop and apply an analytical structure for measuring and tracking these effects as they are distributed across the stakeholders tied together through economic linkages.

4.1 Markets Affected by the NESHAP

Refractory products are in fact fairly specialized, and each batch could be considered a unique product. For modeling the impacts, however, EPA aggregated the refractory products produced by manufacturers in the industry into broad markets. We considered two aggregation schemes: by type of input or material (clay and nonclay) or by form of output. Although the *Census of Manufactures* divides refractories into clay and nonclay, we have concluded that the consumers of refractory products are more concerned about their form than their raw material. Therefore, EPA estimated impacts in three broad refractory product markets:

- C bricks and shapes,
- C monolithics (not directly affected by the NESHAP), and
- C refractory ceramic fibers or RCF (not affected by the NESHAP).

These are the refractory products for which EPA's database provides information. For each facility in the industry, EPA has estimated quantities of each of these products manufactured on-site.

4.2 Conceptual Approach

Industry comments on the rule indicated that the depressed condition of the steel industry, coupled with increased pressure from imported refractories, limit refractory manufacturers' ability to pass cost increases along to their customers in the form of increased prices. In response to these comments, EPA has chosen to model the supply of imported refractories (in the bricks and shapes market) as perfectly elastic. That is, any decrease in domestic production will be offset by increased imports; thus, no price increase occurs. As a result, the Agency has adopted different methods to model the markets for each refractory

commodity. The bricks and shapes market is represented by a full-cost-absorption model, where costs are imposed on facilities and are added to baseline production costs at directly affected plants. Neither market price nor quantity is permitted to adjust in response to higher costs. Thus, the only impact of the higher costs is to reduce the profits of directly affected facilities. This model incorporates a perfectly elastic international supply component, which assumes that foreign producers expand output as affected firms reduce supply due to increased production costs. In the monolithics and RCF markets, simple national competitive market models were developed to estimate the economic impacts to society. In these markets, buyers and sellers exert no individual influence on market prices for refractory commodities potentially affected by the rule. Prices in these markets are set by the collective actions of producers and consumers, who take the market price as a given in making their production and consumption choices.

4.2.1 Producer Characterization

Many refractory plants produce multiple refractory products. Therefore, individual *product-line* supply decisions for existing domestic producers were modeled in this analysis. These decisions were modeled as intermediate-run decisions, assuming that the plant size, equipment, and technologies are fixed. Given the existence of these fixed production factors, each product line was characterized by an upward-sloping supply function (see Figure 4-1). A profit-maximizing firm will select its output level according to this schedule as long as the market price is sufficiently high to cover average variable costs (i.e., greater than C_0 in Figure 4-1). Thus, in the short run, a profit-maximizing firm will not pass up an opportunity to recover even part of its fixed investment in plant and equipment. These individual supply decisions for domestic producers were aggregated (i.e., horizontally summed) to develop a market supply curve for each refractory product. The majority of the industry is not affected directly; however, they are affected indirectly by the decrease in the output of refractory

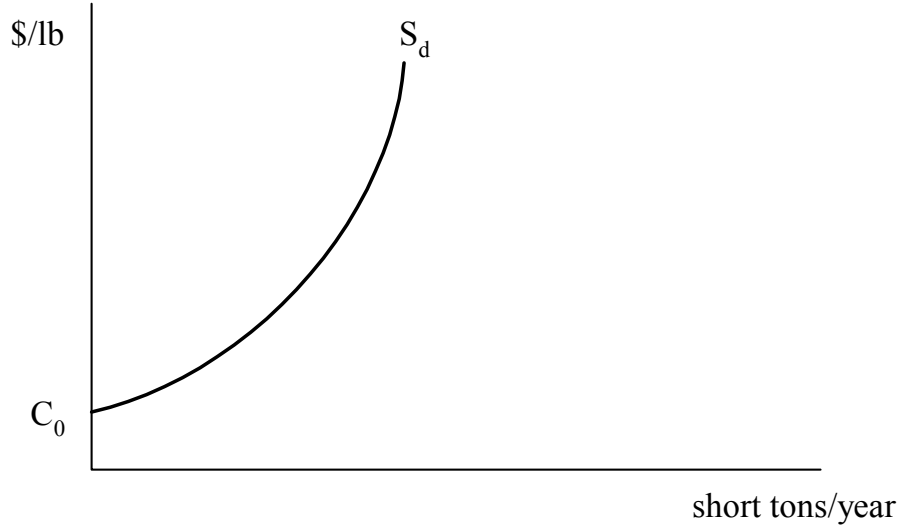

Figure 4-1. Supply Curve for a Representative Directly Affected Facility

products by the industry. Foreign refractory producers, who are assumed in this model to have perfectly elastic supply curves, may respond to the decrease in refractories production in the U.S. by supplying more to the U.S. market.

4.2.2 Consumer Characterization

Demand for refractory products comes mainly from the iron and steel industry, cement industry, and nonferrous metals industry, although smaller shares are sold for use in glass manufacturing and oil refining. The U.S. International Trade Commission (1994) estimates that over 50 percent of refractories are used in the iron and steel industry; DHAN (1999) estimated this share to be 75 percent. There are no direct substitutes for refractory products. Nevertheless, over time, consumers of refractory products have reduced the amount of refractory products consumed. Over the past 20 years, the iron and steel industry has restructured, closing inefficient facilities and modernizing remaining plants. Newer steelmaking technologies significantly reduced the amount of refractories used per ton of steel. Given data limitations, each commodity market will be modeled as having a single aggregate consumer with a downward-sloping market demand curve (see Figure 4-2).

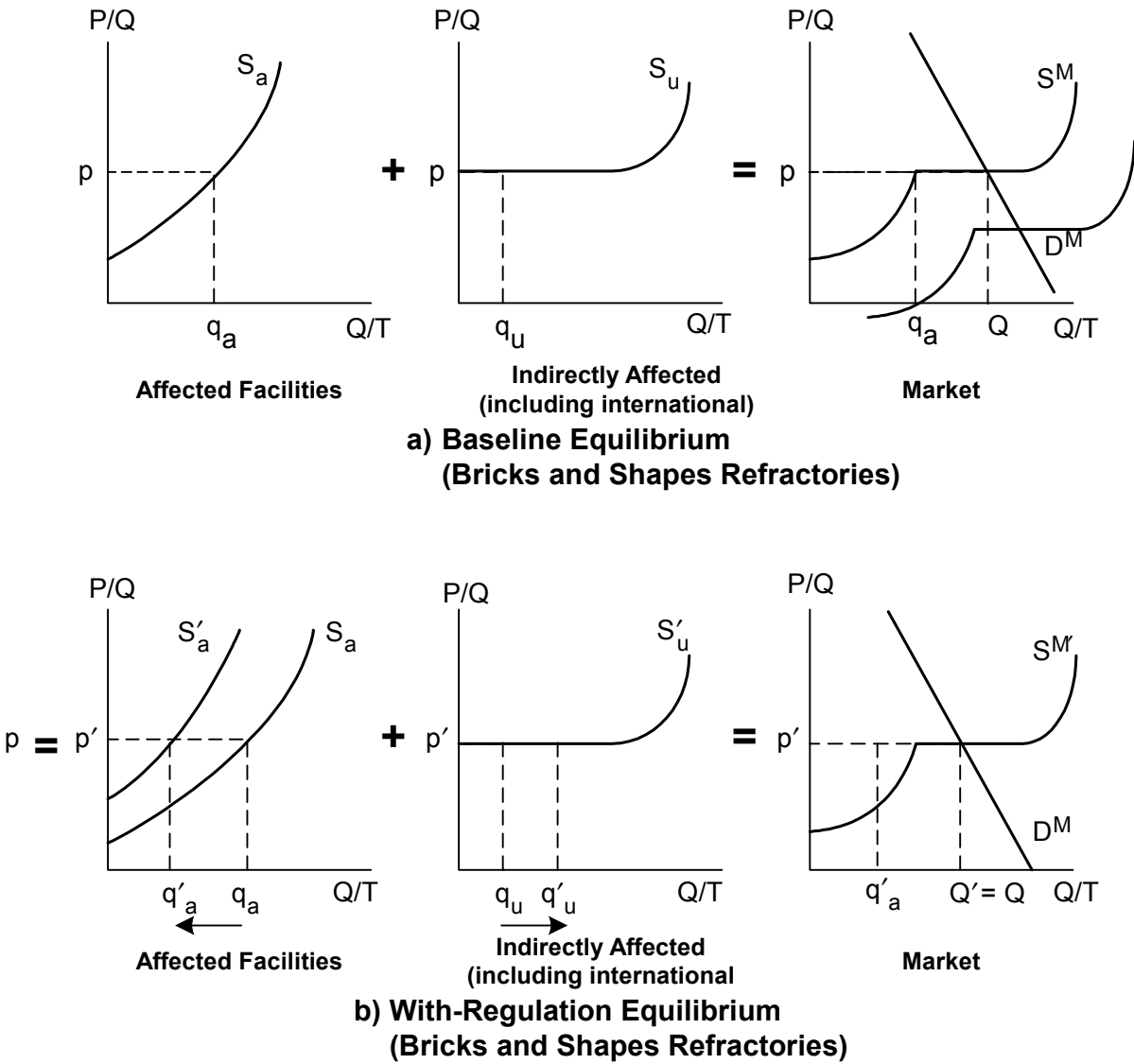

Figure 4-2. Market Equilibrium for Bricks and Shapes Refractories without and with Regulation

4.2.3 Foreign Trade

Although the NESHAP will directly affect domestic facilities that produce refractory products, the rule may have indirect foreign trade implications. Industry stakeholders have commented that foreign suppliers have lower prices than domestic suppliers. If this is true, affected refractory producers may be unable to increase their prices in response to the increased

costs associated with compliance. Thus, to characterize the refractory market for bricks and shapes, the Agency has developed a full-cost-absorption model that incorporates international trade. Under full-cost-absorption, foreign imports may become more attractive to U.S. refractory consumers and U.S. exports may become less attractive to foreign refractory consumers. On the import side, the model assumes that foreign firms that produce bricks and shapes refractories have perfectly elastic supply curves and thus can adjust output to meet demand by using excess capacity in their existing plants. On the export side, foreign demand for refractories produced in the United States may decrease if they become relatively more expensive because of the regulation. Finally, domestic facilities could relocate to foreign countries with laxer environmental regulations if domestic production costs increase. However, given the relatively small size of the expected compliance costs it is unlikely that the regulations will trigger industrial flight at least in the short run. This assumption is consistent with empirical studies in the literature that have found little evidence of environmental regulations affecting industry location decisions (Levinson, 1996).

4.2.4 Baseline and With-Regulation Equilibrium

Impacts of the Refractory Products NESHAP are concentrated in the market for Bricks and Shapes. The markets for other types of refractories, including monolithics and RCF, are unaffected.

4.2.4.1 Bricks and Shapes Market

Under the baseline scenario for bricks and shapes refractories (Figure 4-2[a]), a market price and quantity (p, Q) are determined by the intersection of the downward-sloping market demand curve (D^m) and the market supply curve (S^m). The individual supply curve for each affected domestic plant is defined as upward sloping to reflect factories' willingness to produce additional units of output as the price of each unit rises. The market supply curve for affected plants (S_a) is constructed by summing horizontally across the individual supply curves. For indirectly affected firms (including foreign suppliers), output is characterized by a perfectly elastic market supply curve (S_u), that reflects their ability to rapidly adjust production levels.

With the regulation, the costs of production increase for affected suppliers. These additional costs include a variable component consisting of the operating and maintenance costs and a fixed component that does not vary with output (i.e., expenditures for control-related capital equipment to comply with the regulatory alternative). The imposition of regulatory control costs is represented as an upward shift in the supply curve for each product line. The upward shift of individual supply curves causes the market supply curve for affected refractory products to contract as shown in Figure 4-2(b). Under a full-cost-absorption scenario, the costs that are imposed are added to baseline production costs at directly affected facilities. Market price and quantity do not adjust in response to the higher costs, because indirectly affected firms have the opportunity to expand output along their supply curve (from q_u to q_u,r) by an amount equivalent to the reduction in supply by affected producers.

In baseline without the standards, the bricks and shapes refractories industry produces total output at quantity, Q , and at price, p , with directly affected facilities producing the amount q_a and indirectly affected facilities accounting for Q minus q_a , or q_u . With the regulation, the only impact of the higher regulatory costs is to reduce the profits of directly affected facilities. Indirectly affected firms are able to compensate for the loss of output at affected firms by increasing supply to the market. The net result is that market quantities ($Q = Q_N$) and prices ($p = p$) remain constant for bricks and shapes refractories.

4.2.4.2 Monolithics and RCF Markets

The monolithic refractory sector and the RCF sector are not projected to be directly impacted under the regulation. Thus, prices are projected to remain constant and no change in quantity is anticipated as a result of the MACT standards.

4.3 Economic Impact Results

To develop quantitative estimates of these impacts, EPA developed a computer model using the conceptual approach described above.⁴ Using this model, EPA characterized supply and demand of three refractory commodities—bricks and shapes, monolithics, and refractory ceramic fiber (RCFs)—for the baseline year, 1998; introduced a policy “shock” into the model by using control cost-induced shifts in the supply functions of affected producers; and used a solution algorithm to determine a new with-regulation equilibrium in each refractory market. We report the market, industry, and societal impacts projected by the model below.

4.3.1 Market-Level Impacts

Under the regulation, the price and quantities of refractory products are expected to vary marginally from 1998 baseline levels. As shown in Table 4-1, regulatory costs will reduce domestic production of refractory products (bricks and shapes) by less than 1 percent. However, this reduction will be offset by an equal increase in the quantity of foreign imports; thus, the domestic price will remain unchanged. The regulation is not projected to have a measurable

⁴Appendix A includes a description of the baseline data set, model equations, and solution algorithm.

Table 4-1. Market-Level Impacts: 1998

	Baseline	With Regulation	Change Absolute	Relative
Bricks and Shapes				
Price (\$/ton)	\$910.00	\$910.00	\$0.00	0.00%
Quantity (short tons)	1,863,000	1,863,000	0	0.00%
Domestic	1,679,400	1,675,500	-3,970	-0.24%
Imports	183,500	187,300	3,970	2.16%
Monolithics				
Price (\$/ton)	\$533.00	\$533.00	\$0.00	0.00%
Quantity (short tons)	684,361	684,361	0	0.00%
RCF				
Price (\$/ton)	\$497.00	\$497.00	\$0.00	0.00%
Quantity (short tons)	34,490	34,490	0	0.00%

impact on the monolithics and RCF markets.

4.3.2 Industry-Level Impacts

Industry revenue, costs, and profitability change as prices and production levels adjust to increased production costs. As shown in Table 4-2, the economic model projects that profits for refractory producers will decrease by \$2.1 million, or 2.38 percent reflecting the cost of implementing regulatory controls. Under the regulation, total revenues decline by \$3.6 million, or a change of 0.2 percent below the baseline. Production costs decline by \$3.5 million, as output is reduced at facilities incurring compliance costs. Overall, total costs decline by \$1.5 million under the regulation, which represents less than 0.1 percent change from the baseline.

Table 4-2. Industry-Level Impacts: 1998

	Baseline	With Regulation	Change	
			Absolute	Relative
Total revenue (\$10 ⁶ /yr)	\$1,910.2	\$1,906.6	-\$3.6	-0.19%
Total costs (\$10 ⁶ /yr)	\$1,822.3	\$1,820.7	-\$1.5	-0.08%
Control	\$0.0	\$2.0	\$2.0	NA
Production	\$1,822.3	\$1,818.8	-\$2.1	-0.18%
Pre-tax earnings (\$10 ⁶ /yr)	\$87.9	\$86.1	-\$1.8	-2.38%
Facilities (#)	147	146	-1	-0.68%
Employees (FTEs ^a)	12,440	12,382	-91	-0.73%

^a FTEs = full-time equivalent employees.

Additional distributional impacts of the rule within each producer segment are not necessarily apparent from the reported decline or increase in their aggregate operating profits. The regulation creates both gainers and losers within each industry segment based on the distribution of compliance costs across facilities. As shown in Table 4-3, facilities incurring compliance costs (i.e., eight plants, or 5 percent) are projected to become less profitable under the regulation with a total loss of \$2.1 million. However, 139 facilities are projected to experience no change in profit due to the NESHAP. Foreign producers will also experience increased revenues as they assume a slightly larger share of the refractories market.

4.3.2.1 Facility Closures and Changes in Employment

EPA estimates that one facility is likely to close prematurely as a result of the regulation. However, this facility has options to reduce the emissions or change the processes so that they would no longer be classified as a major source and not incur any compliance costs. The cost to this facility would then be the amount necessary to convert to nonmajor source status. Because we do not know how this facility will respond, our model imposes the MACT regulation costs on this facility and predicts a closure because the with-regulation cost of production exceeds revenue. This facility is estimated to employ fewer than 50 employees at baseline; other plants

Table 4-3. Distributional Impacts Across Facilities: 1998

	Operating Profit		
	Loss ^a	Gain or No Change	Total
Facilities (#)	8	139	147
Compliance costs			
Total (\$10 ⁶ /yr)	\$2.31	\$0	\$2.31
Change in pre-tax earnings (\$10 ⁶ /yr)	-\$2.09	\$0.00	-\$2.09

^aThe loss column includes one projected facility closure.

incurring costs may reduce employment slightly as their output declines. On balance, EPA expects industry employment to change by less than 100 employees, less than 1 percent of industry employment.

4.3.3 Social Cost

The social impact of a regulatory action is traditionally measured by the change in economic welfare that it generates. The social costs of the rule will be distributed across producers of refractory products and their customers. Consumers of refractory products experience minimal welfare impacts due to minimal changes in market prices and consumption levels associated with the rule. Domestic producers experience welfare impacts resulting from changes in profits corresponding with the changes in production levels and market prices. However, it is important to emphasize that this measure does not include benefits that occur outside the market, that is, the value of reduced levels of air pollution with the regulation.

The national compliance cost estimates are often used as an approximation of the social cost of the rule. The engineering analysis estimated annual costs of \$2.31 million. In cases where the engineering costs of compliance are used to estimate social cost, the burden of the regulation is measured as falling solely on the affected facilities, which experience a profit loss exactly equal to these cost estimates. Thus, the entire loss is a change in producer surplus with no change (by assumption) in consumer surplus, because all factors of production are assumed to be fixed and firms are unable to adjust their output levels when faced with additional costs.

In contrast, the economic analysis conducted by the Agency accounts for behavioral responses by producers and consumers to the regulation, as affected producers shift costs to other economic agents. This approach results in a social cost estimate that may differ from the engineering compliance cost estimate and also provides insights on how the regulatory burden is distributed across stakeholders. The computation of social costs is discussed in detail in Appendix B. As shown in Table 4-4, the economic model estimates the total social cost of the rule to be \$2.09 million. Although society reallocates resources as a result of the increased cost of refractory production, only a relatively small change in social welfare occurs. Users of

refractory products (i.e., consumers such as the steel industry) are projected to incur no change in their social welfare, because prices of refractory products remain unchanged. Industrywide, refractory domestic producers experience a net loss of \$2.09 million. This net loss includes welfare changes experienced by facilities incurring compliance costs (which experience increased costs and decreased output and profit) and welfare changes experienced by producers that do not incur compliance costs (who may produce more in response to declines in production at affected facilities). It also reflects the projected premature closure of one refractory manufacturing facility. Overall, however, the impacts on both refractory manufacturers and their customers are projected to be relatively small.

Table 4-4. Distribution of Social Costs: 1998

	Value (\$10 ⁶ /yr)
Consumer surplus	-\$0.00
Bricks and shapes	-\$0.00
Monolithics	-\$0.00
RCF	\$0.00
Producer surplus	-\$2.09
Domestic	-\$2.09
Foreign	\$0.00
Total social cost	-\$2.09

SECTION 5

SMALL BUSINESS IMPACTS

Environmental regulations like this rule potentially affect all businesses, large and small, but small businesses may have special problems complying with such regulations. The Regulatory Flexibility Act (RFA) of 1980 as amended in 1996 by the Small Business Regulatory Enforcement Fairness Act (SBREFA) generally requires an agency to prepare a regulatory flexibility analysis of a rule unless the agency certifies that the rule will not have a significant economic impact on a substantial number of small businesses, small governmental jurisdictions, and small organizations. This section examines the proposed rule's impact on these entities.

5.1 Identify Small Entities

For purposes of assessing the impacts of the proposed rule on small entities, a small entity is defined as (1) a small business according to Small Business Administration (SBA) size standards for NAICS code 327124 (Clay Refractories) of 500 or fewer employees or NAICS code 327125 (Nonclay refractories) of 750 or fewer employees;⁵ (2) a small governmental jurisdiction that is a government of a city, county, town, school district, or special district with a population of less than 50,000; and (3) a small organization that is any not-for-profit enterprise that is independently owned and operated and is not dominant in its field.

The Agency collected data on facility and company employment from the industry; additional data were collected from publicly available sources such as financial databases. Based on this employment data, EPA determined that 56 small entities within this source category would be subject to this proposed rule. Of the 76 companies owning refractory manufacturing facilities in the EPA database, only 20 have company-level employment data showing that they have more than 750 employees. These are classified as large companies for purposes of this analysis. The remaining 56 companies are classified as small entities.

5.2 Economic Analysis

The Agency conducted a screening analysis to assess the impacts of the proposed rule on small businesses and to compare the impacts on small businesses with impacts on large businesses. These results are shown in Table 5-1. Three of the estimated 56 small businesses in the refractory manufacturing industry are projected to incur costs averaging \$99,700 to comply

⁵For purposes of this analysis, small businesses were defined as having 750 or fewer employees. Some of the companies in the refractory industry produce both clay and nonclay refractories, which does not allow us to assign companies unambiguously to a single NAICS code. For this reason, we selected the higher NAICS criterion, 750 employees, as the small business criterion for all companies. Note that this conservative criterion may overstate the total number of small companies.

with the regulation. The five large companies projected to incur compliance costs experience costs averaging \$403,000 (TACC) per company. Of the 33 small companies with sales data and 17 large companies with sales data, none of these companies is projected to experience costs exceeding 1 percent of baseline sales.

Table 5-1. Summary Statistics for SBREFA Screening Analysis: 1998

	Small		Large		Total	
Total number of companies	56		20		76	
Total annual compliance costs (TACC) (\$/year)	\$299,200		\$2,015,000		\$2,314,200	
Average TACC per company (\$/year) ^a	\$99,700		\$403,000		\$289,000	
	Number	Share	Number	Share	Number	Share
Companies with sales data	33	100%	17	100%	50	100%
Compliance costs <1% of sales	33	100%	17	100%	50	100%
Compliance costs 1% to 3% of sales	0	0%	0	0%	0	0%
Compliance costs are >3% of sales	0	0%	0	0%	0	0%
Compliance cost-to-sales ratios (CSRs)						
Mean	NR		NR		0.018%	
Median	NR		NR		0.000%	
Maximum	NR		NR		0.369%	
Minimum	NR		NR		0.000%	

^aAverage over companies incurring compliance costs.
NR = not reported to avoid revealing confidential data.

The Agency analyzed the economic impacts on small businesses under with-regulation conditions expected to result from implementing the proposed rule. This approach examines small business impacts in light of the expected behavioral responses of producers and consumers to the regulation. As shown in Table 5-2, overall revenue and operating profits for facilities owned by small businesses are projected to decline slightly under the recommended alternative. No small businesses will be significantly affected by the rule. In response to the projected increase in control costs for refractory production, most facilities owned by small businesses are projected to decrease their output slightly. As a result, they experience decreased production costs, and decreased revenues and profits, but essentially no change in employment.

Table 5-2. Small Business Impacts: 1998

	Baseline	With Regulation	Change Absolute	Relative
Total revenue (\$10 ⁶ /yr)	\$482.3	\$482.0	-\$0.3	-0.06%
Total costs (\$10 ⁶ /yr)	\$465.5	\$465.5	\$0.0	0.00%
Control	\$0.0	\$0.3	\$0.3	NA
Production	\$465.5	\$465.2	-\$0.3	-0.06%
Pre-tax earnings (\$10 ⁶ /yr)	\$16.8	\$16.5	-\$0.3	-1.77%
Facilities (#)	71	71	0	0.00%
Employees (FTEs ^a)	3,256	3,255	-1	-0.02%

^a FTEs = full-time equivalent employees.

5.3 Assessment

The proposed refractories NESHAP is only expected to result in increased costs for three small businesses. Because of the imposition of control costs, small companies are projected to decrease their production; revenues and profits are projected to decline slightly. Overall, they are expected to experience minor losses as a result of the proposed rule. No business, either large or small, is projected to incur costs exceeding 1 percent of sales. Thus the rule is not expected to result in significant adverse economic impacts to any small business.

REFERENCES

- Allen, R.G.D. 1938. *Mathematical Analysis for Economists*. New York: St. Martin's Press.
- ASM International. 1987. *Engineered Materials Handbook*. Volume 4: *Ceramics and Glasses*. Metals Park, OH: ASM International.
- Ceramic Industry*. 2000. "U.S. Demand for Refractories to Reach \$2.8 Billion through 2003." *Ceramic Industry*. Available at <http://www.ceramicindustry.com/ci/cda/articleinformation/features/bnp_features_item/0,2710,8359,00.html>.
- Contos, George and Ellen Legel. 2000. Corporation Income Tax Returns, 1997. [Computer File]. Available at <http://www.irs.gov/tax-stats/soi/corp_id.html>. As obtained January 26, 2001.
- DHAN. 1999. "Industry Report: Refractories Passing through Difficult Times." Available at <<http://dhan.com/moneyline/991016-refract.html>>.
- Dun & Bradstreet. 2000. *D&B Million Dollar Directory*. Series 2000. Bethlehem, PA: Dun & Bradstreet, Inc.
- Freedonia Group. September 1999. "Refractories in the United States to 2003." Profound WorldSearch <<http://www.profound.com>>.
- Hicks, J.R. 1961. "Marshall's Third Rule: A Further Comment." *Oxford Economic Papers* 13:262-65.
- Hicks, J.R. 1966. *The Theory of Wages*. 2nd Ed. New York: St. Martin's Press.
- Information Access Co. 2000. *Ward's Business Directory*. Belmont, CA.
- Lawson, A. 1997. "Benchmark Input-Output Accounts for the U.S. Economy, 1992: Requirements Tables." *Survey of Current Business*. December, pages 22-47.
- Levinson, Arik: 1996. "Environmental Regulations and Industry Location: International and Domestic Evidence." In *Fair Trade and Harmonization: Prerequisite for Free Trade?* Jagdish Bhagwal; and Robert Hudec, eds. Washington, DC: MIT Press.
- Marinshaw, R. and J. Fields. February 2003a. Memorandum from RTI, International to Fairchild, S., EPA/ESD. Revised Estimate of Major and Area Sources of HAP Emissions.
- Marinshaw, R. and J. Fields. February 2003b. Memorandum from RTI, International to Fairchild, S., EPA/ESD. Revised Estimated Compliance Costs for the Refractory

Products Manufacturing Industry.

- R.S. Means Company, Inc. 1997, 1998 Building Construction Cost Data. Kingston, MA: R.S. Means Company, Inc.
- Semler, Charles E. 2000. "More about Industry Changes." *Ceramic Industry*. Available at <<http://proquest.umi.com/pdqweb?TS...Sid=1&Idx=21&Deli=1&RQT=309&Dtp=1>>.
- Sheppard, Laural M.. 2000. "Trends in Refractories Technology: Highlights of the AcerS Annual Meeting." Refractories Applications.
- Slade, M.E. 1996. "Uniform Compliance Costs for Mineral Commodities: Who Gains and Who Loses?" *Land Economics* 72(1):17-32.
- The Technical Association of Refractories, Japan. 1998. *Refractories Handbook*. Tokyo: The Technical Association of Refractories, Japan.
- U.S. Bureau of Labor Statistics. 2001. "Producer Price Index." <<http://146.142.4.24/cgi-bin/srga>>.
- U.S. Department of Commerce, Bureau of the Census. 1993–1999. *Current Industrial Reports: Refractories*. MA 32C. Available at <<http://www.census.gov/industry/ma32c97>>.
- U.S. Department of Commerce, Bureau of the Census. 1994a. *1992 Census of Manufactures, Industry Series—Abrasive, Asbestos, and Miscellaneous Mineral Products*. Washington, DC: Government Printing Office.
- U.S. Department of Commerce, Bureau of the Census. 1994b. *1992 Census of Manufactures, Industry Series—Cement and Structural Clay Products*. Washington, DC: Government Printing Office.
- U.S. Department of Commerce, Bureau of the Census. 1995. *1993 Annual Survey of Manufactures*. M93(AS)-1. Washington, DC: Government Printing Office.
- U.S. Department of Commerce, Bureau of the Census. 1996a. *1994 Annual Survey of Manufactures*. M94(AS)-1. Washington, DC: Government Printing Office.
- U.S. Department of Commerce, Bureau of the Census. 1996b. *Concentration Ratios in Manufacturing*. MC92-S-2. Washington, DC: Government Printing Office. Available at <<http://www.census.gov/mcd/mancen/download/mc92cr.sum>>.
- U.S. Department of Commerce, Bureau of the Census. 1997. *1995 Annual Survey of Manufactures*. M95(AS)-1. Washington, DC: Government Printing Office.
- U.S. Department of Commerce, Bureau of the Census. 1998. *1996 Annual Survey of Manufactures*. M96(AS)-1. Washington, DC: Government Printing Office.
- U.S. Department of Commerce, Bureau of the Census. 1999a. *1997 Census of Manufactures*. Washington, DC: Government Printing Office.

- U.S. Department of Commerce, Bureau of the Census. 1999b. *1997 Census of Manufactures, Industry Series—Manufacturing: Clay Refractory Manufacturing*. Washington, DC: Government Printing Office.
- U.S. Department of Commerce, Bureau of the Census. 1999c. *1997 Census of Manufactures, Industry Series—Manufacturing: Nonclay Refractory Manufacturing*. Washington, DC: Government Printing Office.
- U.S. Department of Commerce, Bureau of the Census. 1999d. *1998 Survey of Plant Capacity*. Washington, DC: Government Printing Office.
- U.S. Department of Commerce, Bureau of the Census. 2000. *1998 Annual Survey of Manufactures*. M98(AS)-1. Washington, DC: Government Printing Office.
- U.S. Department of Commerce, and International Trade Administration. 1999. *U.S. Industry & Trade Outlook 2000*. New York: The McGraw-Hill Companies and U.S. Department of Commerce.
- U.S. Environmental Protection Agency (EPA). 1994. *AP-42, Fifth Edition, Volume I, Chapter 11: Mineral Products Industry*. Washington, DC: Government Printing Office. Available at <<http://www.epa.gov/ttn/chief/ap42/ch11>>.
- U.S. Environmental Protection Agency (EPA). 2001. Refractories Industry Database.
- U.S. Department of Justice and the Federal Trade Commission. Horizontal Merger Guidelines. April 8, 1992. <<http://www.ftc.gov/bc/docs/horizmer.htm>>.
- U.S. International Trade Commission (USITC). 1993. *Industry & Trade Summary: Refractory Ceramic Products*. USITC Publication 2692. Washington, DC: U.S. International Trade Commission.
- U.S. International Trade Commission (USITC). 1994. *Industry & Trade Summary: Refractory Ceramic Products*. USITC Publication 2692. Washington, DC: U.S. International Trade Commission.
- U.S. International Trade Commission. 2001. Trade Database. <<http://dataweb.usitc.gov/scripts/>>.
- U.S. Small Business Administration. 1998. “Small Business Size Regulations: Size Standards and the North American Industry Classification System.” 13 CFR Part 121.
- Virta, Robert L. 1998. *Minerals Information: Clay and Shale*. Reston, VA: U.S. Department of the Interior, U.S. Geological Survey. Available at <<http://minerals.usgs.gov/minerals/pubs/commodity/clays>>.

APPENDIX A

OVERVIEW OF REFRACTORIES MARKET MODEL

To develop estimates of the economic impacts on society resulting from the refractory product NESHAP, the Agency developed a computational model using a framework that is consistent with economic analyses performed for other rules. This approach employs standard microeconomic concepts to model behavioral responses expected to occur with the regulation. This appendix describes the spreadsheet model in detail and discusses how the Agency

- C characterized the supply and demand of three refractory commodities—bricks and shapes, monolithics, and RCFs;
- C introduced a policy “shock” into the model by using control cost-induced shifts in the supply functions of affected producers; and
- C used a solution algorithm to determine a new with-regulation equilibrium in each refractory market.

A.1 Baseline Data Set

Much of the data used in modeling the refractory industry come from the EPA Refractory Industry Database, which contains confidential survey responses from potentially affected facilities. Among the critical data included in this database are product-specific output. Table A-1 lists additional plant and company data elements and their sources. Table A-2 shows prices of refractory products obtained from Freedonia Group. Although “other” refractory forms include not only RCF but refractories that are shipped in bulk, EPA used this price for RCF.

A.2 Supply and Demand Elasticities

Unfortunately, empirical estimates of demand or supply elasticities for refractory products are limited. The option of estimating a system of demand and supply equations using three-stage least squares (3SLS) was not feasible because of limitations of time-series data. Although these limitations prevent estimation of these parameters, knowledge about the

Table A-1. Types and Sources of Refractory and Processing Facility Data

Data Category	Data Element	Data Source
Plant data	Plant name	EPA Refractory Industry Database
	Plant location	EPA Refractory Industry Database
	Plant ownership	EPA Refractory Industry Database
	Types of refractory products produced	EPA Refractory Industry Database
	Employment	EPA Estimate
	Quantity produced of each refractory product	EPA Refractory Industry Database
Company data	Company name	Ward's Business Directory
	Company sales	Ward's Business Directory
	Employment	Ward's Business Directory
Market data	Prices	Freedonia Group

Sources: Freedonia Group. September 1999. "Refractories in the United States to 2003." Profound WorldSearch <<http://www.profound.com>>. Information Access Co. 2000. Ward's Business Directory. Belmont, CA
U.S. Environmental Protection Agency (EPA). 2001b. Refractory Industry Database.

factors influencing the elasticity of derived demand makes it possible to develop informed assumptions about producer and consumer responses to price changes. Economic theory states that the elasticity of the derived demand for an input is a function of the following (Hicks, 1961; Hicks, 1966; and Allen, 1938):

- C demand elasticity for the final good it will be used to produce,
- C the cost share of the input in total production cost,
- C the elasticity of substitution between this input and other inputs in production, and
- C the elasticity of supply of other inputs.

Using Hicks' formula,

Table A-2. Refractory Products Pricing (\$/ton)

Form	1989\$	1998\$	1993\$	1998\$	1998\$
Monolithics	451	526	491	544	533
Bricks and Shapes	709	826	782	866	910
Other ^a	394	459	442	490	497

^a Other refractory forms consist of ceramic fibers and refractory raw materials that are supplied in lump or ground form used to manufacture refractories “in-house.”

Note: Prices were inflated using the producer price index for stone, clay, glass, and concrete products available through the Bureau of Labor Statistics at <<http://146.142.4.24/cgi-bin/srgate>>.

Source: Freedonia Group. September 1999. “Refractories in the United States to 2003.” Profound WorldSearch <<http://www.profound.com>>.

$$\eta_i = \frac{[s(n+e) + Ke(n-s)]}{[n+e - K(n-s)]} \quad (\text{A.1})$$

where

O_i = elasticity of demand for the refractory product i ,

s = elasticity of substitution between refractory product i and all other inputs to steel production,

n = elasticity of demand for final product (steel products),

e = elasticity of supply of other inputs, and

K = cost share of refractory product i in total production cost.

In the appendix to *The Theory of Wages*, Hicks (1966) shows that, if $n > s$, the demand for the input is less elastic the smaller its cost share. If the data were available, this formula could be used to actually compute the elasticity of demand for each refractory product. The final products for which the refractory is an input include iron and steel products, other nonferrous metal products, and cement. The iron and steel industry dominates the demand for refractory products, perhaps constituting as much as 75 percent of total refractory consumption. For this reason, EPA concentrated on the elasticity of demand for refractories in steelmaking. For the analysis of the Integrated Iron and Steel NESHAP, the Agency estimated the elasticity of demand for iron and steel products to be -0.59 . Values in the literature have been in the same range, both for ferrous (-0.7) and nonferrous (-0.6) metals (Slade, 1996). Lacking estimates of other elasticities of final demand and of the other parameters in the formula makes direct computation of the elasticity of demand, O , impossible. In spite of this, the formula is useful because it identifies factors that influence the magnitude of the elasticity of derived demand.

Knowledge of the general magnitude of those factors makes it possible to make an educated assumption about the magnitude of O.

The elasticity of substitution, s, between refractory products and other inputs is likely to be very low but nonzero. Although there are no substitutes for refractories in the short run, over time, capital equipment has been substituted for refractories as technology has evolved requiring less use of refractories per ton of steel. We thus expect that $n > s$. This implies that the magnitude of O is proportional to the magnitude of K, the cost share of refractories in overall building construction. Based on the benchmark input–output accounts for the United States, stone and clay products (including refractories) are 1.5 percent of primary iron and steel manufacturing and 0.02 percent of primary nonferrous metals manufacturing (Lawson, 1997).

Given that the cost share of stone and clay products in the total production cost of ferrous and nonferrous primary metal manufacturing is small, the elasticity of demand for one of the final products (steel mill products) is relatively low and ease of substitution between inputs very limited, the elasticity of demand for refractory products would be inelastic (i.e., less than 1 in absolute value). In fact, we suspect it may be substantially lower. Assuming the elasticity of supply of other inputs is 1, and the elasticity of substitution between refractory and other inputs is 0.1, the elasticity of demand for refractories would be approximately 0.1 in absolute value.

A.3 Operational Model

The Agency developed an operational model of the refractories industry using spreadsheet software. This model characterizes market supply and demand, allows the analyst to introduce a policy “shock” into the model by using control cost-induced shifts in the supply functions of affected producers, and uses a solution algorithm to determine a new with-regulation equilibrium for each refractory market. This section describes the computer model in detail.

A.3.1 Market Supply

Domestic supply for product i can be expressed as

where

$$Q^{s^i} = \sum_{j=1}^n q_{(j)}^{s^i} \tag{A.2}$$

$q_{(j)}^{s^i}$ = product i supply from domestic plant (j) and

n = the number of domestic suppliers producing commodity i.

A.3.1.1 Product Line Supply

EPA used a simple Cobb-Douglas (CD) supply function for each facility product line

expressed as follows:

$$q_{(j)}^{s_i} = A_i \cdot (P_i)^{\varepsilon^{s_i}} \quad (\text{A.3})$$

where

$q_{(j)}^{s_i}$ = the supply of product i for domestic plant (j),

A_i = a parameter that calibrates the supply equation to replicate the estimated 1998 level of production,

P_i = the 1998 market price for product i, and

ε^{s_i} = the domestic supply elasticity.

Regulatory Induced Shifts in the Supply Function (c_j). The upward shift in the supply function [of domestic facilities] (c_j) is calculated by dividing the total annual compliance cost estimate by baseline output. Computing the supply shift in this manner treats the compliance costs as the conceptual equivalent of a unit tax on domestic output.

$$q_{(j)}^{S_i} = A_i \cdot (P_i - c_j)^{e_{S_i}} \quad (\text{A.3})$$

International Trade. In response to public comment, EPA analyzed economic impacts in the bricks and shapes market using a full cost absorption approach. To implement this approach, EPA's model assumes that foreign suppliers of bricks and shapes increase their supply to offset any decreases in output by affected domestic suppliers. Thus, the model projects no change in the market price or quantity of bricks and shapes due to the regulation.

Plant Closure Analysis. One of the most sensitive issues to consider in the EIA is the possibility that the regulation may induce a producer to shut down operations rather than comply with the regulation. The data (i.e., direct observations of plant-level costs and profits) necessary to make definitive projections of these impacts are unavailable from the survey data. Therefore, EPA developed a crude method of identifying plant closure decisions using firm-specific or broad industry measures of profitability as described below.

The plant closure criterion used for this analysis is defined as follows:

$$\pi_j = TR_j - TC_j \leq 0 \quad (\text{A.4})$$

where total revenue (TR_j) is the sum of the product revenue from plant j 's product lines, and total cost (TC_j) is the sum of the plant's total variable production costs, total avoidable fixed production costs, and total control costs. The conceptually correct view would assume the plant also has some positive liquidation value or opportunity value in an alternative use that is not captured in the TC elements used to compute B_j . However, no data are available to estimate these opportunity costs. Therefore, the Agency has assumed they are exactly offset by the costs of closing a plant (i.e., equal to zero).

Given the estimated 1998 values of revenue and variable production costs implied by the calibrated product line supply functions, the Agency developed an estimate of the total avoidable fixed costs so that the profit ratio for each plant exactly matches either the parent company's profit margin or an industry profit ratio reported by the U.S. Internal Revenue Service (Contos and Legal, 2000).

A.3.2 Market Demand

Domestic demand is expressed as follows:

$$q^{D_i} = B_i \cdot P_i^{\eta^{D_i}} \quad (\text{A.5})$$

where

q^{D_i} = domestic demand for product i ,

B_i = a parameter that calibrates the demand equation to replicate the 1998 level of domestic demand,

P_i = the 1998 market price for product i , and

η^{D_i} = the domestic demand elasticity for product i .

A.3.3 With-Regulation Market Equilibrium Determination

Producer responses and market adjustments can be typically be conceptualized as an interactive feedback process. Plants facing increased production costs due to compliance are willing to supply smaller quantities at the baseline price. Typically, market supply would fall, price would rise, and suppliers would recompute their desired supply at the new price; this process would continue until both demanders and suppliers are satisfied at a given price. In the case of the refractories market, however, EPA is modeling foreign supply as perfectly elastic, so that it compensates for any reduction in domestic supply and no changes in price or market quantity result.

The algorithm for determining with-regulation equilibria can be summarized as:

1. Impose the control costs on all affected plants, thereby affecting their supply decisions.
2. Recalculate the market supply in each product market.
3. Compute change in imports to offset reduction in domestic supply.

In the affected bricks and shapes market, because foreign supply is assumed to be perfectly elastic, the market achieves equilibrium immediately as increased foreign supply exactly offsets decreased domestic supply.

APPENDIX B

ECONOMIC WELFARE IMPACTS ON REFRACTORY INDUSTRY

The economic welfare implications of the market price and output changes with the regulation can be examined using two different strategies, each giving a somewhat different insight but the same implications: changes in the net benefits of consumers and producers based on price and quantity changes and changes in the total benefits and costs of these products based on the quantity changes. This analysis focuses on the first measure—the changes in the net benefits of consumers and producers. Figures B-1 and B-2 depict the change in economic welfare by first measuring the change in consumer surplus and then the change in producer surplus. In essence, the demand and supply curves previously used as predictive devices are now being used as valuation tools.

This method of estimating the change in economic welfare with the regulation divides society into consumers and producers. In a market environment, consumers and producers of the good or service derive welfare from a market transaction. The difference between the maximum price consumers are willing to pay for a good and the price they actually pay is referred to as “consumer surplus.” Consumer surplus is measured as the area under the demand curve and above the price of the product. Similarly, the difference between the minimum price producers are willing to accept for a good and the price they actually receive is referred to as “producer surplus” or profits. Producer surplus is measured as the area above the supply curve and below the price of the product. These areas can be thought of as consumers’ net benefits of consumption and producers’ net benefits of production, respectively.

In Figure B-1, baseline equilibrium occurs at the intersection of the demand curve, D^M , and the supply curve, S^M . Price is P_1 with quantity Q_1 . The regulatory costs will cause the market supply curve for affected facilities (S_{a1}) to shift upwards to (S_{a2}). Indirectly affected firms will expand production along their supply curve by an amount equivalent to the reduction in supply from affected firms. The new equilibrium price of bricks and shapes refractories is P_2 , the same price that existed prior to the regulation. As shown in Figure B-1a, because market price and quantity do not change, there is no change in consumer welfare.

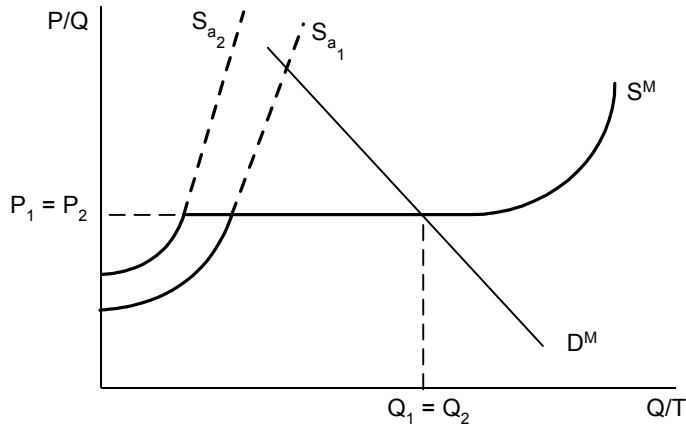

(a) Change in Consumer Surplus with Regulation

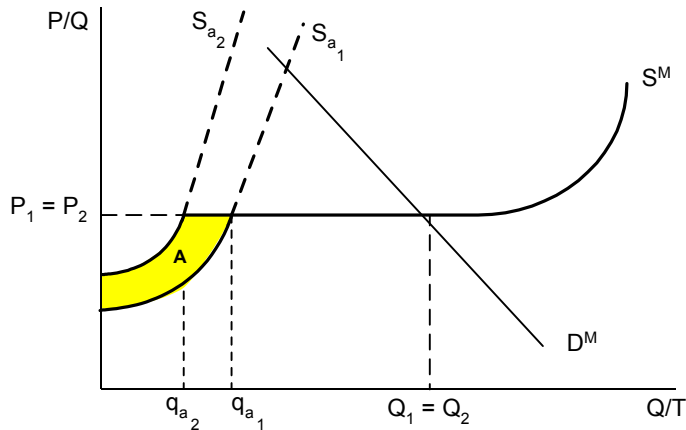

(b) Change in Producer Surplus with Regulation

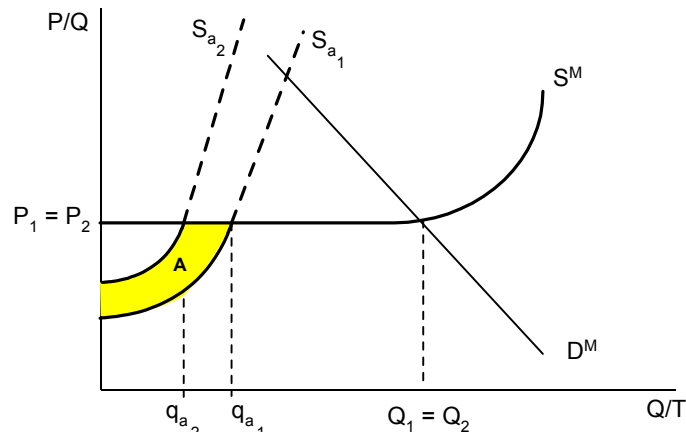

(c) Net Change in Economic Welfare with Regulation

Figure B-1. Economic Welfare Changes with Regulation (Bricks and Shapes): Consumer and Producer Surplus

Producer welfare does change as a result of the regulation. Affected facilities are assumed to be unable to pass the regulatory costs they incur on to consumers in the form of higher prices. Thus, these facilities will restrict output to the level that maintains the original market price, P_1 . In Figure B-1(b), area A represents the loss in producer surplus that the affected firms experience. It is the difference in the area under the supply curve up to the original market price. Indirectly affected facilities expand output to meet demand. However, since their supply curve is highly elastic, these firms do not experience any gain in producer surplus. Thus, the only change in producer welfare is represented by area A.

The change in economic welfare attributable to the compliance costs of the regulation is the sum of consumer and producer surplus changes. Under the assumption that bricks and shapes producers are unable to raise prices, the impacts are restricted to producers. The loss of area B represented the net (negative) change in economic welfare associated with the regulation. However, this analysis does not include the benefits that occur outside the market (i.e., the value of the reduced levels of air pollution with the regulation). Including this benefit may reduce the net cost of the regulation or even make it positive.

TECHNICAL REPORT DATA

(Please read Instructions on reverse before completing)

1. REPORT NO. EPA-452/R-03-004		2.	3. RECIPIENT'S ACCESSION NO.
4. TITLE AND SUBTITLE Economic Impact Analysis of the Refractory Product Manufacturing NESHAP - Final Rule		5. REPORT DATE February 2003	
		6. PERFORMING ORGANIZATION CODE	
7. AUTHOR(S) Lisa Conner, Innovative Strategies and Economics Group		8. PERFORMING ORGANIZATION REPORT NO.	
9. PERFORMING ORGANIZATION NAME AND ADDRESS U.S. Environmental Protection Agency Office of Air Quality Planning and Standards Air Quality Strategies and Standards Division Research Triangle Park, NC 27711		10. PROGRAM ELEMENT NO.	
		11. CONTRACT/GRANT NO.	
12. SPONSORING AGENCY NAME AND ADDRESS Steve Page, Director Office of Air Quality Planning and Standards Office of Air and Radiation U.S. Environmental Protection Agency Research Triangle Park, NC 27711		13. TYPE OF REPORT AND PERIOD COVERED	
		14. SPONSORING AGENCY CODE EPA/200/04	
15. SUPPLEMENTARY NOTES			
16. ABSTRACT This report presents a technical analysis of the economic impacts associated with the National Emissions Standard for Hazardous Air Pollutants to control emissions of air toxic pollutants from Refractory Product Manufacturing. The analysis evaluates adjustments in the refractory products market (through price and production changes), social cost, and the resulting affects on employment, international trade, and small businesses.			
17. KEY WORDS AND DOCUMENT ANALYSIS			
a. DESCRIPTORS	b. IDENTIFIERS/OPEN ENDED TERMS	c. COSATI Field/Group	
Economic Impact Analysis (EIA) Regulatory Flexibility Analysis (RFA)	Air Pollution control economic analysis small business analysis		
18. DISTRIBUTION STATEMENT Release Unlimited	19. SECURITY CLASS (<i>Report</i>) Unclassified	21. NO. OF PAGES	
	20. SECURITY CLASS (<i>Page</i>) Unclassified	22. PRICE	

United States
Environmental Protection
Agency

Office of Air Quality Planning and Standards
Air Quality Strategies and Standards Division
Research Triangle Park, NC

Publication No. EPA 452/R-03-004
February 2003
