



## **Edelbrock E-Force Supercharger**

**2016-2018 MAZDA MIATA MX-5 2.0L**

**Part #1554 and 15540**





## **WARNING!**

*The supercharger bypass valve is factory installed and adjusted intended for vacuum operation only. DO NOT move the solenoid actuator lever by hand or adjust the stop point. Moving the lever manually will damage the solenoid and the system will not function properly. Damage to the bypass assembly from manual movement will not be covered under manufacture warranty.*





## Edelbrock E-Force Supercharger System 2016-17 Miata MX-5 2.0L

### Installation Instructions

#### INTRODUCTION

Thank you for purchasing the Edelbrock Supercharger System for the Mazda Miata MX-5 with 2.0L Skyactiv Engine. This side mounted supercharger system features Eaton's TVS-900 rotor group and installs neatly under the stock hood with no permanent modifications to the body of the vehicle. The unique intake manifold houses an integrated intercooler for low IATs under boost. PN 1554 is 50-State emissions legal (pending), and includes a 3-year 36,000 mile warranty if applicable.

#### TOOLS AND SUPPLIES REQUIRED

- Jack and Jack Stands or Service Lift
- 50/50 Coolant Mixture: ~1.5 Gallons
- Ratchet and Socket Set including but not limited to:
  - 1/4 Drive: 8mm, 10mm and Universal Joint
  - 3/8 Drive: 8mm, 10mm, 12mm, 14mm, 17mm
- Wrench Set including but not limited to: 8mm, 10mm, 12mm, 14mm, 17mm
- Fuel Line Removal Tool
- Panel Puller
- Utility Knife
- Spill-Free Funnel
- Flat Head & Phillips Screwdrivers
- Side Cutters
- Torque Wrench
- Pliers or Hose Clamp Removal Tool
- Blue Thread Locker - *(It is generally recommended to apply BLUE thread locker, unless specified, onto the threads of all bolts prior to installing.)*
- Silicone O-ring Lube
- Masking Tape
- Shop Rags
- Zip Ties/Electrical Tape

#### IMPORTANT CALIBRATION DETAIL

**1554 calibration can only support United States Domestic Market (USDM) ECU versions at this time. Non USDM ECU version customers will need to purchase PN 15540 (no tuner kit) and source their own custom calibration.**

#### IMPORTANT WARNINGS

***Before beginning the installation, use the enclosed checklist to verify that all components are present in the box then inspect each component for damage that may have occurred in transit. If any parts are missing or damaged, contact Edelbrock Technical Support (800-416-8628), not your parts distributor.***

Due to the complexity of the Edelbrock E-Force Supercharging system, it is recommended that this system only be installed by a qualified professional with access to a service lift, pneumatic tools, and a strong familiarity with automotive service procedures. To qualify for the Powertrain Warranty, the E-Force supercharger system must be installed by a Certified ASE Technician at a licensed business, Mazda Dealership, or an Authorized Edelbrock E-Force installer. Failure to do so will void and/or disqualify any and all warranties offered with this system. Please contact the Edelbrock Technical Support department if you have any questions regarding this system and/or how your installer of choice will affect any warranty coverage for which your vehicle may qualify.



**Edelbrock E-Force Supercharger System  
2016-17 Miata MX-5 2.0L  
Installation Instructions**

**IMPORTANT WARNINGS CONT'D**

***Proper installation is the responsibility of the installer. Improper installation will void all manufacture's warranties and may result in poor performance and engine or vehicle damage.***

***Inspect all components for damage that may have occurred in transit before beginning installation. If any parts are missing or damaged, contact Edelbrock Technical Support, not your parts distributor.***

***Any previously installed aftermarket tuning equipment must be removed and the vehicle returned to an as stock condition before installing the supercharger.***

Any equipment that directly modifies the fuel mixture or ignition timing of the engine can cause severe engine damage if used in conjunction with the Edelbrock E-Force Supercharger System. This includes, but is not limited to: OBDII programmers, aftermarket MAF sensors, adapters and any other device that modifies signals to and/or from the ECU. Aftermarket bolt-on equipment such as underdrive pulleys or air intake kits will also conflict with the operation of the supercharger and must be removed prior to installation. Use of any of these products with the E-Force Supercharger could result in severe engine damage.



**91 octane or higher gasoline is required at all times. If your vehicle has been filled with lower octane fuel, it must be run until almost dry and refilled with 91 or higher octane gasoline twice prior to installation.**

**Any failures associated with not using premium 91 octane gasoline or higher, will be ineligible for warranty repairs.**



**WARNING:** *Installation of this supercharger will result in a significant change to the performance characteristics of your vehicle. It is highly recommended that you take some time to familiarize yourself with the added power, and how it is delivered. This must be done in a controlled environment. Take extra care on wet and slippery roads as the rear tires will be more likely to lose traction with the added power. It is never recommended to turn off your vehicles traction control system.*

**It is recommended that you check the Edelbrock Tech Center Website for any updates to this installation manual. Please refer to the lower right hand corner to verify that you have the latest revision of this installation manual before beginning the installation.**

***Tech Center: [http://www.edelbrock.com/automotive\\_new/misc/tech\\_center/install/index.php](http://www.edelbrock.com/automotive_new/misc/tech_center/install/index.php)***

**Edelbrock Authorized Installer Disclaimer**

*Authorized installers of Edelbrock products are independent companies over which Edelbrock has no right of control. Edelbrock LLC makes no claims regarding the abilities, expertise or competency of individual employees of any authorized installer. Each authorized installer is an independent company and makes its own independent judgments. Edelbrock LLC specifically disclaims any responsibility to any party including third parties for the actions, or the failure to act, of individuals, agents or a company authorized in the installation of Edelbrock LLC products.*

### INSTALLATION HARDWARE IDENTIFICATION GUIDE

(Parts Are Not To Scale)

BAG #1 - FEAD HARDWARE				
Item	P/N	QTY.	Description	Torque Spec
1	36-0192	1	M8 x 120mm Hex Head Bolt	18 lb/ft
2	36-4011	1	M8 x 25mm Hex Head Bolt	18 lb/ft
3	36-3813	1	M8 x 25mm Socket Head Bolt	18 lb/ft
4	12-3213	1	M8 Washer	N/A

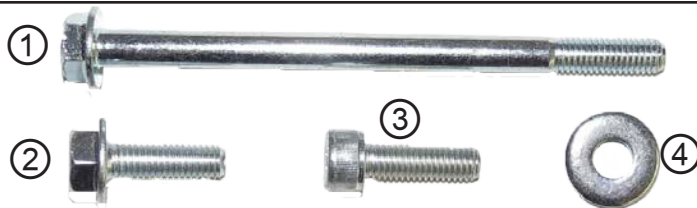

BAG #2 - INTERCOOLER HARDWARE				
Item	P/N	QTY.	Description	Torque Spec
1	36-1507	4	M6 x 16mm Hex Head Bolt	N/A
2	36-1552	2	M6 x 10mm Hex Head Bolt	N/A
3	46-2155	12	3/4" Hose Clamp	N/A
4	46-2157	4	5/8" Hose Clamp	N/A
5	51-4601	2	Straight Connector	N/A
6	60-9399	2	M8 x 1.25 Nyloc Nut	N/A



BAG #3 - MANIFOLD/RUNNER HARDWARE & FUEL FITTING				
Item	P/N	QTY.	Description	Torque Spec
1	36-4016	2	M8 x 90mm Hex Head Bolt	12 lb/ft
2	36-1570	2	M8 x 55mm Hex Head Bolt	12 lb/ft
3	36-0041	3	M8 x 25mm Socket Head Bolt	16 lb/ft
4	36-1502	2	M8 x 12mm Hex Head Bolt	12 lb/ft
5	36-4011	5	M8 x 25mm Hex Head Bolt	16 lb/ft
6	36-4018	1	M8 x 20mm Hex Head Bolt	N/A
7	87-0000	1	M10 x 16mm Hex Head Bolt	N/A
8	72-0010	1	Throttle Body O-ring	N/A
9	64-1119	1	Firewall Plug	N/A

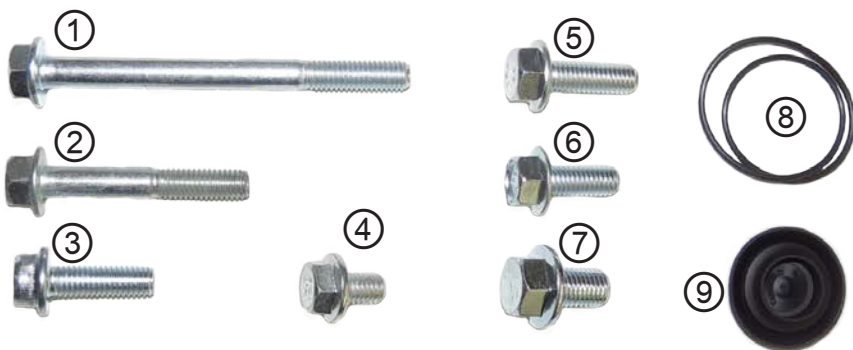

**BRACKET IDENTIFICATION GUIDE**

*(Parts Are Not To Scale)*

BRACKETS			
Item	P/N	QTY.	Description
1	38-1611	1	LTR Bracket, LH
2	38-1612	1	LTR Bracket, RH
3	38-0194	1	Surge Tank Bracket
4	38-0195	1	Water Pump Bracket
5	38-1613	1	LTR Support Bracket
6	24-15544	1	FEAD Bracket
7	38-0196	1	Engine Harness Support
8	38-0193	1	Supercharger Support
9	38-1552	1	EVAP Bracket
10	38-1551	1	Trans Cooler Hose Bracket

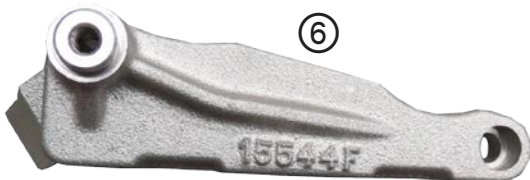



### HOSE IDENTIFICATION GUIDE

(Parts Are Not To Scale)

INTERCOOLER/LTR HOSES			
Item	P/N	QTY.	Description
1	56-1618	1	"IC" CAC to Surge Tank Sec. A
2	56-1622	1	"IC2" CAC to LTR Section B
3	56-1623	1	CAC to Surge Tank Section B
4	56-1616	1	Water Pump to LTR
5	56-1617	1	CAC to LTR Section A
6	56-1615	1	Surge Tank to Water Pump

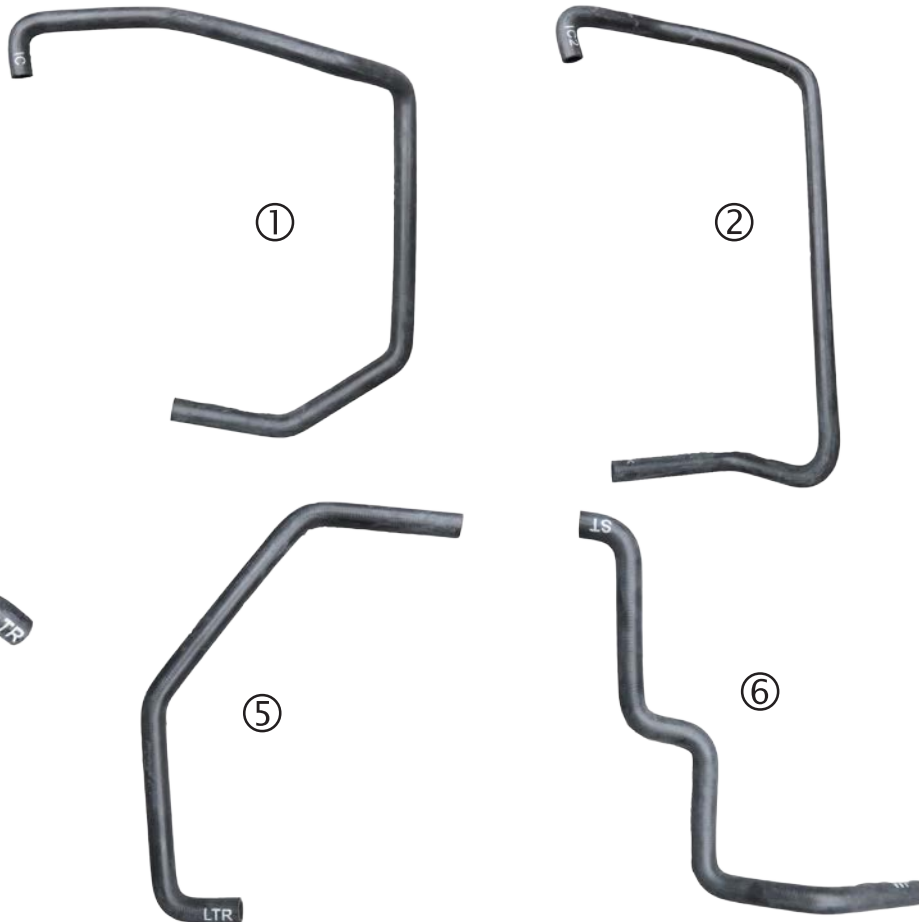

VACUUM / THROTTLE BODY / FUEL			
Item	P/N	QTY.	Description
1	51-7147	1	Air Inlet Tube
2	22-1553	1	Valve Cover Breather Hose
3	88-99026	1	Fuel Input Line
4	56-1000	3'	Brake Booster Hose (Not Shown)
5	56-1601	2'	S/C to EVAP Hose (Not Shown)
6	56-1601	1.3'	Crank Case Breather Hose (Not Shown)



**HOSE ROUTING DIAGRAM**

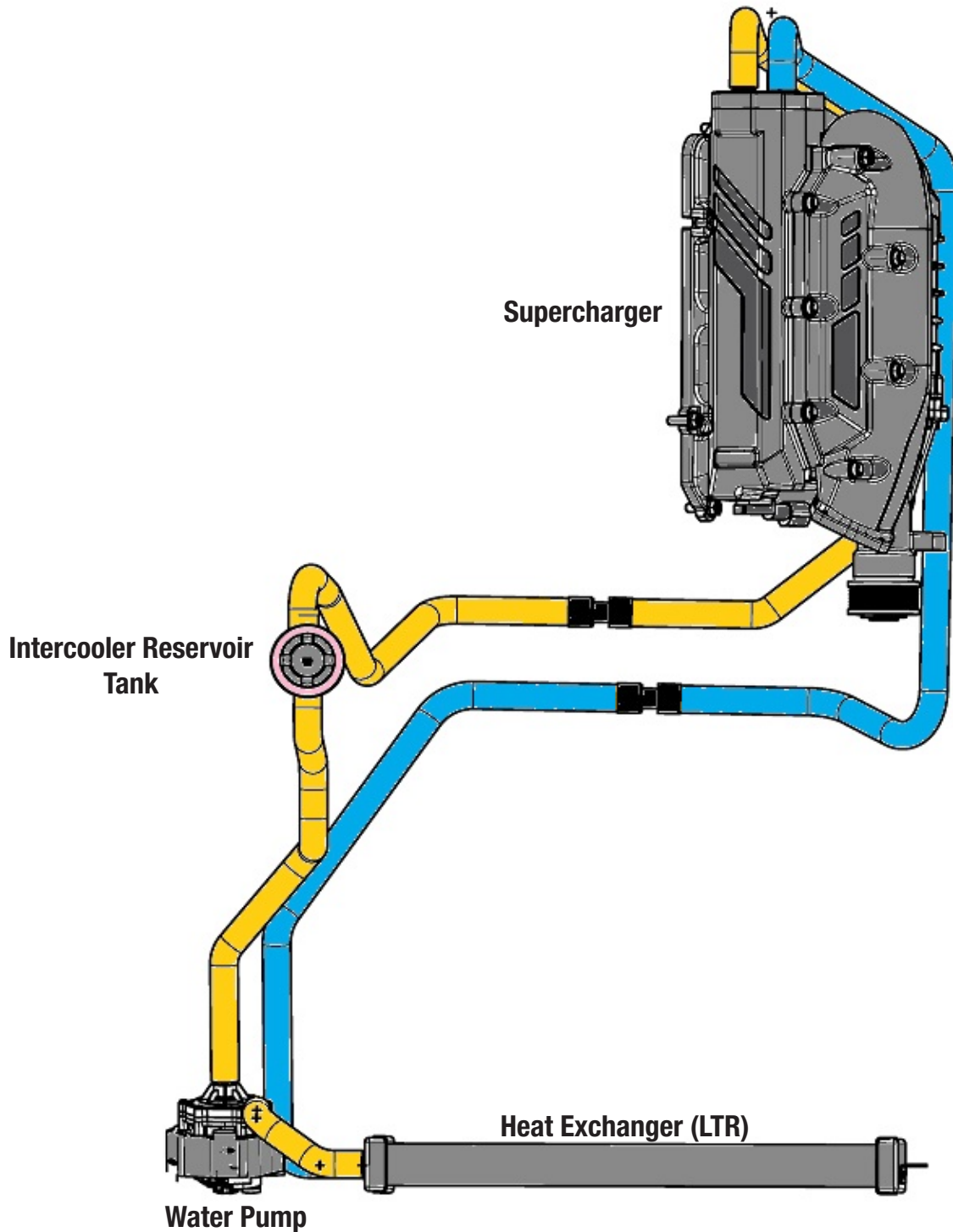

#### WIRE HARNESS GUIDE

(Parts Are Not To Scale)

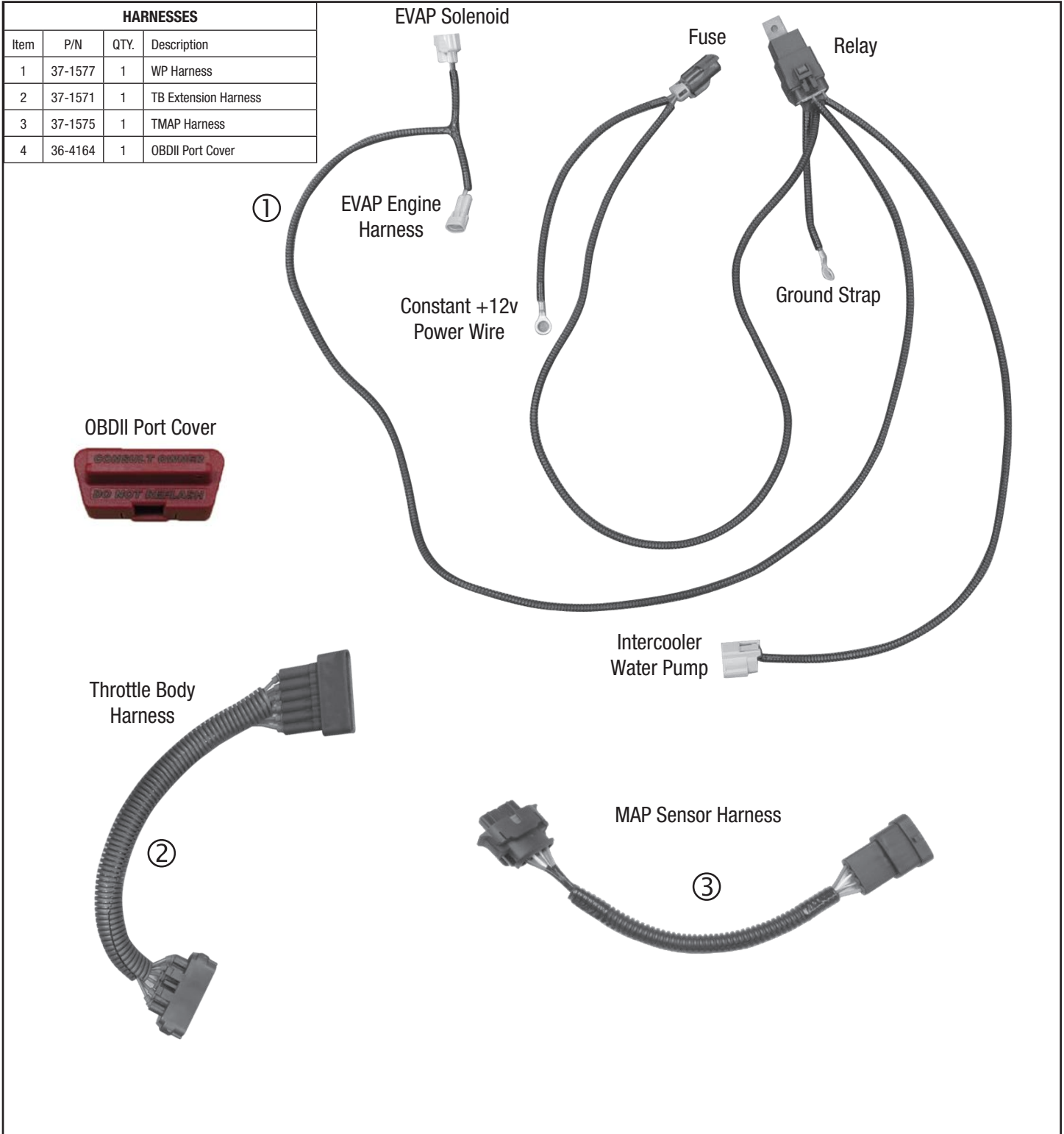

### WIRE HARNESS PINOUT GUIDE (For Maintenance Use Only)

#### Water Pump Harness

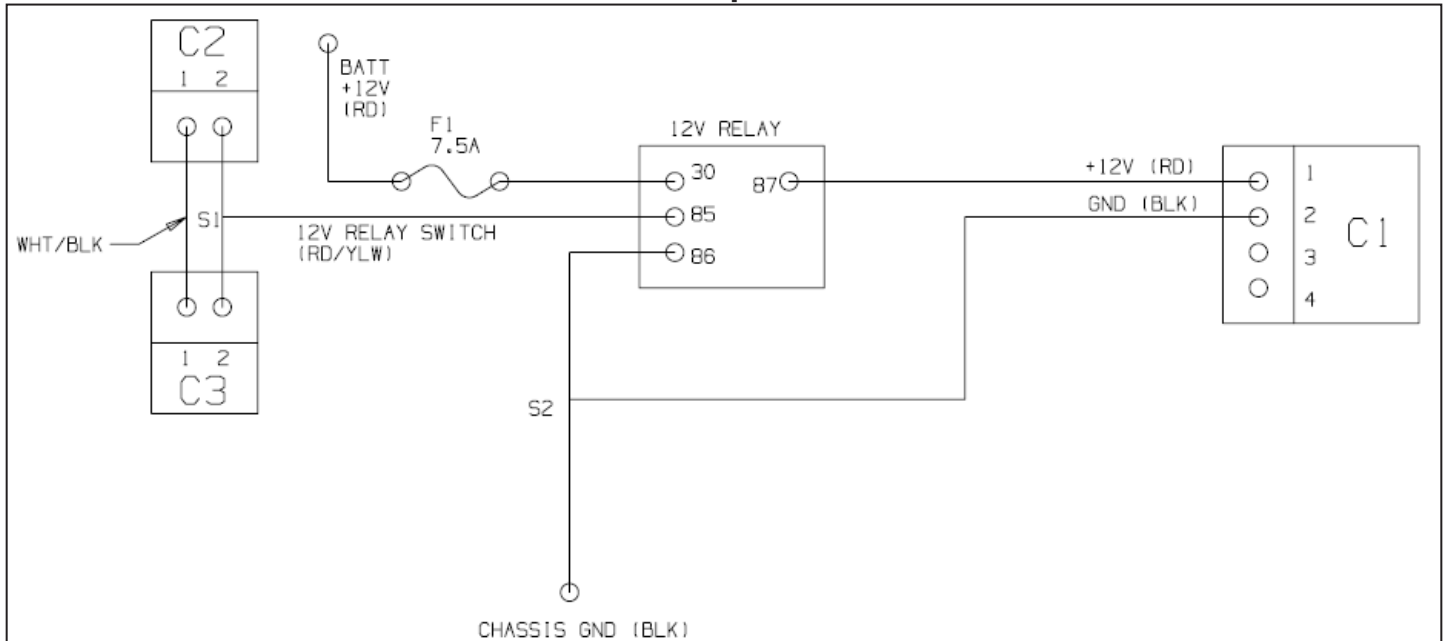

#### Throttle Body Harness

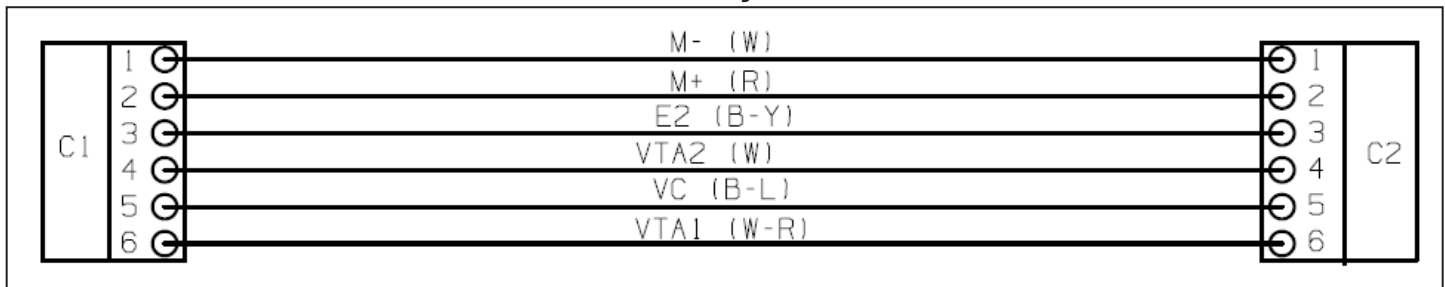

#### TMAP Harness

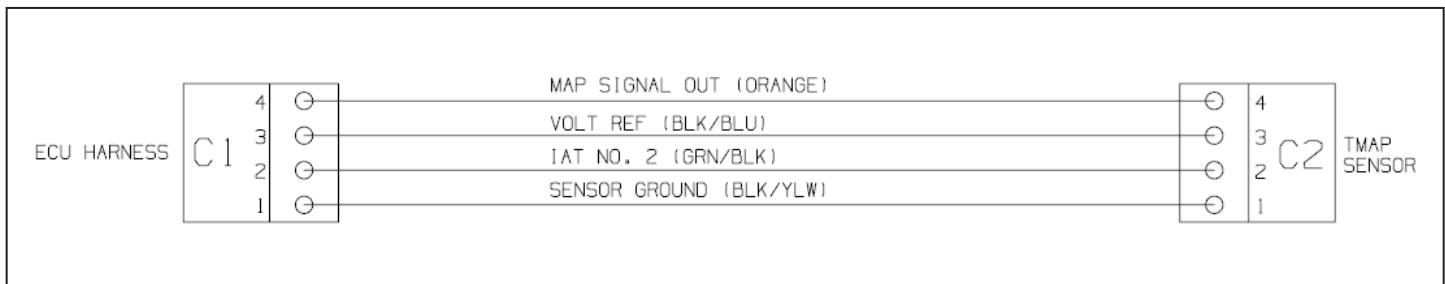

### Installation Instructions

#### PRE SUPERCHARGER INSTALLATION

**IMPORTANT NOTE:** Edelbrock *ONLY* supports US vehicle calibrations. If you own a non-US vehicle, custom tuning for this supercharger kit is required.

Before starting the supercharger installation, it's highly recommended to remove any fuel pressure present within the fuel lines.

To do so, remove the Fuel Pump fuse from the fuse box and start the engine. Let the engine idle until it stalls.

**NOTE:** If the engine is cold, there may not be enough fuel pressure present to start the engine. If this is the case, continue with the removal of the fuel pump fuse regardless.



#### REFLASHING THE ECU

**NOTE:** To prevent vehicle downtime, it is highly recommended to verify that your vehicles' ECU is supported by the EcuTek components included with your E-Force supercharger system (complete systems only). Prior to starting the supercharger installation, download and install the free EcuTek software to a laptop computer (recommended).

1. Download the EcuTek application at [www.ecutek.com/downloads](http://www.ecutek.com/downloads).

2. Select "EcuTek App Downloader" and save the installer file to your computer.

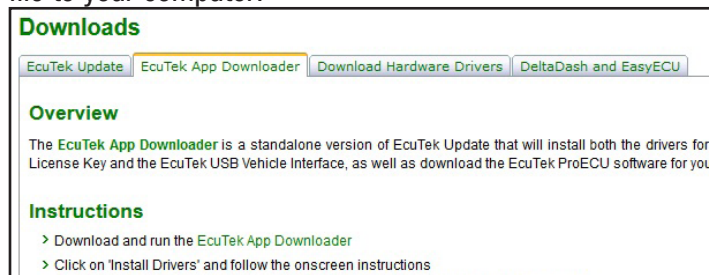

3. Open the installer file to run the application. Select Next to continue.

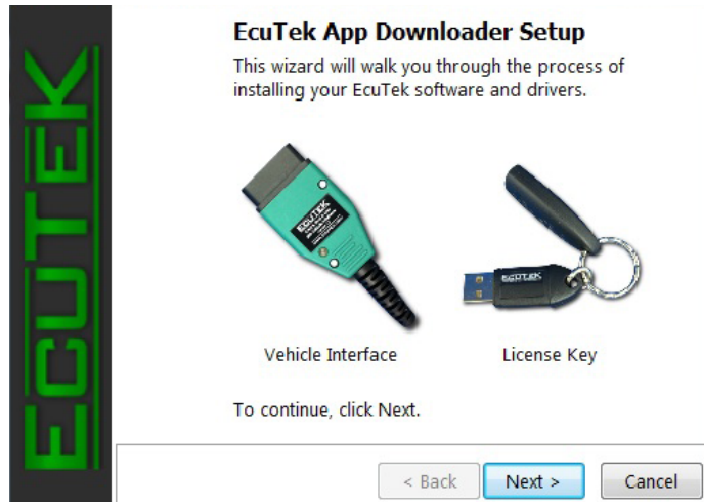

4. You will be prompted to install the necessary EcuTek software and drivers. It is also recommended to install Adobe Reader if you currently do not have it installed. Select Next to continue.

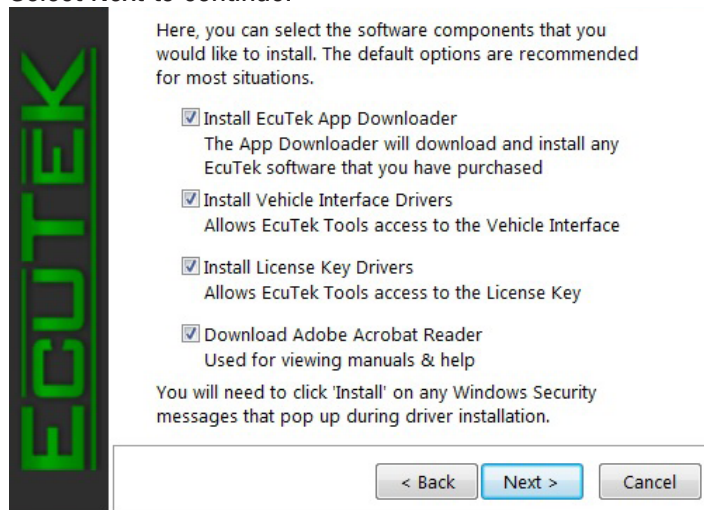

5. Agree with the Windows security warnings if they appear and select Install to continue.

**Installation Instructions**

6. Plug the vehicle interface cable into the laptop when prompted to do so. Select Next to continue.



7. Insert the license key and select Next to continue.

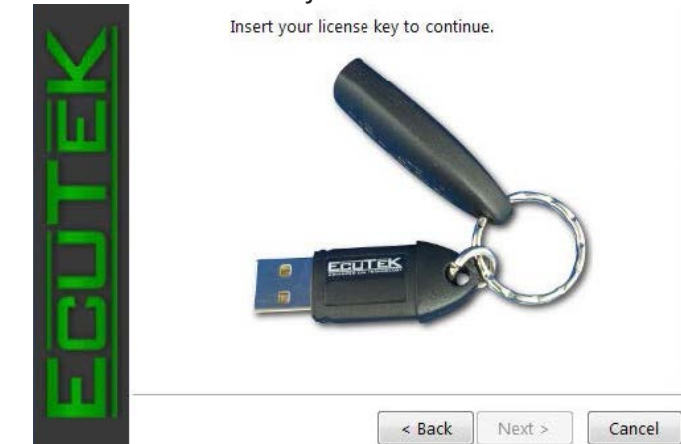

8. Installation is now complete. Verify Run ECUTek APP Downloader is checked and select Finish to complete the process.

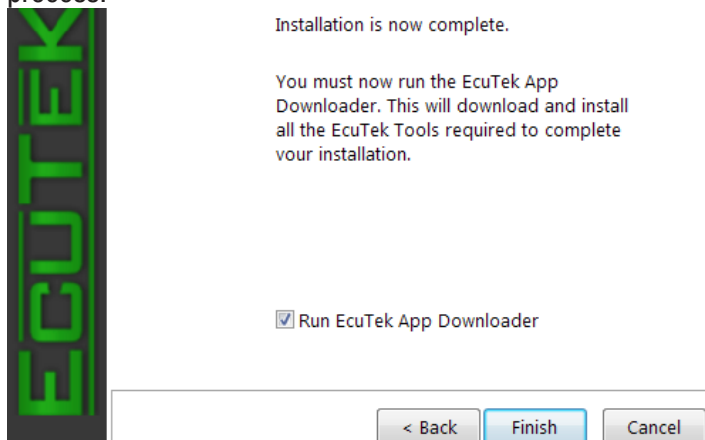

9. Make note of the Dongle ID and the Registration Code. Keep this information safe, for future reference. Select Download Now.

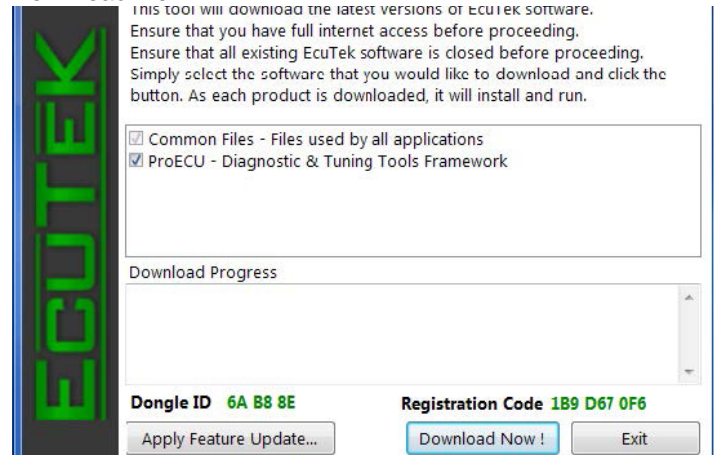

10. The download process may take a few minutes, so please be patient. When the download has completed, select OK to continue. Installation of the EcuTek ProECU software is now complete.

**NOTE:** When programming the ECU, it's highly recommended that all non-essential vehicle devices are switched off before attempting to program an ECU. This includes: headlights, interior lights, A/C, HVAC fan, radios and any other powered devices.

11. Plug the laptop into a power source.

12. Insert the supplied USB flash drive into the laptop.

13. Plug the EcuTek OBD2 vehicle interface cable into the vehicles OBD2 diagnostic socket. The socket is located beneath the lower section of the dashboard just above the drivers throttle pedal.

14. Connect the other end of the EcuTek vehicle interface cable to a USB port on the laptop computer.

15. 'Key-On' the vehicle ignition by pressing the start button twice WITHOUT stepping on the brake pedal. DO NOT START the engine.

### Installation Instructions

16. In the ProEcu software menu bar, select TOOLS, then IDENTIFY ECU, to find your vehicles CAL ID.

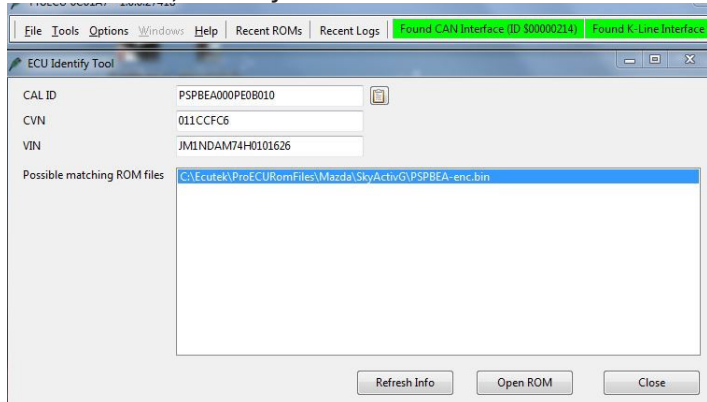

17. In order to acquire the needed supercharger calibration you will now need to email calibration@edelbrock.com with the following information:

- EcuTek Dongle ID #
- Vehicle CAL ID
- Vehicle Make
- Vehicle Model
- Vehicle Year
- Transmission Type (Auto/Manual)

18. Once you have received the E-Force supercharger calibration select TOOLS in the ProEcu menu bar then select DETECT VEHICLE.

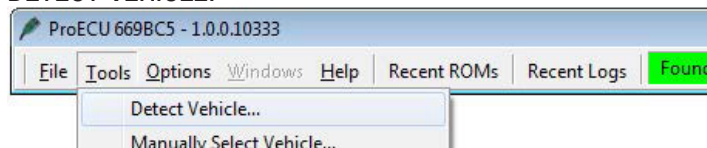

19. The ProECU Programming Tools window will only be displayed if ProECU successfully established a connection to the ECU. Proceed to Step 20 if you have established a successful connection. If not, please proceed with the cautionary notes.

**NOTE:** *If you get the following message, this is because the ProECU can't establish communication with the ECU. Follow the instructions on the message window to try and establish a connection. If this doesn't resolve the communication issue, close ProECU, unplug the EcuTek vehicle interface, plug it back in, and restart the software.*

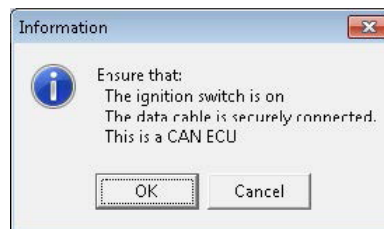

**NOTE:** *It is possible that you will come across an ECU version that EcuTek will not support. In this rare case, you will not be able to program the ECU until EcuTek has been supplied with certain information about the specific ECU. The 'Dump Details for EcuTek' button saves certain information from this ECU. The information is stored in a file that will be saved into the 'C:\EcuTek\RomDumps' folder. The name of the file will be displayed as it is saved.*

**Please note that it is not possible to open ROM Dumps in ProECU until the file has been e-mailed to EcuTek.**

**The information in the Dump Details MUST be sent to EcuTek using the Website Form. Together with a clear photograph of the ECU label and details of the following: Vehicle Make, Model, Year, and Manual or Auto gearbox from which the ECU originates. EcuTek will then supply an updated version of ProECU that will be capable of programming the ECU. You will then need to send the new file received from EcuTek over to Edelbrock (Calibration@edelbrock.com) with your Dongle ID and License Key to have the revised calibration file completed.**

Please note that the Turnaround time may take 24 to 48 hours for a supported calibration file to be created. This is why it is highly recommend to verify that the EcuTek is compatible with your ECU version well before starting the supercharger installation. This will alleviate any potential headaches for all parties.

**Refer to the ProECU Programming Overview file included with your software download for more in depth details regarding the EucTek programming procedure. This will also help if you are experiencing communication issues.**

### Installation Instructions

20. Verify PROGRAM ENGINE ECU is highlighted and select OK.

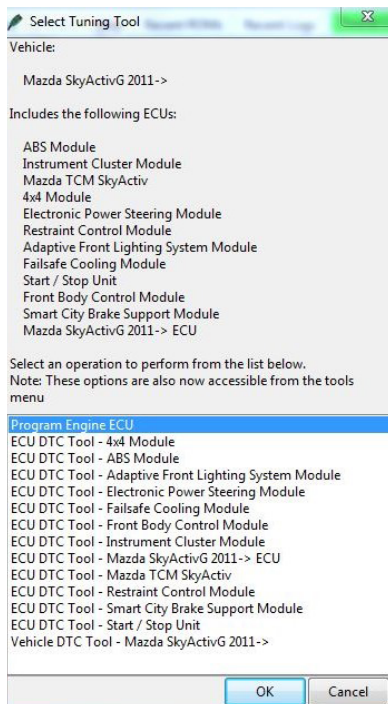

21. Select CHOOSE ROM FILE... under the 'ROM File to Program' window to select the E-Force supercharger calibration from your PC.

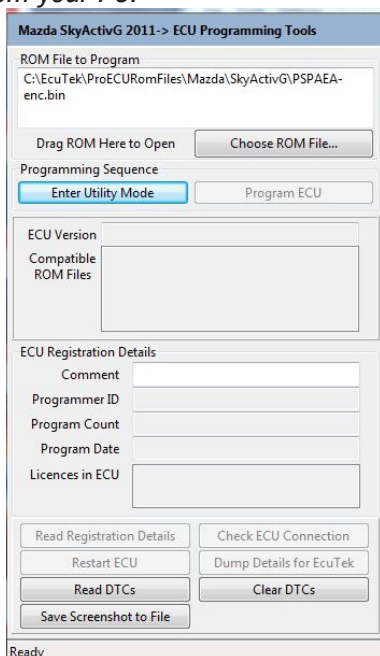

22. Once the E-Force file is displayed in the 'ROM File to Program' window select ENTER UTILITY MODE then PROGRAM ECU.

23. Follow the prompts given by EcuTek to complete the flashing process. Once the ECU programming is complete, the supercharger installation can begin.

Once the ECU programming is complete, secure the provided OBDII "DO NOT FLASH" cover onto the OBDII port. The supercharger installation can now begin.

### SUPERCHARGER INSTALLATION

1. Using a 10mm socket, remove the positive and negative battery terminals.



2. Using a 10mm deep socket, remove the battery hold down and set aside. Remove the battery and insulation from the engine bay.





### Installation Instructions

3. Using a 12mm socket and long extension, remove the three (3) bolts securing the battery tray to the frame. Also remove the retaining pin locating the negative battery terminal to the tray. Remove the tray from the engine bay and set aside.

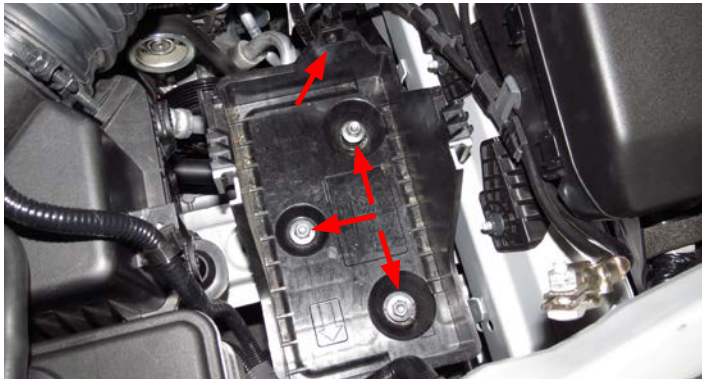

4. Using a panel puller and Phillips head screwdriver, remove the four (4) push pins and two (2) screws securing the radiator cover to the frame.



5. Using a service lift or jack stands, lift the vehicle and remove both front wheels. **NOTE:** The lug nuts can be removed with a 21mm socket.

6. Using a panel puller, remove the (14) push pins and four (4) screws (blue arrows) from the front half of the driver side fender liner. Remove the liner and set aside. Repeat on the passenger side.

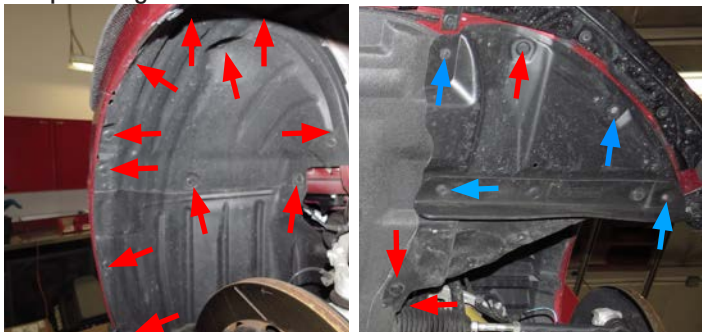

7. Using A 10mm socket, panel puller and Phillips Head Screwdriver, remove the eight (8) bolts, two (2) screws and two (2) push pins securing the under tray.

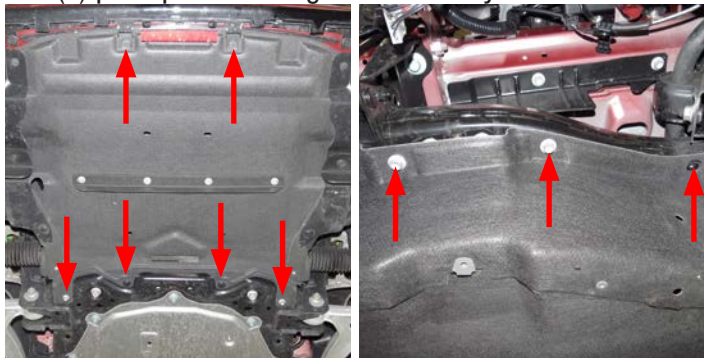

8. On both driver and passenger sides, disconnect the side marker and fog light harness connectors from the light fixtures. Using a panel puller, remove the anchors securing the harness to the light housing.



9. Using a 10mm socket or Phillips Head Screwdriver, remove the two (2) bolts securing the from fascia to the fender (one on each side of the vehicle).



### Installation Instructions

10. With the help from an assistant, remove the bumper by gently pulling out on the top corners where the 10mm bolts were removed in step #9. Set bumper aside.



11. With the vehicle lowered, remove the plastic engine cover by gently pulling up on the cover. This will not be reused.



12. Disconnect the valve cover breather hose from the valve cover.



13. Remove the coolant bleed line from the retaining clip and disconnect the hose from the fill cap side.



14. Disconnect the MAF sensor harness from the MAF sensor. Using a panel puller, remove the plastic retaining pin from the airbox lid.

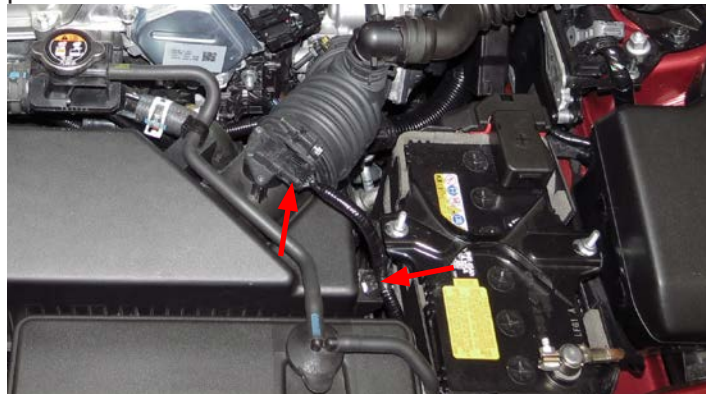

15. Disengage the two (2) clips retaining the airbox lid and loosen the clamp securing the rubber intake tube to the lid. Remove the lid and air filter and set aside.



### Installation Instructions

16. Loosen the clamp securing the rubber intake tube to the throttle body and pull the tube off.



17. If equipped, use a 10mm socket to remove the two (2) bolts securing the sound tube.



18. If equipped, remove the sound tube and intake tube assembly by disengaging the locking tabs from the fire wall mounting hole. **NOTE:** *There are two locking tabs on each side of the sound tube recessed in the fire wall. These tabs can be released by carefully inserting a flat head screwdriver on the sides of the tube to release the tabs.*



19. If the sound tube was removed, install the included fire wall plug located in hardware Bag #3.



20. Using a 10mm socket, remove the bolt securing the lower portion of the airbox to the frame and remove the airbox. The air inlet tube on the left will remain in place.



21. **NOTE:** *If the vehicle is not equipped with a strut tower brace, skip this step.*

Using a 14mm socket, remove the four (4) nuts securing the center and driver side portions of the strut tower brace and set brace aside.



### Installation Instructions

22. Disconnect the engine harness from the ECM by depressing the black clips and lifting up the grey levers to release the harness.



23. Using a 10mm deep socket, remove the two (2) nuts indicated with blue arrow and one (1) bolt indicated with red arrow from the ECM mounting bracket. Remove the ECM and bracket and set aside.

**NOTE:** The ECM bracket is attached to the black box next to it with two clips. CAREFULLY disengage the clips with a flat head screwdriver or needle nose pliers to separate.



24. Using a 10mm socket, remove the bolt securing the EVAP/Fuel line bracket to the frame. Disengage the two (2) white retaining clips from the bracket and remove the bracket. Discard the bracket but save the bolt. **NOTE:** The first white clip is located next to the 10mm bolt and the second can be accessed through the driver side wheel well.



25. Access the lower intake manifold bolt through the drive side wheel well. Use a 1/4" drive, 10mm swivel and long 1/4" drive extension to remove the bolt.

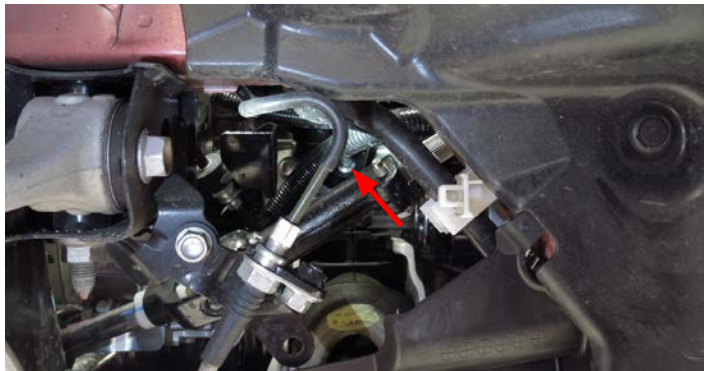

26. Separate the EVAP line and Fuel line by prying apart the plastic clip holding the lines together.



27. Using hose clamp pliers, remove the EVAP hose from the hard line.



28. Stuff shop rags under the fuel line to catch any spilt fuel and disconnect the line by pulling up on the yellow locking tab.



### Installation Instructions

29. Using hose clamp pliers, remove the brake booster hose from the hard line on the fire wall.



30. Remove the EVAP solenoid from the intake manifold by disconnecting the harness connector from the solenoid and removing the 8mm bolt securing the bracket to the solenoid. Remove the solenoid off the manifold as well as the rubber hose that connects to the manifold.



31. Using an 8mm socket, remove the bolt securing the fuel line bracket to the intake manifold.



32. Disconnect the four (4) coil harness connections from the coils. **TIP:** Carefully push down the plastic locking tab with a flat head screwdriver as the plug is pulled out.



33. Disconnect the fuel pump harness connector at the back of the engine just under the cowl.



34. Carefully remove the throttle body connection by gently prying up on the plastic locking tab with a flat head screwdriver and pulling the plug out.



35. Using an 8mm socket, remove the four (4) bolts securing the throttle body to the factory intake manifold.



### Installation Instructions

36. Using a panel puller and side cutters, remove and discard the two (2) anchors securing the engine harness to the intake manifold.



37. Carefully move the engine harness away from the intake manifold to gain access to the manifold bolts.



38. Using a 10mm socket and long extension, remove the five (5) remaining intake manifold bolts securing the manifold to the cylinder head. **NOTE:** Do not remove the intake manifold as the engine harness is still attached.

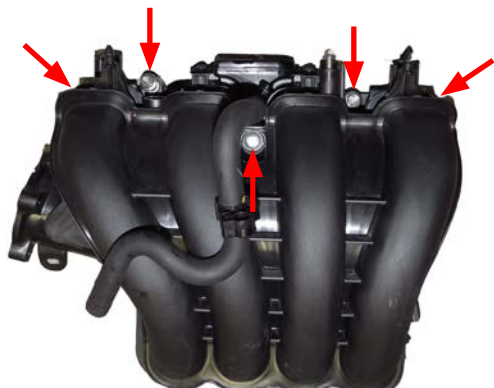

39. Using a panel puller, remove the anchor securing the alternator harness to the intake manifold.



40. Lift up the front of the intake manifold and remove the anchor securing the engine harness to the intake manifold.

**NOTE:** This pin will be located just behind the alternator.



41. Position the intake manifold as far forward as possible and remove the MAP sensor harness connector at the back of the manifold. Using a panel puller, remove the harness anchor attached to the intake manifold next to the MAP sensor.



### Installation Instructions

42. Remove and discard the three (3) remaining anchors securing the engine harness to the intake manifold and pull the hose off of the crank case vent. **TIP:** Use the image below as a guide for remaining anchor locations.



43. Remove the intake manifold and set aside. Using a lint free shop rag, clean the area around the intake ports and cover the ports with masking tape to keep out any debris.



44. Using a 13mm socket, remove the bolt securing the engine hoist bracket to the driver side of the cylinder head. **Optional:** Using the provided M10 x 16mm bolt in Bag #3, transfer the engine hoist bracket to the provision on the passenger side front of the cylinder head.



45. Remove the factory fuel input line by disengaging the locking tab on the fitting. The fitting is located on the driver side at the back of the engine.

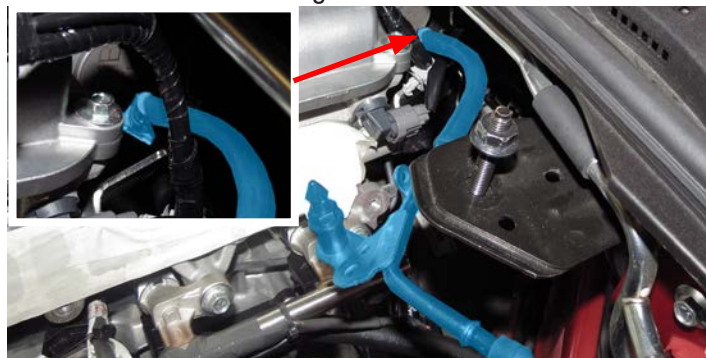

46. Install the provided fuel line by pushing the female end onto the factory quick connect fitting. Tuck the new fuel line against the fire wall as shown.



47. Using one (1) 5/8" clamp from Bag #2, secure the provided 3/8" crankcase breather hose to the fitting on the drive side of the crank case. **NOTE:** The provided hose length for this step is roughly 16" long.

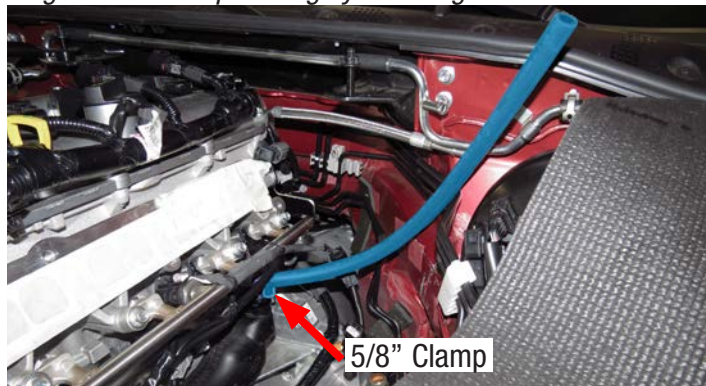

### Installation Instructions

48. Using a 12mm socket, remove the two (2) bolts securing the airbox mounting tray and set the tray aside. This will make removal/installation of the belt easier.

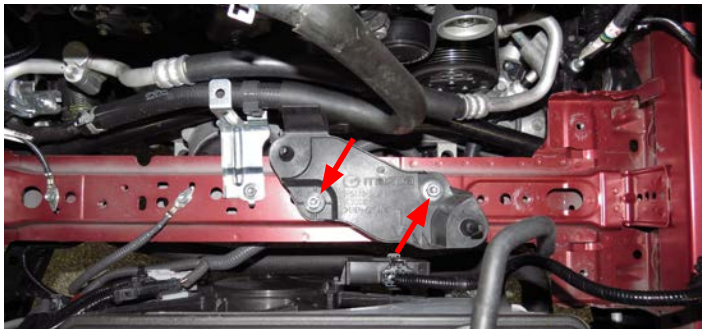

49. Using a 10mm socket, remove the bolt securing the cooling hose bracket to the frame. The bracket can be left attached to the hose. This will make removal/installation of the belt easier.

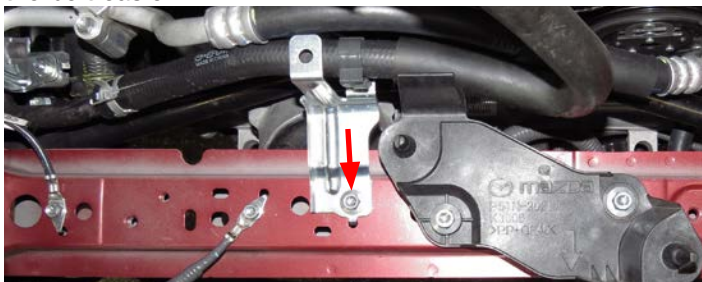

50. Using a 17mm wrench, slowly release the tension on the main drive belt and remove the belt. The wrench should be rotated counter clockwise to compress the tensioner.



51. Remove the four (4) intake O-ring gaskets from the factory manifold and trim off the small tab on each gasket.



52. Apply silicone lubricant to the modified O-ring gaskets then insert the gaskets into the supercharger runner as shown.



53. Locate the hose labeled "IC" and install one (1) 3/4" hose clamp from Bag #2 onto the 90° end.





### Installation Instructions

54. Locate the hose labeled "IC2" and install one (1) 3/4" hose clamp from Bag #2 onto the 90° end.



**NOTE:** Steps 55 and 56 are for vehicles equipped with automatic transmissions to make room for intercooler hose installation. Manual transmission vehicles should skip these steps and proceed to step #57.

55. Locate the plastic harness retaining clip next to the alternator and remove the harness from the clip using a flat head screwdriver. Remove the plastic clip from the bracket and discard.



56. Using pliers, bend the top portion of the harness retaining bracket so it is oriented straight up.

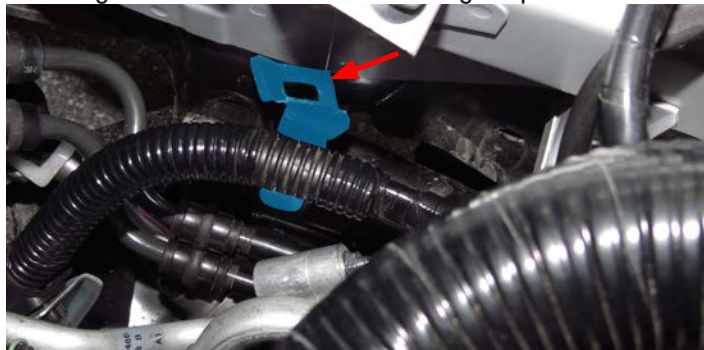

57. Position the hose labeled "IC" into the engine bay so that the hose routes under the clutch line (if equipped), engine harness, A/C line and front sway bar.

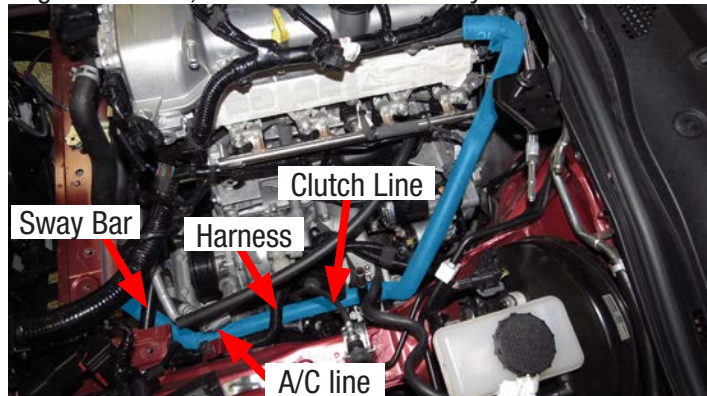

58. Position the hose labeled "IC2" into the engine bay so that it follows the same path as the hose labeled "IC" as shown below.



59. Remove the tape protecting the intake ports and clean off any residue with a lint free shop rag.

60. With the help from an assistant, secure the previously installed hoses onto the supercharger runner using the provided 3/4" hose clamps located in Bag #2. **NOTE:** The hose labeled "IC" should be installed on the top fitting.

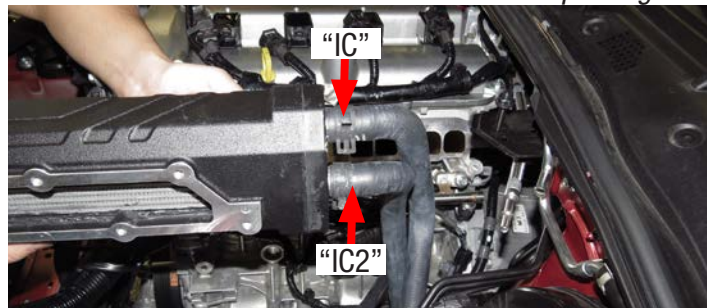

### Installation Instructions

61. Position the supercharger runner onto the cylinder head. Insert the two (2) M8 x 35mm Hex Flange bolts through the two (2) aluminum spacers from Bag #3, then thread the bolts into the slotted holes at the top of the runner. Using a 10mm wrench, tighten the bolts enough to hold the runner in place but do not fully tighten.

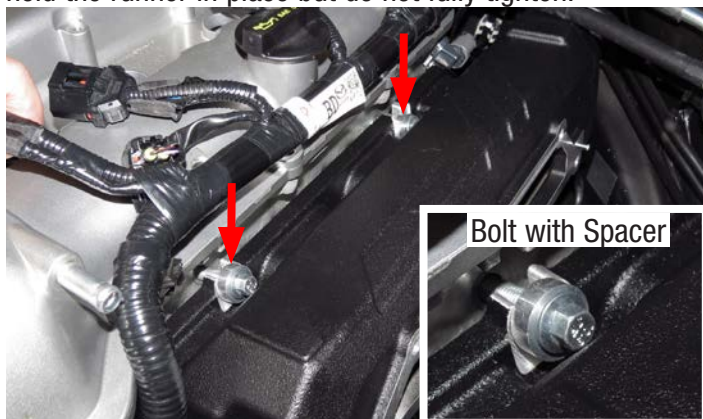

62. Insert the three (3) M8 x 25mm Hex Flange bolts from Bag #3 into the lower holes on the supercharger runner. Use a small 10mm swivel to snug all three bolts.

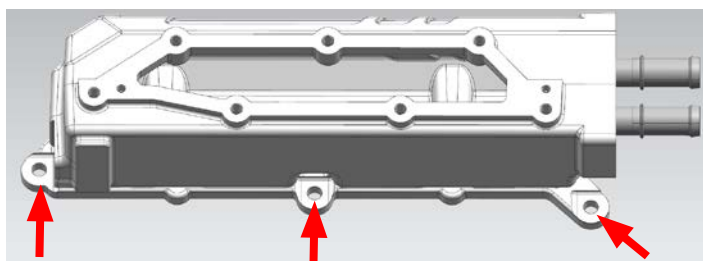

63. Using the torque sequence below, tighten all five (5) supercharger runner bolts to approximately 16 lb-ft.

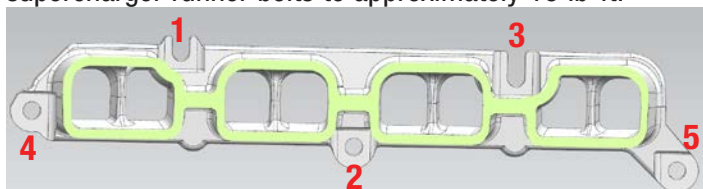

**NOTE:** Steps 64 & 65 are for vehicles equipped with an automatic transmission. Manual transmission vehicles skip these steps and proceed to step 66.

64. Using a 10mm wrench, remove the bolt securing the transmission cooler hoses to the bracket behind the alternator.



65. Using the factory bolt removed during step #24, loosely secure the transmission cooling hose bracket to the frame. Attach the provided hose clamp around both hoses and secure the clamp to the bracket with the factory bolt removed during step #64. Tighten both bolts.

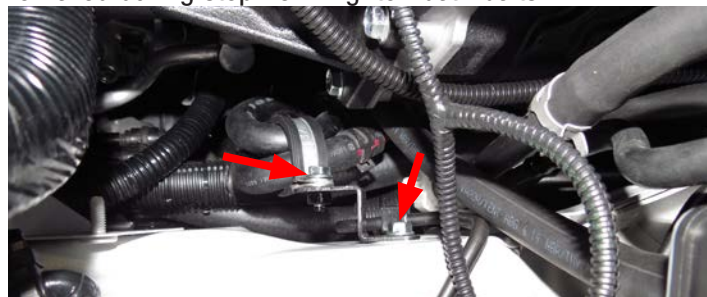

66. Attach convoluted tubing around the hoses installed in steps 57 and 58 in areas that make contact with sharp edges. Secure the convoluted tubing with zip ties or electrical tape.



67. Zip tie the hose labeled IC to the clutch line bracket then zip tie the two hoses together where they cross near the firewall. **Make sure the hoses DO NOT come in contact with the steering shaft.**



68. Connect the T-MAP harness extension to the factory MAP connector on the engine harness. Temporarily route the extension harness to the top of the engine so it is out of the way.



69. Using the one (1) M8 x 20mm bolt from bag #3, loosely install the supercharger support bracket onto the engine block above the drive side engine mount. **NOTE: The bracket should be rotated toward the alternator so to rests against the engine mount.**

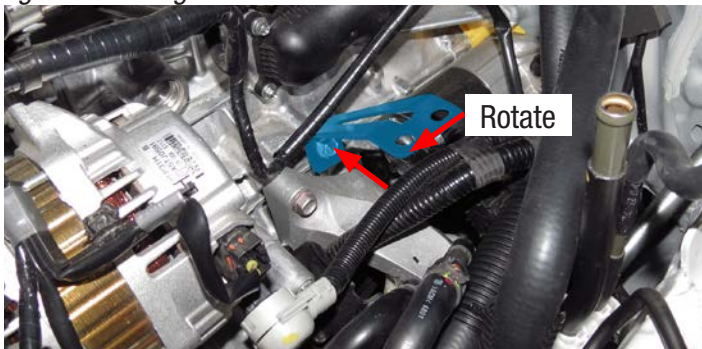

70. Using a 14mm socket, remove the top bolt securing the alternator to the engine block.



71. Using a flat head screwdriver, separate the plastic retaining clip from the engine harness. Remove and discard the bracket and plastic retaining clip.

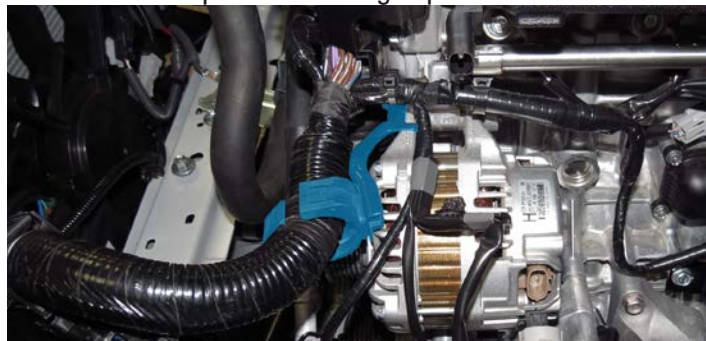

72. Using two (2) 3/4" hose clamps from Bag #2, connect the 2' section of 3/8" hose to the front fitting on the supercharger assembly. This hose will connect to the EVAP solenoid later. Connect the 3' section of hose to the rear fitting. This hose will connect to the brake booster later.

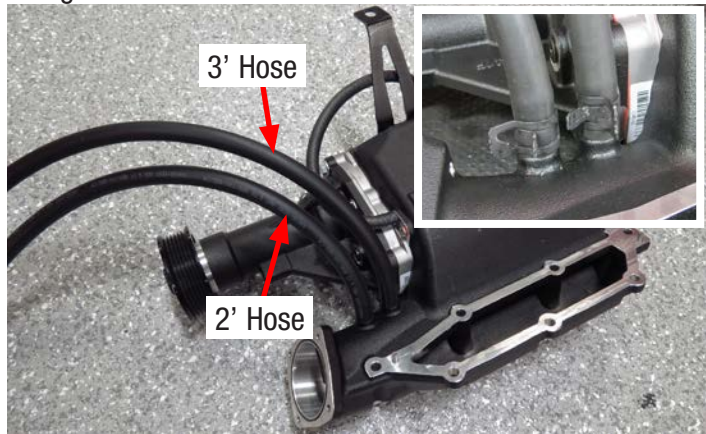

### Installation Instructions

73. Place the supercharger to intake runner gasket onto the intake runner as shown.



74. With the help from an assistant, lower the supercharger assembly into the engine bay angling the back of the supercharger in first. At this time, attach the previously installed crank case breather hose to the fitting on the back of the supercharger assembly using one (1) 3/8" hose clamp from Bag #2.



75. Carefully maneuver the supercharger assembly into place so the dowel pins on the intake runner seat into the associated holes on the supercharger. **Make sure that no wires or hoses are pinched during this step and the supercharger to intake runner gasket remains in place.**



76. Loosely install the seven (7) supercharger to intake runner bolts from Bag #3 (hand tight only).

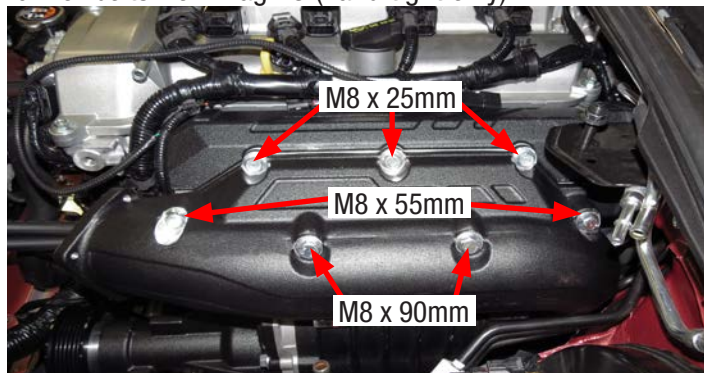

77. Reach under the supercharger assembly and rotate the previously installed supercharger support bracket so it aligns with the mounting holes on the supercharger. Install the two (2) M8 x 12mm bolts from Bag #2 by hand, then tighten to approximately 16 lb/ft. **NOTE: Picture below for representation only.**



78. Access the lower mounting bracket bolt through the drive side wheel well and tighten the bolt to 16 lb/ft.



### Installation Instructions

79. Using the torque sequence below, tighten the supercharger to manifold bolts in even steps to 12 lb/ft.

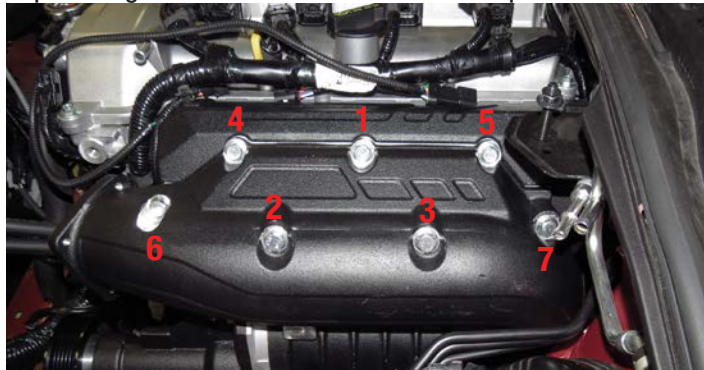

80. Attach protective convoluted tubing (highlighted red) to the engine harness above the alternator so no wires are visible. Secure the convoluted tubing with zip ties or electrical tape.



81. Install the provided engine harness retention bracket using the factory alternator bolt. Torque bolt to 32 lb/ft.

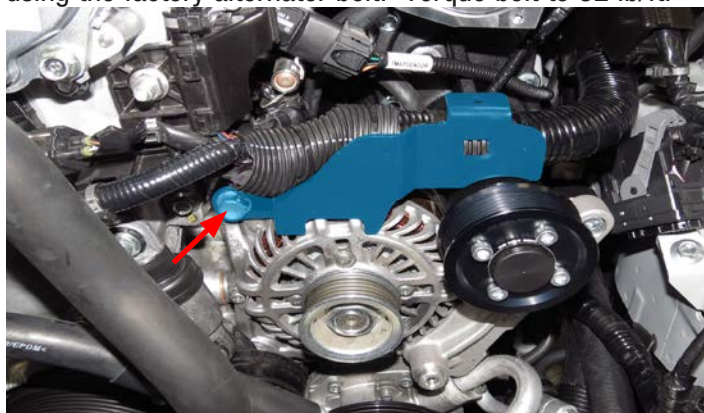

82. Using a 12mm socket, remove the front bolt securing the A/C compressor to the engine. **NOTE:** Pulley removed for photo. **DO NOT remove supercharger pulley.**



83. Using the 120mm hex head bolt from Bag #1, loosely install the supplied idler bracket onto the A/C compressor. Orient the bracket so the idler boss is facing forward and closest to the A/C pulley.

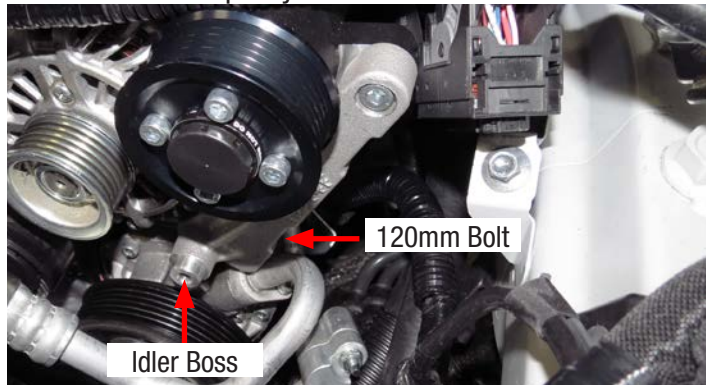

84. Secure the idler bracket to the supercharger nose using the 25mm socket head bolt from Bag #1. Tighten both idler bracket bolts to 18 lb/ft.



### Installation Instructions

85. Attach the idler pulley to the bracket using the M8 x 25mm bolt and washer from Bag #1. Tighten the bolt to 18 lb/ft using blue Loctite.



86. Using a 17mm wrench, slowly compress the belt tensioner by rotating the wrench counter clockwise, then install the provided belt using the routing diagram below.

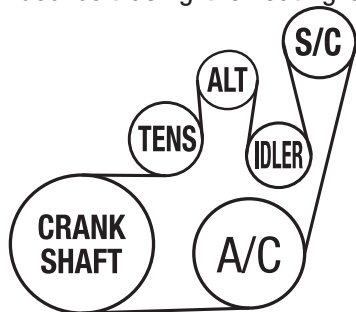

87. CAREFULLY bend the A/C line by hand, toward the driver side, to make clearance for the drive belt. Avoid lifting up on the line while bending as this will cause interference when reinstalling the battery box. Slowly bend the line until there is 1/4" clearance between the belt and the A/C line. **WARNING: Bending the A/C line too much can damage or break the line, leaking toxic refrigerant. Bend ONLY enough to provide 1/4" clearance for the belt.**

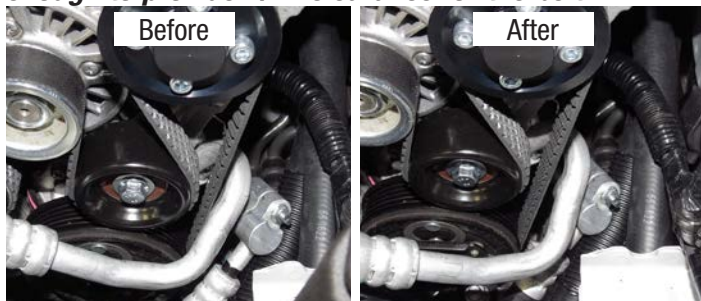

88. Install the surge tank onto the surge tank bracket using the two (2) M6 x 10mm bolts located in Bag #2.



89. Using a 10mm socket, remove the two (2) nuts securing the factory harness connection to the passenger side strut tower. Secure the surge tank bracket to the harness mount using factory nuts.



90. Using a 10mm socket and panel puller, remove the four (4) bolts and one (1) anchor securing the radiator shrouds and set them aside.



### Installation Instructions

91. Remove the two (2) inside bolts securing the passenger side crash beam to the frame. Install the passenger side LTR bracket on top of the crash beam mounting points and reinstall the bolts. **NOTE: Intercooler pump will NOT be installed at this time.**

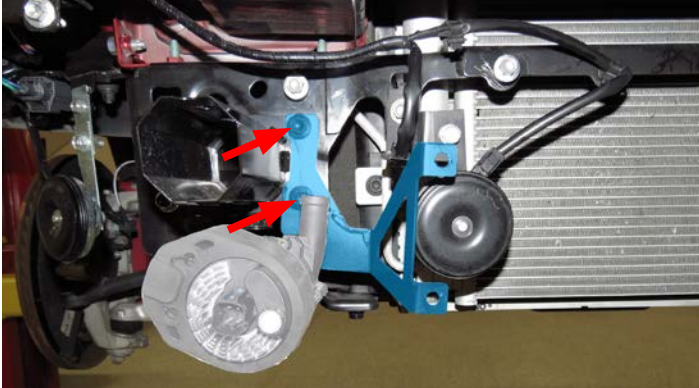

92. Remove the two (2) inside bolts securing the driver side crash beam to the frame. Install the driver side LTR bracket on top of the crash beam mounting points and reinstall the bolts.

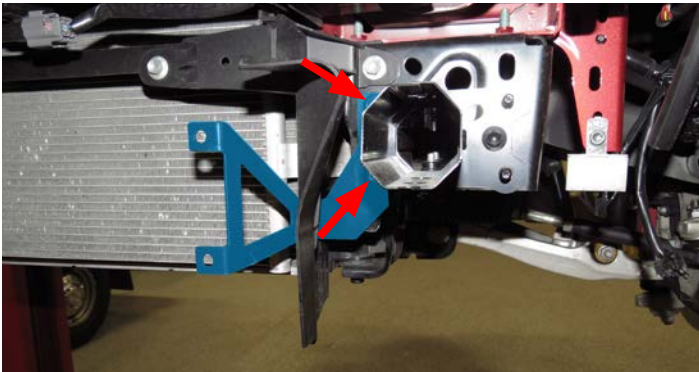

93. Reinstall the driver side shroud using the factory hardware.



94. Using an appropriate cutting tool, remove the top corner of the passenger side radiator shroud to allow for water pump hose clearance. Use the red line and measurements below for reference.

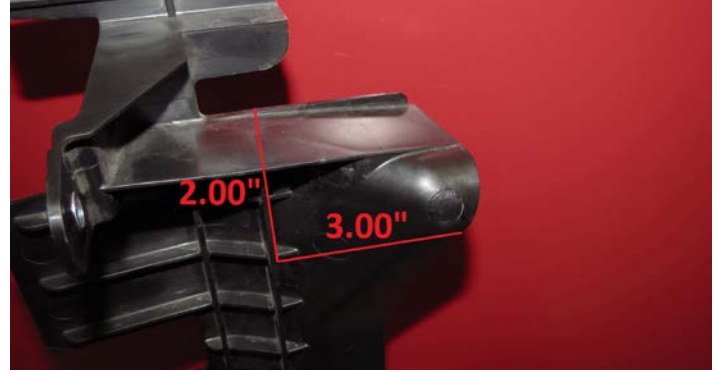

95. Reinstall the passenger side radiator shroud with the LTR support bracket using the factory hardware. The LTR support bracket mounts under the factory bolt on the right side of the shroud. Leave this bolt slightly loose for proper alignment later.

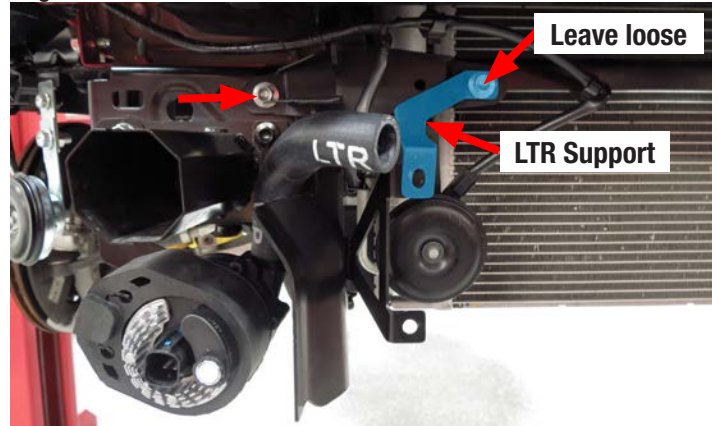

### Installation Instructions

96. Install the LTR onto the mounting brackets using the four (4) M6 x 16mm bolts from Bag #2. The LTR should be oriented so the spot welded portion of the LTR mounting tabs face the front of the vehicle and the hose fittings are on the passenger side. **NOTE:** *On the top left mounting point, the LTR mounting tab should be sandwiched between the LTR support bracket (FRONT) and LTR mounting bracket (BACK).*

**TIP:** If the holes on brackets do not align with the holes on the LTR, loosen the bolts securing the LTR brackets to the crash beam to allow extra play. Retighten the brackets once the bolts are started through the LTR mounting tab and the LTR is parallel to the ground.



97. Tighten the passenger side radiator shroud bolt left loose in step 95. **TIP:** *This bolt can be reached from the back side of the LTR using a 10mm wrench.*

98. Install the water pump into the rubber isolator in the orientation shown below and remove the two (2) protective caps.



99. Install the water pump bracket into the rubber isolator as shown below.



100. Install the water pump and bracket assembly onto the factory studs protruding from the passenger side crash beam support. Using a 13mm socket, secure the bracket to the studs with the two (2) M8 x 1.25 nuts from Bag #2.

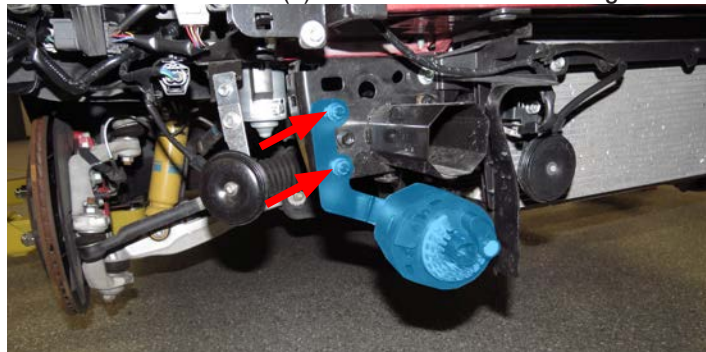

101. Using two (2) 3/4" clamp from Bag #2, install the water pump (WP) to LTR hose .

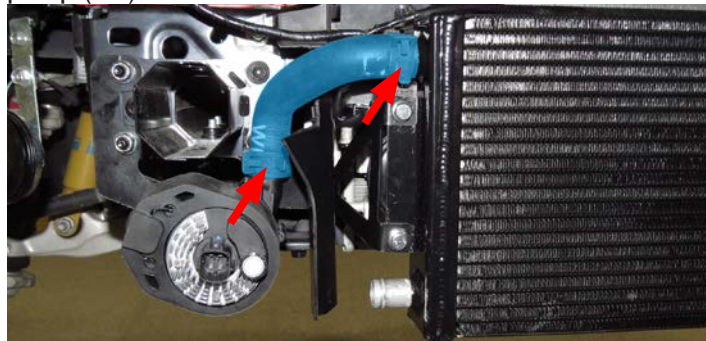



### Installation Instructions

102. Using an appropriate cutting tool, trim the bottom corner of the passenger side radiator shroud to make room for hose installation (remove approximately 2" x 2").

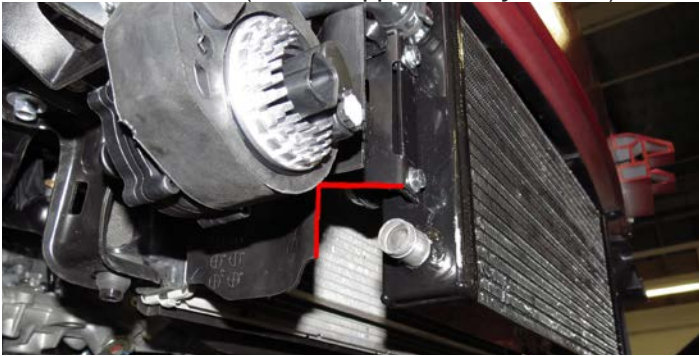

103. Using three (3) 3/4" clamps and one (1) straight connector from Bag #2, install the hose (highlighted blue) from the bottom fitting on the LTR to the hose end labeled "Z". Attach convoluted tubing (highlighted red) on the hose where it makes contact with metal or sharp surfaces and secure with zip ties or electrical tape. **NOTE: Zip Tie the hose to the two (2) ears on each side of the steering rack to hold it in place.**

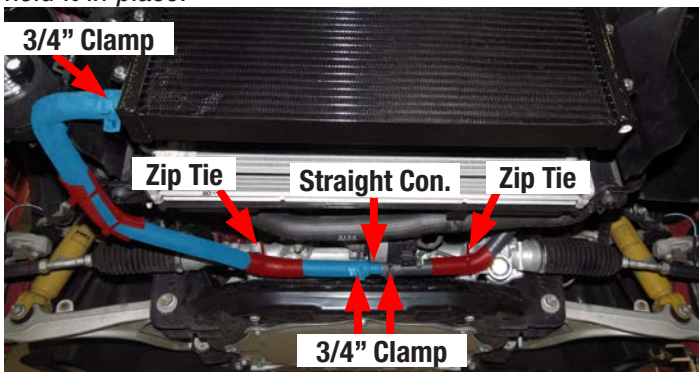

104. Using one (1) 3/4" clamp from Bag #2, secure the surge tank to water pump hose to the surge tank (end labeled "ST") and route the end labeled "WP" down to the water pump.



105. Using one (1) 3/4" Hose clamp from Bag #2, secure the surge tank to water pump hose (highlighted blue) to the water pump. Attach convoluted tubing (highlighted red) on the hose where it makes contact with metal or sharp surfaces and secure with zip ties or electrical tape.



106. Using one (1) 3/4" clamp from Bag #2, install the hose (highlighted blue) to the surge tank (end labeled "ST"), and route the other end of the hose (labeled "Y") down toward the steering rack. Attach convoluted tubing where the hose touches the frame.



107. Using two (2) 3/4" clamps and one (1) straight connector from Bag #2, attach the hose end labeled "Y" to the end labeled "X" as shown below.

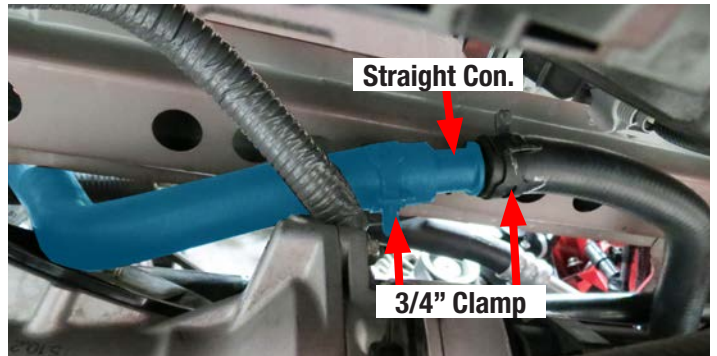

### Installation Instructions

108. Using the factory bolt, mount the water pump harness relay to the passenger side of the radiator fan shroud as indicated below.



109. Remove the factory ground bolt located on the cross member. Using the factory bolt, secure the wire labeled “ground” on the water pump harness to the factory ground location indicated below.

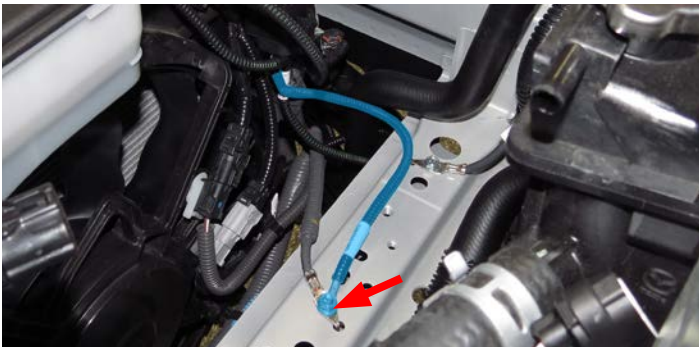

110. Route the connector labeled “water pump” down to the water pump and plug the connector into the pump. Make sure the connector “clicks” into place. Attach the harness to existing harnesses and secure with zip ties or electrical tape.

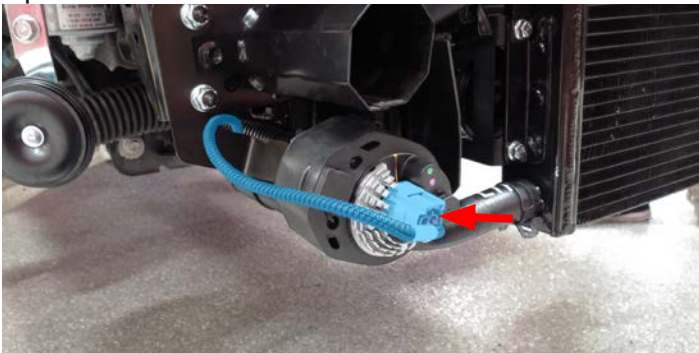

111. Route the power wire and EVAP/engine wires behind the engine coolant reservoir and over to where the battery is normally located. Attach the harness to existing harnesses and secure with zip ties or electrical tape.



112. Route the MAP sensor harness (installed during step 68) around the driver side of the supercharger and connect the harness to the MAP sensor located on the front of the intake runner.



113. Install the throttle body extension harness onto the factory throttle body connector. Tuck the factory end under the MAP sensor and route the harness to the front of the valve cover as shown.



### Installation Instructions

114. Install the valve cover breather hose onto the valve cover then route the hose along the coil harness and under the throttle inlet as shown.



115. Apply silicone lubricant to the provided throttle body O-ring and install the O-ring into the groove on the supercharger inlet.



116. Using the factory bolts, install the throttle body onto the supercharger inlet and plug the throttle body extension harness into the throttle body connector. Note the throttle body orientation below.



117. Locate the 2' section of hose previously attached to the supercharger inlet during step 72. Push the hose onto the nipple at the bottom of the factory EVAP solenoid.



118. Remove the EVAP hose from the factory intake manifold and orient as shown below. Cut the hose as far away from the 90° bend as possible but before the next bend starts as indicated by the red line.



119. Attach the two (2) factory EVAP hose clamps onto the hose cut in the previous step in the locations shown below.



### Installation Instructions

120. Install the hose prepared in step #119 from the factory EVAP hard-line (long end) to the EVAP solenoid (short end) and secure with the factory clamps as shown.



121. Reinstall the ECM and mounting bracket onto the studs protruding from the strut mount.

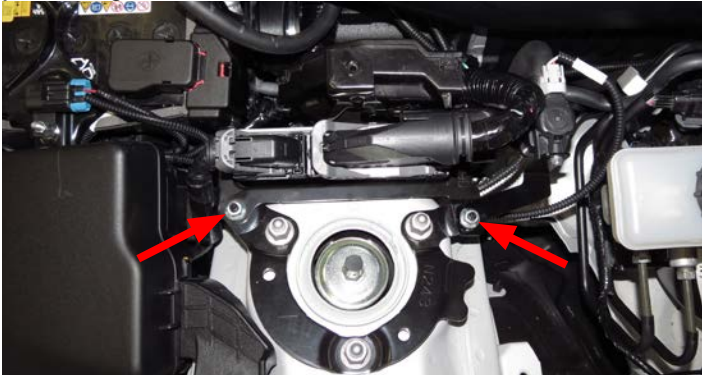

122. Install the EVAP mounting bracket onto the ECM mounting stud closest to the firewall and loosely secure with the factory nut. Attach the EVAP solenoid to the bracket using the factory bolt removed during step 30. Tighten both the nut and bolt.



123. Secure the ECM mounting bracket to the vehicle with the remaining nut and bolt removed during step 23. Reattach the black box to the side of the ECM bracket and reconnect the two (2) engine harness connections to the ECM.



124. Using a 12mm socket and long extension, reinstall the three (3) bolts securing the battery tray to the frame. Also reconnect the retaining pin locating the negative battery terminal to the tray. Make sure the tray clears the modified A/C line.

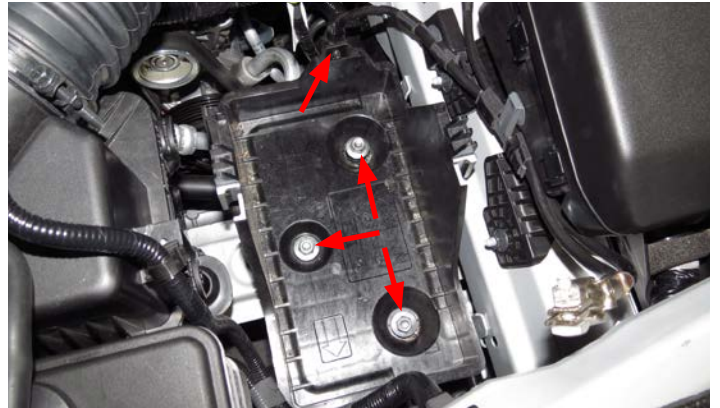

125. Using a 12mm socket, reinstall the two (2) bolts securing the airbox mounting tray.

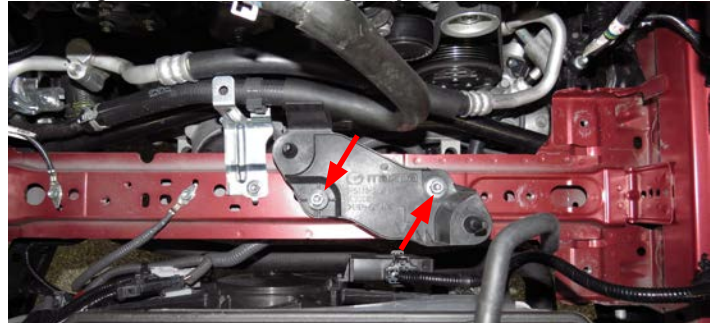

### Installation Instructions

126. Using a 10mm socket, reinstall the bolt securing the cooling hose bracket to the frame.

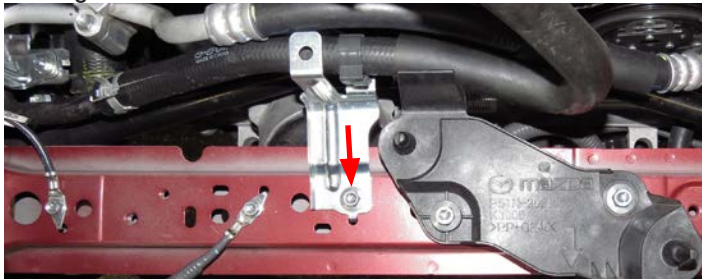

127. Using the factory hardware, reinstall the lower portion of the airbox and insert the provided K&N high flow filter in place of the factory paper filter.



128. Using the factory intake tube clamps and the provided 10mm barbed fitting, prepare the new intake tube as shown below. **NOTE:** Insert the short, barbed end of the aluminum fitting into the intake tube.



129. Install the new intake tube assembly onto the factory airbox lid in the orientation shown below. Do not tighten the clamp on the lid.



130. Reinstall the airbox lid making sure the tabs on the lid engage into the slots on the lower portion of the airbox. Once in place, lock the two (2) clips securing the lid to the lower half of the box. **NOTE:** The intake tube should be installed onto the throttle body at the same time the lid tabs are slid into their corresponding slots.



131. Connect the valve cover breather hose to the fitting on the intake tube by pushing the connector onto the fitting until it "clicks" into place.



### Installation Instructions

132. Using a Phillips head screwdriver, tighten the two (2) clamps securing the intake tube to the airbox and throttle body. Do not overtighten clamps.



133. Reconnect the coolant bleed hose to the radiator fill neck and lock the hose into place with the retaining clip on the airbox.

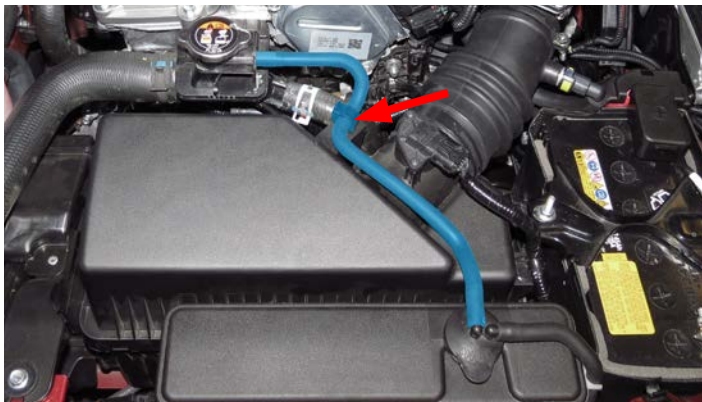

134. Reconnect the MAF sensor harness to the factory MAF sensor on the airbox lid. Also reinstall the harness retaining pin into the hole on the airbox.



135. Locate and remove the brake booster hose from the factory intake manifold. Also remove the indicated clamp.



**WARNING! Steps 136 to 138 are for installing the brake booster check valve. These steps must be followed correctly or braking performance will be severely compromised.**

136. Using a razor blade, carefully cut along the end of the hose as shown to expose and remove the white check valve.



137. Locate the 3' section of hose attached to the supercharger inlet during step 72. Lubricate the brake booster check valve with silicone lube and **insert the tapered end into the hose first**. Push the remaining portion of the check valve into the hose so it sits just below the hose end.

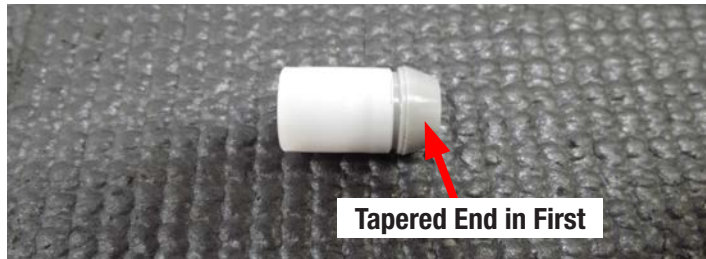

### Installation Instructions

138. Using the factory clamp, install the brake booster hose (with check valve installed inside) from the supercharger inlet onto the hard line on the firewall. **NOTE:** The check valve will move further down the hose as it is pressed onto the hard line.



139. Route the EVAP connector on the water pump harness to the EVAP solenoid and connect as shown. Attach the harness to existing harnesses and secure with zip ties or electrical tape.



140. Route the engine harness connector on the intercooler pump harness to the original EVAP connection at the top of the engine as shown.



141. Reinstall the battery by reversing the removal (steps 1 & 2). Connect the power wire on the water pump harness under the 10mm nut securing the positive battery terminal. **DO NOT** reconnect the battery ground at this time.



142. Using zip ties, secure all water pump harness wires away from any moving parts or potentially hot surfaces. Secure the water pump fuse holder inside the fuse box next to the battery as shown below and reinstall the lid.



143. Reconnect the four (4) coil harness connections and one (1) fuel pump harness connection at the back of the engine.



### Installation Instructions

144. Connect the factory fuel line to the previously installed fuel input line.



145. Reconnect the negative battery terminal.

146. Fill the supercharger surge tank with a 50/50 coolant and water mixture. **NOTE: Please see "How to Prime the Edelbrock E-Force Intercooler Systems" at the end of these instructions for detailed instructions.**

147. Turn the ignition on but do not start the vehicle. Verify that coolant is flowing briskly through the recovery tank, then install the cap. Check for any fuel and coolant leaks. If leaks are present, shut the ignition off immediately and repair leaks before continuing.

148. If equipped, reinstall the strut tower brace by reversing the removal steps.

149. To allow for intercooler pump and hose clearance, modify the passenger side front of the under tray by cutting notches in the areas shown below.

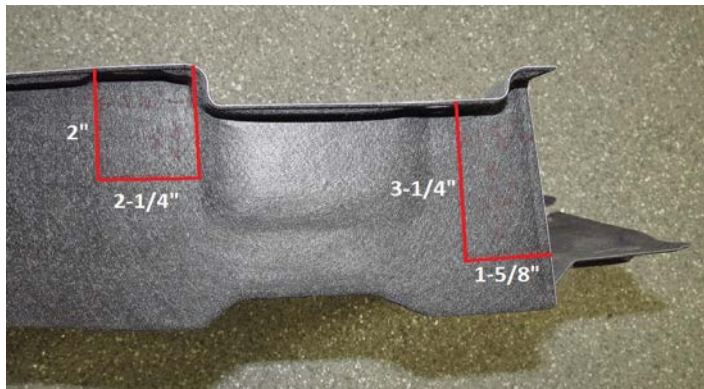

150. Using the factory hardware, reinstall the modified under tray by first rotating the notched section up and around the intercooler hose. One bolt will not be used as the hole was cut away during step #149. **TIP: Use a 10mm ratcheting wrench to tighten the bolt above the hose.**



151. Reinstall the front bumper and reconnect the fog lights and side markers by reversing steps 4, 8 and 9.

152. Reinstall the fender liners by reversing step 6.

153. Reinstall the front wheels and torque the lug nuts evenly to 85 lb/ft.

Congratulations on the installation of your new Edelbrock E-Force Supercharger System. If you have any questions, please call our Technical Support hotline and one of our technicians will be happy to assist you.





## How to Prime the Edelbrock E-Force Intercooler Systems.



***The electric water pump used on this Edelbrock E-Force Supercharger System has a built-in micro-processor that will vary pump cycle speed when air bubbles are present in the system. If a significant amount of air is trapped in the system, the pump may cycle at a slower speed and pulsations are likely to occur resulting in poor cooling performance.***

For the best result, it is highly recommended to use a Radiator Cooling System Vacuum Purge and Refill Kit to properly evacuate the air from the intercooler system before filling with a 50/50 mixture of coolant and distilled water. If one is not available, the following procedure will be adequate.

1. Using the Lisle 24680 Spill-Free Funnel, or equivalent, secure the appropriate filler neck adapter to the surge tank.
2. Attach the funnel and fill with a 50/50 mixture of coolant and distilled water until the funnel is half full.
3. Turn the ignition to the ON position and listen for the pump's electric motor to cycle. Air bubbles will begin to purge from the system as the coolant level drops. Add coolant to the funnel as necessary. *NOTE: Do NOT let the coolant level in the funnel run empty as this may introduce air into the system.*
4. To build more pressure in the intercooler system, try squeezing the intercooler hoses while the pump is cycling. Building pressure in the system will help purge the trapped air from the intercooler system.
5. Cycle the ignition OFF and wait a few seconds for the pump to come to a stop.
6. Cycle the ignition ON again and repeat until the sound of the electric pump is continuous without any pulsation. *NOTE: During water pump start-up, it is normal for a slight pulsation to occur. Once the pump has reached its maximum cycle speed, no pulsations should be present.*
7. Periodically inspect the water pump flow after a few drive cycles and re-fill the intercooler system as necessary.
8. Several drive cycles may be required to completely purge the air from the intercooler system. During a drive cycle, the intercooler system will build up pressure as the supercharger temperature increases. Any residual air trapped in the system will gradually bleed out of the surge tank as the system reaches a pressure above 5psi.

***WARNING: Always avoid removing the surge tank cap when the engine is hot. The hot coolant is under pressure and may spray out causing burns.***