

EECS 247

Analog-Digital Interface Integrated Circuits

© 2009

Instructor: Haideh Khorramabadi
UC Berkeley
Department of Electrical Engineering and
Computer Sciences

Lecture 1: Introduction

Instructor's Technical Background

- Ph.D., EECS department -UC Berkeley 1985, advisor Prof. P.R. Gray
 - Thesis topic: Continuous-time CMOS high-frequency filters
- Industrial background
 - 11 years at ATT & Bell Laboratories, N.J., in the R&D area as a circuit designer
 - Circuits for wireline communications: CODECs, ISDN, and DSL including ADCs (nyquist rate & over-sampled), DACs, filters, VCOs
 - Circuits intended for wireless applications
 - Fiber-optics circuits
 - 3 years at Philips Semiconductors, Sunnyvale, CA
 - Managed a group in the RF IC department- developed ICs for CDMA & analog cell phones
 - 3 years @ Broadcom Corp. – Director of Analog/RF ICs in San Jose, CA.
 - Projects: Gigabit-Ethernet, TV tuners, and DSL circuitry
 - Currently consultant for IC design
- Teaching experience
 - Has taught/co-taught EE247 @ UCB since 2003
 - Instructor for short courses offered by MEAD Electronics
 - Adjunct Prof. @ Rutgers Univ., N.J. : Taught a graduate level IC course

Administrative Issues

- Course web page:
<http://inst.eecs.berkeley.edu/~EE247/fa09>
 - Course notes will be uploaded on the course website prior to each class
 - Homeworks & due dates are posted on the course website
 - Announcements regarding the course will be posted on the home page, please visit course website often

Office Hours & Grading

- Office hours:
 - Tues./Thurs. 4 to 5pm @ 567 Cory Hall (unless otherwise announced in the class)
 - Extra office hours by appointment
 - Feel free to discuss issues via email:
haidehk@eecs.berkeley.edu
- Course grading:
 - Homework/project 50%
 - Midterm 20% (tentative date: Oct. 27)
 - Final 30%

Prerequisites & CAD Tools

- Prerequisites
 - Basic course in signal processing (Laplace and z-transform, discrete Fourier transform) i.e. EE120
 - Fundamental circuit concepts i.e. EE105 and EE140
- CAD Tools:
 - Hspice or Spectre
 - Matlab

Analog-Digital Interface Circuitry

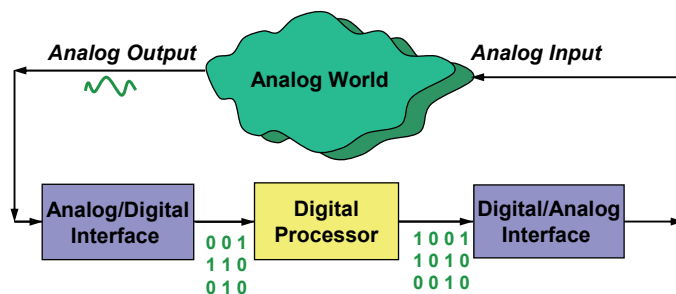

- Naturally occurring signals are analog
- To process signals in the digital domain
 - ∴ Need Analog/Digital & Digital/Analog interface circuitry

Question: Why not perform the signal processing in the analog domain only & thus eliminate need for A/D & D/A?

CMOS Technology Evolution versus Time

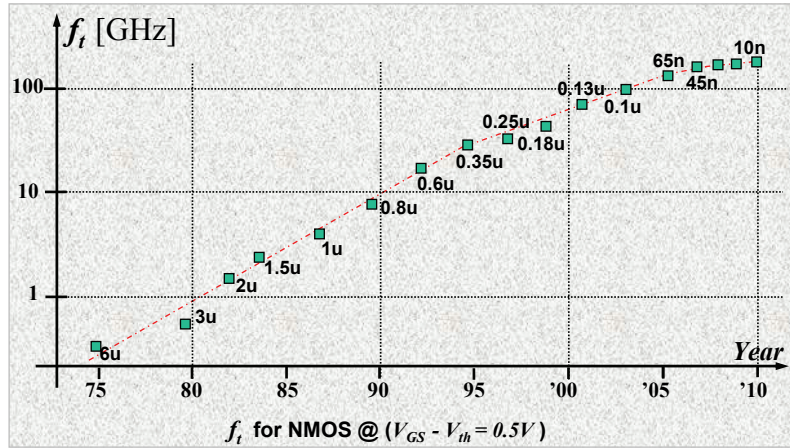

*Ref: Paul R. Gray UCB EE290 course '95

International Technology Roadmap for Semiconductors,

<http://public.itrs.net>

What is f_t ?

- $f_t \rightarrow$ transition frequency
- Freq. where short-circuit common-source current gain $A_f \sim 1$
- For a given technology single device f_t with minimum channel length is a measure of max. achievable ckt speed

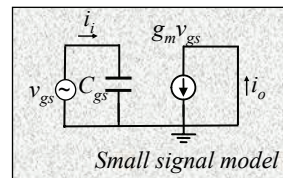
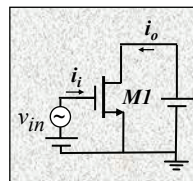

$$\frac{i_o}{i_i} = \frac{g_m}{s C_{gs}}$$

$$\frac{i_o}{i_i} = 1 \rightarrow 2\pi f_t = \frac{g_m}{C_{gs}}$$

Substituting for g_m and C_{gs} :

$$f_t = 1.5 \frac{\mu_n (V_{GS} - V_t)}{2\pi L^2}$$

where L is channel length

CMOS Device Evolution Progression from 1975 to 2005

- Minimum feature sizes $\sim X1/100$
- Cut-off frequency f_t $\sim X300$
- Minimum size device area $\sim 1/L^2$
- Number of interconnect layers $\sim X8$

❖ Note: Moore's Law \rightarrow # of transistors per sq-inch increases x2 every 18 months

Impact of CMOS Scaling on Digital Signal Processing

Direct beneficiary of VLSI technology down scaling

- Digital circuits deal with “0” & “1” signal levels only
 \rightarrow Not sensitive to “analog” noise
- Si Area/function reduced drastically due to
 - Shrinking of feature sizes
 - Increase in # of metal levels for interconnections (currently >8 metal level v.s. only 1 in the 1970s)
- Enhanced functionality & flexibility
- Amenable to automated design & test
- “Arbitrary” precision
- Provides inexpensive storage capability

Analog Signal Processing Characteristics

- Sensitive to “analog” noise
- Has not fully benefited from technology down scaling:
 - Supply voltages scale down accordingly
 - Reduced voltage swings → more challenging analog design
 - Reduced voltage swings requires lowering of the circuit noise to keep a constant dynamic range
 - Higher power dissipation and chip area
- Not amenable to automated design
- Extra precision comes at a high price
- Rapid progress in DSP has imposed higher demands on analog/digital interface circuitry
 - **Plenty of room for innovations!**

Cost/Function Comparison DSP & Analog

- Digital circuitry: Fully benefited from CMOS device scaling
 - Cost/function decreases by ~29% each year
 - ❖ **Cost/function X1/30 in 10 years***
 - Analog circuitry: Not fully benefited from CMOS scaling
 - Device scaling mandates drop in supply voltages → threaten analog feasibility
 - ❖ **Cost/function for analog ckt almost constant or increase**
- **Rapid shift of function implementation from processing in analog domain to digital & hence increased need for A/D & D/A interface circuitry**

*Ref: International Technology Roadmap for Semiconductors, <http://public.itrs.net>

Digitally Assisted Analog Circuitry

- Analog design has indeed benefited from the availability of inexpensive on-chip digital capabilities
- Examples:
 - Compensating/calibrating ADC & DAC inaccuracies
 - Automatic frequency tuning of filters & VCOs
 - DC offset compensation

Analog Digital Interface Circuitry Example: Digital Audio

- Goal-Lossless archival and transmission of audio signals
- Circuit functions:
 - Preprocessing
 - Amplification
 - Anti-alias filtering
 - A/D Conversion
 - Resolution→16Bits
 - DSP
 - Storage
 - Processing (e.g. recognition)
 - D/A Conversion
 - Postprocessing
 - Smoothing filter
 - Variable gain amplification

Analog Input

**Analog
Preprocessing**

**A/D
Conversion**

DSP

**D/A
Conversion**

**Analog
Postprocessing**

Analog Output

Example: Dual Mode CDMA (IS95)& Analog Cellular Phone RF & Baseband

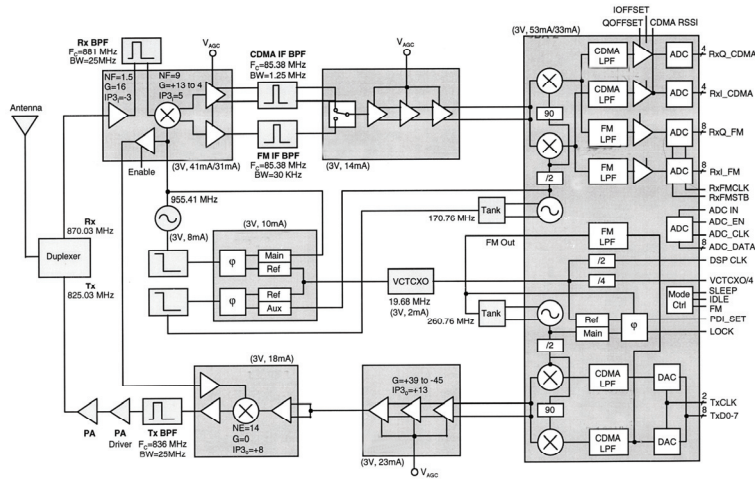

Example: Typical Dual Mode Cell Phone

Contains in integrated form the following interface circuitry:

- 4 RX filters
 - 3 or 4 TX filters
 - 4 RX ADCs
 - 2 TX DACs
 - 3 Auxiliary ADCs
 - 8 Auxiliary DACs
- } Dual Standard, I/Q
- } Audio, Tx/Rx power control, Battery charge control, display, ...

Total: Filters → 8

ADCs → 7

DACs → 12



Areas Utilizing Analog/Digital Interface Circuitry

• Communications

- Wireline communications
 - Telephone related (DSL, ISDN, CODEC)
 - Television circuitry (Cable modems, TV tuners...)
 - Ethernet (Gigabit, 10/100BaseT...)
- Wireless
 - Cellular telephone (CDMA, Analog, GSM...)
 - Wireless LAN (Blue tooth, 802.11a/b/g...)
 - Radio (analog & digital), Television
 - Personal Data Assistants



• Computing & Control

- Storage media (disk drives, digital tape)
- Imagers & displays

Areas Utilizing Analog/Digital Interface Circuitry

• Instrumentation

- Electronic test equipment & manufacturing environment ATEs
- Semiconductor test equipment
- Physical sensors & actuators
- Medical equipment

• Consumer Electronics

- Audio (CD, DAT, MP3)
- Automotive control, appliances, toys

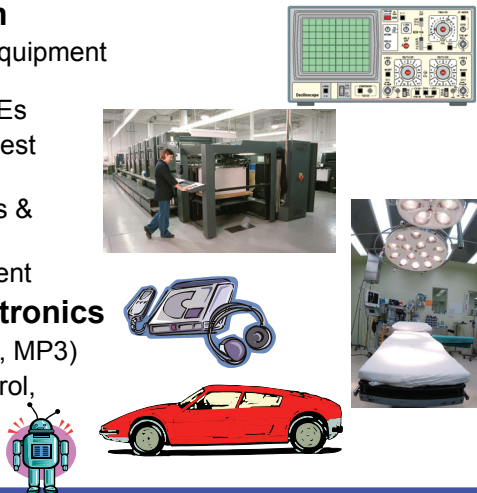

UCB Graduate Level Analog Courses EECS 247 - 240 - 242

- EECS 240
 - Transistor level, building blocks such as opamps, buffers, comparator....
 - Device and circuit fundamentals
 - CAD Tools → SPICE
- EECS 247
 - Filters, ADCs, DACs, some system level
 - Signal processing fundamentals
 - Macro-models, large systems, some transistor level, constraints such as finite gain, supply voltage, noise, dynamic range considered
 - CAD Tools → Matlab, SPICE
- EECS 242
 - RF amplification, mixing
 - Oscillators
 - Exotic technology devices
 - Nonlinear circuits

Material Covered in EE247

- Filters
 - Continuous-time filters
 - Biquads & ladder type filters
 - Opamp-RC, Opamp-MOSFET-C, gm-C filters
 - Automatic frequency tuning techniques
 - Switched capacitor (SC) filters
- Data Converters
 - D/A converter architectures
 - A/D converter
 - Nyquist rate ADC- Flash, Pipeline ADCs,....
 - Self-calibration techniques
 - Oversampled converters

Books (on reserve @ Eng. Library) (NOT required to be purchased)

- Filters
 - A. Williams and F. Taylor, *Electronic Filter Design Handbook*, 3rd edition, McGraw-Hill, 1995.
 - W. Heinlein & W. Holmes, "Active Filters for Integrated Circuits", Prentice Hall Int., Inc. Chap. 8, 1974. Good reference for signal flowgraph techniques
 - A. Zverev, *Handbook of Filter Synthesis*, Wiley, 1967.
A classic; focus is on passive ladder filters. Tables for implementing ladder filters (replaces a CAD tool).
 - Data Converters
 - R. van de Plassche, *Integrated Analog-to-Digital and Digital-to-Analog Converters*, 2nd edition, Kluwer, 2003.
 - B. Razavi, *Data Conversion System Design*, IEEE Press, 1995.
 - S. Norsworthy et al (eds), *Delta-Sigma Data Converters*, IEEE Press, 1997.
 - General
 - Gray, Hurst, Lewis, Meyer, *Analysis & Design of Analog Integrated Circuits*, Wiley 2001.
 - Johns, Martin, *Analog Integrated Circuit Design*, Wiley 1997.
- ❖ Note: a list of relevant IEEE publications is posted on the course website. Some will be noted as mandatory reading and the rest optional

Introduction to Filters

- Filtering → Provide frequency selectivity and/or phase shaping
 - Oldest & most common type of signal processing

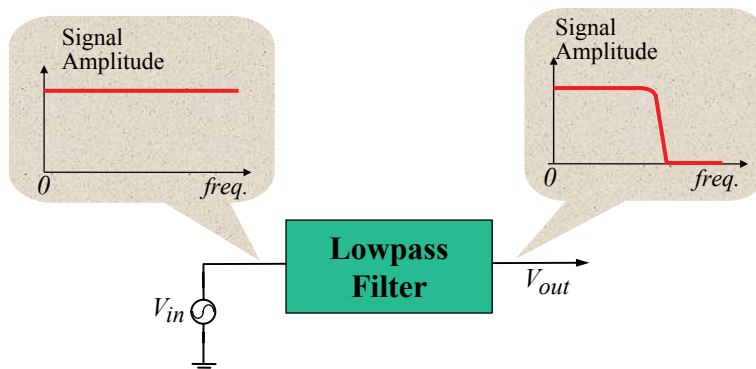

Introduction to Filters

- Typical filter applications:
 - Extraction of desired signal from many (radio, TV, cell phone, ADSL.....)
 - Separating signal and noise
 - Anti-aliasing
 - Phase equalization
 - Amplifier bandwidth limitations

Ideal versus Practical Filters Example: Lowpass Filter

• Ideal filter

- Flat magnitude response in the passband

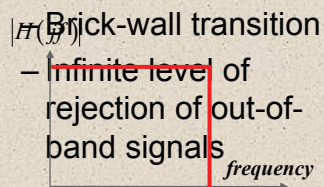

Ideal Lowpass Brick-Wall Filter

• Practical filter

- Ripple in passband magnitude response
- Limited rejection of out-of-band signals

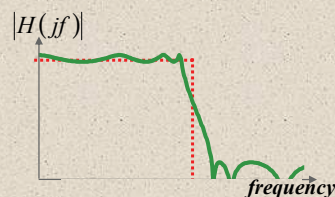

More Practical Filter

Simplest Filter First-Order Lowpass RC Filter

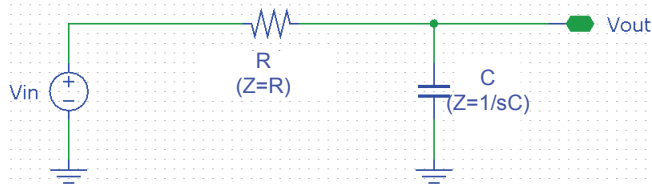

Steady-state frequency response:

$$H(s) = \frac{V_{out}(s)}{V_{in}(s)} = \frac{1/sC}{R + 1/sC} = \frac{1}{1 + RCs}$$

with $\omega_o = \frac{1}{RC} \rightarrow H(s) = \frac{1}{1 + \frac{s}{\omega_o}}$

S-Plane Poles and Zeros

$$H(s) = \frac{1}{1 + \frac{s}{\omega_o}}$$

Pole: $p = -\omega_o$

Zero: $z \rightarrow \infty$

$$|H(s)| = \left| \frac{1}{1 + j \frac{\omega}{\omega_o}} \right| = \frac{1}{\sqrt{1 + \frac{\omega^2}{\omega_o^2}}}$$

s-plane (pzmap):

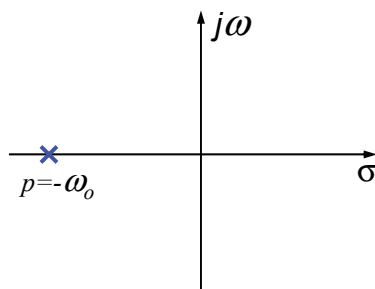

Magnitude Response Characteristics

Typically magnitude response is plotted in terms of decibel:

$$20 \log [|H(s)|] = 20 \log \frac{1}{\sqrt{1 + \frac{\omega^2}{\omega_o^2}}} = -10 \log \left(1 + \frac{\omega^2}{\omega_o^2} \right)$$

$$\omega = \omega_o \rightarrow 20 \log [|H(s)|] = -3dB$$

The frequency where magnitude response changes by $3dB$ is typically called corner or cut-off frequency

Simplest Filter First-Order Lowpass RC Filter Example



Steady-state frequency response:

$$H(s) = \frac{V_{out}(s)}{V_{in}(s)} = \frac{1}{1 + \frac{s}{\omega_o}}$$

$$\text{with } \omega_o = \frac{1}{RC} = 2\pi \times 100 \text{ kHz}$$

Filter Frequency Response Bode Plot

$$|H(s = j\omega)|_{\omega=0} = 1$$

$$|H(s = j\omega)|_{\omega=\omega_0} = 1/\sqrt{2}$$

$$|H(s = j\omega)|_{\omega \rightarrow \infty} = 0$$

Asymptotes:

- 20dB/dec magnitude rolloff
- 90degrees phase shift per 2 decades

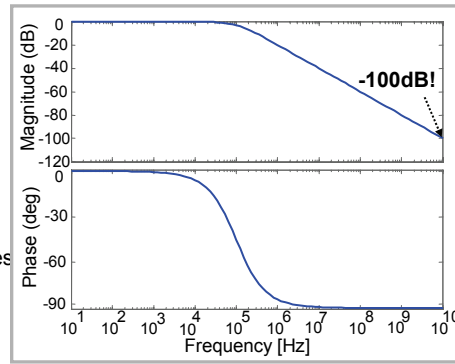

Question:
can we really get 100dB attenuation at 10GHz?

First-Order Low-Pass RC Filter Including Parasitics

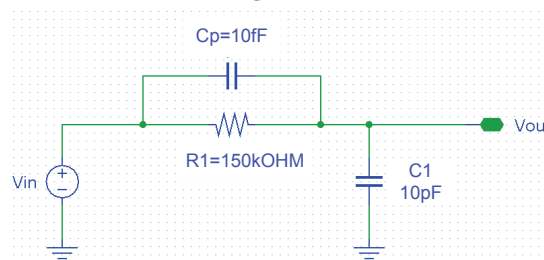

$$H(s) = \frac{1 + sRC_p}{1 + sR(C + C_p)}$$

$$\text{Pole: } p = -\frac{1}{R(C + C_p)} \approx -\frac{1}{RC}$$

$$\text{Zero: } z = -\frac{1}{RC_p}$$

Filter Frequency Response

$$\begin{aligned} |H(j\omega)|_{\omega=0} &= 1 \\ |H(j\omega)|_{\omega \rightarrow \infty} &= \frac{C_P}{C + C_P} \\ &\approx \frac{C_P}{C} \\ &= 10^{-3} \\ &= -60dB \end{aligned}$$

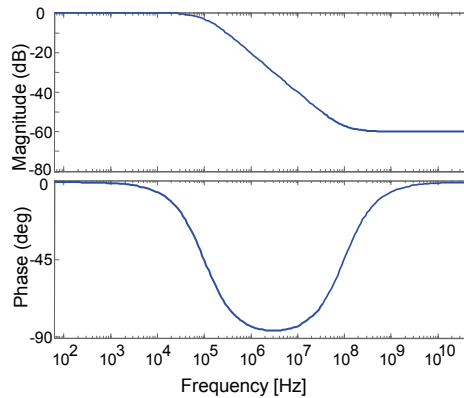

- Beware of important parasitics & include them in the model ...

Dynamic Range & Electronic Noise

- Dynamic range is defined as the ratio of maximum possible signal handled by a circuit and the minimum useful signal
 - Maximum signal handling capability usually determined by maximum possible voltage swings which in turn is a function of supply voltage & circuit non-linearity
 - Minimum signal handling capability is normally determined by electronic noise
 - Amplifier noise due to device thermal and flicker noise
 - Resistor thermal noise
- Dynamic range in analog ckts has direct implications for power dissipation

Analog Dynamic Range Example: First Order Lowpass Filter

- Once the poles and zeroes of the analog filter transfer function are defined then special attention must be paid to the actual implementation
- Of the infinitely many ways to build a filter with a given transfer function, each of those combinations result in a different level of output noise!
- As an example noise and dynamic range for the 1st order lowpass filter will be derived

First Order Filter Noise

- Capacitors are noiseless
- Resistors have thermal noise
 - This noise is uniformly distributed in the frequency domain from dc to infinity
 - Frequency-independent noise is called “white noise”

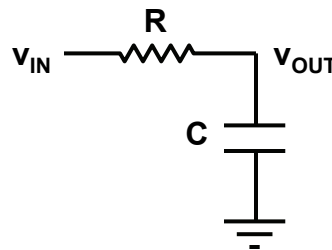

Resistor Noise

- Resistor noise characteristics
 - A mean value of zero
 - A mean-squared value

$$\overline{v_n^2} = 4k_B T_r R \Delta f$$

Volts² ohms measurement bandwidth (Hz) absolute temperature (°K)

Boltzmann's constant = 1.38e-23 J/°K

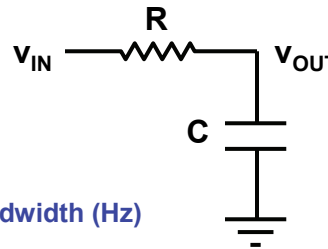

Resistor Noise

- Theoretically, resistor *rms* noise voltage in a 10Hz band centered at 1kHz is the same as resistor *rms* noise in a 10Hz band centered at 1GHz
- Resistor noise spectral density, N_0 , is the *rms* noise per $\sqrt{\text{Hz}}$ of bandwidth:

$$N_0 = \sqrt{\frac{\overline{v_n^2}}{\Delta f}} = \sqrt{4k_B T_r R}$$

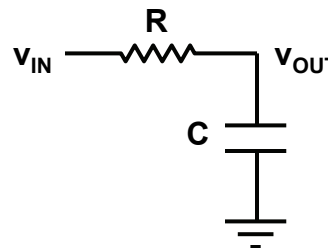

Resistor Noise

Good numbers to memorize:

- N_0 for a **1k Ω** resistor at room temperature is **4nV/ $\sqrt{\text{Hz}}$**
- Scaling R,
 - A 10M Ω resistor gives 400nV/ $\sqrt{\text{Hz}}$
 - A 50 Ω resistor gives 0.9nV/ $\sqrt{\text{Hz}}$

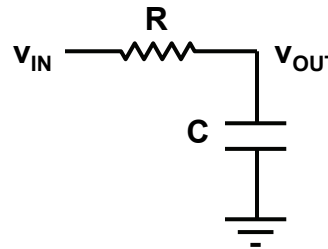

- Or, remember

$$k_B T_r = 4 \times 10^{-21} \text{ J} \quad (T_r = 17 \text{ }^\circ\text{C})$$

- Or, remember

$$k_B T_r / q = 26 \text{ mV} \quad (q = 1.6 \times 10^{-19} \text{ C})$$

First Order Filter Noise

- To derive noise @ the output node:
 - Short circuit the input to ground.
 - Resistor noise gives the filter a non-zero output when $v_{IN}=0$
 - In this simple example, both the input signal and the resistor noise obviously have the same transfer functions to the output
 - Since noise has random phase, we can use any polarity convention for a noise source (but we have to use it consistently)

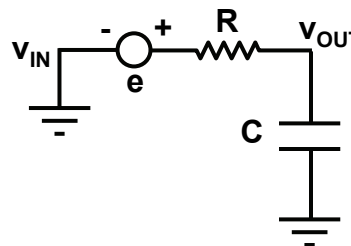

First Order Filter Noise

- What is the thermal noise of this RC filter?

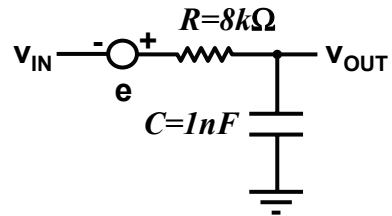

- Let's ask SPICE!
Netlist:

```
*Noise from RC LPF
vin vin 0 ac 1V
r1 vin vout 8kOhm
c1 vout 0 1nF
.ac dec 100 10Hz
1GHz
.noise V(vout) vin
.end
```

$$\omega_o = \frac{1}{RC} = 2\pi \times \underline{20kHz}$$

Output Noise Spectral Density

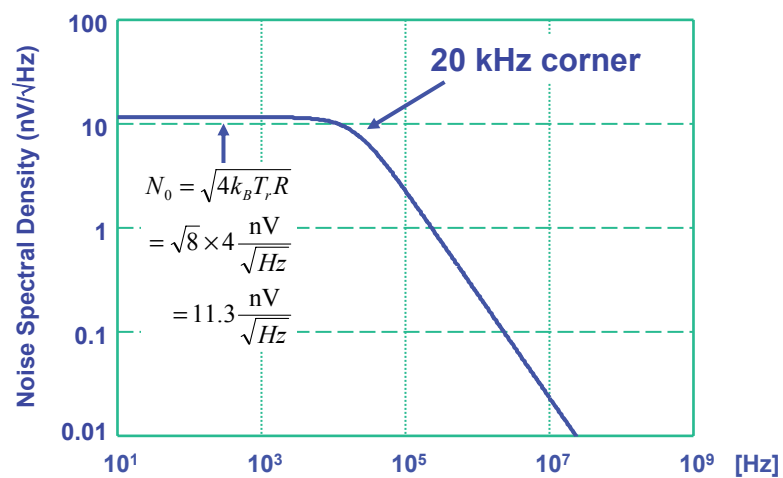

Total Noise

- Total noise is what the display on a volt-meter connected to v_o would show!
- Total noise is found by integrating the noise power spectral density within the frequency band of interest
- Note that noise is integrated in the mean-squared domain, because noise in a bandwidth df around frequency f_1 is uncorrelated with noise in a bandwidth df around frequency f_2
 - Powers of uncorrelated random variables add
 - Squared transfer functions appear in the mean-squared integral

$$\overline{v_o^2} = \int_{f_1}^{f_2} \overline{v_n^2} |H(j\omega)|^2 df$$

$$\overline{v_o^2} = \int_0^{\infty} 4k_B T R |H(2\pi jf)|^2 df$$

*Ref: "Analysis & Design of Analog Integrated Circuits", Gray, Hurst, Lewis, Meyer- Chapter 11

Total Noise

$$\begin{aligned} \overline{v_o^2} &= \int_0^{\infty} 4k_B T R |H(2\pi jf)|^2 df \\ &= \int_0^{\infty} 4k_B T R \left| \frac{1}{1 + 2\pi jfRC} \right|^2 df = 4k_B T R \int_0^{\infty} \frac{1}{1 + (2\pi fRC)^2} = 4k_B T R \times \frac{1}{2\pi RC} \tan^{-1}(2\pi RCf) \Big|_0^{\infty} \end{aligned}$$

$$\rightarrow \boxed{\overline{v_o^2} = \frac{k_B T}{C}}$$

- This interesting and somewhat counter intuitive result means that even though resistors are the components generating the noise, total noise is determined by noiseless capacitors!
- For a given capacitance, as resistance goes up, the increase in noise density is balanced by a decrease in noise bandwidth

kT/C Noise

- kT/C noise is a fundamental analog circuit limitation
- The *rms* noise voltage of the simplest possible (first order) filter is $(k_B T/C)^{1/2}$
- For 1pF capacitor, $(k_B T/C)^{1/2} = 64 \mu\text{V-rms}$ (at 298°K)
- 1000pF gives 2 $\mu\text{V-rms}$
- The noise of a more complex & higher order filter is given by:
 $(\alpha \times k_B T/C)^{1/2}$

where α depends on implementation and features such as filter order

Lowpass Filter Total Output Noise

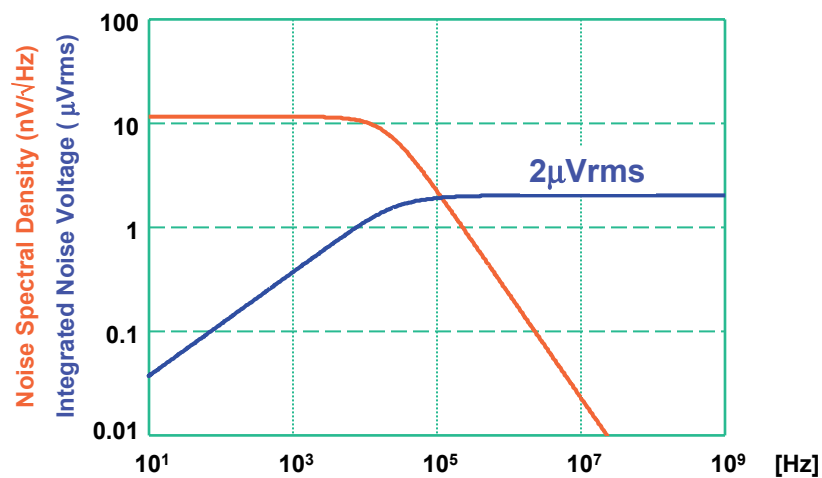

Lowpass Filter Output Noise

- Note that the integrated noise essentially stops growing above 100kHz for this lowpass filter with $f_{-3\text{dB}}=20\text{kHz}$
- Beware of faulty intuition which might tempt you to believe that an 80Ω , 1000pF filter has lower integrated noise compared to our 8000Ω , 1000pF filter...

Lowpass Filter Output Noise

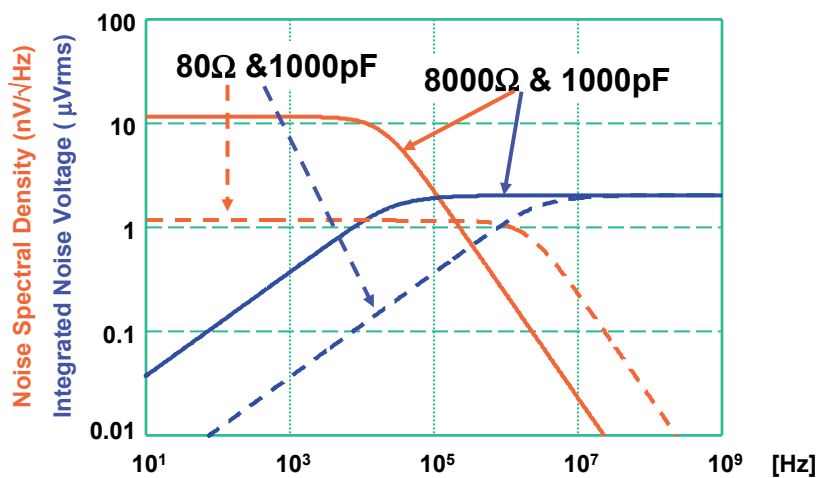

Analog Circuit Dynamic Range

- Maximum voltage swing for analog circuits (assuming no inductors are used!) can at most be equal to power supply voltage V_{DD} (normally is smaller)
- Assuming a sinusoid signal $\rightarrow V_{\max}(rms) = \frac{1}{\sqrt{2}} \frac{V_{DD}}{2}$

- Noise for a filter $\rightarrow V_n(rms) = \sqrt{\alpha \frac{k_B T}{C}}$

$$D.R. = \frac{V_{\max}(rms)}{V_n(rms)} = \frac{V_{DD} \sqrt{C}}{\sqrt{8\alpha k_B T}} \quad [V/V]$$

\rightarrow Dynamic range in dB is:

$$= 20 \log_{10} \left(V_{DD} \sqrt{\frac{C}{\alpha}} \right) + 75 \quad [\text{dB}] \quad \text{with } C \text{ in [pF]}$$

Analog Circuit Dynamic Range

- For integrated circuits built in modern CMOS processes, $V_{DD} < 1.5V$ and $C < 100pF$
 - **$D.R. < 98 \text{ dB}$** (assuming $\alpha = 1$)
- For printed-circuit board type circuits built with “old-fashioned” $30V$ opamps and discrete capacitors of $< 100nF$
 - **$D.R. < 140dB$**
 - **A $42dB$ advantage!**

Dynamic Range versus Number of Bits

- Number of bits and dynamic range in terms of dB are related:

$$D.R. = (1.76 + 6.02N) \text{ [dB]} \quad N \rightarrow \text{number of bits}$$

– see “quantization noise”, later in the course

- Hence

$$\begin{array}{lcl} 98 \text{ dB} & \rightarrow & 16 \text{ Bits} \\ 140 \text{ dB} & \rightarrow & 23 \text{ Bits} \end{array}$$

Dynamic Range versus Power Dissipation

- Each extra bit corresponds to 6dB extra dynamic range
- Increasing dynamic range by one bit \rightarrow 6dB less noise \rightarrow decrease in noise power by 4x!
- This translates into 4x larger capacitors
- To keep speed constant (speed prop G_m/C): G_m must increase 4x
- Power dissipation is proportional to G_m increases by 4x (for fixed supply and V_{dsat})

In analog circuits with performance limited by thermal noise,

1 extra bit costs 4x extra power dissipation

E.g. 16Bit ADC at 200mW \rightarrow 17Bit ADC at 800mW

Do not overdesign the dynamic range of analog circuits!

Noise & Dynamic Range Summary

- Thermal noise is a fundamental property of (electronic) circuits
- In filters, noise is closely related to
 - Capacitor size
- In higher order filters, noise is a function of C, filter order, Q, and depends on implementation
- Operational amplifiers used in active filters can contribute significant levels of extra noise to overall filter noise
- Reducing noise in most analog circuits is costly in terms of power dissipation and chip area