

Keysight Technologies

Keysight EEsof EDA Advanced Design System

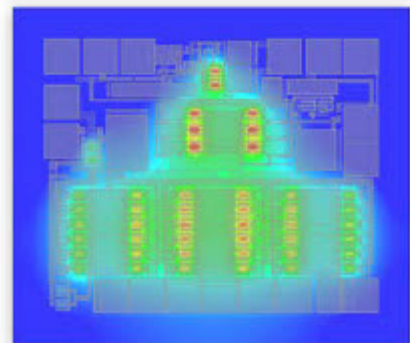
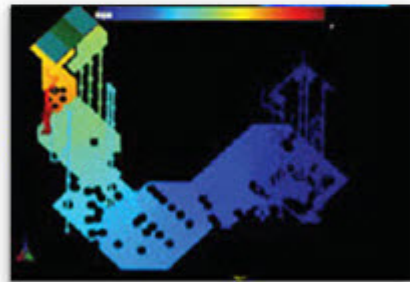
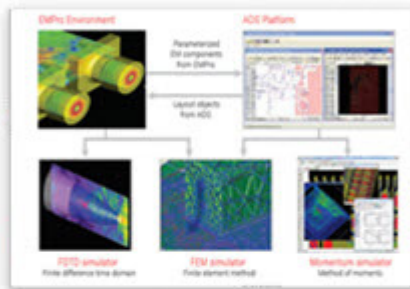
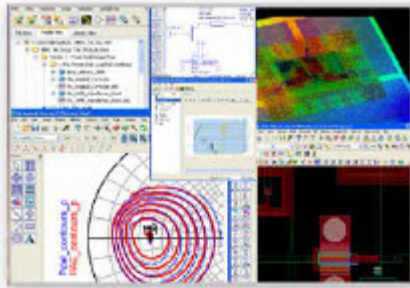

The Industry's Leading RF,
Microwave, Signal Integrity and
Power Integrity Design Platform

Table of Contents

Advanced Design System.....	03
More than 30 Years of Enabling Innovation	04
Design with Confidence.....	05
Complete Design Flow.....	07
Create Custom 3D Components for Simulation with ADS Layout Designs.....	10
Most Complete Solution.....	11
ADS Provides a Cohesive Workflow for Signal Integrity and Power Integrity Analyses	12
Integrated Solutions	13
Seamless Integration with Keysight’s EDA Tools and Measurement Instrumentation	14
Making Your Job Easier with Worldwide Technical Keysight EDA Experts.....	15
ADS Product Structure and Options Summary.....	16
Evolving Since 1939.....	18

Advanced Design System

Powerful. Easy. Complete.

The Keysight Technologies, Inc. Advanced Design System (ADS) is the world's leading electronic design automation (EDA) software for RF, microwave, and high speed digital applications. In a powerful and easy-to-use interface, ADS pioneers the most innovative and commercially successful technologies, such as X-parameters* and 3D EM simulators, used by leading companies in the wireless communication and networking and aerospace and defense industries.

For LTE-A, 802.11ac, PCI Express®, USB3, radar, and satellite applications, ADS provides full, standards-based design and verification with Wireless Libraries and circuit-system-EM co-simulation in an integrated platform.

These two sources create signals at RF +/- fspacing, so the tone spacing is fspacing.

I_nTone

SRC2

Freq[1]=RFfreq-fspacing/2
 Freq[2]=RFfreq+fspacing/2
 I[1]=dbmtoa(RF_power,50)
 I[2]=dbmtoa(RF_power,50)

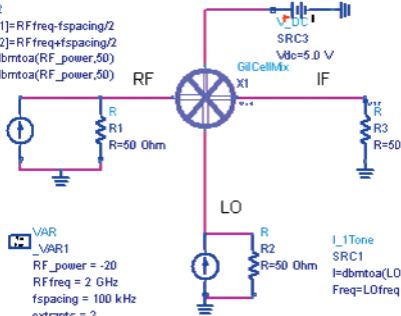

VAR

VAR1

RF_power = -20
 RFfreq = 2 GHz
 fspacing = 100 kHz
 extrapts = 3
 numpts = 20
 LO_power = -5
 LOfreq = 1750 MHz
 tstop = (numpts-extrapts)*tstep
 tstep = 1/((fspacing/2)/numpts)

PARAMETER SWEEP

Sweep2
 SweepVar="RF_power"
 Sim InstanceName[1]="Env1"
 Sim InstanceName[2]=
 Sim InstanceName[3]=
 Sim InstanceName[4]=
 Sim InstanceName[5]=
 Sim InstanceName[6]=
 Start=-50
 Stop=-20
 Step=10

ENVELOPE

Env1
 Max Order=4
 Freq[1]=LOfreq
 Freq[2]=RFfreq
 Order[1]=5
 Order[2]=2
 Sweep Offset=extrapts*tstep
 Stop=tstop
 Step=tstep

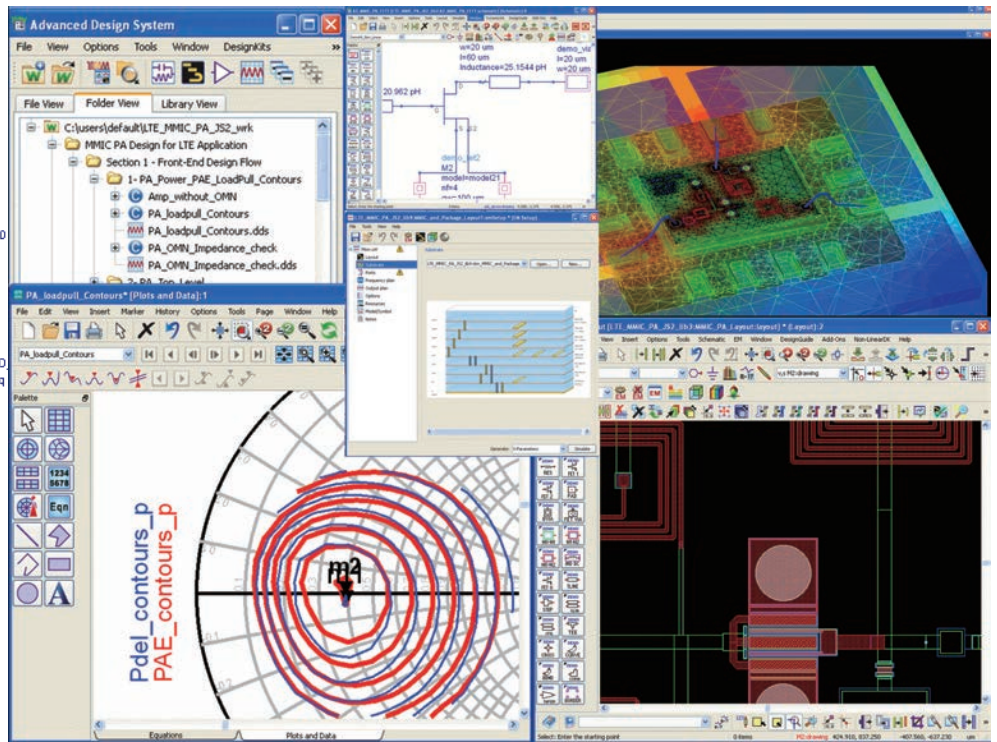

How To Video Series



Keysight EEs of EDA
 "How to" Video

Download the accompanying example workspace to get a jumpstart on your design.

www.keysight.com/find/eesof-ads-tutorial-videos



The Industry's leading technology, and much more

Only ADS offers a solution that combines schematic, layout, circuit, electro-thermal co-simulation and three full-wave 3D EM technologies for IC, package, laminate/PCB and 3D EM component co-design in a single-vendor, integrated platform solution that can dramatically improve productivity and significantly reduce costs.

To shorten your design cycles, ADS provides a huge amount of application-specific data. Over 300 examples cover everything from specific application circuits to tutorials on how to get the most out of ADS. DesignGuides integrate the experience and best practices of leading designers to provide you with wizards, pre-configured set-ups and displays, and step-by-step instructions for design applications, and give you easy access to the power of ADS from day one.

More than 30 Years of Enabling Innovation

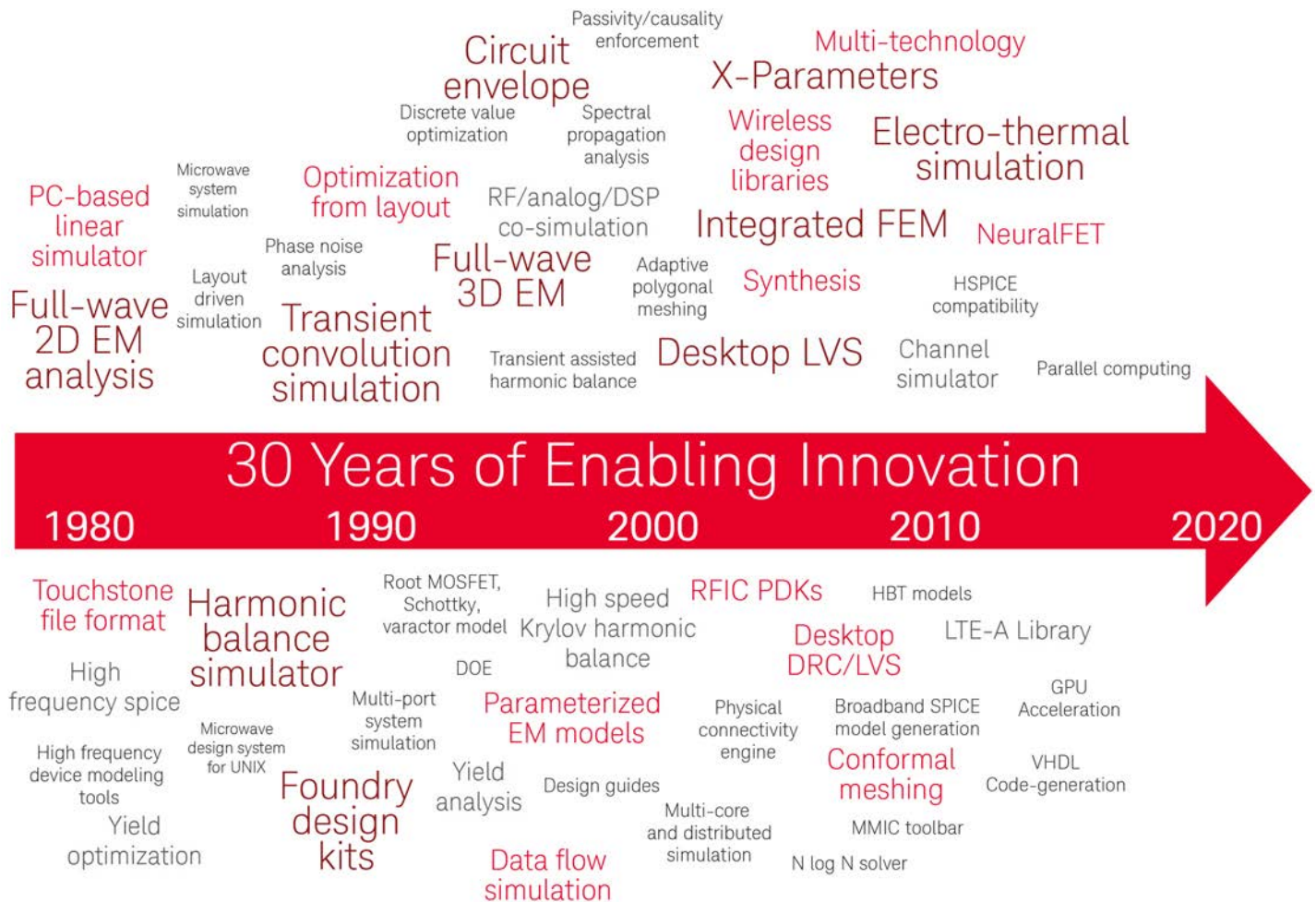

Design with Confidence

Anticipate success with fast, accurate, and easy first-pass simulations

ADS key highlights

- Complete set of fast, accurate and easy-to-use simulators enable first-pass design success
- Easy-to-use, application-specific DesignGuides encapsulate years of expertise
- Exclusively endorsed by leading industry and foundry partners
- Complete schematic capture and layout environment
- Innovative and industry-leading circuit and system simulators
- Direct, native access to 3D planar and full 3D EM field solvers
- Broadest RF and MW process design kit (PDK) coverage, endorsed by leading foundry and industry partners
- EDA and design flow integration with companies such as Cadence, Mentor and Zuken
- Optimization Cockpit for real-time feedback and control when using any of 12 powerful optimizers
- X-parameter model generation from circuit schematic and Keysight's Nonlinear Vector Network Analyzer (NVNA) for nonlinear high-frequency design
- Up-to-date Wireless Libraries for design and verification of the emerging wireless standards

The ADS platform comprises solutions for design entry, synthesis, system, circuit, 3D EM simulation, analysis/post processing, and a complete flow to manufacturing. It easily integrates with the designers' enterprise IC or PCB framework.

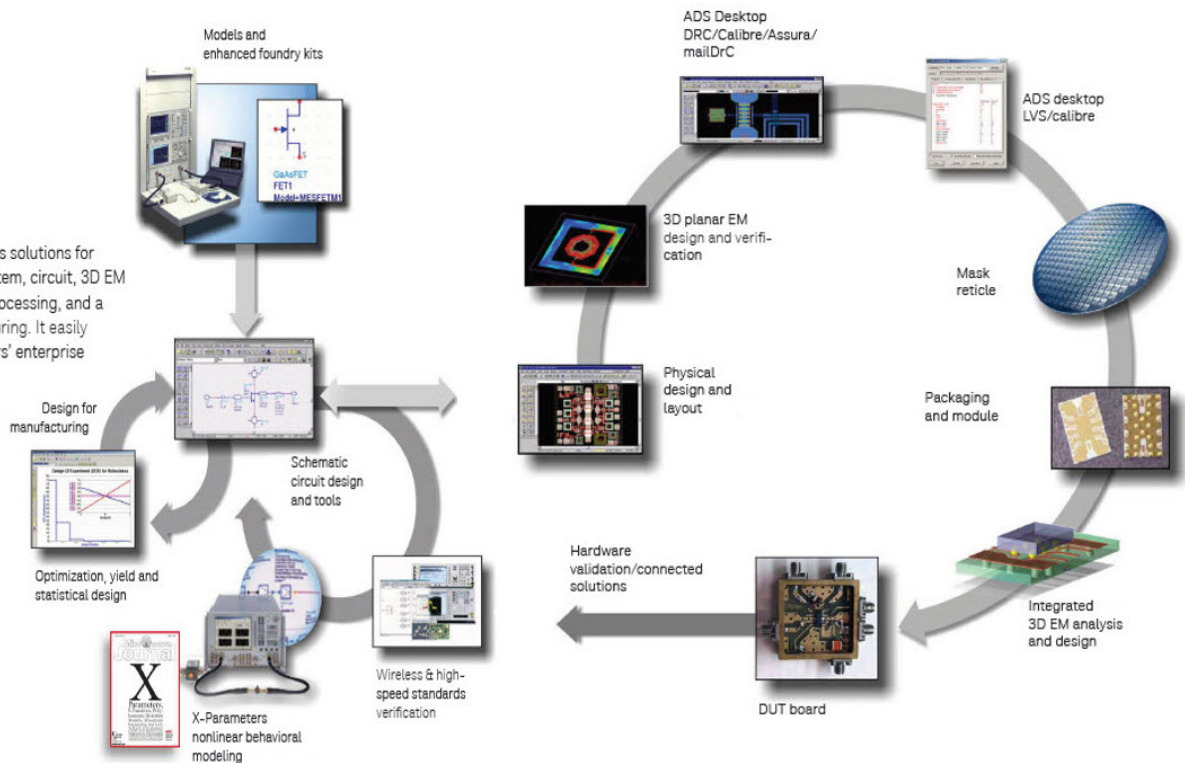

Design with Confidence (Continued)

Accelerate your design process with Keysight EDA foundry partners

RFIC and MIMIC foundry partners

Keysight EEsof EDA works closely with foundries to offer you high-frequency PDKs in Si, SiGe, GaAs, InP and GaN processes.

Complete front-to-back ADS PDKs, including DRC rules and Momentum stack-up files, for all GaAs, InP and GaN processes, as well as a broad range of SiGe and RF-CMOS processes are available.

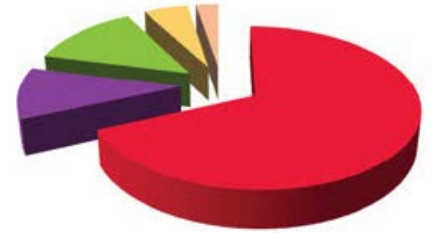

Keysight EDA 69%

Keysight EDA is the leading provider of RF Design and Simulation tools.
(Courtesy of Gary Smith EDA)



GLOBALFOUNDRIES



ON Semiconductor

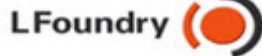

Complete Design Flow

Create robust designs with first pass success and high yield

Innovative and industry-leading simulation technologies

Figure 1

- S-parameter linear frequency-domain simulator
- Harmonic balance nonlinear frequency-domain simulator
- Circuit envelope hybrid time-/frequency-domain nonlinear simulator
- Transient/convolution time-domain simulator
- Momentum 3D planar EM simulator
- Finite Element full 3D EM simulator
- X-parameter generator simulator
- Signal Integrity Channel simulator
- Keysight Ptolemy system simulator

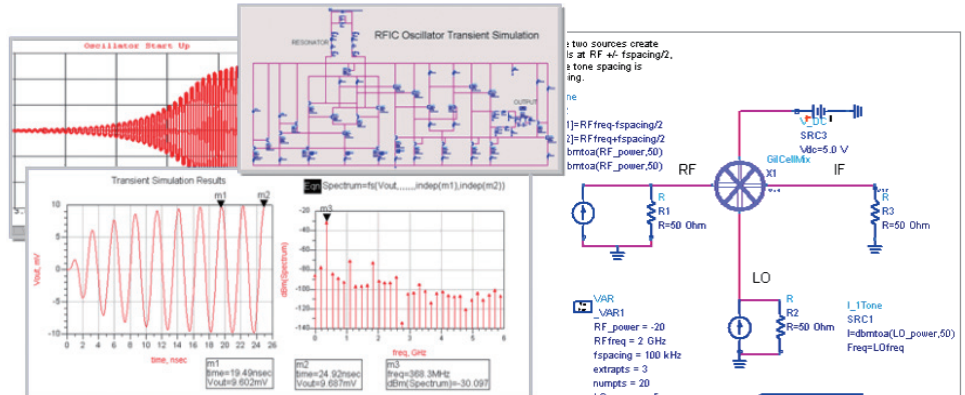

Figure 1.

Post processing with data display

Figure 2

A powerful Data Display capability allows you to learn about your design's performance by post-processing and analyzing the data without re-running simulation. Countless built-in functions simplify the process. For added flexibility, you can even write your own functions (e.g., for the creation of load-pull contours, gain circles or eye diagrams).

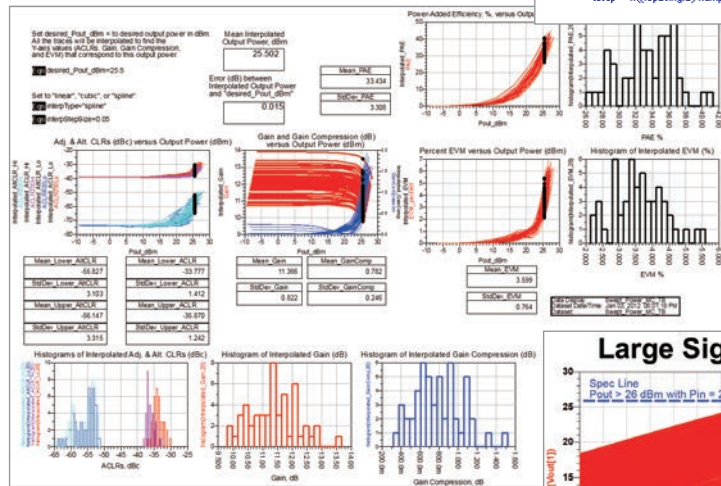

Figure 2.

Optimizing your design

Figure 3

Once your initial design is done, ADS optimizers can further improve its nominal performance. The ADS optimization cockpit provides an interactive environment with multiple optimization variables, interactive tuning and progress controls. Using it, you can achieve optimal performance while gaining design insight into the optimized variables versus the goals.

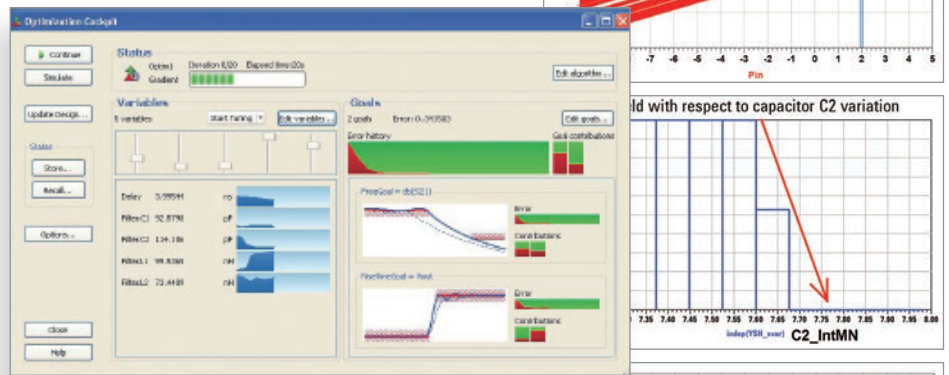

Figure 3.

Making your designs more robust

Figure 4

ADS features unique and easy-to-use statistical tools to pinpoint problems during design. Yield sensitivity histograms help identify the most sensitive design components and how best to set their specifications to improve manufacturing yield.

Large Signal Simulation

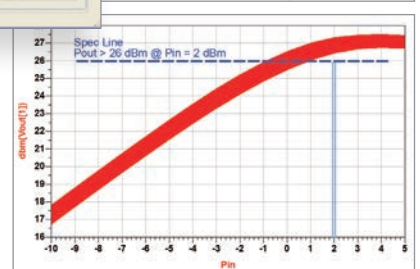
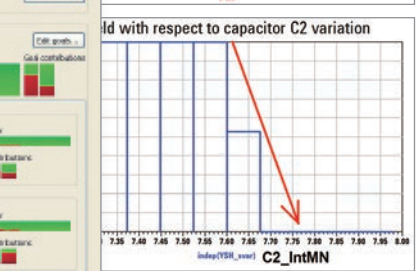
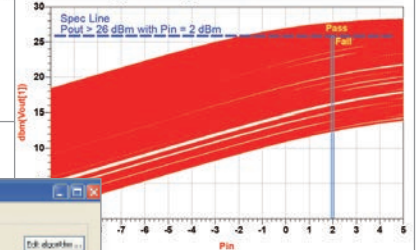

Figure 4.



Eliminate costly layout errors using ADS's advanced LVS and DRC tools

Easy layout in your foundry's specific process

Figure 5

ADS offers a full-featured tool for generating production ready RF layouts. With the largest number of fully endorsed foundry design kits, ADS helps you layout your design in your foundry's specific process. The MMIC Toolbar and layout command line editor, available in all enhanced foundry PDKs, ensures layout editing commands are easily accessible and provide a full suite of layout verification tools.

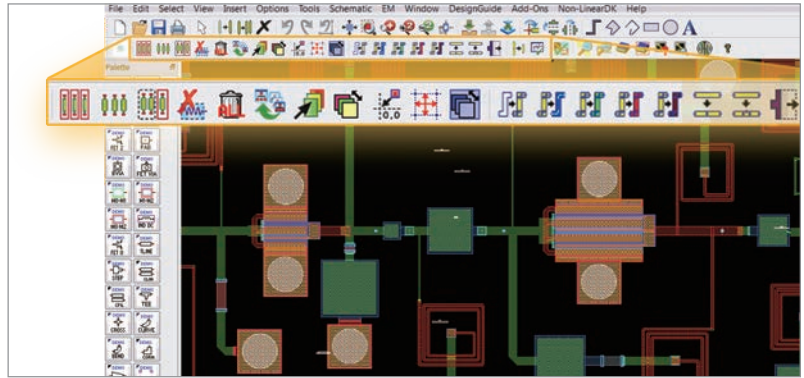

Figure 5.

Catch errors early with ADS desktop DRC and LVS

Figure 6

ADS Desktop design rule check (DRC) enables you to determine whether your physical layout satisfies foundry design rules. Use ADS Desktop layout vs. schematic (LVS) to verify no discrepancies exist between the layout and schematic, to identify missing components and easily find and correct connections in your schematic or layout. Component based LVS on module designs with nested technology finds module-level wiring and pin swap errors. ADS also supports DRC/LVS with Calibre and Assura directly from the ADS cockpit.

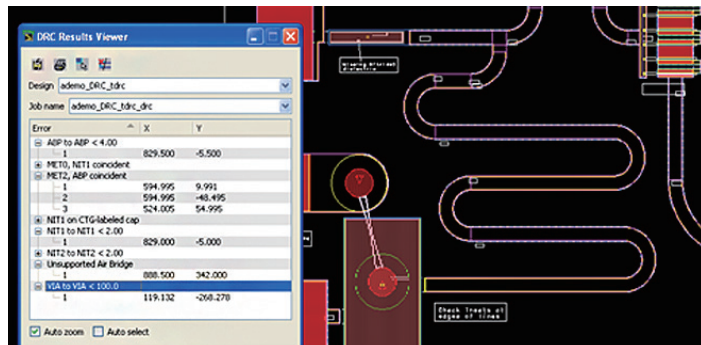

Figure 6.

Integrated electro-thermal solver

Figure 7

ADS provides a full 3-D thermal solver that is tightly integrated with the ADS layout environment and circuit simulators. Simply add the Electro-Thermal controller to the ADS schematic, start a circuit simulation and the integrated thermal solver will run in the background. No more manual export of IC layouts to stand-alone thermal solvers; no more manual import of temperature data into the circuit simulators.

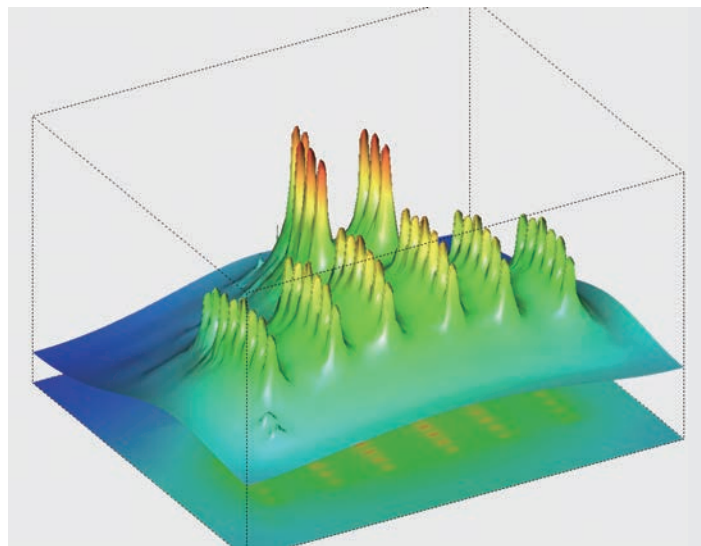

Figure 7.

Innovative multi-technology capability

Figure 8

ADS capabilities enable tradeoffs to be made interactively on the IC, laminate, packaging, and printed circuit boards being designed or co-designed together. Circuits designed in multiple technologies can be combined and simulated at both the circuit and full 3D EM level.

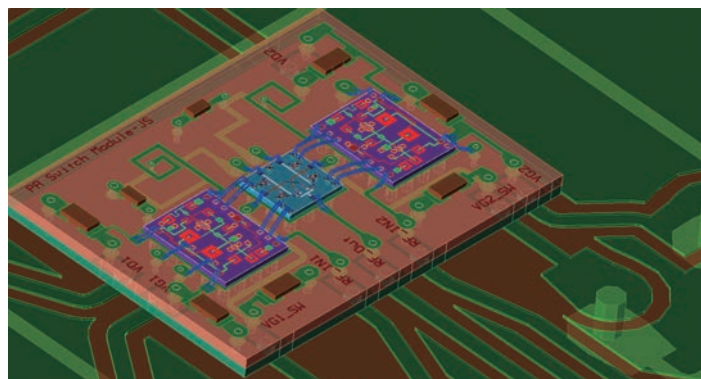

Figure 8.



Keysight offer the broadset selection of EM simulation technologies

Keysight offers multiple EM simulation technologies that are directly integrated into the ADS design flow. This allows seamless co-simulation between schematic, layout and 3D components without leaving the circuit design flow. It is especially convenient for RF module designs where 3D interconnects and packaging must be simulated along with the circuit.

Finite element method (FEM) simulator

The Keysight FEM Simulator is based on the industry-proven Finite Element Method. Unlike 3D planar simulators, this technology can handle arbitrarily shaped 3D structures.

Keysight FEM is integrated with ADS so layout designs do not need to be exported to third-party EM simulators. Keysight FEM is also available in EMPro for simulating 3D models imported from other CAD tools or created natively.

Finite difference time domain (FDTD) simulator

The Keysight FDTD Simulator is based on Finite Difference Time Domain technology. Like FEM, FDTD can handle arbitrarily shaped 3D structures. Whereas FEM produces a large matrix during the solution process, FDTD uses an iterative process to update field values at each time step.

The Keysight FDTD simulator is available in EMPro for simulating 3D models imported from other CAD tools or created natively.

Momentum simulator

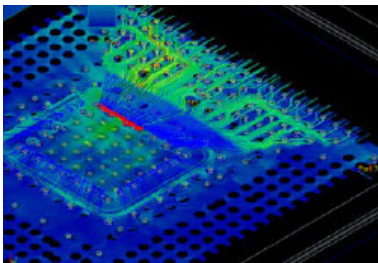

The Keysight Momentum Simulator is the leading 3D planar electromagnetic (EM) simulator used for passive circuit modeling and analysis. It uses frequency-domain Method of Moments (MoM) technology to accurately simulate coupling and parasitic effects of complex multi-layer designs.

Momentum is integrated with ADS, Genesys, and GoldenGate, along with third-party tools from Cadence, Mentor and Zuken.

SIPro: A fraction of full wave 3DEM simulation time

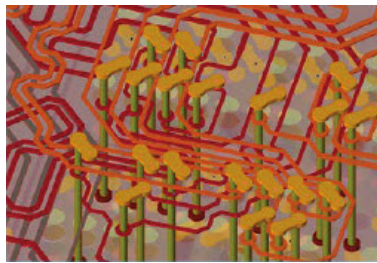

SIPro's composite EM-technology delivers high-frequency accuracy, together with the speed and capacity required for densely-routed cutting-edge PCB design. With Automatic Schematic Generation, extracted EM models flow directly into an ADS transient simulation and ADS channel simulation for complete channel analysis.

PIPro: Accurate, efficient net-driven PI analysis

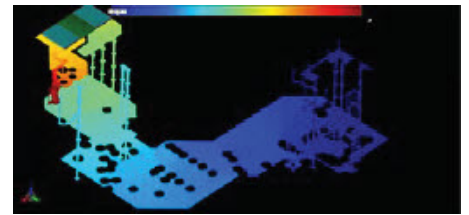

PIPro provides power integrity (PI) analysis of your power distribution network (PDN), including DC IR drop analysis, AC impedance analysis and power plane resonance analysis. PIPro utilizes a common setup and analysis environment within ADS. The EM technologies in PIPro are tuned specifically for PI applications; they are much faster and more efficient than general purpose EM tools.



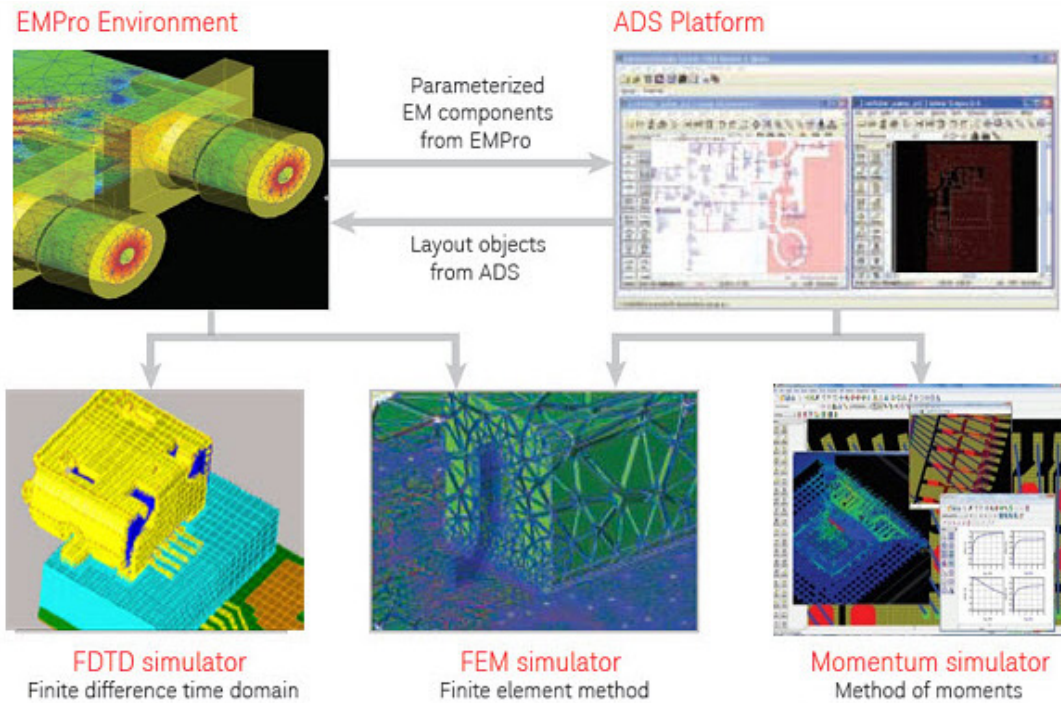

Create Custom 3D Components for Simulation with ADS Layout Designs

Advanced model composer

Momentum and FEM are paired with Keysight's parameterized passive model generation capability, Advanced Model Composer (AMC). AMC enables you to create EM-based custom libraries of 3D models not available in standard simulation libraries. AMC libraries retain the accuracy of EM simulation, but simulate and optimize at the speed of circuit simulation through smart interpolation across the parameterized EM database.

Common database integration with ADS

3D objects in EMPro can now be saved as ADS libraries, containing cells for use directly in ADS. For example, an SMA connector cell created in EMPro will have an emModel view that can be placed directly in an ADS schematic and used for circuit/EM co-sim, and a layout view that can be placed on an ADS layout design (e.g., PCB layout) for full 3D simulations in ADS.

Full 3D drawing environment

EMPro provides the flexibility of drawing arbitrary 3D structures and the convenience of importing existing CAD files. You can create 3D shapes, add material properties, set up simulations, and view results—all within the EMPro environment.

High capacity time and frequency-domain simulation technology

3D structures can be analyzed in EMPro using the same FEM simulator available in ADS. For electrically large problems, such as antennas and some signal integrity analyses, the Finite Difference Time Domain (FDTD) simulator can be used.



Most Complete Solution

Industry-leading tools for your high-frequency and high-speed applications

RF and microwave design flows

Keysight's RF and microwave design and simulation tools provide the most complete solution for creating robust designs with first-pass success and high yields. ADS provides accurate models and powerful simulation technologies for circuit- to system-level designs. Seamlessly integrated circuit and EM simulation tools flow from schematic entry to production and verification. A complete set of the most accurate wireless verification tools in ADS provides true circuit verification to all wireless standards.

RFIC/MMIC design

Figure 13

ADS provides the most complete set of advanced simulation tools, seamlessly integrated into a single environment, that flows from schematic entry to tape-out and packaging. These tools enable you to verify, prior to fabrication, that your RFIC/MMIC meets all specifications in its final package.

All major MMIC foundries offer complete front-to-back ADS PDKs, and also a broad range of SiGe/BiCMOS and CMOS-SOI PDKs are available.

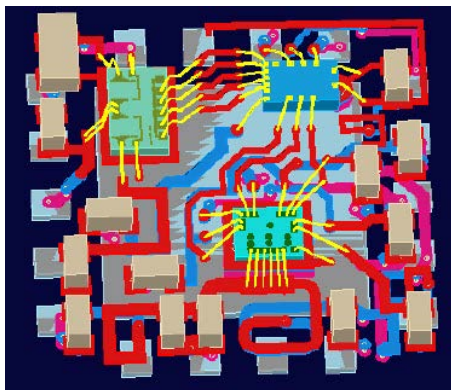

RF module design

Figure 14

As the market and technology leader in RF module design solutions, Keysight EEsof EDA offers the best co-design platform and methodologies for designing RF modules with high confidence. ADS offers designers the best way to reduce risks of design failure due to unexpected parasitics.

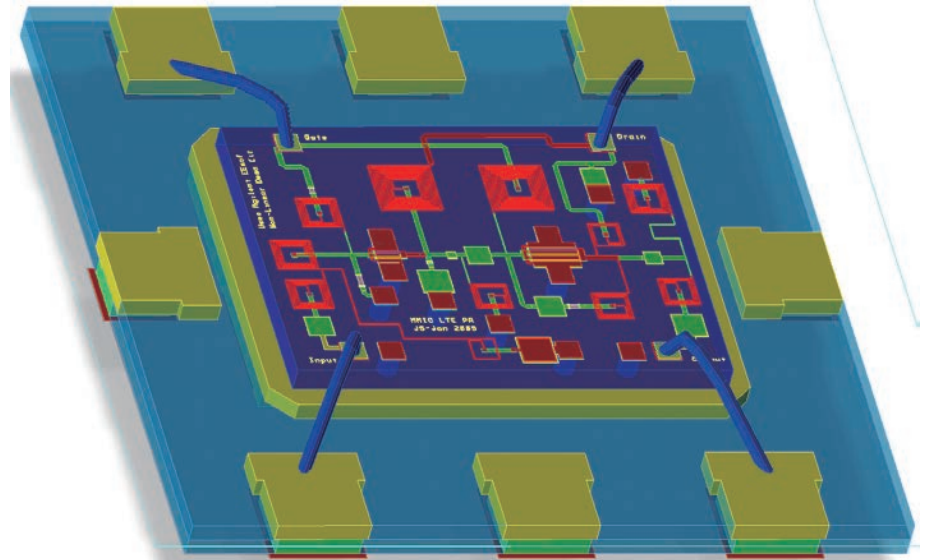

Figure 13. ADS offers a complete set of advanced simulation tools, seamlessly integrated into one single environment, which flows from schematic entry to production and packaging of the MMIC.

Figure 14. ADS offers designers the best solutions and methodologies for confidently designing RF modules.

RF board design

ADS provides proven board design solutions with very accurate models and simulation technologies covering circuit, EM and system level designs. It offers the widest variety of synthesis capabilities to explore alternatives quickly and balance RF performance, parts count and board area, within seconds, while also helping designers assess the cost-effectiveness of making versus buying a commercial component.

Accurate model libraries in ADS support different simulation domains for various applications. Behavioral models (important for initial system-level designs) can be extracted from data sheets, measurement or simulation. ADS's robust layout artwork translators ensure a smooth hand-off to PCB manufacturing for RF board designers.



ADS Provides a Cohesive Workflow for Signal Integrity and Power Integrity Analyses

Facing today's high-speed PCB design challenges

When digital signals reach multigigabit speeds, the unpredictable becomes the norm. Keysight's signal integrity (SI) and power integrity (PI) solutions include EDA design and simulation tools that will help you cut through the challenges of multigigabit digital PCB designs. ADS delivers industry leading time and frequency domain simulation technology, within a cohesive workflow, to help you overcome SI and PI issues and ensure compliant designs.

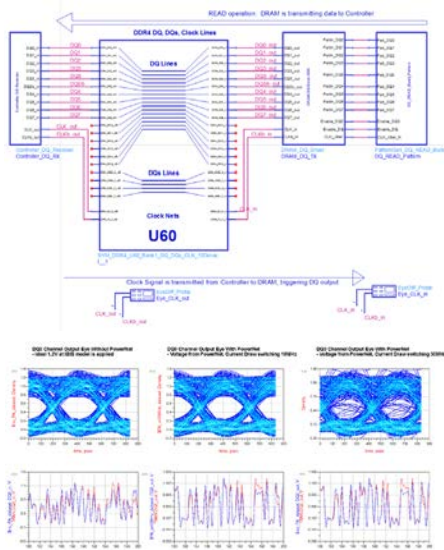

Figure 6. ADS includes industry-leading channel simulation technology.

State-of-the-art channel analysis

With ADS and other tools from Keysight you can:

- Analyze complete chip-to-chip links by modeling at the channel-, circuit- and physical-level of abstraction.
- Import frequency-domain s-parameter models accurately into time-domain circuit and channel simulations, using patented causality and passivity algorithms
- Determine ultra-low BER contours in seconds not days using the statistical and bit-by-bit modes of Channel Simulator
- Import transceiver models in IBIS format (both traditional and AMI) and in netlist format (both unencrypted and encrypted with the Keysight key)
- Generate IBIS AMI models in days not months

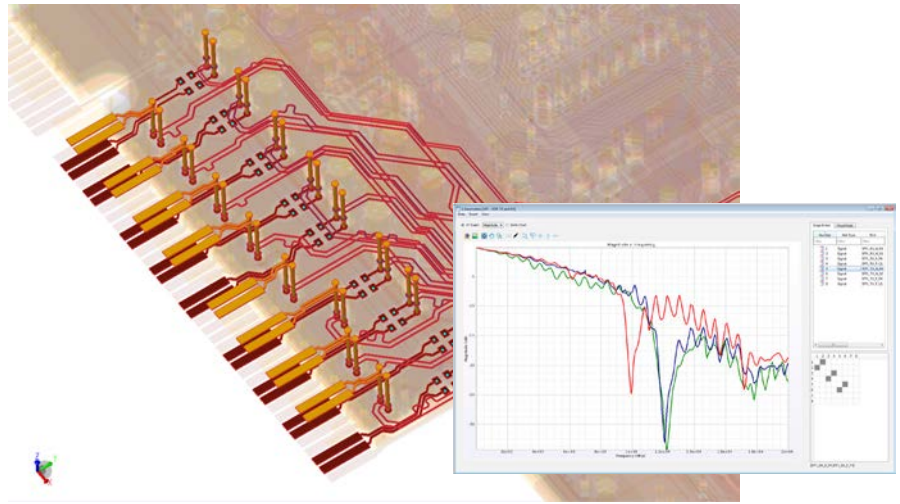

Figure 7. SIPro utilizes composite EM technology to quickly simulate large, complex PCBs and extract accurate models for high data-rate links, all within ADS.

Fast and accurate post-layout EM analysis

ADS includes innovative EM technologies that combine accuracy, speed and capacity required to simulate large, complex PCB designs with multigigabit links. With the SIPro and PIPro EM simulators in ADS you can:

- Import post-layout artwork from enterprise PCB tools from Cadence, Mentor, Zuken, etc. for EM analysis of power integrity and signal integrity issues
- Quickly set up SI and PI analyses in the same environment, using a focused, net-driven use-model
- Extract accurate S-parameter models of high speed links including the effects of signal coupling, non-ideal ground and power planes, and via coupling
- Perform PI analyses to characterize DC IR drop, AC impedance and power plane resonance
- Automatically generate schematic test benches in ADS based on the results of EM-based SI and PI analyses

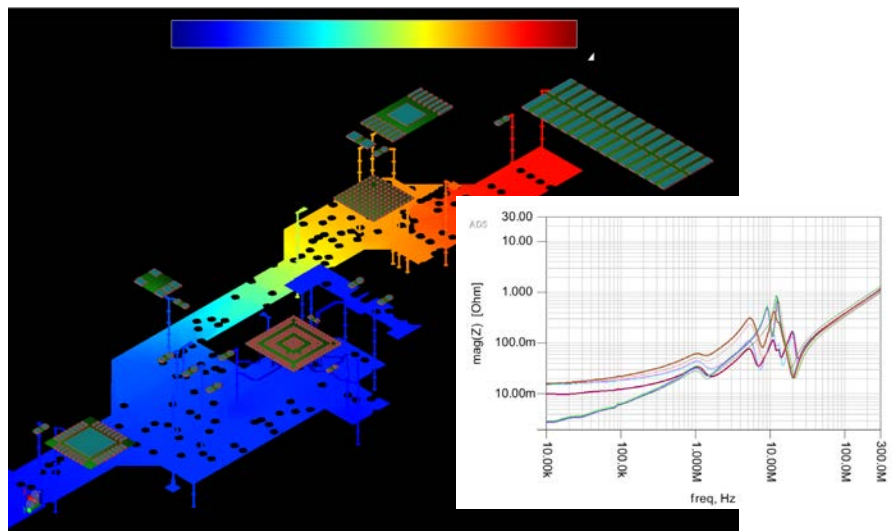

Figure 8. PIPro in ADS provides power integrity analysis of your power distribution network, including DC IR drop analysis, AC impedance analysis and power plane resonance analysis.



Integrated Solutions



Achieve enterprise-wide integration with your design process

Design flow integration—partners for complete success

Keysight EEsof EDA aligns with key EDA vendors and frameworks to provide enhanced solutions that complement your investment. The open and flexible ADS environment ensures that a wide range of design flows are supported. ADS supports design flows based on a Cadence, Mentor or Zuken flow, for example, using industry-standard formats. Our expanding list of partners goes well beyond standard relationships and is part of an ongoing effort to provide best-in-class tools and technology that work in an integrated environment.

ADS board link—Next generation PCB integration solution

ADS Board Link (ABL) provides a bi-directional interface for layouts, schematics and libraries between ADS and enterprise PCB tools. It supports import and export of libraries and technology information (e.g., units, resolution, layers, purposes, and substrates), as well as design data. ABL design transfer between tools is high-fidelity and preserves all data and original objects.

Silicon RFIC schematic interoperability with virtuoso

Figure 16

- Bi-directional schematic interoperability with Virtuoso
- Bring Virtuoso schematics in ADS and simulate RF performance
- Front-end design in ADS and layout implementation in Virtuoso

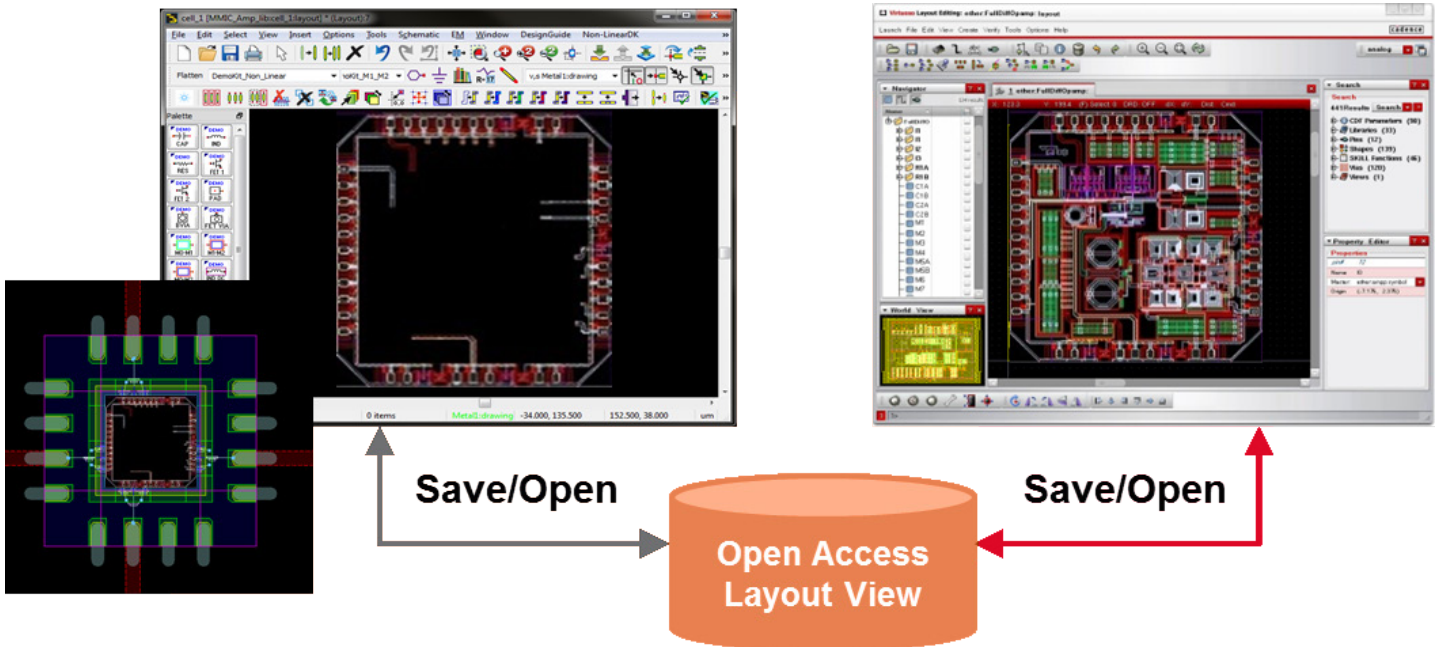

Figure 16. ADS enables users to edit and simulate designs created in Cadence Design System's Virtuoso software.



Seamless Integration with Keysight's EDA Tools and Measurement Instrumentation

X-parameters Enable Rapid Design Optimization

In high-frequency and high-speed designs, X-parameters overcome the system-level inaccuracies that often occur when using overly simplified behavioral models to simulate complex, nonlinear circuits. The use of X-parameters produces highly accurate nonlinear models—from either measurements or simulations—that can be passed through the design chain for quick and accurate simulation and optimization of system-level performance.

Wireless Verification Test Benches (VTB)

Wireless VTBs provide circuit design verification solutions for the newest and most challenging multi-band, wide-bandwidth standards (LTE, LTE-A and 802.11ac) with a dramatically simplified user interface. VTBs and the underlying simulation technology are based on the SystemVue dataflow simulation technology and also allow system architects to develop custom VTBs for use by circuit designers in ADS.

Easy Links to Instrumentation

The integration of ADS with Keysight test instrumentation enables the seamless sharing of signals, measurements, algorithms, and data between the virtual software and physical hardware domains. Designers use this linkage to simulate and evaluate design trade-offs and what-ifs, and then turn the simulated signal into an RF test signal on the bench for hardware test.

Design & simulate with measured or generated X-parameters in ADS

Simulate measured X-parameters in ADS

Proof of concept Bottom-up verification

Measure X-parameters with Keysight's NVNA

indep(PAE_contours_p) (0.000 to 56.000)
 indep(PAE_contours_p2) (0.000 to 56.000)
 indep(Pdel_contours_p) (0.000 to 56.000)
 indep(Pdel_contours_p2) (0.000 to 56.000)

Transducer Power Gain and Com

Transducer Power Gain, dB

Vd [V]

Id

Time (nanoseconds)



Making Your Job Easier with Worldwide Technical Keysight EDA Experts

Keysight is committed to customer satisfaction. We provide the right software, support, and consulting solutions to increase your engineering productivity and advance your long-term success. Whether you are a novice or an experienced user, Keysight EDA's customer support offerings are designed to help you every step of the way.

Significant software updates

Keysight EDA regularly enhances and upgrades its design software. You can expect significant updates that include new features, user interface enhancements, defect fixes, Service Packs, and up-to-date application examples for today's design needs. By using the latest software technology as soon as it becomes available, you can keep your productivity at a maximum.

Worldwide phone support

Keysight EDA regional technical support teams are experienced with all products and supported platforms. Teams are staffed with highly trained engineers; most have extensive design experience and hold advanced engineering degrees. Whether it's a hardware installation question or a complex circuit or system problem, your call is routed to a specialist whose goal is to get you back to work as quickly as possible.

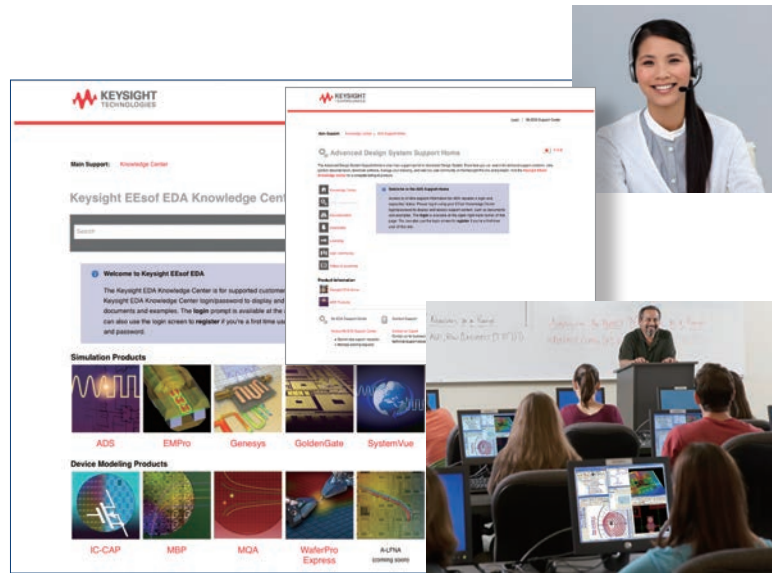

Web-based support

The Keysight EDA support web site, featuring the Knowledge Center, is an around-the-clock resource for designers. The Knowledge Center contains thousands of support documents and hundreds of downloadable examples created by our support and application engineers to supplement the examples and documentation supplied with the software. Software updates to previously released software versions are available for download within the Knowledge Center. The My Knowledge Center feature enables you to submit and manage on-line support cases and any related defect and enhancement requests. The Knowledge Center also includes free recorded Technical Info Sessions and introductory e-Learning Short Courses. You will need a valid support contract to access the Knowledge Center.

Customer education

Increase designer efficiency in setting-up Keysight EDA tools and get a full understanding of how EDA tools can be applied to your own designs. Keysight offers customer education that includes learning weeks, open-enrolment classes, and tailored courses in-house or on-site.

Premium services

Premium services are typically delivered on-site to help your team use Keysight EDA tools in your own IT and design environment, as well as on your application. The Keysight consultant can help designers to configure, use, and customize Keysight EDA tools for a given design purpose. The goal of Premium Services is to contribute to increasing designer productivity and improve time to market by implementing appropriate design flows.

Consulting projects

Get access to external manpower experts to build a turn-key solution fulfilling your requirements and needs to improve your time-to-market. After an in-depth qualification of your needs, Keysight generates a statement of work which includes deliverable content, delivery timelines, and terms and conditions to build a customized solution according to your requirements.



ADS Product Structure and Options Summary

Purchase what you need today; add greater functionality as your needs evolve

ADS can be ordered in value-priced bundles for simplicity and convenience, or in Environment + Element building blocks for greater flexibility.

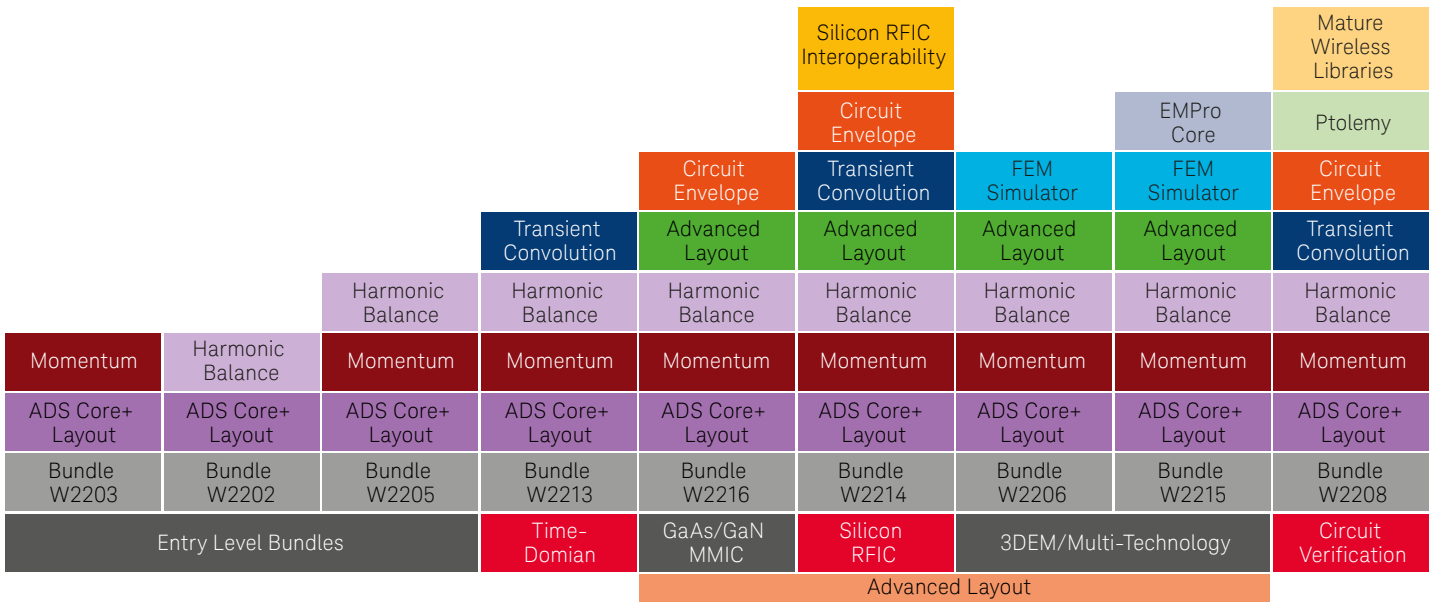

ADS environment + elements

Configure a flexible ADS package that's right for you. Choose an ADS Environment plus any combination of the following individual Element building blocks.

ADS core environment

- W2200 ADS Core
- W2201 ADS Core + Layout

EM simulation elements

- W2341 Momentum G2
- W2343 Momentum Turbo
- W2342 FEM Simulator

Circuit and system simulation elements

- W2300 Harmonic Balance
- W2301 Circuit Envelope
- W2306 Linear Simulator Element
- W2349 Electro-Thermal Simulator
- W2361 Keysight Ptolemy
- W2362 RF Architect & Synthesis

Model and library elements

- W2304 Verilog-AMS Compiler
- W2305 X-Parameter Generator
- W2363 Mature Wireless Library
- W2364 2G/3G Wireless Library
- W2365 Wireless Networking Library
- W2366 Integrated Wireless Library
- W2367 WiMedia Wireless Library
- W2368 3GPP-LTE Wireless Library
- W2369 WVAN Wireless Library
- W2371 Asia DTV Wireless Library



ADS Product Structure and Options Summary (Continued)

Purchase what you need today; add greater functionality as your needs evolve

		SIPro EM	SIPro EM
	PIPro EM	PIPro EM	PIPro EM
	Harmonic balance		Momentum
Transient + Channel Sim	Transient only	Transient + Channel Sim	Transient + Channel Sim
CILD	CILD	CILD	CILD
ADS Core	ADS Core + Layout	ADS Core + Layout	ADS Core + Layout
Bundle W2220BP	Bundle W2222BP	Bundle W2223BP	Bundle W2224BP
Pre-layout design	Pre-layout design	Signal and Power Integrity EM	

High-speed digital design

- W2302 Transient + Channel Simulation
- W2307 Controlled Impedance Line Designer
- W2312 Transient Distributed Computing 8-pack
- W2309 DDR BUS Simulator

Compliance test benches

- W2350 DDR3 Compliance Test Bench
- W2351 DDR4 Compliance Test Bench
- W2352 PCI Express Compliance Test Bench
- W2353 USB Compliance Test Bench
- W2354 100G Compliance Test Bench

Additional recommended products

- W2401 EMPro Core Environment
- W2402 EMPro Core + FEM
- W2404 EMPro Core + FEM + FD-TD



Download your next insight

Keysight software is downloadable expertise. From first simulation through first customer shipment, we deliver the tools your team needs to accelerate from data to information to actionable insight.



- Electronic design automation (EDA) software
- Application software
- Programming environments
- Productivity software

Learn more at
www.keysight.com/find/software

Start with a 30-day free trial.
www.keysight.com/find/free_trials

For more information on Keysight Technologies' products, applications or services, please contact your local Keysight office. The complete list is available at:
www.keysight.com/find/contactus

Americas

Canada	(877) 894 4414
Brazil	55 11 3351 7010
Mexico	001 800 254 2440
United States	(800) 829 4444

Asia Pacific

Australia	1 800 629 485
China	800 810 0189
Hong Kong	800 938 693
India	1 800 11 2626
Japan	0120 (421) 345
Korea	080 769 0800
Malaysia	1 800 888 848
Singapore	1 800 375 8100
Taiwan	0800 047 866
Other AP Countries	(65) 6375 8100

Europe & Middle East

Austria	0800 001122
Belgium	0800 58580
Finland	0800 523252
France	0805 980333
Germany	0800 6270999
Ireland	1800 832700
Israel	1 809 343051
Italy	800 599100
Luxembourg	+32 800 58580
Netherlands	0800 0233200
Russia	8800 5009286
Spain	800 000154
Sweden	0200 882255
Switzerland	0800 805353
	Opt. 1 (DE)
	Opt. 2 (FR)
	Opt. 3 (IT)
United Kingdom	0800 0260637

For other unlisted countries:
www.keysight.com/find/contactus
 (BP-6-20-17)

This information is subject to change without notice.
 © Keysight Technologies, 2013 - 2017
 Published in USA, July 28, 2017
 5988-3326EN
www.keysight.com

Evolving Since 1939

Our unique combination of hardware, software, services, and people can help you reach your next breakthrough. We are unlocking the future of technology.
 From Hewlett-Packard to Agilent to Keysight.

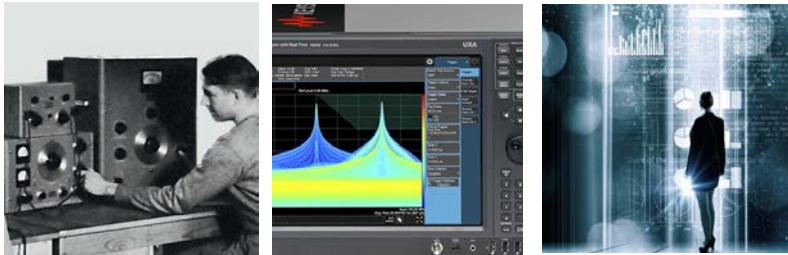

myKeysight

myKeysight
www.keysight.com/find/mykeysight
 A personalized view into the information most relevant to you.

X-parameters is a trademark and registered trademark of Keysight Technologies in the US, EU, JP, and elsewhere. The X-parameters format and underlying equations are open and documented. For more information, visit <http://www.Keysight.com/find/eesof-x-parameters-info>.

PCI-SIG®, PCIe® and the PCI Express® are US registered trademarks and/or service marks of PCI-SIG.

www.keysight.com/find/eesof-online-communities
www.keysight.com/find/ads

