

**electroair**  
ELECTRONIC IGNITION SYSTEMS

***EIS-61000  
Installation Manual***

***Electroair  
5097 Williams Lake Road  
Waterford, MI 48329 U.S.A.  
Ph: 248-674-3433 Fax: 248-674-4231  
Email: sales@electroair.net***

## Table of Contents

REVISION LOG.....	3
IGNITION SYSTEM TECHNICAL DISCUSSION .....	4
IGNITION SYSTEM BASICS.....	4
DUAL MAGNETO SYSTEM REVIEW .....	4
EIS OVERVIEW & PRIMER .....	4
HOW THE ELECTROAIR EIS WORKS .....	5
HIGH RESOLUTION CRANKSHAFT POSITION SENSOR .....	6
ELECTRICAL ENVIRONMENTAL LIMITATIONS.....	6
SPARK PLUG DISCUSSION .....	7
EIS-61000 KIT DESCRIPTION & REQUIREMENTS .....	8
EIS-61000 KIT CONTENTS & OPTIONAL PARTS.....	8
RECEIVING AND ACCEPTANCE CHECKING OF EIS KIT .....	12
OVERVIEW OF SIX CYLINDER SINGLE ENGINE AIRCRAFT EIS INSTALLATION ..	13
INSTALLATION OF EIS-61000.....	14
1. GENERAL OVERVIEW AND RECOMMENDATIONS:.....	14
2. REMOVAL OF OLD IGNITION COMPONENTS:.....	14
3. SET-UP & INSTALLATION OF P/N: EA-9000 OR EA-11000 CSTW KIT:.....	15
4. SET-UP & INSTALLATION OF P/N: EA-10000, EA-12000, OR EA-17000(MTH): .....	19
5. SET-UP & INSTALLATION OF P/N EA-16000 MAG TIMING HOUSING: .....	20
6. SET-UP & INSTALLATION OF P/N EA-19000 MAG TIMING HOUSING: .....	20
7. INSTALLATION OF P/N: EA-21000 EIS CONTROLLER AND P/N: EA-8000 COIL PACK:..	22
8. CONNECTION OF MANIFOLD PRESSURE LINE:.....	24
9. INSTALLATION OF P/N: EA-4000 SPARK PLUG HARNESS:.....	25
10. CONNECTION OF P/N: EA-22000 WIRING HARNESS:.....	29
11. FINAL INSTALLATION STEPS:.....	33
GLOSSARY AND ABBREVIATIONS: .....	34

### Table of Figures

Figure 1: Vacuum Advance Curve.....	5
Figure 2: Picture of Typical installation of CSTW on a Continental 470 engine.....	15
Figure 3: Picture of components that make up the Continental CSTW .....	15
Figure 4: Picture of Typical installation of CSTW on a Lycoming 540 engine. ....	16
Figure 5: Picture of components that make up the Lycoming CSTW S.....	16
Figure 6: Crank Shaft Trigger Wheel Positioning .....	18
Figure 7: Installation of MTH Alignment Pin .....	19
Figure 8: Magneto Drive Gear and Bushing .....	20
Figure 9: EA-19000 Coupler.....	21
Figure 10: Part Number EA-21000; all dimensions in inches. ....	22
Figure 11: Part Number EA-8000 Dimensions .....	23
Figure 12: Spark Plug Wire Component Stack Up. ....	26
Figure 13: Spark Plug Tower Attached to Spark Plug .....	26

Figure 14: Exposed Core of Spark Plug Wire..... 27  
 Figure 15: Terminal Crimped with Central Core Folded ..... 27  
 Figure 16: Inserting Terminal into Boot ..... 27  
 Figure 17: Coil Pack Harness Plug..... 30  
 Figure 18: Wiring diagram for EIS-61000 ..... 32

## Revision Log

Revision	Pages Affected	Date of Revision	Description of Revision	Approved by	Date of Approval
00		08/20/2013	Initial Release		
01		10/30/2013	Add receiving and acceptance checking section.	KP	10/30/2013
02		03/18/2014	Added Lycoming engines	KP	03/28/2014
03		07/16/2014	ECO 1116-0051	KP	07/16/2014
04		08/11/2014	ECO 1116-0066	KP	09/11/2014
05		09/30/2014	ECO 1116-0083	KP	11/17/2014
06		12/15/2014	ECO 1116-0103	KP	12/29/2014
07		01/16/2015	ECO 1116-0109	KP	01/16/2015
08		05/19/2015	ECO 1116-0119	KP	05/19/2015
09		11/03/2015	ECO 1116-0130	KP	11/04/2015
10		10/31/2016	ECO 1019-0027	JMS	02/03/2017
11	1,2,8,9,10,12,13,18,19,20	03/20/2018	ECO 1019-0051	JMS	
12	2-3, 9-11, 25-28	04/26/2018	ECO 1019-0056	JMS	
13	8-11, 13-14, 20-21	05/17/2019	SA09950CH-A	JMS	07/30/2019
14	2,3, 6, 8-14, 22-25, 29-33	12/18/2020	SA09966CH-A: Electronic Ignition Timing Software Project	JMS	

# ***Ignition System Technical Discussion***

## ***Ignition System Basics***

The goal of any ignition system in a four-stroke engine is to start the combustion event so that peak pressure, as a result of combustion, occurs between 10 & 17 degrees after top dead center (ATDC) of the piston travel. This is the generally accepted range and the starting point when talking about ignition systems. From here we work backwards to understand how ignition systems work and what improvements can be made in order to get the most out of the engine.

## ***Dual Magneto System Review***

Traditional aircraft engines use a dual, or two, Magneto Ignition System (MIS). Both magnetos are timed to fire at a preset degree before Top Dead Center (TDC). The two magneto system can be made up of a number of combinations: one impulse coupled magneto and one direct drive magneto; two impulse coupled magnetos; or two magnetos that have some kind of “starting help” device like a shower of sparks or “Slick-Start” system. No matter the combination, the magnetos are responsible for supplying energy to the spark plugs causing a “spark” which is used to ignite a fuel/air mixture inside of the cylinder. For decades, this kind of ignition system has been used quite successfully in aircraft engines. Traditional aircraft ignition systems, however, have remained stagnant in technological development and because of their inherent limitations, hand-cuffed the engine’s ability to deliver peak performance.

Magnetos have two big limitations: one, they produce a relatively small amount of energy; and two, they can only provide that energy (or spark) at a fixed time point in the crank-shaft rotation. Magnetos typically can provide 12,000V through about 5 degrees of crank rotation at the spark plug – less during the start sequence (6,000-8,000 volts during starting). The fixed time point where the spark occurs means that the magneto cannot adjust the spark event to compensate for variances in fuel/air mixtures. As fuel/air mixtures varies (either because of altitude, air density, fuel density, etc.), the time required to develop peak pressure from combustion also changes. If the ignition event timing doesn’t change, then the time where peak pressure occurs MUST change. When this happens, the experience is typically a loss of power.

## ***EIS Overview & Primer***

There are two principle differences between a magneto (MIS) and an electronic ignition system (EIS): one, an EIS is able to deliver much higher energy to the spark plug for a long period of time (70,000V through about 20 degrees of crank rotation) at any RPM; and two, an EIS is able to vary the ignition timing based on changes in the fuel/air mixture.

The very large voltage supplied to the spark plugs comes from using larger coils. The EIS’s ability to deliver that voltage at any RPM is because the output from the EIS is NOT dependent on engine RPM, but the battery supply. The high energy voltage from the EIS allows for a larger gap in the spark plug – insuring a big, long duration, high quality spark. This spark will then have the ability to ignite typically any kind of fuel/air mixture that passes by the spark plug. This is particularly important for hot-start applications, where the fuel/air mixture is corrupt in some way, caused by the high temperature, poor fuel quality, or any combination thereof.

The ability to vary spark timing is also critical. Any good propulsion engineer will pontificate that the way to develop power out of an engine is directly related to the amount of air that can be put

into the combustion chamber (fuel can always be metered). Aircraft engines battle this problem constantly with changing altitude and poorly designed intake systems. A good way of measuring the amount of air in the combustion chamber is by measuring Manifold Absolute Pressure (MAP). This directly correlates to the amount of air available for combustion. The EIS looks at MAP, and adjusts timing based on this to optimize the location (or degree of crank position) for the spark event to occur. The Electroair EIS uses the vacuum advance curve found in Figure 1 for adjusting timing based on MAP. Some top flow induction engines may use a different curve. The EIS also has an option for no additional advance.

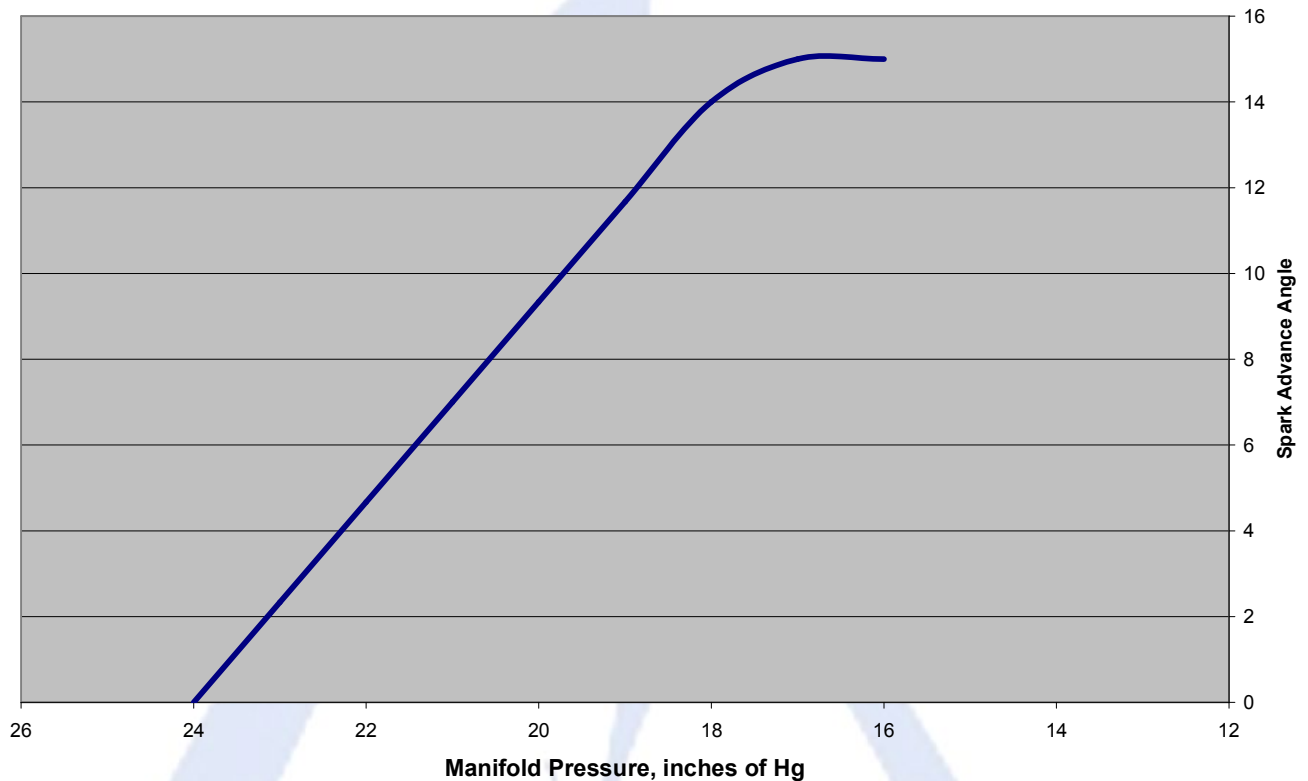

**Figure 1: Vacuum Advance Curve**

### ***How the Electroair EIS Works***

The Electroair EIS fires the spark plugs directly from the coils, not through a distributor. This is accomplished by using multiple coils, each with two spark terminals. The coil terminals are connected to the spark plugs, allowing one cylinder to fire on compression while its companion cylinder fires simultaneously on exhaust. Open spark gaps in the rotor and cap are eliminated, making wear and moisture problems a thing of the past.

What sets the Electroair Electronic Ignition System apart from others is the ability to charge multiple ignition coils at the same time. This increased dwell time means that full spark energy is available over the entire RPM range (up to 9600 RPM at 12 volts). Unlike capacitive discharge systems that only put out one very short spark, the EIS puts out a full energy, long burning spark at the highest and most critical engine speeds. Long burn times assure effective burning of even rich fuel mixtures.

The EIS Controller includes software, which takes the electrical signal from the crankshaft (or mag timing housing) sensor, identifies top-dead center, and then keeps track of the remaining rotation. The EIS determines engine speed and computes the spark advance using the settings pre-set at the factory for the engine as a baseline. Settings from the factory are preset for the engine's certified placarded timing. Additionally, the EIS receives engine manifold pressure information and advances the ignition to compensate for altitude and throttle position.

Beyond the synchronization and firing the plugs at the correct advance angle, the EIS also computes the exact dwell time to produce 6 amps of coil current. Coil charging is dynamically measured, so changes in RPM, battery voltage, or temperature are accounted for on every spark. This corrects any errors that are caused by battery voltage or coil temperature changes and insures maximum spark energy.

### **High Resolution Crankshaft Position Sensor**

The EIS uses a single, high resolution, 60-minus-2 tooth crankshaft position trigger wheel. The trigger wheel is either installed in a timing mechanism that is installed in a mag hole (aka Mag Timing Housing or MTH), or a trigger wheel is installed directly on the crankshaft just behind the prop flange. This affords resolution unheard of in any other electronic ignition available today, offering spark accuracy of ¼ degree of crankshaft rotation. This accuracy means the system is ideal for the most demanding engine applications – *that's why the Electroair EIS has accomplished altitude and speed records in the industry.*

In summary, the Electroair EIS delivers more power because:

- Spark timing is precisely controlled under all conditions, including rapid engine acceleration.
- Longer dwell time and better propagation allows the engine to run better on various mixture settings.
- Accurate spark timing allows sustained engine operation closer to desired peak power timing.
- 100% spark energy up to 9600 RPM on 6-cylinder applications (at 12 volts).
- Longer spark duration!
- Built-in timing program.
- No power draining magnetos to drive.
- No moving parts to wear out or adjust.

### **Electrical Environmental Limitations**

- Radiated Susceptibility – Tested to DO-160G section 20 category T
- Conducted Susceptibility – Tested to DO-160G section 20 category T
- Conducted Emissions – Tested to DO-160G section 21 category B
- Radiated Emissions – Tested to DO-160G section 21 category B
- Lightning – Tested to DO-160G section 22 category A3J3L3



## ***Spark Plug Discussion***

The installation manual specifies the recommended gap for the engine application. This gap will be larger than a typical aircraft plug gap because of the higher energy output from the EIS. This is perfectly acceptable with the EIS ignition charging method, since the high load of the cylinder pressure will allow the voltage to be quite high at the electrode; the gap will keep the plug from seeing an over-voltage situation.

The EIS system uses an *inductive* long duration charging method for the coils. Electroair's experience has drawn us to the following guidelines for spark plug selection:

- Select aircraft spark plugs that will work with the EIS. For Lycoming engines, Electroair has found that the REM37BY (or equivalent) plugs work the best because they are easier to gap to the range required and fit the broadest heat range recommended by the engine manufacturers. (Fine wire plugs are also an excellent choice for Lycoming engines). For Continental Engines requiring long reach spark plugs, off-the-shelf fine wire spark plugs will generally be the easiest to adjust the gap. Electroair strongly recommends verifying the heat range for the engine and using the appropriate plugs.
- Electroair manufactures aviation spark plugs that are gapped at the factory to Electroair's recommended wide gap of 0.036 inches. Electroair manufactures both massive electrode and fine wire spark plugs for various applications. The spark plug information can be found on the Electroair website ([www.electroair.net](http://www.electroair.net)). Electroair spark plugs have been FAA approved for use with Electroair's certified EIS-61000 ignition systems. These plugs are only approved for use with Electroair's EIS. Electroair spark plugs should not be used with magnetos.

## **EIS-61000 Kit Description & Requirements**

### *EIS-61000 System Description & Requirements:*

1. This EIS kit replaces one magneto on the engine of a single engine aircraft
2. 12V or 24V electrical system capable of 0.75A
3. Manifold pressure line
4. Toggle Switch x1 (**NOT PROVIDED IN EIS KIT**)
5. 2 amp circuit breaker or fuse x1 (**NOT PROVIDED IN EIS KIT**)
6. 10 amp circuit breaker or fuse x1 (**NOT PROVIDED IN EIS KIT**)

### *Other items needed:*

1. Basic tools and standard aircraft hardware required for mounting EIS controller and coil pack.
2. Electrical tools for cutting, stripping, and terminating various wiring. Also recommended is a good selection of cable ties for harness routing and tie-off.
3. EIS-61000-4M Kit requires Drive Gear and Bushing from removed magneto. See Set-up & Installation of p/n EA-16000 Mag Timing Housing.
4. EIS-61000-6M requires Coupler from removed magneto. See Set-up & Installation of p/n EA-19000 Mag Timing Housing.

## **EIS-61000 Kit Contents & Optional Parts**

### *EIS-61000-1C Kit Contents:*

1. \_\_\_ EIS Controller (EA-21000) with secondary ground wire.
2. \_\_\_ Coil Pack (EA-8000)
3. \_\_\_ Coil Plate (EA-8010) + Hardware Kit (EA-8000HW)
4. \_\_\_ Crank Shaft Trigger Wheel Kit (EA-11000)
5. \_\_\_ Spark Plug Wires x 3 Bundles (EA-4195)
6. \_\_\_ Spark Plug RHM/RHB Hardware Kit (EA-4180RHMRHB6) or EA-14100-6 Kit
7. \_\_\_ Wiring Harness (EA-22000)
8. \_\_\_ Block Off plate (EA-11030)
9. \_\_\_ USB Drive Containing System Documents (Installation Manual)

### *EIS-61000-1M Kit Contents:*

1. \_\_\_ EIS Controller (EA-21000) with secondary ground wire.
2. \_\_\_ Coil Pack (EA-8000)
3. \_\_\_ Coil Plate (EA-8010) + Hardware Kit (EA-8000HW)
4. \_\_\_ Mag Timing Housing (MTH) (EA-10000) and hardware kit
5. \_\_\_ Spark Plug Wires x 3 Bundles (EA-4195)
6. \_\_\_ Spark Plug RHM/RHB Hardware Kit (EA-4180RHMRHB6) or EA-14100-6 Kit
7. \_\_\_ Wiring Harness (EA-22000)
8. \_\_\_ USB Drive Containing System Documents (Installation Manual)



*EIS-61000-T1C Kit Contents:*

1. \_\_\_ EIS Controller (EA-21000) with secondary ground wire.
2. \_\_\_ Coil Pack (EA-8000)
3. \_\_\_ Coil Plate (EA-8010) + Hardware Kit (EA-8000HW)
4. \_\_\_ Crank Shaft Trigger Wheel Kit (EA-11000)
5. \_\_\_ Spark Plug Wires x 3 Bundles (EA-4196)
6. \_\_\_ Spark Plug RHM/RHB Hardware Kit (EA-4180RHMRHB6) or EA-14100-6 Kit
7. \_\_\_ Wiring Harness (EA-22000T)
8. \_\_\_ Block Off plate (EA-11030)
9. \_\_\_ USB Drive Containing System Documents (Installation Manual)

*EIS-61000-T1M Kit Contents:*

1. \_\_\_ EIS Controller (EA-21000) with secondary ground wire.
2. \_\_\_ Coil Pack (EA-8000)
3. \_\_\_ Coil Plate (EA-8010) + Hardware Kit (EA-8000HW)
4. \_\_\_ Mag Timing Housing (MTH) (EA-10000) and hardware kit
5. \_\_\_ Spark Plug Wires x 3 Bundles (EA-4196)
6. \_\_\_ Spark Plug RHM/RHB Hardware Kit (EA-4180RHMRHB6) or EA-14100-6 Kit
7. \_\_\_ Wiring Harness (EA-22000T)
8. \_\_\_ USB Drive Containing System Documents (Installation Manual)

*EIS-61000-5C Kit Contents:*

1. \_\_\_ EIS Controller (EA-21000) with secondary ground wire.
2. \_\_\_ Coil Pack (EA-8000)
3. \_\_\_ Coil Plate (EA-8010) + Hardware Kit (EA-8000HW)
4. \_\_\_ Crank Shaft Trigger Wheel Kit (EA-9000A)
5. \_\_\_ Spark Plug Wires x 3 Bundles (EA-4195)
6. \_\_\_ Spark Plug RHM/RHB Hardware Kit (EA-4180RHMRHB6) or EA-14100-6 Kit
7. \_\_\_ Wiring Harness (EA-22000)
8. \_\_\_ Block Off plate (EA-9020)
9. \_\_\_ USB Drive Containing System Documents (Installation Manual)

*EIS-61000-T5C Kit Contents:*

1. \_\_\_ EIS Controller (EA-21000) with secondary ground wire.
2. \_\_\_ Coil Pack (EA-8000)
3. \_\_\_ Coil Plate (EA-8010) + Hardware Kit (EA-8000HW)
4. \_\_\_ Crank Shaft Trigger Wheel Kit (EA-9000A)
5. \_\_\_ Spark Plug Wires x 3 Bundles (EA-4196)
6. \_\_\_ Spark Plug RHM/RHB Hardware Kit (EA-4180RHMRHB6) or EA-14100-6 Kit
7. \_\_\_ Wiring Harness (EA-22000T)
8. \_\_\_ Block Off plate (EA-9020)
9. \_\_\_ USB Drive Containing System Documents (Installation Manual)

*EIS-61000-TTT5C Kit Contents:*

1. \_\_\_ EIS Controller (EA-21000) with secondary ground wire.
2. \_\_\_ Coil Pack (EA-8000)
3. \_\_\_ Coil Plate (EA-8010) + Hardware Kit (EA-8000HW)
4. \_\_\_ Crank Shaft Trigger Wheel Kit (EA-9000A)
5. \_\_\_ Spark Plug Wires x 3 Bundles (EA-4196)
6. \_\_\_ Spark Plug RHM/RHB Hardware Kit (EA-4180RHMRHB6) or EA-14100-6 Kit
7. \_\_\_ Wiring Harness (EA-22000T)
8. \_\_\_ Block Off plate (EA-9020)
9. \_\_\_ USB Drive Containing System Documents (Installation Manual)

*EIS-61000-5M Kit Contents:*

1. \_\_\_ EIS Controller (EA-21000) with secondary ground wire.
2. \_\_\_ Coil Pack (EA-8000)
3. \_\_\_ Coil Plate (EA-8010) + Hardware Kit (EA-8000HW)
4. \_\_\_ Mag Timing Housing (EA-12000) and hardware kit
5. \_\_\_ Spark Plug Wires x 3 Bundles (EA-4195)
6. \_\_\_ Spark Plug RHM/RHB Hardware Kit (EA-4180RHMRHB6) or EA-14100-6 Kit
7. \_\_\_ Wiring Harness (EA-22000)
8. \_\_\_ USB Drive Containing System Documents (Installation Manual)

*EIS-61000-T5M Kit Contents:*

1. \_\_\_ EIS Controller (EA-21000) with secondary ground wire.
2. \_\_\_ Coil Pack (EA-8000)
3. \_\_\_ Coil Plate (EA-8010) + Hardware Kit (EA-8000HW)
4. \_\_\_ Mag Timing Housing (EA-12000) and hardware kit
5. \_\_\_ Spark Plug Wires x 3 Bundles (EA-4196)
6. \_\_\_ Spark Plug RHM/RHB Hardware Kit (EA-4180RHMRHB6) or EA-14100-6 Kit
7. \_\_\_ Wiring Harness (EA-22000T)
8. \_\_\_ USB Drive Containing System Documents (Installation Manual)

*EIS-61000-TTT5M Kit Contents:*

1. \_\_\_ EIS Controller (EA-21000) with secondary ground wire.
2. \_\_\_ Coil Pack (EA-8000)
3. \_\_\_ Coil Plate (EA-8010) + Hardware Kit (EA-8000HW)
4. \_\_\_ Mag Timing Housing (EA-12000) and hardware kit
5. \_\_\_ Spark Plug Wires x 3 Bundles (EA-4196)
6. \_\_\_ Spark Plug RHM/RHB Hardware Kit (EA-4180RHMRHB6) or EA-14100-6 Kit
7. \_\_\_ Wiring Harness (EA-22000T)
8. \_\_\_ USB Drive Containing System Documents (Installation Manual)

*EIS-61000-4M Kit Contents:*

1. \_\_\_ EIS Controller (EA-21000) with secondary ground wire.
2. \_\_\_ Coil Pack (EA-8000)
3. \_\_\_ Coil Plate (EA-8010) + Hardware Kit (EA-8000HW)
4. \_\_\_ Mag Timing Housing (EA-16000) and hardware kit
5. \_\_\_ Spark Plug Wires x 3 Bundles (EA-4195)
6. \_\_\_ Spark Plug RHM/RHB Hardware Kit (EA-4180RHMRHB6) or EA-14100-6 Kit
7. \_\_\_ Wiring Harness (EA-22000)
8. \_\_\_ USB Drive Containing System Documents (Installation Manual)

*EIS-61000-6M Kit Contents:*

1. \_\_\_ EIS Controller (EA-21000) with secondary ground wire.
2. \_\_\_ Coil Pack (EA-8000)
3. \_\_\_ Coil Plate (EA-8010) + Hardware Kit (EA-8000HW)
4. \_\_\_ Mag Timing Housing (EA-19000) and hardware kit
5. \_\_\_ Spark Plug Wires x 3 Bundles (EA-4195)
6. \_\_\_ Spark Plug RHM/RHB Hardware Kit (EA-4180RHMRHB6) or EA-14100-6 Kit
7. \_\_\_ Wiring Harness (EA-22000)
8. \_\_\_ USB Drive Containing System Documents (Installation Manual)

*EIS-61000-T6M Kit Contents:*

1. \_\_\_ EIS Controller (EA-21000) with secondary ground wire.
2. \_\_\_ Coil Pack (EA-8000)
3. \_\_\_ Coil Plate (EA-8010) + Hardware Kit (EA-8000HW)
4. \_\_\_ Mag Timing Housing (EA-19000) and hardware kit
5. \_\_\_ Spark Plug Wires x 3 Bundles (EA-4196)
6. \_\_\_ Spark Plug RHM/RHB Hardware Kit (EA-4180RHMRHB6) or EA-14100-6 Kit
7. \_\_\_ Wiring Harness (EA-22000T)
8. \_\_\_ USB Drive Containing System Documents (Installation Manual)

*EIS-61000-7M Kit Contents:*

1. \_\_\_ EIS Controller (EA-21000) with secondary ground wire.
2. \_\_\_ Coil Pack (EA-8000)
3. \_\_\_ Coil Plate (EA-8010) + Hardware Kit (EA-8000HW)
4. \_\_\_ Mag Timing Housing (EA-17000) and hardware kit
5. \_\_\_ Spark Plug Wires x 3 Bundles (EA-4195)
6. \_\_\_ Spark Plug RHM/RHB Hardware Kit (EA-4180RHMRHB6) or EA-14100-6 Kit
7. \_\_\_ Wiring Harness (EA-22000)
8. \_\_\_ USB Drive Containing System Documents (Installation Manual)

## ***Receiving and Acceptance Checking of EIS Kit***

1. Review the packaging before acceptance from the freight carrier. If damaged, refuse the package.
2. Open the package.
3. Review the contents of the package to the content listing on the package.
4. Are all of the materials there?
  - a. Yes, proceed to step 5.
  - b. No, contact the factory. Have the serial number of the kit available when contacting. (factory 248-674-3433 or [sales@electroair.net](mailto:sales@electroair.net))
5. Inspect the controller for damage to the aluminum housing. Verify that the placarded controller timing matched the placarded engine timing. If not contact Electroair 248-674-3433 or [sales@electroair.net](mailto:sales@electroair.net).
6. Inspect the wires for nicks and cracks.
7. Inspect the coil pack and plate for external damage.
8. Inspect the CSTW/MTH for external damage.
9. Are all materials acceptable?
  - a. Yes, proceed with installation.
  - b. No, contact the factory. Have the serial number of the kit available when contacting. (factory 248-674-3433 or [sales@electroair.net](mailto:sales@electroair.net))

If possible, store parts in original packaging when not in use. If not possible, wrap parts in cushioning material and place in one location. Review above prior to reinstallation.

For latest copies of documentation, refer to [www.electroair.net](http://www.electroair.net).

- AML
- AFMS
- ICA
- Installation Manual
- STC
- Trouble Shooting Instructions

## ***Overview of Six Cylinder Single Engine Aircraft EIS Installation***

Thank you for purchasing an Electroair Ignition System for your aircraft. Electroair is confident that you will be happy with the performance of the EIS on your aircraft. The next several pages will take provide a step-by-step process of installing the EIS on the aircraft. Electroair hopes you will enjoy the experience and that this manual will provide clear direction and guidance through this process. This manual will cover the following general installation steps:

1. General overview and recommendations
2. Removal of old ignition components
3. Set-up & installation of p/n: EA-11000 or EA-9000 CSTW kit, if applicable
4. Set-up & installation of p/n: EA-10000, EA-12000, or EA-17000 MTH kit, if applicable
5. Set-up & installation of p/n: EA-16000 MTH kit, if applicable
6. Set-up & installation of p/n: EA-19000 MTH kit, if applicable
7. Installation of p/n: EA-21000 EIS Controller and p/n: EA-8000 Coil Pack
8. Connection of Manifold Pressure Line
9. Installation of p/n: EA-4000 Spark Plug Harness
10. Connection of p/n: EA-22000(T) Wiring Harness
11. Final installation steps

Electroair strongly recommends that reading through this entire installation procedure before installing the EIS on the aircraft. Make sure that any questions are answered before the actual installation. Also, make sure any extra components needed, e.g. cable ties, circuit breakers, switch terminations, etc., are available. Removal of old components and installation of new components is to be completed in compliance with CFR Title 14 Part 43, as applicable, and any Airframe or Engine Manufacturer Maintenance Procedures, as applicable. Above all else, use good common sense and professional judgment. An electronic ignition system is a high voltage device. If an EIS is improperly installed or misfired, severe damage could be caused to the EIS, aircraft, or installer including bodily injury or death.

Please contact Electroair with any questions during this installation process. Good luck and happy flying!!

Electroair



# ***Installation of EIS-61000***

## **1. General Overview and Recommendations:**

- a. Read through the entire installation instructions before beginning the installation to make sure each step is understood. CALL ELECTROAIR (248-674-3433) if there are any questions or if any items that are unclear.
- b. The installation of the EIS could take between 9-20 hours, depending on your skills for working on the engine & ignition systems. It is always advisable to seek help from a professional mechanic. Installation times can vary widely and are very aircraft and installer dependent!
- c. This ignition system is designed to be installed by aviation professionals with the appropriate ratings and experience for maintaining General Aviation aircraft.
- d. If pre-existing components on the airframe are in the way of or are near the installation locations of the EIS components, Electroair Acquisition Corp. recommends that following the procedures listed below. **NOTE:** When making ANY changes or modifications to the aircraft or aircraft components, make sure all practices are in accordance with CFR Title 14 Part 43.
  - i. If the preexisting components can be relocated, move the components to an acceptable location on the airframe where they will not come into contact with the EIS component(s).
  - ii. If the preexisting components must come into contact or near the EIS component(s), make sure to protect all components from each other. This could mean, but not limited to, adding anti-chafing material, additional component securing devices, heat shielding material, etc.
- e. Always use good safety and work practices. Use appropriate safety equipment (safety glasses, etc.) and precautions. The EIS is a high voltage system and if installed or tested incorrectly can cause substantial damage to both the system and YOU!

## **2. Removal of Old Ignition Components:**

- a. **Remove cowling. Verify that Master Switch is off and battery is disconnected.**
- b. **IMPORTANT:** Determine which magneto will be replaced, either the right or the left.
- c. **Remove** ignition harness from the spark plugs associated with the magneto that is being replaced.
- d. **Disconnect** the P-lead that is installed on the magneto that is being replaced from the ignition switch.
- e. **Remove** the selected magneto; retain the clips holding the magneto in place. **If removing a pressurized magneto, ensure that the pressure line is properly plugged.**
- f. **Save** the magneto clips if installing the MTH. Clips will be re-used.
- g. **Remove** the selected magneto's ignition harness and selected magneto's P-lead from ignition switch.
- h. **Remove** the magneto's P-lead entirely from the aircraft system – a replacement P-lead wire is provided in the EIS wiring harness.
- i. **Remove** spark plugs and replace with new plugs (recommended), or re-gap the existing plugs to the specified gap of 0.028-0.036 inches.
- j. If using MTH p/n EA-16000, **Remove and save** drive gear and bushing from the magneto being replaced. See Figure 8 for picture of drive gear and bushing.
- k. If using MTH p/n EA-19000, **Remove and save** the coupler from the magneto being replaced. See Figure 9 for picture of the coupler.



### 3. Set-up & Installation of p/n: EA-9000 or EA-11000 CSTW kit:

- a. Retrieve p/n: EA-9000 or EA-11000 CSTW kit bag.
- b. **Install** the mag hole cover supplied in the EA-9000 or the EA-11000 kit.
- c. Access is needed to the crankshaft between the engine case and the prop flange. Remove those components necessary to accomplish this.
- d. Clean the crank area just in front of the crank shaft seal. **CAUTION:** The exposed portion of the crank shaft is tin plated. Electroair Acquisition Corp. recommends using a liquid cleaner/degreaser. An abrasive (like sand paper or scotch-brite) will remove the plating.
- e. **Continental Installations (CSTW/Magnetic Pick-Up Bracket Installation)**
  - i. Temporarily fit the CSTW on the crank with the trigger wheel (timing teeth) toward the engine case. Slide the CSTW toward the prop flange. (Silver side of the CSTW to the engine case, black side to the propeller).



**Figure 2: Picture of Typical installation of CSTW on a Continental 470 engine. Note: Minimum clearance of 0.650 inches required between front of case and rear of prop studs; contact Electroair Tech Support for additional information.**

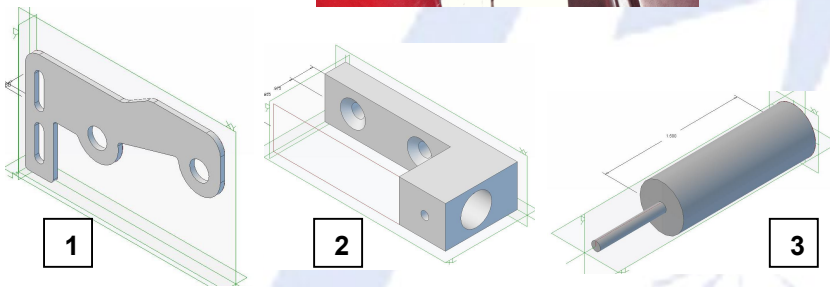

**Figure 3: Picture of components that make up the Continental CSTW Sensor Bracket; 1. Pick-Up Bracket (rear-mount alternator; front-mount alternator bracket not shown); 2. Pick-Up Holder; 3. Magnetic Pick-up (Magnetic Sensor)**

- ii. Temporarily install the pick-up bracket: Remove the first two, forward, top case nuts and install the bracket/pick-up holder assembly (see Figure 3); verify that the center seam of the engine case aligns with the center of the large hole in the Sensor Holder, adjust spacing with flat washers under the bracket if necessary; replace the nuts to a finger tight fit.
- iii. Position the CSTW so that the magnetic pick-up (sensor) would be oriented correctly on the timing teeth on the CSTW.
- iv. Rotate the CSTW and align the hole in the CSTW with the alignment tool (dowel/rievet assembly). Complete this by inserting the shaft of the pop rivet through the hole in the wood dowel. Place this assembly into the hole of the pick-up holder (dowel/rievet assembly simulates a magnetic pick-up and pop rivet will serve as an alignment pin). Hold it in place.
- v. While holding these pieces together, mark the position of the Pick-Up Holder on to the pick-up bracket.

- vi. After marking the location of the Pick-Up holder, remove the Pick-Up Bracket and Holder assembly; tighten the fasteners so the pick-up holder is in the correct location on the bracket.
  - vii. Re-attach completed magnetic Pick-Up Bracket/Holder assembly to the engine using the previous through bolts or nuts and tighten to the recommend torque values found in the engine overhaul specifications.
- f. **Lycoming Installations (Magnetic Pick-Up Bracket Installation)**
- i. Temporarily fit the CSTW on the crank with the trigger wheel (timing teeth) toward the engine case. Slide the CSTW toward the prop flange. (Silver side of the CSTW to the engine case, black side to the propeller)

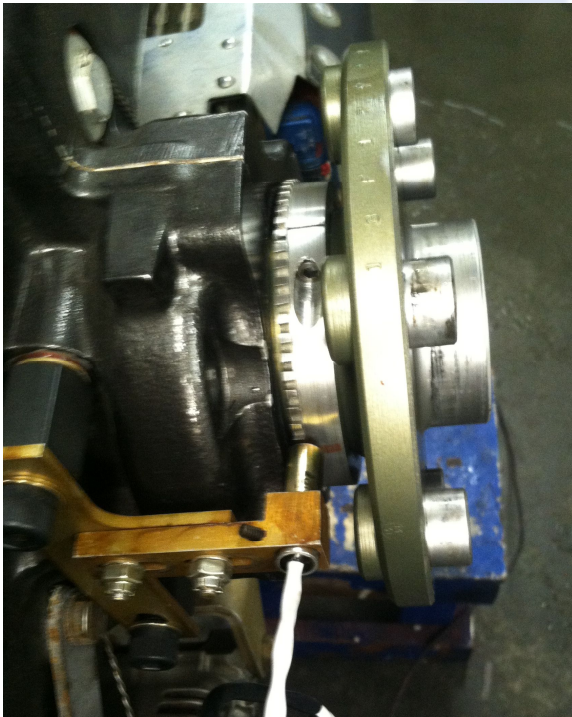

**Figure 4: Picture of Typical installation of CSTW on a Lycoming 540 engine. Picture shows orientation of trigger wheel and typical bracket location. Please contact Electroair Tech Support if there are any questions about the assembly.**

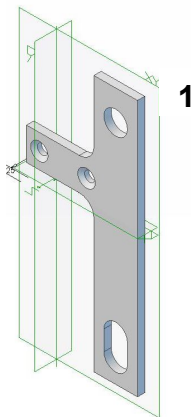

1

**Figure 5: Picture of components that make up the Lycoming CSTW Sensor Bracket; 1. Pick-Up Bracket; 2. Pick-Up Holder; 3. Magnetic Pick-up (Magnetic Sensor); hardware is not shown for clarity.**

2

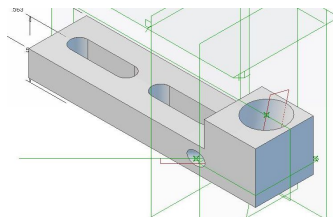

3

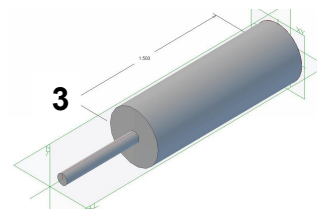

- ii. Temporarily install the pick-up Bracket Stand-Offs: Remove the forward journal bolt nuts and install the Bracket Stand-Offs supplied in the CSTW kit (see Figure 4);

- torque Stand-Offs to the same value as the nuts that were removed (300 in-lbs, per Lycoming manual).
- iii. Install Pick-Up Bracket using supplied socket head cap screws; torque screws to a value of 300 in-lbs. NOTE: Bracket may have to be removed to be able to install Pick-Up Holder; once bracket is in place and will not be removed, safety wire the cap screws in place.
  - iv. Temporarily install the Sensor Holder on to the Pick-Up Bracket; leave the nuts loose enough so the Sensor Holder can slide back and forth to obtain the correct position.
  - v. Position the CSTW so that the magnetic pick-up (sensor) would be oriented correctly on the timing teeth on the CSTW.
  - vi. Rotate the CSTW and align the hole in the CSTW with the alignment tool (dowel/rievet assembly). Complete this by inserting the shaft of the pop rivet through the hole in the wood dowel. Place this assembly into the hole of the Pick-Up Holder (dowel/rievet assembly simulates a magnetic pick-up and pop rivet will serve as an alignment pin). Hold it in place.
  - vii. While holding these pieces together, mark the position of the Pick-Up Holder on to the Pick-Up Bracket.
  - viii. After marking the location of the Pick-Up Holder, remove the Pick-Up Bracket and Holder assembly; tighten the fasteners so the Pick-Up Holder is in the correct location on the bracket.
  - ix. Re-attach completed magnetic Pick-Up Bracket/Holder assembly to the engine (install bracket assembly on stand-offs); tighten fasteners to the recommended torque values found in the engine overhaul specifications. **Verify that screws holding bracket to stand-offs have been secured using safety wire.**
- g. **Verify that the master switch is off and battery is disconnected. Verify that the mag switch is off and the mag is properly grounded.**



## **ALWAYS STAY OUT OF THE PROPELLER ARC!**

- h. Rotate the engine until number one cylinder is on Top Dead Center (TDC).
- i. Loosen the CSTW and rotate it until the alignment pin (remember the dowel/pop rivet assembly which is still in the pick-up holder) lines up with the hole in the CSTW. The alignment pin can be used to lock the CSTW position. **This should place the trailing edge of the 11<sup>th</sup> tooth past the two missing teeth** directly under the center of where the magnetic pick-up will go. Reference Figure 6 for sensor alignment and positioning. If this is not correct, return to step “d” or “e” (depending on your engine make) and repeat.

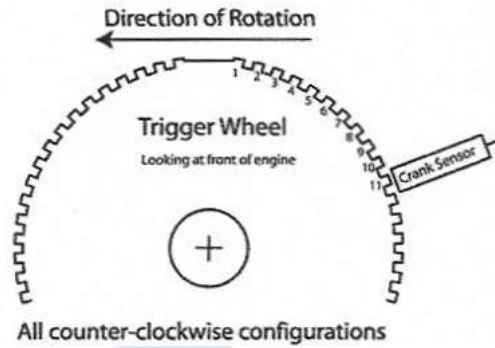

**Figure 6: Crank Shaft Trigger Wheel Positioning**

- j. Remove CSTW and apply Loctite (Loctite # 242) to the crank shaft side of CSTW and to the two socket head cap screws.
- k. Carefully replace the collar to the crank shaft and line up using the alignment pin as described in 3h. The alignment pin will help hold the CSTW in position.
- l. Torque the cap screws on the CSTW to 20-25 inch-pounds. Be very careful that the gap between the two collar halves remains equal on both sides. If this gap is not held constant, the CSTW will not be concentric around the crank shaft and the timing pick-up will not function properly. **CAUTION:** Do not tighten the CSTW screws to the point that there is no gap between the collar halves. This means that the screws are over torqued, the aluminum collar stretched, and the CSTW will need replacing.
- m. Route the magnetic pick-up wire harness up the center of the engine case and then on top of the engine. Use cable ties as necessary to secure routing. **Do not route near spark plug wires. Do not tie wrap to ignition leads.**
- n. Remove the dowel/pop rivet assembly from the pick-up holder and install the magnetic pick-up. Using a feeler gage or equivalent, set the gap to 0.024 inches. Once the gap between the timing teeth and the magnetic pick-up is set, apply a thin coating of Loctite #242 to the set-screws, insert them into the pick-up holder, and tighten them down. **NOTE:** The tip of the sensor is a "Chisel Point"; this chisel must be positioned so that it is perpendicular to the plane of the trigger, or so that the chisel is parallel to the line of flight.



#### 4. Set-up & Installation of p/n: EA-10000, EA-12000, or EA-17000(MTH):



**Caution: Disconnect the battery and ALL ignition leads before starting this procedure.**

- a. **VERIFY MASTER SWITCH IS OFF AND BATTERY IS DISCONNECTED.**
- b. Rotate the engine to Top Dead Center (TDC) for cylinder # 1. This done by rotating the prop ***in the direction of proper engine rotation*** until TDC is reached. Verify TDC using the timing marks found on the engine. Typically, the first set is on the fly wheel and the starter; they will line up at TDC; the second set may be another mark on the back-side of fly wheel which lines up with the engine case seam (top or bottom) at TDC. A TIME-RITE™ may also be used. If any of these indications are not correct, repeat this step until they are. ***Always rotate the engine in the direction that it rotates during operation.***
- c. Retrieve the MTH and the MTH Hardware Kit.
- d. Clean magneto pad on the engine. Install provided gasket from hardware kit onto the MTH.
- e. Retrieve the alignment pin from the hardware kit.

If the removed magneto was located between the propeller and the accessory case, use timing hole CW. If the removed magneto was located between the accessory case and the firewall, use timing hole CC. See Figure 7.

Holding the MTH, insert the alignment pin into the appropriate timing cover hole on the back of the MTH (supplied with hardware kit). Slowly turn the gear on the front of the unit until the alignment pin drops into a hole in the internal gear inside the MTH. The MTH is now set to Top Dead Center (TDC) and the MTH shaft should not be able to spin.



Figure 7: Installation of MTH Alignment Pin

- f. Install the MTH into the proper magneto hole. Secure the MTH using the mag holding clips referenced in step 2f and secure per engine manufacturer specifications.
- g. **If required**, re-index the magneto drive gear to facilitate clearance for the magnetic sensor and the housing. Follow the engine manufacturer's instructions for re-indexing the drive gear.
- h. **REMOVE THE ALIGNMENT PIN.** Failure to remove the MTH Alignment Pin may cause damage to the MTH, the engine, or both.
- i. The MTH (p/n: EA-10000, EA-12000, or EA-17000) is now installed and timed properly.

#### 5. Set-up & Installation of p/n EA-16000 Mag Timing Housing:

- a. Retrieve p/n: EA-16000 MTH and the EA-16000 MTH Hardware Kit.
- b. Insert woodruff keys into slots on MTH. Insert the faux coupler onto the shaft and align with the woodruff keys.
- c. Place the drive gear obtained from the removed magneto onto the coupler. Then insert the bushing obtained from the magneto onto the shaft and drive gear while aligning with woodruff key. See Figure 8 for picture of drive gear and bushing.

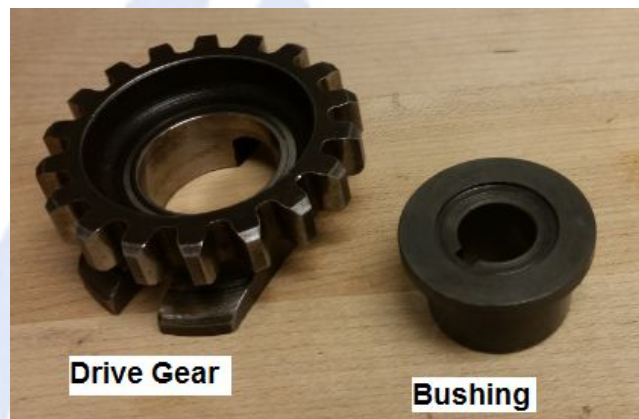

Figure 8: Magneto Drive Gear and Bushing

- d. Place washer and castle nut onto the shaft and tighten to 160-190 in-lbs. Install the cotter pin through the castle nut and MTH shaft with the long end of the cotter pin facing away from the MTH. Bend the long end of the cotter pin over the end of the shaft and the short end along the side of the nut.

#### 6. Set-up & Installation of p/n EA-19000 Mag Timing Housing:

- a. Retrieve coupler from the magneto being replaced. See Figure 9.
- b. Retrieve p/n: EA-19000 MTH and the EA-19000 MTH Hardware Kit.
- c. Insert 404 woodruff key into the slot on the shaft of the EA-19000 MTH. Insert the coupler onto the shaft and align with the woodruff key.
- d. Place washer and castle nut onto the shaft and tighten to 160-190 in-lbs. Install the cotter pin through the castle nut and MTH shaft with the long end of the cotter pin facing away from the MTH. Bend the long end of the cotter pin over the end of the shaft and the short end along the side of the nut.



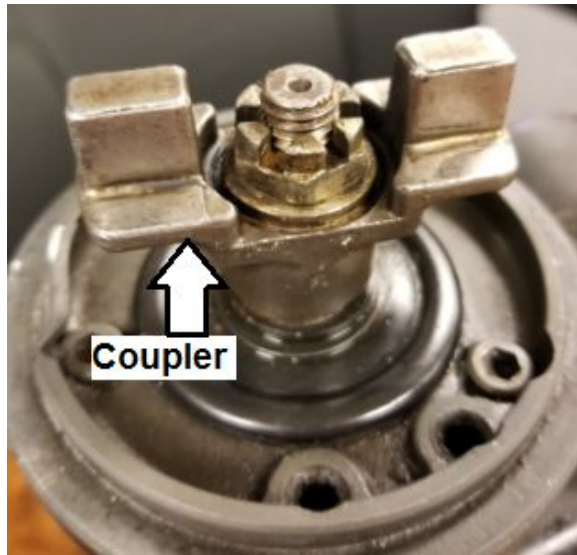

Figure 9: EA-19000 Coupler



**Caution: Disconnect the battery and ALL ignition leads before starting this procedure.**

- e. **VERIFY MASTER SWITCH IS OFF AND BATTERY IS DISCONNECTED.**
- f. Rotate the engine to Top Dead Center (TDC) for cylinder # 1. This done by rotating the prop ***in the direction of proper engine rotation*** until TDC is reached. Verify TDC using the timing marks found on the engine. Typically, the first set is on the fly wheel and the starter; they will line up at TDC; the second set may be another mark on the back-side of fly wheel which lines up with the engine case seam (top or bottom) at TDC. A TIME-RITE™ may also be used. If any of these indications are not correct, repeat this step until they are. ***Always rotate the engine in the direction that it rotates during operation.***
- g. Clean magneto pad on the engine. Install provided gasket from hardware kit on p/n: EA-19000.
- h. Retrieve the alignment pin from the hardware kit.

If the removed magneto was located between the propeller and the accessory case, use timing hole CW. If the removed magneto was located between the accessory case and the firewall, use timing hole CC. See Figure 7.

Holding the MTH, insert the alignment pin into the appropriate timing cover hole on the back of the MTH (supplied with hardware kit). Slowly turn the gear on the front of the unit until the alignment pin drops into a hole in the internal gear inside the MTH. The MTH is now set to Top Dead Center (TDC) and the MTH shaft should not be able to spin.
- i. Install the MTH into the proper magneto hole. Secure the MTH using the mag holding clips referenced in step 2f and secure per engine manufacturer specifications.
- j. **If required**, re-index the magneto drive gear to facilitate clearance for the magnetic sensor and the housing. Follow the engine manufacturer's instructions for re-indexing the drive gear.
- k. **REMOVE THE ALIGNMENT PIN.** Failure to remove the MTH Alignment Pin may cause damage to the MTH, the engine, or both.
- l. P/N EA-19000 is now installed and timed properly.

## 7. Installation of p/n: EA-21000 EIS Controller and p/n: EA-8000 Coil Pack:

- a. **EA-21000 Installation:** Install p/n EA-21000 EIS Controller where temperatures will not exceed 150°F. Because of this, Electroair requires that the EIS Controller be mounted on the cockpit side of the firewall with the shortest practical distance from the coil pack for the wiring harness runs. Refer to Figure 10 for controller dimensions.
- b. Use standard hardware to attach secondary ground wire from the exposed metal mounting hole on the EA-20000 to a competent airframe ground. A standard #6 screw will fit in the mounting hole.

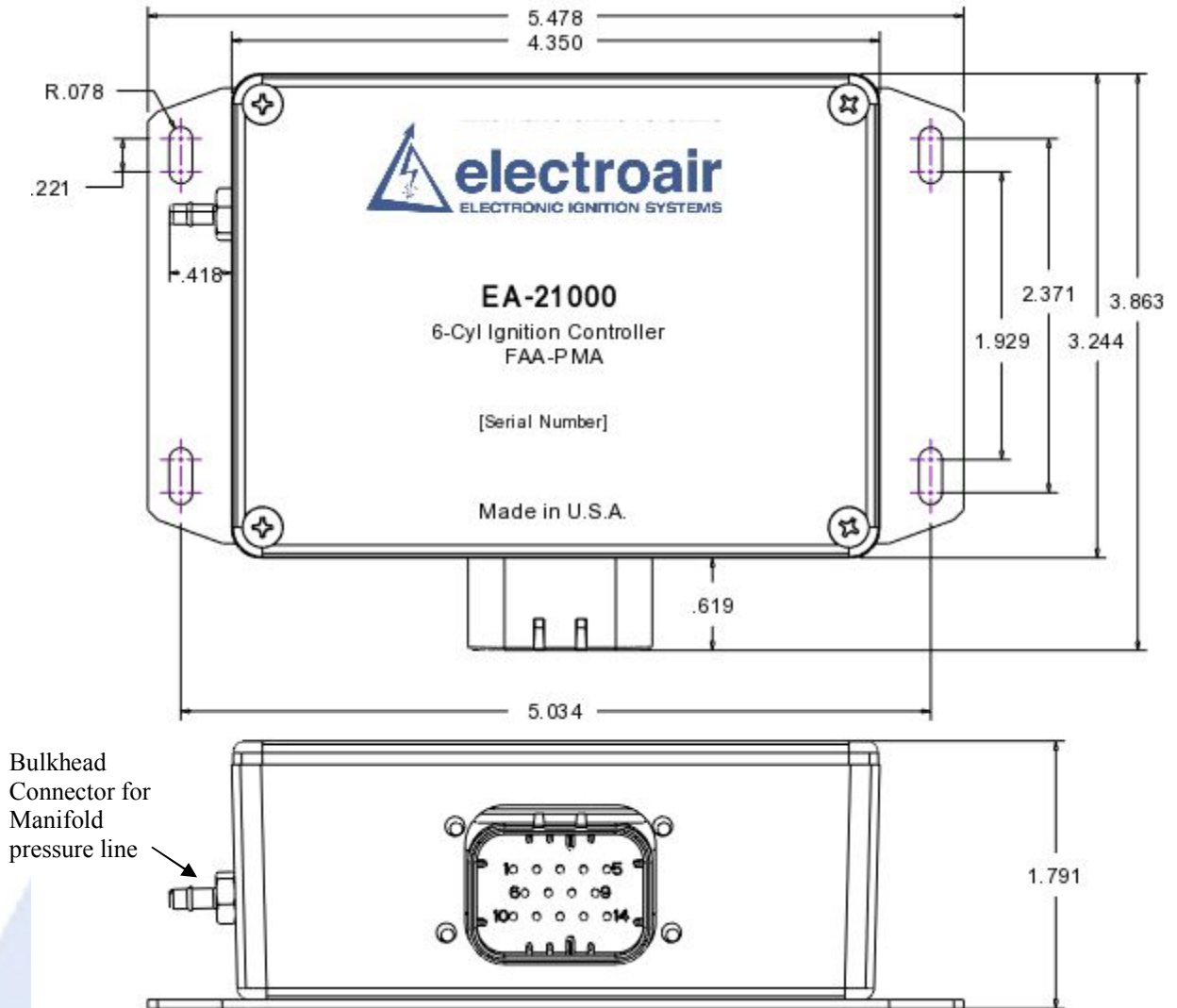
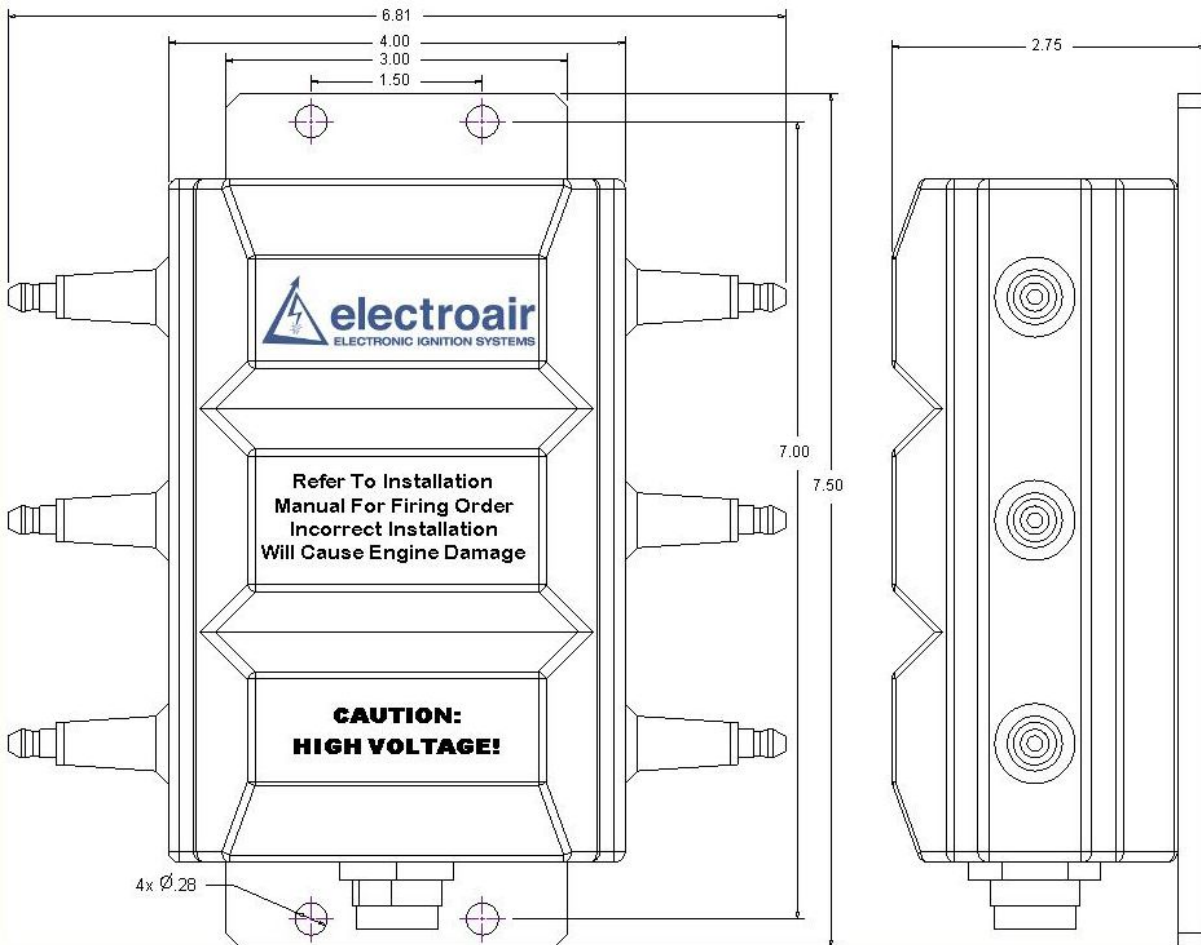

Figure 10: Part Number EA-21000; all dimensions in inches.

- c. **EA-8000 Installation:** The Coil Pack is designed to be installed on the engine side of the firewall. Locate the unit in a position to keep the spark plug wires as short as possible and not interfere with other components or create maintenance difficulties in the future. Electroair strongly suggests that the Coil Pack be positioned so that the connector on the coil is facing straight down, but it can be positioned in any orientation that the installation requires. See Figure 11 for the Coil Pack dimensions.

Electroair also suggests that the coil pack and harness be kept some distance away from exhaust pipes and potential exhaust leaks.



**Figure 11: Part Number EA-8000 Dimensions**

- d. P/N EA-8000 comes with the mounting plate disassembled from the coil pack. This is done so the mounting plate can be used as a guide for easily locating mounting holes on the firewall. When locating the mounting holes on the firewall is completed, install the plate to the coil pack following the procedure below:
- i. Obtain the mounting plate, coil pack, mounting screws (MS24694S50), and Loctite #242 (included in the EIS-61000 kit box).
  - ii. Align the clearance holes on the coil plate with the threaded inserts in the coil pack. Make sure that the countersinks, on the plate, are facing outward from the coil.

- iii. Apply a small drop of Loctite #242 to each of the coil mounting screws and install plate to coil pack. Make sure the plate is straight and tighten screws (recommended torque value is 12-15 inch pounds).
- iv. The black wire that is attached to the mounting plate should be attached to a competent airframe ground.



***CAUTION: Prior to any drilling, verify that there is clearance from any components on both sides of the firewall.***



***CAUTION: Use proper firewall sealing techniques during installation of all components.***

- e. After all considerations have been made regarding the placement of the controller and the coil pack, drill the mounting holes and install both units using standard AN hardware.

**NOTES:**

- i. To avoid any firewall cracking, place large area washers (AN970) between the firewall and fastening nuts to reinforce these contact points.
- ii. For honeycomb firewall installations, consider placing internal screw grommets inside the firewall around the mounting hardware to help prevent damage to the honeycomb structure.

## **8. Connection of Manifold Pressure Line:**

- a. Verify that a manifold pressure line exists from the engine.
- b. If a manifold pressure line does NOT exist, then one needs to be installed in order to use the variable advance feature of the EIS. Locate on a cylinder or intake manifold spider. Use of a primer port also acceptable.
- c. Now connect the manifold pressure line to the bulkhead connector on the EA-21000. Make sure the connection is tight using hose clamps.
- d. If a Manifold Pressure gauge is installed, a "T" can be placed into the manifold pressure line that is feeding the Manifold Pressure gauge.
  1. The size of the bulkhead connector is 1/8 inch. Recommend Aeroquip 306 or Stratoflex 193 hose with 1/8inch ID.
  2. The manifold pressure line may be connected with either standard fittings or other appropriate fittings for this application, in accordance with F.A.R 43.13.
  3. Verify that all connections and lines are tight and secure.

## 9. Installation of p/n: EA-4000 Spark Plug Harness:

- a. Now install the spark plugs that will be connected to the Electronic Ignition System. Electroair recommends use of new aircraft spark plugs. If the old spark plugs are being re-used, make sure spark plugs are clean and gapped 0.028 - 0.036 inches.

- i. **Electroair Spark Plugs:** Electroair has approved wide gap aircraft spark plugs for use with the Electroair Electronic Ignition Systems. These spark plugs are manufactured with the wider air gap Electroair recommends be used with the Electronic Ignition Systems. These Electroair spark plugs are not included in the standard EIS kit. These plugs are only approved to be used with the Electroair Electronic Ignition Systems.
- ii. **Non-Electroair Spark Plugs:** For all other aircraft spark plugs, Electroair recommends opening the gap of the spark plugs to 0.028 - 0.036 inches.



**CAUTION:** Be careful when gapping plugs because the outer electrode can become over-stressed and break. If any problems occur with plug selection, please contact Electroair ([sales@electroair.net](mailto:sales@electroair.net) or 248-674-3433).

- b. The kit came with three spark plug wire bundles. Each bundle will make two spark plug wires. **Note:** The EIS Kit comes with RHM spark plug hardware or EA-14100 spark plug tower attachments. If REM spark plugs are being used, please contact Electroair for replacement hardware.



**CAUTION:** Since each assembly makes two spark plug wires, be careful when determining spark plug wire length.

- i. Route the spark plug wire from the coil pack to the correct cylinder (See the ID table at the end of this section for wire orientation) to determine the spark plug wire length. Make sure to keep spark plug wire routings away from exhaust pipes and sensor wires. Wires routed parallel to each other require a minimum of 1/4 inch of separation.
- ii. Cut the spark plug wire leaving enough length to go three inches beyond the spark plug.
- c. If your kit came with an EA-4000RHM Hardware kit, continue with step c and skip step d. If your kit came with EA-14100 spark plug tower attachments, skip this step and proceed to step d.
- i. Slide the aluminum nut, receptacle, and Viton gasket on the wire. See Figure 12.
- ii. The wire supplied is a spiral core wire with a non-conductive center. Insert the spark plug spring on the outside of the spiral core so that the spring 'tail' makes contact with the spiral core. The spring 'tail' should be felt as it hits the spiral core during the insertion.



**CAUTION:** Do not install the spring tail directly in the center of the Kevlar fibers as it will not make contact with the spiral core. **OPTIONAL:** ~1/8 inch of the ignition wire insulation may be stripped to expose the spiral core wire to make installing the spring easier.

- iii. Verify continuity of the wires prior to install. Blue Wire (p/n EA-4090) resistance is 350 ohms/ft  $\pm 10\%$ . Red Wire (p/n EA-4091) resistance is 5700 ohms/ft  $\pm 10\%$ .

**NOTE:** For assistance with Spark Plug Wire Assembly, you can go to <http://www.electroair.net/>. Under Tech Support and Troubleshooting there is a link to a video that provides a helpful demonstration for Spark Plug Wire Assembly.



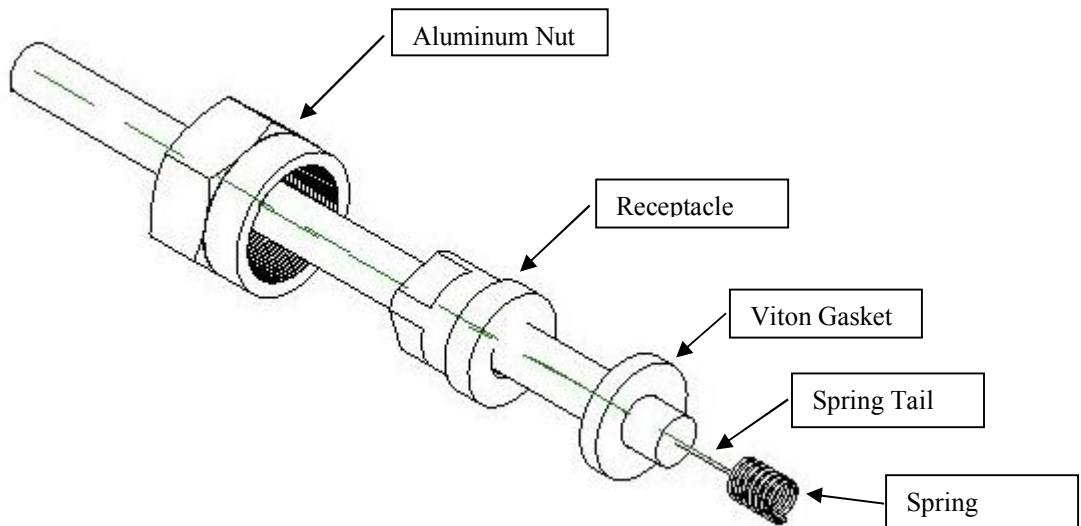

**Figure 12: Spark Plug Wire Component Stack Up.**

- iv. To finish the connection, install the spark plug end of the wire first. This prevents the spark plug wire from twisting as the spark plug nut is tightened.



**CAUTION:** Do not over-tighten the spark plug nut as this may cause separation of the core of the wire. Torque spark plug nuts to 95 in-lbs.

- d. If using EA-14100 Spark Plug Tower Attachments, insert the spring end of the part into the spark plugs. Tighten the tower to the plugs with the provided aluminum nut. See Figure 13.



**Figure 13: Spark Plug Tower Attached to Spark Plug**

- i. Strip the end of the spark plug wire and expose the central core without damaging it. See Figure 14.





**Figure 14: Exposed Core of Spark Plug Wire**

- ii. Fold the wire core over in a 180° bend and attach the provided terminal. Crimp the terminal to the wire and make sure that the wire stays in place while crimping. See Figure 15.



**Figure 15: Terminal Crimped with Central Core Folded**

- iii. Insert the terminal as far as possible into the 90° rubber boot. See Figure 16.



**Figure 16: Inserting Terminal into Boot**

- iv. Test the resistance of the spark plug wires. Red Wire: 5.7k Ohms/ft +/-10%. Blue Wire: 350 Ohms/ft +/-10%.
- v. Insert the 90° boot onto the spark plug tower attachment. An audible “SNAP” should be heard when the wire is properly installed onto each tower. If this snap is not heard, remove the boot from the tower and repeat this step until the “SNAP” is heard.

- vi. Repeat steps i through v for each wire
- e.
  - i. Attach the other end of the spark plug wires to the coil pack at their appropriate coil tower. **NOTE:** When inserting the 90° boot over each tower on the coil pack, an audible “SNAP” should be heard when the wire is properly installed onto each tower. If this snap is not heard, remove the boot from the tower and repeat this step until the “SNAP” is heard.
  - ii. Coil towers are labeled on the coil pack: A, B, & C. Because of the nature of the system, coil towers A will fire, then coil towers B will fire, and then coil towers C will fire.
  - iii. Install the spark plug wires to cylinders as detailed in the chart below:

Coil Pack	Tower A	Tower A	Tower B	Tower B	Tower C	Tower C
<b>Continental Cylinder #</b>	1	2	5	6	3	4
<b>Lycoming Cylinder #</b>	1	2	3	4	5	6

**NOTE:** The coil towers should be oriented towards the same side of the engine as the cylinder number – this will make spark plug wire installation easier.

## 10. Connection of p/n: EA-22000 Wiring Harness:

- a. **Verify that the master switch is off and battery is disconnected.**
- b. The electrical connections that will be made are as follows:
  - i. Harness to p/n: EA-21000, EIS Controller
  - ii. Harness to p/n: Magnetic Sensor (CSTW or MTH)
  - iii. Harness to p/n: EA-8000, Coil Pack
  - iv. Harness to Switched Power & Ground for EIS Controller
  - v. Harness to Ignition Switch (Rotary Switch Only)
  - vi. Harness to Tachometer
- c. A small hole must be drilled in the fire wall to route wires from the harness to their intended connections. Electroair recommends a 1-inch diameter hole to provide clearance for the wire harnesses. An MS35489-12 grommet can be used along with high temperature silicone sealant to help seal off the firewall hole after the wire harness has been passed through the firewall.



**CAUTION:** Prior to any drilling, verify that there is nothing on the back side of the firewall that could be damaged.

- d. **NOTES:** The main harness is assembled so it can be installed through tight clearances such as the previously drilled hole in the fire wall. A supply of ring terminals for switches, circuit breakers, and the main Bus Bar is needed. A wiring diagram with pin-out information has been supplied at the end of this section for reference.



**CAUTION:** Follow these wiring instructions very carefully to insure a correct hook-up of the EIS. Skipping ahead or taking short cuts increases the risk of an incorrect installation and either a poor performing EIS or the possibility of damaging equipment. Prior to turning on bus power, verify the wiring. Please call Electroair with any questions ([sales@electroair.net](mailto:sales@electroair.net) or 248-674-3433).



**CAUTION:** Make sure that wires are separated away from the spark plug wires. High voltages going through the spark plug wires can interfere with signals going through sensor and power wires.

- e. **Harness to p/n: EA-21000, EIS Controller:**
  - i. Connect the wiring harness assembly to the EIS Controller. This is done by inserting the 14-pin female connector (**C1**) into the male header on the Controller. Begin routing the various harness bundles and wires from here.
- f. **Harness to p/n: EA-9000, CSTW Kit (Lycoming engines):**
  - i. Route the harness with the square BLACK three pin connector to the connector that is on the magnetic pickup sensor.
  - ii. Loop any excess wire and secure with cable ties behind the firewall.
- g. **Harness to p/n: EA-11000, CSTW Kit (Continental engines):**
  - i. Route the harness with the square BLACK three pin connector to the connector that is on the magnetic pickup sensor.
  - ii. Loop any excess wire and secure with cable ties behind the firewall.
- h. **Harness to p/n: EA-10000, EA-12000, EA-16000, EA-17000 or EA-19000 MTH Kit:**
  - i. Route the harness with the square BLACK three pin connector to the connector that is on the magnetic pickup sensor attached to the MTH.

- ii. Loop any excess wire and secure with cable ties behind the firewall.
- i. **Harness to p/n: EA-8000, Coil Pack:**
  - i. Route the harness with the round BLACK connector to the Coil Pack and connect. See Figure 17 below for how the harness should look. **CAUTION: There is a noise suppressor capacitor in the harness just below Coil Pack Connector (covered by heat shrink). Use extreme caution when routing this harness. DO NOT make sharp bends in the portion of the harness covered by the heat shrink. Make all bends past the heat shrink tube covered portion of the harness. This will prevent damage to the capacitor. Please call Electroair Tech Support if there are any questions.**

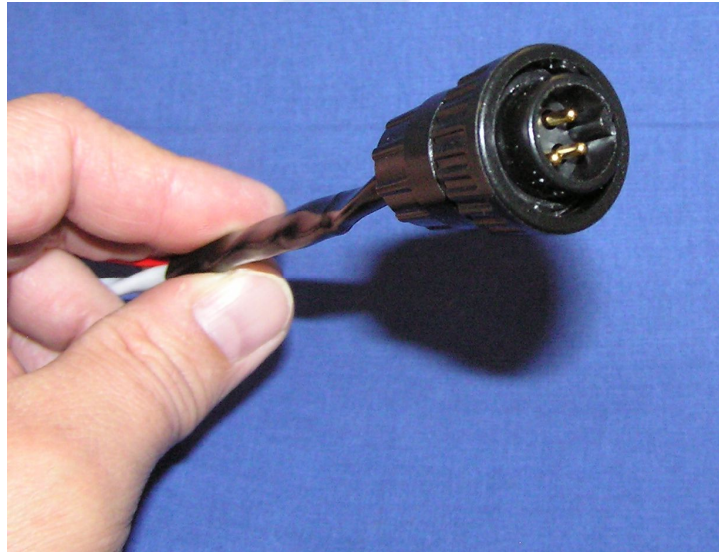

**Figure 17: Coil Pack Harness Plug**

- ii. Route the unterminated end of the Red wire from the harness through a 10 amp breaker (fuses may be used as an alternative to breakers) to the main Bus Bar. Cut to length and install terminals as required.
- iii. Loop any excess wire and cable tie or clamp the loop to a convenient location that does not interfere with any components (a location on the inside of the firewall is suggested).
- j. **Harness to Switched Power & Ground for EIS Controller:**
  - i. Obtain the RED wire that is coming out of the **C1** connector, **PIN 6**, and route this RED wire to the panel for switch termination and circuit breaker termination (fuses may be used as an alternative to the breaker).
  - ii. Trim and connect the Red wire to a panel mounted switch. Label this panel mounted switch "**EIS Switch**", and proper "**ON/OFF**" orientation. This switch should be a SPST aviation approved switch.
  - iii. Connect this panel mounted switch to a 2-amp breaker or fuse and connect the 2-amp breaker or fuse to main Bus Bar.
  - iv. Obtain the 16 gauge Black wire, labeled "ELECTROAIR GROUND", that is coming out of the **C1** connector, **PIN 14**.
  - v. Trim and connect the Black wire to a competent airframe ground.
  - vi. **IMPORTANT:** For aircraft that are using the "EIS Switch" as the ignition switch for the EIS-61000 and not a Rotary Style Grounding switch, follow these procedures:



1. Obtain the shielded WHITE wire, labeled “ELECTROAIR KEY SWITCH P-LEAD”, connector **C1, PIN 10**.
2. Cut this wire out of the connector and discard. **NOTE:** Be careful not to nick or cut any of the surrounding wires in the connector when cutting out this wire. Cover trimmed wire with appropriate protection.

k. **Harness to Ignition Switch (Optional Rotary Switch Connection):**

**WARNING:** If installed, the P-LEAD wire for the EIS can only be connected to the aircraft’s rotary style ignition switch. **DO NOT** install the EIS P-LEAD wire to any other starting accessory.

- i. This installation step is only necessary for aircraft that use a ROTARY STYLE ignition switch. For aircraft that use two separate ignition switches, e.g. rocker or toggle style switches, the “**EIS Switch**” will be the ignition switch for the EIS-61000. For aircraft that use two separate ignition switches, make sure to complete Installation step 9b before starting the engine.
- ii. Obtain the shielded WHITE wire, labeled “ELECTROAIR KEY SWITCH P-LEAD”, connector **C1, PIN 10**.
- iii. Trim and connect this shielded wire to the appropriate connection. On the ignition switch, this will be the location that the replaced magneto P-lead was removed from. Use the same methods for connecting a Magneto P-Lead when connecting the EIS P-Lead. **IMPORTANT:** Make sure the shield on the EIS P-Lead wire is grounded. Failure to ground this shield can cause the EIS to not operate properly.

l. **Harness to Tachometer:**

- i. Obtain the black wire, labeled “ELECTROAIR TACHOMETER”, connector **C1, PIN 8**.
- ii. The Tachometer output signal is a 12V or 24V (dependent on aircraft system voltage) square wave with three pulses per revolution. **CAUTION:** Verify that the Tachometer or engine monitor system that you are using can receive the above signal before connecting and operating. Incorrect signal types can cause incorrect readings or potentially damage monitoring systems.
- iii. Route this BLACK wire to Tachometer or monitor system and install the lead as specified by the equipment manufacturer. Trim and connect this wire appropriately.
- iv. If you do not intend to use this output, then this bundle should be looped and tied to an appropriate place inside the cockpit for later use.

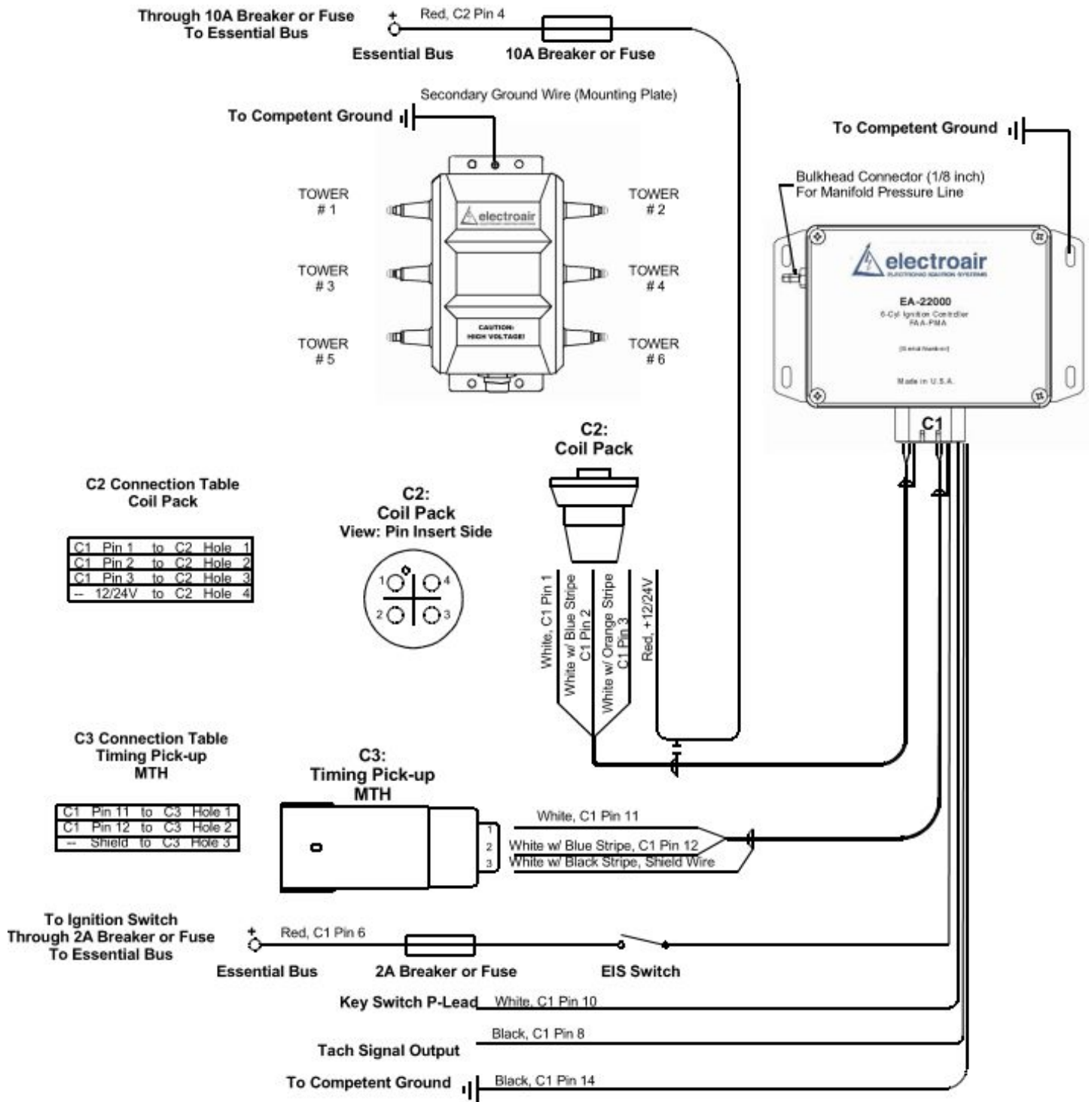

Figure 18: Wiring diagram for EIS-61000



## 11. Final Installation Steps:

- a. Calibration and Timing settings: The unit has been pre-set at the factory to a pre-determined base timing (base timing is always placarded timing for the engine). If the timing placarded on the controller does not match the timing placarded on the engine, please contact Electroair ([sales@electroair.net](mailto:sales@electroair.net) or 248-674-3433). If you feel that the unit is not performing optimally or if base timing needs to be adjusted contact Electroair ([sales@electroair.net](mailto:sales@electroair.net) or 248-674-3433).
- b. **IMPORTANT:** For aircraft that are using the “EIS Switch” as the ignition switch for the EIS-61000 follow these procedures: Verify that the wire labeled “ELECTROAIR KEY SWITCH P-LEAD”, has been cut out of the connector and discarded. **NOTE:** Be careful not to nick or cut any of the surrounding wires in the connector when cutting out this wire.
- c. Re-attach and reinstall any connections or components that were removed or loosened during this installation.
- d. Secure all new wires, harness, connections and lines to prevent failures due to vibration.
- e. Connect battery connections and close any open circuit breakers.
- f. Recover all tools that may have been used (you don't want any tools 'floating' around inside the airplane).
- g. Review remaining magneto, if pressurized; verify there are no pressure leaks.
  - i. Verify the calibrated vent is installed.
  - ii. Verify the inline filter, if equipped with a drain, is pointed down for proper drainage of any liquid that may accumulate in the filter.
- h. Proceed to the operational section of the Flight Manual Supplement and perform a test run-up before flying.
- i. Aircraft using multiple EIS systems, should have a way of differentiating between each EIS.

## ***Glossary and Abbreviations:***

AD(s) – Airworthiness Directive(s)

AFM – Aircraft Flight Manual

AFMS – Aircraft Flight Manual Supplement

ALS – Aircraft Limitations Section

AML – Approved Model List

APU – Auxiliary Power Unit

BTDC – Before Top Dead Center

CFR – Code of Federal Regulations

CSTW – Crank Shaft Trigger Wheel

EIS – Electronic Ignition System

FAA – Federal Aviation Administration

Ignition Timing – is the process of setting the angle relative to piston position and crankshaft angular velocity that a spark will occur in the combustion chamber near the end of the compression stroke.

MAG – magneto

MAP – Manifold Absolute Pressure

May/Should – an optional requirement

MTH – Mag Timing Housing

Must/Shall – a mandatory requirement

RPM – Revolutions per Minute

POH – Pilot's Operating Handbook

STC – Supplemental Type Certificate

TDC – Top Dead Center