

ECOLOG-NET LR8

Operation Manual



ELPRO-BUCHS AG

Warranty conditions and liability disclaimer

Liability

- ELPRO-BUCHS AG does not accept any liability for direct, indirect, special, incidentally occurring, randomly occurring or subsequent damage or losses including lost profit or data resulting from the use of their data loggers, sensors, accessories, software products or information from the documentation.
- ELPRO-BUCHS AG does not bear any responsibility for the installation of the software products.
- ELPRO-BUCHS AG does not provide any guarantees, either explicit or implicit, regarding the usability or suitability of their products for a specific purpose.
- In the interest of our customers we reserve the right to make changes and discontinue the product on the basis of technical advancement. For this reason the functionality, diagrams, descriptions and scope of supply can be modified without prior notification!
- As individual countries or states do not permit the concept of an implicit warranty or a liability disclaimer for incidental or subsequent damage, the restrictions and disclaimers may not apply to all customers. If one of the provisions of this warranty is declared by a competent court to be invalid or not enforceable, this does not affect the validity or enforceability of the remaining provisions.
- ELPRO-BUCHS AG does not accept any liability for transport damage.
- In general the statutory regulations of Switzerland apply.

Guarantee

- The guarantee obligations of ELPRO-BUCHS AG are limited to reworking, reimbursement of the purchasing price, repair free of charge or the replacement of a faulty product that is returned within the guarantee period to ELPRO-BUCHS AG or an approved reseller of ELPRO-BUCHS AG.
- There is no obligation to provide on-site customer support by an employee of ELPRO-BUCHS AG.
- The guarantee is only applicable to the original purchaser or end user and customer of an approved reseller of ELPRO-BUCHS AG.
- Resellers approved by ELPRO-BUCHS AG are not authorized to enter into any extended or different guarantee obligations in the name of ELPRO-BUCHS AG.
- ELPRO-BUCHS AG provides a guarantee of 24 months on the following new products:
 - Datalogger
 - Brackets
 - Accessories excluding probes and third-party products
- This guarantee is valid for material faults or production faults.
- ELPRO-BUCHS AG provides a guarantee of 6 months for the following products and services:
 - All servicing and repair work
 - Temperature probe
 - Humidity probe
- ELPRO-BUCHS AG provides a 90 day guarantee that the medium on which the software product is supplied is free from material and processing faults under normal conditions. All main items of the software product comply with the operating instructions and the information in the help file.
- The guarantee does not apply to consumables, disposable batteries or any other product that ELPRO-BUCHS AG deems to be:
 - misused
 - modified
 - replaced by an incorrect product
 - damaged as the result of an accident or operational or handling conditions that do not comply with the specifications.
- Wear, cable breakage and corrosion are not covered by the guarantee.
- For third-party products ELPRO-BUCHS AG provides the maximum guarantee period of the manufacturer.
- ELPRO-BUCHS AG only provides a guarantee and customer support for discontinued products for a limited period.
- Repair work covered by the guarantee is solely carried out at the works (ELPRO-BUCHS AG) or by an agent approved by the works.
- ELPRO-BUCHS AG does not offer any guarantee for the standard or SCS calibration of the data loggers and probes. The stated data correspond to the situation during the calibration process.

Software

- The software products of ELPRO-BUCHS AG are subject to internal quality requirements and are validated regularly at the works. In the event of program errors, circumvention of the error is regarded as constituting its elimination.
- Software manuals do not contain either instructions on basic operation of a computer or the basic functions of the Windows® operating system. For information on the operation of the computer or the operating system please refer to the applicable computer manuals.

Data loggers, sensors and accessories

- ELPRO-BUCHS AG applies the highest quality standards during production of the data loggers and their accessories as well as a certified quality management system in compliance with ISO 9001.
- For information on operation of the data loggers and their accessories please refer to the respective product documentation.
- During the installation of data loggers, probes and accessories, compliance with the locally valid installation regulations is mandatory.
- When used in potentially explosive atmospheres, the zone category and the application and safety instructions of ELPRO-BUCHS AG must be complied with.
- In the event of a guarantee claim, customers receive a repair cost estimate from ELPRO-BUCHS AG to obtain the corresponding consent before starting work.
- The customer will bear the transport costs incurred for any repairs carried out by ELPRO-BUCHS AG. The DAP (value added tax) is borne by ELPRO-BUCHS AG.
- ELPRO-BUCHS AG reserves the right to invoice the customer for costs incurred for repair/part replacement.
- After repair work the product is returned to the purchaser, who will be charged with the return shipping costs (FOB shipping point).

Trademarks

All stated company and product names and their trademarks are the protected property of the respective owner.

Table of Contents

1. Product description	7
1.1 Radio Datalogger	7
1.2 Radio sensors	7
2. General application and safety information	9
2.1 Antenna position	9
2.2 Temperature effect	9
2.3 Exceptional environmental conditions	9
2.4 Precautionary measures for handling units containing lithium batteries	10
2.5 Precautions in handling with power supply units	10
2.6 Applications in intrinsically safe environments	10
3. Radio datalogger	11
3.1 Transmitted frequency, radio channel & aerial	11
3.2 Network connection	11
3.3 USB connection	11
3.4 Display	12
3.5 Menu	13
3.6 Threshold value function / alarm parameters	14
3.7 Contact inputs D1 and D2	18
3.8 Configuring the radio datalogger	18
3.9 Pin assignments and connections	23
3.10 Alarm diagrams	25
3.11 Maintenance	26
3.12 Power failure	26
4. Radio sensors	27
4.1 Types	27
4.2 Initial startup	27
4.3 Operation	29
4.4 Maintenance	30
5. Installation	31
6. Status and error messages	32
6.1 Radio Datalogger	32
6.2 Radio sensor	33

7. Technical data	34
7.1 Radio settings	34
7.2 Radio datalogger	35
7.3 Radio sensors	35
7.4 Marking for use in potentially explosive environments	39
7.5 Part no. System and Accessories	40
7.6 Dimensional drawings	41
8. Approvals	42
8.1 ETSI	42
8.2 Wireless Communication reliability	42
8.3 FCC	43
8.4 INDUSTRY CANADA	44
8.5 Conclusion	44
9. Declarations of conformity	45
9.1 Declaration of conformity for ECOLOG-NET LR8	45
9.2 Confirmation of identical design	46
9.3 Declaration of conformity for radio sensors in potentially explosive environments ..	47
Index	50

Symbols and description codes used



Information



IMPORTANT INFORMATION AND WARNINGS



Reference to related chapter or document





Software

For a detailed description, see the corresponding operating instructions or the software help files.

Software	Operation Manual
elproLOG ANALYZE	SE3003E
elproLOG ANALYZE QLS	
elproMONITOR	SM3031E



CHANGES OR MODIFICATIONS MADE TO THIS EQUIPMENT MAY VOID THE ETSI / FCC AUTHORIZATION TO OPERATE THIS EQUIPMENT.
THIS DEVICE COMPLIES WITH PART 15 OF THE FCC RULES AND WITH RSS-210 OF INDUSTRY CANADA. OPERATION IS SUBJECT TO THE FOLLOWING TWO CONDITIONS:
(1) THIS DEVICE MAY NOT CAUSE HARMFUL INTERFERENCE.
(2) THIS DEVICE MUST ACCEPT ANY INTERFERENCE RECEIVED, INCLUDING INTERFERENCE THAT MAY CAUSE UNDESIRE OPERATION.

-  - This product is subject to CE marking.
-  - The manufacturer guarantees that this product complies with the relevant guidelines. (see: 9. *Declarations of conformity*)
-  - FCC ID: Z45-E11645398
-  - IC: 9954A-E11645398
-  - This product must be disposed of in accordance with WEEE (Waste electrical and electronic equipment, 2002/96/EC)!

 In the interest of our customers, we reserve the right to make changes due to ongoing technical development. As a result, images, descriptions and scope of delivery are not binding! The release of this document is available on the printed and archived original only.
This manual is valid for firmware version 1.02 elproLOG ANALYZE 3.63

1. Product description

The radio datalogger system from ELPRO-BUCHS AG consists of a network-capable (LAN) radio datalogger ECOLOG-NET LR8 as receiving terminal and various radio sensors for detecting temperature and humidity values.

Up to 8 Radio sensors
64000 measured values
Alarms

1.1 Radio Datalogger

The ECOLOG-NET LR8 is a datalogger for recording up to 8 radio sensors and a maximum of 64,000 measured values. The measured values are transmitted via radio to the datalogger and from there, via the local network to the PC. In the event of a power outage, all data is retained and the internal clock continues to run.

The radio datalogger ECOLOG-NET LR8 is equipped with a 10/100 BaseT network connection.

☞ 3.2 Network connection and 3.3 USB connection.

USB connection
LAN connection

There are multiple possibilities for local alerting:

- Alarm indicator on the display
- Alarm buzzer
- Alarm contacts

With the elproMONITOR software, alarms can be registered and relayed over the network.

☞ 3.10 Alarm diagrams

Alarm

The ECOLOG-NET LR8 has a screwed connection(SMA) for the antenna on the upper side of its casing. The ECOLOG-NET LR8 has a number of electrical connections on the left side of its casing. The front side of the casing has a large LCD display and the membrane keypad.

Casing

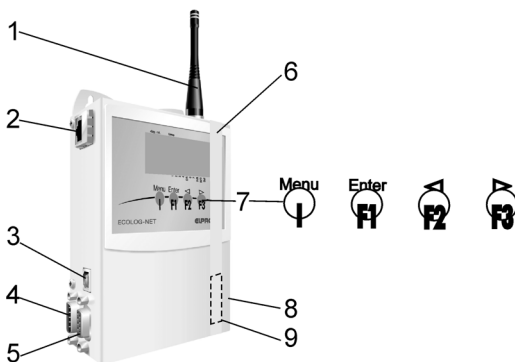

1. Aerial
2. Network connection
3. USB connection
4. Power supply, contact inputs and alarm output
5. Alarm output
6. Battery discharge protection
Removal initiates the first "System Reset" entry in the status! After removal, it is necessary to wait about 10 sec. until the datalogger is operational.
7. Membrane keypad with 4 buttons
8. Type label with ID number and IP address
9. Battery (inside the logger)

Connections
Membrane keypad
Battery discharge protection

1.2 Radio sensors

Using the available radio sensors, temperature and humidity values can be detected and transmitted via radio to the base station (ECOLOG-NET LR8). The radio sensors work autonomously and are supplied with power via internal batteries.

On the front side there is a status display (green/red LED) and a type label which documents the radio sensor designation and the ID number of the sensor.



A radio sensor can be connected with up to 2 sensing devices.

A humidity/ temperature sensor corresponds to 2 sensors in the elproLOG ANALYZE and elpro-MONITOR software if both measured values are recorded.

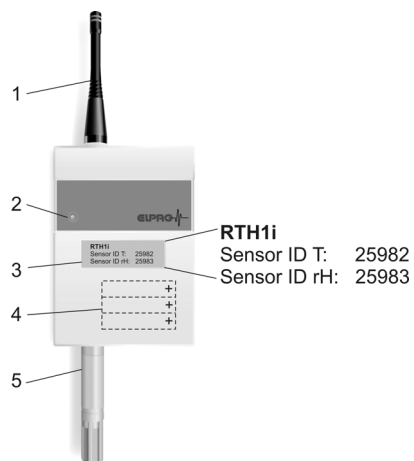

1. Aerial

2. Status display  4.2 Initial startup and 4.3 Operation

3. Type label with ID numbers

4.3 batteries for the types: RTxx and RTH1x inside the radio sensor

5. Sensor, i.e. humidity or temperature sensor

Types of radio sensors  7.3 Radio sensors

 2.6 Applications in intrinsically safe environments

2. General application and safety information

2.1 Antenna position

The 433/886/915MHz range (always dependent upon the structural conditions of the building such as cement ceilings, water pipes etc.) is approx. 100m in a typical office environment  7.1 Radio settings.

Range approx. 1000m 

With this type of aerial, the signal is emitted at right angles from the aerial. The direction can be visualized as being like a CD that is skewered on the aerial. This makes it clear that it is best for the aerial to be placed vertically, pointing upward, so that it transmits to all rooms on the same floor. If the aerial is placed horizontally, reception is best on the floors above and below. The worst reception is when the radio sensor antenna is pointed directly at the radio datalogger. For optimal reception, the radio sensor should be in the line of sight of the radio datalogger.

In which direction should the antenna point? 

Metal objects such as shelves, reinforced concrete walls, ventilation and energy shafts, but also the opening of a refrigerator door can lead to the weakening of the signal. This kind of effect is usually very much limited to the location.

Moving the radio sensor within an area of 2.5 meters (sometimes just a few centimeters) is usually adequate to completely change the reception ( 4.2.3 Transmitted frequency & radio channel). Move the radio sensor forward, backward, up and down within this area. The radio datalogger / radio sensor should always be mounted at least 1.5m above the ground.

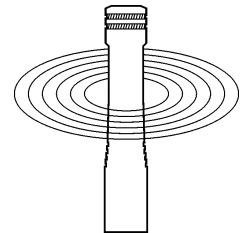

If no direct line of sight to the radio datalogger is available, the angular position (angle in relation to the horizontal axis and rotation of direction) can improve reception.

Placing the datalogger / radio sensors in an open stairwell is an additional possibility to avoid one or more reinforced steel ceilings that are an obstacle.

For additional details regarding the antennas  7.1 Radio settings

2.2 Temperature effect

- For the range of application  7. Technical data
- It can't be guaranteed that the loggers will function properly if the datalogger is exposed to temperatures which exceed the specified threshold range. Experience shows that at storage temperatures below -50°C, the battery freezes, measurements are no longer taken and setpoint tracking may be temporarily interrupted. Once it has been returned to room temperature, the logger must be reprogrammed before it can be used again.
- At temperatures below -20°C, the display is not easily readable; however, longterm use is not affected.
- For longterm use above 40°C, lithium battery passivation can lead to temporary reading problems (self-discharge protection), which can be resolved with repeated utilization.
- At temperatures above 45°C, battery self-discharging increases. With long term use above 45°C, the battery lifetime can be reduced by about 1/3.
- Exposure to temperatures above 55°C can result in permanent discoloration of the display.
- There is danger of a gas explosion if the lithium battery is heated to temperatures exceeding 100°C.

2.3 Exceptional environmental conditions

Pay attention to the following when using the datalogger in exceptional environmental conditions:

- IR radiation (heat) and superheated steam can damage the surface coating of the casing
- There is a risk that the battery may explode if the logger is used under microwave radiation

Initial startup 



THE RADIO DATALOGGER MUST BE AT ROOM TEMPERATURE BEFORE INITIAL STARTUP!

NOTES ABOUT THE POWER SUPPLY UNIT  3.10.2 SUPPLY; CONNECTOR RED AND 4.2.2 RA2E - 4-20MA SIGNALS

2.4 Precautionary measures for handling units containing lithium batteries

Lithium batteries



- Do not short-circuit and charge batteries: Explosion hazard
- Do not throw units which contain batteries into fire: Explosion hazard
- Do not subject batteries to mechanical stress and do not dismantle them as leaking battery fluid is highly corrosive and lithium can generate severe heat or can ignite a fire if it comes into contact with moisture.
- Do not heat battery operated units to temperatures exceeding 100°C: Explosion hazard
- Avoid excessive impact
- Follow the manufacturer specifications for storing batteries
- Return batteries to the supplier for correct waste disposal

2.5 Precautions in handling with power supply units

Power supply unit



Follow the safety and application instructions of the power supply unit.

2.6 Applications in intrinsically safe environments



THE RADIO DATA LOGGER IS NOT APPROVED FOR APPLICATIONS IN INTRINSICALLY SAFE AREAS



2.6.1 Measures to maintain explosion protection during operation - Radio sensor

RT1e, RT2e, RTH1i and RTH1e



- Operation of the radio sensors: RT1e, RT2e, RTH1i and RTH1e in dry and clean rooms only.
- Ensure that there is a strain-free cable entry point
- The connecting, removing or extending of sensor cables must be carried out in the unprotected zone only.
- Only operate using Pt100 sensors that have been specified by Elpro-Buchs AG
- The radio sensors must be fitted with the markings specified in the chapter.7.4 *Marking for use in potentially explosive environments*.
- In order to ensure the proper functioning of the radio sensor, the customer must not make any repairs on the radio sensor.

2.6.2 Application area of the radio sensor: II 3G Ex nA IIC T6 X

- II** Device group II for use in all areas at risk of an explosion except mines
- 3** Category 3, appropriate for use in zone 2 (rare hazard)
- G** Area at risk for explosion due to gas and vapors; however, not because of dust
- Ex** Explosion protection according to European standards: EN 60079-0:2009, EN 60079-15:2010, EN 1127-1:2011 and the standards for specific types of ignition protection
- nA** Type of ignition protection: non-sparking equipment
- IIC** Use in all hazardous areas outside of the mines:
Group II subdivision C
- T6** Temperature class T6: max. surface temperature 85°C with a safety margin of 5 Kelvin for constantly hot surfaces.
- X** Special installation requirements:
 -  2.6.1 *Measures to maintain explosion protection during operation - Radio sensor*
 -  7.4 *Marking for use in potentially explosive environments*

3. Radio datalogger

3.1 Transmitted frequency, radio channel & aerial

The transmitted frequency and the channel used are defined using the software elproLOG ANALYZE . Three frequency bands, 433MHz and 868MHz for Europe and 915MHz for the USA can be selected. Aerials will be delivered with appropriate color coding depending upon the country .

Aerials 

 7.1 Radio settings

The default setting is channel A / 868MHz for Europe and channel A / 915MHz for the USA.

Default settings 

Transmission disturbances can be resolved by selecting a different channel. There are up to 16 channels available depending upon the transmitted frequency. When using multiple LR8 dataloggers, it is recommended that each datalogger be operated on a separate channel.

Transmission failur 

 7.1 Radio settings

3.2 Network connection

The ECOLOG-NET LR8 is equipped with a 10/100 Base T network connection. The datalogger functions and network can be configured using this connection.

 3.8.1 Assign network address

3.3 USB connection

This connection can be used for parameterization and for data readout if no network connection is available; however, it is not possible to define network parameters using this connection.

In order to obtain an optimal USB connection, the following operational sequence should be followed:

1. Connect the power supply to the datalogger and turn on the PC
2. Once both devices are ready for use, connect the USB cable
3. The Windows driver for the USB connection being used must be installed. If the appropriate driver is missing, it can be installed using the elproLOG ANALYZE software CD.
4. elproLOG ANALYZE: Options - Com Port - RS232 and 57600 (Hoseries 4) and appropriate COM-port.

In the event that the USB and the LAN connections are busy, no data exchange is possible via the LAN. 

3.4 Display

Large LCD display for measured values, units and conditions

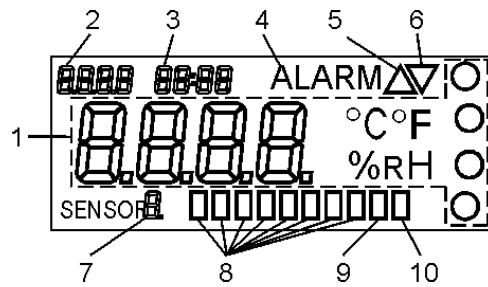

1. Measured value with unit
2. Date or communication via USB or LAN connection
3. Time
4. Alarm
5. Measured value is above upper threshold value
6. Measured value is below lower threshold value
7. Sensor number
8. Alarm flag for sensor 1...8
9. Logging data

10. Battery low

Activated when the capacity limit of the battery has been reached. The battery must be changed at the next opportunity ( 3.11 Maintenance).

Battery low 

Display on/off

In the event that no measured values shall be displayed, the radio datalogger display can be switched off. Correct data logging is indicated by 4 small circles in the measured values display. For testing purposes, the measured values display may temporarily be switched on using the keypad.

The display is switched on and off using the elproLOG ANALYZE software - Additional settings - Configure logger display... - Logger display off.







THE DISPLAY IS UPDATED IN THE TRANSMITTING INTERVAL OF THE RADIO SENSOR ONLY. FOR CALIBRATION THE LOGGED DATA ARE VALID ONLY!

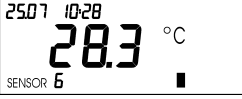
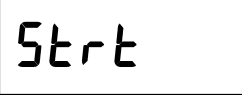

7.3.1 BATTERY LIFETIME

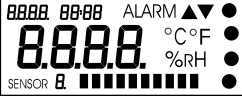
3.5 Menu

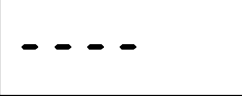
<p>1 Power-saving mode</p> 	<p>4 only appears if the logger is in power saving mode and is recording data. The measured value display can be activated for a few seconds by pressing the menu button.</p> <p> Temporary jump to menu item 2</p>
<p>2 Measuring mode</p> 	<p> Jump to menu item 3 or 4 or 5; depending upon the situation</p>
<p>3 Start</p> 	<p>Only appears when the datalogger is in start/stop mode and is waiting for the start time. StoP, ALA, dISP 6.1.1 <i>Datalogger display and elproLOG ANALYZE</i></p> <p> Jump to menu item 5</p>
<p>4 Acknowledgment</p> 	<p>Appears when there is an alarm or when the "self-sustaining" function is selected and an alarm is registered. 3.8.4.1 <i>Window: Setup of Alarm parameters</i></p> <p> Jump to menu item 5</p> <p> Reset alarm display and alarm contacts as well as entry of the reset time in the alarm log and exit menu, jump to menu item 8</p> <p> Exit menu, jump to menu item 8</p>
<p>5 Functions</p> 	<p> Jump to menu item 6</p> <p> Timestamp indicated as D2 and exit menu, jump to menu item 8 3.7 <i>Contact inputs D1 and D2</i></p> <p> Exit menu, jump to menu item 8</p>
<p>6 LCD display test</p> 	<p> Jump to menu item 7</p> <p> Exit menu, jump to menu item 8</p>
<p>7 Alarm output test</p> 	<p> Jump back to menu item 4 or 5</p> <p> OFF - ON - OFF</p> <p> Exit menu, jump to menu item 8</p>
<p>8 Exit menu</p> 	<p>Automatic jump back to menu item 1 or 2 or 3</p>



ERROR 5: MODULE DOES NOT RESPOND DURING DATA READ-OUT

- THE RADIO DATA LOGGER IS NOT IN MEASURING MODE
- PRESS F1/F3 TO EXIT THE MENU

3.6 Threshold value function / alarm parameters

The ECOLOG-NET LR8 has a feature for monitoring threshold values. The threshold values are defined separately for each individual sensor  3.8.4 *Definition of threshold values and alarm parameters*. The ECOLOG-NET LR8 can signal a threshold violation / an alarm in several ways:

Threshold value violation

1. A threshold violation is shown on the display with an alarm flag and two arrows; signaling is always sensor-specific  3.4 *Display*. They are only visible for the duration of the threshold violation. This status is not logged
2. The text: ALARM is displayed when the conditions for an alarm are fulfilled and depending upon the selected alarm output (self-sustaining).
3. If an alarm is triggered, the ECOLOG-NET LR8 has a collective alarm function. This function is simultaneously activated with the text: ALARM activated  3.6.1 *Collective alarm contact functions* and 3.10 *Alarm diagrams*.
4. After the alarm delay time is up, an alarm is not registered in the memory until the next log interval has elapsed. All threshold violations / alarms are registered in the alarm protocol, even if they are shorter than the defined log interval!

Acknowledging alarm messages

Alarm messages can be acknowledged manually by using the PC software or the keypad.

Monitoring threshold values

 **THRESHOLD VALUES ARE CHECKED IN ONE MINUTE CYCLES. IF THE DISPLAY IS SWITCHED OFF, THE TEXT : ALARM AND ALA WILL BE DISPLAYED WHEN THE APPROPRIATE CONDITIONS ARE MET.
IF THE RADIO DATALOGGER IS IN STOP MODE, THRESHOLD VALUES WILL NO LONGER BE MONITORED.**

3.6.1 Collective alarm contact functions

Alarm signaling:

- Relay contact
- Alarm 1
- Alarm 2
- Buzzer

The ECOLOG-NET LR8 has 4 possibilities for alarm signaling:

- Relay contact S
This is a potential-free switch-over contact. The contact switches when an alarm is triggered or when the external power supply fails.
- Semiconductor contact alarm 1
Only reacts when there is an alarm
This is a semiconductor break contact at the datalogger GND
- Semiconductor contact alarm 2
Only reacts when there is an alarm
This is a semiconductor switch at the datalogger GND
- Integrated buzzer
Serves as an acoustic alarm

 3.8.4 *Definition of threshold values and alarm parameters*

 Wiring: 3.9 *Pin assignments and connections*

3.6.2 Time response collective alarm

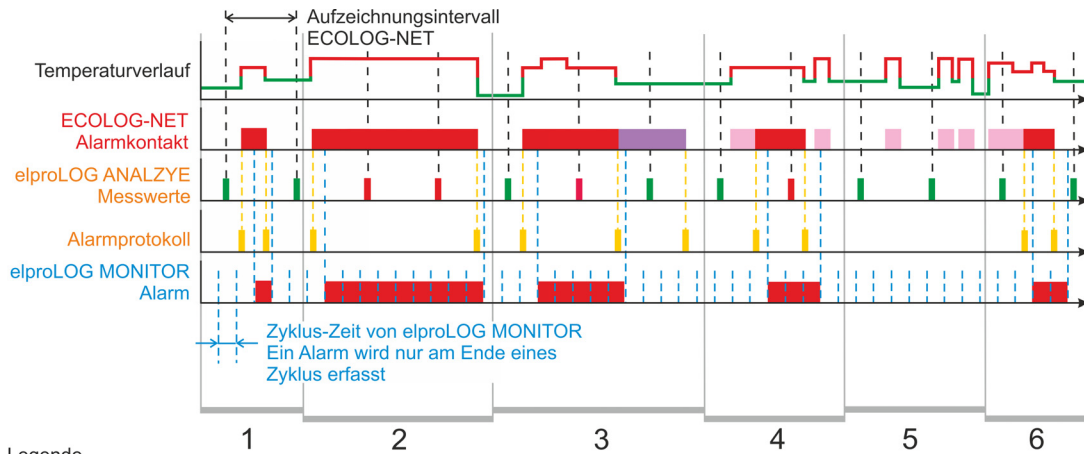

Legende

- █ Messwert normal
- █ Alarm
- █ Eintrag im Alarmprotokoll
- █ Selbsthaltung des Alarmkontaktes
- █ Alarmverzögerungszeit

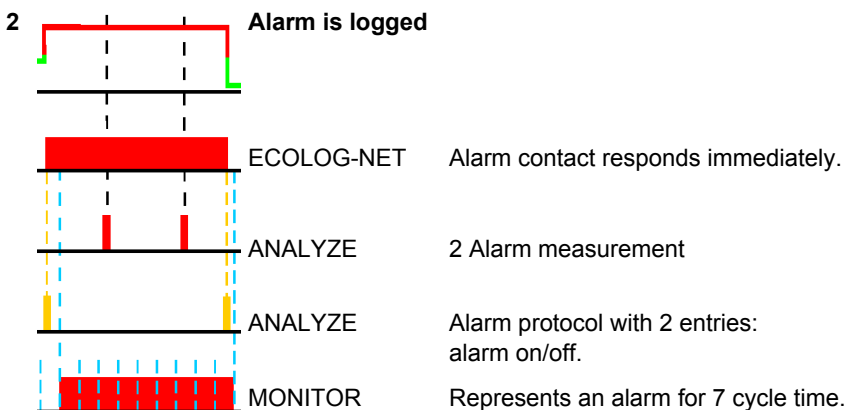
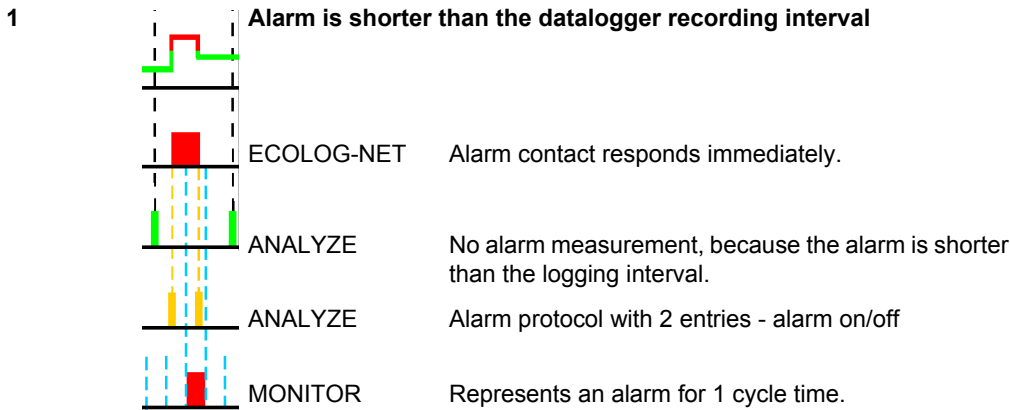

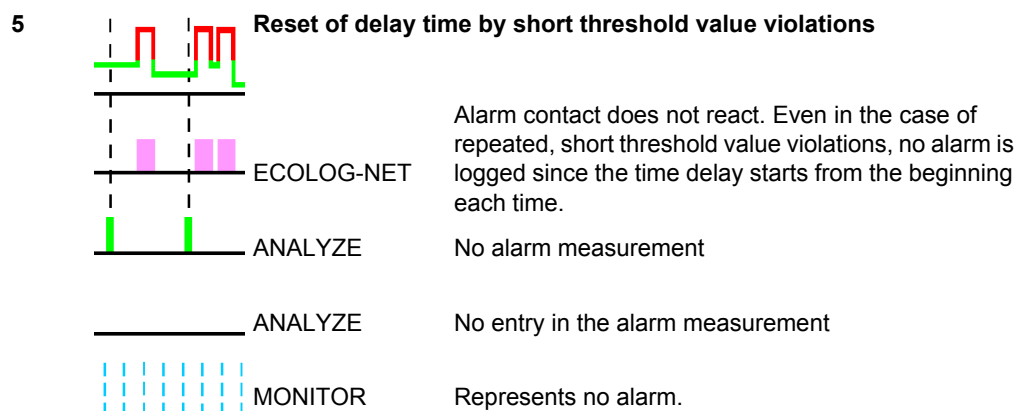
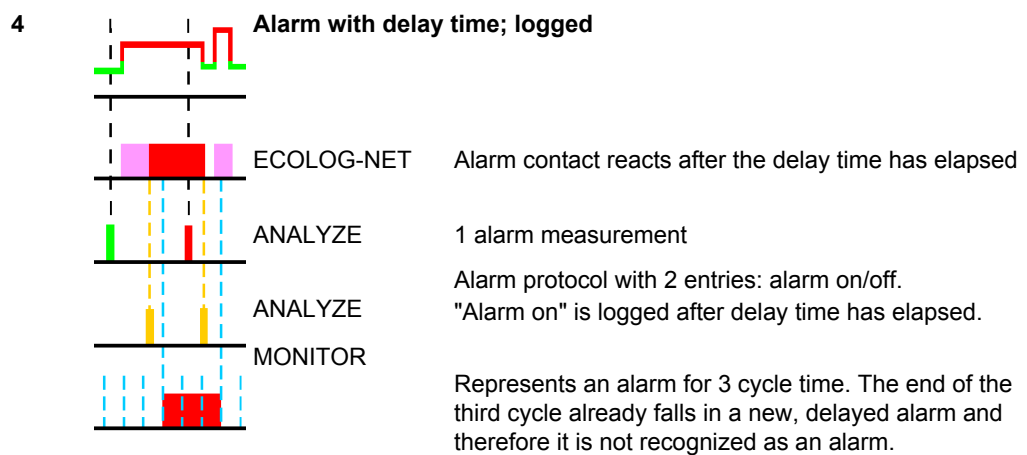
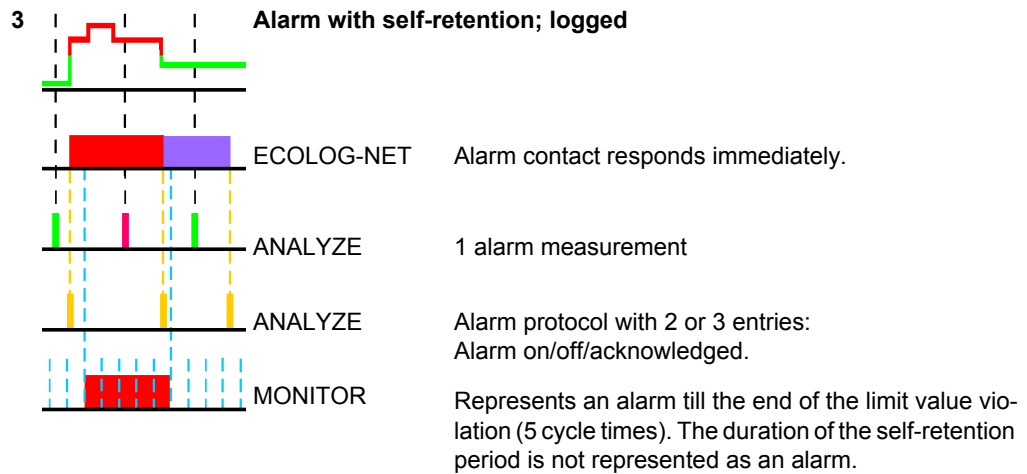

6

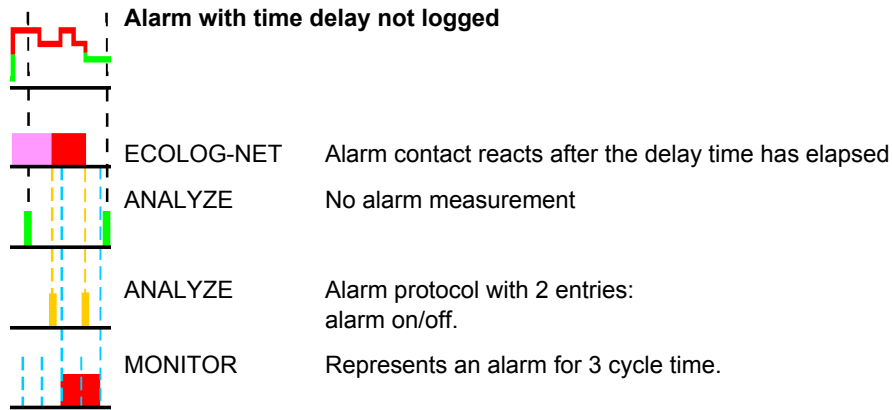

3.7 Contact inputs D1 and D2

**Both inputs are busy with dual functions!
In each case, only one function should be used!**

Function	possible configurations			
Assign	D2 key	D2 key	Assign	D2 key
Defrost input	D1 external		D1 external	
Alarm forwarding		D1 external	D2 external#	D1 external and D2 external

- D2 key See function F2, timestamp designated as D2 3.5 Menu
This function can be used to register incidents such as a watchman's patrol on the logger.
- D1 external As defroster input (3.8.4 Definition of threshold values and alarm parameters) or for alarm forwarding.
Wiring 3.9 Pin assignments and connections
- # For alarm forwarding.
Wiring 3.9 Pin assignments and connections and 3.10 Alarm diagrams

- Status - The status of D1 and D2 is not recorded in the alarm protocol and has no influence on the alarm contacts. They are first logged to memory on the radio datalogger at the end of the following recording interval in memory. In the measurement table elproLOG ANALYZE both contacts are represented as D1, D2 or MarkPos.
- Alarm forwarding - Alarm forwarding is used in combination with the elproMONITOR software. The status (alarm / no alarm) of the contacts is checked during the update of the monitor data. Status changes between two updates are not detected.

3.8 Configuring the radio datalogger

- Assignments In preparation for installation, the assignment of the radio sensors to the radio dataloggers and the network addresses being used should be defined.
Additional preparatory steps include:
 - Definition of limit values
 - Configuration of the alarm outputs
 - Function of the digital inputs

3.8.1 Assign network address

- Digi Device Discovery
Fixed IP In order to be able to identify each radio datalogger in a network environment, each radio datalogger receives a unique network address. This address is made up of 3 pieces of information: IP-Address, subnet mask and default gateway. For the elproLOG ANALYZE and elproMONITOR programs, we recommend the use of a static IP address.
In order to avoid network conflicts, the network administrator must assign the addresses! These 3 pieces of information must be entered manually into each datalogger using the software Digi Device Discovery. For additional installation information see the elproLOG ANALYZE operating instructions, SE3003E, or the online help feature. For additional network information see ECOLOG-NET service instruction IT6001A.
This manual can be found on the ELPRO homepage at [www.elpro.com/Download/Data Sheets/ECOLOG-NET networkable datalogger](http://www.elpro.com/Download/Data%20Sheets/ECOLOG-NET%20networkable%20datalogger).

The datalogger requires an external power supply for the operation of the LAN interface. After connection to the power supply, it takes approximately 1 minute until the datalogger responds via the network.

3.8.2 elproLOG ANALYZE - Datalogger setup

Of the 8 ECOLOG-NET LR8sensors, 4 user-defined measurement units can be represented in the elproLOG ANALYZE software 3.8.2.2 Axis assignment.



The window "Datalogger Setup" is used to define the radio and measurement parameters.

Radio datalogger
setup

Radio parameters

1. Select list for the transmitted frequency
2. Select list for the radio channel being used
3. *Radio ID*

The assignment of the measuring channels to the ID numbers corresponds to the definitions on the type label.

ID number



THE RADIO SENSORS ARE PROVIDED WITH FIXED ID NUMBERS DURING PRODUCTION THAT CANNOT BE CHANGED BY THE ELPROLOG ANALYZE SOFTWARE. THIS WAY IT CAN BE ASSURED THAT EACH NUMBER IS ONLY ASSIGNED ONCE. DATA CAN ONLY BE CAPTURED IF THE SELECTED TRANSMISSION FREQUENCY AND THE CHANNEL FOR THE RADIO DATALOGGER AND ITS RADIO SENSORS ARE IDENTICAL.

Sensors

4. *S1 ... S8*
Check boxes are used to select sensors for recording.



5. *Description*
Free text box

6. *Type*
One of the predefined measurement ranges can be assigned to the measuring channel.

4. Radio sensors

Measurement parameters

The measuring parameters are general guidelines that depend upon the monitoring function being performed.

- Mode
- Log start
- Log interval
- Module description
- Close, program

3.8.2.1 Sensor profile

Open the window to parameterize the radio sensors that are appropriate to the connection of 4-20mA transmitters.

Sensorprofile

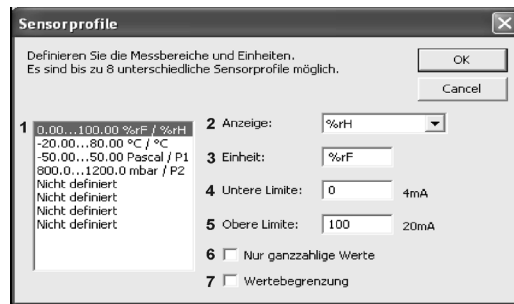

1. By selecting a profile, it is possible to define the measurement range and the unit
 Items 2 to 6.
2. Menu for selecting the measurement units shown on the display.
 The measurement units °C, °F and %rH are represented on the display. For all other units, select one of the 4 items (items 1 to 4). The items are numbered from top (1) to bottom (4) (3.4 Display).
3. The graphic function of the elproLOG ANALYZE software can represent up to 4 independent y-axes. Each of these axes can be assigned its own measurement unit.
 The unit text may not contain a semicolon (;) since this character is used by default as a separating character for communication with the elproMONITOR.
4. Measurement scaling in accordance with sensor settings for the lower limit of the measurement range.
5. Measurement scaling in accordance with sensor settings for the upper limit of the measurement range.
6. Scaled measurements are rounded and represented as whole numbers.
7. Limit function for measurement values outside of the measurement range for the defined range.
 Measurements above the measurement range result in O.F.
 Measurements below the measurement range result in U.F.
 N.C. is not shown
 6.1 Radio Datalogger

3.8.2.2 Axis assignment

Open the window that enables the assignment of sensors to the 4 representable Y axes in the elproLOG ANALYZE graphic.

Achsenzuordn.

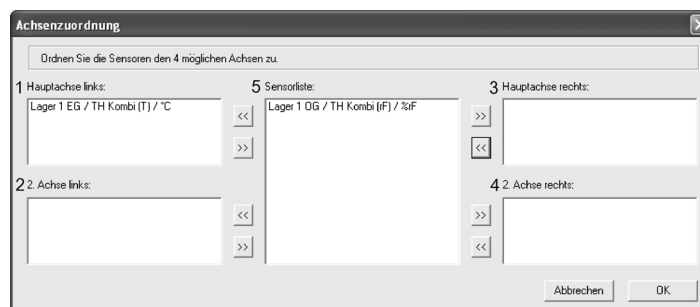

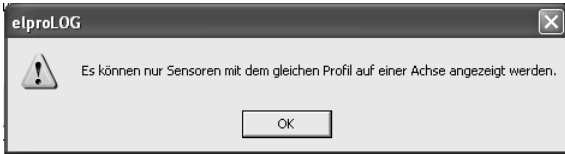

1. Main axis left
2. Auxiliary axis left
3. Main axis right
4. Auxiliary axis right
 The difference between the 4 axes may be in range or value. The main axes are the dominant axes in the scaling of the graphic.
5. List of all possible sensors that are not yet assigned to an axis.

Unit and measurement range 



Only sensors with the same unit and the same measurement range may be assigned to the same axis.





Data from multiple dataloggers 



elproLOG ANALYZE Function: Overlaying
 At present, mutual overlaying is not available for the ECOLOG-NET LR8.

3.8.3 elproLOG ANALYZE- Extended setup



Name	Function
Direct calibration through the input of values ...	This function is used to calibrate the sensors.
Set calibration date	This function enters the current date as the calibration date into the status of the radio datalogger.
Definition of the alarm thresholds...	 3.8.4 Definition of threshold values and alarm parameters The internal buzzer is also switched on/off in this window
Reset alarm	This function is used to acknowledge an alarm message.
Set date and time...	Used to adjust the internal clock on the radio datalogger.
Configure logger display...	 3.4 Display
Configure communication settings...	Settings for terminal mode communication  D-HC-6001Ax
Set temperature unit...	Selection of temperature units used. A selection can be made between °C and °F
Set new password...	Set a password. Delete: Entering a password in the "old password" line alone deletes the password
Programming of battery change time...	This function restarts the radio datalogger after a battery replacement ( 2. General application and safety information).

3.8.4 Definition of threshold values and alarm parameters

Threshold values and alarm parameters are defined in the "Alarm parameters setup" window. Threshold monitoring is only performed by sensors that have been specified in the measurement function. An alarm is triggered by the following conditions:

Conditions



- The measured value must be outside the defined tolerance range, i.e. the measured value is higher than the maximum allowable threshold value or lower than the minimum allowable threshold value.
- The threshold violation must exceed the defined alarm delay times.
- The threshold violation remains active until the measured value reaches the defined tolerance range again.

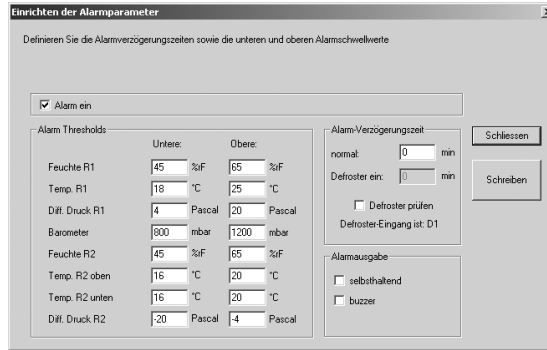
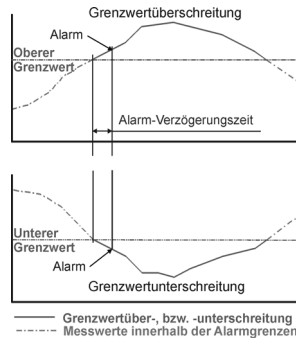

3.8.4.1 Window: Setup of Alarm parameters

Name	Function
Alarm on	Activate this checkbox to switch on the alarm threshold function, 3.6 Threshold value function / alarm parameters.
Alarm thresholds	Input fields for the lower and upper threshold values.
Alarm delay time	<ul style="list-style-type: none"> - normal An alarm is not triggered until the threshold violation has lasted longer than the specified time. <ul style="list-style-type: none"> - Defrost on If the "Check defroster" function is active and defrost contact D1 is closed, then an alarm is not triggered until the threshold violation has lasted longer than the time specified at this enter field.
Alarm output	This mode is used for all applications where the alarm contact controls an external device such as a flash or a telephone dialing unit. <ul style="list-style-type: none"> - No selection made The text: ALARM is displayed for the duration of the threshold violation. The alarm contact is closed for the duration of the threshold violation. <ul style="list-style-type: none"> - self-sustaining This mode is used for all applications where the alarm contact controls an external device such as a flash or a telephone dialing unit. The text: ALARM is displayed until a manual reset is executed. The alarm contact remains closed until a manual reset is executed. <ul style="list-style-type: none"> - buzzer Switches the buzzer on and off
Close / write	These buttons are used to program the radio datalogger and to close the "Setup of Alarm Parameters" window.

3.9 Pin assignments and connections

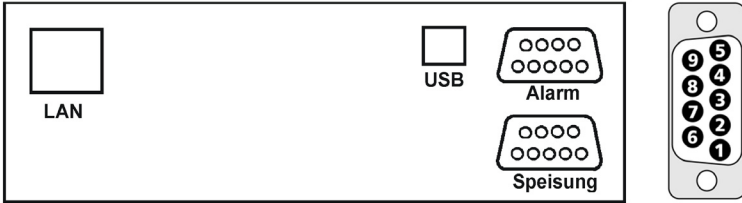

USB: connection for local analysis and programming

LAN: RJ45 for network connection

3.9.1 Alarm

white plug
DB9 female
Part no. 800506

Pin	Signal	Function
1	sb	Alarm contact (relay contact)
2	Gnd	Ground
3	Gnd	Ground
4	Alarm 1	Alarm output 1
5	V out	Alarm power supply (logger operating voltage)
6	sc	Alarm contact (relay contact)
7	sa	Alarm contact (relay contact)
8	Gnd	Ground
9	Gnd	Ground

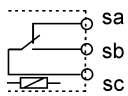

Alarm contact (relay contact)
Relay contact represented in dead state.
Connection sa - sc: Alarm
Connection sb - sc: no a Alarm
This relay is actuated (sb - sc) as soon as the power supply is available.
Switching load max. 42VAC or VDC; 500mA

Alarm contact

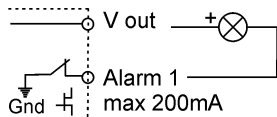

Alarm output 1(open)
Semi-conductor contact! Use only for DC voltage (DCV)
- Opens in the event of an alarm
- No floating contact
- Alarm cable max. length 15m

Alarm output 1

3.9.2 Supply, Contact inputs , Alarm 2

External power supply unit
Contact input and Alarm 2
Plug red DB9 male
Part no. 800505

Pin	Signal	Function
1	Alarm 2	Alarm output 2
2	D1 external	Contact input 1
3	D2 external	Contact input 2
4	Gnd	Ground
5	V in	External power supply (logger operating voltage)
6	Gnd	Ground
7	Gnd	Ground
8	Gnd	Ground
9	Gnd	Ground



FOLLOW THE SAFETY AND APPLICATION INSTRUCTIONS OF THE POWER SUPPLY UNIT.

Contact input 1 and 2

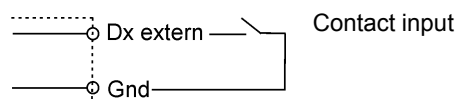

Alarm output 2

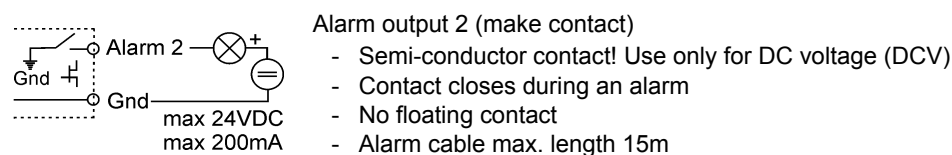

External power supply unit

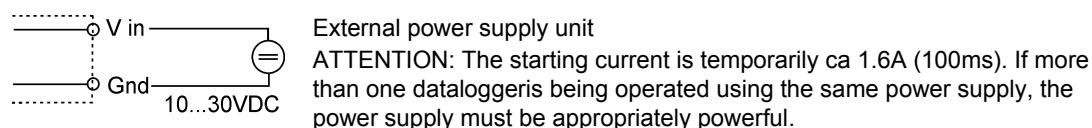

3.10 Alarm diagrams

3.10.1 Alarm; Connector white

Alarm = threshold violation

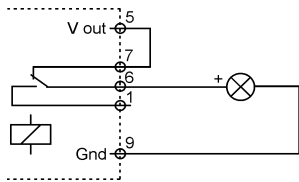

- Alarm: Contact open
- Datalogger requires an external power supply for signaling
- ☞ 3.9.2 *Supply, Contact inputs, Alarm 2*
- Relays
- Switching load max. 42VAC or VDC; 500mA

Alarm = Threshold value violation or failure of external power supply

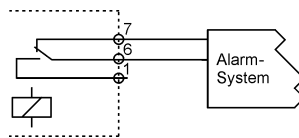

- Alarm: Contact open
- Relays
- Switching load max. 42VAC or VDC; 500mA

Alarm = Threshold value violation, failure of external power supply or cable break

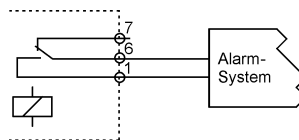

- Alarm: Contact open
- Relays
- Switching load max. 42VAC or VDC; 500mA

Alarm = Threshold value violation or cable break

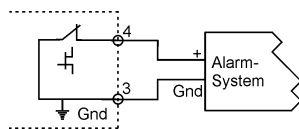

- Alarm: Contact open
- Datalogger does not require external power supply
- Semi-conductor contact! Use only for DC voltage (DCV)
- Switch load max. 24VDC; 200mA

3.10.1.1 Elpro telephone dialing device

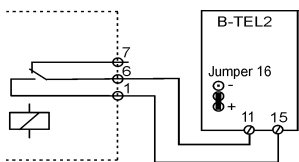

- Alarm: Threshold violation, loss of datalogger power or cable damage between datalogger and telephone dialing device.
- Jumper 16, see image
- Settings B-TEL 2
- Set "Connection type" to "positive command"

3.10.2 Supply; Connector red

Alarm = Threshold value violation

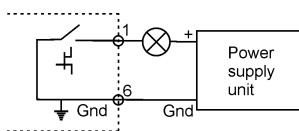



- Alarm: Contact closed
- Semi-conductor contact! Use only for DC voltage (DCV)
- Signalization has its own power supply
- Switch load max. 24VDC; 200mA

3.11 Maintenance

Maintenance schedule

To ensure proper datalogger functioning, the following steps should be part of a periodic maintenance schedule:

- Perform radio datalogger readout and save the data
- Test the alarm function, if implemented
- Check the quality of the radio connection to the radio sensors ( 4.2.3 *Transmitted frequency & radio channel*)
- Replace the battery ( 1.1 *Radio Datalogger* and 7.5.2 *Accessories*)

Battery

Monitoring of the battery is based on an energy consumption count. For this reason, only the specific manufacturer recommended battery should be used. Do not remove the battery from the logger when it is not in use. The use of third party batteries or removal of batteries will produce incorrect status information at the battery indicator.

Replacing battery



AFTER THE BATTERIES ARE CHANGED, THE BATTERY CHANGE TIME MUST BE SET (ELPROLOG ANALYZE SOFTWARE - EXTENDED SETUP - PROGRAMMING BATTERY CHANGE TIME...) OTHERWISE THE ENERGY COUNTER WILL NOT FUNCTION CORRECTLY!

3.12 Power failure

In the current version, battery life in the radio datalogger ECOLOG-NET LR8 is approx. 3 months with a complete loss of power (backup). All of the logged data is retained. This condition is represented by 4 small circles in the measured value display.

 3.4 *Display - Battery low*

Battery lifetime



No data is logged (<=min).

4. Radio sensors

With the radio sensors associated to the ECOLOG-NET LR8 radio datalogger temperature and humidity values and 4-20mA signals could be recorded.

4.1 Types

Temperature

- RT1e 1 external Pt100 temperature sensor
 - RT2e 2 external Pt100 temperature sensors
- The external Pt100 sensors can be used with 3- or 4-wire connections.

Temperature and Humidity

- RTH1i 1 internal humidity or temperature sensor
- RTH1e 1 external humidity or temperature sensor with 3m cable

4-20mA signal

- RA2e 2 external 4-20mA transmitters

4.2 Initial startup

4.2.1 RTxx .. RTH1x - Temperature and Humidity

The radio sensor casing contains various operating equipment, 3 batteries and the sensor connections. Technical data and the assignment of terminals in the :SENSORS" field 7.3 Radio sensors

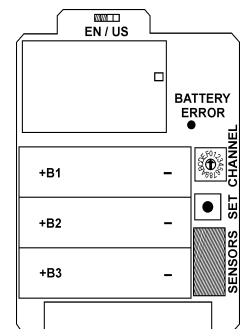

The radio sensors uses 3 lithium 3.6V batteries. The battery capacity is sufficient for operation time of 1.5 - 5 years.

Poor radio connection or low ambient temperatures may reduce battery lifetime. 7.3.1 Battery lifetime

Replacement batteries 7.5.2 Accessories

Batteries

BATTERY ERROR

This LED lights up red when the battery is inserted incorrectly.

SET key

The battery counter is reset by pressing and holding the SET key (6 seconds).

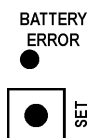

Battery counter

The condition of the batteries is documented in the radio datalogger status elproLOG ANALYZE.

4.2.2 RA2e - 4-20mA signals

Inside the radio sensor housing, there are various control elements, the terminals for two 4-20mA transmitter and for the required supply voltage.

Technical data and terminal assignments 7.3.4 RA2e - 2 external 4-20mA transmitters.

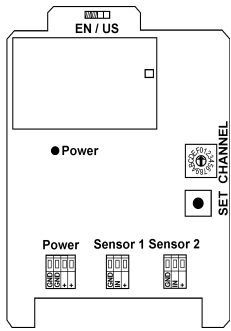

Power supply unit

For the operation of the radio sensor, a supply voltage of 24VDC is required. The output power of the power supply unit depends on the total power consumption of the transmitters and the radio sensor. Power consumption of a radio sensor 7.3.4 RA2e - 2 external 4-20mA transmitters
 Specifications of the available power supply units 7.5.2 Accessories

Power

PWR

This LED lights green, if the required supply of 24VDC is applied.

FOLLOW THE SAFETY AND APPLICATION INSTRUCTIONS OF THE POWER SUPPLY UNIT.

4.2.3 Transmitted frequency & radio channel

The transmitted frequency and the radio channel used are defined using the positions of the internal switches. Three frequency bands, 433MHz and 868MHz for Europe (EN) and 915MHz for the USA (US) can be used. When using multiple LR8 dataloggers, it is recommended that each datalogger is operated on a separate channel. 7.1 Radio settings and 3.8.2 elproLOG ANALYZE - Datalogger setup



Appropriate antennas are to be used for every frequency band.

SET

SET key

By quickly pressing the SET key (1 second), the settings are acknowledged and the test of the radio connection is started. The test lasts approx. 2 seconds. The test result is represented by repeated color blinking in the status display at a rate of 1 per second.

Status display - test result

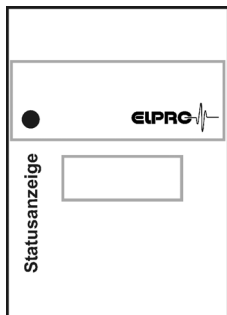

Quality of the radio connection		Blinks, number	Color
good radio connection	100%	5	green
↓	80%	4	green
	60%	3	green
	40%	2	green
	poor radio connection	20%	1
No radio connection or wrong settings*		1	red

In the event of a poor test result, shifting the radio sensor can lead to an improvement in the radio connection 2.1 Antenna position.

If no radio connection can be established, the transmitted frequency and the channel settings should be checked. A radio connection is only possible if all of the radio sensors being used and the assigned radio datalogger have the same setting Status of the radio datalogger in elproLOG ANALYZE.

If the radio channel needs to be changed during operation, it is necessary to briefly press the SET key after selecting the new channel.

Radio channel change

4.3 Operation

Undisrupted operation is indicated by a green, blinking light of the status indicator at intervals of 10 seconds.

Status indicator

Status indicator - Operation

Quality of the radio connection	Blinks, number	Color
good radio connection	1	green
No radio connection or wrong settings*	1	red

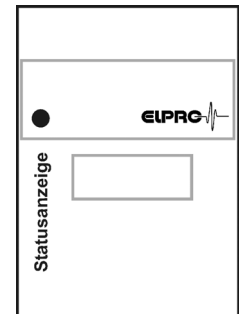

***) ALWAYS ENTER BOTH ID NUMBERS IN THE LOGGER CONFIGURATION FOR 2 CHANNEL RADIO SENSORS. IN ELPROMONITOR THE UNUSED CHANNEL HAS TO BE DISABLED.**

4.4 Maintenance

4.4.1 RTxx .. RTH1x - Temperature and Humidity

Maintenance schedule

To ensure proper functioning of the radio sensors, the following steps should be part of a periodic maintenance schedule:

- Calibrate radio sensors
- Replace batteries  4.2.1 RTxx .. RTH1x - Temperature and Humidity and 7.5.2 Accessories

Replacing battery

Monitoring of the battery is based on an energy consumption count. For this reason, only the specific manufacturer recommended battery should be used. Do not remove the battery from the logger when it is not in use. The use of third party batteries or removal of batteries will produce incorrect status information at the battery indicator.

Measured value display

After the new batteries are installed, the display in the ECOLOG-NET LR8 changes from "n.c." to the measured value display.



AFTER THE BATTERIES ARE CHANGED, THE SET KEY MUST BE PRESSED AND HELD FOR 6 SECONDS, OTHERWISE THE ENERGY COUNTER WILL NOT FUNCTION

4.4.2 RA2e - 4-20mA signals

Maintenance schedule

To ensure proper functioning of the radio sensors, the following steps should be part of a periodic maintenance schedule:

- Calibrate the radio sensors with a 4-20mA current source
- Calibrate the transmitter

Replacing battery

There is no battery required to operate the radio sensor.

5. Installation

The following chapter describes the step by step sequence of actions for the initial startup of the radio datalogger and its radio sensors.

1. Mount the radio datalogger and radio sensors at the place of use in accordance with the planning and connect the network, power supply, contact inputs, alarm outputs and sensors.

Connection test 

2.  4.2.3 *Transmitted frequency & radio channel*

3. Communication test LAN
Check communication - PING
Checking the network configuration and function test of the communication with elproLOG ANALYZE and checking the quality of the radio connection to the radio sensors

PING 

4. elproLOG ANALYZE
Parameterizing the datalogger,  3.8 *Configuring the radio datalogger.*

elproLOG ANALYZE 

5. elproMONITOR
This program is used for the on-line measured value display. For a detailed description of the functions and application, see  SM3031E.

elproMONITOR 

6. Verification of the installation
Check the installation and ensure that sensor positions, alarm parameters and network addresses are correct. Current calibrators can be used as an aid in simulating defined measured values.

7. Documentation
Documentation for the implemented configurations. Log the network parameters on a status printout from the radio datalogger.

IP address 

 Record IP address on the type label of the radio datalogger. This is the most simple way to identify the radio datalogger at installation!

6. Status and error messages

6.1 Radio Datalogger

6.1.1 Datalogger display and elproLOG ANALYZE

Display elproLOG ANALYZE

ALA	--	Additional alarm text in the power saving mode
CON	--	Radio datalogger is communicating with the software
USB	--	Communication via the USB connection
LAN	--	Communication via the LAN connection
dISP	Measured value	The measured value is outside of the range that can be displayed (-999 ... 9999). The measured values are however correctly logged.
Strt	--	The radio datalogger is waiting for the log start time programmed at menu item: Datalogger setup
StOP	--	Radio datalogger is in Start/Stop mode and the memory is full. No further measured values can be logged. In order to resume data logging, the logger must be reprogrammed. This is the condition upon delivery of ECOLOG-NET LR8.
U.F.	<=min	The radio sensor never had a connection to the radio datalogger. RA2e: The measurement channel is activated but there is no sensor connected to channel 1 RTxx: Measurement channel is activated but there is no sensor connected
	- O.F. - O.F. - C.FO - C.FO - random - random value Measured value	
C.Fd	C.F.	Faulty radio datalogger
n.c.	N.C.	RTH1x: Measurement channel is activated but there is no sensor connected RA2e: The measurement channel is activated but there is no sensor connected to channel 2

6.1.2 Status in elproLOG ANALYZE

RAM IMG-BMP destroyed

This error message appears in the radio datalogger status report in line: Module time. The cause of this error message can, for example, be a battery change if the battery change time was not programmed (3.11 Maintenance).

System resets since last reprogramming.

This error message can appear in the radio datalogger status report in the line: Last reprogrammed on. It is the result of the reset counters. All entries in the alarm protocol will be erased!

Battery

The condition of the batteries (radio datalogger & radio sensors) is presented in the status information (elproLOG ANALYZE) of the radio datalogger.
Battery replacement: 3.11 Maintenance

The version of the firmware is documented in the status.

Firmware

6.1.3 Messages in elproMONITOR

Text

UNDEF	Undefined
G.F.	General Error
S.C.	Short Circuit
N.C.	Not Connected, loss of radio connection
O.F.	Range Overflow
U.F.	Range Underflow or the radio sensor never had a connection to the radio datalogger
C.FO	Conversion Failure Overflow, no sensors connected
C.FU	Conversion Failure Underflow
C.FD	Conversion Failure Data
C.FG	Conversion Failure General
DISP	Display Range Error

6.2 Radio sensor

6.2.1 Status indicator

Operation Blinks green at an interval of 10 seconds

Failure The interruption of the radio connection is indicated by a red blinking light at an interval of 10 seconds. Reestablishing the radio connection can take up to 1 minute.

Connection test Blinks green / red 4.2.3 *Transmitted frequency & radio channel*

In the housing: This LED lights up red when if one of batteries is inserted incorrectly.
BATTERY ERROR

6.2.2 Status in elproLOG ANALYZE

The condition of the 3 batteries is displayed in the status information (elproLOG ANALYZE) of the radio dataloggers.

Battery exchange: Maintenance, see: 4.4 *Maintenance*

Batteries

Information regarding the sensor data and the assignment of the radio sensors to the radio datalogger is documented in the status of the radio datalogger.

Assignments

7. Technical data

7.1 Radio settings

Europe / USA / Canada

Frequency band	Europe	USA / Canada
433 MHz	permitted frequencies	May not be used! These frequency bands are already assigned to satellite flight and mobile communication!
868 MHz		
915 MHz	May not be used! This frequency band is reserved for railway radio!	permitted frequency

Chan-nel	Europe		USA / Canada	
	ETSI (MHz)	Color coding of the aerial	FCC (MHz)	Color coding of the aerial
0 - 9	433	red	915	yellow
A - F	868	gray	915	yellow

Aerial

- External, omnidirectional
- 1/4 wavelengths
- Synthetic whip
- RP-SMA connection
- The range is approximately 1000m in open areas and with line of sight

Signal weakening in air

Frequency band (MHz)	Signal weakening at a distance of:			
	10m		100m	
	dB	Factor	dB	Factor
433	45	180	65	1800
868	51	360	71	3600
915	51.5	380	71.5	3800

This example makes the dramatic relation between free space damping and transmission frequency very clear.

The damping factor for solid materials is 4 - 6 times higher than the factor for free space damping (air).

7.2 Radio datalogger

7.2.1 Use

Ambient temperature	-30°C ...55°C, non-condensing
Protective class	IP30
external power supply U_B	10 ...30VDC 24VDC; up to 1.6A startup current, 70mA operation

7.3 Radio sensors

7.3.1 Battery lifetime

Log interval	Transmitting interval [#]	Battery lifetime
1 min	1 min	approx. 1.5 years
2 min	1 min	approx. 1.5 years
3 min	2 min	approx. 3 years
4 min	2 min	approx. 3 years
5 min	2 min	approx. 3 years
>5 min	4 min	approx. 5 years

#) This is the update interval of the ECOLOG-NET LR8 display.

This information is valid for firmware version 1.05 or higher.

7.3.2 RT1e - 1 external temperature sensor RT2e - 2 external temperature sensor

Ambient temperature	-30°C ...55°C, non-condensing	
Protective class	IP54	
Power supply / operating time	3 internal lithium batteries / 2-3 years	
Measurement range / sensors	-200°C ...200°C / Pt100	
Accuracy (without sensor)	25.1°C ...200.0°C	+/- 0.50°C
	-10.0°C ...25.0°C	+/- 0.30°C
	-200.0°C ...-10.1°C	+/- 0.50°C
Length sensor cable	max. 20m	

Sensor connection

The terminal assignment for the Pt100 sensors is presented in the adjacent figure. Pt100 sensors with 3 or 4 leads can be used.

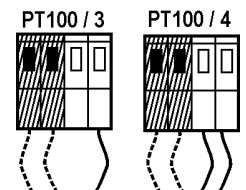

Connection cables

In order to guarantee that the sensor cable has good contact, the lead ends should have between 8.5 - 9.5mm of the insulation stripped

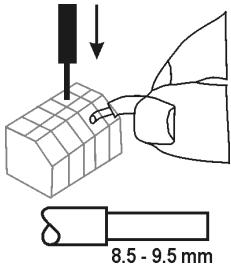

**7.3.3 RTH1i - 1 internal temperature and humidity sensor
RTH1ei - 1 external temperature and humidity sensor**

Ambient temperature	-30°C ...55°C, non-condensing			
Protective class	IP50			
Power supply / operating time	3 internal lithium batteries / 2-3 years			
Measurement range / sensors	-30°C ...55°C / 0 ...100%rH / combined T/rH measurements, new devices ^{1,2)}			
Accuracy	40.1°C ...55.0°C	+/- 0.8°C	90.1% ...100%	+/- 4.8%
	10.1°C ...40.0°C	+/- 0.4°C	10.1% ...90%	+/- 2.4%
	-10.0°C ...10.0°C	+/- 0.9°C	0% ...10%	+/- 4.8%
	-30.0°C ...-10.1°C	+/- 1.3°C		
Length sensor cable	max. 3m			



1. The following error components at 23°C are considered: Accuracy, repeatability, non-linearity, hysteresis
2. Devices after use or at recalibration (as found calibration) at 23°C:
The following error components are considered: accuracy, repeatability, non-linearity, hysteresis, creep
±4.0 %RH [10.1 %RH..90.0 %RH]
±5.8 %RH [0.0 %RH..10.0 %RH] and [90.1 %RH..100.0 %RH]

Error components

Sensor aging

**⚠ FOR THE COMBINING T/RH-SENSORS, THE PLUG POSITION MUST TAKEN INTO ACCOUNT.
THE PLUG IS USED FOR INTERNAL OR EXTERNAL SENSORS**

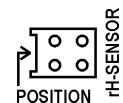

7.3.4 RA2e - 2 external 4-20mA transmitters

Ambient temperature	-30°C ...55°C, non-condensing
Protective class	IP54
Power supply	24VDC, 110mA
Working resistance	50 ...100Ohm
Measurement range	3.6 ...20.4mA
Resolution	0.003mA
Accuracy	± 0.04mA



i 110mA is the maximum power consumption of a radio sensors with two 2-wire transmitters. The power requirements by using 3-wire transmitters has to be determined by the transmitter data sheets.

Viewing ranges

Measurement range in user unit	0 ...2	3 ...21	22 ...210	211 ...2100	> 2100
Resolution per digit (saved value in datalogger)	≤ 0.003	≤ 0.003	≤ 0.03	≤ 0.3	> 0.3
Resolution in ANALYZE	0.001	0.001	0.01	0.1	1.0
Range Resolution (Representation range of "whole number" and / or "value limitation")	The scaled range (3.6mA ...20.4mA) will at step 6242 be resolved to +/- 1 the last number displayed.				

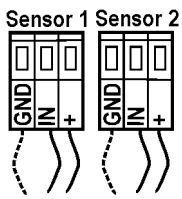

Transmitter connection

The terminal assignment for the 4-20mA sensors is presented in the adjacent figure. You may use 2- or 3-wire transmitters.

Radio sensor
RA2e

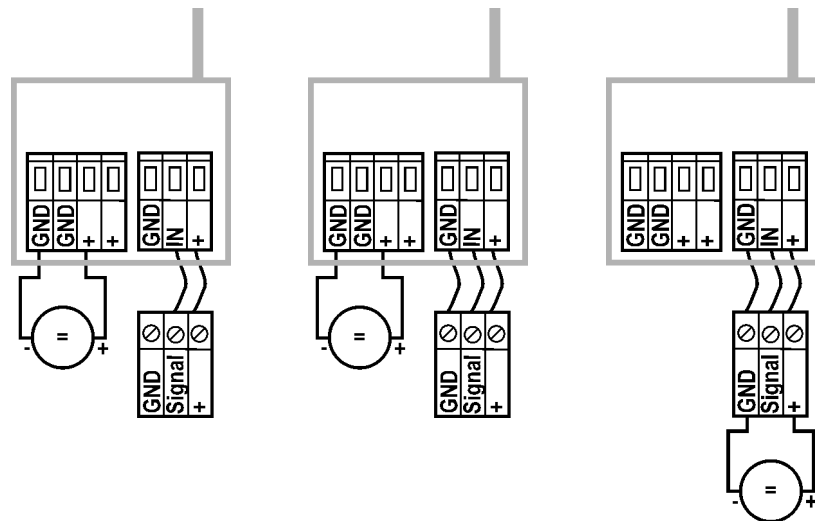

4-20mA Transmitter
2-wire connection

4-20mA Transmitter
3-wire connection

4-20mA Transmitter
3-wire connection with external power supply unit

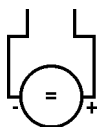

Power supply unit - Part no. 800494

The terminal assignment for the power supply is presented in the above figure. Specifications of the available power supply units 7.5.2 Accessories



FOLLOW THE SAFETY AND APPLICATION INSTRUCTIONS OF THE POWER SUPPLY UNIT.

Connection cables

In order to guarantee that the sensor cable has good contact, the isolation at the wire end should be stripped of between 7.5 - 8.5mm.

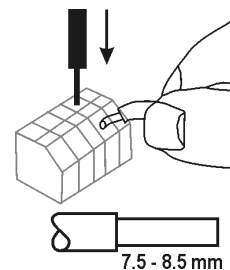

7.4 Marking for use in potentially explosive environments

Labels for potentially explosive environments 



Part no

800056	RTH1i EU ATEX
800058	RT1e EU ATEX
800060	RT2e EU ATEX
800062	RTH1e EU ATEX

7.5 Part no. System and Accessories

7.5.1 Radio datalogger-system

EU	US	
- 433MHz	912MHz	Transmitted frequency
- 868MHz		

Part no.		Function
800483	800484	ECOLOG-NET LR8 Radio datalogger
800860	800861	RT1e radio sensor - 1 x external temperature
800863	800864	RT2e radio sensor - 2 x external temperature
800857	800858	RTH1i radio sensor - internal temperature & humidity
800869	800870	RTH1e radio sensor - external temperature & humidity with 3m connection cable
800853	800854	RA2e radio sensor - 2 x 4-20mA transmitters external

7.5.2 Accessories

Part no.	Description
800494	Power supply unit with open ends 24VDC, 330mA / power supply for radio sensors
800496	Power supply unit with plug DB9 24VDC, 330mA
800498	Power supply unit plug DB9 24VDC, 1.6A
800506	Plug DB9, male, alarm, white
800505	Plug DB9, female, power supply, red
100818	Antenna 433 MHz Band ETSI, red
100819	Antenna 868 MHz Band ETSI, gray Included in scope of delivery
100820	Antenna 915 MHz band FCC, yellow Included in scope of delivery
800871	T/rH sensor RTH1i
800873	T/rH sensor RTH1i
800556	Replacement battery, set of 2, can be stored for at least 5 years, for radio datalogger
800557	Replacement battery, set containing 3 batteries, can be stored for at least 5 years, for radio datalogger

7.6 Dimensional drawings

Radio datalogger

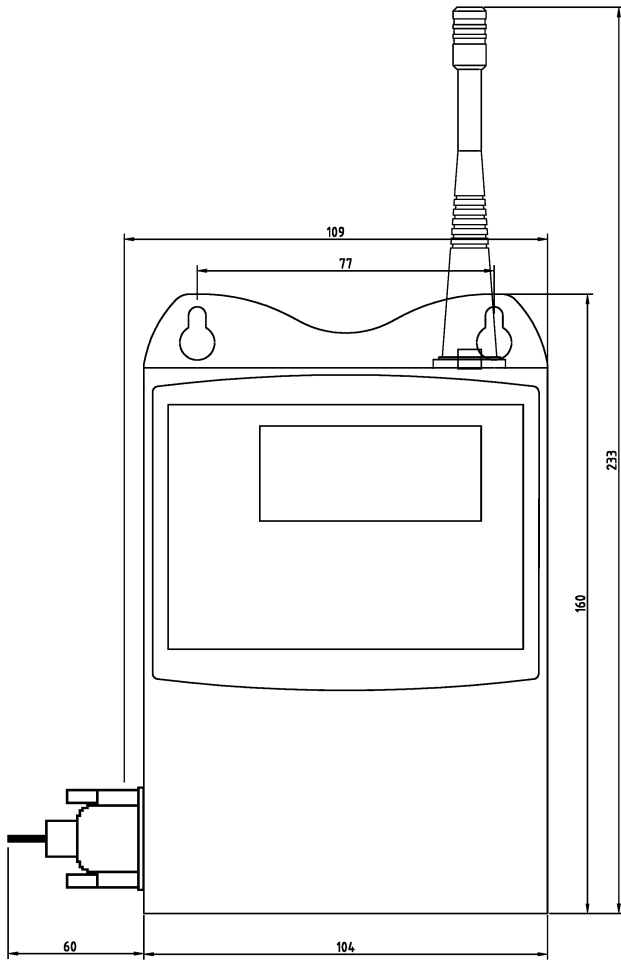

Housing depth: 50mm

Radio sensor

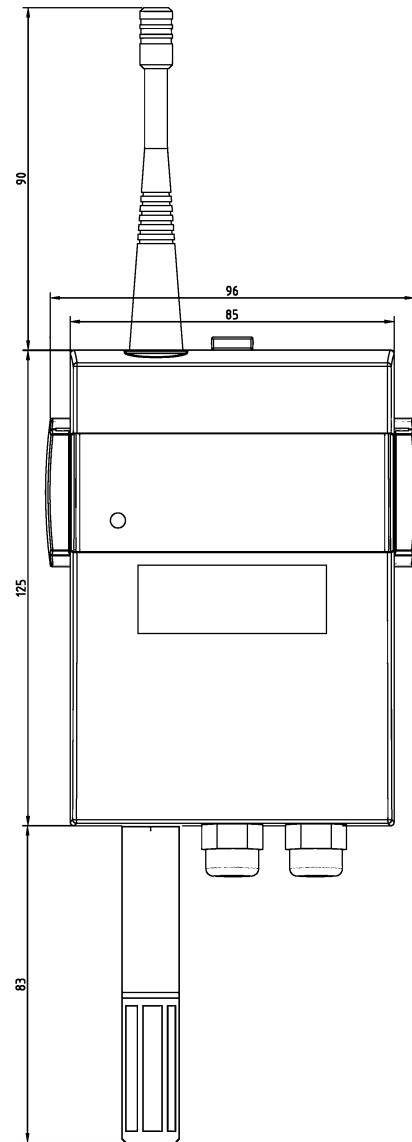

Housing depth: 50mm

8. Approvals

8.1 ETSI

The standards used in the evaluation of this product establish the threshold values for use in residential areas, business and commercial areas as well as in small businesses whereby the use of the product is intended for a business environment.

This includes the following, typical sites and spaces:

- Residential buildings/living spaces such as houses, apartments and rooms, etc.;
- Retail areas such as stores, supermarkets, etc.;
- Business premises such as municipal offices, banks, etc.;
- Entertainment businesses such as cinemas, public establishments, etc.;
- Outdoor locations such as gas stations, parking lots, sports facilities, etc.;
- Small business offices such as workshops, service centers, etc.

All areas of application are characterized by the fact that they are connected to the public low-voltage power supply. When using in a location in a severely electromagnetically disrupted environment such as typical industry environments, problems are likely to occur as a result of the product's inadequate interference immunity.

R&TTE Guideline 99/5/EG

EN 300 220-1 V2.1.1 (2006-04) EN 60950-1 (2006-11)

EN 300 220-2 V2.1.2 (2007-06)

EN 301 489-1 V1.8.1 (2008-04)

EN 301 489-3 V1.4.1 (2002-08)

EMV Guideline 2004/108/EG

EN 55022 (2008-05)

EN 50130-4 (2003-09)

EN 50371 (2002-11)

Low Voltage Directive 2006/95/EG

EN 60650-1 (2006-11)

EN 61000-6-1 (2007-10)

EN 61000-6-3 (2007-09)

8.2 Wireless Communication reliability

The communication reliability for the Elpro wireless sensor system, often referred to as Quality of service (QoS) is based on the following principles:

"The used modulation is of the "Gaussian Frequency-Shift Keying (GFSK)" type. This is a type of frequency shift keying modulation that uses a Gaussian filter to smooth positive/negative frequency deviations:

- Multi channel operation - ETSI/FCC compatible
- Address match for detection of incoming package
- Automatic retransmission of data packages
- Automatic CRC and preamble generation
- Build in test function for the radio signal
- Listen before talk (LBT) for the 433 and 868 MHz band
- Use of frequency hopping in the 915MHz band
- Limited number of sensors and transmitters used
- Installation requirements

The Elpro wireless system is made up of a receiver and a transmitter function in the wireless datalogger and in each wireless sensor. The receivers are divided into three classes, each having its own set of minimum performance criteria. The classification is based upon the impact the equipment has on persons in case of a failure.

The Elpro wireless sensor system complies to a class 2 system:

A failure causes loss of function but not physical risk of a person

**Risk assessment
for Receivers and
Transmitters**

8.3 FCC

In the USA, the FCC (Federal Communications Commission) regulates the use of frequencies for RF equipment. CFR 47 part 15 (Code of Federal Regulations) covers the unlicensed ISM bands. This is usually referred to as FCC part 15. All equipment must be certified with the FCC with the issuance of a Grant of Authorization by the FCC. When the product is approved, the FCC issues an identification number which the product must be marked with.

The part 15 sections for ISM band radios are:

- 15.19 / RSS-210: Manual requirements
- 15.35: General rules for certification measurements
- 15.105: Manual requirements
- 15.109: Radiated emission limits for unintentional radiators
- 15.205: Restricted bands of operation
- 15.209: Radiation limits for intentional radiators
- 15.247: Frequency Hopping and Spread Spectrum (FHSS), operation within the bands 902 - 928MHz, 2400 - 2483.5 MHz

A large part of the FCC Part 15 is about the limit of spurious emissions (harmonic component) and restricted bands. The main concept behind part 15 is that a general set of rules must be followed, but with exceptions for different application and frequency bands.

Spurious emissions and restricted bands

Emissions are divided into two parts:

- Unintended radiators, like receivers and transmitters in standby or other radiators requirements are given in 15.109
- Intended radiators, like active transmitters requirements are given in 15.209

There is a number of restricted frequencies according to 15.205 which can not be used for active transmissions, but spurious emissions can be produced. The levels are given in EIRP, Electrical Field Strength Power, at a distance of 3 meters

Frequency	Electrical Field Strength	EIRP
216-960MHz	200mV/m	-49.2dBm

915MHz band

White Paper

Section 15.249 gives the opportunity to use the 902-928MHz band with a output power of 50mV/m at 3 meters or -1.2dBm. The harmonics are limited to 500uV/m or -41.2dBm. This band is commonly referred to as the 915MHz band in the USA. There are no restrictions on duty cycle or the application.

Even higher output power can be used according to section 15.247. This implies the use of frequency hopping. The following requirements must be fulfilled for the use of the 902-928MHz band under section 15.247:

- Hopping channels shall be separated by minimum 25 kHz or the 20dB bandwidth of the hopping channel, whichever is greater.
- The system shall hop to channel frequencies that are selected at the system hopping rate from a pseudorandomly ordered list of hopping frequencies.
- If the 20 dB bandwidth of the hopping channel is less than 250 kHz, the system shall use at least 50 hopping frequencies and the average time of occupancy on any frequency shall not be greater than 0.4 seconds within a 20 second period.
- If the 20 dB bandwidth of the hopping channel is 250 kHz or greater, the system shall use at least 25 hopping frequencies and the average time of occupancy on any frequency shall not be greater than 0.4 seconds within a 10 second period.
- The maximum allowed 20 dB bandwidth of the hopping channel is 500 kHz.
- Maximum peak conducted output power is 1W in the 902-928MHz band if more than 50 hopping channels are used. The limit is 0.125W for 25 to 50 hopping channels.

This product has been tested and complies with the specifications for a Class B digital device, pursuant to Part 15 of the FCC Rules. These limits are designed to provide reasonable protection against harmful interference in a residential installation. This equipment generates, uses, and can radiate radio frequency energy and, if not installed and used according to the instructions, may cause harmful interference to radio communications.

FCC STATEMENT

However, there is no guarantee that interference will not occur in a particular installation. If this equipment does cause harmful interference to radio or television reception, which is found by turning the equipment off and on, the user is encouraged to try to correct the interference by one or more of the following measures:

- Reorient or relocate the receiving antenna
- Increase the separation between the equipment and receiver
- Connect the equipment to an outlet other than the receiver's
- Consult a dealer or an experienced radio/TV technician for assistance

This equipment complies with FCC radiation exposure limits set forth for an uncontrolled environment. This equipment should be installed and operated with minimum distance 20cm between the radiator and your body.

Radiation Exposure Statement

8.4 INDUSTRY CANADA

This Class B digital apparatus complies with Canadian ICES-003, RSS210.

The use of this device in a system operating either partially or completely outdoors may require the user to obtain a license for the system according to the Canadian regulations.

8.5 Conclusion

The data transfer between wireless dataloggers and wireless sensors could be seen as a safe way to exchange data.

This conclusion is valid as long as the wireless datalogger system is secured against any kind of fraud from the inside or outside of the company. This security task has to be fulfilled by the company internal IT department or other related departments.

More information regarding rules and requirements are found at:

<http://www.fcc.gov>

ETSI standards are found at:

<http://www.etsi.org>

The CEPT/ERC rec 70-03 are found at:

<http://www.ero.dk>

The ARIB STD-T66 regulation is found at:

<http://www.arib.or.jp/english/index.html>

The Australian/New Zealand Standard AS/NZS 4268:2003 are found at:

<http://www.standards.org.au>

Further information

9. Declarations of conformity

9.1 Declaration of conformity for ECOLOG-NET LR8



EG Konformitätserklärung
CE Déclaration de conformité
EC Declaration of conformity

Seite 1 von 1 | Page 1 de 1 | Page 1 of 1

Gültig ab | Valable à partir du | Valid from **08. 2016**
Zertifikat Nr. | No du certificat | Certificate No **10.111 08-16**

Beschreibung	Description	Description	
Datalogger Typ	Art. Nr.	Funktion	
Type	No d'article	Fonction	
Type	Part No	Function	
ECOLOG-NET LR8	800483	recording of up to 8 wireless sensors	
RT1i radio sensor	800866	for temperature recording 1 internal sensor	
RT1e radio sensor	800860	for temperature recording 1 external sensor	
RT2e radio sensor	800863	for temperature recording 2 external sensors	
RTH1i radio sensor	800857	for humidity and temperature recording 1 internal sensor	
RTH1e radio sensor	800870	for humidity and temperature recording 1 sensor with 3m cable	
RA2e radio sensor	800853	for 2 external current (4-20mA) signals	
Hersteller	Fabricant	Manufacturer	ELPRO-BUCHS AG, 9470 Buchs, Switzerland
Datei	Fichier	File	10.111 08-16 Conformity ECOLOG-NET LR
Richtlinien R&TTE	Directives R&TTE	Directives R&TTE	2014/53/EU
Standards			EN 300220-1 V2.3.1; EN 300220-2 V2.1.2 EN 301489-1 V1.8.1; EN 301489-3 V1.41
Richtlinien EMV	Directives CEM	Directives CEM	2014/30/EU
Standards			EN 61000-6-1:2005, EN 61000-6-2:2005
Richtlinien RoHS2	Directives RoHS2	Directives RoHS2	2011/65/EU
Standards			EN 50581:2012

Wir erklären, dass die oben aufgeführten Produkte den erwähnten Richtlinien und Normen oder normativen Dokumenten entsprechen.

Diese Erklärung gilt für alle Ausführungen innerhalb der Modell-Serie.

Nous déclarons que les produits décrit ci-dessus sont conformes aux dispositions de directives et les normes ou autres documents normatifs susmentionnés.

Cette déclaration est valable pour tous les modèles parmi cette série.

We declare that the products listed above are in conformity with the mentioned provisions of directives and the standards or other normative documents.

This declaration is valid for all versions of the above mentioned product series.

Buchs, den 31. August 2016

Buchs, le 31 août 2016

Buchs, August 31, 2016

ELPRO-BUCHS AG

CQO



Björn Niggemann

we prove it.

ELPRO-BUCHS AG | Langäulistrasse 45
 9470 Buchs | Switzerland
 T +41 81 552 08 08 | www.elpro.com



9.2 Confirmation of identical design



Baugleichheitsbestätigung

Confirmation of identical design

Confirmation des constructions identiques

Seite 1 von 1 | Page 1 de 1 | Page 1 of 1

Gültig ab | Valable à partir du | Valid from **08. 2016**
 Zertifikat Nr. | No du certificat | Certificate No **10.113 08-16**

Beschreibung Description Description	Art. Nr.	Funktion
Datalogger Typ	No d'article	Fonction
Type	Part No	Function
ECOLOG-NET LR8	800484	recording of up to 8 wireless sensors
RT1i radio sensor	800867	for temperature recording 1 internal sensor
RT1e radio sensor	800861	for temperature recording 1 external sensor
RT2e radio sensor	800864	for temperature recording 2 external sensors
RTH1i radio sensor	800858	for humidity and temperature recording 1 internal sensor
RTH1e radio sensor	800869	for humidity and temperature recording 1 sensor with 3m cable
RA2e radio sensor	800854	for 2 external current (4-20mA) signals
RA2e radio sensor	800853	for 2 external current (4-20mA) signals
Hersteller	Fabricant	Manufacturer
Datei	Fichier	File
Standards	Canada: RSS-210 Issue 8 US: FCC Rule Parts 15C	

Wir erklären, dass die oben aufgeführten Produkte das baugliche Funkmodul enthalten, welches den erwähnten Standards entspricht.

We declare that the products listed above are equipped with an identical radio module, corresponding to the mentioned standards.

Nous déclarons que les produits décrits ci-dessus contiennent le module radio identique qui répond aux normes mentionnées.

Buchs, den 31. August 2016
 Buchs, le 31 août 2016
 Buchs, August 31, 2016

ELPRO-BUCHS AG
 CQO

Björn Niggemann

we prove it.

ELPRO-BUCHS AG | Langäulistrasse 45
 9470 Buchs | Switzerland
 T +41 81 552 08 08 | www.elpro.com



9.3 Declaration of conformity for radio sensors in potentially explosive environments

2014/34/EU 

EG Konformitätserklärung CE Déclaration de conformité EC Declaration of conformity

Seite 1 von 2 | Page 1 de 2 | Page 1 of 2

Gültig ab | Valable à partir du | Valid from **08. 2016**
Zertifikat Nr. | No du certificat | Certificate No **10.114 08-16**

Beschreibung Description Description	Art. Nr.	Funktion
Datalogger Typ Type	No d'article Part No	Fonction Function
RT1e radio sensor ATEX	800058	for temperature recording 1 external sensor; see page 2 for sensor details
RT2e radio sensor ATEX	800060	for temperature recording 2 external sensors; see page 2 for sensor details
RTH1i radio sensor ATEX	800056	for humidity and temperature recording 1 internal rH/T sensor
RTH1e radio sensor ATEX	800062	for humidity and temperature recording 1 external rH/T sensor with 3m cable
ECOLOG-NET LA8F	800486	for 8 external current (4-20mA) signals
Hersteller Fabricant Manufacturer	ELPRO-BUCHS AG, 9470 Buchs, Switzerland	
Datei Fichier File	10.114 08-16 Conformity ECOLOG-NET LR ATEX 1_2	
Richtlinien R&TTE Directives R&TTE Directives R&TTE	2014/53/EU	
Standards	EN 300220-1 V2.3.1; EN 300220-2 V2.1.2 EN 301489-1 V1.8.1; EN 301489-3 V1.41	
Richtlinien EMV Directives CEM Directives CEM	2014/30/EU	
Standards	EN 61000-6-1:2005, EN 61000-6-2:2005, EN 61000-6-3:2006, EN 61000-6-4:2006	
Richtlinien ATEX Directives ATEX Directives ATEX	2014/34/EU	
Standards	EN 60079-0:2012; EN 60079-15:2010 EN 61000-6-2:2006; EN 60000-6-4:2006 EN 1127-1:2011	
Richtlinien RoHS2 Directives RoHS2 Directives RoHS2	2011/65/EU	
Standards	EN 50581:2012	

Wir erklären, dass die oben aufgeführten Produkte den erwähnten Richtlinien und Normen oder normativen Dokumenten entsprechen. Diese Erklärung gilt für alle Ausführungen innerhalb der Modell-Serie.

Nous déclarons que les produits décrit ci-dessus sont conformes aux dispositions de directives et les normes ou autres documents normatifs susmentionnés. Cette déclaration est valable pour tous les modèles parmi cette série.

We declare that the products listed above are in conformity with the mentioned provisions of directives and the standards or other normative documents. This declaration is valid for all versions of the above mentioned product series.

Buchs, den 31. August 2016
Buchs, le 31 août 2016
Buchs, August 31, 2016

ELPRO-BUCHS AG
CQO



Björn Niggemann

ELPRO-BUCHS AG | Langäulistrasse 45
9470 Buchs | Switzerland
T +41 81 552 08 08 | www.elpro.com



we prove it.



EG Konformitätserklärung
 CE Déclaration de conformité
 EC Declaration of conformity

Seite 2 von 2 | Page 2 de 2 | Page 2 of 2

Gültig ab | Valable à partir du | Valid from **08. 2016**
Zertifikat Nr. | No du certificat | Certificate No **10.114 08/16**

Beschreibung	Description						Funktion
Datalogger Typ	Art.Nr.						Fonction
Type	No d'article						Fonction
Type	Part No						Fonction
PT100 Sensors	800683	800690	800698	800705	800713	800724	for temperature recording
	800684	800691	800699	800706	800714	800725	
	800685	800692	800700	800707	800716	800726	
	800686	800694	800701	800708	800718		
	800687	800695	800702	800709	800719		
	800688	800696	800703	800710	800720		
	800689	800697	800704	800712	800722		
	ECA_PT100_SILxx						xx = Cable length in [m]; max. 30
Hersteller	Fabricant	Manufacturer				ELPRO-BUCHS AG, 9470 Buchs, Switzerland	
Datei	Fichier	File				10.114 08-16 Conformity ECOLOG-NET LR ATEX 2_2	

we prove it.

ELPRO-BUCHS AG | Langgüllstrasse 45
 9470 Buchs | Switzerland
 T +41 81 552 08 08 | www.elpro.com



Revision History

Author	Date	Version	Description
A. Gubler	30.09.2010	--	First edition
A. Gubler	01.12.2010	a	Error: Connection 3-wire Pt100 / Power supply unit
A. Gubler	02.02.2012	b	New: 4-20mA Radio sensor RA2e
A. Gubler	28.02.2014	c	Various changes and intrinsically safety ATEX - Europe
A. Gubler	26.06.2015	d	New technical data for rH/T sensor
A. Gubler	23.03.2016	e	New part numbers
A. Gubler	21.11.2016	f	New CE declarations

Index

Numerics

- 2/3-wire-Transmitter 38
- 3 / 4 wires 35, 38
- 4-20mA signal 28
- 4-20mA Transmitter 27
- 64,000 measured values 7

A

- Accuracy 35, 37
- Acknowledging alarm messages 14
- Aerial 11, 28, 34
- Alarm - DB9 25
- Alarm cable 24
- Alarm contact 25
- Alarm delay time 22
- Alarm diagrams 25
- Alarm forwarding 18
- Alarm output 25
- Alarm output test 13
- Alarm parameters 14, 22
- Alarm protocol 32
- Alarm signaling 14
- Ambient temperature 35, 37
- ATEX radion sensors 10
- Axes - Auxiliary axes 20
- Axes - Main axes 20
- Axis assignment 20

B

- Batteries 27, 30, 41
- Batteries - condition 32
- Battery 7
- Battery counter 21, 26, 27
- Battery discharge protection 7
- BATTERY ERROR 27, 33
- Battery lifetime 26, 35
- Battery low 12

C

- Calibration of the sensors 33
- Channel 11, 34
- Collective alarm function 14
- Communication test 31
- Connection - humidity sensor internal/external 37
- Contact input 24

D

- Datalogger - network configuration 18
- Datalogger - radio settings 19
- DB9 - Alarm 23, 24
- DB9 - Alarm contact 23
- DB9 - Alarm output 1 23
- DB9 - Alarm output 2 24
- DB9 - Alarm scheme 25
- DB9 - Contact input 24
- DB9 - Power supply 24
- Digi Device Discovery 18
- Display 12

- Display on/off 12
- Documentation for the installation 31

E

- ECOLOG-NET LR8 7
- elpro DEVICE DISCOVERY 18
- elproLOG ANALYZE 18, 31
- elproLOG ANALYZE default settings 11
- elproMONITOR 18, 31
- EN 1127 10
- EN 60079 10
- Environmental conditions 9
- Error messages 32
- ETSI 43
- Europe 28
- Explosion protection 10

F

- FCC 44
- Firmware Version 33
- Frequency 11, 28
- Frequency band 34

H

- Humidity 27
- Humidity sensor - cable 27

I

- ID number 8, 19
- Initial startup 9
- IP address 18, 31

L

- LAN 11

M

- Maintenance schedule 26, 30
- Measured value display 12
- Measurement range 21, 35, 37
- Measurement units 19
- Measuring channel 19
- Membrane keypad 7

O

- Operating range 38
- Overlaying 21

P

- Power failure 26
- Power LED 28
- Power supply 24, 35, 37
- Power supply unit 28, 38, 41
- Power supply unit for radio sensor 28
- Power-saving mode 26
- Precautionary measures 10
- Preparation 18
- Protection class 35, 37
- Pt100 27
- Pt100 - Zone 2 10
- Pt100 2/3 lead 35
- PWR indicator 28

R

- Radio channel 19, 28
- Radio connection 28
- Radio sensor 7
- Radio sensor adjustment 33
- RAM IMG-BMP destroyed 32
- Range 9
- Replacing battery 26, 30
- Resolution 37

S

- Sensor cable 35, 37
- Sensor connection 35, 38
- Sensor for 4-20mA 20
- SET key 27, 28
- Signal weakening 34
- Special environmental conditions 9
- Status indicator 28, 29, 33
- Subnet mask 18
- System resets 7, 32

T

- Telephon dialing device 25
- Telephon dialing device - DB9 25
- Temperature influence 9
- Temperature probe 27
- Threshold value function 14
- Threshold value violation 14
- Threshold values 22
- Time response 15
- Transmitted frequency 19
- Transmitting interval 35

U

- Unit 21
- USA 28
- USB connection 11

V

- Verification of the installation 31

W

- Working resistance 37

(Head Office)
ELPRO-BUCHS AG
Langäulistrasse 45
9470 Buchs
SWITZERLAND
E-mail: swiss@elpro.com



For local representatives see:
www.elpro.com