

# SHARP

## ELECTRIC OVEN

### MODEL: E042K

# OPERATION MANUAL

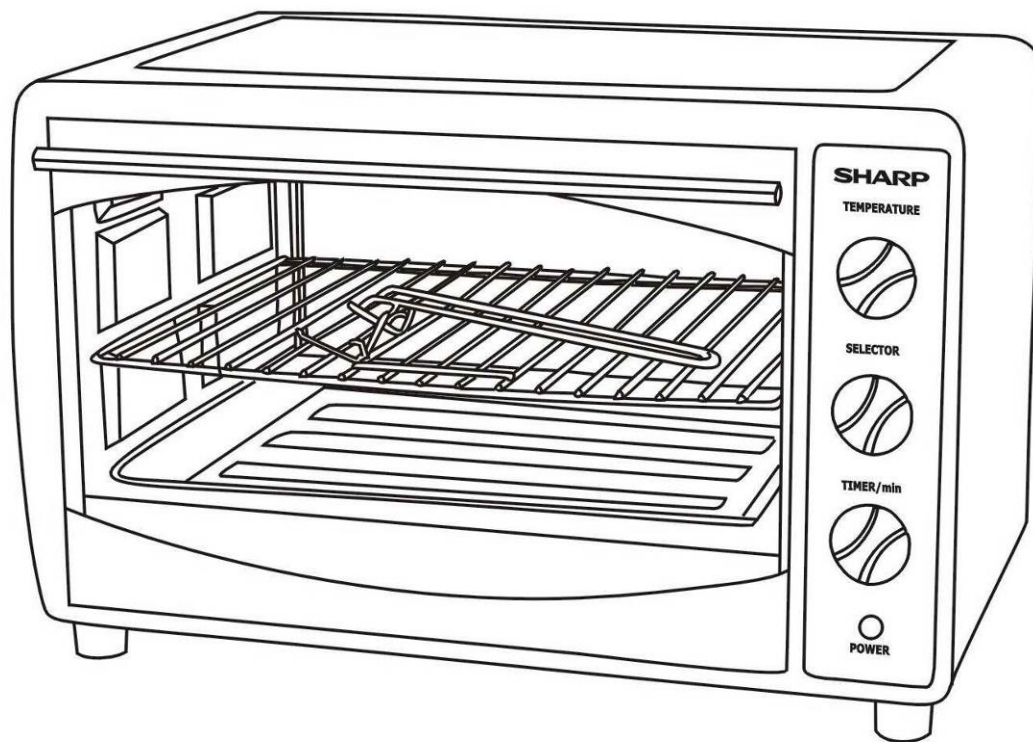

Before operating this appliance, please read these instructions completely

# PARTS IDENTIFICATION

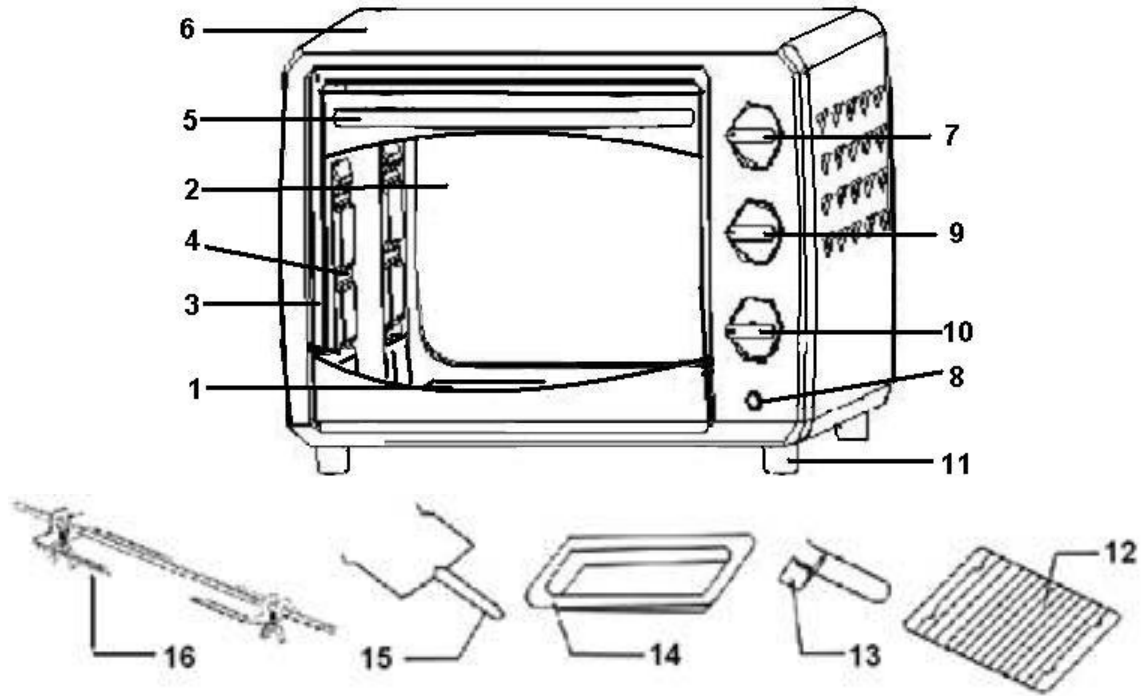

- |                    |                    |                |                       |
|--------------------|--------------------|----------------|-----------------------|
| 1. Heating element | 5. Door handle     | 9. Switch knob | 13. Tray handle       |
| 2. Glass door      | 6. Outer case      | 10. Timer knob | 14. Food tray         |
| 3. Inner case      | 7. Temp knob       | 11. Stand      | 15. Rotisserie handle |
| 4. Rack support    | 8. Indicator light | 12. Wire rack  | 16. Rotisserie fork   |

# CIRCUIT

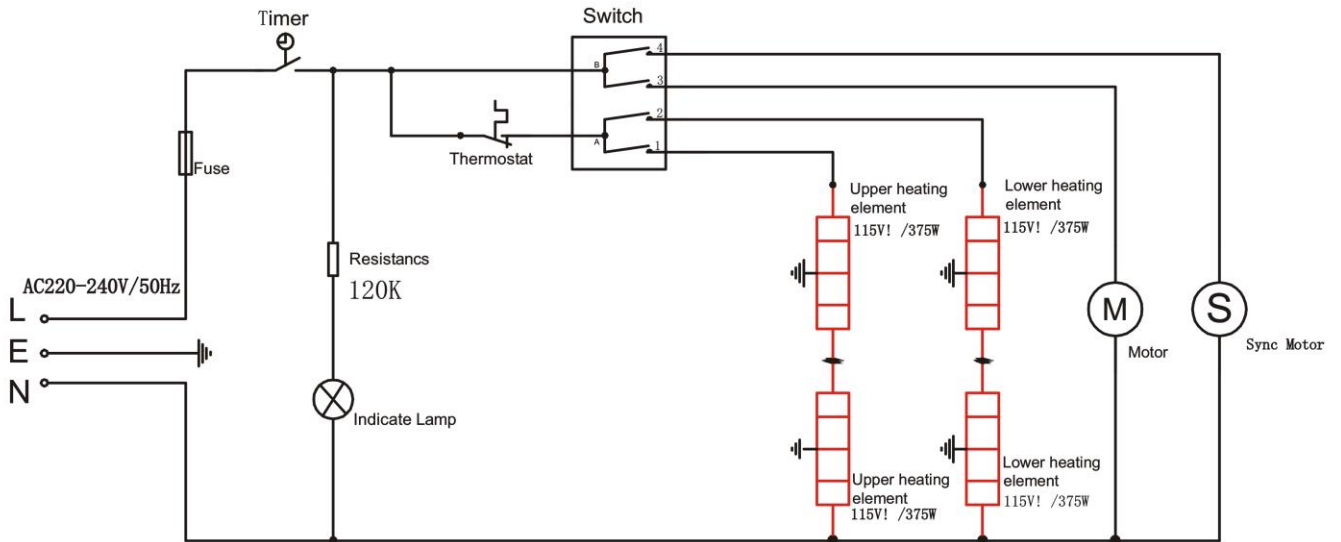

## SPECIFICATION

|                     |                   |
|---------------------|-------------------|
| Model NO.           | EO-42K            |
| Power supply        | 220-240V, 50/60Hz |
| Power consume       | 1800W             |
| Package measurement | 555*382*370mm     |
| Net weight          | 11.5KGS           |
|                     |                   |

## CAUTIONS

Special indication:

The accessory image varies from different models. Please refer to the actual model you buy.



Always use the food fork when inserting or removing the tray. Touching these will cause severe burns.

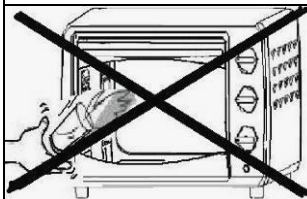

When hot, do not apply water to the glass window, it may cause the glass to break.



When unplugging the cord, always take hold of the plug itself. Never pull on the cord. Doing so could break the wires inside the cord.

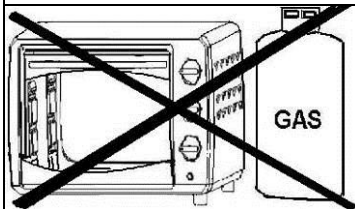

Do not position the unit close to a gas burner or other source of high temperature or do not direct an electric fan, etc, at the unit during **USE**. Doing so could prevent correct temperature control.



Do not wet the power cord nor handle the unit with wet hands. Always unplug the cord after use, or whenever the unit is to be left unattended. A malfunction while the plug is inserted into the outlet could cause a fire.



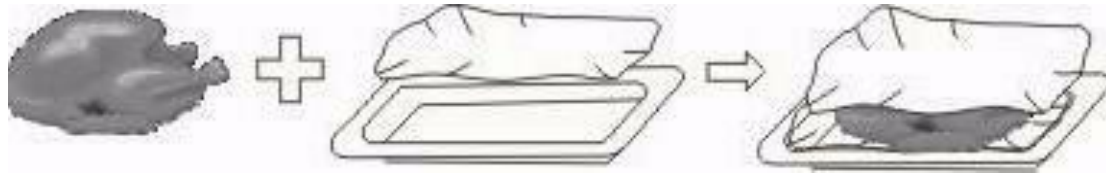

When cooking oil-splashing dishes such as roast chicken, it is recommended to put 2 sheets of aluminum foils on a tray in order to diminish oil splashing. Put one on a tray. Then oil will drip to a gap between foils.



## USE INDICATION

Special indication: the parts and accessory varies from different models. Please refer the image to the real item you buy.

### Food tray and baking net

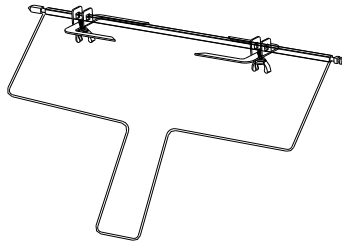
|  |  |  |
|--|--|--|
| <p>Food tray</p>                    | <p>Roast Chicken,<br/>Hamburg steak, Gratin,<br/>Sponge cake, almost all<br/>other oven-cooked foods</p> | <p>How to use tray<br/>handle</p>       |
| <p>Wire rack</p>                    | <p>Baked potatoes, Dry food</p>  |   |
| <p>Food tray and wire<br/>rack</p>  | <p>For food which will<br/>drip/boiled fish, etc</p>   | <p>Rotisserie forks and<br/>handle</p>  |

The trays are not perfectly square.

Note:

Be careful when removing pudding and other hot liquids.

## Rack Support

You can adjust the tray at 4 different positions according to the dishes you want to cook. For instance, when making macaroni gratin and you want to have the top part cooked the most, use the second or the second rack support. For roasting a chicken, use the fourth or the bottom rack support.

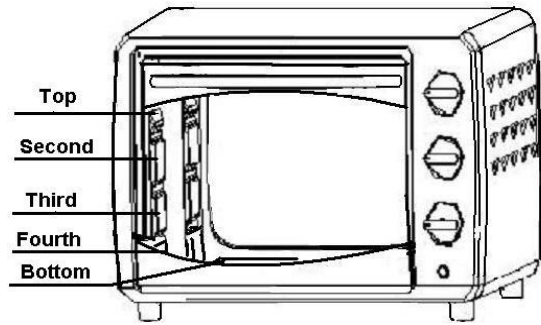

## Rotisserie Function

### Use with Rotisserie Forks

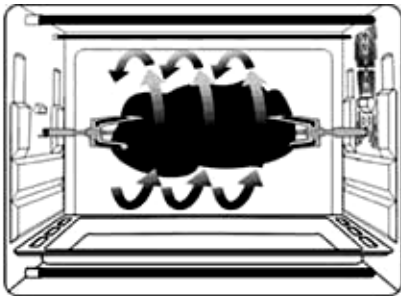

With this function, even baking will be provided. Rotisserie forks can carry food under 3 kilograms.

### Install Rotisserie Forks

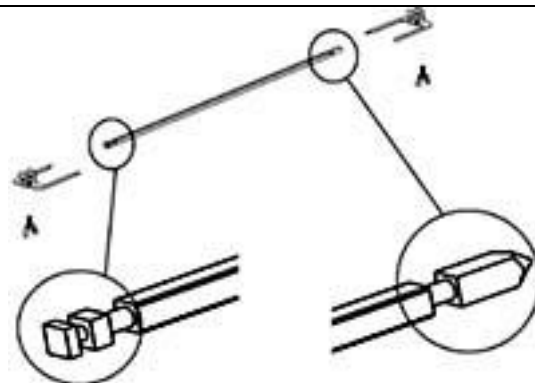

Left

Right

### Install Rotisserie Forks

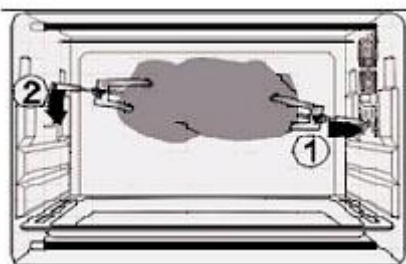

Install the Rotisserie Forks to the rotisserie hole, and then put it to the rotisserie tray.

### Remove Rotisserie Forks

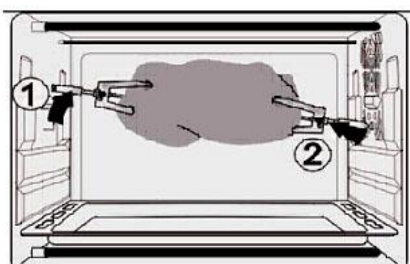

Use Rotisserie Handle to take out the Rotisserie Forks from the rotisserie tray, and then remove it from the rotisserie hole.

**CAUTION: Beware of HOT dripping oil!**

### Rotisserie Handle

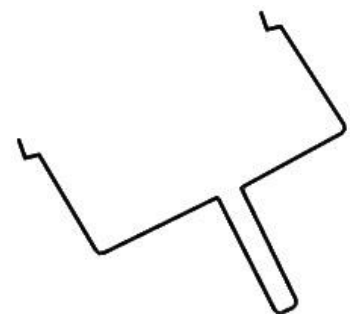

Please always use Rotisserie Handle to take out the Rotisserie Forks.

## Convection Function

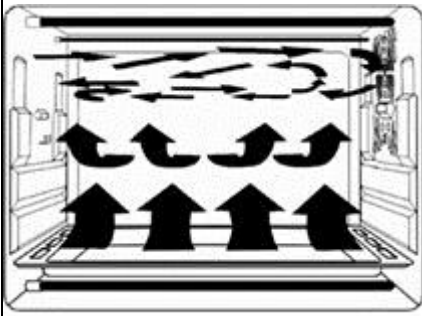

Featured with a special convection function, strong and absolute cycling airflow by making the heating more complete. Original flavor can be kept.

## Functional Control

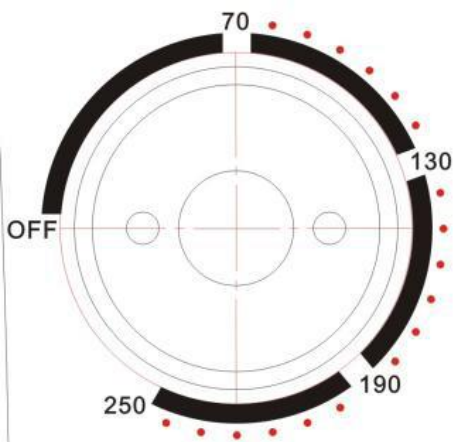

Temperature Control

Set the "Temperature Control" by turning clockwise to select the suitable temperature according to the dishes you are going to cook.

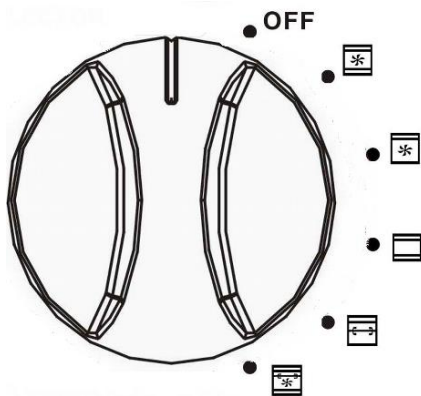

Function Control

Select the suitable heating element according to the dishes you are going to cook.



Upper & Lower Heating  
+  
Convection Function



Lower Heating  
+  
Convection Function



Upper & Lower Heating

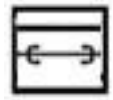

Upper Heating  
+  
Rotisserie Function



Upper & Lower Heating  
+  
Convection & Rotisserie Function

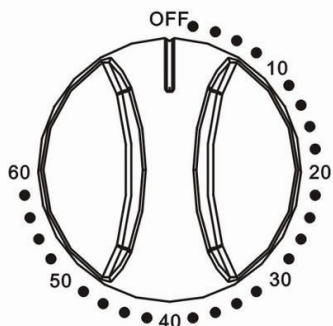

**Timer**

\*You can observe whether the heating elements are working or not by observing the front Indicator light.

1. Set the arrow on the "Timer" to the number which indicates the cooking time (minutes) according to the dishes you are going to cook.

2. Set the "Timer" by turning it clockwise. The oven will turn off automatically at the end of the selected time and a bell will ring.

- When setting the Timer to less than 5 min, turn it to more than 6 min. and then back to the selected time.

3. The oven can be turned off manually during cooking by turning the "Timer" anti-clockwise to the "OFF" position.

## METHOD OF CLEANING



Take off the plug and cool down before cleaning.

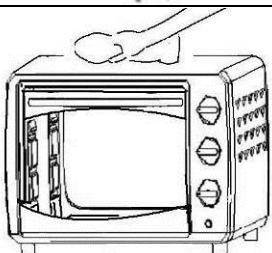

When cleaning, wash the interior and exterior surface, do not use hard brush or any others to wash, so as not to scrape the interior surface of the oven, and to protect the tray, the net and the food fork.



Do not use the toxic and abrasive cleaners such as gasoline, polishing powder, solvent.

## BAKING REFERENCE OF COMMON FOOD

| TYP OF FOOD  | TEMPERTURE | SITE(SHELF) | TIME  |
|--------------|------------|-------------|-------|
| Bread        | 180        | 3           | 9-13  |
| Cake         | 180        | 2           | 25-35 |
| Fish         | 250        | 2           | 10-15 |
| Chicken/Duck | 220-250    | 2           | 30-45 |
| Pancake      | 160        | 1           | 7-10  |
| Beef         | 250        | 2           | 8-15  |
| Egg/Peanut   | 125-150    | 2           | 6-10  |

|           |     |   |       |
|-----------|-----|---|-------|
| Hot Dog   | 200 | 2 | 6-10  |
| Hamburger | 240 | 2 | 10-14 |

## OPERATING INSTRUCTIONS

Before using the unit for the first time:

Heat the empty oven.

(1) Insert the tray and baking net.

(2) Set the heater operating switch to "UPPER & LOWER", set the temperature control dial to "250°C" and heat the empty oven for about 10 minutes.

Note:

There may be some smoke and a burning smell at first use, but this is not a malfunction.

Temperature control dial:

Set the Temperature Control Dial for the dishes which you are going to cook.

Heat Operating Switch:

Select "upper" "Lower" or "Upper and Lower" according to the dishes you are going to cook. You can observe whether the heaters are working or not by observing the front Indicator light.

UPPER(  ), LOWER(  ), UPPER & LOWER(  )

1. Set the arrow on the timer knob to the number which indicates the cooking time (minutes) according to the dishes you are going to cook.

2. Set the Timer by turning it clockwise.

The oven will turn off automatically at the end of the selected time and a bell will ring

• When setting the Timer to less than 5 min., turn it to more than 6 min. and then back to the selected time.

3. The oven can be turned off manually during cooking by turning the Timer counter-clockwise to the "OFF" position.

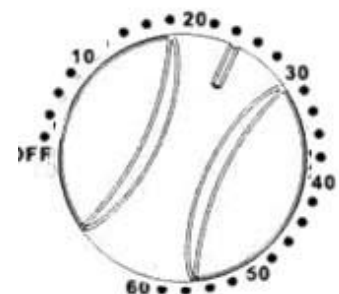



Note:

If the inside of the oven is dirty, cooking may take slightly longer than usual.

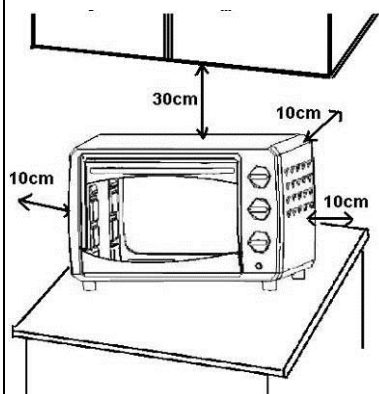
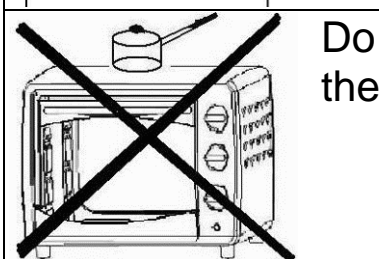
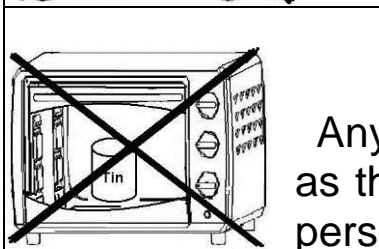

## CAUTIONS

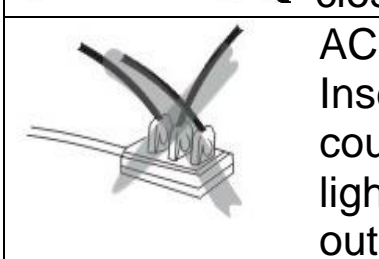
|   |  |
|---|--|
|    | <p>If the oven is positioned too close to a wall, the wall will be burned or stained. Be sure the curtain, etc., are not in contact with the body. Do not put anything between the bottom of the body and the surface on which it is set, an object so placed could be burned.</p> |
|    | <p>Do not put anything on the oven while using it, the heat could cause deformation, cracking, etc.</p>  |
|   | <p>Any bottled or tinned food can not be heated directly as the bottle or tin would be broken out and scald the person.</p>  |
|  | <p>Be careful! Not to burn yourself during use or immediately after use. The metal parts and glass window of the door become extremely hot during use. Be careful not to touch them when opening and closing the door.</p>   |
|  | <p>AC power must be taken from a properly wired outlet. Insert the plug completely into the socket. If it is not, it could become abnormally hot. Do not use an electric light outlet. Never connect multiple plugs to the same outlet.</p>  |

## MAINTENANCE

1. Other than cleaning mentioned in this instruction manual, no additional maintenance or servicing of this appliance is required.
2. Repairs, when necessary, must be performed at an authorized service facility.
3. This appliance is intended for HOUSEHOLD USE ONLY and not for commercial or industrial use.

## **WARNING**

If the supply cord is damaged, the manufacturer or its service agent or a similarly qualified person in order to avoid a hazard must replace it.

## **SPECIAL WARNING**



Recycling symbol, don't dispose of the product with household refuse.

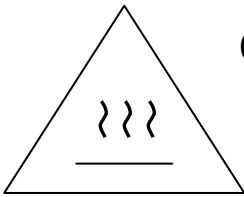

Caution: The temperature of the accessible surface may be high when the appliance is operation.

**MANUFACTURED FOR/ DIBUAT UNTUK  
SHARP ROXY SALES & SERVICE COMPANY (M) SDN BHD (8394-W)  
NO 1A PERSIARAN KUALA LANGAT, SECTION 27  
40400 SHAH ALAM, SELANGOR DARUL EHSAN**