

ELECTRIC SERVICE HANDBOOK

2016



 **Pepeco Holdings**®

An Exelon Company

NEW BUSINESS ADDRESSES AND PHONE NUMBERS



An Exelon Company

NEW JERSEY OFFICES

Cape May Courthouse Operations

420 Route 9 North
Cape May Court House, NJ 08210
(609) 463-3823

Glassboro Operations

428 Ellis Street
Glassboro, NJ 08028
From Salem Co. (856) 863-7926
From Cumberland Co. (856) 863-7926
From Gloucester Co. (856) 863-7906

Pleasantville Operations

2542 Fire Road
Egg Harbor Township, NJ 08234
From Atlantic City (609) 645-4896
From West Creek (609) 294-6727
From Pleasantville (609) 645-4667

Winslow Operations

295 North Grove Street
Williamstown Junction
Berlin, NJ 08009
From Hammonton (609) 561-2242
From Winslow (856) 753-2808



An Exelon Company

DELAWARE OFFICES

New Castle Region

401 Eagle Run Road
P.O. Box 9239
Newark, DE 19714

Millsboro Operations

700 E. Dupont Highway
P.O. Box 637
Millsboro, DE 19966
(800) 375-7117

MARYLAND OFFICES

Centreville Operations

2600 Centreville Road
P.O. Box 159
Centreville, MD 21617
(800) 375-7117

North East Operations

2 Center Drive
North East Commerce Center
North East, MD 21901-0497
(800) 375-7117

Salisbury Operations

2530 N. Salisbury Boulevard
P.O. Box 1739
Salisbury, MD 21802-1739
(800) 375-7117



An Exelon Company

MARYLAND OFFICES

Montgomery County Region

201 West Gude Drive
Rockville, MD 20855
(301) 670-8700
Fax: (301) 670-8718

Prince George's County Region

8300 Old Marlboro Pike
Upper Marlboro, MD 20772
(301) 967-5800
Fax: (301) 967-5820

DISTRICT OF COLUMBIA OFFICES

District of Columbia Region

3400 Benning Road NE
Washington, DC 20019
(202) 331-6237
Fax: (202) 388-2721

Call Before You Dig



Know what's below.
Call before you dig.

Delaware	1-800-282-8555
Cecil, Montgomery & Prince George's Counties in Maryland and the District of Columbia	1-800-257-7777
Eastern Shores of Maryland	1-800-441-8355
New Jersey	1-800-272-1000

SERVICE TERRITORIES

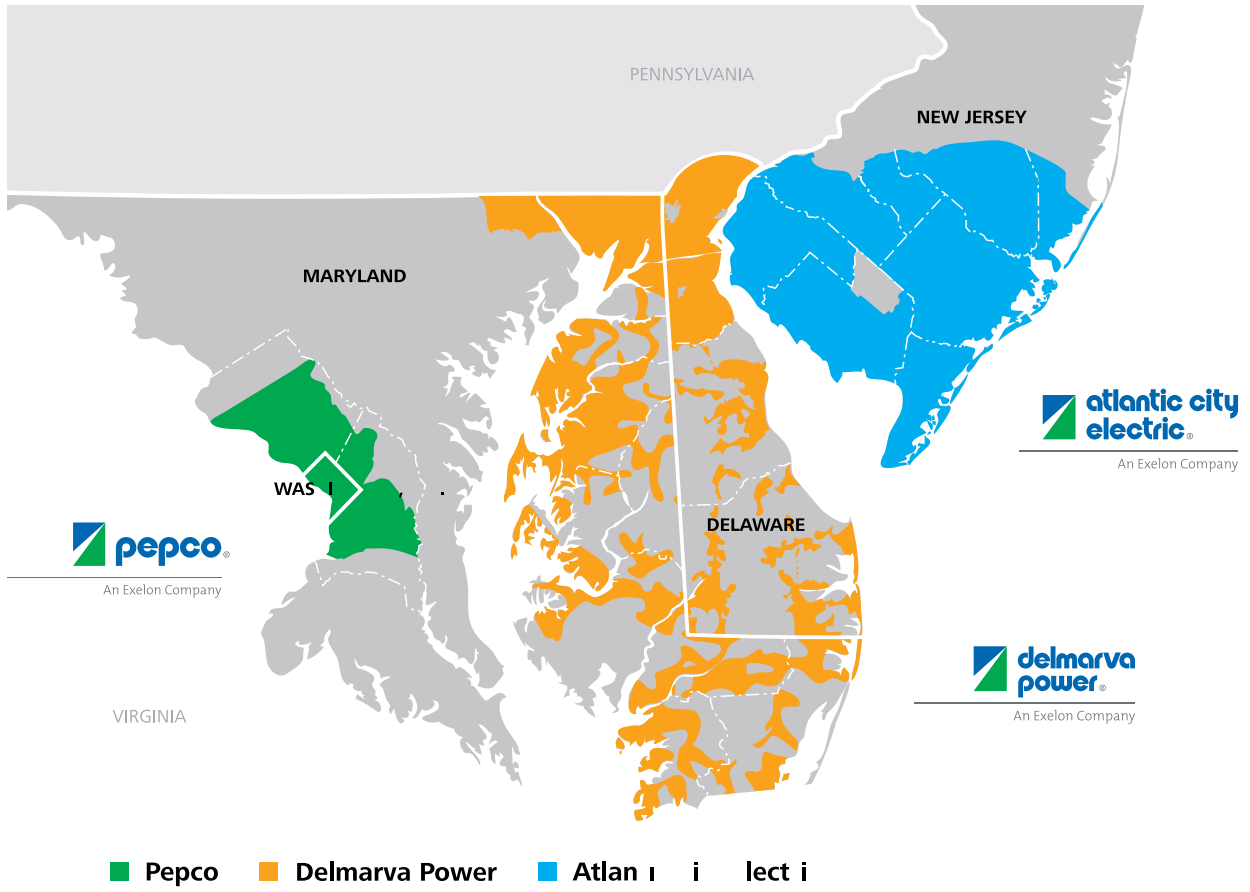

TABLE OF CONTENTS INFORMATION

CHAPTER 1 – GENERAL	1
A. General Information	1
101. PURPOSE	1
102. GETTING THE JOB DONE.....	1
103. INTERPRETATIONS.....	1
104. EMPLOYEE IDENTIFICATION	1
105. LIABILITY	1
106. HANDBOOK REVISIONS	1
107. SERVICE SUPPLY.....	1
108. SERVICE AVAILABILITY	1
109. SERVICE CONTINUITY	2
110. OUTAGES.....	2
B. Definitions	2
111. COMMONLY USED TERMS	2
C. Supply Voltages	4
112. NOMINAL VERSUS ACTUAL	4
113. AVAILABILITY OF LOW VOLTAGE (SECONDARY) SERVICE.....	4
114. AVAILABILITY OF HIGH VOLTAGE (PRIMARY) SERVICE	4
D. Application for Service	4
115. INFORMATION REQUIRED	4
116. CLASS OF SERVICE	5
117. CONSTRUCTION AGREEMENTS	5
118. SERVICE DELIVERY LOCATION	5
119. TARIFF	5
120. RIGHT OF WAY	6
121. CONSTRUCTION POWER.....	6
122. TEMPORARY SERVICE WIRING	6
E. Inspections	6
123. NATIONAL ELECTRICAL CODE	6
124. INSPECTION AGENCY APPROVAL	6
125. SAFETY	6
126. COMPANY INSPECTIONS.....	6
F. Design & Construction	6
127. CLEAR ZONES	6
CHAPTER 2 – SAFETY	7
A. General Information	7
201. OVERHEAD WIRES	7
202. REGULATIONS.....	7
203. PLANNING	7
204. UNDERGROUND FACILITIES	7
205. PLANTING.....	7
206. FOREIGN ATTACHMENTS	7
207. ANTENNAS/FLAGPOLES	7
208. POOLS & BUILDINGS.....	7

209. CIRCUIT BREAKERS & SERVICE EQUIPMENT	8
210. FALLEN WIRES	8
211. POLE SAFETY	8
CHAPTER 3 – EXTENSIONS & SERVICES	8
A. General Information.....	8
301. EXTENSIONS	8
302. CONNECTIONS	8
303. FINANCIAL PARTICIPATION	8
B. Extensions.....	8
304. CONFORMITY	8
305. OWNERSHIP	8
C. Services – General	9
306. POINT OF SERVICE	9
307. OVERHEAD TO UNDERGROUND CONVERSIONS.....	9
308. OVERHEAD SERVICE ATTACHMENT.....	9
309. OVERHEAD SERVICE LENGTH.....	9
310. PROTECTION FOR UNDERGROUND SERVICES.....	9
D. Services – Underground	10
311. RESIDENTIAL SERVICES	10
312. COMMERCIAL SERVICES	10
CHAPTER 4 – CUSTOMERS’ INSTALLATIONS	13
A. General Information.....	13
401. PLANNING	13
402. SHORT CIRCUIT RATINGS	13
403. CONNECTIONS TO COMPANY FACILITIES	13
B. Service Entrance.....	13
404. NATIONAL ELECTRICAL CODE	13
405. OVERHEAD SERVICE DROPS	13
406. ATTACHMENT HOOKS	13
407. SERVICE CAPACITY.....	14
408. SAFETY	14
409. MULTI-UNIT DWELLINGS.....	14
410. EXTERIOR MOUNTED SERVICE ENTRANCES	14
411. COLOR CODING.....	14
412. BALANCING LOADS	14
413. HEAT/AIR CONDITIONING SERVICE	14
C. Service Switches and Fuses	14
414. TROUGHS	14
415. SWITCHES / CIRCUIT BREAKERS	14
416. SERVICE DISCONNECT IDENTIFICATION	15
417. ISOLATING SWITCHES	15
D. Lighting and Appliances	15
418. SINGLE PHASE SERVICE.....	15
419. THREE PHASE SERVICE	15

420. APPLIANCES	15
421. TANKLESS WATER HEATERS	15
422. WELDERS.....	15
E. Motors – General.....	16
423. STARTING CURRENT.....	16
424. HORSEPOWER RATING.....	16
425. VOLTAGE IMBALANCE ON MOTOR LOADS	16
426. REDUCED VOLTAGE STARTING	16
427. OTHER PROTECTION	17
J. Generators	17
428. EMERGENCY STANDBY GENERATION.....	17
429. CO-GENERATION	17
K. Power Factor Correction	18
430. ECONOMICS OF POWER FACTOR CORRECTION	18
L. Transformer Vaults, Manholes and Pads.....	18
431. PLANNING	18
432. VAULTS FOR TRANSFORMERS WITHIN BUILDING FOR LOW VOLTAGE SERVICE	18
433. RESTRICTED USE OF VAULTS	18
434. SECURITY OF VAULTS.....	18
435. MAINTENANCE OF VAULTS	18
436. TRANSFORMER MANHOLES.....	18
437. TRANSFORMER PADS.....	18
M. Substations	19
438. PLANNING & DESIGN.....	19
N. Metering on a Private Structure.....	19
439. DISCONNECTING MEANS.....	19
O. Sensitive Electronic Equipment	19
440. PROTECTION	19
P. Customers’ Use of Service.....	19
441. DISTURBANCES.....	19
442. PHASE LOAD BALANCE.....	19
443. FEEDER LOAD BALANCE.....	19
CHAPTER 5 – METERS	20
A. General Information.....	20
501. NUMBER OF METERS	20
502. ACCESS.....	20
503. METER BOX SUPPLY	20
504. OWNERSHIP	20
505. INSTALLATIONS PROHIBITED.....	20
506. TRANSFORMER RATED METERING	20
507. EXCESSIVE METERING COSTS.....	21
508. CONDUIT	21
509. RESALE OF ELECTRICITY	21
510. AESTHETICS	21

B. Meter Locations	21
511. METER LOCATION	21
512. OUTDOOR LOCATIONS	22
513. PERMANENT SELF SUPPORTING METER STRUCTURE	22
514. METER PEDESTAL	22
515. METER ROOMS	22
516. JUMPERS	22
517. MULTI-METER INSTALLATIONS	22
518. SAFETY	23
519. PROXIMITY TO GAS METERS, REGULATORS AND VENTS	23
C. Group Metering	23
521. IDENTIFICATION	23
522. MANUFACTURED METER ASSEMBLIES	23
523. PROTECTION	23
524. TROUGH FED METERING	23
D. Meter Connections	24
525. SOCKET METERS	24
526. TRANSFORMER RATED SERVICE	24
527. FIFTH CLIP	24
528. REMOTE COMMUNICATIONS	24
CHAPTER 6 – TEMPORARY ELECTRIC SERVICE	24
A. General Information	24
601. DESCRIPTION	24
602. PREREQUISITES	24
603. COSTS	25
604. LOCATION	25
605. MATERIAL / SUPPLIES	25
606. SAFETY	25
B. Overhead	25
607. CUSTOMER'S SERVICE POLE	25
608. POLE/TIMBER SIZE	25
609. POLE / TIMBER SETTING DEPTH	25
610. GUYING / BRACING	25
611. LOCATION	25
612. WIRE / SPAN	25
613. DRAWINGS	26
614. INSPECTION	26
C. Underground	26
615. GENERAL	26
616. CUSTOMER'S SERVICE POLE	26
617. LENGTH	26
618. LOCATION	26
619. CABLE & CONDUIT INSTALLATION	26
620. CABLE SIZE / TYPE	26
621. INSPECTION	26

TABLE OF CONTENTS – FIGURES

FIGURE 1 - ACE / DPL - SINGLE PHASE, THREE WIRE, 120/240 & 120/208 VOLT METER WIRING DIAGRAM 200 AMP

FIGURE 1 - ACE / DPL - SINGLE PHASE, THREE WIRE, 120/240 & 120/208 VOLT METER WIRING DIAGRAM 200 AMP SINGLE CONDUCTOR

FIGURE 2 - DPL - SINGLE PHASE, THREE WIRE, 120/240 VOLT METER WIRING DIAGRAM 320 AMP UG SERVICE SINGLE & PARALLEL CONDUCTORS

FIGURE 3 - DPL - SINGLE PHASE, THREE WIRE, 120/240 VOLT METER WIRING DIAGRAM 320 AMP OH SERVICE SINGLE & PARALLEL CONDUCTOR

FIGURE 4 - ACE / DPL - SINGLE PHASE, THREE WIRE, 120/240 VOLT METER WIRING DIAGRAM 400 AMP SINGLE CONDUCTOR

FIGURE 5 - ACE / DPL - SINGLE PHASE, THREE WIRE, 120/240 VOLT METER WIRING DIAGRAM 400 AMP PARALLEL CONDUCTORS

FIGURE 6 - ACE / DPL - SINGLE PHASE, THREE WIRE, 120/208 VOLT METER WIRING DIAGRAM 400 AMP SINGLE CONDUCTOR

FIGURE 7 - ACE / DPL - SINGLE PHASE, THREE WIRE, 120/208 VOLT METER WIRING DIAGRAM 400 AMP PARALLEL CONDUCTORS

FIGURE 8 - ACE / DPL - THREE PHASE, 4 WIRE DELTA, 120/240 VOLT METER WIRING DIAGRAM 200 AMP SINGLE CONDUCTOR

FIGURE 9 - ACE / DPL - THREE PHASE, 4 WIRE WYE, 120/208 & 277/480 VOLT METER WIRING DIAGRAM 200 AMP SINGLE CONDUCTOR

FIGURE 10 - ACE / DPL - THREE PHASE, 4 WIRE DELTA, 120/240 VOLT METER WIRING DIAGRAM 400 AMP SINGLE CONDUCTOR

FIGURE 11 - ACE / DPL - THREE PHASE, 4 WIRE DELTA, 120/240 VOLT METER WIRING DIAGRAM (400AMP PARALLEL CONDUCTOR)

FIGURE 12 - ACE / DPL - THREE PHASE, 4 WIRE WYE, 120/208 & 277/480 VOLT METER WIRING DIAGRAM 400AMP SINGLE CONDUCTOR

FIGURE 13 - ACE / DPL - THREE PHASE, 4 WIRE WYE, 120/208 & 277/480 VOLT METER WIRING DIAGRAM 400AMP PARALLEL CONDUCTORS

FIGURE 14 - DPL - THREE PHASE, 4 WIRE, 600 AMP, 120/208 VOLT METERING DIAGRAM

FIGURE 15 - PEPCO - SINGLE PHASE, 3 WIRE 120/240 VOLT METER WIRING DIAGRAM 200AMP OH & UG SERVICE

FIGURE 16 - PEPCO - SINGLE PHASE, 3 WIRE, 120/240 VOLT METER WIRING DIAGRAM 320 AMP OH & UG SERVICE

FIGURE 17 - PEPCO - THREE PHASE, 4 WIRE, 120/208 VOLT METER WIRING DIAGRAM 400 AMP



FIGURE 18 - PEPCO - THREE PHASE, 4 WIRE, 265/460 VOLT METER WIRING DIAGRAM 200 AMP

FIGURE 19 - PEPCO - SINGLE PHASE, 3 WIRE, 120/240 VOLT 800 AMP C.T. CABINET PREFERRED OUTSIDE INSTALLATION

FIGURE 20 - PHI - METER INSTALLATION FOR NEW CONSTRUCTION 400AMP MAXIMUM

FIGURE 21 - PHI - TEMPORARY SERVICE OVERHEAD (ACROSS PUBLIC ROAD)

FIGURE 22 - PHI - TEMPORARY SERVICE OVERHEAD (ACROSS PRIVATE DRIVE)

FIGURE 23 - PHI - TEMPORARY SERVICE UNDERGROUND

FIGURE 24 - PHI - OVERHEAD SECONDARY SERVICE

FIGURE 25 - PHI - SERVICE MAST

FIGURE 26 - PHI - UNDERGROUND SERVICE PEDESTAL

FIGURE 27 - PHI - UNISTRUT METERING EQUIPMENT

FIGURE 28 - PHI - ANCHORING SERVICE ATTACHMENTS TO BUILDINGS

FIGURE 29 - PHI - TROUGH INSTALLATIONS

FIGURE 30 - PHI - CLEAR SPACE REQUIREMENTS FOR PAD MOUNTED EQUIPMENT

FIGURE 31 - PHI - WARNING STICKERS

CHAPTER 1 – GENERAL

A. General Information

101. PURPOSE

Atlantic City Electric, Delmarva Power (ACE/DP) and Pepco, operating within the Pepco Holdings (PHI) service territory, issue this booklet as a general guide for customers, contractors, architects, engineers, etc., who plan to install electrical wiring or apparatus which will be connected to Company lines. These requirements do not replace the regulations of appropriate State, County or Municipal authorities having jurisdiction or the National Electrical Code (NEC) or the National Electrical Safety Code (NESC). The booklet is not intended to address all possible situations. Contacting your Local Office about particular issues is encouraged.

102. GETTING THE JOB DONE

The Company will endeavor to cooperate in every way in completing service connections as promptly as possible and will give special attention to unusual problems that may confront the customer, contractor, architect or engineer. The Company reserves the right to impose additional requirements where unusual circumstances exist.

103. INTERPRETATIONS

Observance of requirements contained herein will enable the Company to render prompt and satisfactory service. Assistance in the interpretation or clarification of these requirements may be obtained by contacting your local office. Key phone numbers appear at the beginning of the booklet.

104. EMPLOYEE IDENTIFICATION

For the mutual protection of you and the Company, only authorized employees of the Company are permitted to make and energize the connection between the service and your service entrance. All Company employees carry identification cards that will be shown upon request.

105. LIABILITY

The Company shall not be liable for damages resulting from the presence of its electric service or equipment on the customer's premises, or for the customer's use of that service. The Company also shall not be liable for power interruptions resulting from situations beyond the reasonable control of the Company.

106. HANDBOOK REVISIONS

The company may from time to time supplement, alter or otherwise change its requirements, as may be required by changing conditions, for the protection of the interest of the customer, the Company or the general public. Revisions to the booklet will be posted online at www.atlanticcityelectric.com, www.delmarva.com and www.pepco.com.

107. SERVICE SUPPLY

The standard electric service supplied by the company is alternating current with a nominal frequency of 60 hertz (cycles per second). See Articles 112–114 for nominal supply voltages and their load limitations.

108. SERVICE AVAILABILITY

The voltage, number of phases, load and type of metering that can be supplied depends upon the companies existing facilities at or near the customer's location. The customer will consult the company before proceeding with the purchase or installation of any materials or equipment.

109. SERVICE CONTINUITY

The Company does not guarantee continuous and uninterrupted electric service and will not be liable for any loss, cost, damage or expense to any customer caused by an interruption or phase reversal, or loss of phase, if the incident is caused by an event beyond the reasonable control of the Company.

110. OUTAGES

When it becomes necessary to make repairs or changes to the Company electric system, the Company may suspend the delivery of service for such periods as may be reasonably necessary without incurring any liability because of such a service interruption. However, the Company will make every reasonable effort to schedule outages to minimize the impact of the outage on its customers.

B. Definitions

111. COMMONLY USED TERMS

Certain terms used in these rules shall be understood to have the following meanings:

APPROVED

Referring to an electrical installation, it is considered as meeting the requirements of an authorized inspector or inspection agency. Referring to electrical materials or equipment, it is considered as meeting the approval of a recognized laboratory after test by a recognized authority after inspection, trial or general use. Self contained meter socket equipment, which is purchased and installed by the customer, must be approved by the Company.

AUTHORITY HAVING JURISDICTION:

Governmental (States, County, and Municipal) agencies or others having authority over the Customer's electrical installation and equipment.

COMPANY

The word refers to Atlantic City Electric, Delmarva Power and Pepco.

CONSTRUCTION AGREEMENTS

Written agreements between the Customer and the Company defining what must be done by the Customer before the Company's work to provide service can be completed.

CUSTOMER

The word designates either the present or prospective users, or their authorized representatives, of the Company's electric service.

DEMAND

The rate at which electric energy is metered per time interval, also referred to as the load.

HIGH VOLTAGE SERVICE

Primary voltage service in excess of 600 volts phase to phase.

INSPECTION AGENCY

The person, agency or organization, also known as the Authority Having Jurisdiction (AHJ), duly authorized by the appropriate state, county or municipality to conduct the inspection of wires and appliances utilizing electric energy subject to applicable statutes and regulations for such installations.

LOW VOLTAGE SERVICE

Secondary voltage service of 600 volts or less phase to phase.

MULTI-METERING

Those meter installations at multiple occupancy buildings where the individual meters for various customers are arranged in a bank or grouping in the same area, and are energized from the same service entrance.

NORMAL SERVICE

The service and service connection facilities offered by the company to supply the Class of Service (the "Company Plan") without regard for special customer requirements for service which is not normal (the "Customer Plan").

OSHA

The Occupational Safety and Health Administration

SERVICE

The supply of the Company's product, "electricity", to the Customer. The wire and associated connections between Company lines and the Customer's wiring. These wires may be high or low voltage, overhead or underground.

SERVICE DROP

The portion of the overhead wire between the Company's last pole or support to and including splices, if any, and the first point of attachment of the Customer's facilities.

SERVICE ENTRANCE

The customer owned installation, generally wires and enclosures, connecting the Customer's service equipment to the Company's service drop or underground service.

STARTING CURRENT

The maximum current drawn when a motor is starting. Without some sort of starting aid, the starting current is generally about five times the normal running current.

TARIFF

The documents of agreement between a state's utility regulating body and the utility defining the various rates and the rules and regulations governing specific interactions between the utility and its customers.

UNDERGROUND SERVICE

The underground portion of conductors and associated materials, owned by the Company, that run between the Companies' distribution system and the Customer's service facilities.

NOTE: Definitions used in Article 100 of the NEC and other local jurisdictional codes applicable to terms not otherwise defined.

C. Supply Voltages

112. NOMINAL VERSUS ACTUAL

In this booklet, all references to voltages are nominal voltages. Actual voltages supplied may vary within the allowable limits per state tariff. Customers should call the local Company office before purchasing equipment if there is any doubt about the service voltage.

113. AVAILABILITY OF LOW VOLTAGE (SECONDARY) SERVICE

Not all of the service voltages listed below is available at all locations and may be subject to minimum and/or maximum KVA requirements. Please contact your local office to verify availability. Subject to system limitations, the types of secondary electric service are listed below

TABLE 1 – TYPES OF LOW VOLTAGE SECONDARY SERVICE

			ACE	DPL	Pepco
Single-phase	3 wire	20/240 Volt	X	X	X
Single-phase	3 wire	120/208 Volt	X	X	X
Three-phase	4 wire	240/120 Volt	X	X	
Three-phase	4 wire	208/120 Volt	X	X	X
Three-phase	4 wire	480/277 Volt	X	X	
Three-phase	4 wire	480/240 Volt	X	X	
Three-phase	4 wire	460/265 Volt			X

114. AVAILABILITY OF HIGH VOLTAGE (PRIMARY) SERVICE

Primary electric service voltages may also be available depending upon the location and the size of load being served. Such electric service may be made available under suitable contractual arrangements. Not all voltages below are available at all locations. Consult your local office for voltage options at your location.

TABLE 2 - NOMINAL PHASE TO GROUND/PHASE TO PHASE VOLTAGES

	MAXIMUM kVA	ACE	DPL (New Castle)	DPL (Bay)	Pepco
2400/4160	2,000	X	X	X	
6940/11847	4,000		X		
7200/12470	4,000	X	X	X	
7620/13200	-----				X
13200/23000	8,000	X			
14400/24940	10,000		X	X	
19200/33000	18,000		X North East MD		
19900/34500	18,000	X	X		

D. Application for Service

115. INFORMATION REQUIRED

To notify the Company that you need electric service, complete the Application for Electric Service form available on www.atlanticcityelectric.com, www.delmarva.com, www.pepco.com or contact the appropriate number listed for your area located on the first page of this handbook. When you contact the Company representative or complete this form, you must provide specific information depending on your type of service.

It is best to have this information prepared in advance so that the initiation phase passes quickly and one of the Company's designers can begin to prepare your work request. Company designers cannot begin their design until all of the necessary project initiation information has been provided. These forms are also available at each of the local offices for pick up, or can be mailed or faxed to your office. To expedite the completion of the application, the prospective customer should be prepared to furnish the following information:

1. Exact location of the premises (number, street, post office and zip code and pole number if possible).
2. Name of the person to be billed for service.
3. Phone numbers
4. The address to which the bill should be mailed.
5. Date electric service will be required.
6. Characteristics of the electrical load - the size in kilowatts of major appliances such as electric heat, air conditioning, stove, water heater, etc., horsepower ratings of motors, voltage requirement and three versus single phase service.
7. Details of special load requirements.
8. Requested meter location.
9. Name & phone number of any other contacts (builder, electrician, etc.).
10. Square Footage of building.
11. Plot Plan or Site Improvement Plan.
12. Electrical Drawings are required for non-residential or any large loads or non-typical applications.

Sometimes a plot plan or electrical drawings have to be mailed to the appropriate Company office.

116. CLASS OF SERVICE

Each single family and townhouse residential structure will be provided an individual service connection. The class of service will normally be single phase, three (3) wire, 120/240 volts. In certain areas, the class of service for residential service may be 120/208 volts.

The class of service available for multi-family residential structures and non-residential structures such as commercial and industrial buildings will be determined after a review of the information provided in the application for service. The class of service to be provided to these structures will be determined on a case by case basis by the Company and communicated to the Customer. Electrical equipment dependent on the class of service should not be purchased until this information is provided.

117. CONSTRUCTION AGREEMENTS

Construction Agreements for electric service will be required for residential developments and commercial and industrial customers. They may also be required for residential customers where deposits for extensions are required.

118. SERVICE DELIVERY LOCATION

In all situations, the company retains the right to dictate the location of the point of attachment, service entrance and metering equipment. The Company must also be consulted with regard to the size and character of the anticipated electric load so that the Company may advise the customer about the electrical facilities available at that specific location. These consultations are distinctly advantageous to the customer or his representatives so that errors in equipment ratings and any deficiency in electric service capacity may be avoided. Advance consultation may also help avoid unnecessary additional expense or delays on the part of the customer or his contractor.

119. TARIFF

The service classifications and the rules and regulations applicable to electric service prepared pursuant to the requirements of the respective state regulatory authorities are open for inspection at each business office of the company. The tariff can also be found on the Internet at www.atlanticcityelectric.com, www.delmarva.com, or www.pepco.com.

120. RIGHT OF WAY

Furnishing electric service to a prospective customer is dependent upon the ability to obtain adequate rights of way, easements and/or jurisdictional permits.

121. CONSTRUCTION POWER

Temporary installations requiring special service, meter or other work, such as for construction purposes, exhibits of short duration, etc., shall be made at the expense of the customer with charges according to the material and work required for installing and removing. A payment in advance, sufficient to cover construction and removal expenses and current use, may be required. See Chapter 6 for more details on Temporary Services.

122. TEMPORARY SERVICE WIRING

Service entrance, metering and wiring on temporary installations shall be installed in the same manner as for permanent installations.

E. Inspections

123. NATIONAL ELECTRICAL CODE

All new wiring and equipment, or changes in wiring and equipment, must be installed in accordance with the latest edition of the National Electrical Code and the Company's requirements in order to be approved for connection to the Company's lines.

124. INSPECTION AGENCY APPROVAL

The Company will normally render electric service from its distribution system to the new facilities of a customer only after receipt by the Company of a notice of approval, issued by an Authority Having Jurisdiction (AHJ) – commonly referred to as a "cut-in" card or Temporary Pending Final (TPF). Whenever a service has been disconnected for a year or more or the Company suspects that the wiring may have been modified, an inspection will be required before service will be reconnected (See Service Restoration Section 124.1 for more information).

124.1. SERVICE RESTORATION – DISCONNECTED SERVICES

If a service has been disconnected (service wires cut or meter blocked) for 12 months or more, a new inspection by the local or state inspection authority is required before the service will be reconnected. In any area where there is no local or state inspection authority, or the local or state inspection authority will not perform the inspection for whatever reason, a licensed electrician must perform the inspection. The licensed electrician must provide the Company with a signed letter on the electrician's company letterhead stating that the service has been inspected and conforms to the NEC and applicable local codes.

125. SAFETY

The Company may refuse to render or continue service to a customer when it has knowledge of or reason to believe that a customer's wiring or equipment does not comply with recognized requirements.

126. COMPANY INSPECTIONS

Inspections, when made by the Company, are to insure compliance with its own requirements and to cooperate with customers, contractors, architects and engineers. The Company does not assume any responsibility for the customer's wiring, equipment, or for any loss or damage that may result from any defects that may exist in the customer's wiring and equipment.

F. Design & Construction

127. CLEAR ZONES

To allow for safe and efficient operation of high voltage equipment, certain areas around the equipment must be free from obstructions. Figure 30 shows the Company's requirements for clear space around commonly used equipment. If there is any doubt about placement of surface mounted equipment, contact your local office.

CHAPTER 2 – SAFETY

A. General Information

In order to avoid personal injury or extended loss of electric service, the following safety practices should be followed.

201. OVERHEAD WIRES

People have suffered serious injuries or death as a result of carelessness around electrical wires. Many believed that the wires were insulated and harmless. While it is true that various types of wire may have a covering, this insulation is NOT designed for personal protection.

202. REGULATIONS

The Occupational Safety & Health Administration (OSHA) is the arm of the Federal Government that regulates the proximity to electrical wires of work crews unqualified to work on electric lines. Many states (DC, DE, MD, NJ, etc.) have High Voltage Acts that define clearances between energized electrical wires and personnel or work equipment. Additionally, the National Electrical Safety Code governs the erection of structures near electric lines.

203. PLANNING

Whenever any work activity is to be performed in the vicinity of overhead lines or when an excavation is involved, our Company must be notified in advance of the start of such work. Many situations are unique and must be handled individually. Depending on the scope of the work there may be associated costs. Covering overhead conductors is not an option.

204. UNDERGROUND FACILITIES

Underground facilities belonging to most utility companies will be located for free by calling the appropriate agency listed on the first page of this document. It is the law that you must have underground structures marked so there is no chance of damaging them when excavating. Fines may be imposed for failure to comply with the law.

205. PLANTING

Trees should not be planted where they would normally grow into electric lines. The Company should be contacted before tree trimming or removal in the vicinity of electric wires so the work site can be made safe for the workers. Please refer to the following website for a 'Safe Planting Guide' <http://www.arboday.org/trees/righttreeandplace/righttree.cfm>.

206. FOREIGN ATTACHMENTS

The Company's poles, towers and other structures are provided for the sole purpose of supplying electric service. The attachment of antennas, signs, banners, basketball hoops, or any privately owned wiring to Company facilities is strictly prohibited. The Company reserves the right to remove such attachments without notice. No attachments shall be made on company facilities without company prior approval.

207. ANTENNAS/FLAGPOLES

Antennas on any high support are particularly vulnerable to high winds and lightning. Accidents may be prevented if installations are made by experienced installers who use prime materials, conform to manufacturers' recommendations and conform to all building codes and National Electric Safety Codes.

208. POOLS & BUILDINGS

Pools and their associated structures should never be constructed over/under electrical wires/cables. Contact the Company during the planning stages of such projects so various options for relocating facilities can be evaluated.

209. CIRCUIT BREAKERS & SERVICE EQUIPMENT

The available fault current at a site must be known before circuit breakers and other service equipment which must interrupt and withstand such fault current magnitudes, can be specified. The local office can supply fault currents upon request. To safeguard your property, you are warned against sizing fuses or circuit breakers larger than National Electrical Code guidelines. You are also warned against using any technique to modify the operation of any protective device.

210. FALLEN WIRES

Fallen wires are particularly dangerous because they are often assumed to be de-energized. Do not hesitate to call '911' to report downed wires. In New Jersey call 1-800-833-7476. In New Castle County (DE) and Cecil and Harford Counties (MD) call 1-800-898-8042. In Kent and Sussex Counties (DE) and the Eastern Shore of Maryland call 1-800-898-8045. In Pepco (MD & DC) call 1-877-PEPCO-62 (1-877-737-2662).

Do not touch the wire, even with a tree branch or long pole. You should prevent others from getting near the wire until Company representatives check the situation. A downed wire is our highest response priority.

211. POLE SAFETY

In Delaware, District of Columbia, Maryland and New Jersey, electricians will not erect any structure like an underground cable riser or ladder higher than 10 feet high on Company poles. No work on Company poles at an elevation above 10 feet is permitted. The Company will perform all work above that 10-foot elevation. Contact the Company's local office to coordinate any work involving Company poles.

CHAPTER 3 – EXTENSIONS & SERVICES

A. General Information

301. EXTENSIONS

The Company will extend its system up to the point of connection to the customer's service entrance under conditions outlined below and detailed in the appropriate state/jurisdiction Tariff. The extension of the Company's system may be on public or private rights-of-way. The last span of wire or run of underground cable will be considered the service. See Article 111 for the definition of service.

302. CONNECTIONS

Overhead service wires, underground service cables, meters and other Company equipment shall not be connected or disconnected so as to be energized or de-energized by persons other than Company employees.

303. FINANCIAL PARTICIPATION

Customers and developers must contact the Company while in the planning stage of their projects to ensure that company facilities already exist at the construction site. Existing facilities may not be adequate to support the proposed project. The extent the customer must participate financially in the cost of upgrading or installing company facilities varies from state to state within the Company's territory.

B. Extensions

304. CONFORMITY

In general, extensions will conform to the existing facilities (overhead or underground) in accordance with existing regulatory requirements.

305. OWNERSHIP

The Company will own and maintain extension facilities, overhead or underground.

C. Services – General

306. POINT OF SERVICE

In all cases the service entrance should conform to the National Electric Code (NEC) and National Electric Safety Code (NESC). The Company shall specify the pole or underground facility from which the service is to be run. In general, the customer's service entrance will be located near the closest front corner of the structure to the point of service. Contact the local Company office for guidance on approved point of service and meter location. The Company reserves the right to refuse service if the service entrance has not been placed at the location specified by the Company. The customer may have to pay the cost of modifications to Company facilities to accommodate the service entrance location or simply relocate his service entrance. The point of service must be located to avoid service cables crossing swimming pools, buildings or other obstructions.

307. OVERHEAD TO UNDERGROUND CONVERSIONS

Where an overhead service drop to a customer exists and an underground service is requested, the company must be contacted to determine the location and routing of the service. Also, the proposed division of labor between the customer and the Company and the cost to be paid by the customer must be determined. In the event that the Company shall be required by a public authority to place overhead facilities underground, customers will be responsible for the costs to modify their facilities to receive the new underground service.

308. OVERHEAD SERVICE ATTACHMENT

The customer shall provide and maintain a safe, substantial support for the Company's service drop wires. The anticipated steady state pull of the wires should never exceed 350 pounds. In no case shall the Company be responsible for the condition of any customer's structure or building to which service drops are attached. Figure 28 shows recommended methods and hardware required to provide adequately strong attachment hooks for various types of building materials. All hardware must be corrosive resistant. Parapet walls and chimneys are not satisfactory supports. The company will not install attachment hooks for the customer.

Some buildings may not be sufficiently high enough to allow attachment of overhead service wires given the fact that the Company must adhere to the ground clearance requirements of the National Electric Safety Code (NESC). An extension support above the roof may be required in order to provide the necessary clearances specified in Figures 24 and 25. Figure 25 provides details on the installation of a service mast to provide additional height above the roof line. Sometimes a guyed pole may have to be installed near the customer's service entrance to provide necessary attachment height.

If, due to an obstruction or limitation, the Company is not able to run overhead electric service, a customer underground service may be required.

309. OVERHEAD SERVICE LENGTH

The maximum length of overhead service wires shall be limited to 100 feet to limit the tension on the structure at the attachment point. For larger conductors, this length may have to be shortened considerably. Always consult the Company for advice on how best to serve a structure using overhead wire. Sometimes an underground service may prove to be a better design.

310. PROTECTION FOR UNDERGROUND SERVICES

Customers may be required to provide conduit, size specified by the Company, when the proposed cable route is to be covered by paving, decks, stoops, patios, etc., prior to the installation of the cables. The conduit provides mechanical protection for the cables as well as facilitating their replacement without digging.

D. Services – Underground

311. RESIDENTIAL SERVICES

Atlantic City Electric, Delmarva Power and Pepco

Ownership

- The Company, in general, will own all services in underground developments and most services not in such developments. **However, in the Atlantic City Electric and Delmarva Power regions there are private underground services.** The customer is responsible for marking all underground facilities located on private property prior to the company scheduling construction crews (i.e. well, septic, sprinkler system etc.).

Installations

- Underground services to residences will generally terminate in a Company approved meter enclosure mounted on the outside of the building. A list of Company approved meter enclosures is available on the Company's website. Contractors should mount the meter enclosure at the location specified by the Company as shown on Figure 20. The enclosure should be at a height where the top of the meter glass will be between three and six feet above the ground with three feet of horizontal clear area in front of the meter. **In the Atlantic City Electric and Delmarva Power regions line and load side cable mechanical connectors for the meter box shall be provided by the customer.**
- Residential customers (in **New Jersey ONLY**) have the option to request Atlantic City Electric to install their underground secondary service cables, for a fee, or they can choose to install their own secondary cables. **Note:** Customer owned services are not allowed in residential developments.
- Residential customers (in **New Jersey ONLY**) that choose to install privately owned underground secondary cables will be required to install customer owned secondary cables from the meter socket out to a pole location designated by the company and on the side of the pole designated by the company.
- Residential customers will **ONLY** be required to install the first 10 feet of cable and conduit (in compliance with NEC requirements) up the utility pole. The remaining 35 feet of cable is to be coiled up and tied off at this level. The conduit is to be attached directly to the pole. **(Atlantic City Electric and Delmarva Power regions ONLY)**
- The Company will provide, at No Cost, the labor and material to install a 2" or 4" PVC U-Guard over the existing conduit and cable provided by the customer and secure it from the 10-foot level up to the electrical system on the pole. Some installations may require weatherheads or standoffs to be installed. If necessary, the customer shall provide all materials necessary for the company to complete the installation. The customer will continue to own and maintain the entire secondary voltage cables and conduits. **(Atlantic City Electric and Delmarva Power regions ONLY)**
- If the customer chooses to install the cables in conduit along the entire length, the contractor must ensure that water, which may enter the conduit system, be drained out at appropriate locations. One way of accomplishing this is to drill a 1/2" diameter hole in the conduit to drain the water. **(Atlantic City Electric and Delmarva Power regions ONLY)**

312. COMMERCIAL SERVICES

Atlantic City Electric

Ownership

- All underground Commercial or Industrial secondary services will be owned and maintained by the customer.

Installations

- All planned installations must be reviewed with the Company prior to installation.
- All installations must be performed by a licensed electrician, at the customer's expense, from an approved metering point or panel to a location designated by the Company (generally a padmount transformer or pole).
- For services originating at a pole location, the licensed electrician must adhere to the following.
 - The contractor will only install the first 10' of cable and conduit on the pole (in compliance with NEC requirements). The remaining 35' of cable is to be coiled and tied off at the 10' level. The conduit shall be attached directly to the pole.
 - If the service requires 3 sets or more of conductors, or if conduits will be installed on a pole that already has existing riser conduits, the licensed electrician must meet with a Company Representative before performing any work. The Company Representative will provide further instruction.
 - The Company will provide the labor and material to install U-Guard over the existing conduit and cable provided by the customer from the 10' level up to the electrical system on the pole. The Customer will continue to own the entire secondary voltage cables and conduits.
 - If weatherheads or standoff brackets are required to be installed, the customer shall provide the necessary materials to the Company to complete the installation.
 - If the customer chooses to install conduit along the entire length, they must ensure that water, which may enter the system, be drained at appropriate locations. This can be accomplished with ½" diameter drain holes in the conduit.
- For services originating at a padmount transformer, the licensed electrician must install the cables to the transformer, with sufficient length for the company to make all connections.

Delmarva Power (Delaware)

Ownership

- For single-metered properties:
 - All service facilities (aerial or underground) on the customer's property, including primary voltage and secondary voltage facilities from Delmarva Power's distribution point to the point of attachment to the customer's electric system shall be installed, owned and maintained by the customer. Delmarva Power will normally provide only one distribution point for the customer to connect to. Delmarva Power will install, own and maintain the transformer. All underground non-residential service drops (cables), shall be installed, owned and maintained by the customer from the transformer to the metering point. Should the service be CT (Current Transformer) metered on the bushings of the transformer the service conductors from the transformer to the customer's premise are also required to be installed, owned and maintained by the customer. All customer owned services must be installed by a licensed electrical contractor, in compliance with NEC requirements. (See Example #1A)
- For multi-metered customers:
 - All secondary service cables will be installed, owned and maintained by the customer from the transformer to any multi-metering point, where the secondary cables will serve more than one customer/account. This may be accomplished through the use of a multi-meter stack configuration or multi-meters fed from a trough. For buildings under 300 feet in length, Delmarva Power will provide only one distribution point. For buildings over 300 feet long, Delmarva Power may provide additional distribution points based on load requirements as determined by Delmarva Power for each additional 300 feet of building length. Generally only one distribution point will be provided for each 300' of building length. (See Example #1B)

Example 1A

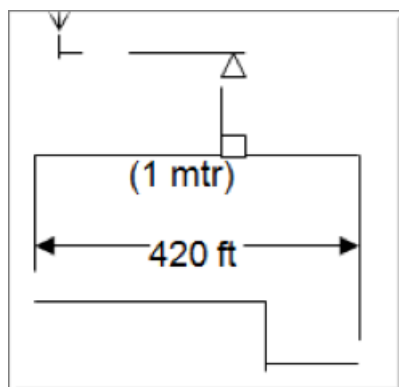

- DPL owns the primary and transformers (distribution points).
- Customer owns the service drops.
- Additional distribution points at the customer's cost

Example 1B

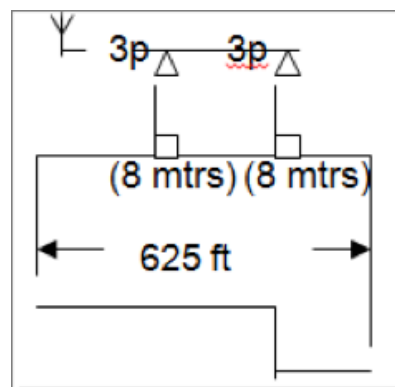

- Customer owns entire service (primary and secondary)
- DPL owns the transformer
- Additional distribution points at the customer's cost

Installations

- All planned installations must be reviewed with the Company prior to installation. The customer shall be responsible to provide a service path, clear of all obstacles for the installation and MAINTENANCE of Delmarva Power's facilities. Therefore conduit may be required to be installed by the customer.

Delmarva Power (Maryland)

Definitions:

Non-Residential Service refers to the overhead and underground primary and/or secondary facilities that are located on the applicant's and/or owner's property and extend to the point of attachment to the customer's electric system.

Service Drop refers to conductors that extend from Delmarva Power's distribution point (transformer, secondary pedestal or applicant's lot line) to point of attachment to the customer's electric system.

Ownership

- All secondary service cables are installed, owned and maintained by the Company from the transformer to the metering point. Should the service be CT (Current Transformer) metered on the bushings of the transformer then the service conductors from the transformer to the customer's premise are required to be installed, owned and maintained by the customer.

Installation

- All planned installations must be reviewed with the Company prior to installation. The customer shall be responsible to provide a service path, clear of all obstacles for the installation and maintenance of Company facilities. Conditions may warrant conduit be installed by the customer from the metering point to the company transformer.
- In the cases where CT (Current Transformer) metering on the bushings of the transformer is used the customer owned service must be installed by a licensed electrician, in compliance with NEC requirements.

Pepco

Ownership

- The Company, in general, will own and maintain the electrical facilities up to the point of service. The Customer will own and maintain all structural facilities located on private property to house or protect or support Company-owned electrical facilities. The Customer shall provide access and clearance for installation and maintenance of the Company's facilities.

Installation

- The Customer shall design, furnish and install, subject to Company approval all structural facilities located on private property.
- The Company shall furnish and install the electrical facilities up to the point of service that are required to supply the electrical requirements of the facility being served.
- In-depth information about the Company's requirements and standards for Commercial Services is available at the Company website: <http://www.pepco.com/business/services/new/res/>.

CHAPTER 4 – CUSTOMERS' INSTALLATIONS

A. General Information

401. PLANNING

The Company shall be consulted in conjunction with the planning of new installations and all changes to the service entrance equipment so that facilities of the proper capacity may be provided to assure satisfactory operation of the customer's equipment, and to protect both the customer's and Company's equipment against damage.

402. SHORT CIRCUIT RATINGS

The available short circuit current will vary from place to place within an electrical system and may change at any time without notification. Customers' service equipment must be designed to withstand available short circuit currents. The local office can supply fault currents upon request.

403. CONNECTIONS TO COMPANY FACILITIES

All connections to Company lines must be designed, installed and operated in a manner which will cause no undue disturbance to other customers or handicap the Company in maintaining proper operating conditions. Wiring and equipment, and its application, must be such as to permit proper metering and servicing.

B. Service Entrance

404. NATIONAL ELECTRICAL CODE

All service entrance conductors must be installed in accordance with the NEC. The service entrance conductors must be terminated in a manufactured service head if the facility is to receive an overhead service drop.

405. OVERHEAD SERVICE DROPS

Service entrance conductors shall extend at least three feet beyond the service head to permit the attachment to the service drop conductors with a drip loop. See Figure 24.

406. ATTACHMENT HOOKS

The customer is responsible for providing a device on a structure near the service head which has enough strength to hold the tension of the overhead service drop. In general, the tension in any individual wire or wire assembly such as triplex is limited in steady state to 350 pounds. Fastening hardware must be corrosion resistant. The point of attachment must be ladder accessible from the ground and no higher than 24 feet above the ground.

407. SERVICE CAPACITY

A new or upgraded single family residence shall be wired with a three wire service entrance having a National Electrical Code allowable current carrying rating of not less than 100 amperes, (Local jurisdiction rules may vary e.g. 150A in the District of Columbia), and shall have service equipment of equal ampacity. The requirement shall also apply to each unit of a multi family dwelling and to mobile homes.

408. SAFETY

When an existing service installation is considered unsafe by the company, the customer will be required to rectify the situation in a time frame specified by the company or face being disconnected.

409. MULTI-UNIT DWELLINGS

All metering and disconnecting devices are to be arranged so that the service for each unit can be properly and independently controlled from a point readily accessible to both the customer and the Company. Additionally, each meter or disconnect shall be permanently marked with the address served by that equipment on both the inside of the meter socket and the outside of the cover.

410. EXTERIOR MOUNTED SERVICE ENTRANCES

The entire length of cable or conduit shall normally be exposed with the exception of masts which sometimes pass through the roof in conduit. Covering with siding is not permitted.

411. COLOR CODING

For three phase 120/240 Volt services, if available, the power wire or high leg (the phase wire having the highest voltage to ground – 208 Volts nominally) shall be located on the right side of the meter box and shall be identified by the color, orange. When parallel service conductors are run, conductors of the same phase must be identified as such.

412. BALANCING LOADS

The total load shall be balanced among the phases as nearly as practical. This will keep the delivery voltages as closely balanced as possible. Also see "Voltage Imbalance on the Motor Loads" in the section on motors.

413. HEAT/AIR CONDITIONING SERVICE

A separately metered, non-demand service, specific for space heat and air conditioning and electric hot water, is available in Maryland (Delmarva Power ONLY). Some installations still exist throughout the companies. Never connect new loads to the HVAC service entrance unless they are space heating or air conditioning.

C. Service Switches and Fuses

414. TROUGHS

A service entrance trough is allowed when the installation of a manufactured meter stack is not practical or in those instances where the number of meters is unknown at the time of service design. Load side or metered conductors are not allowed in the same trough that are occupied by line side or metered conductors. Troughs must be provided with means of securing the cover with locking devices such as seals. The specific size of the trough shall be determined by field conditions and cable terminal lug requirements and is subject to the approval of the Company. Contact the local office for specification and review of trough installations. See Figure 29 for trough details. In the Pepco region, approved switchgear can be found at the following website: <http://www.pepco.com/business/services/new/switchgear/>.

415. SWITCHES / CIRCUIT BREAKERS

A service switch or circuit breaker shall be of a type and capacity approved by the Authority Having Jurisdiction and shall be installed for each meter. The available fault current value shall be obtained from the Company.

416. SERVICE DISCONNECT IDENTIFICATION

Where group installations of two or more service switches or circuit breakers are made, each shall be legibly and permanently marked by the customer to indicate the address, apartment number or portion of the building associated with that device. Markings should be made both on the inside of the mounted unit as well as on the outside of the cover.

417. ISOLATING SWITCHES

An isolating switch with a visible break shall be installed by the customer on the line side of the meter for all self-contained 277/480 Volt and 265/460 Volt meter installations. This switch is also required for all the 120/208 Volt self-contained meter installations served from the secondary networks located in downtown Atlantic City, New Jersey and Wilmington, Delaware. The Company must be consulted about specific requirements in these cases. The switch will be owned and maintained by the customer. Local Code Enforcement agencies may require a fused switch. Before installing, consult with your Authority Having Jurisdiction. In the Pepco region, approved switchgear can be found at the following website: <http://www.pepco.com/business/services/new/switchgear/>.

D. Lighting and Appliances

418. SINGLE PHASE SERVICE

Single phase service will normally be supplied at 120/240 Volts. However, areas of downtown Atlantic City and Wilmington are served by a 120/208 Volt secondary three phase network. Single phase 120/208 Volt service is supplied in these areas. Consult the Company to determine exactly which areas could be served by a 120/208V single phase service. Special metering (see Figure 1) must be provided as well as appliances which would use the 208 voltage.

419. THREE PHASE SERVICE

Throughout the company's service territory, 3-phase service may not be readily available and certain secondary voltages may be limited. Consult the Company to determine what service voltage options are readily available. Where permitted, a cost to extend the facilities into certain areas may be incurred.

420. APPLIANCES

The voltage rating of appliances must correspond to the service voltage specified by the Company. If the customer is moving equipment from one site to another, make sure the voltage requirement for that equipment corresponds to the service voltage before operating it. Where voltages are dissimilar, 'Step-Up/Step-Down' transformers may be installed by the customer to customize the voltage to the equipment rating.

421. TANKLESS WATER HEATERS

Tankless water heaters are available in electric, as well as propane (LP) or natural gas. Electrical ratings for whole house electric models can be as high as 32 KW, and smaller point of use models can be as high as 18 KW. It is not uncommon for a home or business to have multiple electric tankless water heaters. Customers must provide the Company with the electrical rating(s) of their units PRIOR to installation. This will help ensure proper sizing of the transformer and electrical service.

422. WELDERS

Arc welders, arc furnaces and spot welders operate by creating a high impedance short circuit to ground. The operation of this type of equipment can result in harmonics and flicker, which can affect the power system and customer equipment. In every case the customer or contractor shall consult with the Company concerning the electrical supply to electric welders before any commitments for their purchase or installation are made.

E. Motors – General

423. STARTING CURRENT

It is the characteristic of most electrical motors to draw large amounts of power as they come up to speed or start. This may result in objectionable dips in voltage supply to other customers who receive their service from the same service, transformer, or circuit. In the interest of all customers, the Company limits the value of the starting current which may be drawn by certain classes of motors. Motor starting accessories are available to reduce the starting current to acceptable values. Variable frequency drives may be used to reduce starting current to as low as the running current of the motor.

Since the operation of lamps and other devices is seriously affected by abrupt voltage fluctuation of more than several percent the Company establishes maximum inrush or pulsating current limitations for utilization equipment. In the case of motors, the starting or inrush current limitation specified is the maximum increase in current per step permitted in starting the motor. Motor starting currents are considered to be the same as the locked-rotor current so that starting current limitations are given in terms of locked-rotor amperes.

The following table shows the starting current limitations applicable:

120 volts single-phase.....	50 amperes
208 or 240 volts single-phase.....	75 amperes
208, 240, 460 or 480 volts three-phase.....	100 amperes

Consult the Company for motor installations having starting currents (locked-rotor current) exceeding those given in the above table.

The starting current limitations do not limit the total current that may be taken by a motor in starting, but require that the total current be built up gradually or in steps which do not exceed the allowed value. In installations of two or more motors supplied from the same service, the starting current limit per step allowed for the largest motor shall be the limit for any other motor installed. Motors starting simultaneously shall be considered as one motor.

The Company reserves the right to measure the starting current of any motor. Contact your local office for any questions.

424. HORSEPOWER RATING

The Company must always be consulted in advance regarding motor installations above 5 horsepower single phase or above 10 horsepower three phase to insure that the proposed installation is acceptable and that company supply system is adequate for the load to be served.

Motors larger than 5 HP shall be three-phase except where three-phase service is not available. Motors up to and including 10 HP may be single-phase provided written permission for each installation is obtained from the Company. Single-phase motors, larger than 5 HP, if permitted, shall be operated from 240 volt circuits.

The company recommends that all motors be connected to circuits other than lighting circuits.

425. VOLTAGE IMBALANCE ON MOTOR LOADS

Unbalanced voltage conditions of 3% or more should be avoided to reduce the adverse impacts on induction motor loads. Increased starting and running currents, heating and reduced motor capacity are some impacts of voltage unbalance. Percent voltage unbalance can be calculated using the NEMA definition:

$$\% \text{ Voltage Imbalance} = ((\text{Max Deviation from Avg Voltage}) / (\text{Average Voltage})) * 100$$

426. REDUCED VOLTAGE STARTING

Motors equipped with reduced voltage starters that cannot be safely subjected to full voltage at starting should be provided with a device to insure that, on the failure of the supply voltage, the motor will be disconnected from the line or the starter returned to the "off" position, unless the motor is equipped with an automatic

starting means. To prevent unnecessary shutdowns, it is recommended that this starter be equipped with a time delay feature to prevent the starter from dropping out and to permit the motor to continue to operate during a momentary voltage change.

427. OTHER PROTECTION

The direction of phase rotation and the continuity of all three phases of the supply are carefully maintained by the Company; however, the Company cannot guarantee against the accidental or temporary change or failure thereof. Therefore, motors or other apparatus requiring unchanged phase rotation or continuity of three-phase supply should be equipped, by the customer, with suitable three-phase protection against reversal or loss of phase.

J. Generators

428. EMERGENCY STANDBY GENERATION

The Company must always be consulted concerning the installation of any electric generating equipment. In all cases of emergency standby generation (Non-Co-generation) a double throw switch shall be installed between the generator and the Company's metering point, to prevent the generator from being connected to the Company's system.

Since the Company's wires may be short circuited or grounded during abnormal working conditions (i.e. storm, maintenance, etc.) the customer's generator would be subjected to a short circuit. The generator would pose a threat to persons working on the lines. Closed transition switching may be permitted for restoration to the utility system after a customer & equipment specific evaluation is made by the Company. Portable generators shall only be used with the service conductors physically disconnected from the utility system to prevent any possibility of back feed onto the utility system.

Permanent installations involving closed transition switching may be permitted after specific evaluation is made by the Company. Portable generators should not be connected to the premise wiring without first creating a visible disconnect from the company's supply wires.

429. CO-GENERATION

In the case of co-generation or small power producers, the electrical connection to the utility system must be reviewed by the Company. A brochure detailing the various types of connections to the utility is available upon request. From the company website, select "Service Requests" and then select "Interconnection Standards for generators (including renewable generation)."

<http://www.pepco.com/energy/renewable/connection/>

<http://www.delmarva.com/energy/renewable/connection/>

<http://www.atlanticcityelectric.com/energy/renewable/connection>

Co-Generation or Interconnection Customers are those customers intending to install generation that connects into the Company system. These installations require that both the Company and the Customer meet certain minimum requirements for operation and safety. The Company and the licensed professional engineer for the Customer will ensure these requirements are met. It is very important the Company review these installations early in the design stage. All co-generation installations must adhere to all applicable national and local codes, standards, rules and regulations and receive all applicable approvals from all appropriate governing bodies and be designed and constructed in accordance with Good Utility Practice. If the generation is being installed under the Pennsylvania-New Jersey-Maryland Interconnection (PJM) tariff process, the Customer must also meet all applicable PJM requirements. An Interconnection Agreement or Interconnection Service Agreement, as appropriate, needs to be agreed to between the Customers, the Company, and, where appropriate, PJM. Revenue metering requirements will depend on options for exporting and/or importing power selected by the Customer.

K. Power Factor Correction

430. ECONOMICS OF POWER FACTOR CORRECTION

Attention is called to the desirability and importance of maintaining the power factor of any load as near to unity (100%) as possible. The maintenance of high power factor using appropriately sized capacitors near the loads will increase the overall operating efficiency of conductors and equipment. In states where the rates are designed with a power factor clause, additional charges may apply. See the Electric Tariff of the appropriate state for details and calculations. Where large motors are to be installed, consideration should be given to the use of synchronous motors or applying capacitors.

L. Transformer Vaults, Manholes and Pads

431. PLANNING

Customers are required to consult the Company regarding the location and construction of transformer vaults, manholes, and pads while the building plans are being developed.

432. VAULTS FOR TRANSFORMERS WITHIN BUILDING FOR LOW VOLTAGE SERVICE

Where conditions are such that the customer requests the installation of Company owned transformers within the customer's facility, the customer must provide a suitable room. Rooms must be adequately ventilated, of standard fireproof construction, be built in accordance with all applicable Codes and jurisdictional requirements, and meet all of PHI construction standards and engineering requirements.

The Company will furnish and maintain the transformers and associated protective equipment in the customer owned vault, without cost or rental charge to the Company. Contact Distribution Engineering to receive PHI requirements during building architectural and structural design if an indoor transformer installation will be requested. Because of the cost, complexity, and access problems, this is the least desirable transformer installation and is not considered standard. Consult with local engineering office to obtain engineering specifications and approval.

433. RESTRICTED USE OF VAULTS

Transformer vaults must contain only transformers and their auxiliary equipment. The customer's secondary fuses, circuit breakers and the Company's meters shall not be installed in the transformer vault. The vault is not to be used for storage and access by unqualified personnel is prohibited.

434. SECURITY OF VAULTS

The vault shall be accessible to Company personnel at all times. The customer shall grant access to a transformer vault only to qualified persons. The customer must provide suitable locks for the sole use by the Company for access. Company provided lock boxes may be installed for the storage of appropriate access keys. Warning sign (**Danger - High Voltage - Keep Out**) must be prominently displayed on the exterior of the vault door.

435. MAINTENANCE OF VAULTS

The customer is responsible for maintenance to the vault structure. This includes, but is not limited to, the integrity of all structural components (walls, ceiling & doors), lighting and ventilation (fans, louvers, etc.).

436. TRANSFORMER MANHOLES

The quantity, size, and configuration of manholes vary greatly depending on electrical load requirements and building location. Consult the company for site specific requirements.

437. TRANSFORMER PADS

Poured or pre-cast concrete pads for Company equipment must be provided by the customer in certain situations. Outdoor pad mounted equipment may be made less noticeable by using landscaping or other

architectural treatments. It is important to consult with the company to insure that none of the planned screening will interfere with the equipment's operation. (See Figure 30)

M. Substations

438. PLANNING & DESIGN

The Company shall always be consulted regarding the location, layout and key design features of customer owned substations before the plans are completed.

N. Metering on a Private Structure

439. DISCONNECTING MEANS

Where Company service terminates at a privately owned pole or structure and is metered at that point, a disconnecting means should be provided on that same structure by the customer on the load side of the meter. (Examples: farmstead, mobile home, estate and pertinent attached buildings). If service is furnished at 277/480 Volts [265/460 Volts (Pepco Only)] or from a secondary network system (Atlantic City and Wilmington), a disconnecting means ahead of the metering must also be provided.

O. Sensitive Electronic Equipment

440. PROTECTION

Protection of end use equipment is suggested to protect against disturbances such as weather, automobile accidents, static electricity and even sources within the customer's facility. Electronic equipment such as computers, video/audio equipment, and industrial process controllers, should be protected from power interruptions, transient and short duration voltage variations. When purchasing transient voltage surge suppression (TVSS) equipment, care should be given to the selection and installation of the device to provide the desired protection. The use of a battery powered uninterruptible power system (UPS) can provide uninterrupted power to sensitive/critical equipment during voltage variations to ensure reliable operation. Proper electrical system grounding, bonding and the installation of dedicated circuits for sensitive electronic equipment can help reduce the exposure to some forms of electrical interference. Contact the Company if you would like additional information or suggestions.

P. Customers' Use of Service

441. DISTURBANCES

Electric service must not be used by a customer in a manner as to cause unusual fluctuations, harmonics or disturbances in the Company's supply system. Should such disturbances be caused by the customer, the Company may require the customer to modify the installation and/or install approved controlling devices. Failure by the customer to implement corrective measures will constitute cause for the Company to discontinue service.

442. PHASE LOAD BALANCE

Where Commercial or Industrial service is rendered, the customer shall at all times balance the load on the available phases. The phase loading shall be balanced such that the customer causes no more than 1% phase voltage unbalance measured at the point of service. Should the customer choose to operate an unbalanced system, the Company reserves the right to compute, in accordance with local tariff, the customer's billing demand. The effect of load unbalance on voltage can cause overheating in motors and other customer equipment as well as overload the company's service equipment.

443. FEEDER LOAD BALANCE

Where a customer is provided with service from more than one normal load carrying feeder and the customer can transfer load, either manually or automatically, between feeders, the customer distribution feeders must be designed and operated so that the total load is reasonably balanced between all feeders under normal

and emergency conditions at the time of the customer's peak. The highest loaded feeder is not to exceed the loading of the lightest loaded feeder by more than 10%. (Note: This does not apply to customers supplied by two (2) feeders, one (1) normal load-carrying feeder and one (1) emergency standby feeder.)

CHAPTER 5 – METERS

A. General Information

501. NUMBER OF METERS

The Company will normally furnish, install, maintain and own one set of metering equipment for measurement of electric service supplied under each account. Adding a new metered service to a location which is already metered in order to accommodate a new load is not a substitute for upgrading the existing service entrance equipment.

502. ACCESS

The authorized agents or representatives of the Company having the proper Company identification shall have access at all times to the premises of the customer for the purpose of inspecting, removing or repairing any property of the Company situated thereon.

503. METER BOX SUPPLY

Meter sockets and cabinets are not normally supplied by the Company. Local electrical distributors and supply houses sell Company Approved Meter enclosures. Approved equipment can be found on the Company's website:

<http://www.atlanticcityelectric.com/business/services/new/sockets/>

<http://www.delmarva.com/business/services/new/sockets/default.aspx>

http://www.pepco.com/_res/documents/ApprovedResidentialMeterSockets.pdf.

The Company will not connect to nonstandard meter enclosures. (See Figure 31 for approved sticker) Weatherproof connections must be used for all cable and conduit entry.

Pepco provides the remote meter panel for cabinets greater than 800 Ampere.

504. OWNERSHIP

Self contained meters, transformer rated meters, transformers, and associated electrical equipment are provided by the Company. This metering equipment remains the property of the Company. Meter enclosures and/or conduit purchased and installed by the Customer remain the property of the Customer. No person except a duly authorized representative of the Company shall make any connection or disconnection, either temporary or permanent, between service load of the customer and the service wires of the company. In addition, no person except a duly authorized representative of the Company may set, change, remove or interfere with or make any connections to the Company's meter or other property or any wiring between the Company's meter and the service wires of the Company.

505. INSTALLATIONS PROHIBITED

Meter enclosures, meter mounting devices or transformer cabinets that may be furnished by the Company will be installed by the customer at no expense to the Company. In no case shall any meter enclosure be used as a junction or distribution box. No service equipment ground wires may be run through or attached to meter equipment enclosures.

506. TRANSFORMER RATED METERING

Services in excess of 400 amperes require the use of transformer rated metering. Self contained metering up to and including 600 amperes is available at Delmarva Power. Transformer cabinets or switchgear must be provided and installed by the Customer. In some instances, the Company may sell current transformer cabinets directly to the Customer.

NOTE: In the Pepco and ACE Regions only 120/240 volt can have self contained metering up to 400 amperes. All other services over 200 amperes require the use of transformer rated metering.

507. EXCESSIVE METERING COSTS

The cost of transformer rated metering is far more expensive than a socket meter. Customers installing oversized services, where the Company's experience is that the load can be served with a socket meter, (if allowed) may be charged for the excessive cost to the company for the unnecessary metering capacity.

508. CONDUIT

In all cases involving transformers in cabinets or switchgear, the conduit for the secondary wiring to the meters will be furnished and installed by the customer's contractor. Conduit size, type and configuration should be approved by the local office. The transformers and associated wiring will be installed by the Company.

509. RESALE OF ELECTRICITY

Resale of bulk metered electricity may be permissible under provisions of the Tariff of a particular jurisdiction. Contact your local Company office for more information.

Residential multiple occupancy buildings, shopping centers and housing units must have individual metered service or, if allowed by the authority having jurisdiction, be sub-metered in accordance with local codes and regulations.

510. AESTHETICS

Outside meter locations may be concealed or screened using various approaches. All such plans must be reviewed by the Company and comply with local codes and ordinances. Complete enclosure using metal or masonry is not allowed. Adequate clearances and access to the Company's meters and cables must be maintained. Customers may request a different meter location. Additional costs incurred for meter location changes, if acceptable by the Company, will be borne by the customer.

B. Meter Locations

511. METER LOCATION

In all cases, approval for meter locations must be obtained from the Company before installation. For residential services, the meter is to be located on the outside of the building on the side of the residences, within three feet or as close as reasonably possible to the front wall and outside of fences. This location minimizes the Company's required access to the Customer's premises. Alternate locations must be approved by the Company and will require reimbursement for any additional costs incurred. In certain circumstances the meter can be mounted on a self supporting structure or on an approved meter pedestal.

Local codes and/or site conditions may necessitate that meters will be located indoors. A dedicated meter room must be provided for **meters located indoors**. If located in an indoor meter room the height of the center of the meter can be reduced to two feet. At least three feet of unobstructed space in front of the meter must be provided. Sufficient space to permit full opening of all meter cabinet doors is required. Indoor meters installations shall have provisions for remote automatic meter reading. Meters that communicate using an RF network (AMI) shall be located where there is sufficient signal strength, or have provisions for an external antenna. In those locations where RF reception can not be provided the customer must provide access to a dedicated phone line.

Unsuitable Meter Locations – Meters shall not be installed in a hazardous location; on mobile equipment; in a location accessible only through a trap door or by means of a ladder; in a location with less than six feet of headroom; in a clothes storage or janitor's closet; in a pantry; in or through a trash room, bathroom, doorway, toilet, coal bin, show window or attic; where subject to chemical fumes or damage, over a fuel tank, stove, radiator, stationary wash tub or sink; in a continuously wet or damp place; under a pipe likely to sweat; or in the same room or enclosure with more than nine gas meters or approved gas meter locations; on partition subject to vibration or in location subject to great variation in temperature. The list of locations above is not all inclusive.

When replacing or upgrading services, existing indoor meter installations of all self contained socket type meters should be relocated outdoors.

512. OUTDOOR LOCATIONS

The height of socket meters located outdoors should be no more than six feet above grade and no less than three feet to the top of the meter. **If the local jurisdiction or code requirements dictate a higher elevation, please consult with the company.** If the meter exceeds six feet from the ground, it is necessary to provide a permanent structure allowing the company access to the meter while standing. At least three feet of unobstructed space in front of the meter must be provided. Meters shall not be installed on company poles. It is necessary that the metering equipment be rigidly attached to the customer's structure or building. Figures 20 and 27 illustrate typical attachments. When attaching to masonry walls, do not use plastic anchors. Instead use suitable metallic anchors with compatible machine bolts. The meter box must also be plumb and level before the meter will be set. Outside meter sockets shall be installed only on the finished outside wall surface (i.e., on brick veneer, aluminum siding, wood siding, etc.) unless alternative methods are approved in advance and in writing by the Company. If, in the opinion of the Company, the finished outside wall cannot support the meter socket adequately, the Customer shall provide such additional support as required.

513. PERMANENT SELF SUPPORTING METER STRUCTURE

In cases where a building structure does not exist, a metal unistrut (H-frame) shall be used to mount the meter socket (i.e. ball field, soccerplex, cell site etc.). The H-frame must be in an upright position and support structures are to be installed on a solid foundation of concrete (direct buried in dirt is unacceptable). See Figure 27. Wooden structures may be used if approved by the local office.

514. METER PEDESTAL

Manufactured meter pedestals can be used for individual services rated 200 amperes and less. These devices must be UL listed and approved by the Authority Having Jurisdiction. Specifications for these pedestals should be submitted to the Company for approval prior to purchase. At Pepco, meter pedestals used for commercial services such as traffic signals must be equipped with a manual by-pass. See Figure 26.

515. METER ROOMS

Meter locations above the first floor are not normally approved. Meters shall be suitably located in a clean, adequately lighted and safe place free from vibration and shall be accessible from the outside for the convenience in reading, testing and repair. The Company must have 24 hour access. In all cases, customers are required to consult the Company regarding the location of the metering equipment. Where metering equipment is installed in metal enclosed switchgear, metal-clad switchgear or switchboards hinged doors arranged for sealing shall be provided for access. Removable metal plates will not be approved. Inside meter connection equipment supports shall consist of frames or racks provided with suitable brackets or panels for mounting meter connection equipment and meters. Where wood panels are used, the boards shall be clear dressed and not less than three-quarters of an inch thick.

516. JUMPERS

The use of jumpers is forbidden without prior approval by the company. When approved, the jumpers must be compatible with the equipment being jumpered.

517. MULTI-METER INSTALLATIONS

Multi-meter installations for customers such as apartment buildings, office buildings, commercial buildings or industrial customers, where there is a large number of meters or the equipment is especially bulky, should be installed outdoors if possible. However, if this is not possible, the company may approve a suitable alternate location. Often such installations are facilitated by using a meter stack or trough. For trough meter installations see Figure 29. Multiple individual service entrance cables run up the wall from individual meter boxes to the

attachment of the overhead service wire are less desirable than running one or two large cables down the wall into a trough. It may become impossible to connect too many individual service entrance cables to one overhead service wire.

518. SAFETY

If the interior of the meter devices is exposed to the weather or if the terminals are energized, it must be temporarily protected. It is very important to notify the Company if you energize a new meter box and just cover it. A Company employee will either install the meter and seal the box or will seal the protective cover. A covered but unsealed energized meter box is potentially dangerous if tampered with. Replacement of a meter box is required if the locking mechanism is not functional. Unauthorized removal of meter locking provisions by someone other than a Company employee implies tampering or theft of service. In addition to breaking the law, the act can be hazardous. Unsealed or removed meters must be reported to the company immediately.

519. PROXIMITY TO GAS METERS, REGULATORS AND VENTS

The location of electric meter connection equipment in relation to gas meters, regulators and vents or approved locations of gas equipment shall be such that the distance measured in any direction between the nearest sides of the equipment is a minimum of three feet. On townhouses, **if space limitations require**, the minimum clearance may be reduced to one foot for outside meter locations, however, the three foot clearance for inside meter locations shall remain. The gas equipment shall not be located below the electric meter. The foregoing clearances are a minimum and local requirements of permitting authorities should be checked.

520. PRIMARY METERING

Customers with large loads often choose to be served and metered at the Company's primary voltage. Such customers (primary metered) are required to install a high voltage disconnecting means behind the high voltage metering. This is a requirement of the National Electrical Code (Rule 230-205 b), not a company rule. Check with your local Company office. When electric service is supplied at high voltage delivery levels (13.2 kV or above) primary cables will be furnished and installed by the Company, extending from its main line facilities to the Customer's main disconnecting device located at a point determined by the electrical and architectural design of the building or project and approved by the Company.

C. Group Metering

521. IDENTIFICATION

When multiple meters are grouped together, it is usually difficult to determine what meter position feeds a particular address. For this reason the contractor must indelibly mark the unit number or the address on both the outside and the inside of the meter box. It is most important that the inside be marked since box covers can sometimes be swapped. Meters will not be set unless the permanent marking has been done.

522. MANUFACTURED METER ASSEMBLIES

Usually when the exact number of customers for a building is known, a manufactured meter box assembly is specified. It is not as flexible for adding meters as is the trough arrangement previously discussed. Some large group metering installations can create problems for our meter readers. Before buying a specially built group meter enclosure, consult the Company.

523. PROTECTION

If more than 6 meter locations exist for a single service, a main disconnect ahead of all the meters must be provided. If service cable is to be run to a unit through the building, it must be protected by a fuse or circuit breaker.

524. TROUGH FED METERING

Where individual meters are fed from a trough, in no case shall there be metered and un-metered conductors

in the same trough. A service trough of approved design with cable supports shall be provided for service connections requiring two or more service entrance conductors per phase. Service troughs must be sealable and constructed with removable panels of such size and weight that they can be removed readily by one person.

D. Meter Connections

525. SOCKET METERS

Customers shall furnish and completely install suitable wiring within the meter box. Line side wiring goes to the top connections and load side connections to the bottom. When an underground service is supplied to the meter box by the Company, those wires will be run into the meter box and connected by the Company. The meter will be furnished and installed by the Company.

526. TRANSFORMER RATED SERVICE

The Company will provide and install the test block and all secondary wiring from the transformers to the meter. The transformers furnished by the Company for the job and the service cables are installed by the electrical contractor. In the Pepco Region the Company will provide and install service cables, the test block, transformers, and all secondary wiring from the transformers to the meter.

527. FIFTH CLIP

Where single-phase 120/208 Volt service is available and approved, a meter mounting device with 5 terminals is required. (See Figure 1) The fifth terminal may be obtained from the meter box supplier and shall be installed in the 9 o'clock position.

528. REMOTE COMMUNICATIONS

All meters must be located such that remote communication can be established and maintained to provide full customer benefits. The Company's preferred method of remote communication is by the use of radio frequency. Meters located outside must be kept clear of obstructions to a distance of 3 feet. Obstructions include but are not limited to structures, vehicles, debris, bushes, trees and shrubs. Inside meter locations must be approved by the Company. These inside locations should be at street level or 1st basement level and positioned near an exterior wall. These locations referred to as Meter Rooms must be provided with lights, ventilation, and 120 volt power outlets. In these instances, the Customer may be required to provide a conduit with pull line from the meter room to the outside of the building where a communication device would be installed by the Company. Where radio frequency communication is not possible, the customer must provide a conduit with pull line from the meter room to a point of telephone or cable access.

CHAPTER 6 – TEMPORARY ELECTRIC SERVICE

A. General Information

601. DESCRIPTION

Temporary service is a service that typically exists for less than one year. Although temporary services vary in size, the most common is 200 Amp, single phase. Common installations can be found in the following figures. (21, 22 & 23)

For the specific requirements for higher capacity and/or three phase service, consult with the Engineering personnel at the Company's local office.

602. PREREQUISITES

Temporary service will be rendered only when and where the Company has the necessary facilities available to deliver the requested service, without detriment to the service of other customers.

Permanent service will not be expedited to provide temporary construction power.

603. COSTS

Extensions from the Company's existing lines and the entire cost of connecting and disconnecting service must be paid by the customer prior to the installation of facilities.

604. LOCATION

All temporary service locations shall be approved by a Company representative.

605. MATERIAL / SUPPLIES

All equipment except the meter shall be furnished and installed by the customer/contractor.

606. SAFETY

No temporary pole or wire installations may be moved while the Company's service is either energized or attached. The temporary service must be located to avoid construction traffic and other activities that may create an unsafe situation. All applicable codes and clearances must be adhered to at all times.

Under no circumstances will the temporary service be allowed to back feed the service panel or meter socket.

IMPORTANT: Before digging for the post and before driving for the ground rod, have the underground electric facilities marked by the local 1-call or Miss Utility locating service.

B. Overhead

607. CUSTOMER'S SERVICE POLE

A pole or timber to which the Company dead-ends a temporary overhead service for supplying a construction project shall be supplied and erected by the customer and shall meet the Company's minimum requirements as outlined in this section.

608. POLE/TIMBER SIZE

If the Company's service wires will cross a public street or highway, the support must be a treated pole of Class 6 or larger. A Class 6 pole has a minimum diameter at the top of 5.4 inches. If the service will not cross a public highway or street, the support may either be a treated pole or timber. If a timber is to be used, it shall be structural grade fir or pine with a cross section not less than 5-1/2 inches by 4-1/2 inches (nominal 6" x 6"). No ladders will be placed on temporary posts. Conductors must extend to the ground to allow for safe connection to Company facilities.

609. POLE / TIMBER SETTING DEPTH

The pole or timber shall be long enough so that, when set to the proper depth, it will provide a suitable location for the attachment of the Company's service at a sufficient height to insure compliance with the clearances shown on Figures 22, 23 and 24.

610. GUYING / BRACING

The pole or timber shall have inherent strength or be adequately guyed to support the service conductor. Braces are to be 2" x 4" nominal lumber well spiked into the pole or timber at least 10 feet above the ground and to solidly driven 2" x 4" stakes. For 1/0 triplex or larger, installation of a guy wire to an anchor in the ground may be required depending on the span length. Contact the local office for specifications.

611. LOCATION

The customer's pole or timber must be at a location approved by the Company.

612. WIRE / SPAN

Temporary services will normally be three-wire, 120/240 Volt and limited to one span of 100 feet provided

proper ground clearance can be maintained. It is important to note that wires must be installed with sag or they will exert too much force on dead-end structures. Sags in larger wires or longer spans are greater and compromise vertical ground clearance. Before placing the pole contact the Company. The customer/electrician must install the overhead conductor at the point of attachment with sufficient length to reach the ground. See Figures 21 and 22.

613. DRAWINGS

Temporary service poles shall be wired as shown in Figures 21 and 22.

614. INSPECTION

The entire customer installation, including grounding, must be approved by the 'Authority Having Jurisdiction'.

C. Underground

615. GENERAL

When a customer requires a temporary service from an underground distribution system, the pole or timber with service equipment shall be installed by the contractor and shall meet the requirements in this section.

IMPORTANT: Before digging for the post and before driving for the ground rod, have the underground electric facilities marked by the local 1-call or Miss Utility locating service.

616. CUSTOMER'S SERVICE POLE

The support shall be a treated pole or structural timber with a cross sectional area of not less than a nominal 4" x 6" or a 2" x 12" board.

617. LENGTH

The pole or timber must be of sufficient length to be installed in the ground to make the support sturdy against accidental damage, approximately 30". See Figure 23.

618. LOCATION

The pole or timber must be at a location specified and approved by the Company, and will be nominally 5 feet from an existing pad mounted transformer, secondary pedestal or splice box. See Figure 23.

619. CABLE & CONDUIT INSTALLATION

In the Atlantic City Electric and Delmarva Power regions, the contractor will provide conduit down the pole or timber from the meter box to a distance approximately 8 inches below grade, and enough underground cable to reach the Company's transformer or splice box. The contractor must dig the trench from the support to within 3 feet of the Company's facility at a minimum depth of 12 inches.

In the Pepco region, the company installs the cable for the line side of the meter. The customer is required to provide and install 4 inch conduit on private property. Contact the local office for specifications.

620. CABLE SIZE / TYPE

In those instances where the customer is required to install the cable, the underground cables must be 600 Volt rated and approved for direct burial. The cable provided by the electrician must be of sufficient length to reach to the splice box or the transformer's low voltage compartment (the far right front side as you face the transformer) and sweep up to the terminals. The minimum cable size will be #2 AWG aluminum.

621. INSPECTION

The entire installation, including grounding, must be approved by the 'Authority Having Jurisdiction'.

SINGLE PHASE, 3 WIRE, 120/240 & 120/208 VOLT METER WIRING DIAGRAM (200AMP SINGLE CONDUCTOR)

~ FIGURE #1 ~

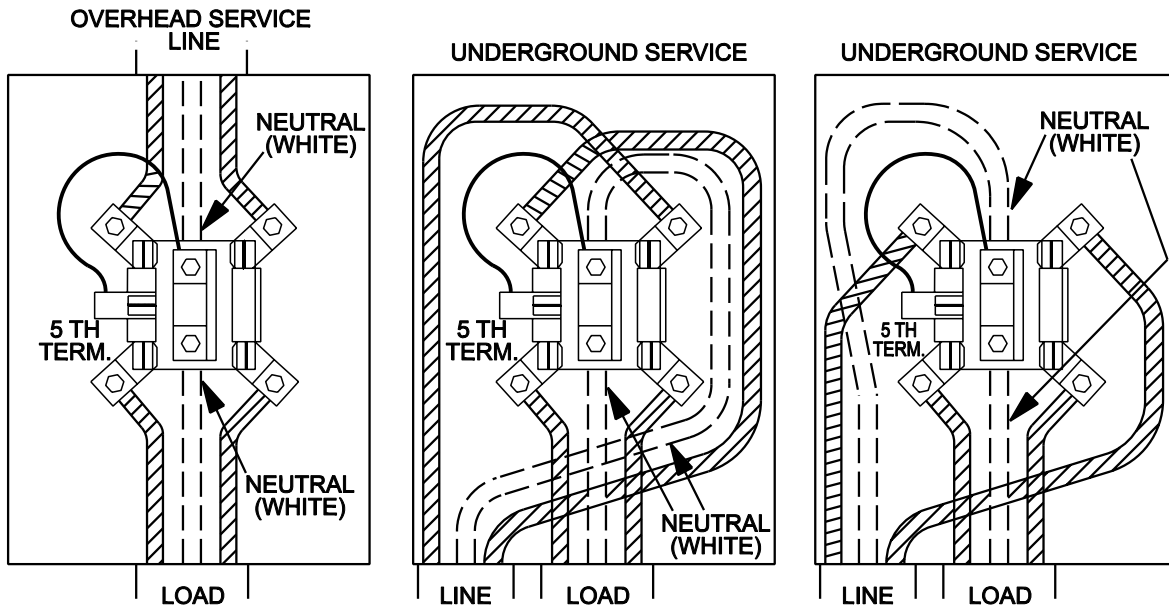

NOTES:

1. A LINE SIDE ISOLATING SWITCH, WITH A VISIBLE BREAK, IS REQUIRED FOR THE EXCLUSIVE USE OF ACE / DELMARVA ON ALL 120/208V SERVICES FED FROM THE DOWNTOWN ATLANTIC CITY AND WILMINGTON SECONDARY NETWORKS.
2. THE FIFTH TERMINAL CLIP IS ONLY REQUIRED ON THE 120/208V SERVICES.
3. THE FIFTH TERMINAL CLIP AS SHOWN SHALL BE PROVIDED BY THE ELECTRICAL CONTRACTOR.

AJS 5/12/2010

Applies to:



SINGLE PHASE, 3 WIRE, 120/240 VOLT METER WIRING DIAGRAM (320AMP UNDERGROUND SINGLE & PARALLEL CONDUCTOR)
 ~ FIGURE #2 ~

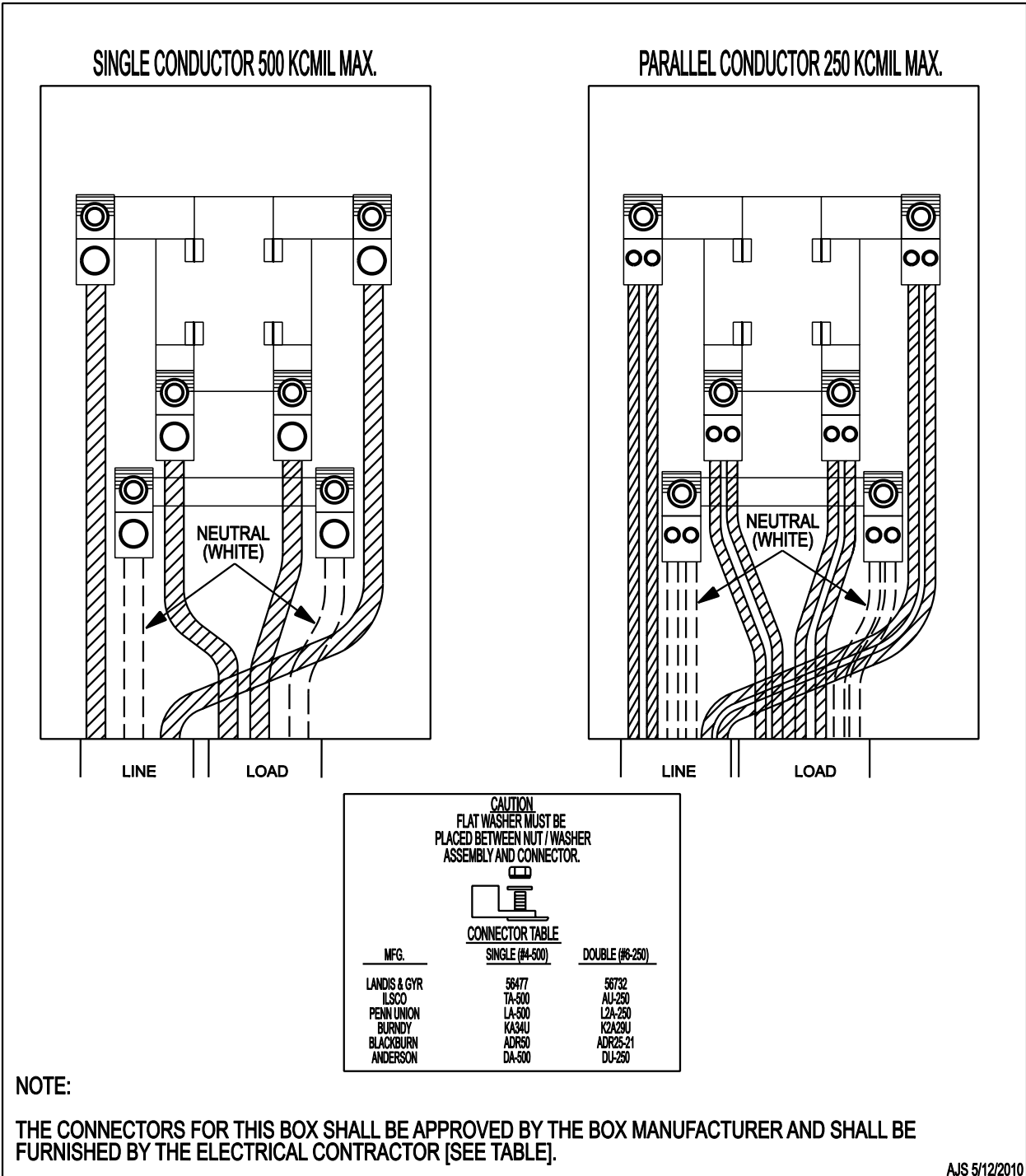

Applies to:



SINGLE PHASE, 3 WIRE, 120/240 VOLT METER WIRING DIAGRAM (320AMP OVERHEAD SINGLE & PARALLEL CONDUCTOR)
 ~ FIGURE #3 ~

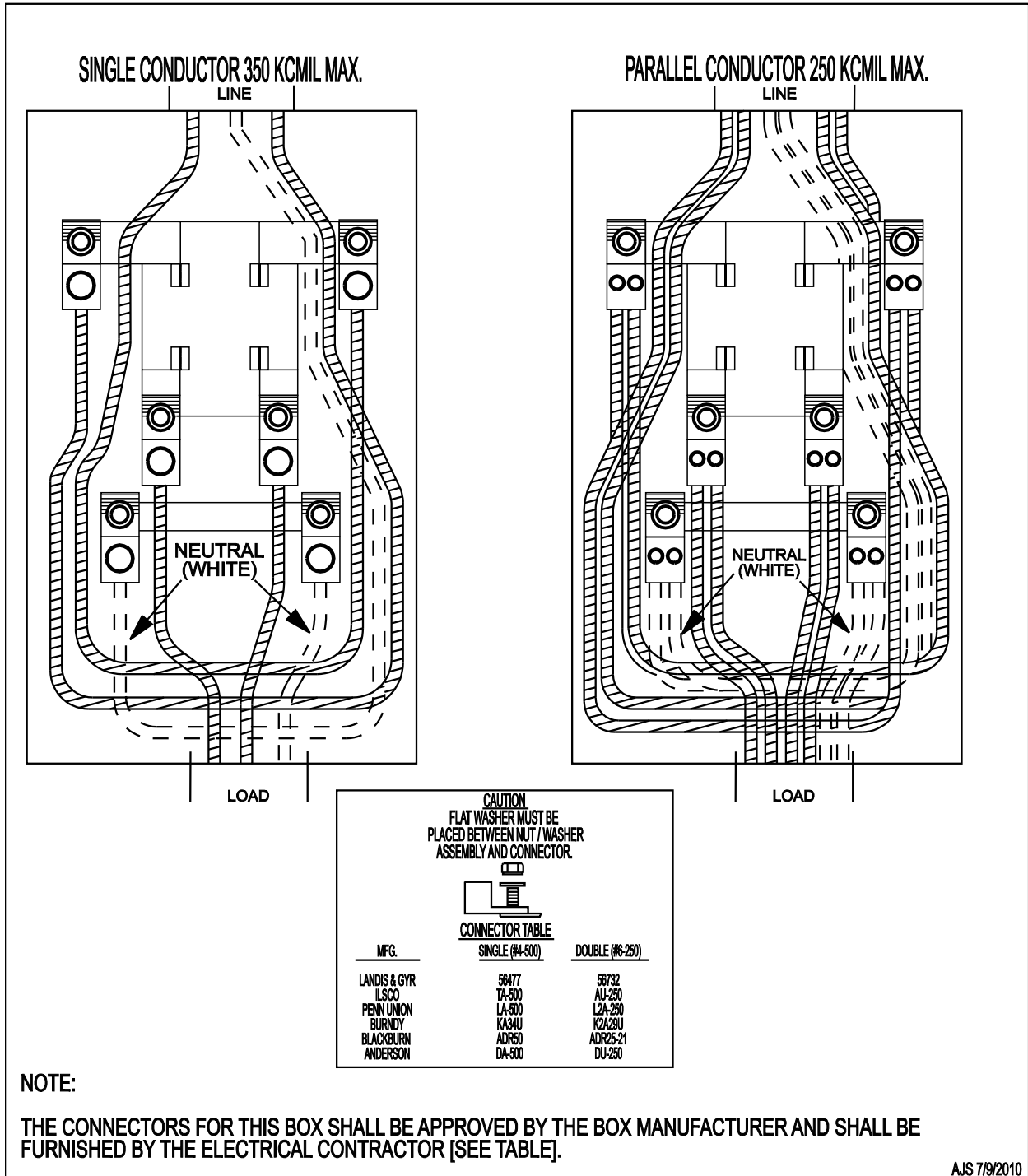

Applies to:



SINGLE PHASE, 3 WIRE, 120/240 VOLT METER WIRING DIAGRAM (400AMP SINGLE CONDUCTOR)

~ FIGURE #4 ~

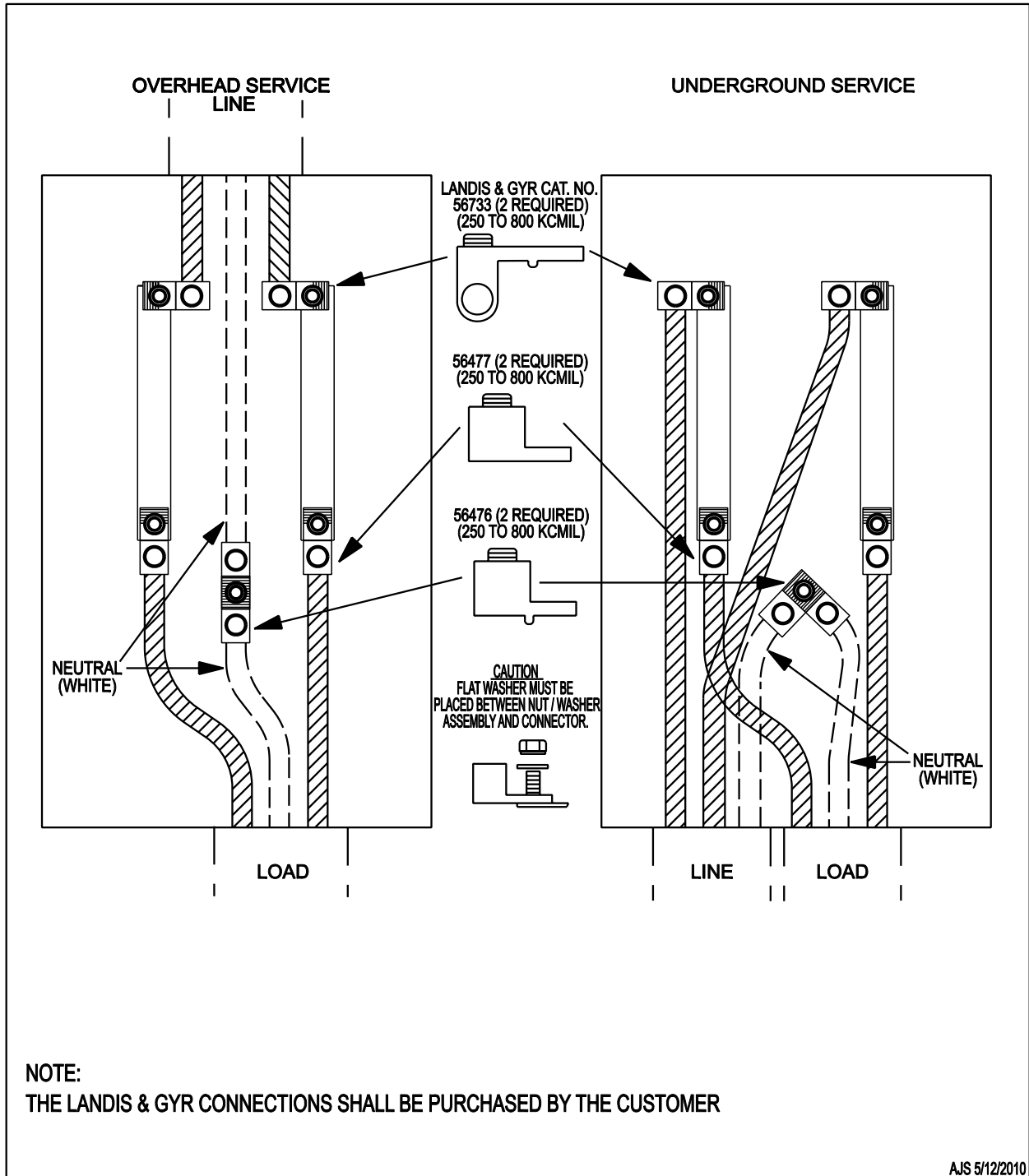

Applies to:



SINGLE PHASE, 3 WIRE, 120/240 VOLT METER WIRING DIAGRAM (400AMP PARALLEL CONDUCTORS)

~ FIGURE #5 ~

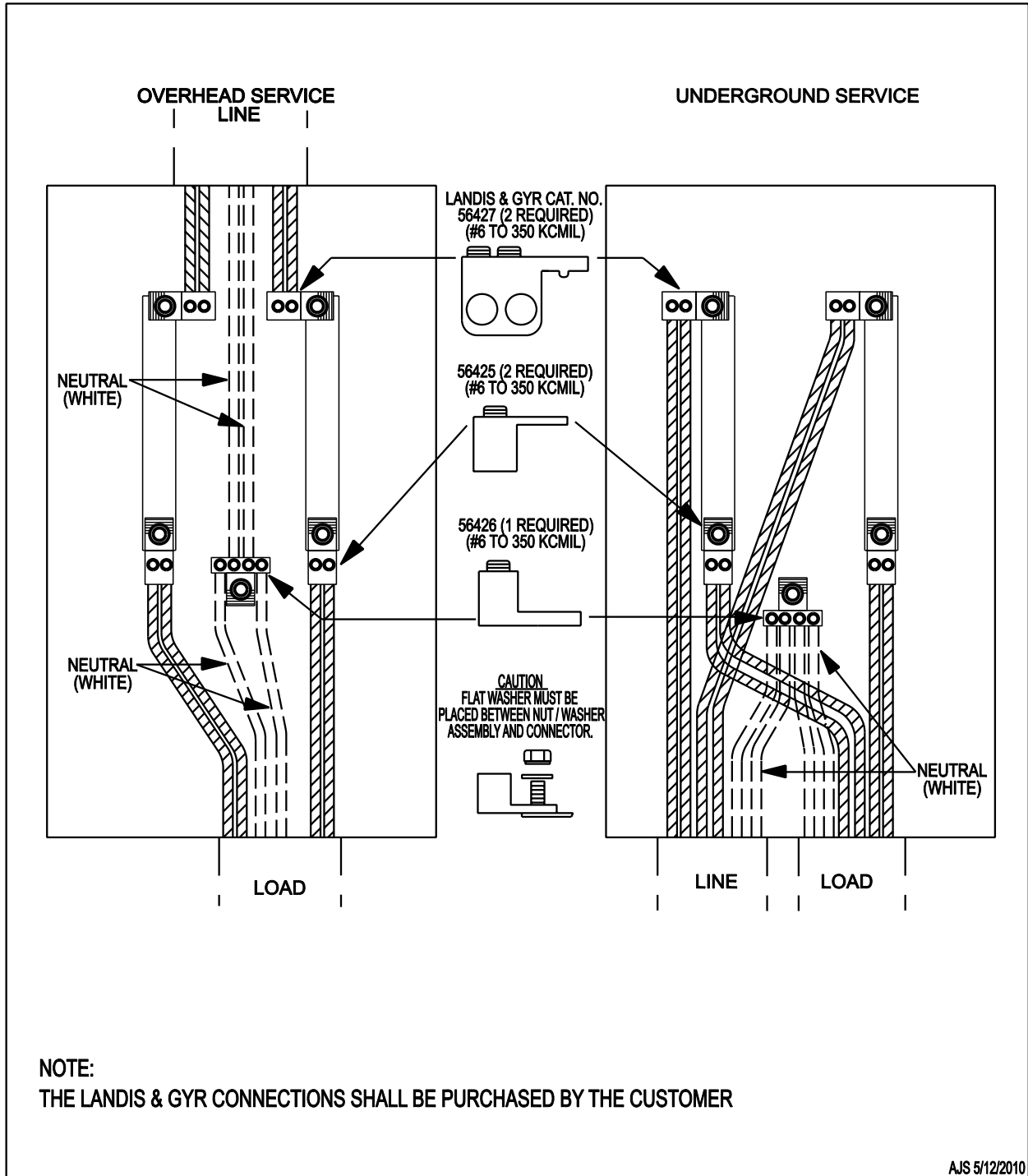

Applies to:



SINGLE PHASE, 3 WIRE, 120/208 VOLT METER WIRING DIAGRAM (400AMP SINGLE CONDUCTOR)

~ FIGURE #6 ~

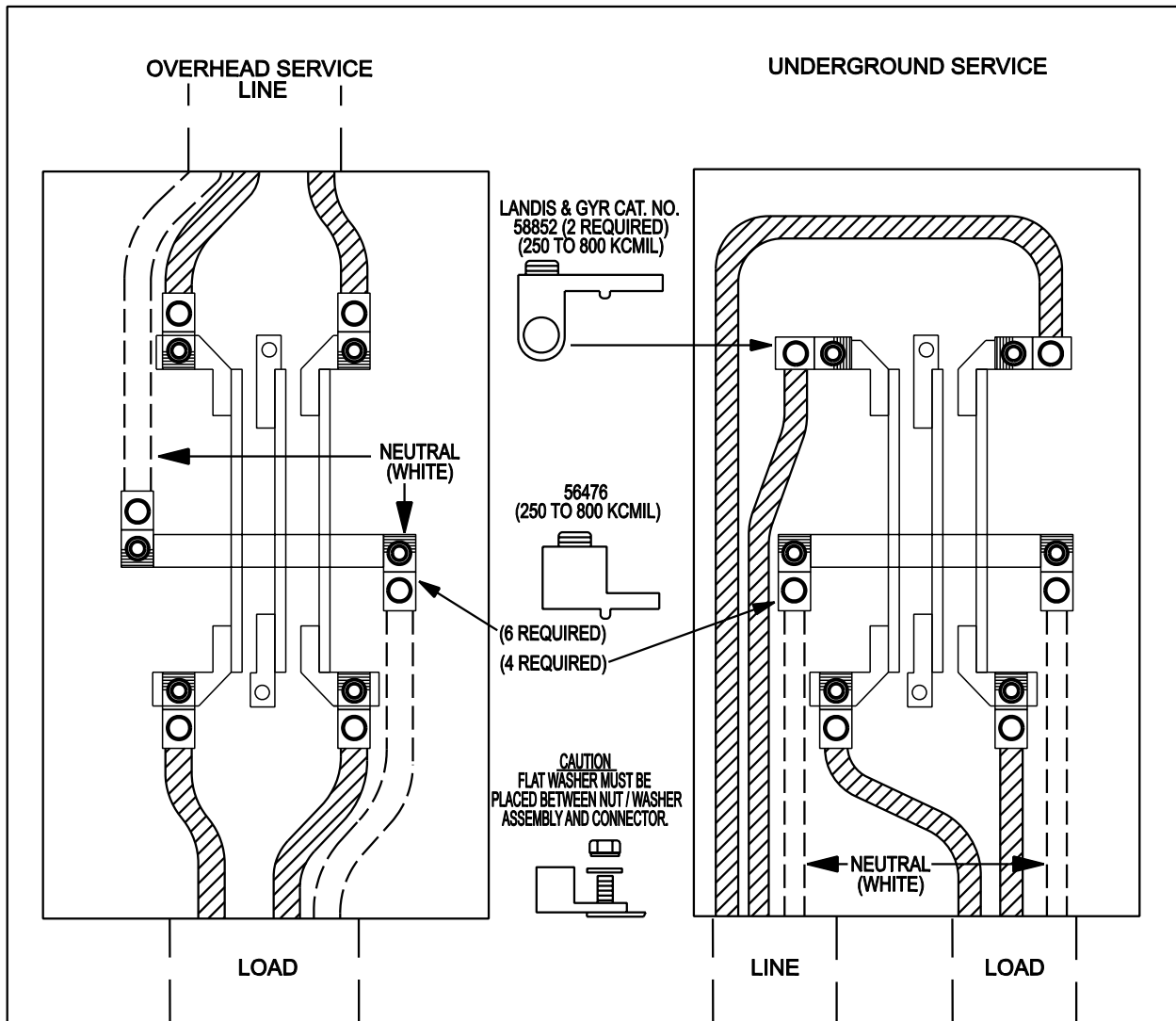

NOTES:

1. THE CONNECTORS FOR THIS BOX SHALL BE APPROVED BY THE BOX MANUFACTURER AND SHALL BE FURNISHED BY THE ELECTRICAL CONTRACTOR.
2. A LINE SIDE ISOLATING SWITCH, WITH A VISIBLE BREAK, IS REQUIRED FOR THE EXCLUSIVE USE OF ACE / DELMARVA ON ALL 120/208V SERVICES FED FROM THE DOWNTOWN SECONDARY NETWORKS IN ATLANTIC CITY AND WILMINGTON.

AJS 5/12/2010

Applies to:



An Exelon Company



An Exelon Company

SINGLE PHASE, 3 WIRE, 120/208 VOLT METER WIRING DIAGRAM (400AMP PARALLEL CONDUCTORS)
 ~ FIGURE #7 ~

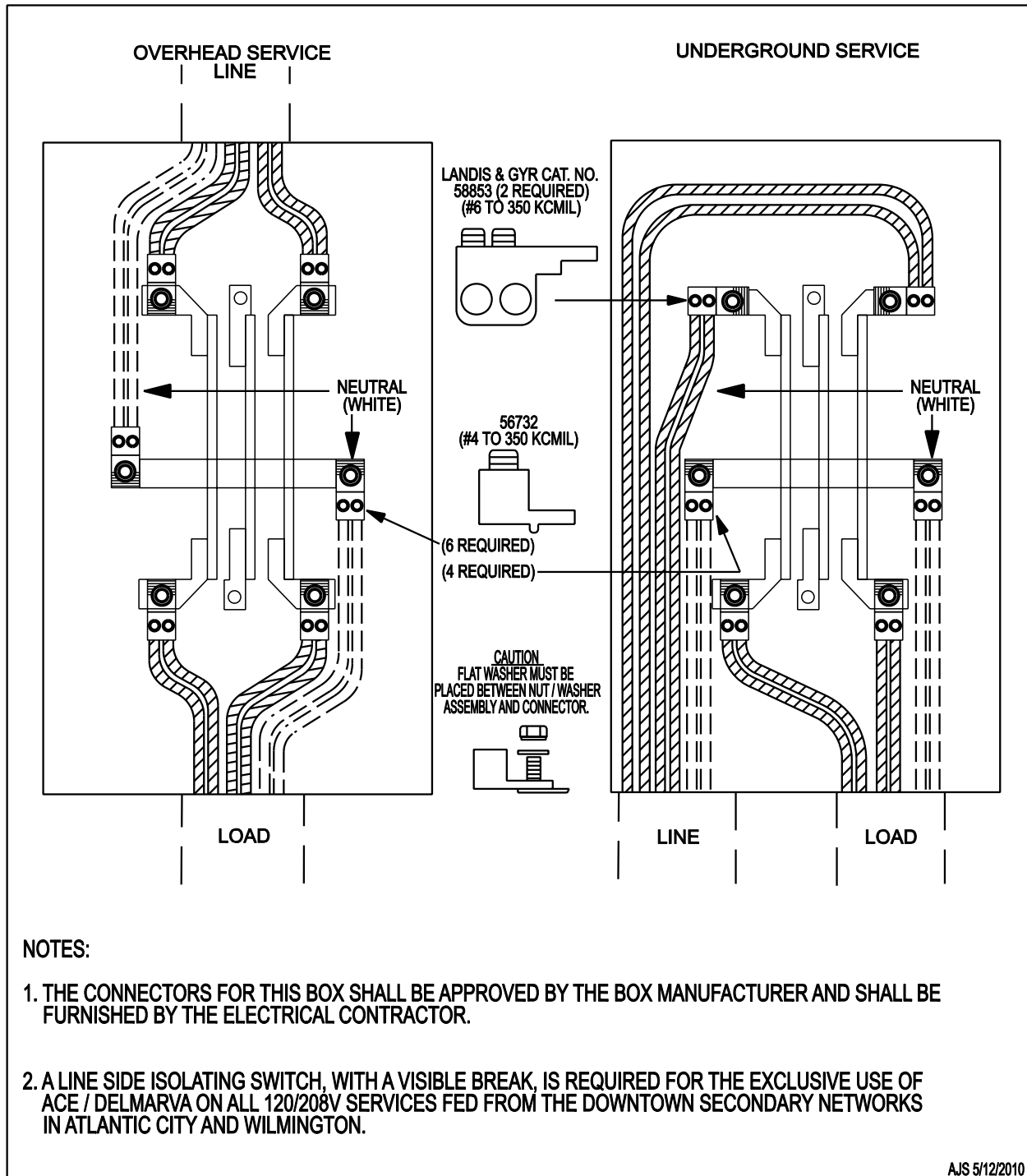

Applies to:



THREE PHASE, 4 WIRE DELTA, 120/240 VOLT METER WIRING DIAGRAM (200AMP SINGLE CONDUCTOR)

~ FIGURE #8 ~

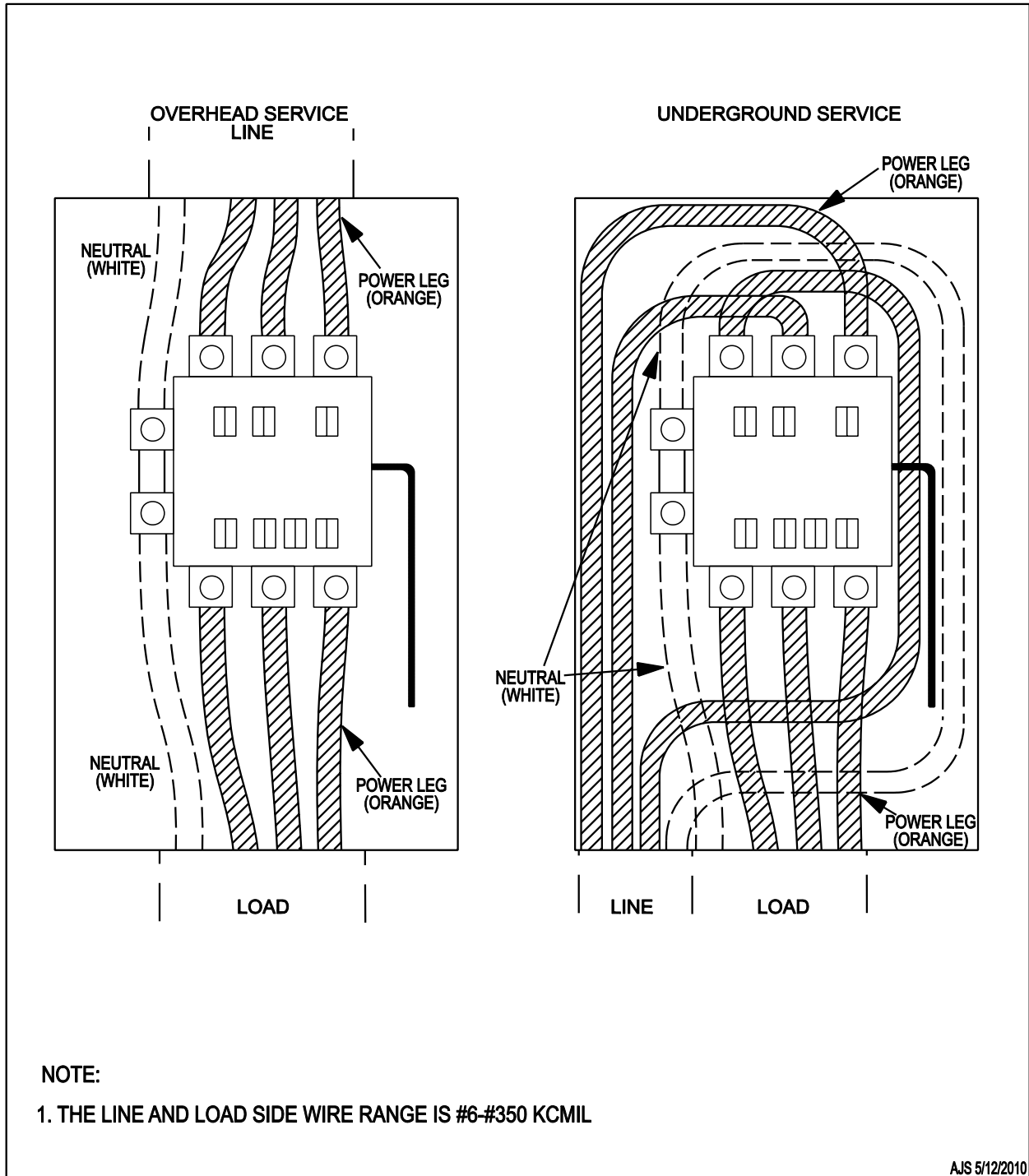

Applies to:



THREE PHASE, 4 WIRE WYE, 120/208 & 277/480 VOLT METER WIRING DIAGRAM (200AMP SINGLE CONDUCTOR)
 ~ FIGURE #9 ~

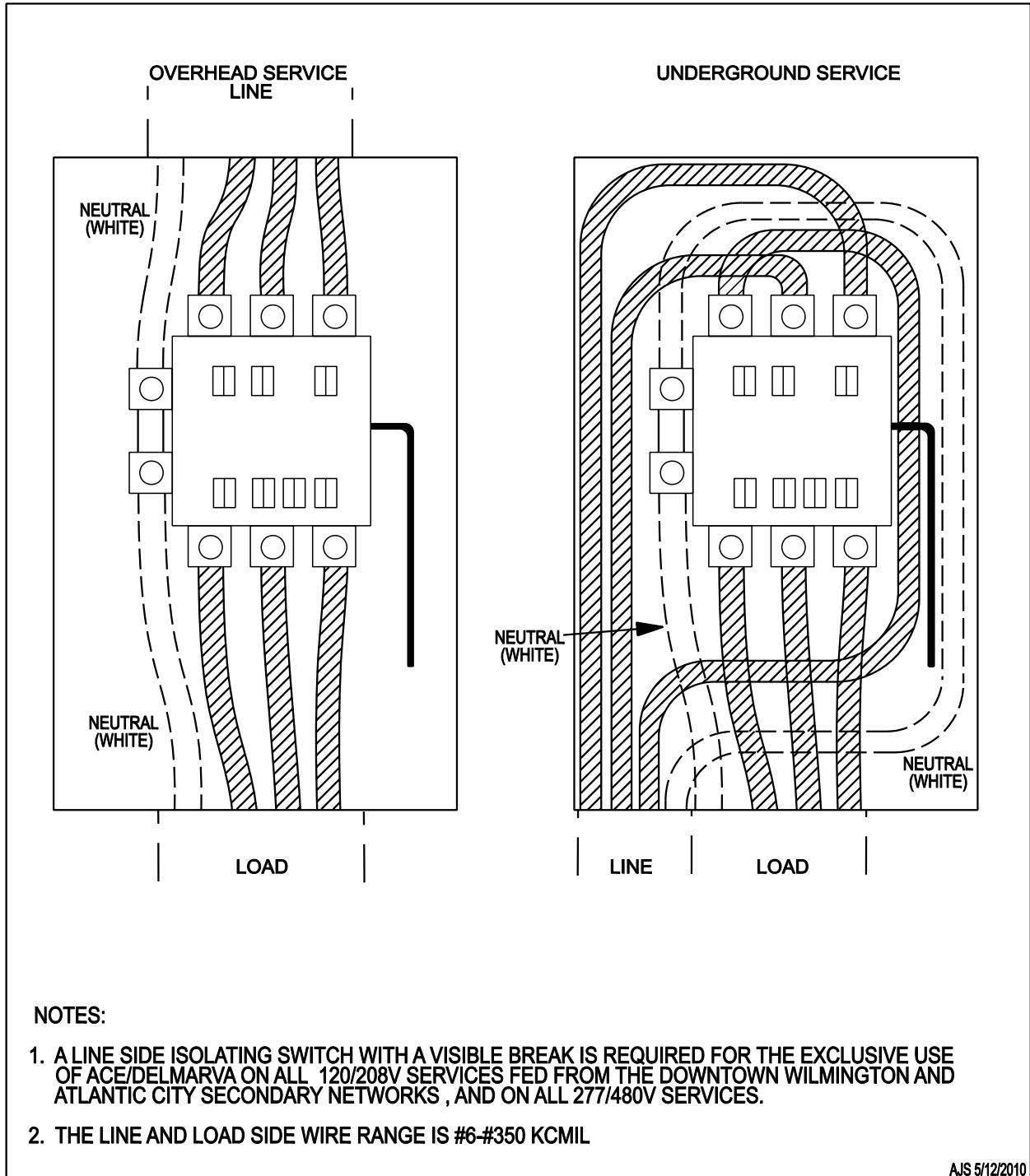

NOTES:

1. A LINE SIDE ISOLATING SWITCH WITH A VISIBLE BREAK IS REQUIRED FOR THE EXCLUSIVE USE OF ACE/DELMARVA ON ALL 120/208V SERVICES FED FROM THE DOWNTOWN WILMINGTON AND ATLANTIC CITY SECONDARY NETWORKS, AND ON ALL 277/480V SERVICES.
2. THE LINE AND LOAD SIDE WIRE RANGE IS #6-#350 KCMIL

AJS 5/12/2010

Applies to:



THREE PHASE, 4 WIRE DELTA 120/240 VOLT METERING WIRING DIAGRAM (400AMP SINGLE CONDUCTOR)

~ FIGURE #10 ~

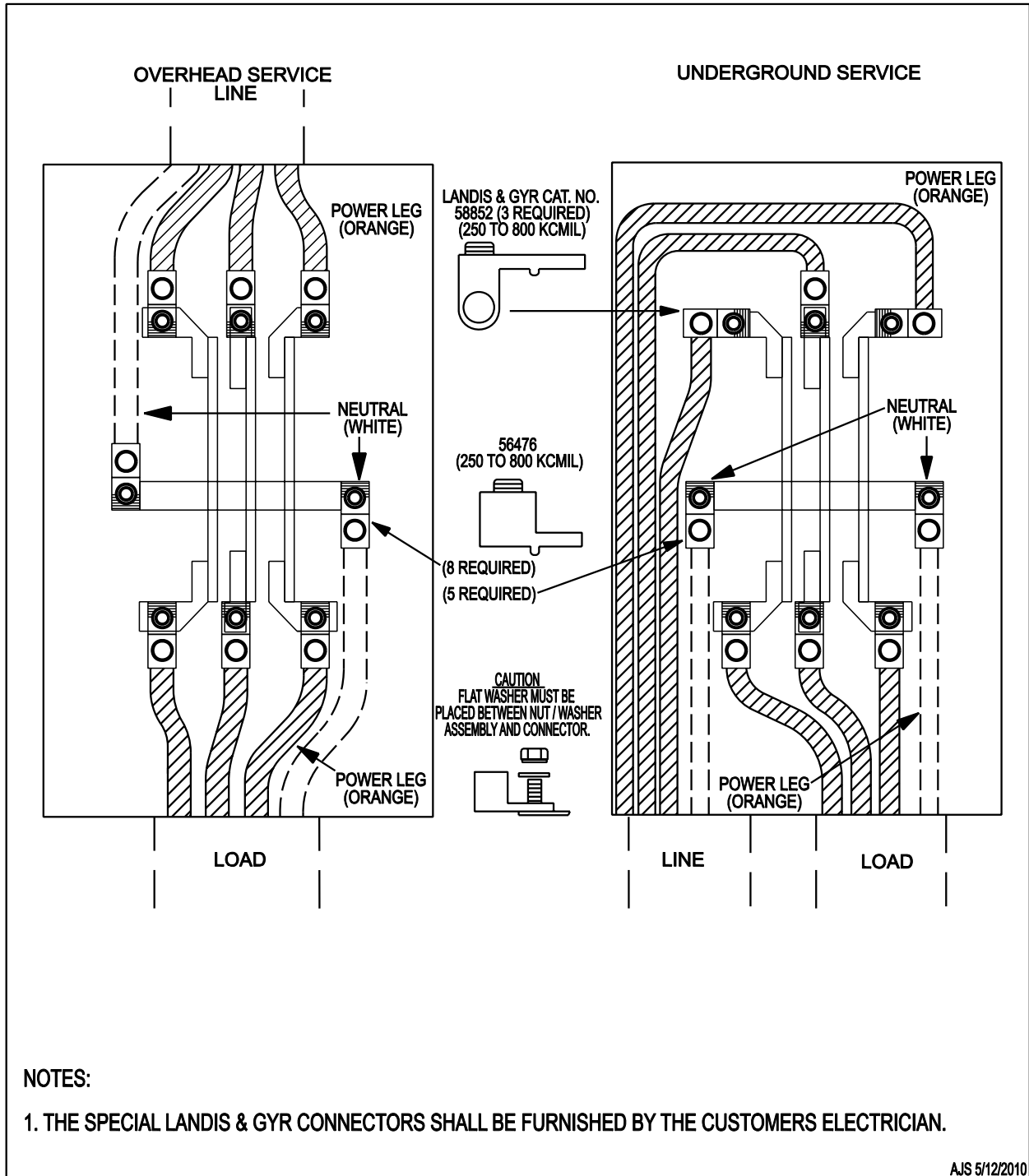

Applies to:



THREE PHASE, 4 WIRE DELTA 120/240 VOLT METERING WIRING DIAGRAM (400AMP PARALLEL CONDUCTOR)

~ FIGURE #11 ~

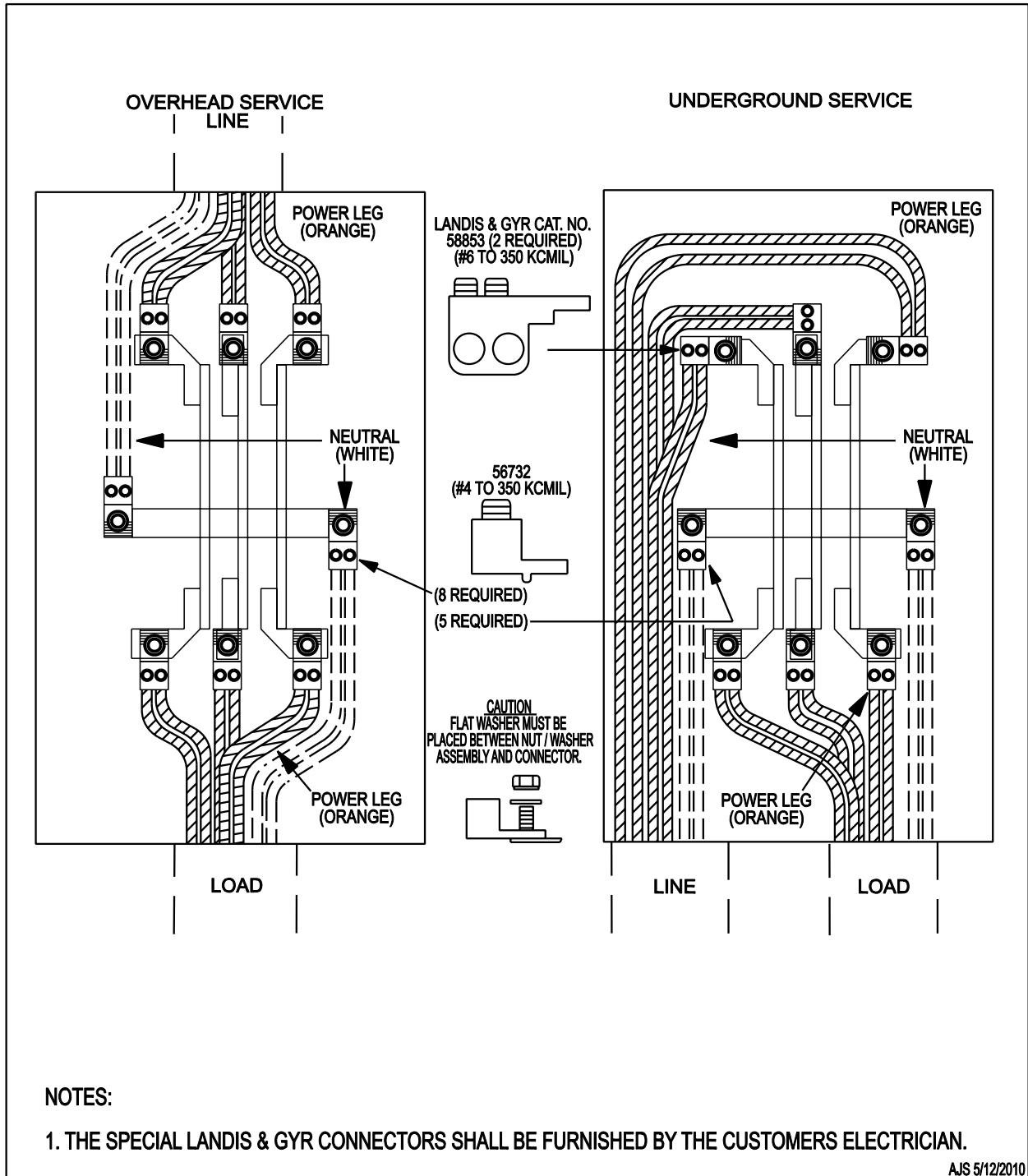

Applies to:



THREE PHASE, 4 WIRE WYE 120/208 AND 277/480 VOLT METERING WIRING DIAGRAM (400AMP SINGLE CONDUCTOR)

~ FIGURE #12 ~

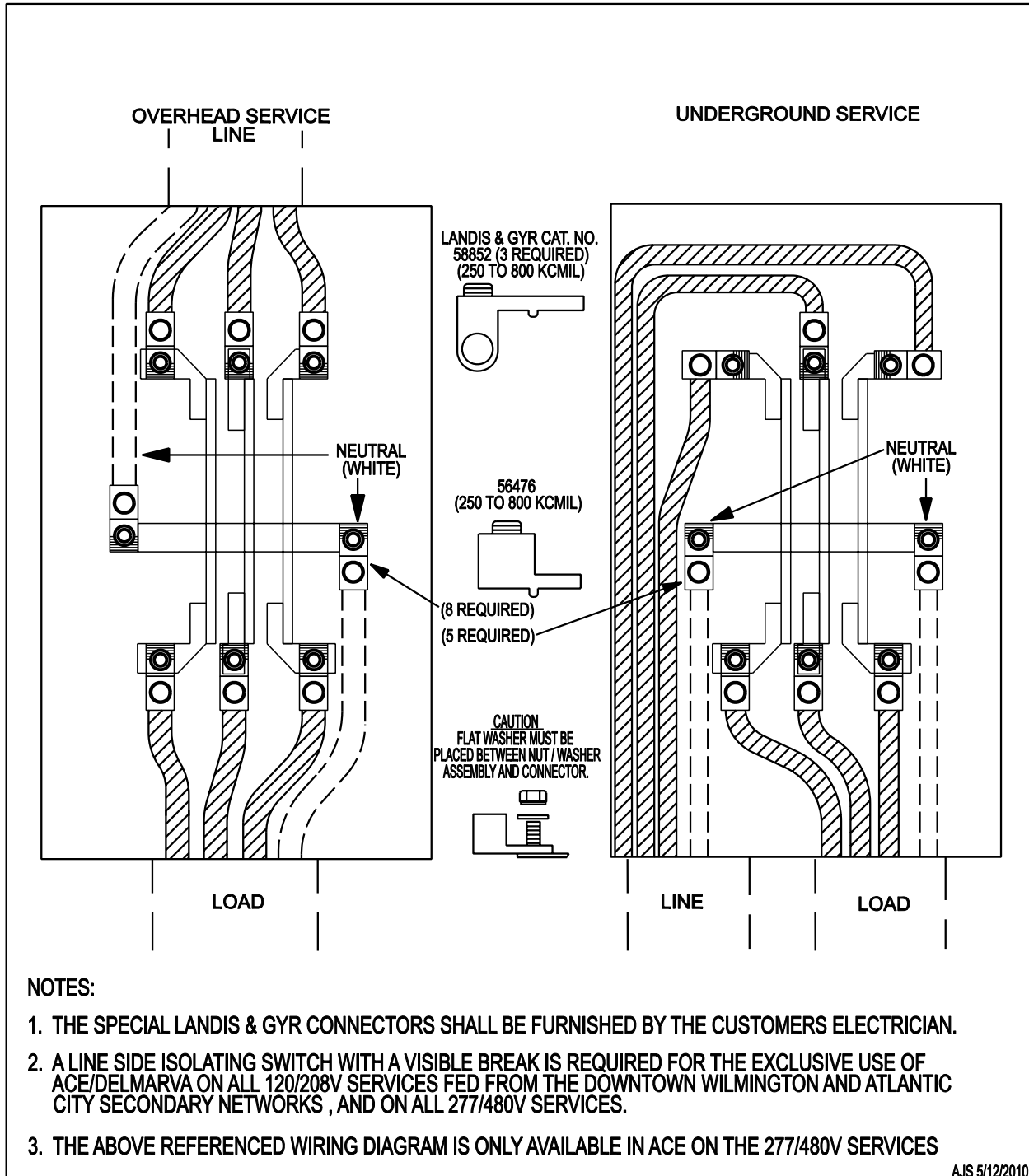

Applies to:



THREE PHASE, 4 WIRE WYE 120/208 AND 277/480 VOLT METERING WIRING DIAGRAM (400AMP PARALLEL CONDUCTOR)

~ FIGURE #13 ~

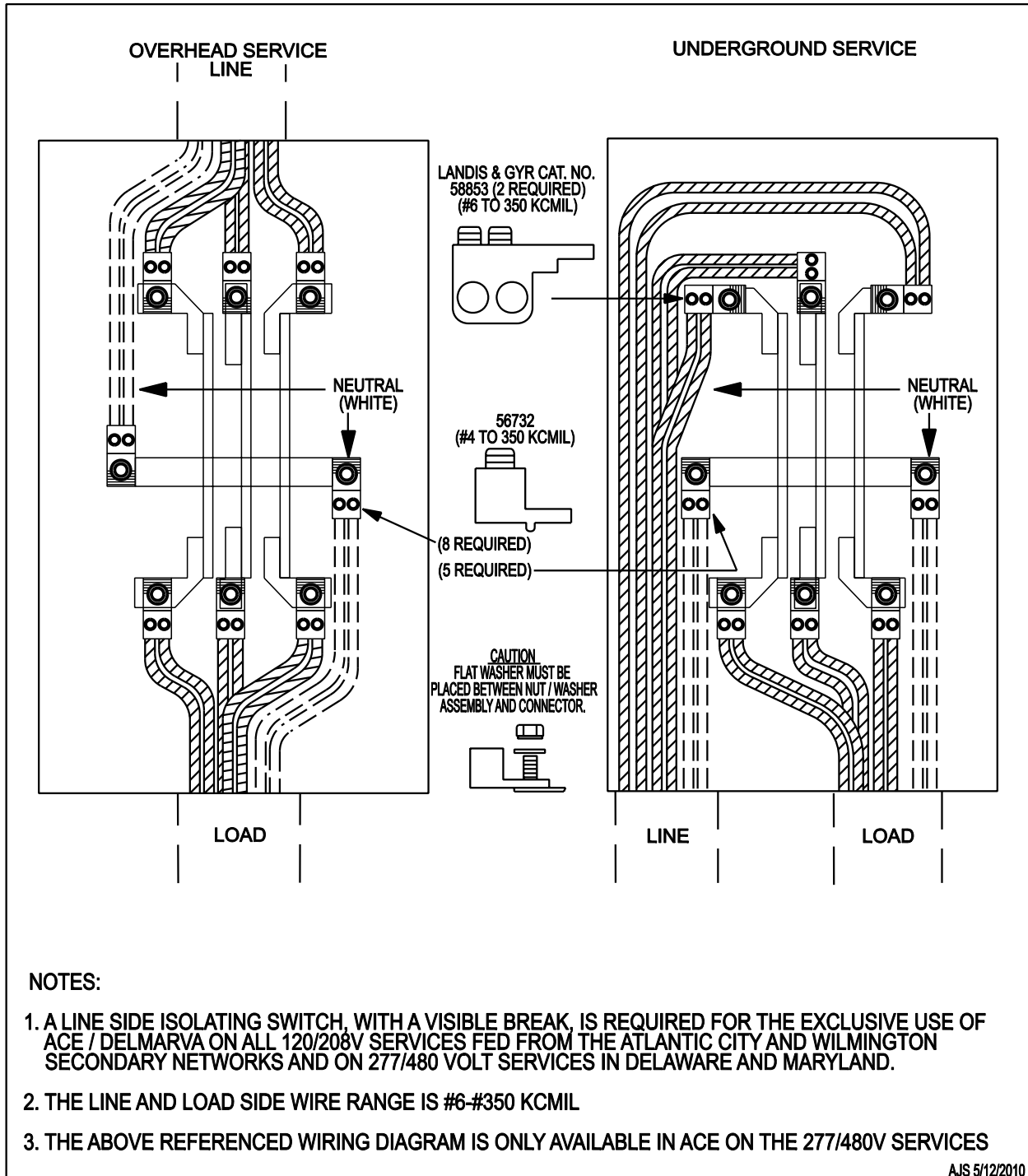

Applies to:



THREE PHASE, 4 WIRE, 120/208 VOLT METER WIRING DIAGRAM (600AMP)

~ FIGURE #14 ~

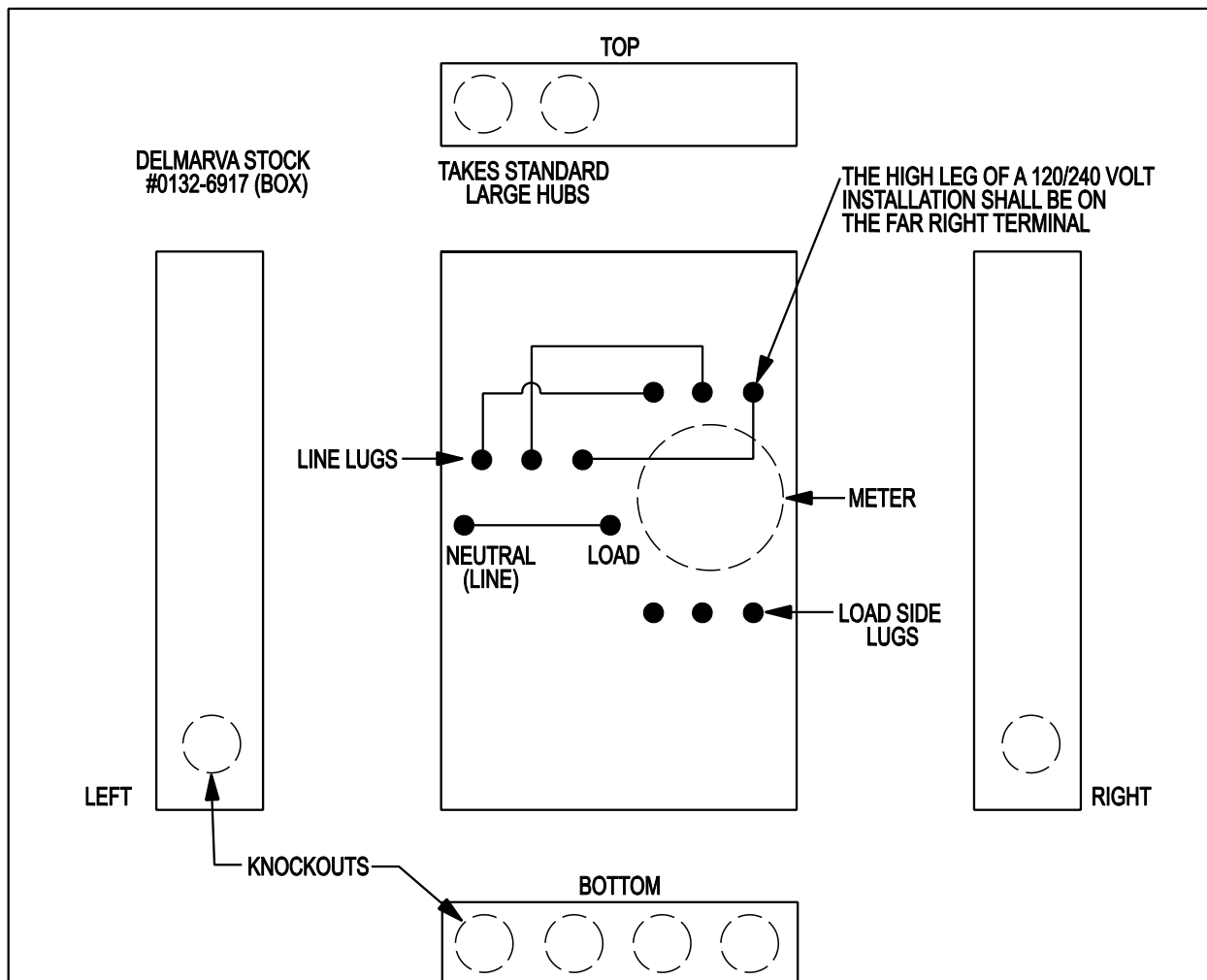

NOTES:

1. THE BOX IS ONLY MANUFACTURED BY LANDIS & GYR.
2. THE BOX AND MATCHING CONNECTORS SHOULD BE PURCHASED FROM AN ELECTRICAL DISTRIBUTOR. THEY WILL BE SOLD BY DELMARVA ONLY IF THERE IS A PROBLEM WITH THE DISTRIBUTORS.
3. THE CONNECTORS SHALL BE EITHER OF TWO APPROVED LANDIS & GYR MODELS:
 - CATALOG #54732M ACCOMODATES UP TO 2-500 KCMIL STANDARD CONDUCTORS AND MAY BE USED ON EITHER THE LINE OR LOAD SIDE. (DELMARVA) STOCK#0132-6925)
 - CATALOG #68752M ACCOMODATES UP TO 3-250 KCMIL STANDARD CONDUCTORS AND MAY ONLY BE USED ON THE LOAD SIDE. (DELMARVA) STOCK#0132-6933)
4. AT THE DISCRETION OF DELMARVA, THE INSTALLATION OF A 600 AMP METER BOX MAY BE USED FOR LARGER AMPACITIES.
5. THE METER BOX CAN BE USED FOR THREE PHASE 120/208V, 120/240V AND 277/480V. IT WILL NOT BE USED FOR 277/480V UNTIL THE LOAD AND POTENTIAL FOR LOAD GROWTH ARE CONSIDERED. CONTACT YOUR LOCAL ENGINEERING OFFICE TO DETERMINE IF THIS SELF CONTAINED METER BOX WILL MEET DELMARVA REQUIREMENTS.

AJS 5/12/2010

Applies to:



An Exelon Company

SINGLE PHASE, 3 WIRE, 120/240 VOLT METER WIRING DIAGRAM (200AMP)

~ FIGURE #15 ~

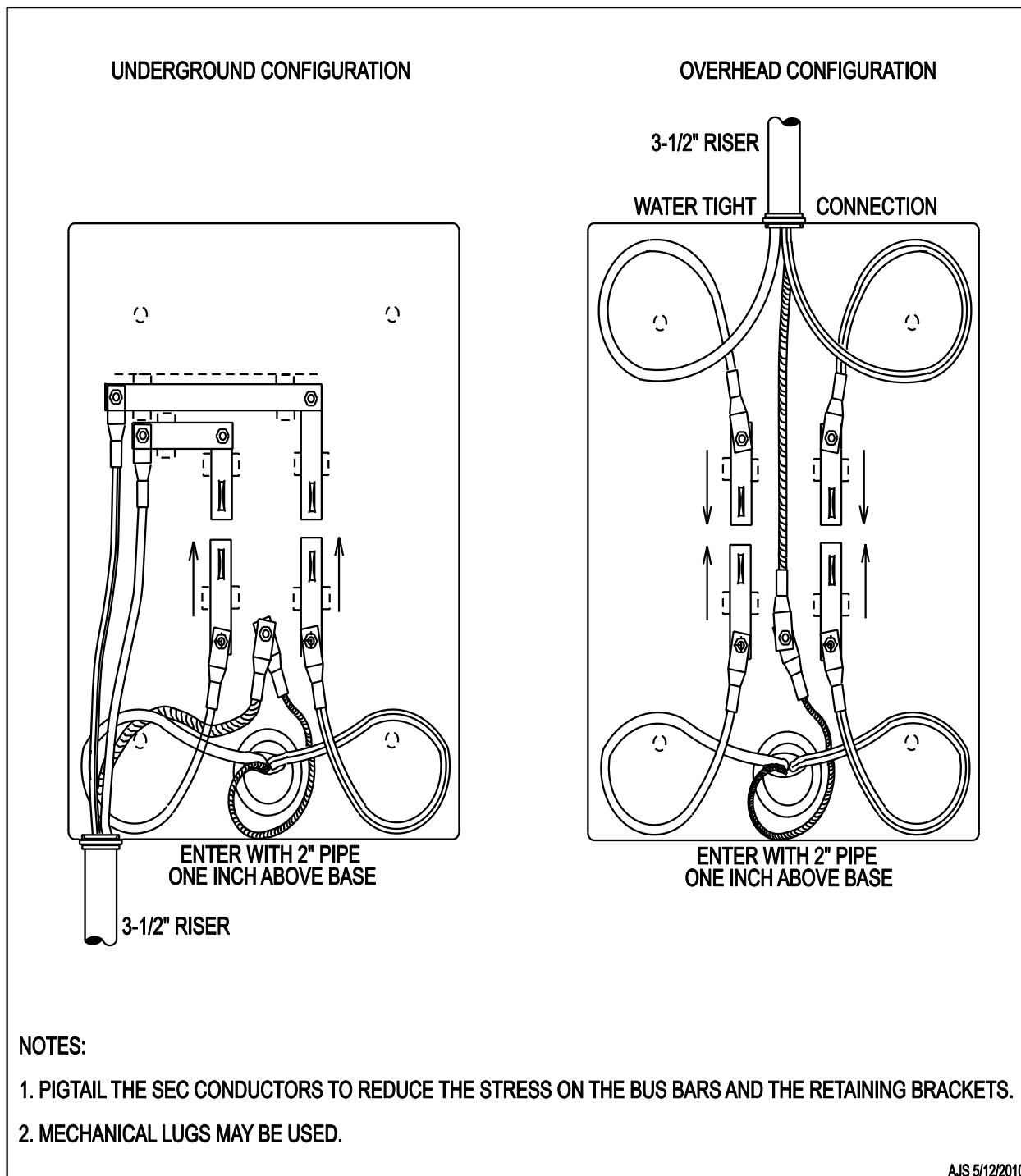

Applies to:



SINGLE PHASE, 3 WIRE , 120/240 VOLT METER WIRING DIAGRAM (320AMP)

~ FIGURE #16 ~

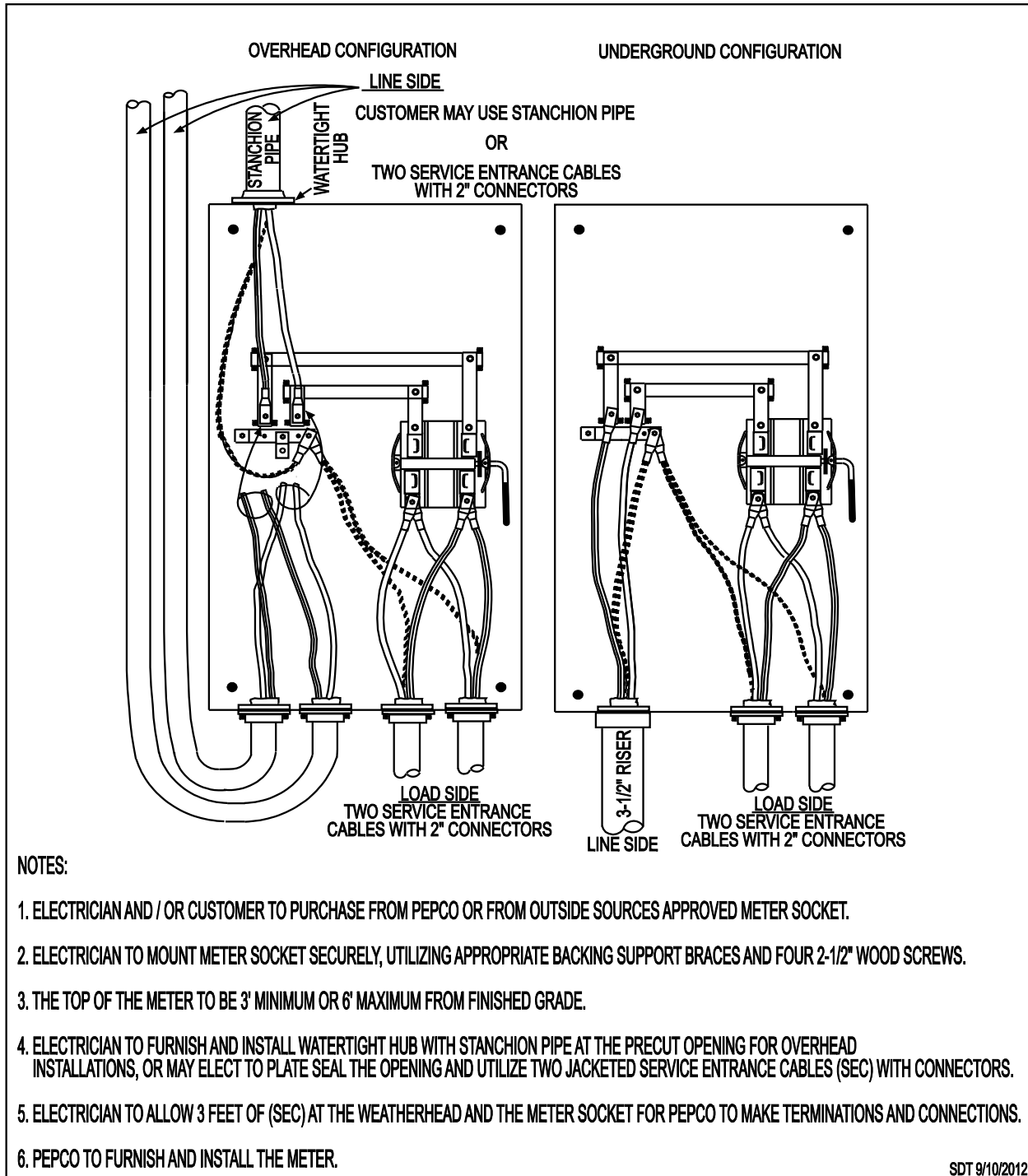

SDT 9/10/2012

Applies to:



THREE PHASE, 4 WIRE, 120/208 VOLT METER DIAGRAM (400AMP)

~ FIGURE #17 ~

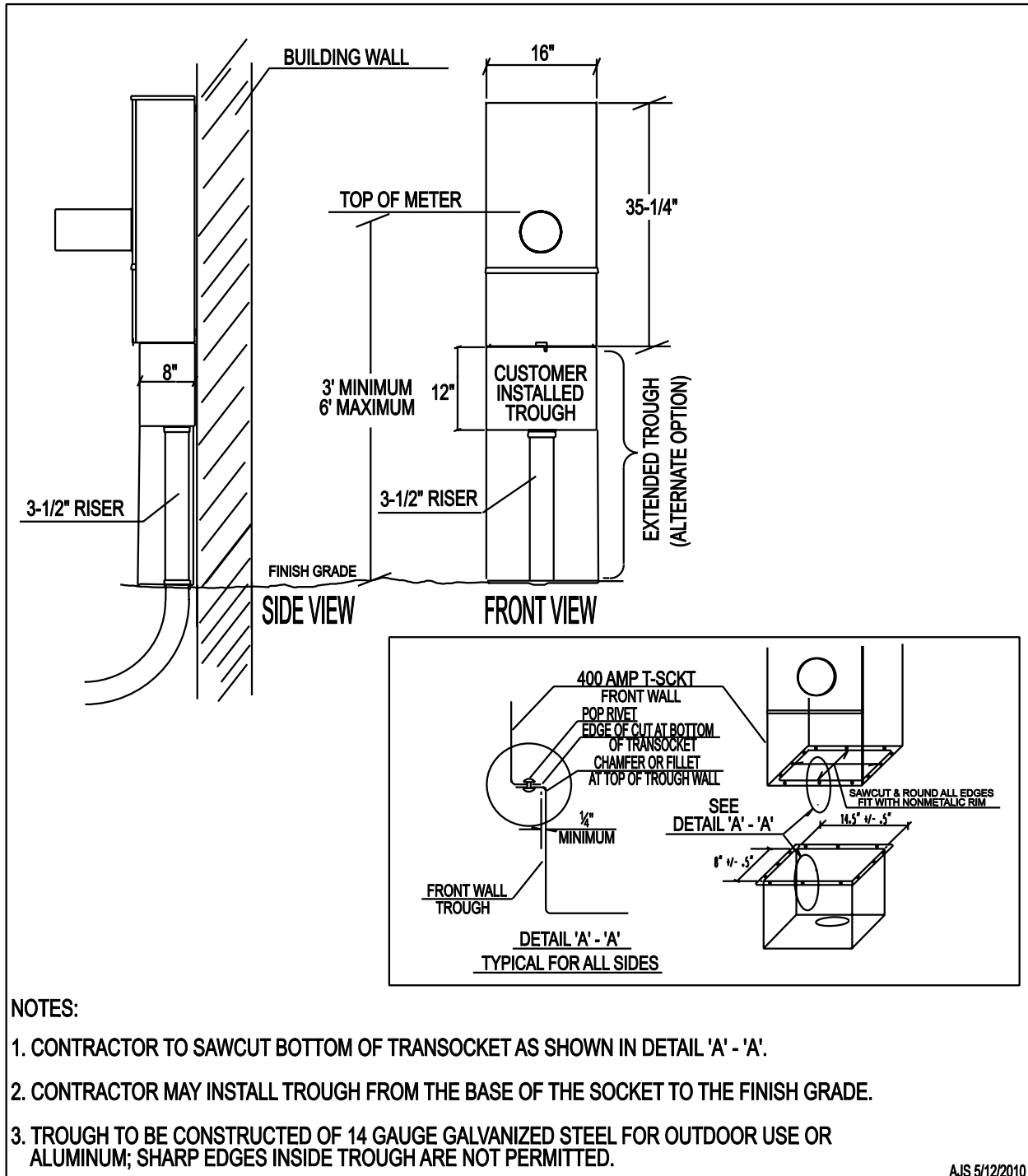

Applies to:



THREE PHASE, 4 WIRE, 265/460 VOLT METER DIAGRAM (200AMP)

~ FIGURE #18 ~

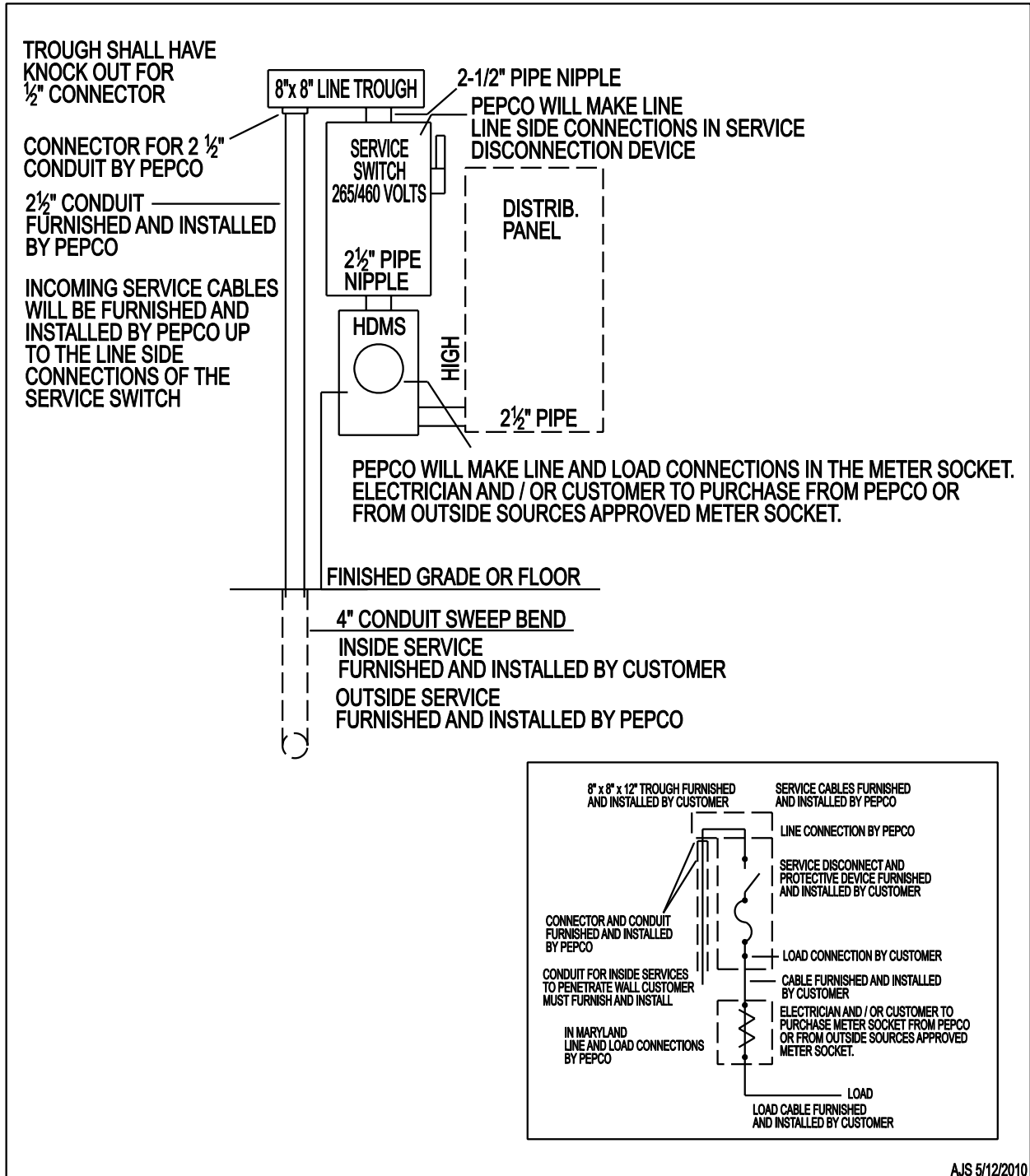

AJS 5/12/2010

Applies to:



An Exelon Company

SINGLE PHASE, 3 WIRE, 120/240 VOLT 800 AMP C.T. / BINET PREFERRED OUTSIDE INSTALLATION

~ FIGURE #19 ~

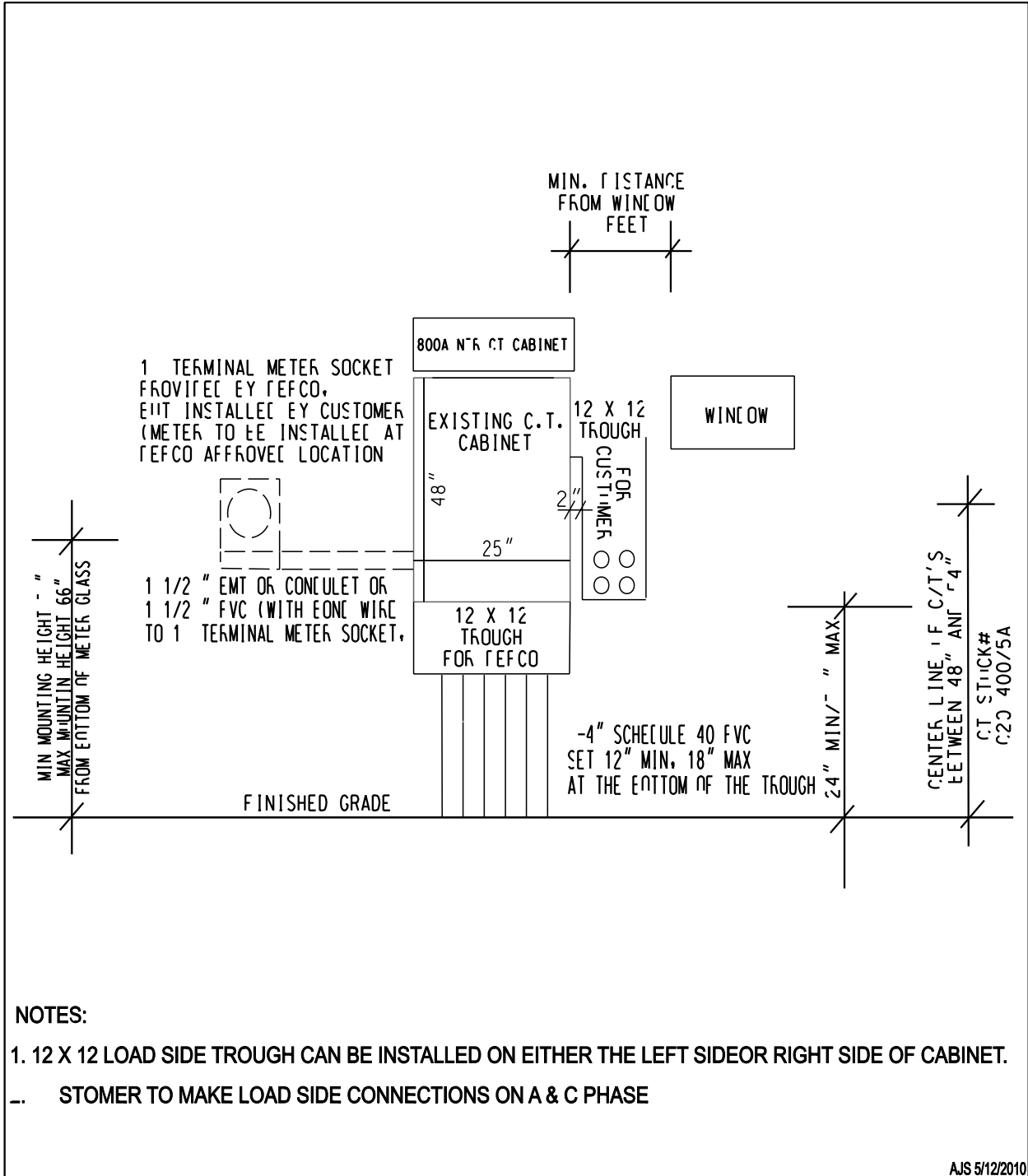

Applies to:



An Exelon Company

METER INSTALLATION FOR NEW CONSTRUCTION 400 AMP MAXIMUM

~ FIGURE #20 ~

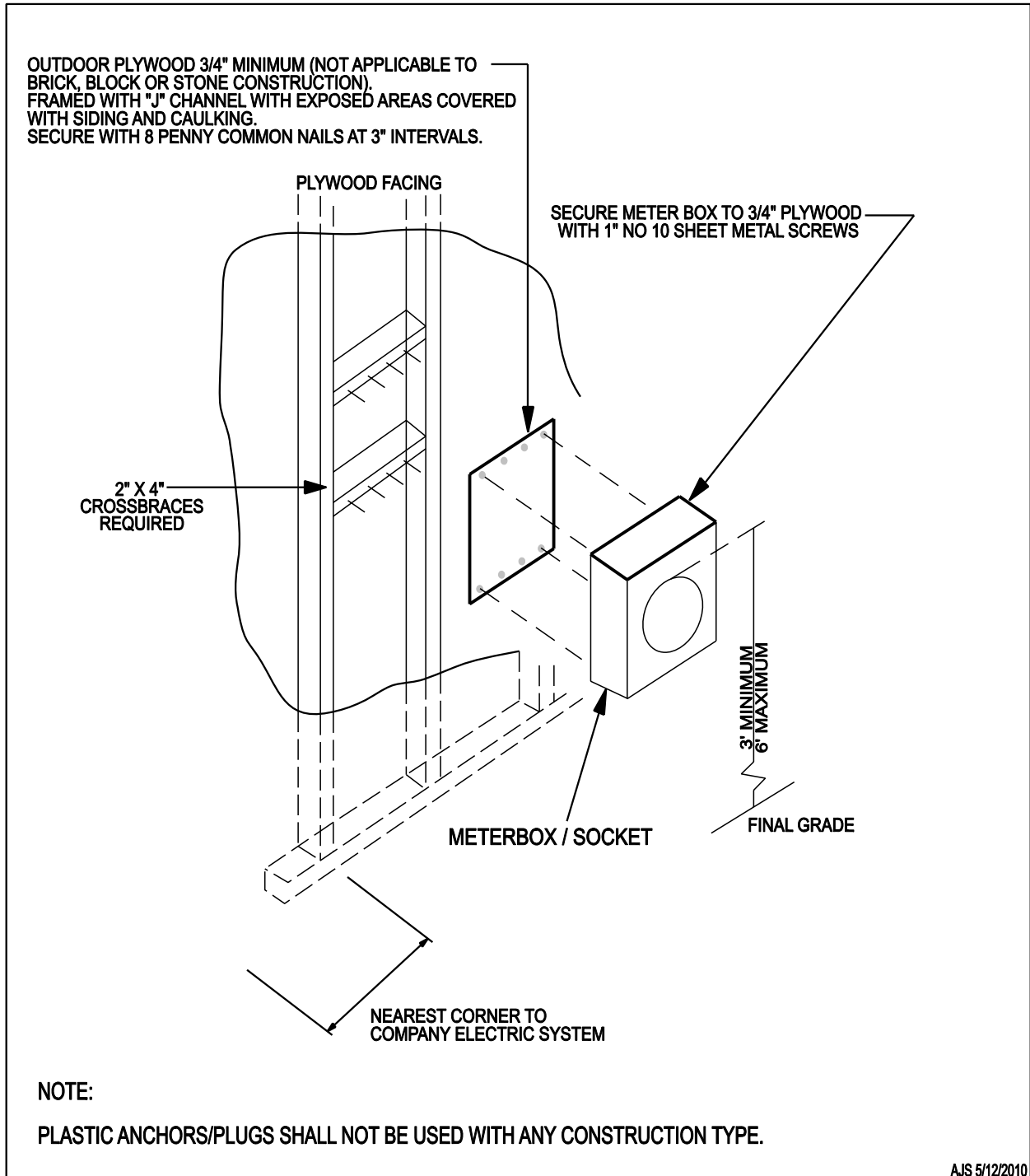

Applies to:



An Exelon Company



An Exelon Company



An Exelon Company

TEMPORARY SERVICE - OVERHEAD (ACROSS PUBLIC ROAD)
 ~ FIGURE #21 ~

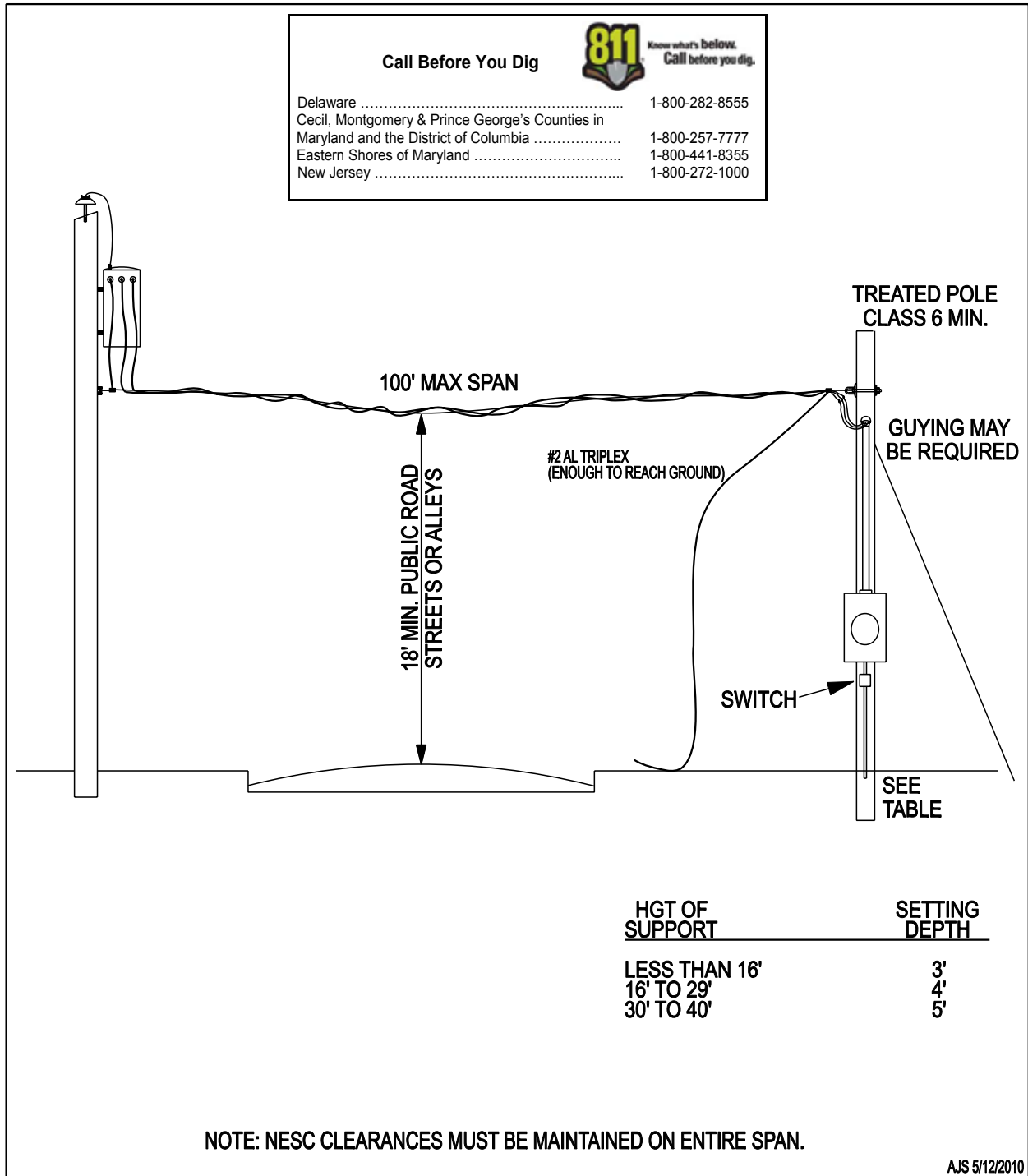

Applies to:



TEMPORARY SERVICE - OVERHEAD (ACROSS PRIVATE DRIVE)
 ~ FIGURE #22 ~

Call Before You Dig



Delaware	1-800-282-8555
Cecil, Montgomery & Prince George's Counties in Maryland and the District of Columbia	1-800-257-7777
Eastern Shores of Maryland	1-800-441-8355
New Jersey	1-800-272-1000

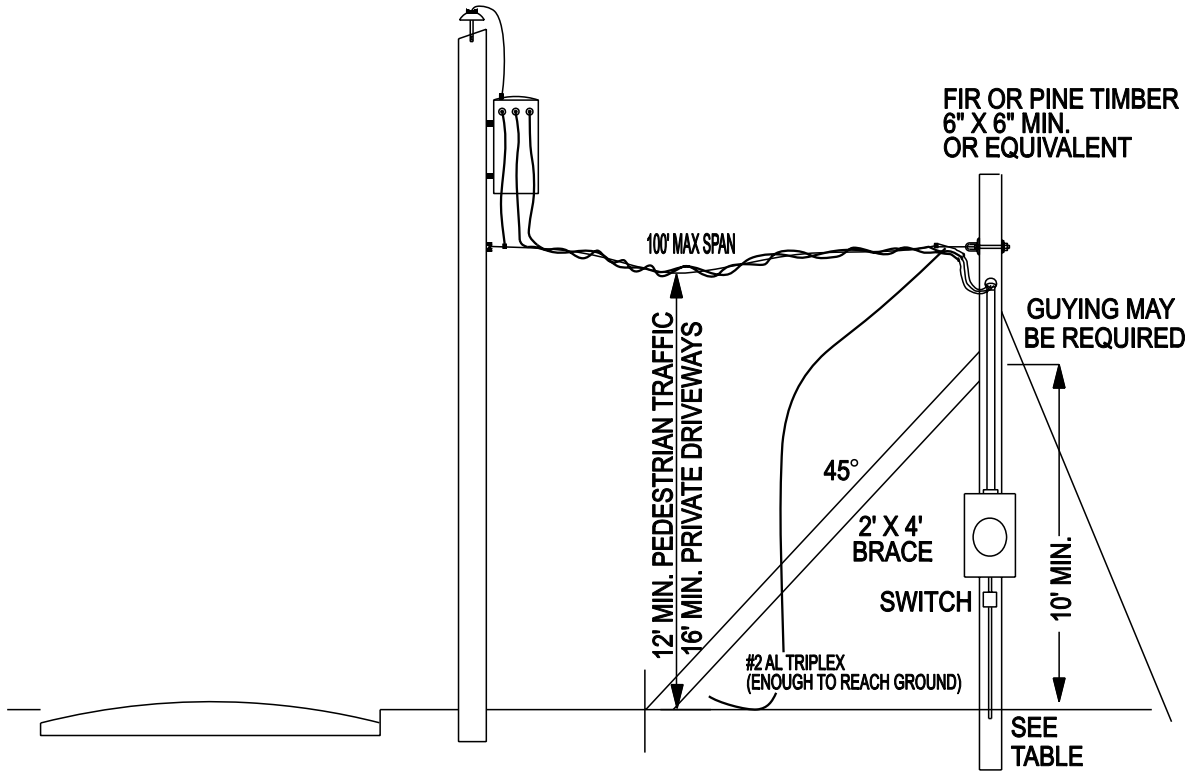

HGT OF SUPPORT	SETTING DEPTH
LESS THAN 16'	3'
16' TO 29'	4'
30' TO 40'	5'

NOTES:

1. NESC CLEARANCES MUST BE MAINTAINED ON ENTIRE SPAN.
2. CLEARANCES CAN BE REDUCED BASED ON NESC STANDARDS.

AJS 5/12/2010

Applies to:



An Exelon Company



An Exelon Company



An Exelon Company

TEMPORARY SERVICE - UNDERGROUND

~ FIGURE #23 ~

Call Before You Dig

Know what's below.
Call before you dig.

Delaware	1-800-282-8555
Cecil, Montgomery & Prince George's Counties in Maryland and the District of Columbia	1-800-257-7777
Eastern Shores of Maryland	1-800-441-8355
New Jersey	1-800-272-1000

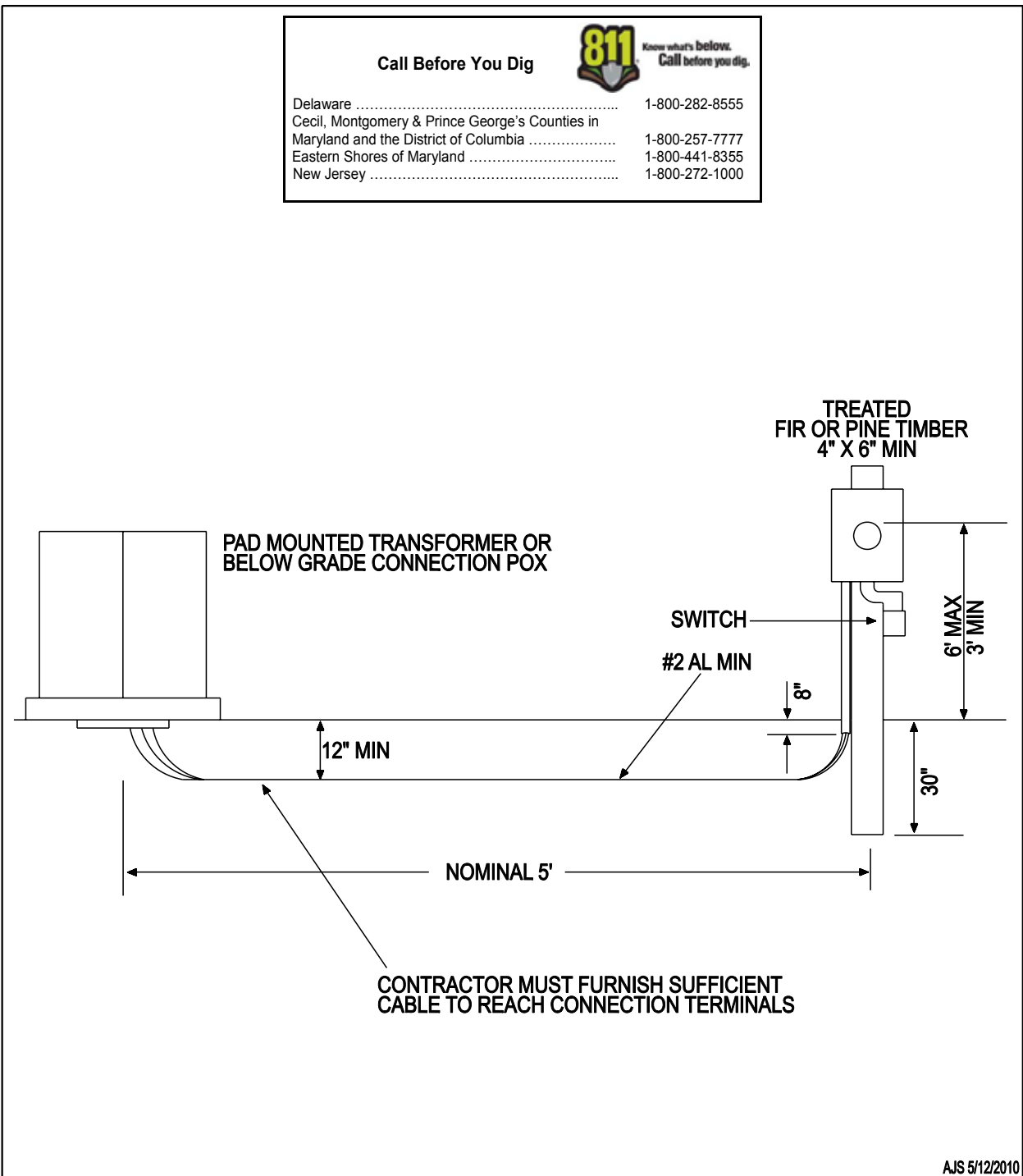

AJS 5/12/2010

Applies to:



An Exelon Company



An Exelon Company



An Exelon Company

OVERHEAD SECONDARY SERVICE
~ FIGURE #24 ~

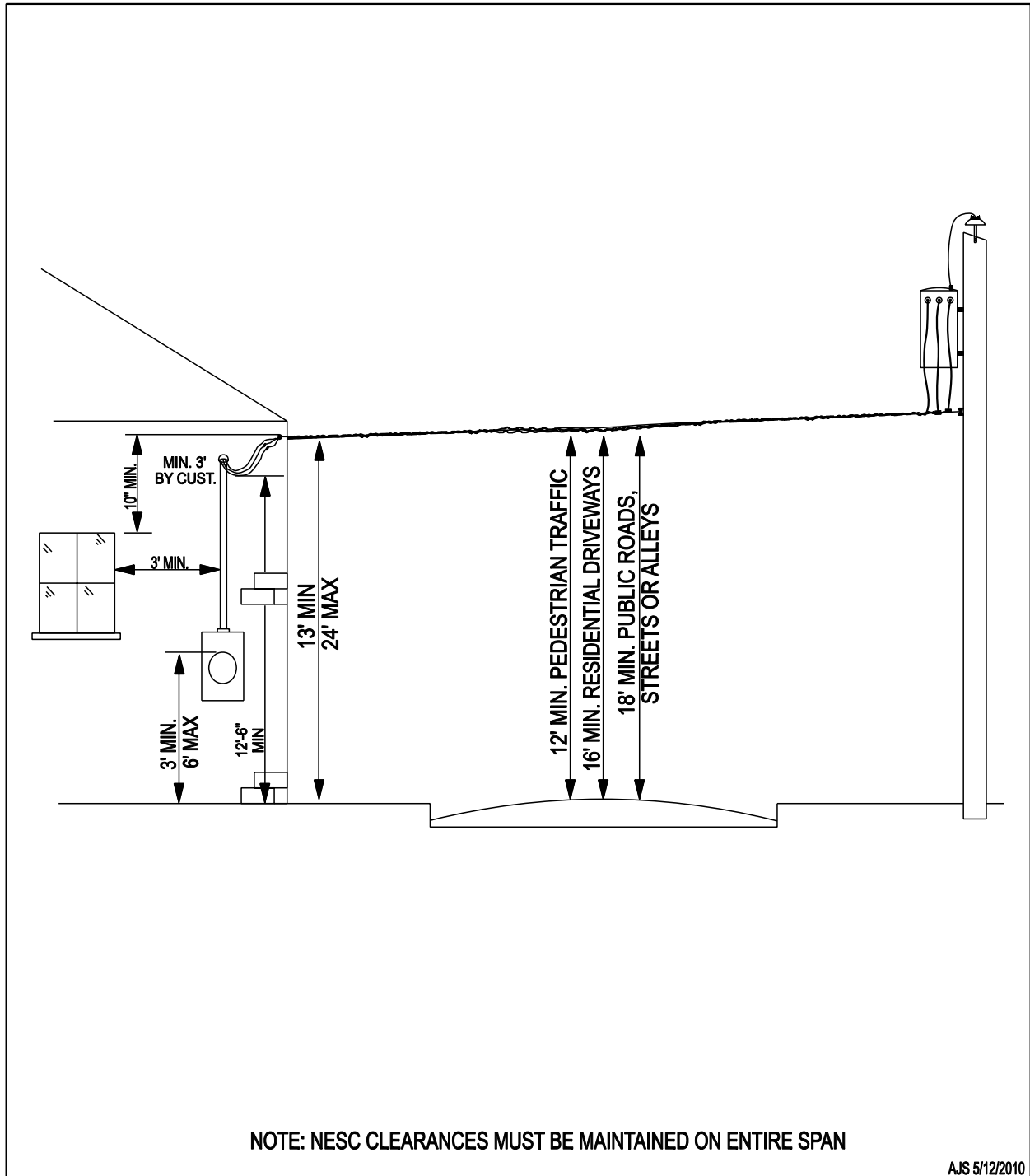

Applies to:



An Exelon Company



An Exelon Company



An Exelon Company

SERVICE MAST
~ FIGURE #25 ~

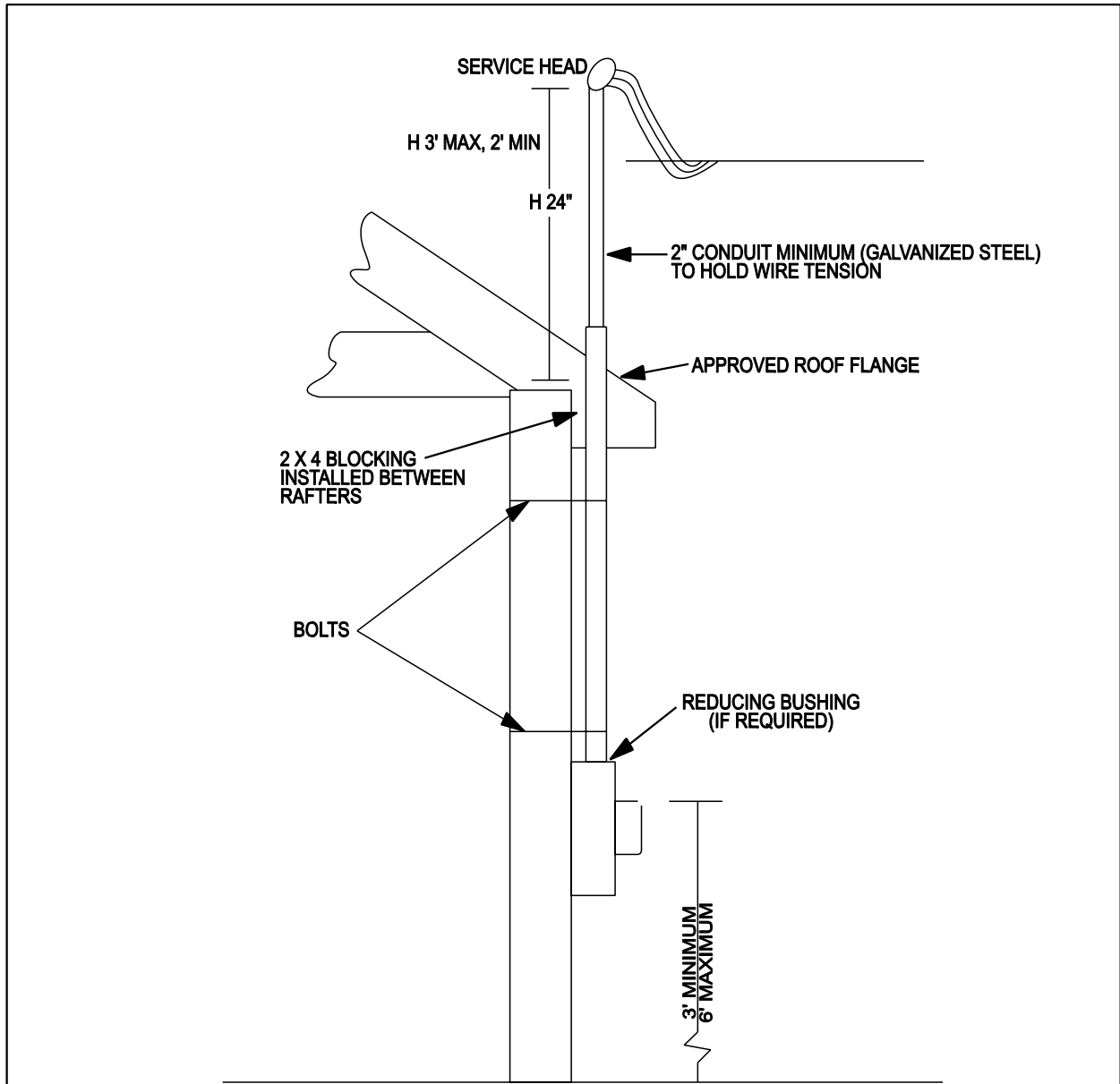

NOTES:

- 1. SEE FIGURE #24 FOR MINIMUM CLEARANCE REQUIREMENTS
- 2. IF PIPE HEIGHT EXCEEDS 3 F.T., IT MUST BE GUYED TO THE ROOF RAFTERS OR OTHERWISE REINFORCED. CONSULT COMPANY IF YOU HAVE ANY QUESTIONS.

AJS 5/12/2010

Applies to:



An Exelon Company



An Exelon Company



An Exelon Company

UNDERGROUND SERVICE PEDESTAL

~ FIGURE #26 ~

Call Before You Dig



Delaware	1-800-282-8555
Cecil, Montgomery & Prince George's Counties in Maryland and the District of Columbia	1-800-257-7777
Eastern Shores of Maryland	1-800-441-8355
New Jersey	1-800-272-1000

RING TYPE SEALING ACE/DPL
RINGLESS TYPE SEALING PEPCO

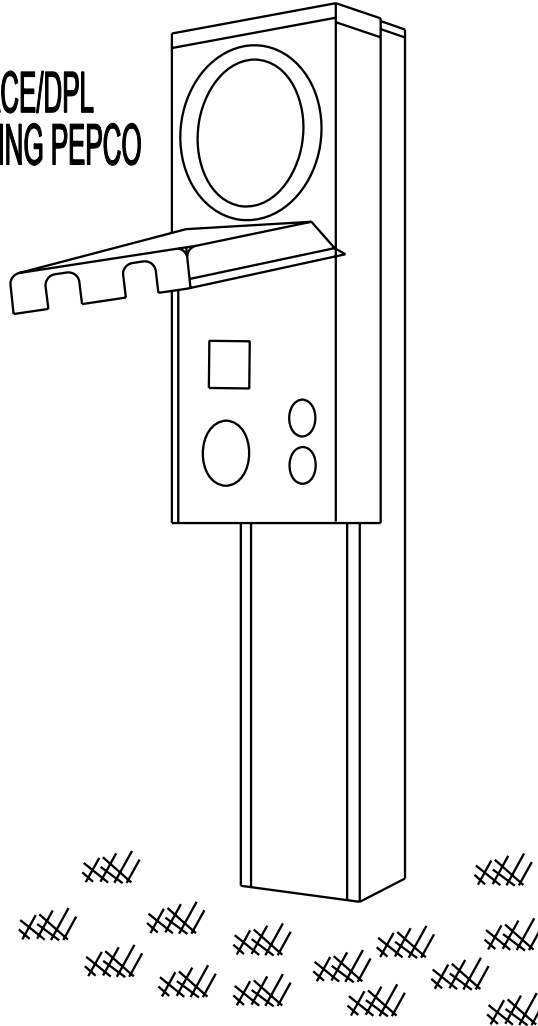

NOTES:

- . NIT MUST BE UL APPROVED.
- .. INSTALLATION SHALL BE PER MANUFACTURE RECOMMENDATION.

I JS 5/12/2010

Applies to:



An Exelon Company



An Exelon Company



An Exelon Company

UNISTRUT METERING EQUIPMENT

~ FIGURE #27 ~

Call Before You Dig



Delaware	1-800-282-8555
Cecil, Montgomery & Prince George's Counties in Maryland and the District of Columbia	1-800-257-7777
Eastern Shores of Maryland	1-800-441-8355
New Jersey	1-800-272-1000

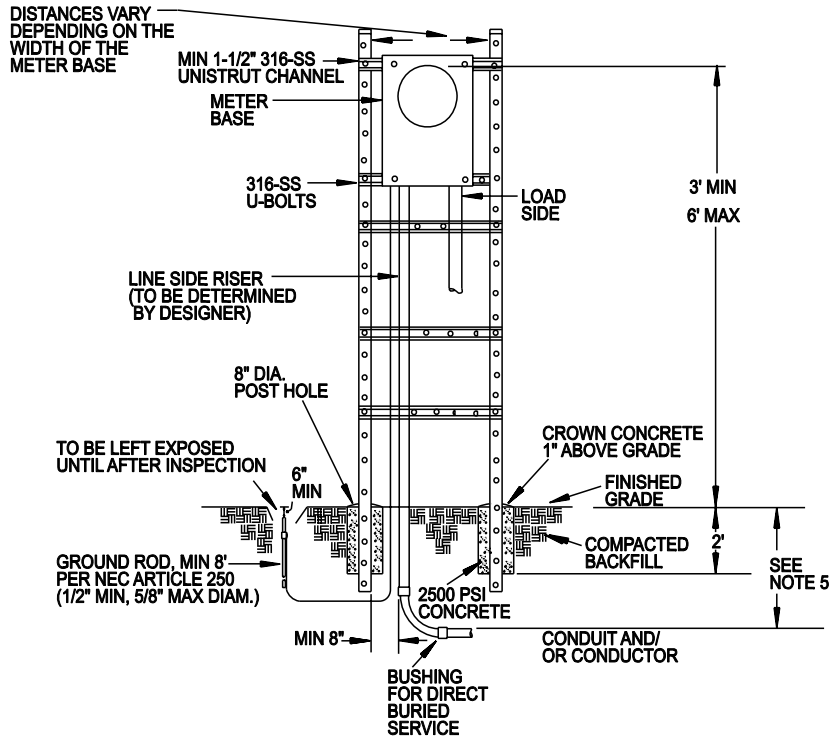

NOTES:

1. BURY UNISTRUT IN GROUND MIN 2 FEET IF ENCASED IN CONCRETE.
2. UNISTRUT REQUIREMENTS:
 - A. UNISTRUT - PER ASTM SPEC-A-123 OR A-153, 1-5/8 X 1-5/8", 12GA, 9/16" DIA. HOLES SPACED 1-7/8" APART
 - B. TO CONNECT THE UNISTRUT FRAMING USE:
 - 3/8 X 1-1/4" ELECTROGALVANIZED, PER ASTM A164
 - NUT W/ SPRING FOR 3/8 DIA. BOLT, ELECTROGALVANIZED PER ASTM A164
 - FLAT WASHER - 1" DIA. FOR 3/8" BOLT, ELECTROGALVANIZED, PER ASTM A164
 - LOCK WASHER- FOR 3/8" DIA. BOLT, HOT-DIPPED GALVANIZED, PER ASTM A153
 - C. TO ATTACH CABINETS AND BOXES USE:
 - 1/4" X 20 ELECTROGALVANIZED BOLTS, PER ASTM A164
 - NUT W/ SPRING FOR 1/4" DIA. BOLT, ELECTROGALVANIZED, PER ASTM A164
3. METER SOCKET SHOULD BE RATED FOR OUTDOOR USE.
4. CUSTOMER OWNS AND MAINTAINS UNISTRUT STRUCTURE AND METER SOCKET.
5. PEPCO 3 FT
ACE/DPL 2 FT

AJS 5/12/2010

Applies to:



An Exelon Company



An Exelon Company



An Exelon Company

ANCHORING SERVICE ATTACHMENTS TO BUILDINGS

~ FIGURE #28 ~

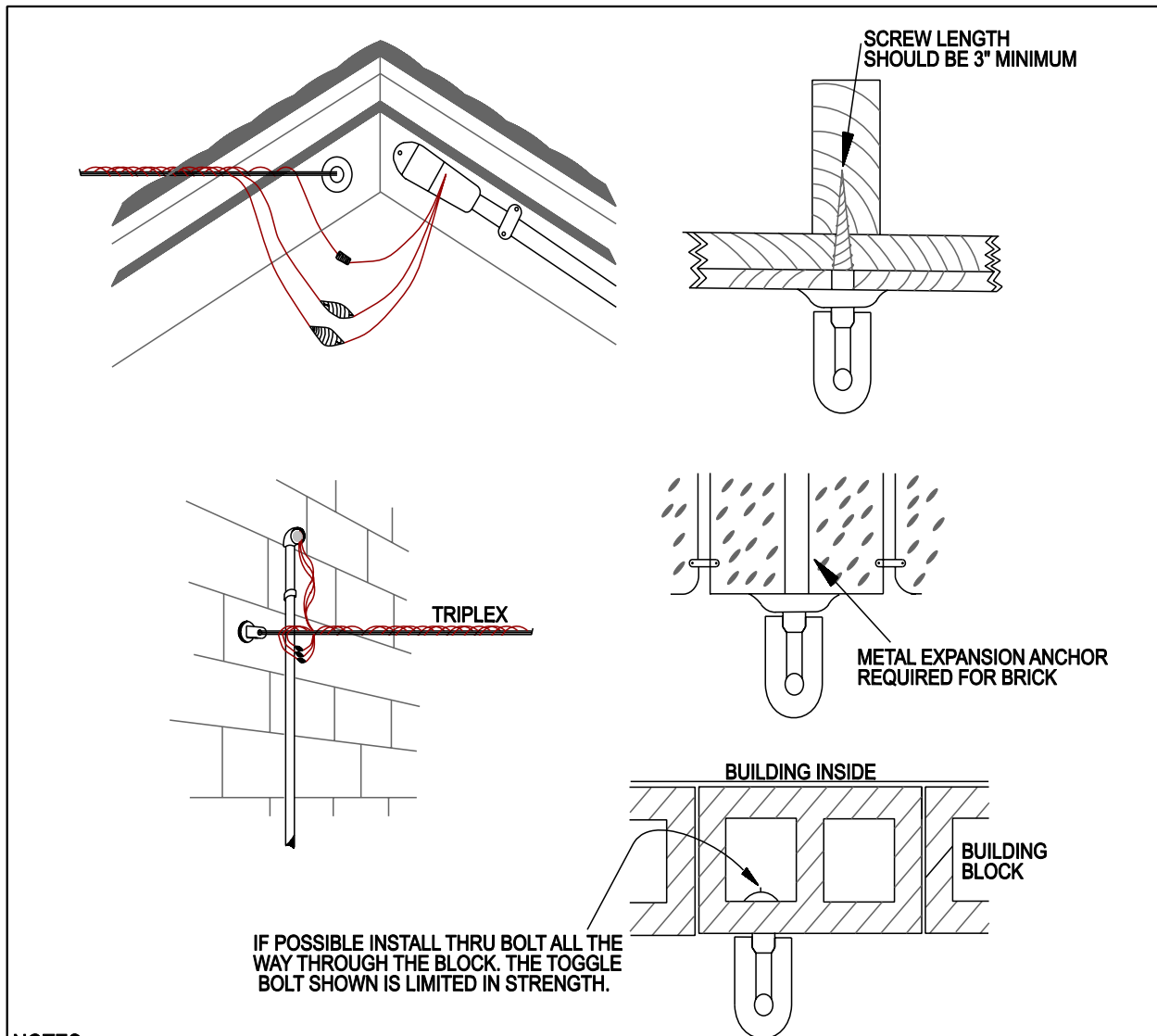

IF POSSIBLE INSTALL THRU BOLT ALL THE WAY THROUGH THE BLOCK. THE TOGGLE BOLT SHOWN IS LIMITED IN STRENGTH.

NOTES:

1. THE BUILDER / ELECTRICIAN ASSUMES RESPONSIBILITY FOR THE INTEGRITY OF THE ANCHORING DEVICE.
2. THE PULL ON A SERVICE CONDUCTOR IS A MAXIMUM OF 350 POUNDS WHEN THE CONDUCTOR IS COVERED WITH A 1/2" COATING OF ICE AND WIND IS BLOWING AT 40 MPH. DEPENDING ON THE WIRE SIZE, SAG AND SPAN LENGTH, CONDUCTOR TENSIONS COULD APPROACH OR EXCEED THE MAXIMUM TENSION.
3. TO LIMIT CONDUCTOR TENSIONS, SUBSTANTIAL SAG MAY BE REQUIRED FOR LONGER SPANS. THE HEIGHT OF THE ATTACHMENT MUST BE SUFFICIENT TO PROVIDE ADEQUATE VERTICAL CLEARANCE AT THE LOWEST SAG OF THE WIRE. SAGS OF SERVICE WIRES MAY APPROACH 6 FEET IN A 100 FOOT SPAN. CONSULT THE COMPANY IF YOU SUSPECT A CLEARANCE PROBLEM MIGHT OCCUR.

AJS 5/12/2010

Applies to:



An Exelon Company



An Exelon Company



An Exelon Company

TROUGH INSTALLATIONS

~ FIGURE #29 ~

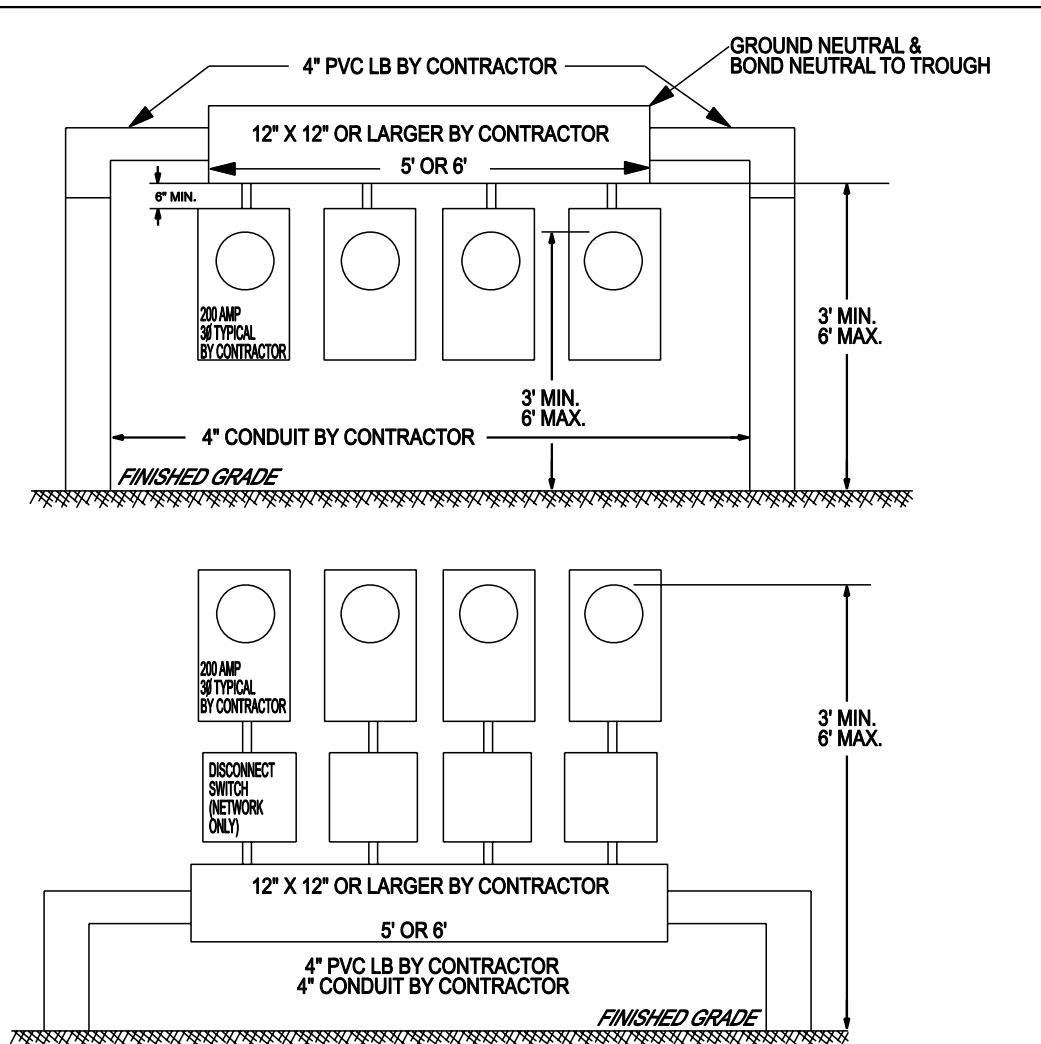

NOTES:

1. FOR 3 OR 4 METERS USE 5' TROUGH; FOR 5 METERS USE 6' TROUGH. METERS MAY BE MOUNTED ABOVE TROUGH, BUT MIN-MAX RESTRICTIONS APPLY.
2. TROUGH, LB'S, METERBOXES AND CONNECTIONS IN TROUGH PURCHASED AND INSTALLED BY THE CUSTOMER.
3. DELMARVA POWER WILL SUPPLY AND INSTALL CONDUCTORS INTO TROUGH IN MARYLAND ONLY. IN DELAWARE, VIRGINIA AND ATLANTIC CITY ELECTRIC TERRITORY (NEW JERSEY), THE CUSTOMER OWNS AND INSTALLS THE CONDUCTORS. IN ALL CASES, THE CUSTOMER OWNS AND INSTALLS THE CONDUITS.
4. ALL THE LINE SIDE CONNECTIONS TO BE MADE IN TROUGH PRIOR TO ENERGIZATION OF FIRST METER.
5. TROUGH TO HAVE EASILY REMOVABLE FRONT PANELS (MAY BE HINGED)
6. TROUGH MUST BE PROVIDE WITH MEANS TO PERMIT LOCKING BY THE COMPANY.
7. TROUGH MAY BE USED FOR 400 AMP OR LARGER SERVICES. (CONSULT DISTRIBUTION ENGINEERING)
8. TROUGH AND ALL FASTENERS MUST BE CORROSION RESISTANT MATERIAL. TROUGH TO BE SECURELY FASTENED TO WALL
9. THIS SPEC APPLIES TO 120/240V AND 120/208V INSTALLATIONS EXCEPT 120/208V INSTALLATIONS ON DOWNTOWN ATLANTIC CITY AND WILMINGTON SECONDARY NETWORKS.

AJS 5/12/2010

Applies to:



An Exelon Company



An Exelon Company



An Exelon Company

CLEAR SPACE REQUIREMENTS FOR TYPICAL PAD MOUNTED EQUIPMENT

~ FIGURE #30 ~

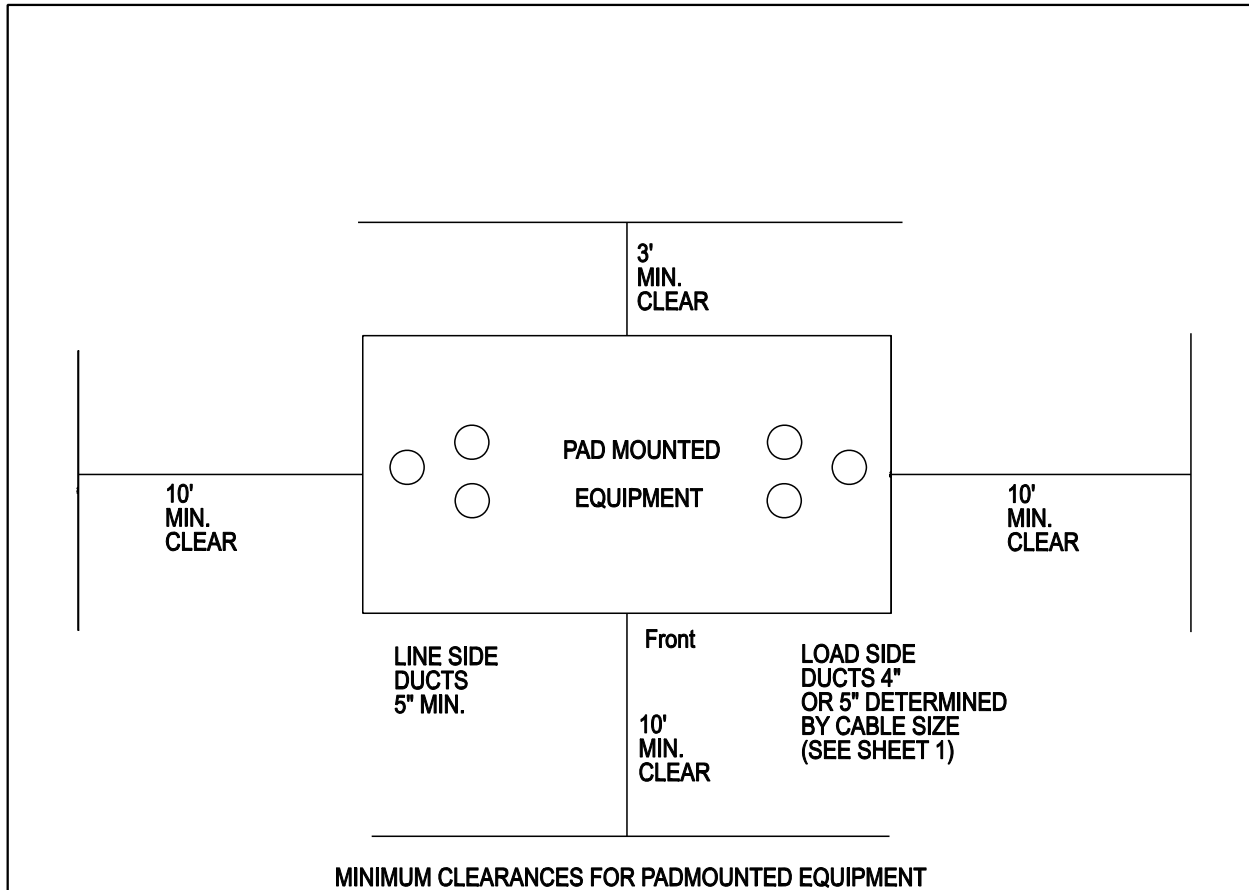

NOTES:

CLEAR SPACE AROUND PAD MOUNTED EQUIPMENT SHALL BE 10'-0" BUT MAY BE REDUCED ON SIDES WHERE NO ACCESS TO THE INTERIOR OF THE EQUIPMENT EXISTS. (I.E. - NO DOORS OR ACCESS PANELS EXIST)

ACCESS NEAR BUILDING DOORS/WINDOWS MAY REQUIRE ADDITIONAL CLEARANCE.

1. CLEAR SPACE ON EITHER SIDE (SIDES DO NOT HAVE DOORS) SHALL BE 3'-0".
2. CLEAR SPACE ALONG THE BACK OF A CUBICLE HAVING NO DOORS SHALL BE 3'-0".
3. CLEAR SPACE IN FRONT OF OR BEHIND CUBICLES HAVING DOORS SHALL BE 10'-0" IF MANUAL OPERATION OF SWITCHES OR LOAD BREAK ELBOWS USING INSULATED SWITCH STICKS IS LIKELY.

AJS 5/12/2010

Applies to:



An Exelon Company



An Exelon Company



An Exelon Company

WARNING STICKERS
FIGURE #31 ~

ATLANTIC CITY WARNING LABEL



PEPCO WARNING LABEL



DELMARVA POWER DELIVERY
WARNING LABEL

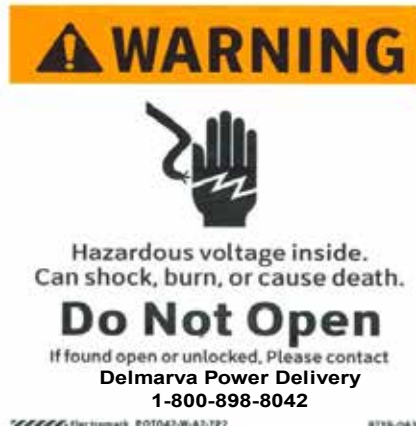

AJS 5/12/2010

Applies to:



An Exelon Company



An Exelon Company



An Exelon Company

