

*A Handbook on*

# Electrical Engineering

*Revised & Updated*

*Contains well illustrated formulae  
& key theory concepts*

*~~~~~ For ~~~~~*

## ESE, GATE, PSUs

& OTHER COMPETITIVE EXAMS



**MADE EASY**  
Publications



## **MADE EASY Publications**

**Corporate Office:** 44-A/4, Kalu Sarai (Near Hauz Khas Metro Station), New Delhi-110016

**Contact:** 011-45124660, 8860378007

**E-mail:** infomep@madeeasy.in

**Visit us at:** [www.madeeasypublications.org](http://www.madeeasypublications.org)

### **A Handbook on Electrical Engineering**

© Copyright, by MADE EASY Publications.

All rights are reserved. No part of this publication may be reproduced, stored in or introduced into a retrieval system, or transmitted in any form or by any means (electronic, mechanical, photo-copying, recording or otherwise), without the prior written permission of the above mentioned publisher of this book.

First Edition: 2012

Second Edition: 2014

Third Edition: 2015

**Fourth Edition: 2019**

## Director's Message



**B. Singh (Ex. IES)**

During the current age of international competition in Science and Technology, the Indian participation through skilled technical professionals have been challenging to the world. Constant efforts and desire to achieve top positions are still required.

I feel every candidate has ability to succeed but competitive environment and quality guidance is required to achieve high level goals. At MADE EASY, we help you to discover your hidden talent and success quotient to achieve your ultimate goals. In my opinion CSE, ESE, GATE & PSUs exams are tool to enter in to main stream of Nation serving. The real application of knowledge and talent starts, after you enter in to the working system. Here in MADE EASY you are also trained to become winner in your life and achieve job satisfaction.

MADE EASY alumni have shared their winning stories of success and expressed their gratitude towards quality guidance of MADE EASY. Our students have not only secured All India First Ranks in ESE, GATE and PSUs entrance examinations but also secured top positions in their career profiles. Now, I invite you to become alumni of MADE EASY to explore and achieve ultimate goal of your life. I promise to provide you quality guidance with competitive environment which is far advanced and ahead than the reach of other institutions. You will get the guidance, support and inspiration that you need to reach the peak of your career.

I have true desire to serve Society and Nation by way of making easy path of the education for the people of India.

After a long experience of teaching in Electrical Engineering over the period of time MADE EASY team realised that there is a need of good *Handbook* which can provide the crux of Electrical Engineering in a concise form to the student to brush up the formulae and important concepts required for ESE, GATE, PSUs and other competitive examinations. This *handbook* contains all the formulae and important theoretical aspects of Electrical Engineering. It provides much needed revision aid and study guidance before examinations.

**B. Singh (Ex. IES)**

CMD, MADE EASY Group

# C O N T E N T S

## A Handbook on Electrical Engineering

### Chapter 1 :

#### **Power Systems ..... 1-52**

I. Supply System.....	1
II. Line Parameters .....	4
III. Performance of Transmission Line.....	14
IV. Concept of Corona.....	23
V. Mechanical Design of Overhead Lines....	25
VI. Balanced and Unbalanced Faults .....	27
VII. Power System Stability.....	32
VIII. Power System Transients.....	36
IX. Economic Load Dispatch.....	38
X. Underground cable .....	40
XI. Protective Relays .....	45
XII. Circuit Breakers .....	48
XIII. Generating Power Stations.....	50
XIV. Loads and Load Curves .....	52

### Chapter 2 :

#### **Electrical Machines..... 53-101**

I. Transformers .....	53
II. Electromagnetic System .....	66
III. Basic Concepts in Rotating Electrical Machines .....	68
IV. D.C. Machines .....	70
V. Polyphase Induction Motors .....	78
VI. Polyphase Synchronous Machines .....	89

### Chapter 3 :

#### **Power Electronics..... 102-164**

I. Power Electronics.....	102
II. Thyristor.....	108
III. Diode Circuits and Rectifiers.....	116
IV. Thyristor Commutation Techniques.....	124

V. Phase Controlled Rectifiers.....	129
VI. Choppers.....	144
VII. Inverters.....	150
VIII. AC Voltage Controllers .....	159
IX. Electric Drives.....	162

### Chapter 4 :

#### **Measurements and Instrumentation ..... 165-214**

I. Characteristics of Instruments and Measurement Systems .....	165
II. Circuit Components (Resistors, Inductors, Capacitors).....	171
III. Galvanometers.....	173
IV. Analog Meters .....	175
V. Instrument Transformers.....	183
VI. Measurement of Power and Wattmeters .....	186
VII. Measurement of Resistance .....	191
VIII. A.C. Bridges.....	197
IX. Magnetic Measurements.....	204
X. Electronic Instruments .....	205
XI. Cathode Ray Oscilloscope.....	207
XII. High Frequency Measurements.....	211
XIII. Transducers .....	212

### Chapter 5 :

#### **Network Theory ..... 215-244**

I. Circuit Elements and Signal Waveform.....	215
II. Network Laws and Theorems.....	222
III. Graph Theory .....	227

IV. Laplace Transform Analysis and Circuit Transients .....	230
V. Resonance.....	234
VI. Magnetically Coupled Circuit.....	236
VII. Two Port Network .....	238
VIII. Network Synthesis .....	241
IX. Dual Network.....	244

## Chapter 6 :

### Control Systems ..... 245-282

I. Introduction .....	245
II. Mathematical Modelling .....	246
III. Transfer function .....	253
IV. Time Response Analysis of Control System .....	258
V. Stability in Time-Domain .....	265
VI. Industrial Controller .....	269
VII. Compensator .....	272
VIII. Frequency Response Analysis.....	273
IX. State Space Analysis.....	281

## Chapter 7 :

### Signals and Systems ..... 283-307

I. Introduction to Signals .....	283
II. Linear Time Invariant Systems.....	290
III. Fourier Series.....	292
IV. Fourier Transform.....	296
V. Laplace Transform.....	298
VI. Z -Transform .....	303

## Chapter 8 :

### Analog Electronics..... 308-372

I. Semiconductor Physics .....	308
II. Junction Diode Characteristics.....	317
III. Bipolar Junction Transistors.....	327
IV. Transistor Biasing Circuits.....	333
V. BJT as an Amplifier.....	336
VI. Junction Field Effect Transistors.....	339

VII. Metal Oxide Semiconductor Field Effect Transistor.....	344
VIII. Transistor Hybrid Model .....	347
IX. Feedback Amplifiers.....	350
X. Operational Amplifiers.....	354
XI. Large Signal Amplifiers .....	360
XII. The Signal Generators and Wave Shaping Circuits .....	366

## Chapter 9 :

### Digital Electronics ..... 373-418

I. Number System and Codes .....	373
II. Logic Gates .....	376
III. Boolean Algebra and Reduction Techniques .....	383
IV. Digital Logic Circuits .....	388
V. Sequential Circuits .....	395
VI. Registers .....	400
VII. Counters .....	402
VIII. Digital ICs Family .....	406
IX. DACs and ADCs .....	412

## Chapter 10 :

### Electrical Materials ..... 419-448

I. Dielectric Properties of Insulating Materials .....	419
II. Dielectric Breakdown.....	427
III. Magnetic Properties of Materials.....	430
IV. Conductive Materials .....	436
V. Semiconductor Materials .....	441
VI. Insulating Materials .....	443
VII. Crystal Structure .....	446

## Chapter 11 :

### Electromagnetic Theory..... 449-487

I. Vector Calculus.....	449
II. Coordinate system and Transformation .....	450

III. Electrostatics.....	459
IV. Magnetostatic Field.....	468
V. Maxwell's Equations.....	473
VI. Electromagnetic Wave Propagation....	476
VII. Incidence of EM Wave.....	481
VIII. Transmission Lines.....	484

## Chapter 12 :

### **Microprocessors ..... 488-532**

I. Introduction.....	488
II. Architecture of 8085.....	489
III. Instruction Set and Data Formats.....	496

IV. Interrupts.....	513
V. Interfacing with Microprocessor.....	515
VI. Introduction to 8086.....	518
VII. Microcontroller.....	524

## Chapter 13 :

### **Communication Systems ..... 533-556**

I. Basics.....	533
II. Fourier Series, Energy and Signals.....	535
III. Analog Modulation.....	536
IV. Pulse Modulation.....	545
V. Digital Carrier Modulation.....	550
VI. Random Variables and Noise.....	553



## I Supply System

### Basic Structure of Power System

Electrical energy generated at generating stations by synchronous generator. The generating voltages are generally 11 kV and 33 kV. This voltage is then stepped up by step up transformer upto 132 kV, 220 kV, 400 kV for transmission over long distances. Again this high voltages are brought down to subtransmission level i.e. 66 kV to supply large consumer and further stepped down for primary distribution i.e. 33 kV, 11 kV. For secondary distribution level voltage is brought down to 400 V for 3  $\phi$  and 230 V for 1  $\phi$  for residential and commercial used.

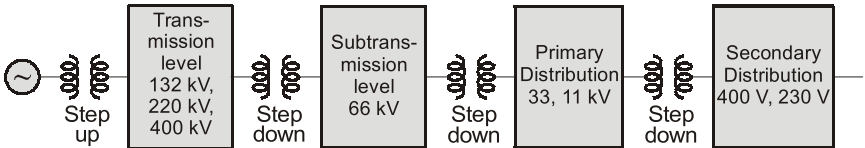

**Note:** .....

- Generating stations are interconnected by the lines.
  - Transmission lines, when interconnected with each other, becomes transmission networks.
  - The combined transmission and distribution network is known as the “power grid”.
- .....

### Effect of System Voltage on Transmission of Power

- Power loss in the line is inversely proportional to the system voltage and power factor both.
- Percentage voltage drop in resistance decreases with the increase in the system voltage.
- Weight of the conductor material for the line will decrease with the increase in supply voltage and power factor.
- Efficiency of transmission, increases with the increase of supply voltage and power factor.
- Higher supply voltages also enhances the system stability.

- The problems encountered with high voltages are the insulation of the equipment, corona, radio and television interference.
- The voltage level of a system is therefore governed by the amount of power to be transmitted and the length of the line.

### Voltage Level

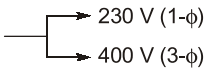
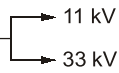
- Low voltage —  230 V (1-φ)  
400 V (3-φ)
- High voltage —  11 kV  
33 kV
- Extra high voltage: 66 kV, 132 kV, 220 kV.
- Modern EHV: 400 kV
- Ultra high voltage: 765 kV and above.

### Conductor Used for Transmission Line

- Copper conductor
- ACSR (Aluminium conductor steel reinforced).
- ACAR (Aluminium conductor alloy reinforced).
- AAAR (All Aluminium alloy reinforced).
- Expanded ACSR conductor: Normally used for EHV lines.

### Types of Conductor

- Solid conductor: It has high skin effect.
- Hollow conductor: Preferred under heavy current i.e. more than 1000 Amp.
- Stranded conductor.
- Composite standard conductor: used for voltage  $\leq 220$  kV.
- Bundle conductor: Used for voltage  $> 275$  kV.

### Advantage of Bundle Conductor

- Self distance (GMR) increased without change in mutual distance.
- Voltage gradient reduced so corona loss reduce.
- It reduces the interference with nearby communication line.
- Inductance ( $L$ ) of transmission line reduces and capacitance ( $C$ ) increases.
- Surge impedance i.e.  $Z_s = \sqrt{\frac{L}{C}}$  decreases.
- Power system stability increases.



### Insulators

Over head line insulators provide the required insulation to the line conductors from each other and from the supporting structures electrically. Most commonly used materials are porcelain and toughened glass.

Where

- where,  $C \rightarrow$  Capacitance between metal part of the insulator and tower structure ;
- $mC \rightarrow$  Capacitance of each insulator disc.
- $mC > C$

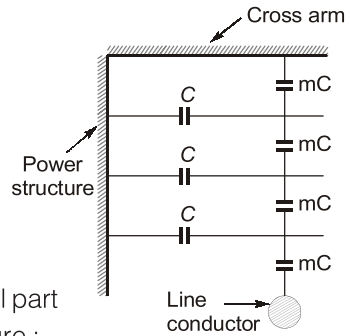

**Note:** .....

- The stress experienced by the disc near the power conductor is more than the stress experience by the disc near the cross-arm.

### String Efficiency

$$\text{String efficiency} = \frac{\text{Voltage across the whole string}}{n \times (\text{Voltage across the unit adjacent to line conductor})}$$

where,  $n \rightarrow$  Number of insulator discs in the string

**Note:** .....

- As the number of disc increases string efficiency decreases.

### Methods of Equilising Potential Across Each Disc

- Increase the length of cross arm.
- Capacitance grading or grading of units.
- Use of grading rings or static shielding.

### Types of Insulator

- **Pin type insulator:** Pin type insulator operate satisfactory upto 25 kV.
- **Multipine type insulator:** Operates upto 33 kV
- **Suspension type insulator:** A suspension insulator is designed to operate at 11 kV.
- **Strain type insulator:** Strain type insulator mechanically strong. It is used when direction of transmission line changes across river crossing and at the dead end of the transmission line.
- **Shackle type:** Shackle type insulator are used in low tension cable. These insulator can be operated either horizontally or vertically.

## II Line Parameters

Transmission line is a carrier on which bulk amount of power from a remote generating station to the operative areas is being carried out.

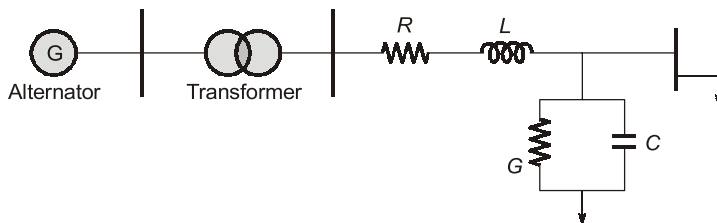

Transmission line is

- series combination of resistance ( $R$ ) and inductance ( $L$ ) and
- Parallel combination of shunt conductance ( $G$ ) and capacitance ( $C$ ).

**Note:** .....

- The line parameter of transmission line is calculated in per unity or per km and are constant for entire line length.
- The shunt conductance is caused by leakage current.
- In transmission line if  $G = 0$  means leakage current is assume to be zero.
- Power loss in the conductor in only due to series resistance.
- Power transmission capacity of the line is mainly governed by the series inductance.

- **Resistance of a conductor,**  $R_{\text{eff}} = \frac{\text{Power loss in conductor}}{I^2}$  ohms

where,  $R_{\text{eff}} \rightarrow$  Effective resistance of the conductor

- **D.C. Resistance of a Conductor,**  $R_{dc} = \rho \frac{l}{A}$  ohms

where,  $\rho \rightarrow$  Resistivity of conductor,  $\Omega\text{-m}$  ;  $l \rightarrow$  Length of conductor, metre ;  $A \rightarrow$  Cross-sectional area,  $\text{m}^2$

**Note:** .....

- The effective resistance is equal to the dc resistance of the conductor only if the current is uniformly distributed through out the cross-sectional area of the conductor (i.e. for DC only).

**Skin Effect**

If DC is passed in a conductor, the current density is uniform over the cross-section of the conductor but when an alternating current flows through a conductor, the distribution tends to become non uniform. There is a tendency of the current to crowd near the surface of the conductor. This phenomenon is called “skin effect”.

**Remember:** .....

- ☑ Skin effect increases with increase in frequency, conductor diameter and permeability.
- .....

**Proximity Effect**

When two or more conductors are in proximity, their electromagnetic field interact with each other, with the result that the current in each of them is redistributed such that the greater current density is concentrated in that part of the strand most remote from the interfering conductor. In each case, a reduced current rating results from the apparent increase of resistance.

**Magnetic Flux Density**

**Biot-savart’s law**

- Magnetic flux at any point produced by a current carrying element

$$d\vec{B} = \frac{\mu}{4\pi} \frac{I d\vec{l} \times (\vec{r})}{r^3}$$

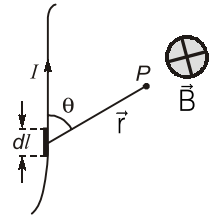

- where,  $dB \rightarrow$  Infinitesimal flux density at point  $P$
- $I \rightarrow$  Current in element ;  $dl \rightarrow$  Length of element
- $\theta \rightarrow$  Angle between current direction and radius vector to  $P$
- $r \rightarrow$  Radius vector ;  $\mu \rightarrow$  Permeability of medium

- Magnetic flux density  $B$  at any point to an infinite conductor.

$$B = \frac{\mu I}{2\pi R}$$

- where,  $R =$  Radial distance of the point from the conductor.

**Note:** .....

The direction of the flux density is normal to the plane containing the conductor and radius vector  $R$ .

.....

**Ampere's law** ,  $\oint H \cdot dl = I_{\text{enclosed}}$

where,  $H \rightarrow$  Magnetic field intensity  
 $I \rightarrow$  R.M.S. value of current enclosed by an amperian loop.

### Relation Between Magnetic Flux Density and Magnetic Field Intensity

$$B = \mu H, \mu = \mu_0 \mu_r$$

where,  $\mu_0 \rightarrow 4\pi \times 10^{-7}$  H/m = Permeability of free space  
 $\mu_r \rightarrow$  Relative permeability of the medium  
 $= 1$  (for non magnetic material)

### Inductance

Inductance of an inductor is the ratio of its total magnetic flux linkages to the current  $I$  through the inductor.

$$L = \frac{N\Psi_m}{I} = \frac{\lambda}{I} \text{ Henry}$$

where,  $\Psi_m \rightarrow$  Magnetic flux linkages through a single turn  
 $N \rightarrow$  Total number of turns ;  $\lambda \rightarrow$  Total magnetic flux linkages

Above formulae is valid for a medium in which the permeability is constant.

#### Remember:

The permeability of ferrous medium is not constant. For such cases the inductance is defined as the ratio of infinitesimal change in flux linkage to the infinitesimal change in current producing it

$$L = \frac{d\lambda}{dI} \text{ Henry}$$

- Flux linkages within the conductor

$$\Psi_{\text{int}} = \frac{\mu I}{8\pi} \text{ Wb-T/m}$$

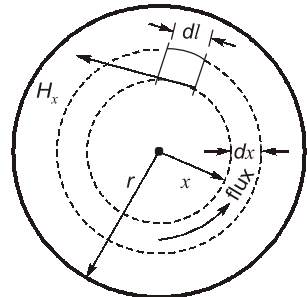

where,  $\Psi_{\text{int}} \rightarrow$  Total internal flux linkages ;  $I \rightarrow$  R.M.S. value of current.

$$\Psi_{\text{int}} = 0.5I \times 10^{-7} \text{ Wb-T/m}$$

- Inductance of the conductor, contributed by flux within the conductor:

$$L_{int} = 0.5 \times 10^{-7} \text{ H/m} \quad \text{as } L_{int} = \frac{\Psi_{int}}{I}$$

- Flux linkages outside the conductor

$$\Psi_{12} = \frac{\mu I}{2\pi} \ln\left(\frac{D_2}{D_1}\right) \text{ Wb-T/m}$$

for  $\mu_r = 1$

$$\Psi_{12} = 2 \times 10^{-7} \ln\left(\frac{D_2}{D_1}\right) \text{ Wb-T/m}$$

where  $\Psi_{12} \rightarrow$  Total flux linkages between points 1 and 2

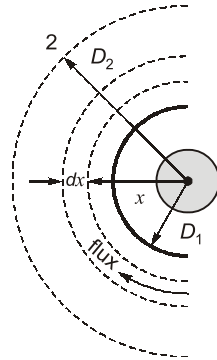

- Inductance of the conductor, contributed by flux between points 1 and 2:

$$L_{12} = 2 \times 10^{-7} \ln\left(\frac{D_2}{D_1}\right) \text{ H/m}$$

- Inductance of a single phase two wire line:  $L = 4 \times 10^{-7} \ln\left(\frac{D}{r'}\right) \text{ H/m}$

where,  $D \rightarrow$  Distance between two solid conductors of same radii  $r$   
 $r' \rightarrow$  Radius of fictitious conductor =  $0.7788r$

- Flux linkages of one conductor in an array:

Figure shows an array of  $n$  long round conductors suspended parallel to each other in space and carrying currents  $I_1, I_2, \dots, I_n$ .

Such that:  $I_1 + I_2 + I_3 + \dots + I_n = 0$

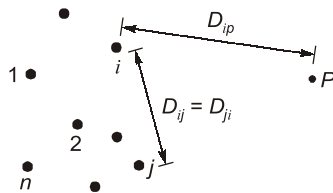

$$\Psi_i = 2 \times 10^{-7} \left[ I_1 \ln \frac{1}{D_{i1}} + I_2 \ln \frac{1}{D_{i2}} + \dots + I_i \ln \frac{1}{D_{ii}} + \dots + I_n \ln \frac{1}{D_{in}} \right] \text{ Wb-T/m}$$

where,  $\Psi_i \rightarrow$  Total flux linkages of conductor  $i$

$D_{ij} \rightarrow$  Centre to centre distance between conductor  $i$  and  $j$

$D_{ii} \rightarrow$  Distance of conductor  $i$  from itself and equals  $0.7788 r_i$

### Inductance of Composite Conductor Lines

Conductor  $M$  consists of  $m$  similar parallel sub-conductors and conductor  $N$  consists of  $n$  similar parallel sub-conductors.

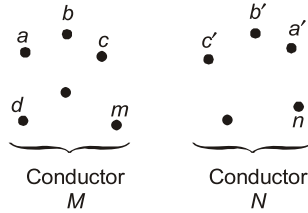

**(Single phase line having composite conductors)**

If line current is  $I$ , then each strand of conductor  $M$  carries a current  $I/m$  and each strand of conductor  $N$  carries a current of  $-I/n$  (the conductor  $N$  being the return conductor).

$$L_M = 2 \times 10^{-7} \times \ln \frac{[(D_{aa'} D_{ab'} \dots D_{an}) (D_{ba'} D_{bb'} \dots D_{bn}) \dots (D_{ma'} D_{mb'} \dots D_{mn})]^{1/mn}}{[(D_{aa} D_{ab} \dots D_{am}) (D_{ba} D_{bb} \dots D_{bm}) \dots (D_{ma} D_{mb} \dots D_{mm})]^{1/m^2}} \text{ H/m}$$

where,  $L_M \rightarrow$  inductance of conductor  $M$

$$L = 2 \times 10^{-7} \ln \left( \frac{\text{GMD}}{\text{GMR}} \right)$$

**Remember:** .....

- $\text{GMD} = mn^{\text{th}}$  root of the product of  $mn$  distances (known as the geometric mean distance between conductor  $M$  and conductor  $N$  and denoted by  $D_m$ ).
  - $\text{GMR} = (m^2)^{\text{th}}$  root of the product of  $m^2$  distances these being the distances from each sub-conductor of conductor  $M$  to every other sub-conductor of conductor  $M$  (including  $D_{aa}, D_{bb} \dots D_{mm}$ ).
  - $\text{GMR} =$  Geometric mean radius (denoted by  $D_s$ ).
  - $D_{aa} = 0.7788$  times the radius of sub-conductor 'a'.
- .....

### Inductance of 3- $\phi$ Line With Equivalent Spacing.

Assuming balanced currents i.e.  $(I_a + I_b + I_c = 0)$

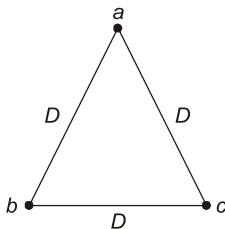

$$L_a = 2 \times 10^{-7} \ln \left( \frac{D}{r} \right) \text{ H/m}$$

- where,
- $L_a \rightarrow$  Inductance of phase
  - $D \rightarrow$  Distance between any two phases
  - $r' \rightarrow 0.7788r =$  Radius of fictitious conductor  
 $\rightarrow 0.7788$  times the radius of conductor
  - $L_a \rightarrow L_b = L_c$  (Because of symmetry)

**Inductance of 3- $\phi$  line with unsymmetrical spacing**

In this case the lines are transposed.

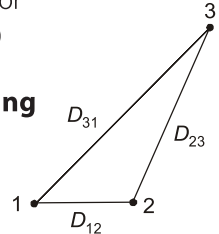

**Transposition of transmission line**

When ever 3 $\phi$  unsymmetrical line running parallel and neighbour to the communication line it cause interference in the communication line. In order to eliminate the communication interference transposition of line is recommended.

Change the position of power conductor at regular interval with equidistance for a given line length, so that the position of power conductor is replaced by its successive phase conductor.

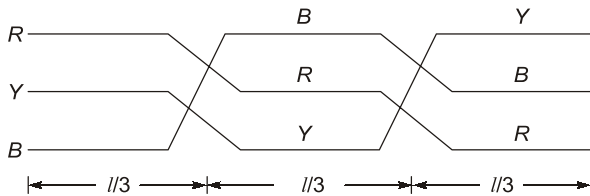

**Advantages of Transposition**

- Net resultant flux  $\phi_r$  which link with communication line become zero.
- GMD/phase equal.
- L/phase equal.
- I/phase equal.
- Flux per phase equal.

**Note:** .....

- Transposition of transmission line is an old technique. The radio interference is eliminated by completely insulating any one of the phases.
- .....

**Inductance of Phase-1**

$$L_1 = 2 \times 10^{-7} \ln \left( \frac{D_{eq}}{r'} \right) \text{ H/m}$$

where,  $L_1 \rightarrow$  inductance of phase 1

$$D_{eq} \rightarrow \sqrt[3]{D_{12}D_{23}D_{31}} = \text{Equivalent spacing}$$

$$= \text{Geometric mean of the distance of the line.}$$

**Inductance of Bundled Conductor Lines**

- For a two conductor (duplex) arrangement

$$D_s^b = \sqrt[4]{(D_s \cdot d)^2} = \sqrt{D_s \cdot d}$$

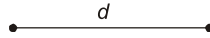

- For a three conductor (triplex) arrangement

$$D_s^b = \sqrt[9]{(D_s \cdot d \cdot d)^3} = \sqrt[3]{D_s \cdot d^2}$$

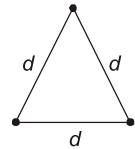

- For a four-conductor (quadruplex) arrangement

$$D_s^b = \sqrt[16]{(D_s \cdot d \cdot d \cdot d \sqrt{2})^4}$$

$$= 1.09 \times \sqrt[4]{D_s \cdot d^3}$$

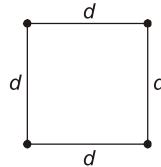

where,  $D_s^b =$  Geometric mean radius of bundled conductor

$D_s =$  Geometric mean radius of each sub-conductor of bundle

$d =$  Spacing between the sub-conductors of a bundle

**Remember:** .....

- ☑ GMD of a bundled conductor line can be found by taking the root of the product of distances from each conductor of a bundle to every other conductor of other bundles.

- ☑ Inductance of bundled conductor line is less than the inductance of the line with one conductor per phase.
- .....

**Inductance of Double Circuit 3-φ Line**

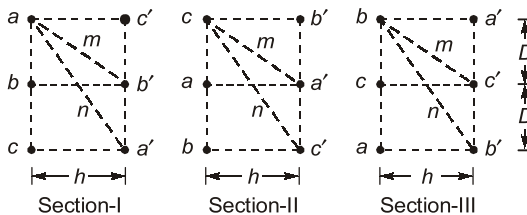

**Inductance per phase per metre length**

$$L = 2 \times 10^{-7} \ln \left[ 2^{1/6} \left( \frac{D}{r'} \right)^{1/6} \cdot \left( \frac{m}{n} \right)^{1/3} \right] \text{ H/phase/m}$$



### Mutual Inductance

Mutual inductance is defined as the flux linkages of one circuit due to the current in the second circuit per-ampere of current in the second circuit. If the current  $I_2$  produces  $\lambda_{12}$  flux linkages with circuit 1. The mutual inductance is

$$M_{12} = \frac{\lambda_{12}}{I_2} \text{ Henry}$$

### Electrical Field and Potential Difference

- The lines of electric flux originate on the positive charges on one conductor and terminate on the negative charges on the other conductor.
- If a long straight cylindrical conductor has a uniform charge throughout its length and is isolated from other charges.
- Electric field intensity  $E$  at any point,  $E = \frac{q}{2\pi \epsilon x}$  V/m  
 where,  $q \rightarrow$  Charge on conductor per unit length  
 $\epsilon \rightarrow$  Permittivity of the medium  
 $x \rightarrow$  Distance from conductor to the point under consideration.

- The potential difference between two points

$$V_{xy} = \frac{q}{2\pi \epsilon} \ln\left(\frac{D_y}{D_x}\right) \text{ Volts}$$

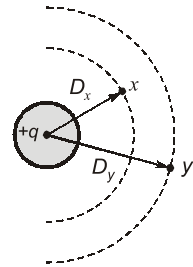

where,  $D_x, D_y \rightarrow$  Distance of point x and y from charge  $q$   
 $q \rightarrow$  Charge per unit length

- The potential difference between two conductor of an array of parallel conductors

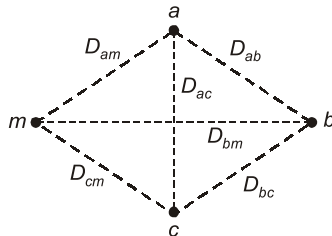

(An array of m charged conductors)

$$V_{ab} = \frac{1}{2\pi \epsilon} \left[ q_a \ln \frac{D_{ab}}{r_a} + q_b \ln \frac{r_b}{D_{ba}} + q_c \ln \frac{D_{cb}}{D_{ca}} + \dots + q_m \ln \frac{D_{mb}}{D_{ma}} \right]$$

## Capacitance

### Capacitance of Two Wire Line

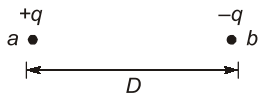
$$C_{ab} = \frac{0.01206}{\log\left(\frac{D}{r}\right)} \mu\text{F/km}$$

where,  $C_{ab} \rightarrow$  Capacitance between the conductors per unit length  
 $q \rightarrow$  Charge per unit length;  $r \rightarrow$  Radius of conductor  $a$  and  $b$

If the conductor have different radii , 
$$C_{ab} = \frac{0.01206}{\log\left(\frac{D}{\sqrt{r_a r_b}}\right)} \mu\text{F/km}$$

where,  $r_a, r_b \rightarrow$  Radius of conductor 'a' and conductor 'b' respectively.  
 $C_{ab} \rightarrow$  Line to line capacitance

### Line to neutral capacitance

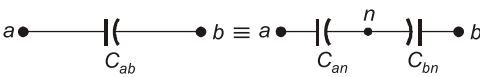
$$C_{an} = C_{bn} = 2C_{ab}$$

### Charging Current

- The current caused by the alternate charging and discharging of the line due to alternating voltage is called **charging current** of the line.

**Note:** .....

- Charging current flows in a line even when the line is open circuited and affects the voltage drop, efficiency and power factor of the line.
- .....

### Charging Current for 1-ϕ line

$$I_C = j\omega C_{ab} V_{ab} = j \cdot 2\pi f C_{ab} V_{ab}$$

where,  $V_{ab} \rightarrow$  Potential difference between conductor  $a$  and  $b$   
 $f \rightarrow$  Frequency of alternating voltage

### Capacitance of 3-ϕ line with equilateral spacing

$$C_n = \frac{0.02412}{\log\left(\frac{D}{r}\right)} \mu\text{F/km}$$

where,  $C_n \rightarrow$  Line to neutral capacitance ;  $D \rightarrow$  Spacing between conductors ;  $r \rightarrow$  Radius of each conductor

**Charging current per phase,  $I_C = j\omega C_n V_{an}$**

**Capacitance of 3-φ line with asymmetrical spacing**

$$C_n = \frac{0.02412}{\log\left(\frac{D_{eq}}{r}\right)} \mu\text{F/km}$$

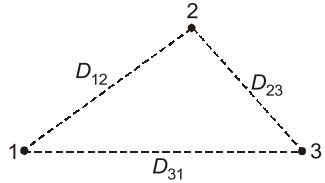

where,  $D_{eq} = \sqrt[3]{D_{12} D_{23} D_{31}}$

**Capacitance of bundled conductor lines**

$$C_n = \frac{0.02412}{\log\left(\frac{D_{eq}}{\sqrt{rd}}\right)} \mu\text{F/km}$$

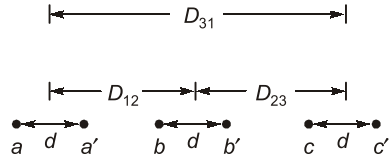

The term  $\sqrt{rd}$  is known as GMR or self GMD for a two bundle; denoted by  $D_{sc}^b$

- For a two conductor bundle,  $D_{sc}^b = \sqrt{rd}$
- For a three conductor bundle,  $D_{sc}^b = \sqrt[9]{(r \times d \times d)^3} = \sqrt[3]{rd^2}$
- For a four conductor bundle,  $D_{sc}^b = \sqrt[16]{(r \times d \times d \times \sqrt{2}d)^4} = 1.09\sqrt[4]{rd^3}$

**Effect of Ground on Line Capacitance (Method of Images)**

The presence of ground alters the electric field of a line and hence affect the line capacitance.

**For 1-φ line**

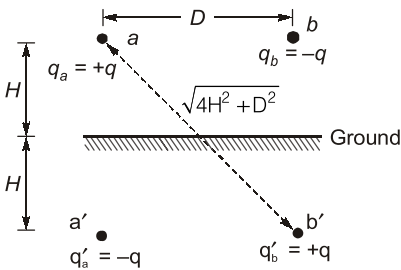

$$C_{ab} = \frac{0.01206}{\log\left(\frac{D}{r\left(1 + \frac{D^2}{4H^2}\right)^{0.5}}\right)} \text{mF/km}$$

where,  $H \rightarrow$  Height of conductor from ground

$$C_{an} = 2C_{ab} = \frac{0.02412}{\log\left(\frac{D}{r'}\right)} \mu\text{F/km} \quad ; \quad r' = r\sqrt{1 + \left(\frac{D}{2H}\right)^2}$$

**For 3-φ line**

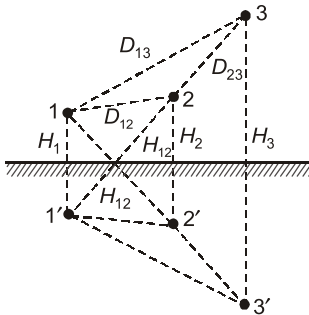

Conductors of a 3-phase line with image charges

$$C_n = \frac{0.02412}{\log\left(\frac{D_{eq}}{r}\right) - \log\left[\frac{\sqrt[3]{H_{12}H_{23}H_{31}}}{\sqrt[3]{H_1H_2H_3}}\right]}$$

where,  $H_1, H_2, H_3,$  and  $H_{12}, H_{23}, H_{31}$  are shown in figure.  
 $C_n$  is in  $\mu\text{F}/\text{km}$ .

**Note:** .....

- Presence of ground increases the line capacitance by small amount.
- .....

**III Performance of Transmission Line**

Type of Transmission line	Classification based on $f * l$	Classification based on length if line is power line i.e. $f = 50 \text{ Hz}$	Based on operating voltage	Effect of capacitance
Short line	$ft < 4000 \text{ Hz km}$	$l < 80 \text{ km}$	0-20 kV	Neglected
Medium line	$4000 < ft < 12000 \text{ Hz km}$	$80 \text{ km} < l < 240 \text{ km}$	20-100 kV	Capacitor is lumped and constant
Long line	$ft = 12000 \text{ Hz km}$	$l > 240 \text{ km}$	$> 100 \text{ kV}$	Capacitance is uniformly distributed

where,  $f \rightarrow$  Operating frequency ;  $l \rightarrow$  Length of transmission line

**Short transmission lines**

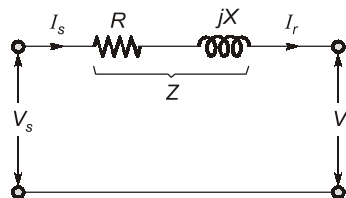

$$I_s = I_r, \quad V_s = V_r + I_r Z$$

where,  $V_s \rightarrow$  Sending end voltage ;  $V_r \rightarrow$  Receiving end voltage  
 $I_s \rightarrow$  Sending end current ;  $I_r \rightarrow$  Receiving end current

*In Matrix form:*

$$\begin{bmatrix} V_s \\ I_s \end{bmatrix} = \begin{bmatrix} A & B \\ C & D \end{bmatrix} \begin{bmatrix} V_r \\ I_r \end{bmatrix} ; \quad \begin{bmatrix} V_s \\ I_s \end{bmatrix} = \begin{bmatrix} 1 & Z \\ 0 & 1 \end{bmatrix} \begin{bmatrix} V_r \\ I_r \end{bmatrix}$$

So,  $A = 1, B = Z, C = 0, D = 1$

$$V_s \simeq V_r + I_r R \cos \phi_r + I_r X \sin \phi_r$$

**Note:** .....

- ☑ The performance of transmission line is determine by efficiency and voltage regulation.
  - ☑ For rotating machine speed regulation determine and for static machine voltage regulation determine.
  - ☑ For satisfactory performance lower the regulation and higher the efficiency.
- .....

**Voltage Regulation**

It is the change in receiving end voltage from no load to full load while keeping the sending end voltage constant and made supply frequency constant.

$$\text{Voltage regulation} = \frac{V'_r - V_r}{V_r}$$

where,  $V'_r$  = Receiving end voltage under no load condition  
 $V_r$  = Receiving end voltage under full load condition

**Regulation of Short Transmission Line**

$$\text{Regulation} = \frac{I_r R \cos \phi_r \pm I_r X \sin \phi_r}{V_r}$$

where,  $+$  → For lagging power factor  
 $-$  → For leading power factor

**Note:** .....

- Regulation is always positive for lagging power factor.
  - Regulation may be positive, negative or zero for leading power factor.
  - In short line sending end power factor always less than receiving end power factor.
  - Short line is always symmetrical and reciprocal.
  - Regulation maximum when  $\phi_r = \theta$ .
- .....

**Maximum voltage regulation occurs when**

$$\phi_r = \theta$$

where,  $\phi_r$  = Phase angle of load

$$\theta = \text{Impedance angle of line} = \tan^{-1} \frac{X}{R}$$

**Zero regulation occurs when**

$$\phi_r + \theta = \frac{\pi}{2}$$

- At leading pf the regulation will generally negative but it also becomes zero provided that

$$\phi_r = \tan^{-1}(R/X) \quad \text{i.e. 0.707 power factor lead.}$$

**Medium Length Transmission Line**

ABCD parameter in matrix form

**For nominal T-circuit**

$$\begin{bmatrix} V_s \\ I_s \end{bmatrix} = \begin{bmatrix} 1 + \frac{YZ}{2} & Z \left( 1 + \frac{YZ}{4} \right) \\ Y & 1 + \frac{YZ}{2} \end{bmatrix} \begin{bmatrix} V_r \\ I_r \end{bmatrix}$$

**For nominal  $\pi$ -circuit**

$$\begin{bmatrix} V_s \\ I_s \end{bmatrix} = \begin{bmatrix} 1 + \frac{YZ}{2} & Z \\ Y \left( 1 + \frac{YZ}{4} \right) & 1 + \frac{YZ}{2} \end{bmatrix} \begin{bmatrix} V_r \\ I_r \end{bmatrix}$$

**Note:**

- For a fix receiving end voltage the sending end voltage which is calculated in nominal- $\pi$  model will be slightly high when compare to nominal-T so regulation in nominal- $\pi$  is slightly high when compare to nominal-T.

**Farranti Effect**

When receiving end of the transmission line is operating under no load condition or lightly load condition, sending end voltage  $V_s$  is less than receiving end voltage  $V_r$ .