

# Electroless Nickel / Immersion Gold Process Technology for Improved Ductility of Flex and Rigid-Flex Applications

By: Kuldip Johal and Hugh Roberts - Atotech USA Inc.  
 Sven Lampecht and Christian Wunderlich - Atotech Deutschland GmbH  
[kjohal@atousa.com](mailto:kjohal@atousa.com); [sven.lampecht@atotech.com](mailto:sven.lampecht@atotech.com); [hroberts@atousa.com](mailto:hroberts@atousa.com)

## ABSTRACT

Because of their numerous functional design and application possibilities, the use of flex and rigid-flex PWBs is increasing rapidly. However, this shift poses additional challenges within circuit board fabrication and assembly operations, particularly in terms of the surface finish on the PWB. In response, to improve the reliability of flex and rigid-flex circuit applications, alternative surface finish methods are increasingly being used, such as the electroless nickel/immersion gold (ENIG) process.

To avoid cracking of the nickel during bending, the use of ENIG for flex and rigid-flex circuits has typically required a relatively thin electroless nickel deposit of medium phosphorus content. In this technical paper, the reliability of ENIG with high-phosphorus electroless nickel is examined for such applications. Using electroless nickel deposits of varying thickness and phosphorus content, results of bending tests, hardness, and SEMs are compared to predict reliability of the assembled flexible circuit. In particular, Young's Modulus (stress-to-strain ratio) is evaluated to show a direct relationship between the phosphorus content of the electroless nickel deposit and the ductility of the overall ENIG finish. The ENIG process with high-phosphorus nickel is shown to offer a more reliable surface finish for flex and rigid-flex applications.

## INTRODUCTION

During the next several years, no other segment of the printed wiring board (PWB) industry is forecasted to grow as rapidly as the flexible circuit segment. As shown in

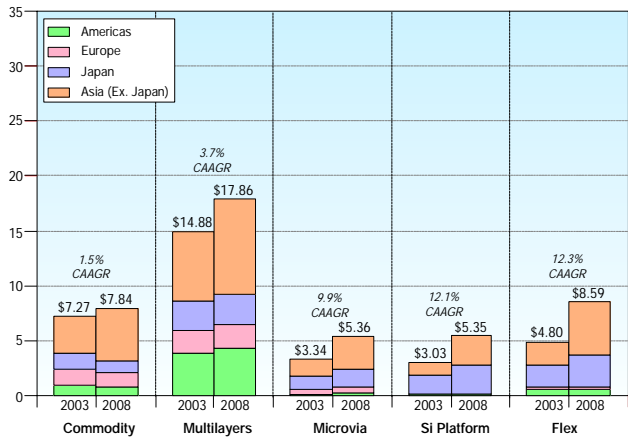

Fig 1. Projected PWB Market Profiles Growth 2003 vs. 2008 (Source: Prismark Partners LLC)

Figure 1, the flexible printed circuit market is forecasted to grow at an annualised rate of more than 12-percent, reaching a worldwide production value of \$8.6 billion by 2008. As indicated in Figure 2, this increase is concentrated in key areas, mainly attributed to the rapid growth in use of mobile phone, digital camera and LCD technologies.

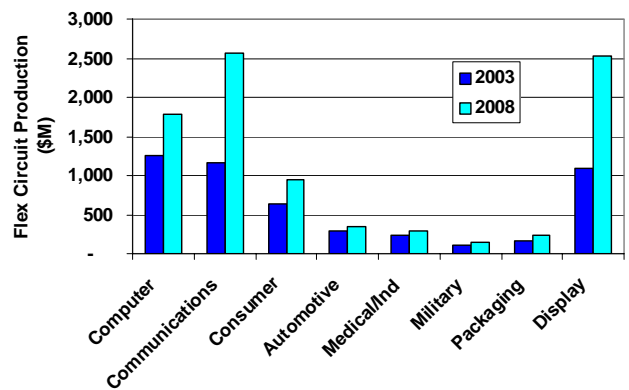

Fig 2. Flexible Circuit Market Growth by Application 2003 vs. 2008 (Source: Prismark Partners LLC)

Only a few years ago, Japan was recognized as the global center for fabrication of flexible circuits. However, as expected, much of the growth in this market segment will be experienced most dramatically in other parts of Asia. As presented in Figure 3, the value of flexible circuits produced in Asian (countries other than Japan) is predicted to reach nearly five billion dollars by 2008.

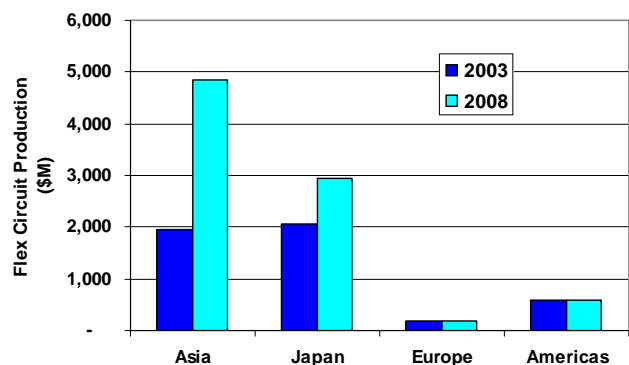
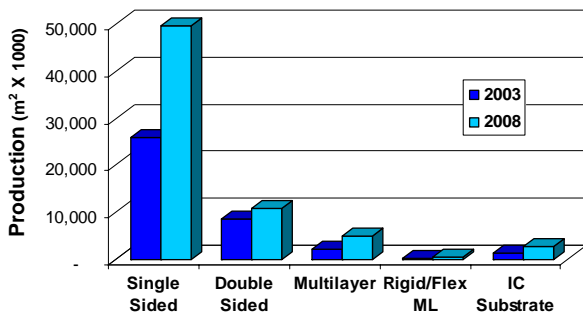
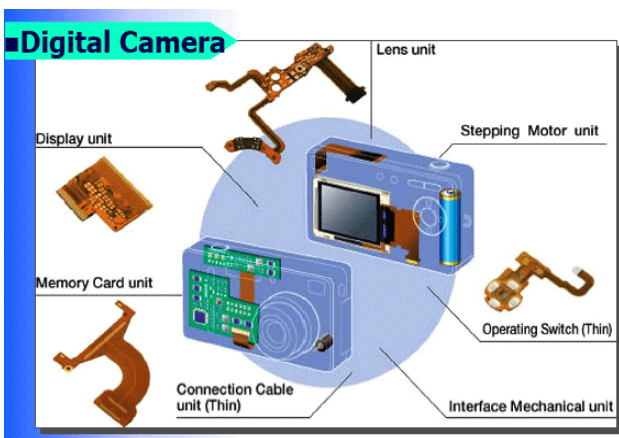
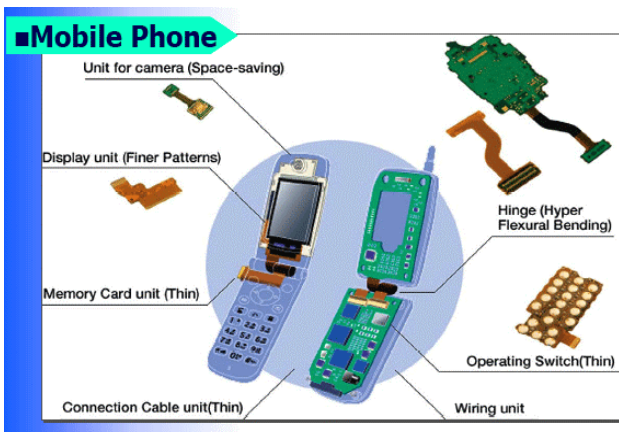

Fig 3. Flexible Circuit Market Growth by Global Area 2003 vs. 2008 (Source: Prismark Partners LLC)

Figure 4 presents a prediction of the expected flexible



circuit market growth according to the type of circuit board. As shown, single-sided flexible material will continue to be the dominant format and will increase in terms of market share.



## SURFACE FINISH ALTERNATIVES FOR FLEXIBLE CIRCUIT APPLICATIONS

Currently, a variety of methods exist for surface finish of flexible and rigid-flex circuits. Among these are:

- Electrolytic Tin/Lead
- Electrolytic Tin
- Electrolytic Nickel/Gold
- Immersion Silver
- Immersion Tin
- Electroless Nickel/Immersion Gold
- Organic Solderability Preservative

There is no single deposit that provides the perfect surface finish, which explains the existence of these various alternatives. For example, electrolytic nickel/gold is most predominant in flexible circuit applications where metallic surface finishes are used. However, as with any electrodeposited metal, there are problems with surface distribution and plating in fine-line dimensions. Likewise, OSPs are simple to use from a fabrication standpoint, although these coatings do not allow wire bonding and their ability to withstand multiple thermal excursions during component assembly is well known. As a result, OEMs are frequently seeking ways to improve the reliability of the surface finish while reducing costs.

The electroless nickel / immersion gold (ENIG) process has been used for more than 20 years in the PWB industry. As a finish, ENIG is now receiving increased attention because it meets requirements for lead-free assembly while offering a coplanar surface that is both solderable and aluminum-wire bondable. ENIG is also well suited for hot bar soldering and anisotropic conductive film (ACF) bonding.

## HIGH-PHOSPHORUS ELECTROLESS NICKEL / IMMERSION GOLD

In the application of electroless nickel, the nickel is commonly co-deposited with phosphorus. Most ENIG processes currently used for circuit applications create a nickel deposit with medium-phosphorus content, in the range of 7-9 percent by weight. In recent years there has been a gradual but consistent shift to the use of high-phosphorous electroless nickel/immersion gold (HP-ENIG) as a final finish. This acceptance is particularly evident in the telecommunications industry, which is experiencing a significant increase in the use of flexible circuits, as previously mentioned.

The immersion gold step of any ENIG process relies on the exchange of nickel ions for gold, which is essentially a corrosion action. To compensate for the lower ductility of medium-P electroless nickel deposits, some fabricators of flexible PWBs finished with ENIG deposit a relatively low nickel thickness (2-3 microns) in comparison to deposits on standard rigid materials. This reduced thickness has been necessary to avoid nickel cracking during normal bending of the flex circuit. However, because of the thin nickel layer, corrosion from the immersion gold step can frequently cause problems with solder joint integrity after assembly, a

result commonly known as the “Black Pad” defect. Although a thicker nickel deposit may eliminate the black pad issue, it compounds the problem of nickel cracking during bending of the flexible circuits. This cracking is directly related to the nickel deposit properties, such as ductility and internal stress, which are primarily influenced by the composition of the nickel solution, the solution age as defined by number of metal turnovers (MTO) and the phosphorous content.

HP-ENIG involves the use of an electroless nickel deposit containing 10-13 percent phosphorus by weight. Because of the higher phosphorus content in the nickel deposit, it offers superior corrosion resistance compared to that of a low- or medium- phosphorous process. Figure 6 illustrates the build-up of the electroless nickel and immersion gold layers on the base copper of the flexible circuit.

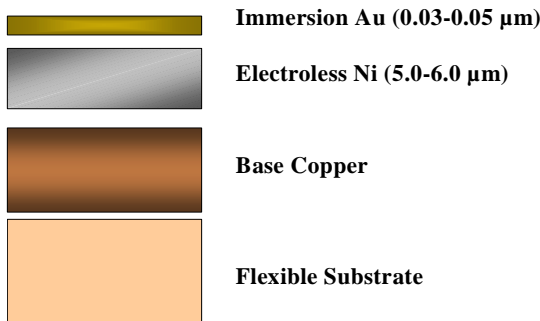

**Fig 6.** Layer build-up for the High-Phosphorus ENIG process

Table 1 presents information regarding the HP-ENIG process sequence and key operating parameters.

<b>Table 1. HP-ENIG Process Sequence and Parameters</b>		
<b>Process Step</b>	<b>Treatment Time (min)</b>	<b>Treatment Temp (°C)</b>
Clean	3-6	35-45
Micro etch	1 - 2	25-35
Acid Dip	>3	Ambient
Activate	1-3	20-25
<b>Electroless Nickel</b>	<b>20-30</b>	<b>80-90</b>
<b>Immersion Gold</b>	<b>10-12</b>	<b>80-85</b>

If it is accepted that a corrosion-resistant electroless nickel layer undergoes less attack by the immersion gold reaction, the resultant gold thickness will be lower in comparison to a nickel layer with less corrosion-resistance, providing the immersion gold solution parameters are equal. This condition was previously observed<sup>1</sup> on a nickel deposit of 8.0-percent phosphorus that achieved a gold thickness of 0.08μm, while a nickel layer of 11.2-percent phosphorus yielded a gold thickness of only 0.05μm. Although the tool

used to measure the gold thickness is also limited in accuracy (typically +/- 0.01μm or greater) depending on pad size and collimator been used, it does suggest that thicker gold will be deposited on the nickel layer that is more readily attacked.

From the standpoint of solder joint integrity, previous investigations<sup>1</sup> have shown that the resulting deposit exhibits greater ductility and is less prone to brittle fracture than that obtained using a medium-P process.

**FLEXIBLE CIRCUIT BENDING TEST METHODS**

Because flexible circuit designs are often unique for each application, the original equipment manufacturer (OEM) defines their specific performance criteria. However, such specifications are typically based on accepted industry standards. The primary standard regarding performance testing for flexible circuits is IPC-6013A (Qualification and Performance Specification for Flexible Printed Boards)<sup>2</sup>. Within this standard, Section 3.6 specifies “Physical Requirements” for such circuits, including “Bending Flexibility”. Figure 7 shows the basic premise for the 90° and 180° bend tests according to IPC-6013A, where

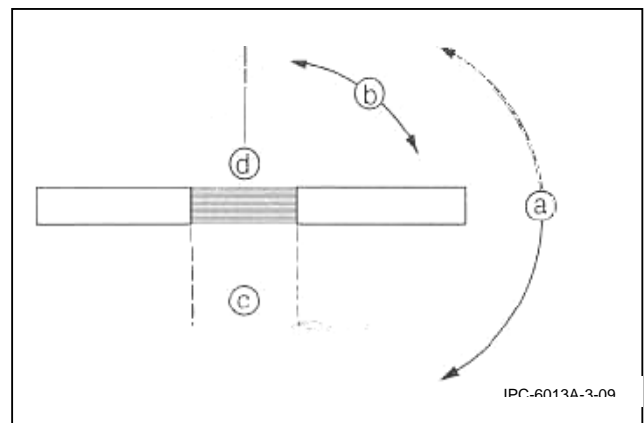

**Fig 7.** Bending test according to IPC-6013A

direction of bend (a), degree of bend (b), number of bend cycles and the bend radius (d) are required. Guidelines for determining the minimum bend radius (d) are set forth in IPC-2223-A (Sectional Design Standard for Flexible Printed Boards). Figure 8 illustrates the performance of the 90° and 180° bend tests in practice for a selected bend radius.

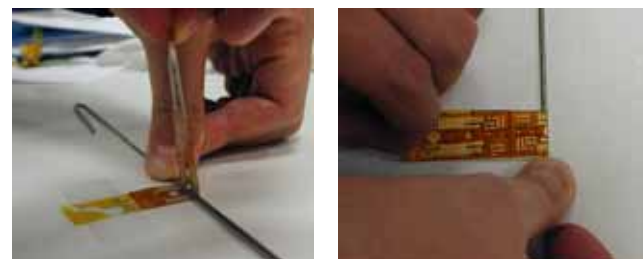

**Fig 8.** Performing the 90° bend test (left) and 180° bend test (right)

Other dynamic testing is employed within the flex circuit industry and has been previously documented<sup>3</sup>. An illustration of each of these tests is shown in Figure 9.

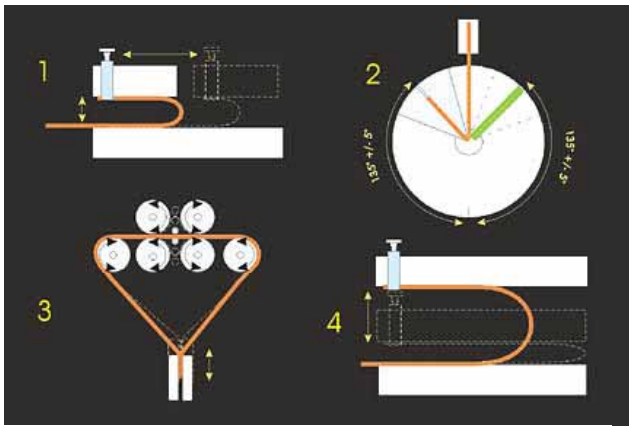

**Fig 9.** Illustration of various bending tests for flexible circuits: (1) Cyclical Rolling Flex Test, (2) Cyclical Bend Test, (3) Fatigue Ductility Flex Test and (4) Collapsing Radius Test

One flexible circuit fabricator has adopted a relatively simple method for testing the ENIG surface finish on flexible substrates. The test involves fixing one end of the flexible circuit coupon and pulling a wire of known diameter ( $d$ ) through the length of the sample as shown in Figure 10.

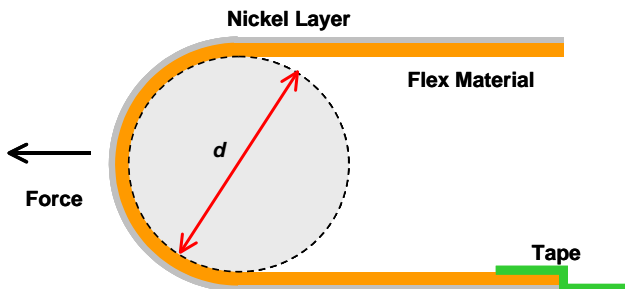

**Fig 10.** Wire pull/bend test for flexible circuits

By simulating both a bending and “curling” effect, this test was considered to be a more demanding and accurate measure of the ductility required of the deposit. Figure 11 shows the performance of this test in practice using a 2-mm wire to roll the bend through the flexible material.

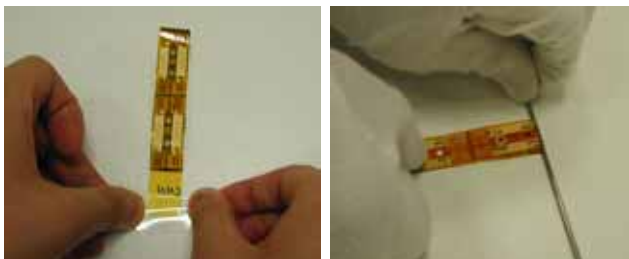
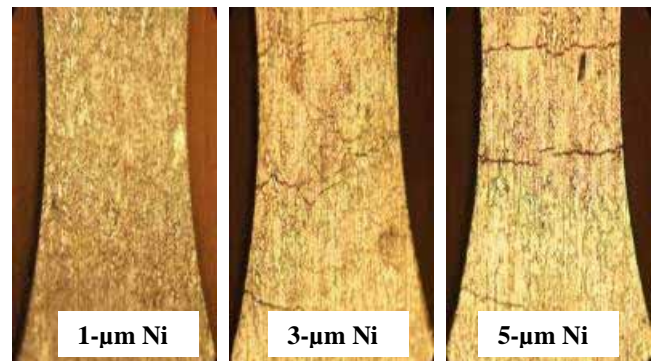

**Fig 11.** Securing the flex circuit sample (left) and performing the 2-mm wire pull/bend test (right)

## BENDING TEST RESULTS

Wire pull/bend tests were performed on flexible circuits with surface finishes of medium-phosphorus and high-phosphorus ENIG. Using a 2-mm wire, tests were conducted on both deposits with nickel deposit thicknesses of 1 $\mu$ m, 3 $\mu$ m and 5 $\mu$ m. In all cases, the gold thickness was held constant at 0.05 $\mu$ m. All conductor widths were 0.5 mm.

Figure 12 shows the results of the 2-mm wire pull/bend test as performed on the ENIG deposit of medium phosphorus



**Fig 12.** Medium-phosphorus ENIG deposit after 2-mm wire pull/bend test showing evidence of surface cracks

content. Cracks in the deposit are readily noticeable at a nickel thickness of 3 $\mu$ m and the defect is exacerbated at the 5- $\mu$ m nickel thickness, as seen in Figure 13, which presents

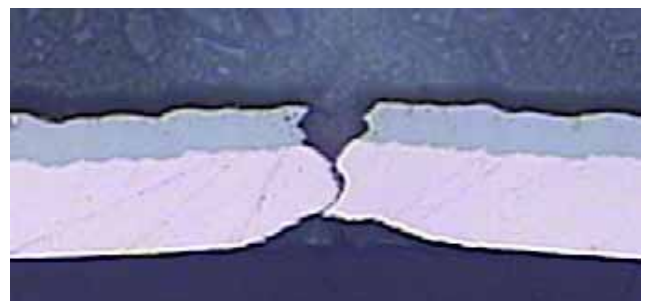

**Fig 13.** Cross section of 5- $\mu$ m medium-phosphorus ENIG deposit on copper following 2-mm wire pull/bend test

a sample cross-section that clearly shows the magnitude of the defect. As noted previously, it is for this reason that fabricators of flexible circuits will compensate for the lack of ductility in this type of deposit by reducing the electroless nickel thickness. Unfortunately, such a reaction increases the probability of “black pad” effect as a result of corrosion by the immersion gold.

In contrast, the wire pull/bend test results for the HP-ENIG deposit resulted in no discernible cracks at any thickness tested, as shown in Figures 14 and 15. The preferred minimum electroless nickel deposit of 5- $\mu$ m can thus be applied without concern for surface cracking. This is a significant advantage of the HP-ENIG deposit since it plays



such a major role in the prevention of copper attack by the immersion gold step (and the resultant Black Pad effect).

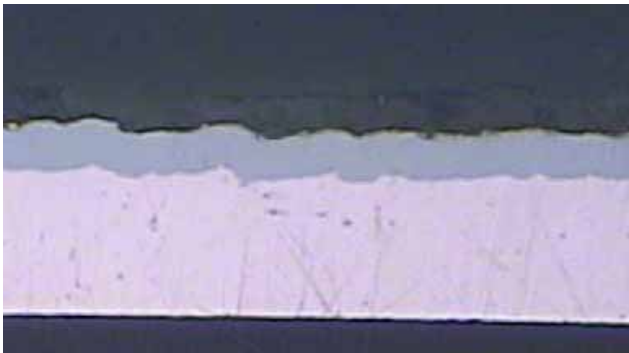
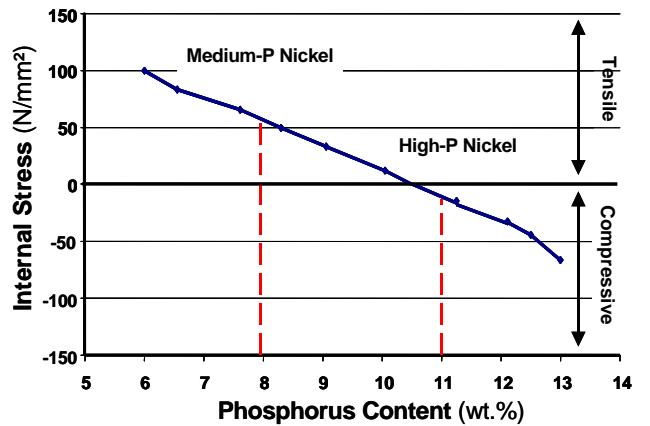
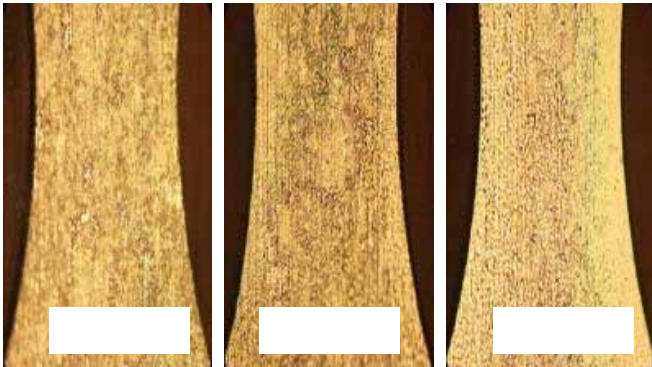

Figures 17 and 18 show the results of these tests for different nickel thicknesses and electroless nickel solution metal turnovers (MTO). Comparing the two charts, it can be observed that the internal stress of the high-phosphorus deposit is lower and impacted to a lesser degree by both metal thickness and MTO.

### DUCTILITY AND STRESS ANALYSIS

Ductility is a measurement of the extent that a material can be “plastically” deformed before fracture occurs. It is commonly expressed as percent elongation (%EL) or percent reduction in area (%RA):

$$\%EL = \frac{l_f - l_0}{l_0} \times 100\% = \epsilon_f \times 100\%$$

$$\%RA = \frac{A_0 - A_f}{A_0} \times 100\%$$

In flexible circuit applications, ductility one is an important property of the ENIG deposit. The key to ductility is to maintain low internal stress to account for the required bending. As shown in Figure 16, electroless nickel deposits with medium phosphorus content of (7-9 percent) exhibited internal stress in the tensile range of approximately 60 N/mm<sup>2</sup>. Conversely, the high-phosphorus (10-12 percent) nickel deposit displayed internal stresses of a compressive nature and of lower values in comparison to the medium-phosphorus deposit.

In similar manner, the effect of nickel thickness was examined for medium- and high-phosphorus deposits.

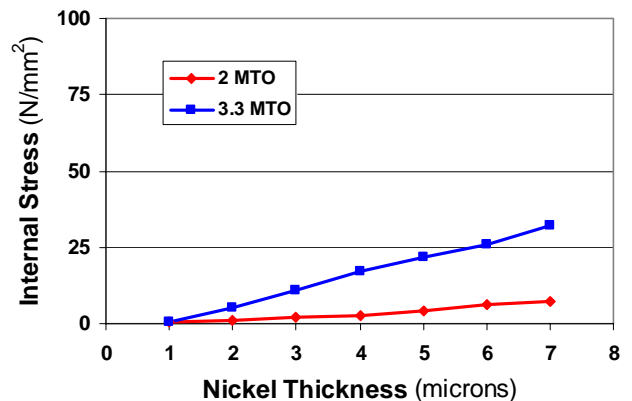
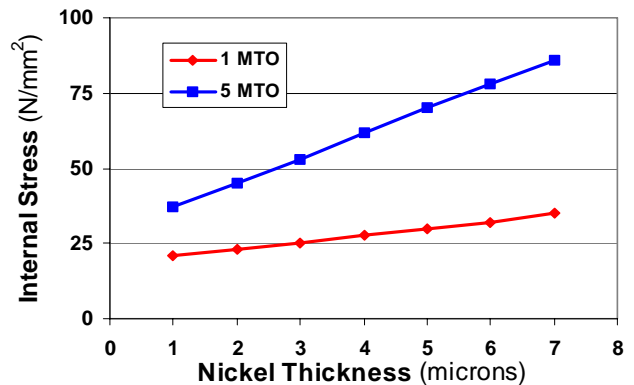

**ELASTICITY**

For the description of the elastic properties of linear objects like wires, rods, columns that are either stretched or compressed, a convenient parameter of the material is the Young's Modulus.<sup>4</sup> Young's modulus can be used to predict the elongation or compression of an object as long as the stress is less than the yield strength of the material.

Young's Modulus ( $E$ ) is defined as the ratio of stress to strain:

$$E = \frac{[\text{stress}]}{[\text{strain}]}$$

This ratio can also be expressed as:

$$E = \frac{L_0}{\Delta L} \frac{F}{A}$$

where  $L_0$  is the equilibrium length,  $\Delta L$  is the length change under the applied stress,  $F$  is the force applied, and  $A$  is the area over which the force is applied.

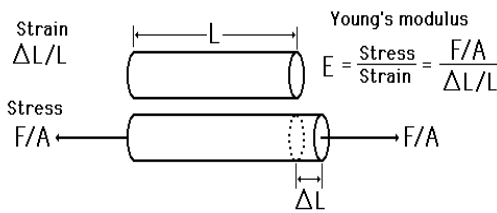

Measured in Pascals or Newtons per square meter ( $N/m^2$ ), Young's Modulus provides a relatively simple method for comparing the elastic properties of various materials.

As a means of comparing the elasticity of HP-ENIG deposit versus an ENIG deposit of medium phosphorus content, the Young's modulus for each case was measured. A Fisherscope H100C was used to measure the resultant stress and strain. Figure 19 shows a comparison of Young's Modulus values for electroless nickel deposits of varying

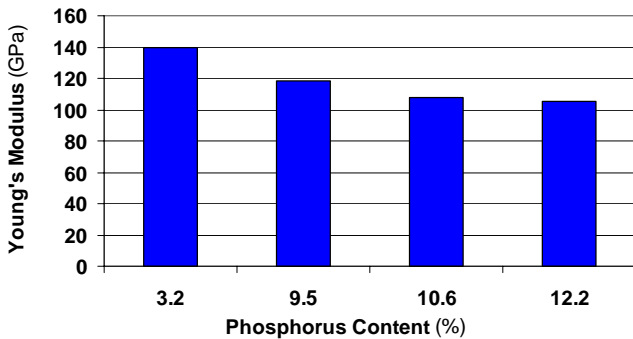

phosphorus content. As shown, the deposits of higher phosphorus content exhibit a lower Young's Modulus, indicating a higher degree of elasticity. The Young's Modulus of the HP-ENIG is within the range of that for electrolytically deposited copper, which is typically 70-110 Gpa.

**HARDNESS**

Hardness is defined as the measure of a material's ability to withstand indentation. For measurements of microhardness, the Vickers unit of hardness is often used and results can be directly related to the strength of the material. The following table compares the Vickers hardness values for electroless nickel deposits of varying phosphorus content. As shown, no clear trend was observed regarding the relationship between phosphorus content of the nickel and the hardness of the deposit.

Comparison of Hardness for Electroless Nickel Deposits of Varying Phosphorus Content		
Electroless Nickel Process Solution	Phosphorus Content (%)	Vickers Hardness
Low P	3.2	1026
Medium P	9.5	760
Medium-High P	10.6	1040
High P	12.2	802

**CONCLUSIONS**

Based on the investigations performed in this evaluation, the following conclusions are offered:

1. OEMs exert a major influence in determining the application requirements for flexible circuits. As such, design and functionality are often not assigned to a common industry standard.
2. Varying the content of co-deposited phosphorus directly influences the inherent stress in the electroless nickel deposit. The internal stress within the nickel deposit will shift from the tensile range at medium phosphorus content (7-9%) to the compressive range at 10-13% phosphorus. Furthermore, at the higher phosphorus content, the internal stress of the nickel is less affected by changes in deposit thickness and plating solution age.
3. Increasing the content of co-deposited phosphorus can improve the elasticity of the nickel deposit as measured by Young's Modulus. A more elastic (i.e. lower Young's Modulus) response can be achieved with the high-phosphorus electroless nickel deposit.
4. For all thicknesses examined, the HP-ENIG deposit showed superior performance in the 2-mm wire pull/bend test for flexible circuit applications in comparison to a medium-phosphorus deposit.

In summary, results of internal stress analysis, measurement of elasticity and practical bending tests indicate that the HP-ENIG process is well suited for applications involving flexible and rigid-flex circuitry. Because of its (1) improved resistance to corrosion from the immersion gold step, (2) lower and compressive internal stress and (3) higher ductility, the HP-ENIG deposit was determined to be capable of withstanding more intensive flexural testing than conventional ENIG processes with nickel deposits of medium phosphorus content. Further investigations are necessary and will be performed to fully assess the impact of different flexible circuit construction and design on testing results.

---

## REFERENCES

1. Kuldip Johal , Sven Lamprecht, Dr. Hans-Jurgen Schreier, Hugh Roberts; "Impacts of Bulk Phosphorous Content of Electroless Nickel Layers to Solder Joint Integrity and their Use as Gold- and Aluminum-Wire Bond Surfaces", Proceedings of SMTA Pan Pacific Microelectronics Symposium; February 2004.
2. "Qualification and Performance Specification for Flexible Printed Boards" IPC-6013A, Published by IPC, November 2003.
3. Fjelstad, Joseph. "Bend Testing Methods for Flexible Circuits". CircuiTree; February 2002.
- 4 . Halliday, Resnick, Walker, Fundamentals of Physics, 5E,Extended, Wiley 1997.