

# Electronic Excitation by UV/Vis Spectroscopy :

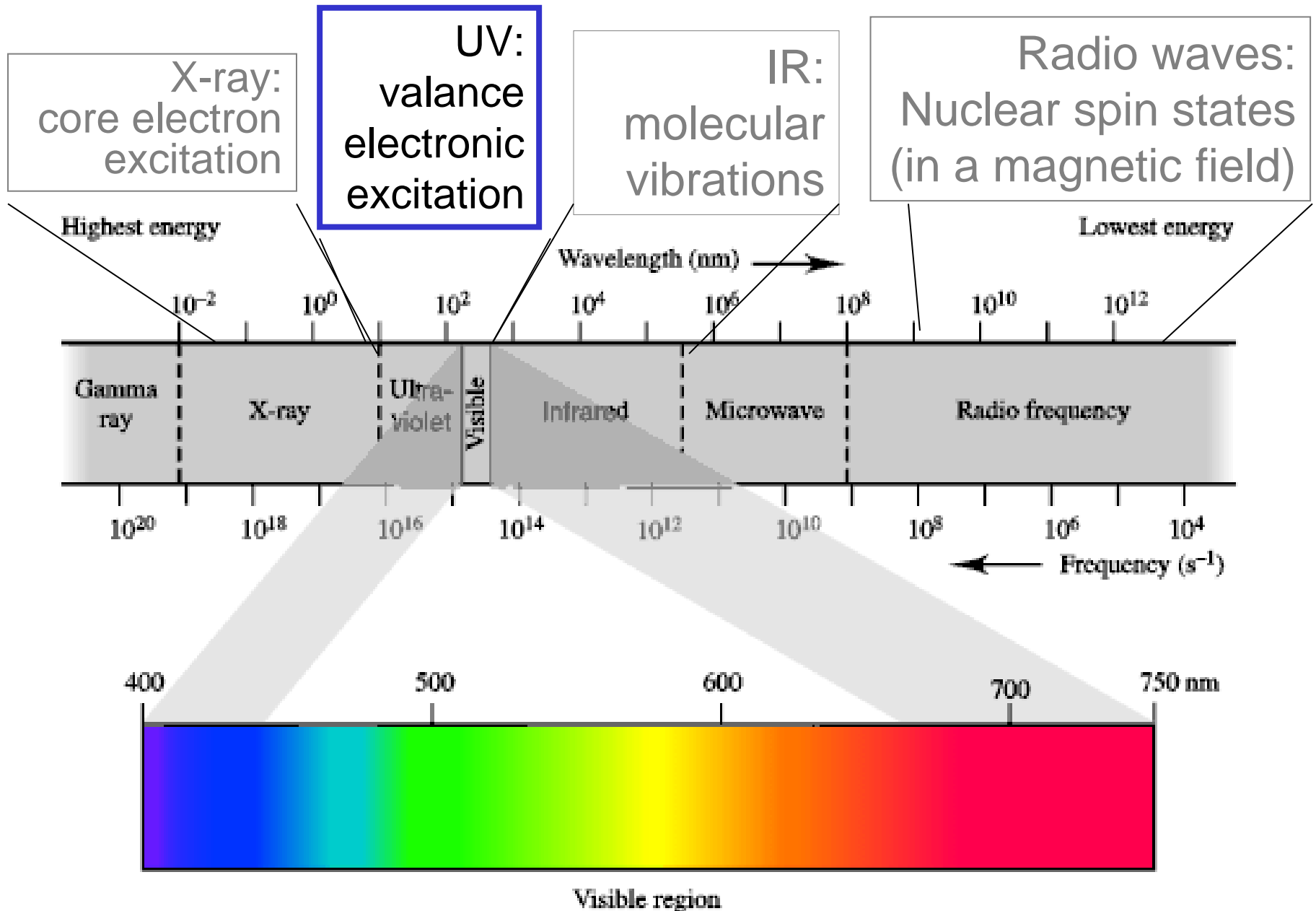

# • Interaction of electromagnetic radiant with matter

– The wave-length,  $\lambda$ , and the wave number,  $\nu'$ , of e.m.r. changes with the medium it travels through, because of the refractive index of the medium; the frequency,  $\nu$ , however, remains unchanged

– Types of interactions

- Absorption
- Reflection
- Transmission
- Scattering
- Refraction

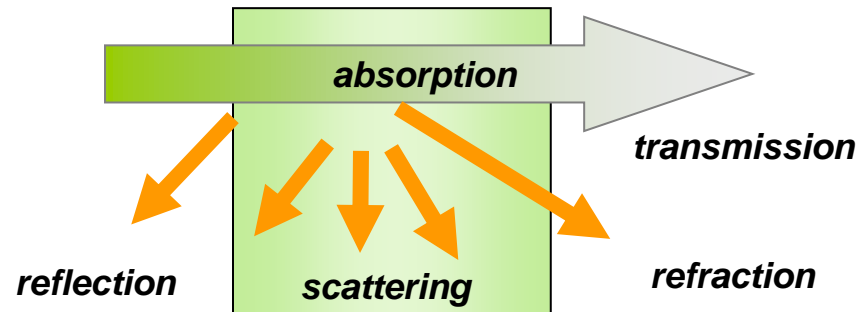

– Each interaction can disclose certain properties of the matter

– When applying e.m.r. of different frequency (thus the energy e.m.r. carried) different type information can be obtained

# Spectral properties, applications, and interactions of electromagnetic radiation

Energy		Wave number	Wavelength	Frequency	Type of radiation	Type of spectroscopy	Type of quantum transition
kcal/mol	Electron volt eV	$\frac{\nu}{\text{cm}^{-1}}$	$\frac{\lambda}{\text{cm}}$	$\frac{\nu}{\text{Hz}}$			
$9.4 \times 10^7$	$4.1 \times 10^6$	$3.3 \times 10^{10}$	$3.0 \times 10^{-11}$	$10^{21}$	Gamma ray	↑ Gamma ray emission ↓	↑ Nuclear ↓
$9.4 \times 10^5$	$4.1 \times 10^4$	$3.3 \times 10^8$	$3.0 \times 10^{-9}$	$10^{19}$	X-ray	↑ X-ray absorption emission ↓	↑ Electronic (inner shell) ↓
$9.4 \times 10^3$	$4.1 \times 10^2$	$3.3 \times 10^6$	$3.0 \times 10^{-7}$	$10^{17}$	Ultra Violet	↑ Vac ↓	↑ Electronic (outer shell) ↓
$9.4 \times 10^1$	$4.1 \times 10^0$	$3.3 \times 10^4$	$3.0 \times 10^{-5}$	$10^{15}$	Visible	↑ UV } ↓ Vis } absorption emission fluorescence	↑ Electronic (outer shell) ↓
$9.4 \times 10^{-1}$	$4.1 \times 10^{-2}$	$3.3 \times 10^2$	$3.0 \times 10^{-3}$	$10^{13}$	Infrared	↑ IR absorption ↓ Raman	↑ Molecular vibration ↓
$9.4 \times 10^{-3}$	$4.1 \times 10^{-4}$	$3.3 \times 10^0$	$3.0 \times 10^{-1}$	$10^{11}$	Microwave	↑ Microwave absorption ↓	↑ Molecular rotation ↓
$9.4 \times 10^{-5}$	$4.1 \times 10^{-6}$	$3.3 \times 10^{-2}$	$3.0 \times 10^1$	$10^9$	Radio	↑ Electron paramagnet resonance ↓	↑ Magnetically induced spin states ↓
$9.4 \times 10^{-7}$	$4.1 \times 10^{-8}$	$3.3 \times 10^{-4}$	$3.0 \times 10^3$	$10^7$		↑ Nuclear magnetic resonance ↓	

# UV Spectroscopy

## I. Introduction

### A. UV radiation and Electronic Excitations

1. The difference in energy between molecular bonding, non-bonding and anti-bonding orbitals ranges from 125-650 kJ/mole
2. This energy corresponds to EM radiation in the ultraviolet (UV) region, 100-350 nm, and visible (VIS) regions 350-700 nm of the spectrum
3. For comparison, recall the EM spectrum:

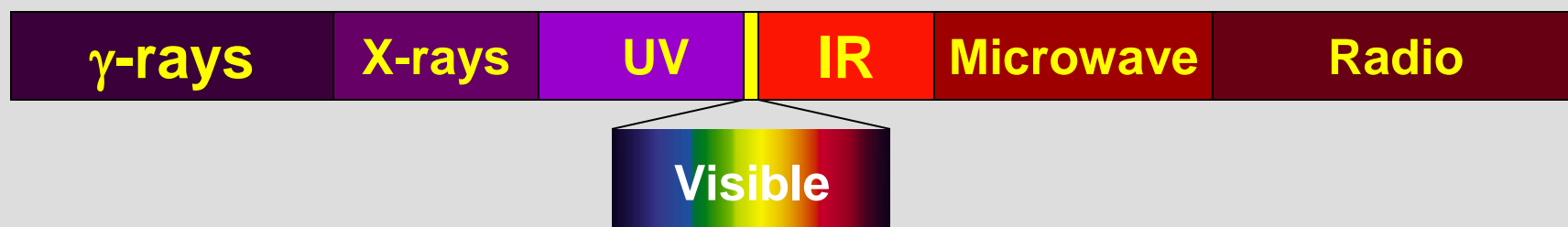

4. Using IR we observed vibrational transitions with energies of 8-40 kJ/mol at wavelengths of 2500-15,000 nm
5. For purposes of our discussion, we will refer to UV and VIS spectroscopy as UV

# ESPECTROSCOPIA NO ULTRAVIOLETA / VISÍVEL

***Faixa de absorção***

***Efeito e informação obtida***

***Ultravioleta***

$\lambda = 190 - 400 \text{ nm}$

***Visível***

$\lambda = 400 - 800 \text{ nm}$

***Mudança nos níveis de energia eletrônica da molécula***

*(característico de extensão dos sistemas de elétrons  $\pi$ , presença de insaturação conjugada e conjugação com elétrons não-ligantes)*

# Transmission and Color

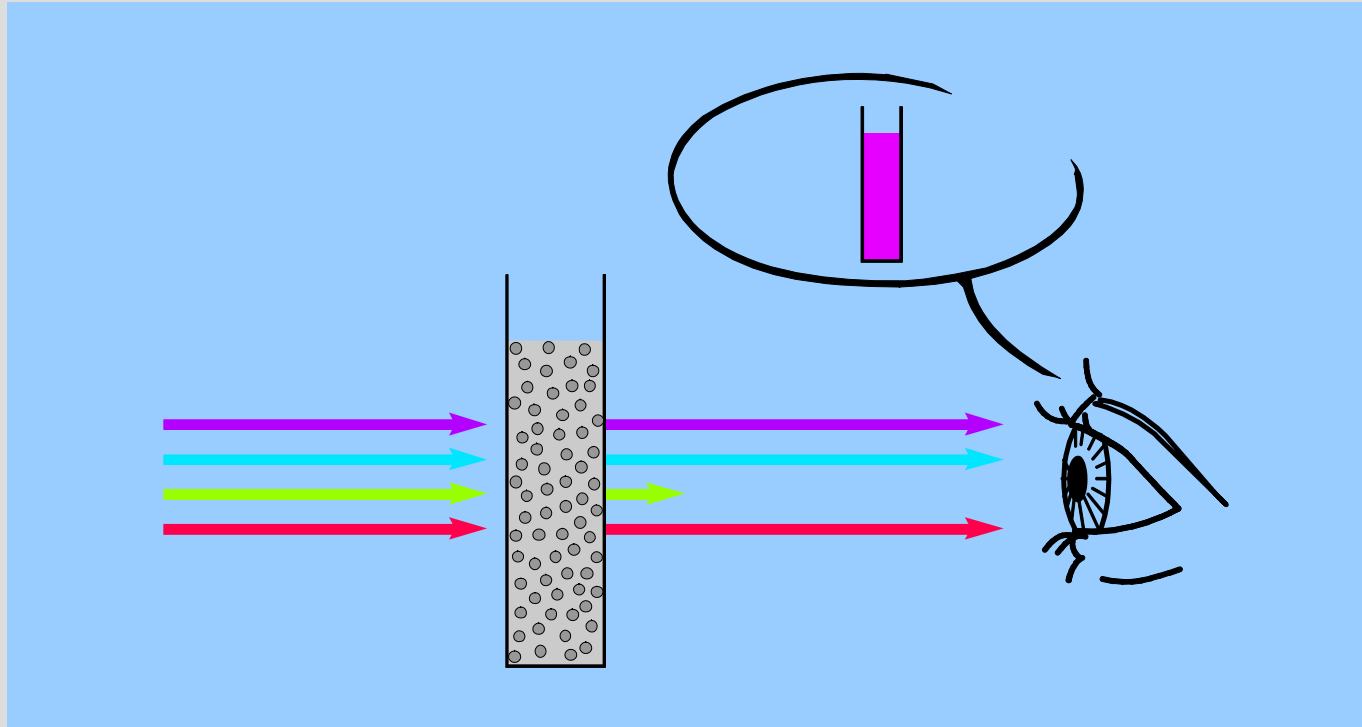

*The human eye sees the complementary color to that which is absorbed*

# Absorbance and Complementary Colors

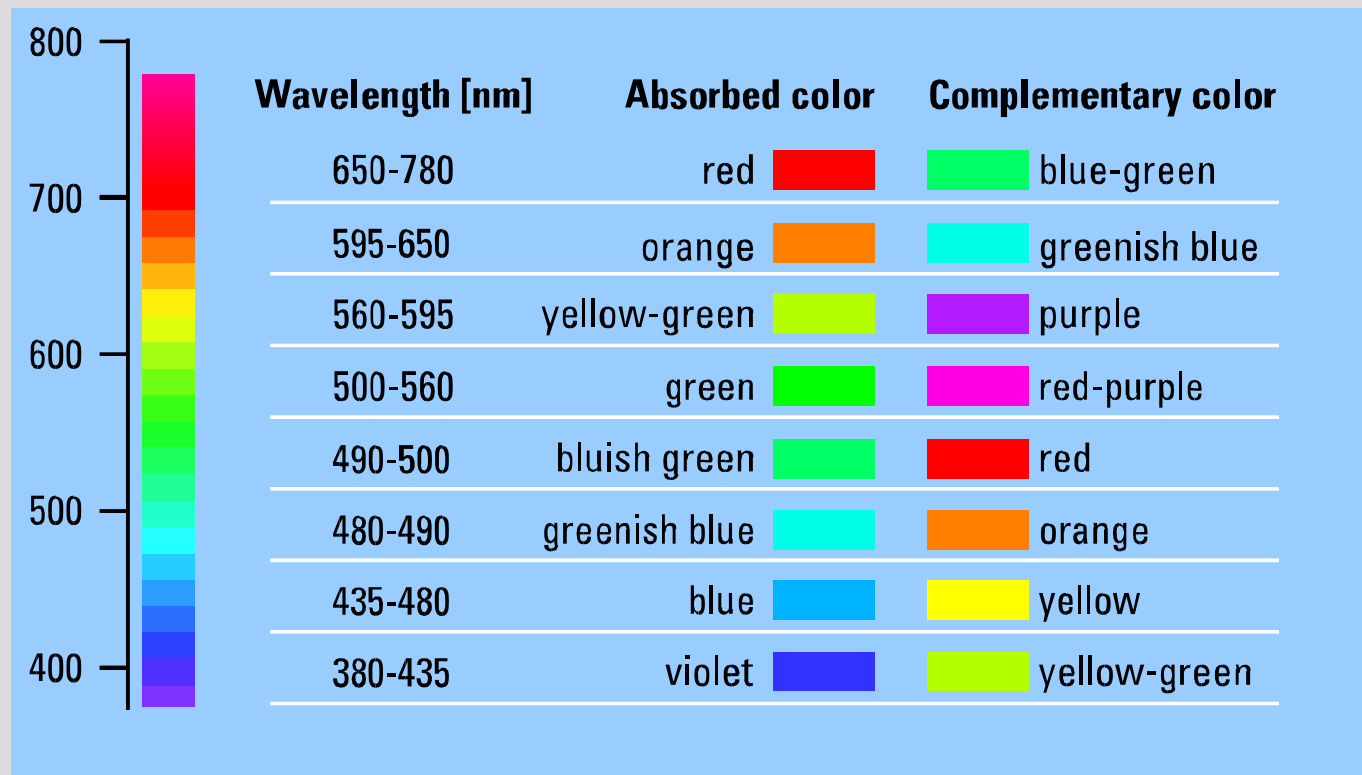

# UV Spectroscopy

- When white (continuum of  $\lambda$ ) light passes through, or is reflected by a surface, those  $\lambda$ s that are absorbed are removed from the transmitted or reflected light respectively
- What is "seen" is the complimentary colors (those that are not absorbed)
- This is the origin of the "color wheel"

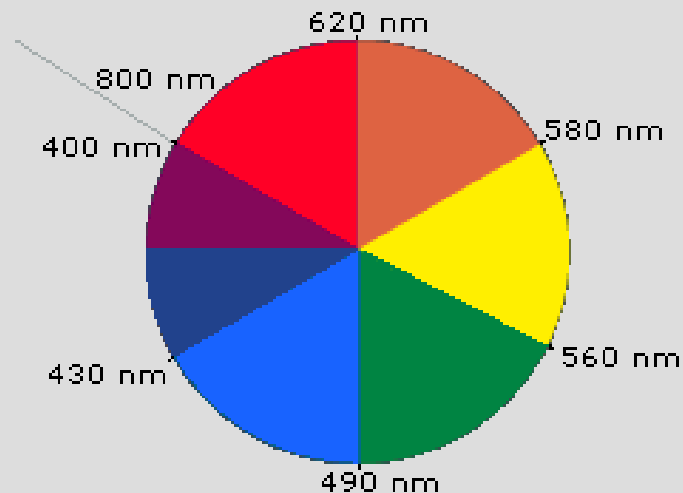



## V. Visible Spectroscopy

### A. Color

#### 1. General

- Organic compounds that are “colored” are typically those with extensively conjugated systems (typically more than five)
- Consider  $\beta$ -carotene

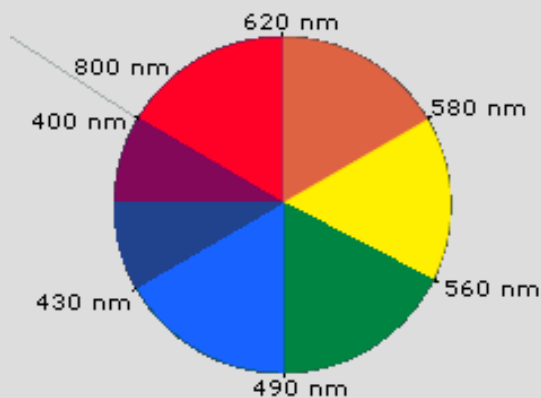
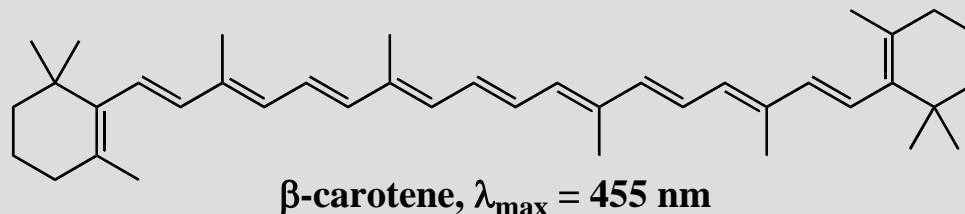

$\lambda_{\max}$  is at 455 – in the far blue region of the spectrum – this is absorbed

The remaining light has the complementary color of orange

# Molecular Spectra

## • Motion & energy of molecules

- Molecules are vibrating and rotating all the time, two main vibration modes being
  - stretching - change in bond length (higher  $\nu$ )
  - bending - change in bond angle (lower  $\nu$ )  
(other possible complex types of stretching & bending are: scissoring / rocking / twisting)
- Molecules are normally at their ground state ( $S_0$ )
  - S (Singlet) - two e-'s spin in pair  $\uparrow\downarrow$
  - T (Triplet) - two e-'s spin parallel  $\uparrow\uparrow$
- Upon exciting molecules can change to high E states ( $S_1, S_2, T_1$  etc.), which are associated with specific levels of energy
- The change from high E states to low ones can be stimulated by absorbing a photon; the change from low to high E states may result in photon emission

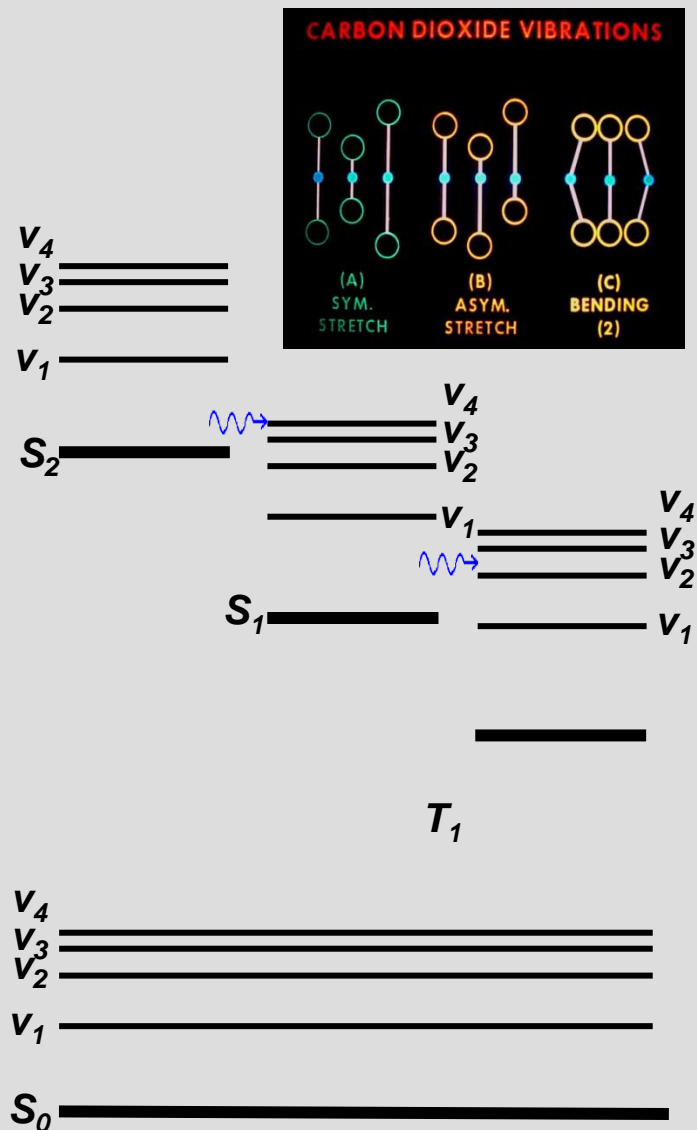

# Singlet vs. triplet

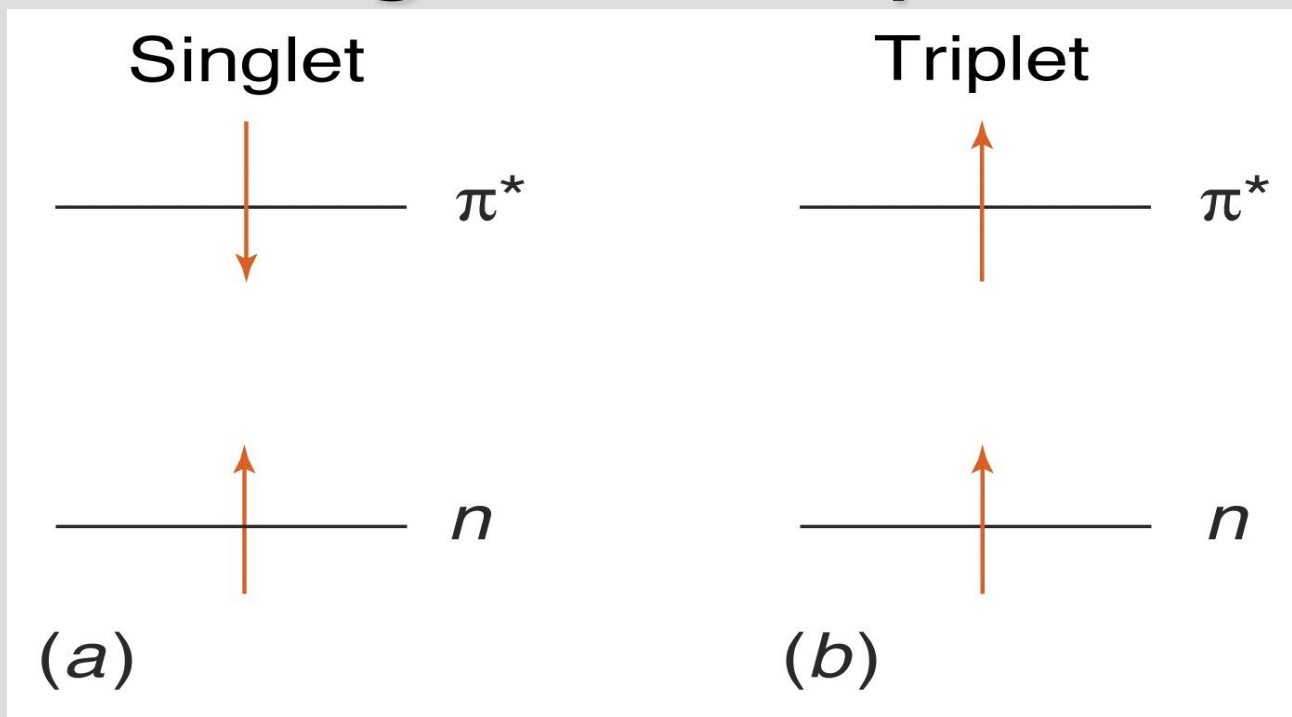

- In these diagrams, one electron has been excited (promoted) from the  $n$  to  $\pi^*$  energy levels (non-bonding to anti-bonding).
- One is a Singlet excited state, the other is a Triplet.

# Molecular Spectra

## • Excitation of a molecule

- The energy levels of a molecule at each state / sub-state are *quantised*
- To excite a molecule from its ground state ( $S_0$ ) to a higher E state ( $S_1, S_2, T_1$  etc.), *the exact amount of energy equal to the difference between the two states has to be absorbed.* (Process A)

i.e. to excite a molecule from  $S_{0,v_1}$  to  $S_{2,v_2}$ , e.m.r with wavenumber  $\nu'$  must be used

$$h\nu' = E_{S_{2,v_2}} - E_{S_{0,v_1}}$$

- The values of energy levels vary with the (molecule of) substance.
- *Molecular absorption spectra* are the measure of the amount of e.m.r., at a specific wavenumber, absorbed by a substance.

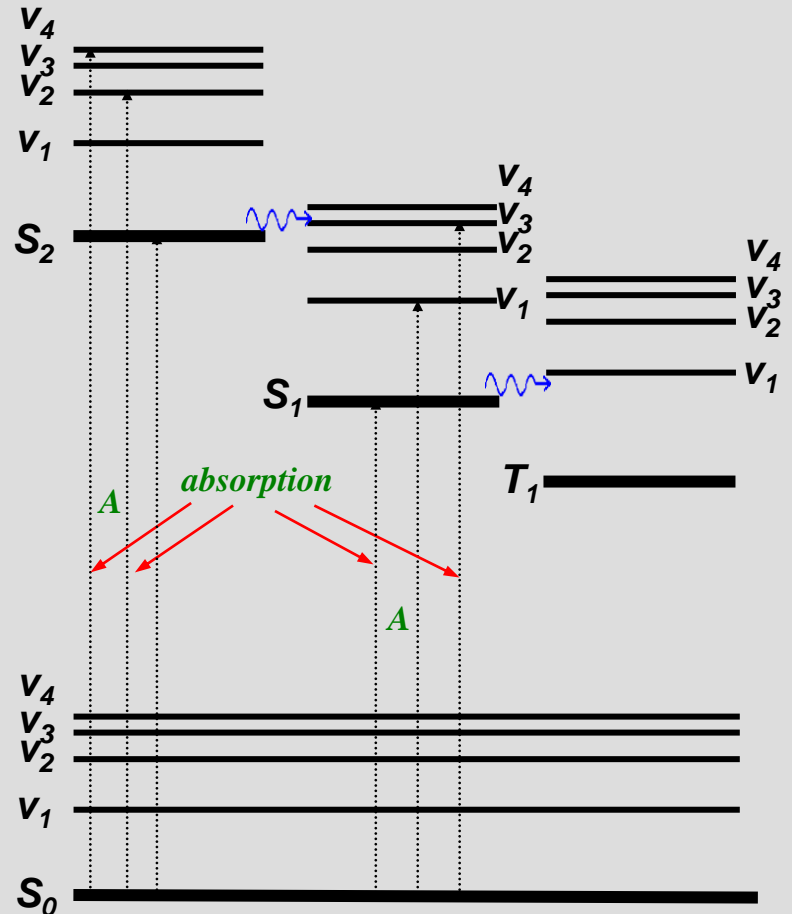

# Molecular Spectra

## • Energy change of excited molecules

An excited molecules can lose its excess energy via several processes

- Process B - Releasing E as *heat* when changing from a sub-state to the parental state occurs within the same state
- The remaining energy can be release by one of following Processes (C, D & E)
- Process C - Transfer its remaining E to other chemical species by collision
- Process D - Emitting photons when falling back to the ground state - *Fluorescence*
- Process E<sub>1</sub> - Undergoing *internal transition* within the same mode of the excited state
- Process E<sub>2</sub> - Undergoing *intersystem crossing* to a triplet sublevel of the excited state
- Process F - Radiating E from triplet to ground state (triplet quenching) - *Phosphorescence*

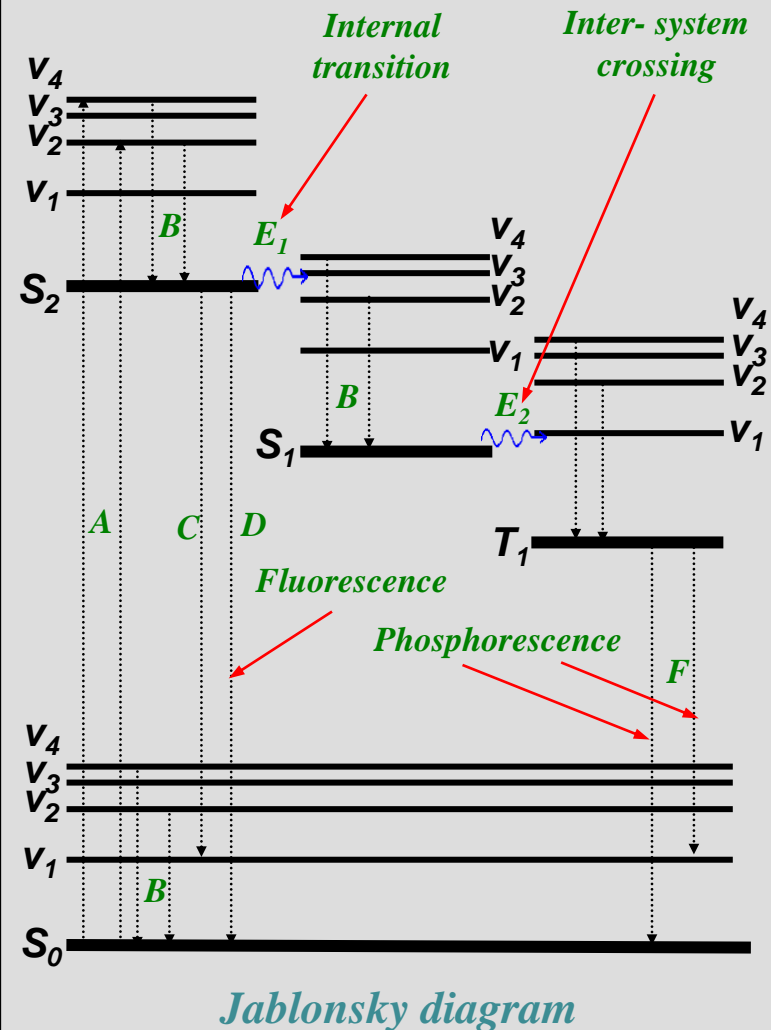

# Molecular Spectra

- **Two types of *molecular emission spectra***

- ***Fluorescence***

- In the case fluorescence the energy emitted can be the same or smaller (if heat is released before radiation) than the corresponding molecular absorption spectra.

e.g. adsorption in UV region - emission in UV or visible region (the wavelength of visible region is longer than that of UV thus less energy)

- Fluorescence can also occur in atomic adsorption spectra
- Fluorescence emission is generally short-lived (e.g.  $\mu\text{s}$ )

- ***Phosphorescence***

- Phosphorescence generally takes much longer to complete (called *metastable*) than fluorescence because of the transition from triplet state to ground state involves altering the e-'s spin. If the emission is in visible light region, the light of excited material fades away gradually

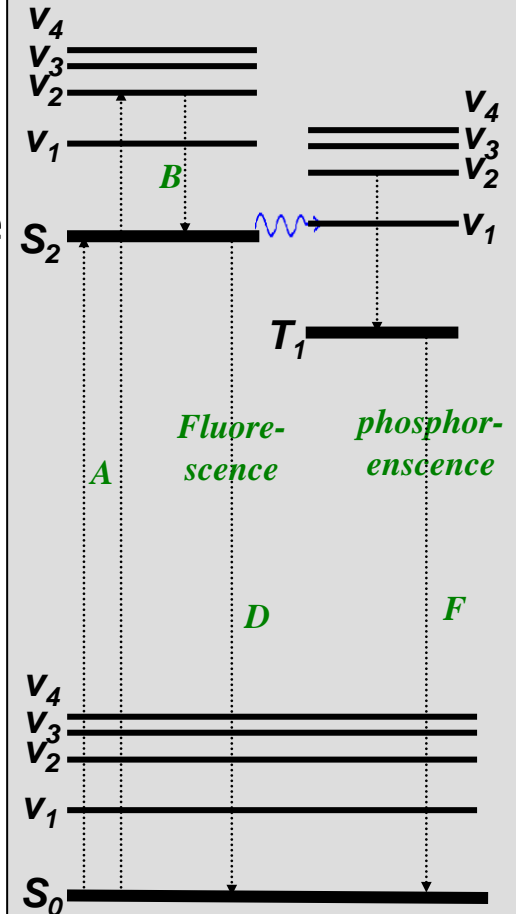

# Atomic Spectra & Molecular Spectra

- **Comparison of atomic and molecular spectra**

	Atomic spectra	Molecular spectra
Adsorption spectra	Yes	Yes
Emission spectra	Yes	Yes
Energy required for excitation	high	low
Change of energy level related to	change of e-'s orbital	change of vibration states
Spectral region	UV	mainly visible
Relative complexity of spectra	simple	complex

- **Quantum mechanics is the basis of atomic & molecular spectra**

- The translational, rotational and vibrational modes of motion of objects of atomic / molecular level are well-explained.

# UV Spectroscopy

- I. Introduction
  - C. Observed electronic transitions
    - 6. Here is a graphical representation

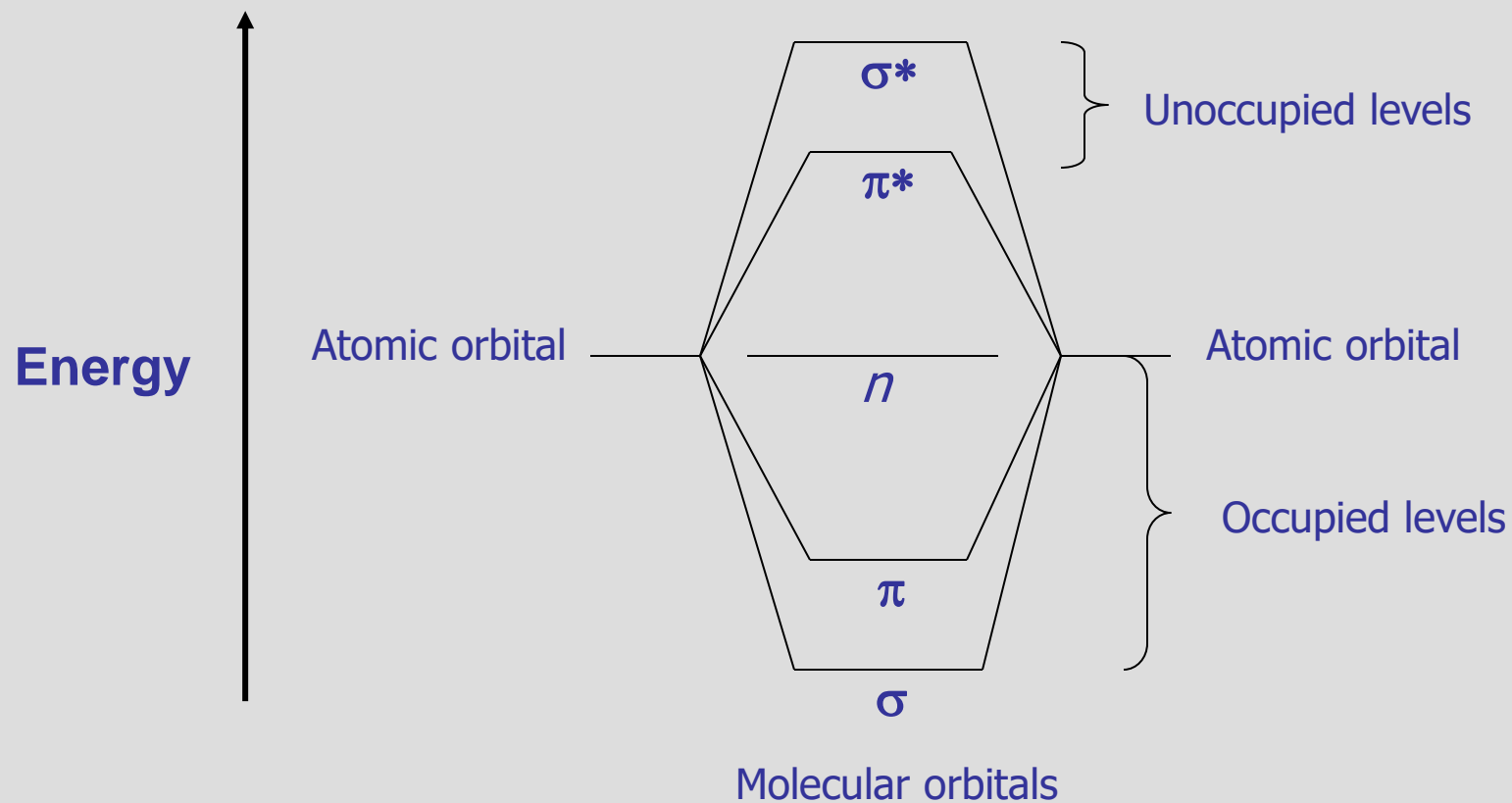



# UV Spectroscopy

## I. Introduction

### C. Observed electronic transitions

7. From the molecular orbital diagram, there are several possible electronic transitions that can occur, each of a different relative energy:

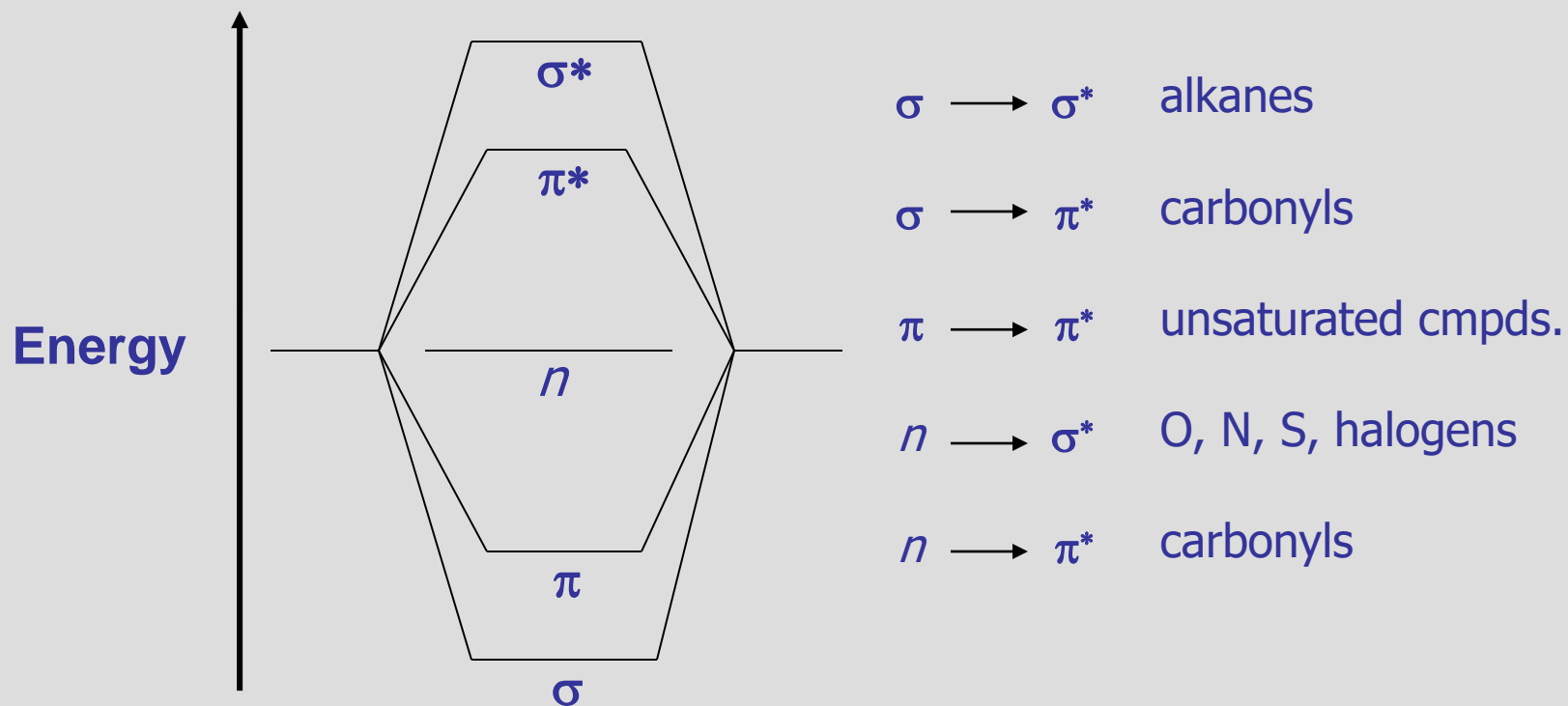

# UV Spectroscopy

## I. Introduction

### C. Observed electronic transitions

7. Although the UV spectrum extends below 100 nm (high energy), oxygen in the atmosphere is not transparent below 200 nm
8. Special equipment to study *vacuum* or *far UV* is required
9. Routine organic UV spectra are typically collected from 200-700 nm
10. This limits the transitions that can be observed:

$\sigma \longrightarrow \sigma^*$	alkanes	150 nm	
$\sigma \longrightarrow \pi^*$	carbonyls	170 nm	
$\pi \longrightarrow \pi^*$	unsaturated cmpds.	180 nm	✓ - if conjugated!
$n \longrightarrow \sigma^*$	O, N, S, halogens	190 nm	
$n \longrightarrow \pi^*$	carbonyls	300 nm	✓

## I. Introduction

### D. Selection Rules

1. Not all transitions that are possible are observed
2. For an electron to transition, certain quantum mechanical constraints apply – these are called “**selection rules**”
3. For example, an electron cannot change its spin quantum number during a transition – these are “**forbidden**”  
Other examples include:
  - the number of electrons that can be excited at one time
  - symmetry properties of the molecule
  - symmetry of the electronic states
4. To further complicate matters, “forbidden” transitions are sometimes observed (albeit at low intensity) due to other factors

## I. Introduction

### E. Band Structure

1. Unlike IR (or later NMR), where there may be upwards of 5 or more resolvable peaks from which to elucidate structural information, UV tends to give wide, overlapping bands
2. It would seem that since the electronic energy levels of a pure sample of molecules would be quantized, fine, discrete bands would be observed – for atomic spectra, this is the case
3. In molecules, when a bulk sample of molecules is observed, not all bonds (read – pairs of electrons) are in the same vibrational or rotational energy states
4. This effect will impact the wavelength at which a transition is observed – very similar to the effect of H-bonding on the O-H vibrational energy levels in neat samples

# UV Spectroscopy

## I. Introduction

### E. Band Structure

- When these energy levels are superimposed, the effect can be readily explained – any transition has the possibility of being observed

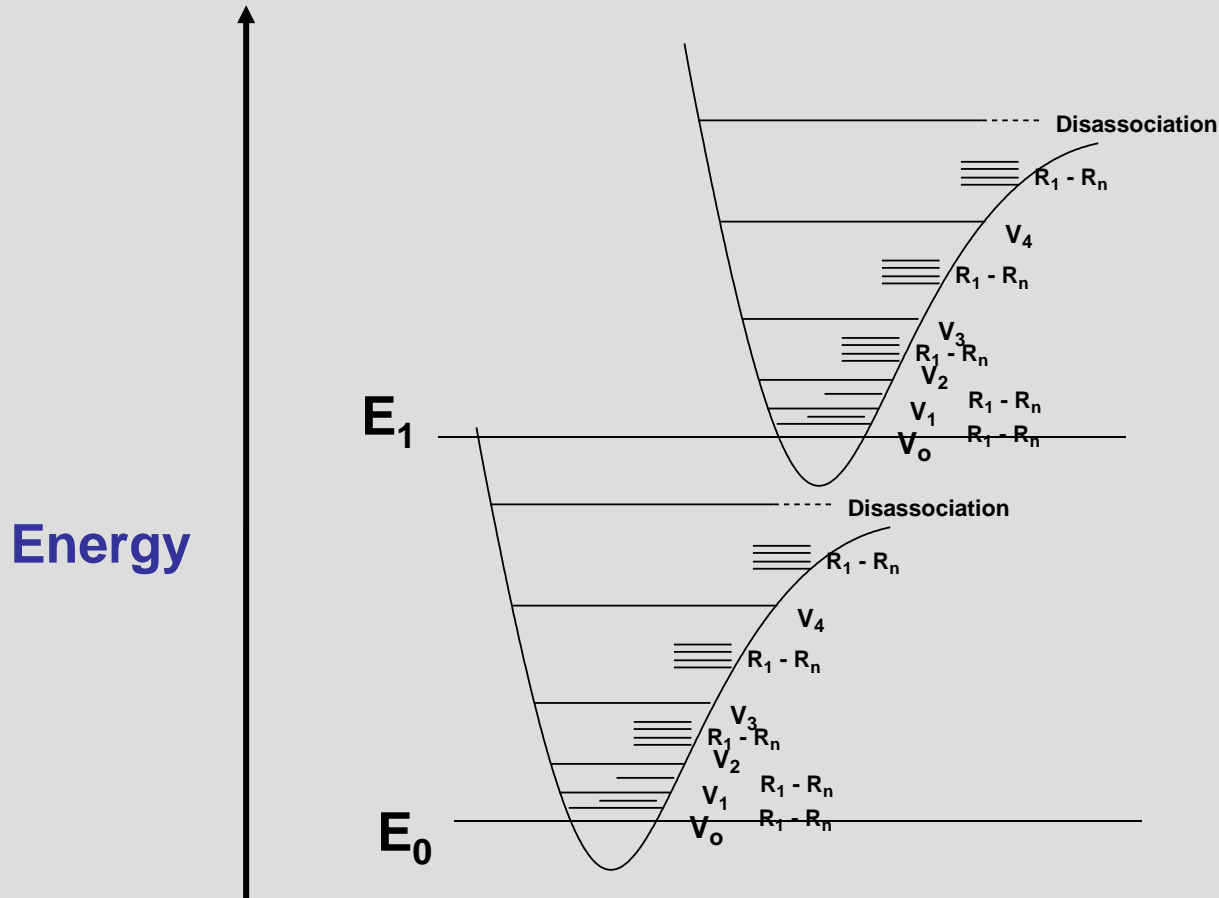

# UV Spectroscopy

## II. Instrumentation and Spectra

### A. Instrumentation

1. The construction of a traditional UV-VIS spectrometer is very similar to an IR, as similar functions – sample handling, irradiation, detection and output are required
2. Here is a simple schematic that covers most modern UV spectrometers:

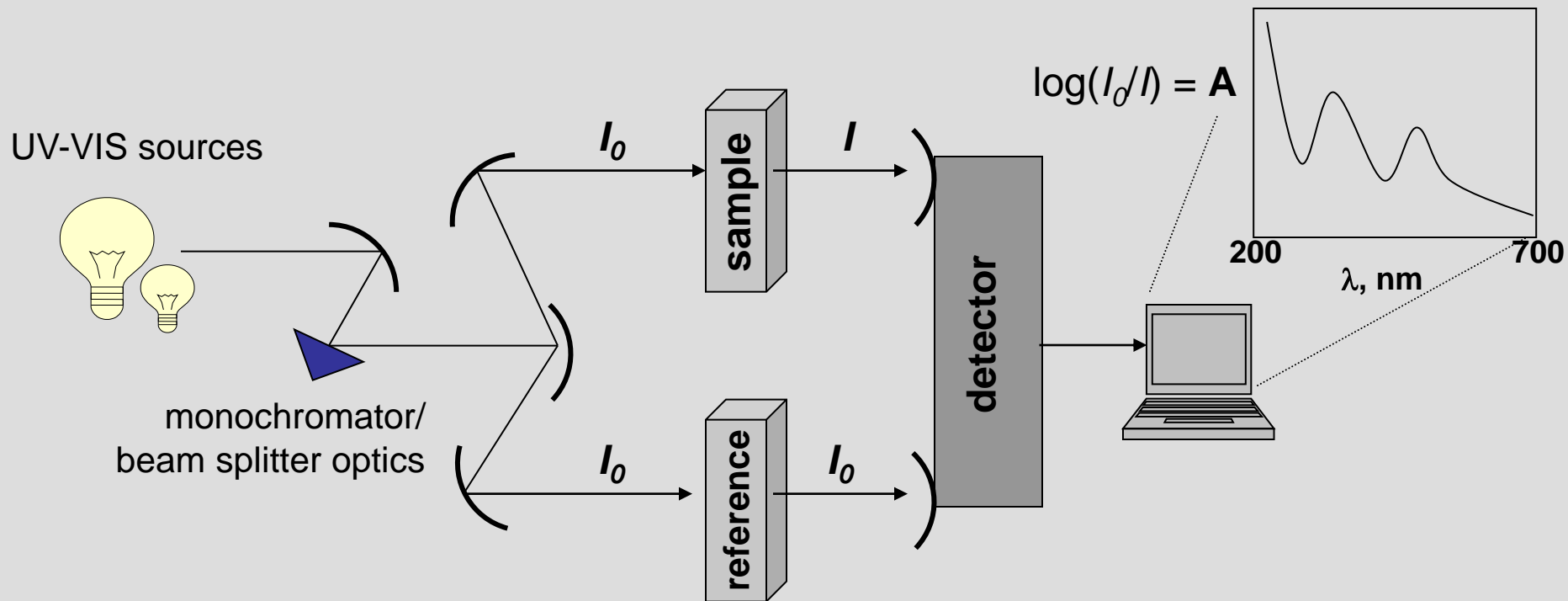

## II. Instrumentation and Spectra

### A. Instrumentation

3. Two sources are required to scan the entire UV-VIS band:
  - Deuterium lamp – covers the UV – 200-330
  - Tungsten lamp – covers 330-700
4. As with the dispersive IR, the lamps illuminate the entire band of UV or visible light; the monochromator (grating or prism) gradually changes the small bands of radiation sent to the beam splitter
5. The beam splitter sends a separate band to a cell containing the sample solution and a reference solution
6. The detector measures the difference between the transmitted light through the sample ( $I$ ) vs. the incident light ( $I_0$ ) and sends this information to the recorder

## II. Instrumentation and Spectra

### A. Instrumentation

7. As with dispersive IR, time is required to cover the entire UV-VIS band due to the mechanism of changing wavelengths
8. A recent improvement is the diode-array spectrophotometer - here a prism (dispersion device) breaks apart the full spectrum transmitted through the sample
9. Each individual band of UV is detected by a individual diodes on a silicon wafer simultaneously – the obvious limitation is the size of the diode, so some loss of resolution over traditional instruments is observed

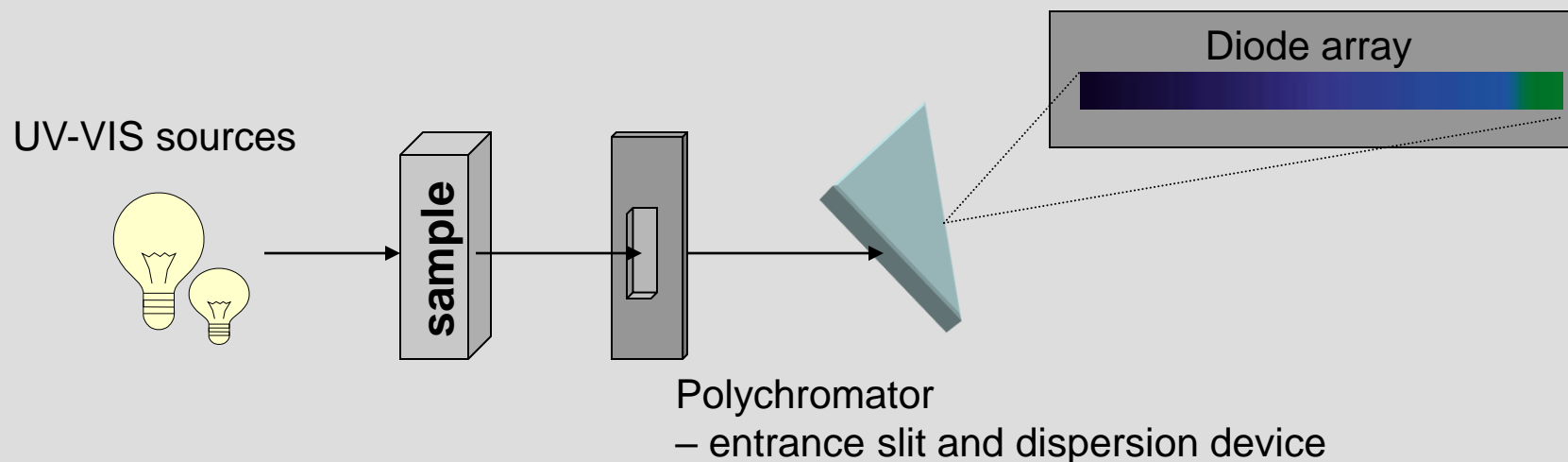



## II. Instrumentation and Spectra

### B. Instrumentation – Sample Handling

1. Virtually all UV spectra are recorded solution-phase
2. Cells can be made of plastic, glass or quartz
3. Only quartz is transparent in the full 200-700 nm range; plastic and glass are only suitable for visible spectra
4. Concentration (we will cover shortly) is empirically determined

A typical sample cell (commonly called a *cuvet*):



## II. Instrumentation and Spectra

### B. Instrumentation – Sample Handling

5. Solvents must be transparent in the region to be observed; the wavelength where a solvent is no longer transparent is referred to as the **cutoff**
6. Since spectra are only obtained up to 200 nm, solvents typically only need to lack conjugated  $\pi$  systems or carbonyls

Common solvents and cutoffs:

acetonitrile	190
chloroform	240
cyclohexane	195
1,4-dioxane	215
95% ethanol	205
<i>n</i> -hexane	201
methanol	205
isooctane	195
water	190

## II. Instrumentation and Spectra

### B. Instrumentation – Sample Handling

7. Additionally solvents must preserve the fine structure (where it is actually observed in UV!) where possible
8. H-bonding further complicates the effect of vibrational and rotational energy levels on electronic transitions, dipole-dipole interacts less so
9. The more non-polar the solvent, the better (this is not always possible)

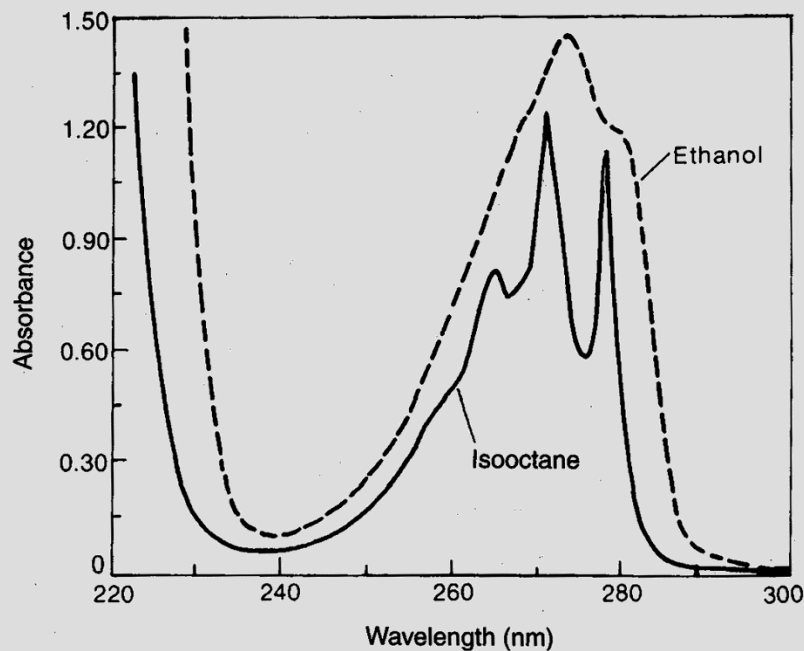

## II. Instrumentation and Spectra

### C. The Spectrum

1. The x-axis of the spectrum is in wavelength; 200-350 nm for UV, 200-700 for UV-VIS determinations
2. Due to the lack of any fine structure, spectra are rarely shown in their raw form, rather, the peak maxima are simply reported as a numerical list of "lambda max" values or  $\lambda_{\text{max}}$

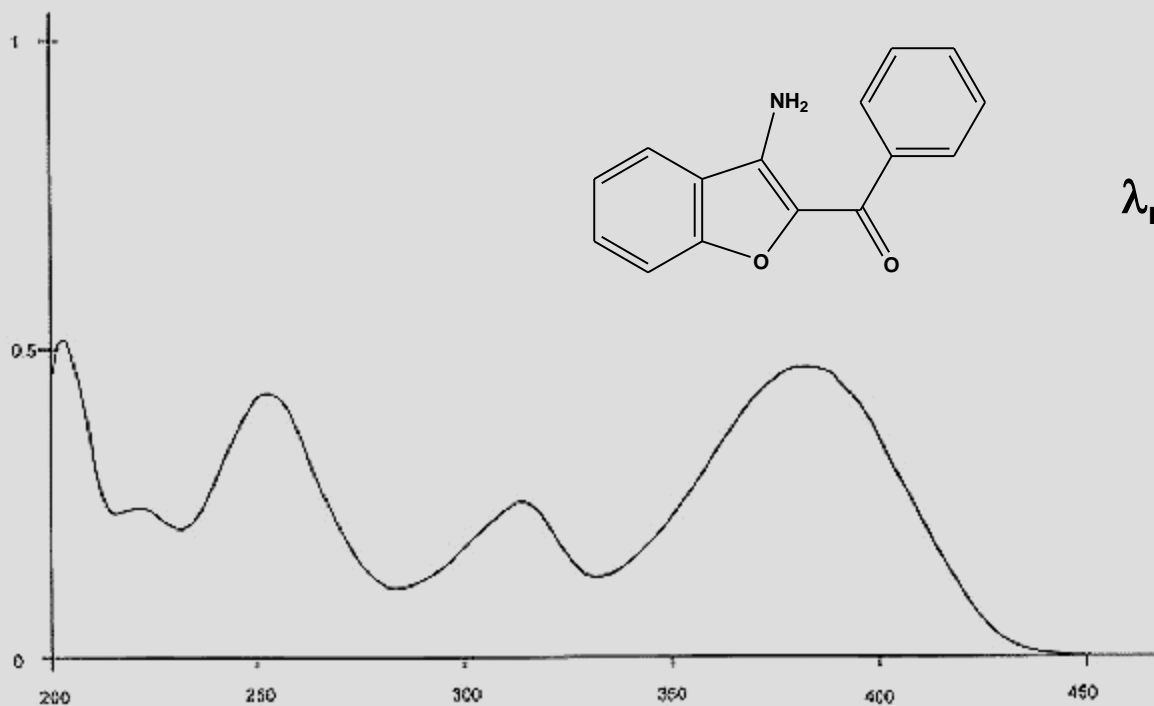

$\lambda_{\text{max}} =$   
**206 nm**  
**252**  
**317**  
**376**

## II. Instrumentation and Spectra

### C. The Spectrum

1. The y-axis of the spectrum is in absorbance,  $A$
2. From the spectrometers point of view, absorbance is the inverse of transmittance:  $A = \log_{10} (I_0/I)$
3. From an experimental point of view, three other considerations must be made:
  - i. a longer *path length*,  $l$  through the sample will cause more UV light to be absorbed – linear effect
  - ii. the greater the *concentration*,  $c$  of the sample, the more UV light will be absorbed – linear effect
  - iii. some electronic transitions are more effective at the absorption of photon than others – *molar absorptivity*,  $\epsilon$   
*this may vary by orders of magnitude...*

## II. Instrumentation and Spectra

### III. The Spectrum

4. These effects are combined into the Beer-Lambert Law:  $A = \epsilon c l$
5. for most UV spectrometers,  $l$  would remain constant (standard cells are typically 1 cm in path length)
6. concentration is typically varied depending on the strength of absorption observed or expected – typically dilute – sub 0.001 mol/L
7. molar absorptivities vary by orders of magnitude:
- values of  $10^4$ - $10^6$  are termed *high intensity absorptions*
  - values of  $10^3$ - $10^4$  are termed *low intensity absorptions*
  - values of 0 to  $10^3$  are the absorptions of *forbidden transitions*

$A$  is unitless, so the units for  $\epsilon$  are  $\text{cm}^{-1} \cdot (\text{mol/L})^{-1}$  and are rarely expressed

5. Since path length and concentration effects can be easily factored out, absorbance simply becomes proportional to  $\epsilon$ , and the y-axis is expressed as  $\epsilon$  directly or as the logarithm of  $\epsilon$

## III. Chromophores

### B. Organic Chromophores

1. **Alkanes** – only possess  $\sigma$ -bonds and no lone pairs of electrons, so only the high energy  $\sigma \rightarrow \sigma^*$  transition is observed in the far UV

This transition is destructive to the molecule, causing cleavage of the  $\sigma$ -bond

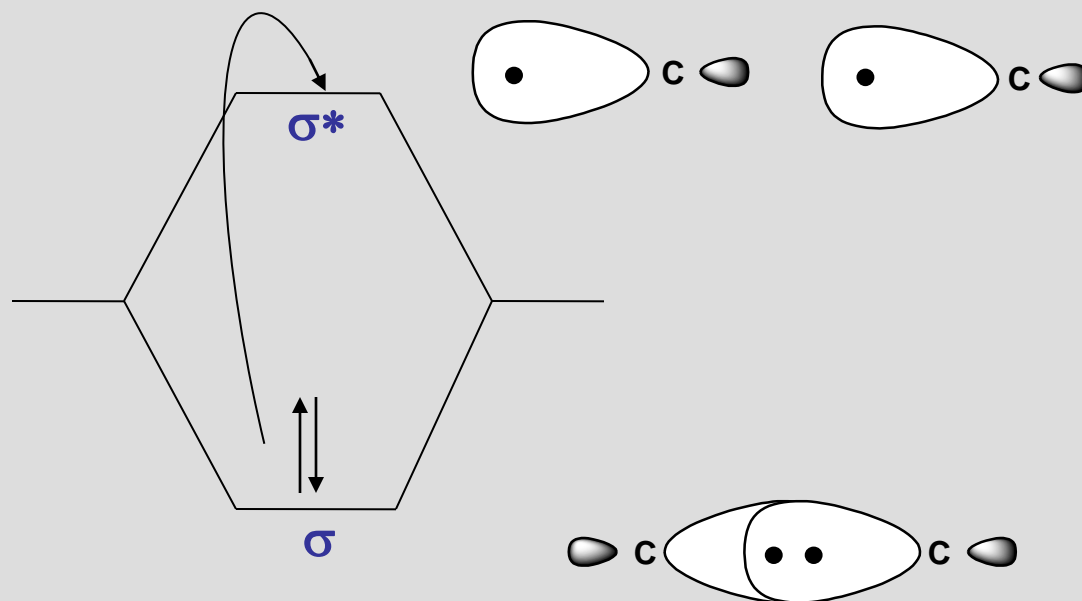

## III. Chromophores

### B. Organic Chromophores

3. Alkenes and Alkynes – in the case of isolated examples of these compounds the  $\pi \rightarrow \pi^*$  is observed at 175 and 170 nm, respectively

Even though this transition is of lower energy than  $\sigma \rightarrow \sigma^*$ , it is still in the far UV – however, the transition energy is sensitive to substitution

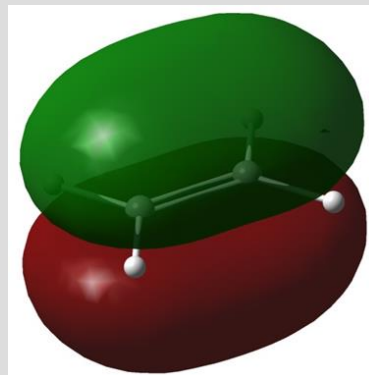
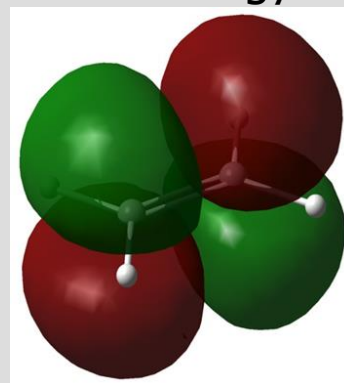
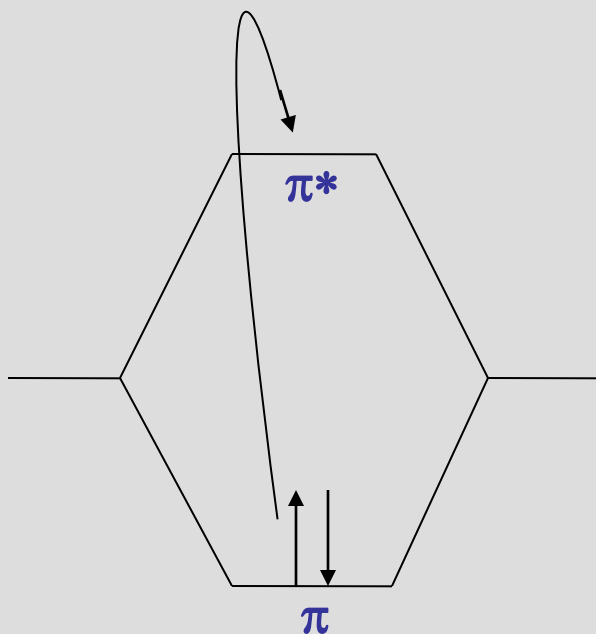

*$\pi \rightarrow \pi^*$  transitions responsible for ethylene UV absorption at ~170 nm calculated with ZINDO semi-empirical excited-states methods*



## III. Chromophores

### B. Organic Chromophores

2. Alcohols, ethers, amines and sulfur compounds – in the cases of simple, aliphatic examples of these compounds the  $n \rightarrow \sigma^*$  is the most often observed transition; like the alkane  $\sigma \rightarrow \sigma^*$  it is most often at shorter  $\lambda$  than 200 nm

Note how this transition occurs from the HOMO to the LUMO

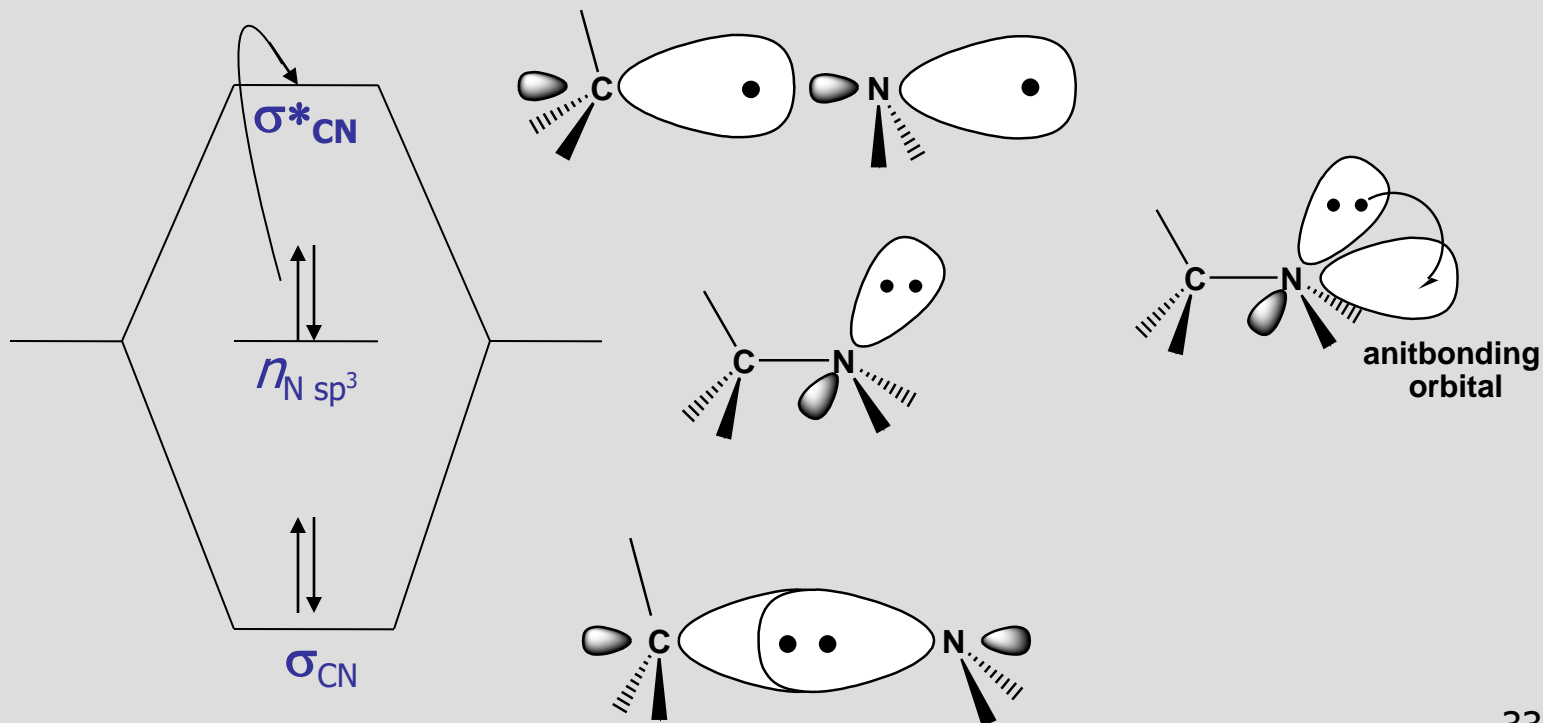

# ESPECTROSCOPIA NO ULTRAVIOLETA / VISÍVEL

## Exemplo de espectro

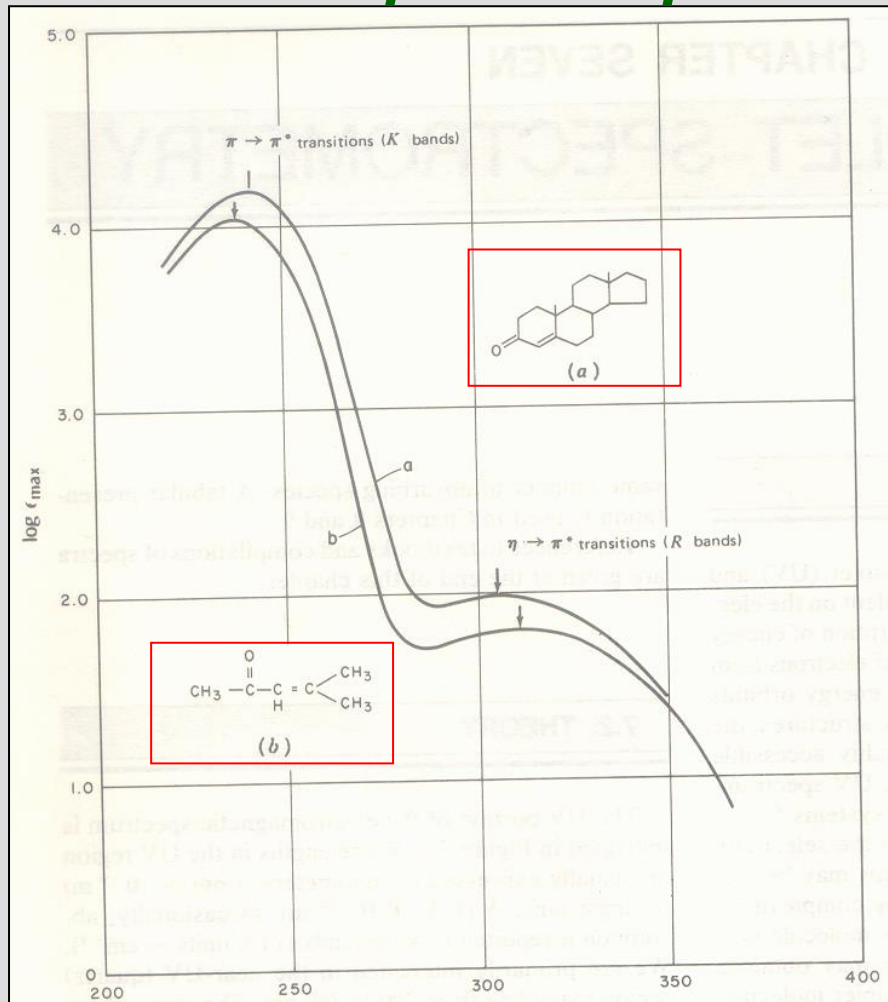

Abs vs  $\lambda$   
Log  $\epsilon$  vs  $\lambda$

**Absorção no UV/VIS  
se deve ao grupo  
cromóforo**

## III. Chromophores

### B. Organic Chromophores

4. **Carbonyls** – unsaturated systems incorporating N or O can undergo  $n \rightarrow \pi^*$  transitions ( $\sim 285$  nm) in addition to  $\pi \rightarrow \pi^*$

Despite the fact this transition is forbidden by the selection rules ( $\epsilon = 15$ ), it is the most often observed and studied transition for carbonyls

This transition is also sensitive to substituents on the carbonyl

Similar to alkenes and alkynes, non-substituted carbonyls undergo the  $\pi \rightarrow \pi^*$  transition in the vacuum UV (188 nm,  $\epsilon = 900$ ); sensitive to substitution effects

## III. Chromophores

### B. Organic Chromophores

#### 4. Carbonyls – $n \rightarrow \pi^*$ transitions ( $\sim 285$ nm); $\pi \rightarrow \pi^*$ (188 nm)

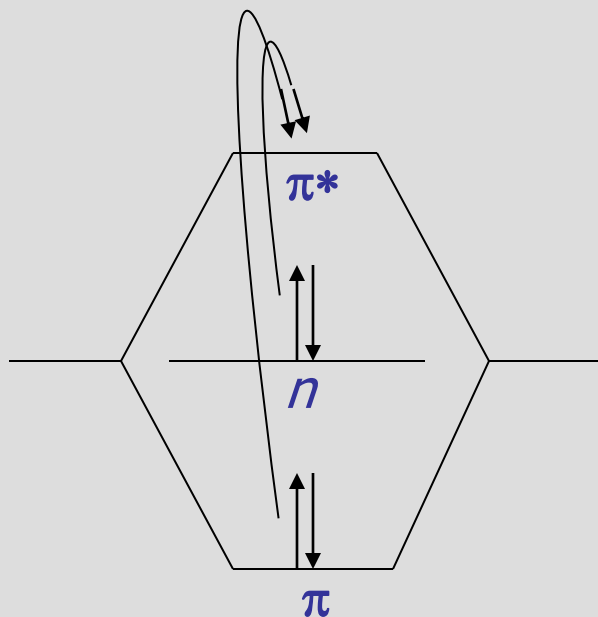

$\sigma_{CO}$  transitions omitted for clarity

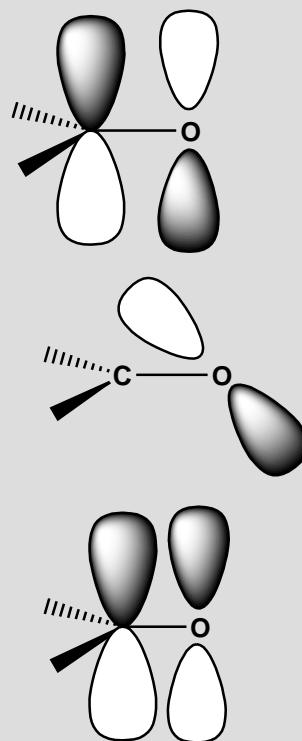

It has been determined from spectral studies, that carbonyl oxygen more approximates  $sp$  rather than  $sp^2$  !

## III. Chromophores

### C. Substituent Effects

**General** – from our brief study of these general chromophores, only the weak  $n \rightarrow \pi^*$  transition occurs in the routinely observed UV

The attachment of substituent groups (other than H) can shift the energy of the transition

Substituents that increase the intensity and often wavelength of an absorption are called *auxochromes*

Common auxochromes include alkyl, hydroxyl, alkoxy and amino groups and the halogens

## III. Chromophores

### C. Substituent Effects

**General** – Substituents may have any of four effects on a chromophore

- i. **Bathochromic shift** (red shift) – a shift to longer  $\lambda$ ; lower energy
- ii. **Hypsochromic shift** (blue shift) – shift to shorter  $\lambda$ ; higher energy
- iii. **Hyperchromic effect** – an increase in intensity
- iv. **Hypochromic effect** – a decrease in intensity

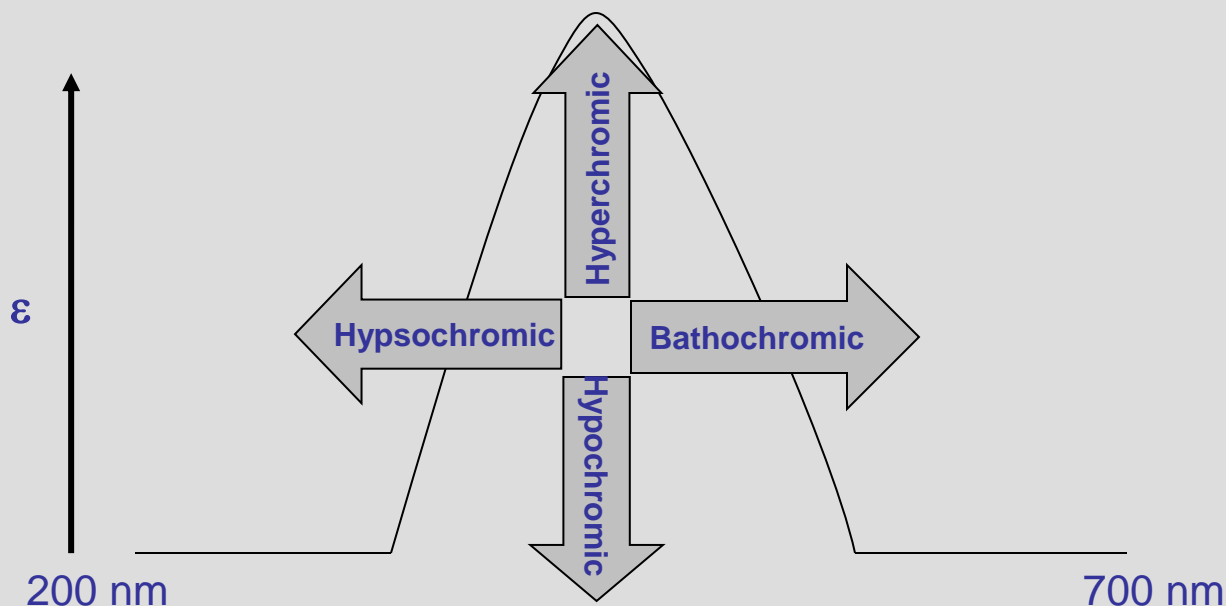

# Efeitos dos solventes

## Aumento da polaridade do solvente:

deslocamento do máximo da banda de absorção para o vermelho (isto é para comprimentos de onda maiores): energias menores.

## Modelo:

$\pi^*$  é mais estabilizado do que  $\pi$  pelo aumento da polaridade do solvente.

Conseqüência:

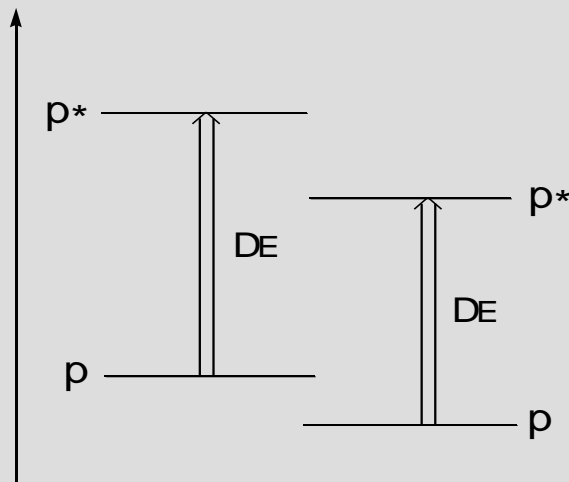

## Aumento da polaridade do solvente:

deslocamento do máximo da banda de absorção  $\pi$ ,  $\pi^*$  para o **vermelho** (isto é para comprimentos de onda maiores): *energias menores*.

deslocamento do máximo da banda de absorção  $n$ ,  $\pi^*$  para o **azul** (isto é para comprimentos de onda menores): *energias maiores*.

$\pi^*$  é mais estabilizado do que  $\pi$   
 $n$  é mais estabilizado do que  $\pi^*$

transição  $\pi \rightarrow \pi^*$

deslocamento batocrômico

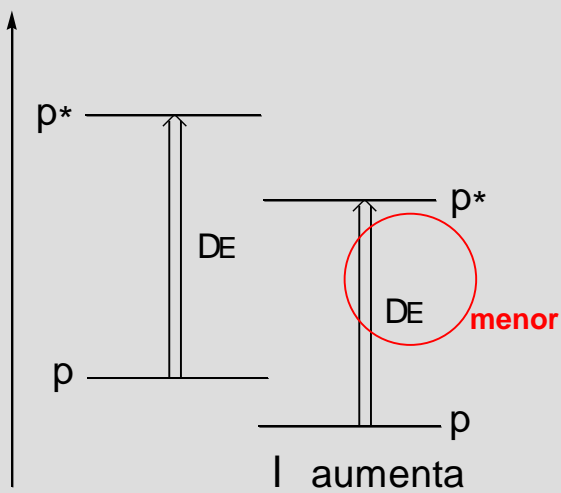

polaridade do solvente

transição  $n \rightarrow \pi^*$

deslocamento hipsocrômico

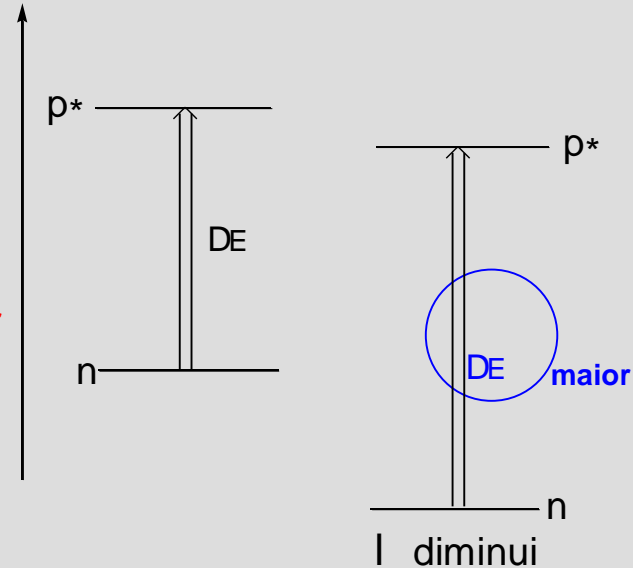

polaridade do solvente



**Modelo:** como



## III. Chromophores

### C. Substituent Effects

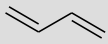
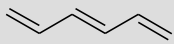
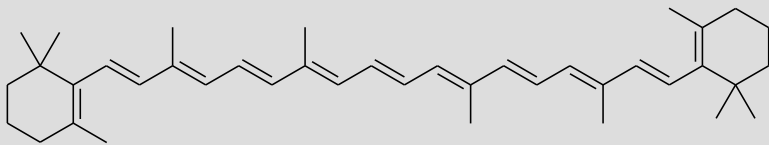
1. **Conjugation** – most efficient means of bringing about a bathochromic and hyperchromic shift of an unsaturated chromophore:

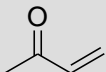
$\text{H}_2\text{C}=\text{CH}_2$		$\lambda_{\text{max}}$ nm	$\epsilon$
		175	15,000
		217	21,000
		258	35,000
		465	125,000
	<b><math>\beta</math>-carotene</b>		
	$n \rightarrow \pi^*$	280	12
	$\pi \rightarrow \pi^*$	189	900
	$n \rightarrow \pi^*$	280	27
	$\pi \rightarrow \pi^*$	213	7,100

## III. Chromophores

### C. Substituent Effects

#### 1. Conjugation – Alkenes

The observed shifts from conjugation imply that an increase in conjugation decreases the energy required for electronic excitation

From molecular orbital (MO) theory two atomic  $p$  orbitals,  $\phi_1$  and  $\phi_2$  from two  $sp^2$  hybrid carbons combine to form two MOs  $\Psi_1$  and  $\Psi_2^*$  in ethylene

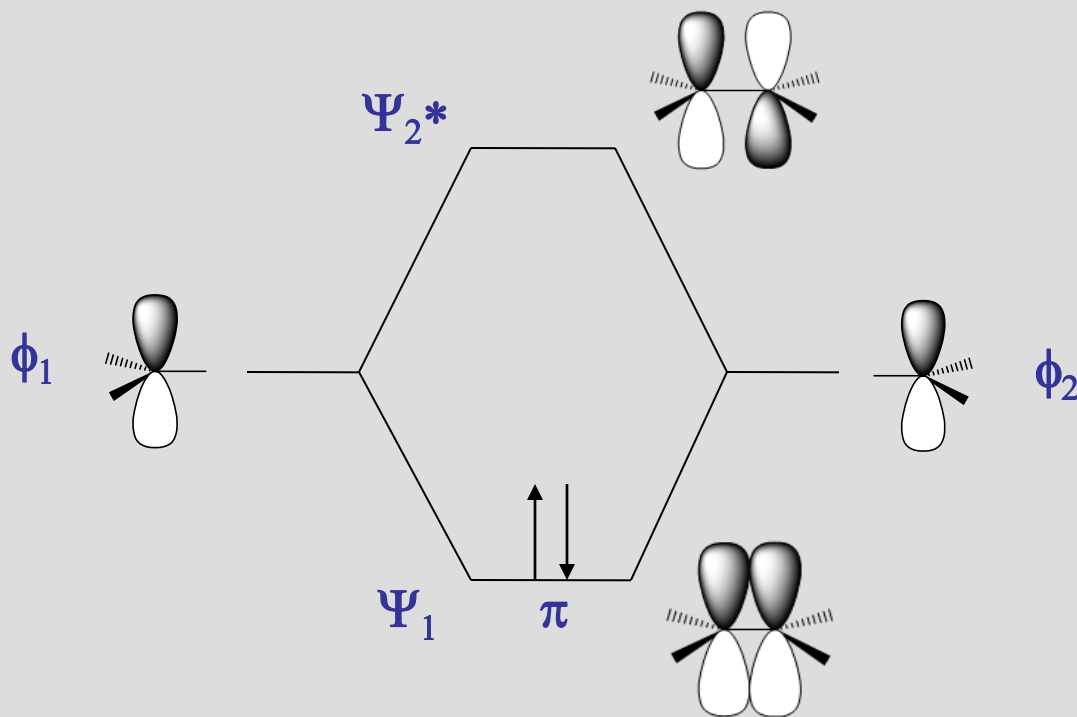

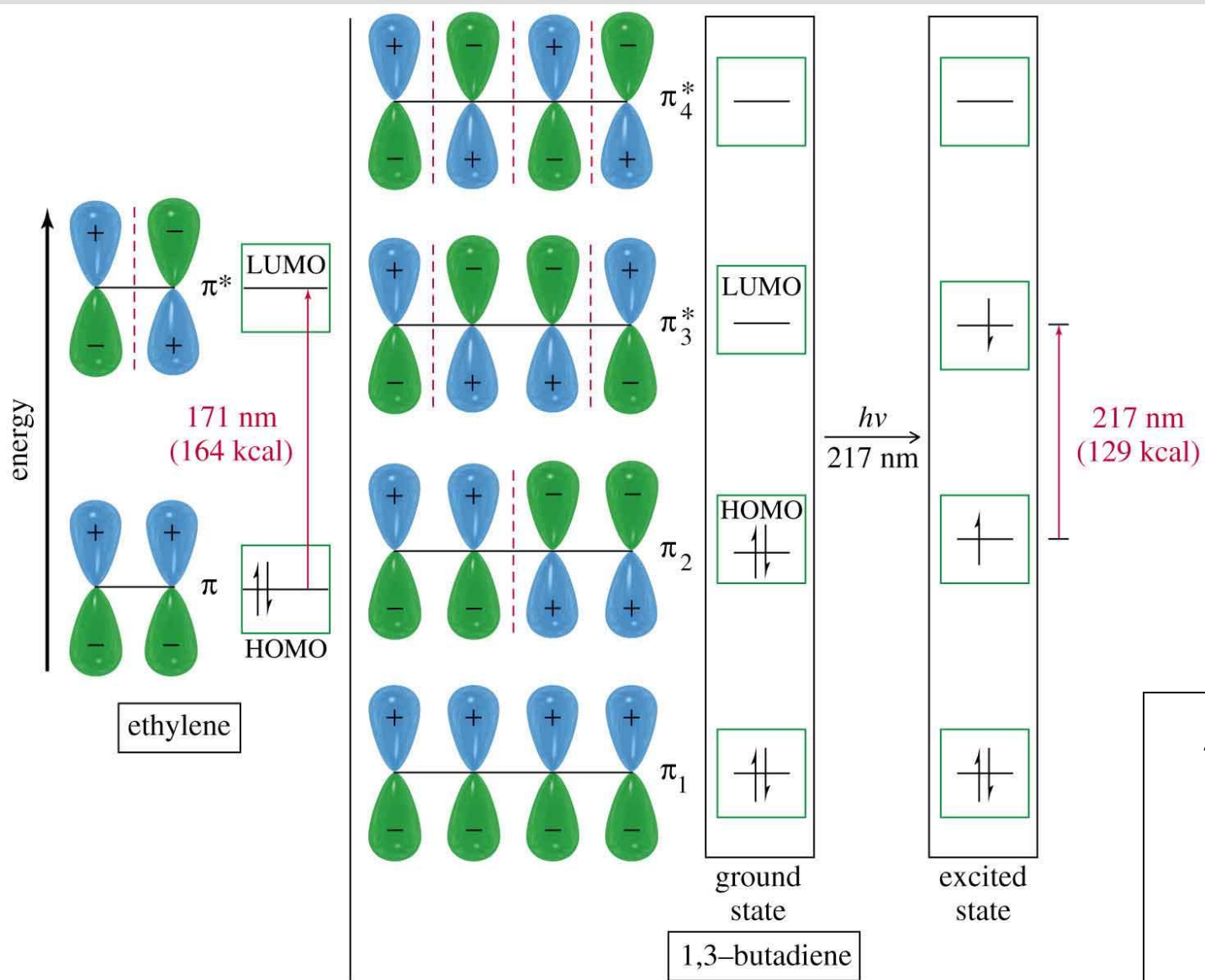

$\pi \rightarrow \pi^*$  for  
ethylene  
and  
butadiene

## III. Chromophores

### C. Substituent Effects

#### 2. Conjugation – Alkenes

Extending this effect out to longer conjugated systems the energy gap becomes progressively smaller:

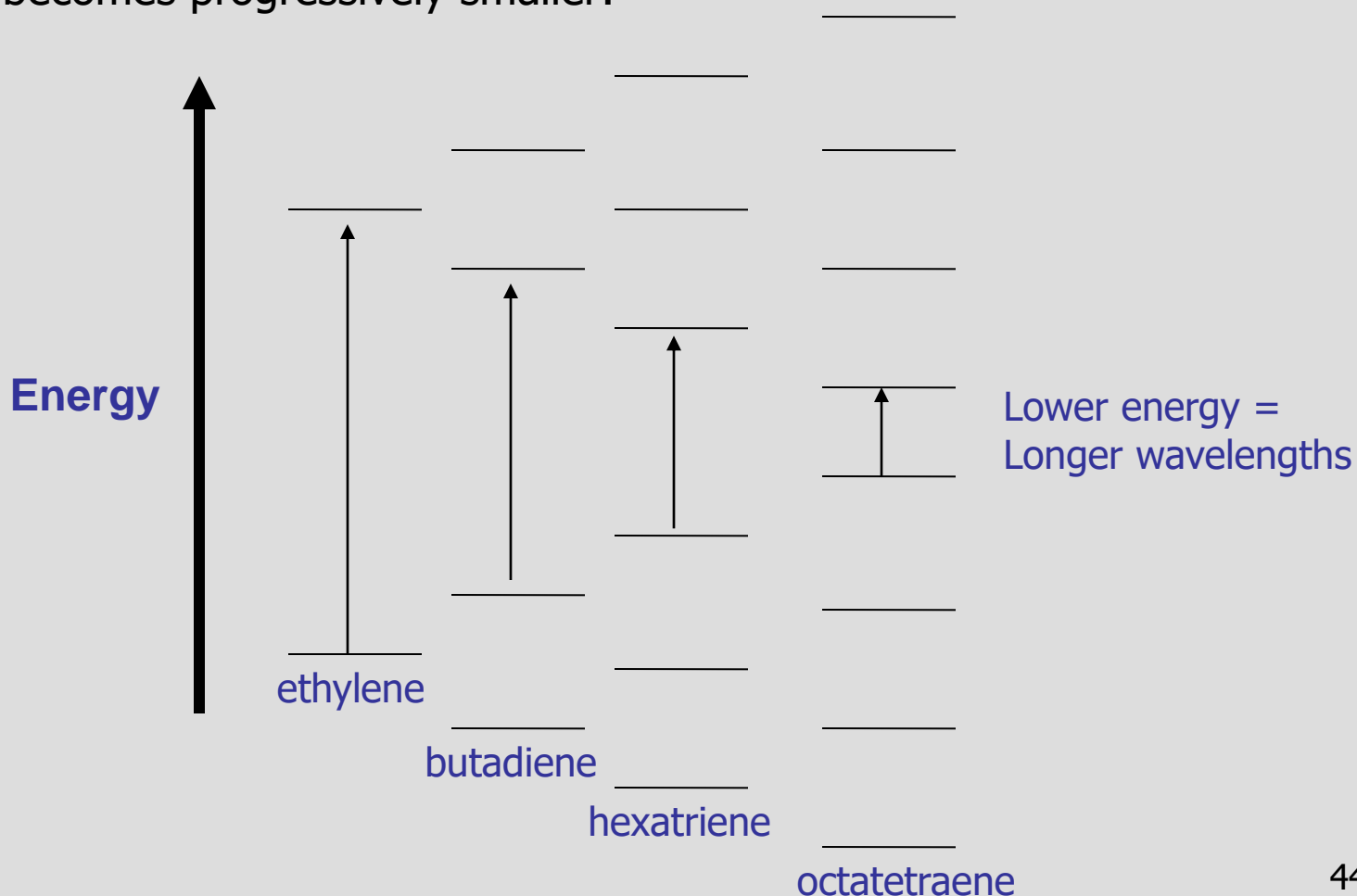

## III. Chromophores

### C. Substituent Effects

#### 2. Conjugation – Alkenes

Similarly, the lone pairs of electrons on N, O, S, X can extend conjugated systems – auxochromes

Here we create 3 MOs – this interaction is not as strong as that of a conjugated  $\pi$ -system

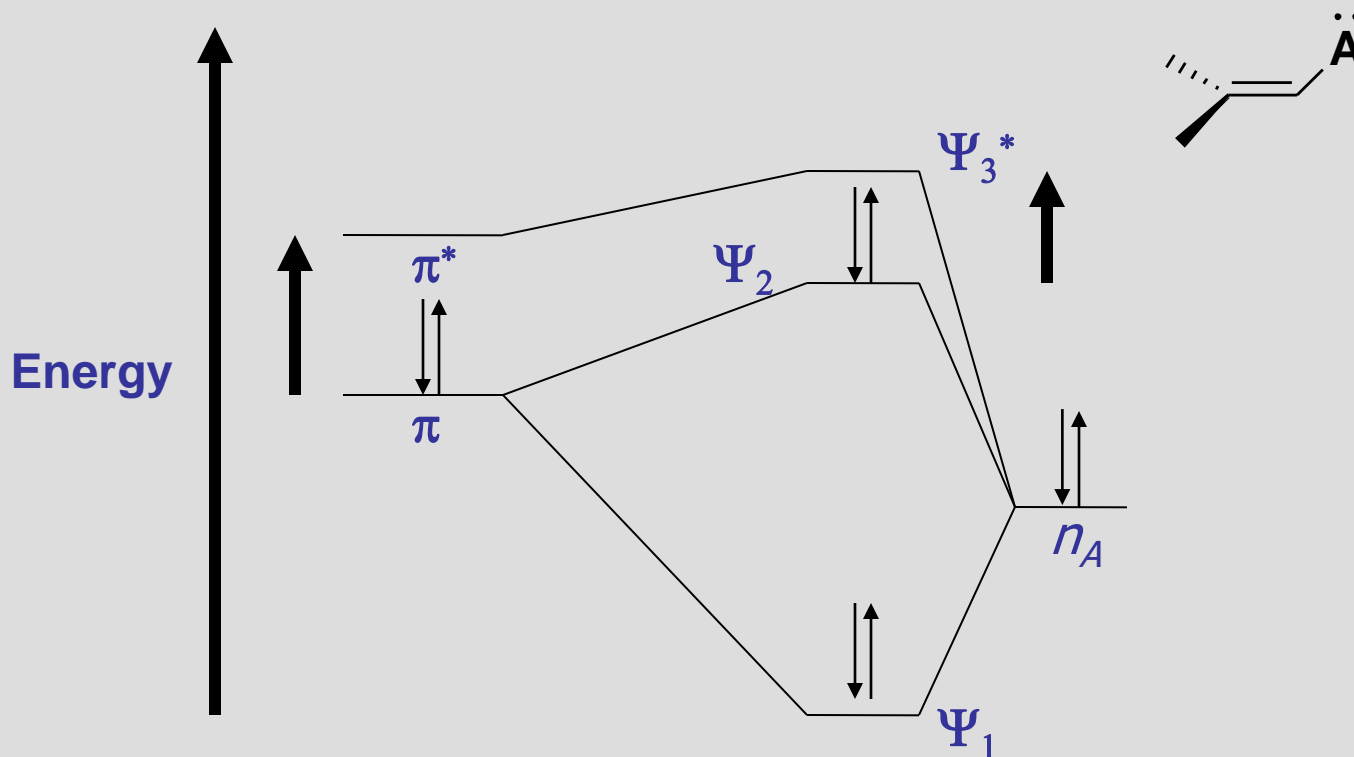

## III. Chromophores

### C. Substituent Effects

#### 2. Conjugation – Alkenes

Methyl groups also cause a bathochromic shift, even though they are devoid of  $\pi$ - or  $n$ -electrons

This effect is thought to be through what is termed “hyperconjugation” or sigma bond resonance

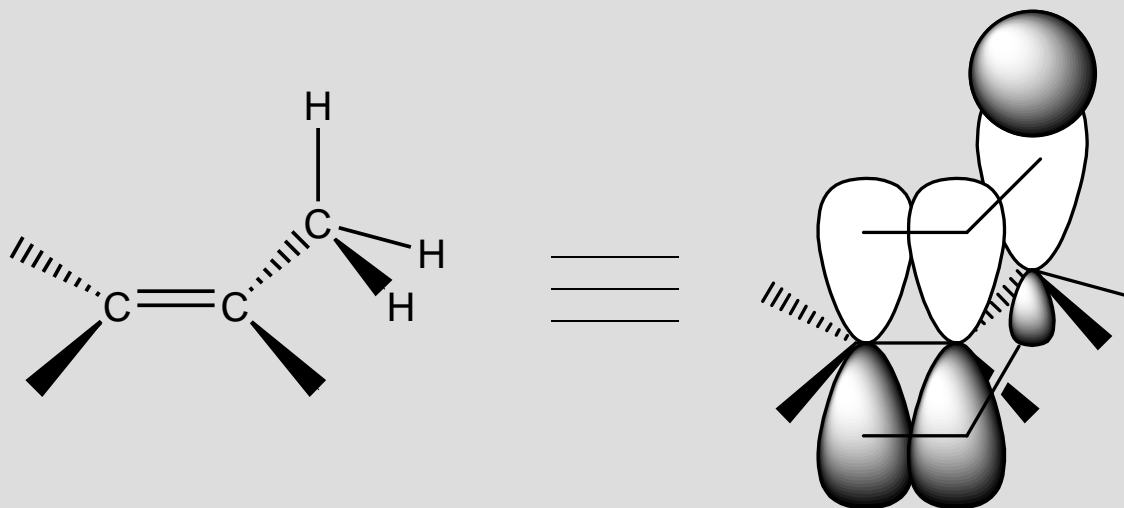

Next time – We will find that the effect of substituent groups can be reliably quantified from empirical observation of known conjugated structures and applied to new systems

This quantification is referred to as the Woodward-Fieser Rules which we will apply to three specific chromophores:

1. Conjugated dienes
2. Conjugated dienones
3. Aromatic systems

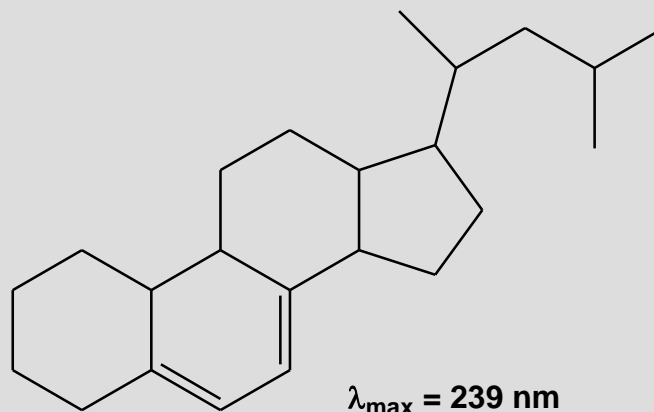

## IV. Structure Determination

### A. Dienes

#### 1. General Features

For acyclic butadiene, two conformers are possible – *s-cis* and *s-trans*

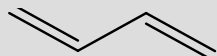

***s-trans***

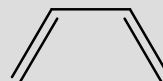

***s-cis***

The *s-cis* conformer is at an overall higher potential energy than the *s-trans*; therefore the HOMO electrons of the conjugated system have less of a jump to the LUMO – lower energy, longer wavelength



## IV. Structure Determination

### A. Dienes

#### 1. General Features

Two possible  $\pi \rightarrow \pi^*$  transitions can occur for butadiene  $\Psi_2 \rightarrow \Psi_3^*$  and  $\Psi_2 \rightarrow \Psi_4^*$

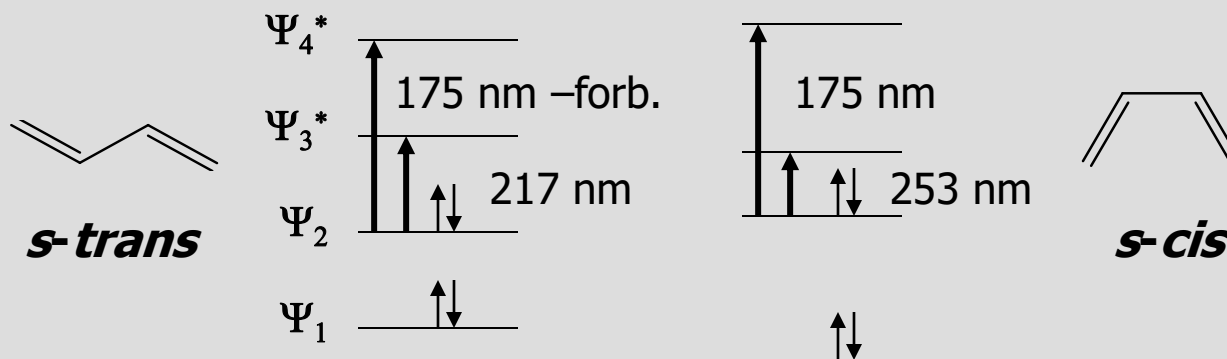

The  $\Psi_2 \rightarrow \Psi_4^*$  transition is not typically observed:

- The energy of this transition places it outside the region typically observed – 175 nm
- For the more favorable *s-trans* conformation, this transition is forbidden

The  $\Psi_2 \rightarrow \Psi_3^*$  transition is observed as an intense absorption

## IV. Structure Determination

### A. Dienes

#### 1. General Features

The  $\Psi_2 \rightarrow \Psi_3^*$  transition is observed as an intense absorption ( $\epsilon = 20,000+$ ) based at 217 nm within the observed region of the UV

While this band is insensitive to solvent (as would be expected) it is subject to the bathochromic and hyperchromic effects of alkyl substituents as well as further conjugation

Consider:

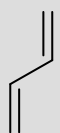

$\lambda_{\max} = 217$



253

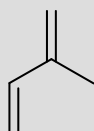

220

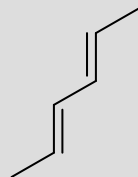

227

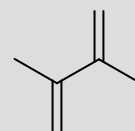

227

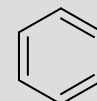

256

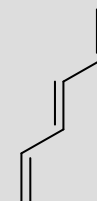

263 nm

## IV. Structure Determination

### A. Dienes

#### 2. Woodward-Fieser Rules

Woodward and the Fiesers performed extensive studies of terpene and steroidal alkenes and noted similar substituents and structural features would predictably lead to an empirical prediction of the wavelength for the lowest energy  $\pi \rightarrow \pi^*$  electronic transition

This work was distilled by Scott in 1964 into an extensive treatise on the Woodward-Fieser rules in combination with comprehensive tables and examples – (A.I. Scott, *Interpretation of the Ultraviolet Spectra of Natural Products*, Pergamon, NY, 1964)

A more modern interpretation was compiled by Rao in 1975 – (C.N.R. Rao, *Ultraviolet and Visible Spectroscopy*, 3<sup>rd</sup> Ed., Butterworths, London, 1975)

## IV. Structure Determination

### A. Dienes

#### 2. Woodward-Fieser Rules - Dienes

The rules begin with a base value for  $\lambda_{\max}$  of the chromophore being observed:



acyclic butadiene = 217 nm

The incremental contribution of substituents is added to this base value from the group tables:

Group	Increment
Extended conjugation	+30
Each exo-cyclic C=C	+5
Alkyl	+5
-OCOCH <sub>3</sub>	+0
-OR	+6
-SR	+30
-Cl, -Br	+5
-NR <sub>2</sub>	+60

## IV. Structure Determination

### A. Dienes

#### 2. Woodward-Fieser Rules - Dienes

For example:

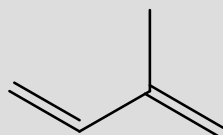

Isoprene - acyclic butadiene =	217 nm
one alkyl subs.	<u>+ 5 nm</u>
	222 nm
Experimental value	220 nm

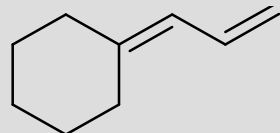

Allylidencyclohexane	
- acyclic butadiene =	217 nm
one exocyclic C=C	+ 5 nm
2 alkyl subs.	<u>+10 nm</u>
	232 nm
Experimental value	237 nm

## IV. Structure Determination

### A. Dienes

#### 3. Woodward-Fieser Rules – Cyclic Dienes

There are two major types of cyclic dienes, with two different base values

Heteroannular (transoid):

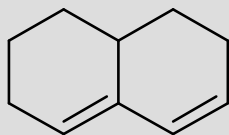

$$\begin{aligned}\epsilon &= 5,000 - 15,000 \\ \text{base } \lambda_{\text{max}} &= 214\end{aligned}$$

Homoannular (cisoid):

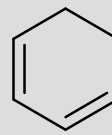

$$\begin{aligned}\epsilon &= 12,000 - 28,000 \\ \text{base } \lambda_{\text{max}} &= 253\end{aligned}$$

The increment table is the same as for acyclic butadienes with a couple additions:

Group	Increment
Additional homoannular	+39
Where both types of diene are present, the one with the longer $\lambda$ becomes the base	

## IV. Structure Determination

### A. Dienes

#### 3. Woodward-Fieser Rules – Cyclic Dienes

In the pre-NMR era of organic spectral determination, the power of the method for discerning isomers is readily apparent

Consider abietic vs. levopimaric acid:

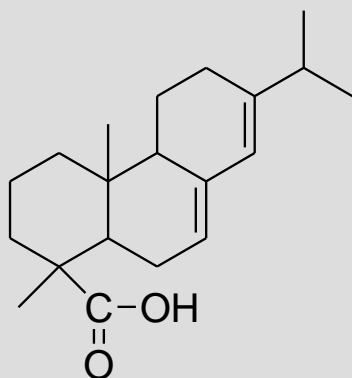

abietic acid

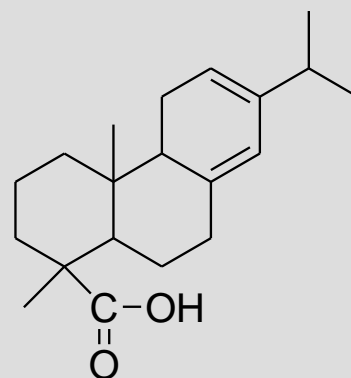

levopimaric acid

## IV. Structure Determination

### A. Dienes

#### 3. Woodward-Fieser Rules – Cyclic Dienes

For example:

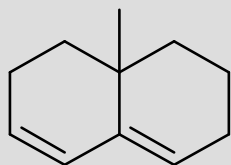

1,2,3,7,8,8a-hexahydro-8a-methylnaphthalene

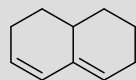

heteroannular diene = 214 nm

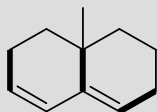

3 alkyl subs. (3 x 5) +15 nm

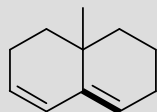

1 exo C=C + 5 nm  
234 nm

Experimental value 235 nm



## IV. Structure Determination

### A. Dienes

#### 3. Woodward-Fieser Rules – Cyclic Dienes

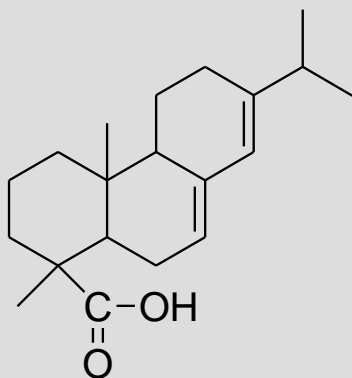

heteroannular diene = 214 nm

4 alkyl subs. (4 x 5) +20 nm  
1 exo C=C + 5 nm

239 nm

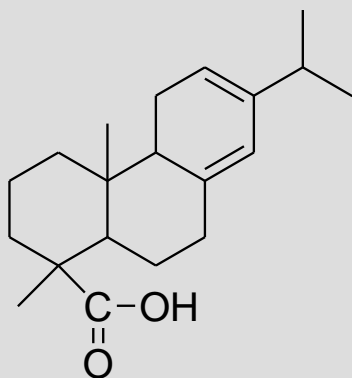

homoannular diene = 253 nm

4 alkyl subs. (4 x 5) +20 nm  
1 exo C=C + 5 nm

278 nm

## IV. Structure Determination

### A. Dienes

#### 3. Woodward-Fieser Rules – Cyclic Dienes

Be careful with your assignments – three common errors:

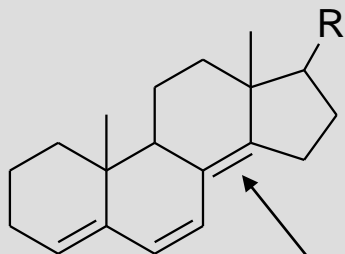

This compound has three exocyclic double bonds; the indicated bond is exocyclic to **two** rings

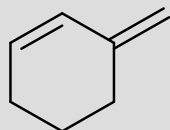

This is **not** a heteroannular diene; you would use the base value for an acyclic diene

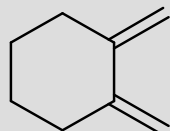

Likewise, this is **not** a homoannular diene; you would use the base value for an acyclic diene

## IV. Structure Determination

### B. Enones

#### 1. General Features

Carbonyls, as we have discussed have two primary electronic transitions:

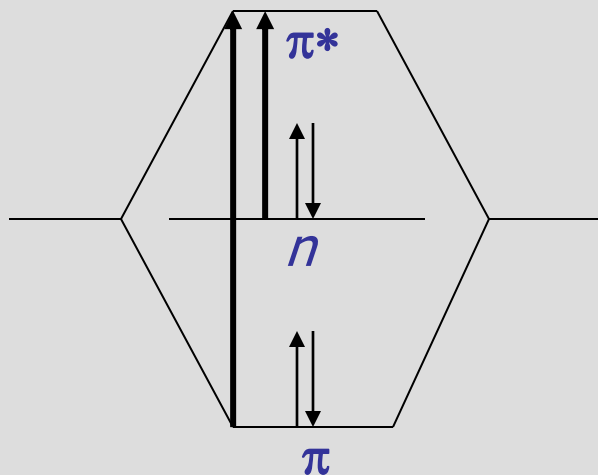

Remember, the  $\pi \rightarrow \pi^*$  transition is allowed and gives a high  $\epsilon$ , but lies outside the routine range of UV observation

The  $n \rightarrow \pi^*$  transition is forbidden and gives a very low  $\epsilon$ , but can routinely be observed

## IV. Structure Determination

### B. Enones

#### 1. General Features

For auxochromic substitution on the carbonyl, pronounced hypsochromic shifts are observed for the  $n \rightarrow \pi^*$  transition ( $\lambda_{\max}$ ):



293 nm

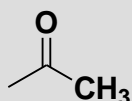

279

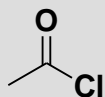

235

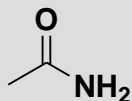

214

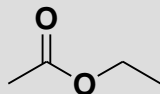

204

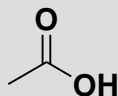

204

This is explained by the inductive withdrawal of electrons by O, N or halogen from the carbonyl carbon – this causes the  $n$ -electrons on the carbonyl oxygen to be held more firmly

It is important to note this is different from the auxochromic effect on  $\pi \rightarrow \pi^*$  which extends conjugation and causes a bathochromic shift

In most cases, this bathochromic shift is not enough to bring the  $\pi \rightarrow \pi^*$  transition into the observed range

## IV. Structure Determination

### B. Enones

#### 1. General Features

Conversely, if the C=O system is conjugated both the  $n \rightarrow \pi^*$  and  $\pi \rightarrow \pi^*$  bands are bathochromically shifted

Here, several effects must be noted:

- i. the effect is more pronounced for  $\pi \rightarrow \pi^*$
- ii. if the conjugated chain is long enough, the much higher intensity  $\pi \rightarrow \pi^*$  band will overlap and drown out the  $n \rightarrow \pi^*$  band
- iii. the shift of the  $n \rightarrow \pi^*$  transition is not as predictable

For these reasons, empirical Woodward-Fieser rules for conjugated enones are for the higher intensity, allowed  $\pi \rightarrow \pi^*$  transition

## IV. Structure Determination

### B. Enones

#### 1. General Features

These effects are apparent from the MO diagram for a conjugated enone:

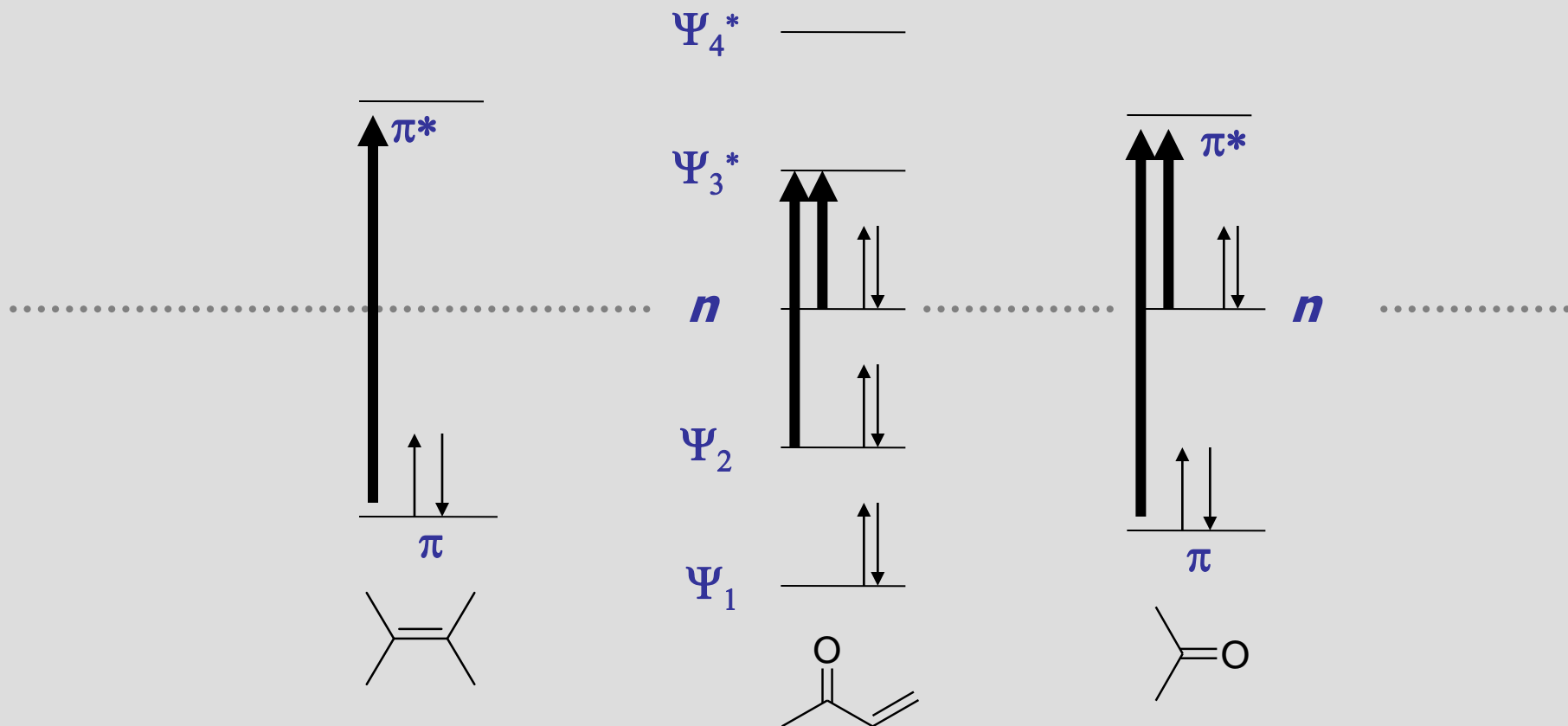

## IV. Structure Determination

### B. Enones

#### 2. Woodward-Fieser Rules - Enones

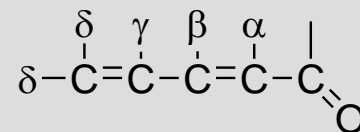
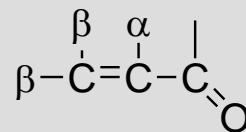

Group		Increment
6-membered ring or acyclic enone		Base 215 nm
5-membered ring parent enone		Base 202 nm
Acyclic dienone		Base 245 nm
Double bond extending conjugation		30
Alkyl group or ring residue	$\alpha, \beta, \gamma$ and higher	10, 12, 18
-OH	$\alpha, \beta, \gamma$ and higher	35, 30, 18
-OR	$\alpha, \beta, \gamma, \delta$	35, 30, 17, 31
-O(C=O)R	$\alpha, \beta, \delta$	6
-Cl	$\alpha, \beta$	15, 12
-Br	$\alpha, \beta$	25, 30
-NR <sub>2</sub>	$\beta$	95
Exocyclic double bond		5
Homocyclic diene component		39

## IV. Structure Determination

### B. Enones

#### 2. Woodward-Fieser Rules - Enones

Aldehydes, esters and carboxylic acids have different base values than ketones

Unsaturated system	Base Value
Aldehyde	208
With $\alpha$ or $\beta$ alkyl groups	220
With $\alpha,\beta$ or $\beta,\beta$ alkyl groups	230
With $\alpha,\beta,\beta$ alkyl groups	242
Acid or ester	
With $\alpha$ or $\beta$ alkyl groups	208
With $\alpha,\beta$ or $\beta,\beta$ alkyl groups	217
Group value – exocyclic $\alpha,\beta$ double bond	+5
Group value – endocyclic $\alpha,\beta$ bond in 5 or 7 membered ring	+5



## IV. Structure Determination

### B. Enones

#### 2. Woodward-Fieser Rules - Enones

Unlike conjugated alkenes, solvent does have an effect on  $\lambda_{\max}$

These effects are also described by the Woodward-Fieser rules

Solvent correction	Increment
Water	+8
Ethanol, methanol	0
Chloroform	-1
Dioxane	-5
Ether	-7
Hydrocarbon	-11

## IV. Structure Determination

### B. Enones

#### 2. Woodward-Fieser Rules - Enones

Some examples – keep in mind these are more complex than dienes

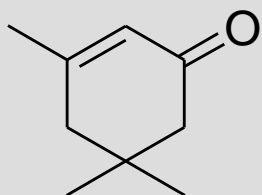

cyclic enone =	215 nm
2 x $\beta$ - alkyl subs. (2 x 12)	<u>+24 nm</u>
	239 nm

Experimental value 238 nm

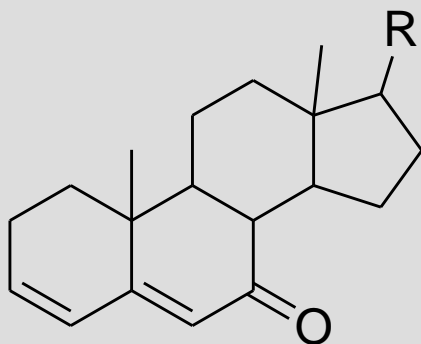

cyclic enone =	215 nm
extended conj.	+30 nm
$\beta$ -ring residue	+12 nm
$\delta$ -ring residue	+18 nm
exocyclic double bond	<u>+ 5 nm</u>
	280 nm

Experimental 280 nm

## IV. Structure Determination

### B. Enones

#### 2. Woodward-Fieser Rules - Enones

Take home problem – can these two isomers be discerned by UV-spec

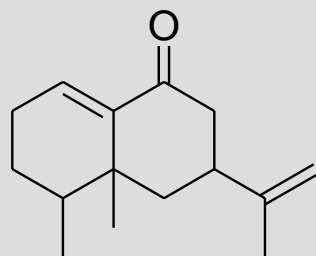

Eremophilone

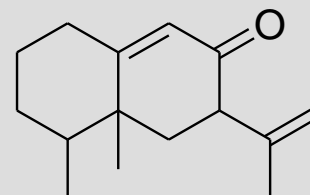

*allo*-Eremophilone

Problem Set 1: (text) – 1,2,3a,b,c,d,e,f,j, 4, 5, 6 (1<sup>st</sup>, 2<sup>nd</sup> and 5<sup>th</sup> pairs), 8a, b, c

Problem Set 2: outside problems/key -Tuesday

## IV. Structure Determination

### C. Aromatic Compounds

#### 1. General Features

Although aromatic rings are among the most widely studied and observed chromophores, the absorptions that arise from the various electronic transitions are complex

On first inspection, benzene has six  $\pi$ -MOs, 3 filled  $\pi$ , 3 unfilled  $\pi^*$

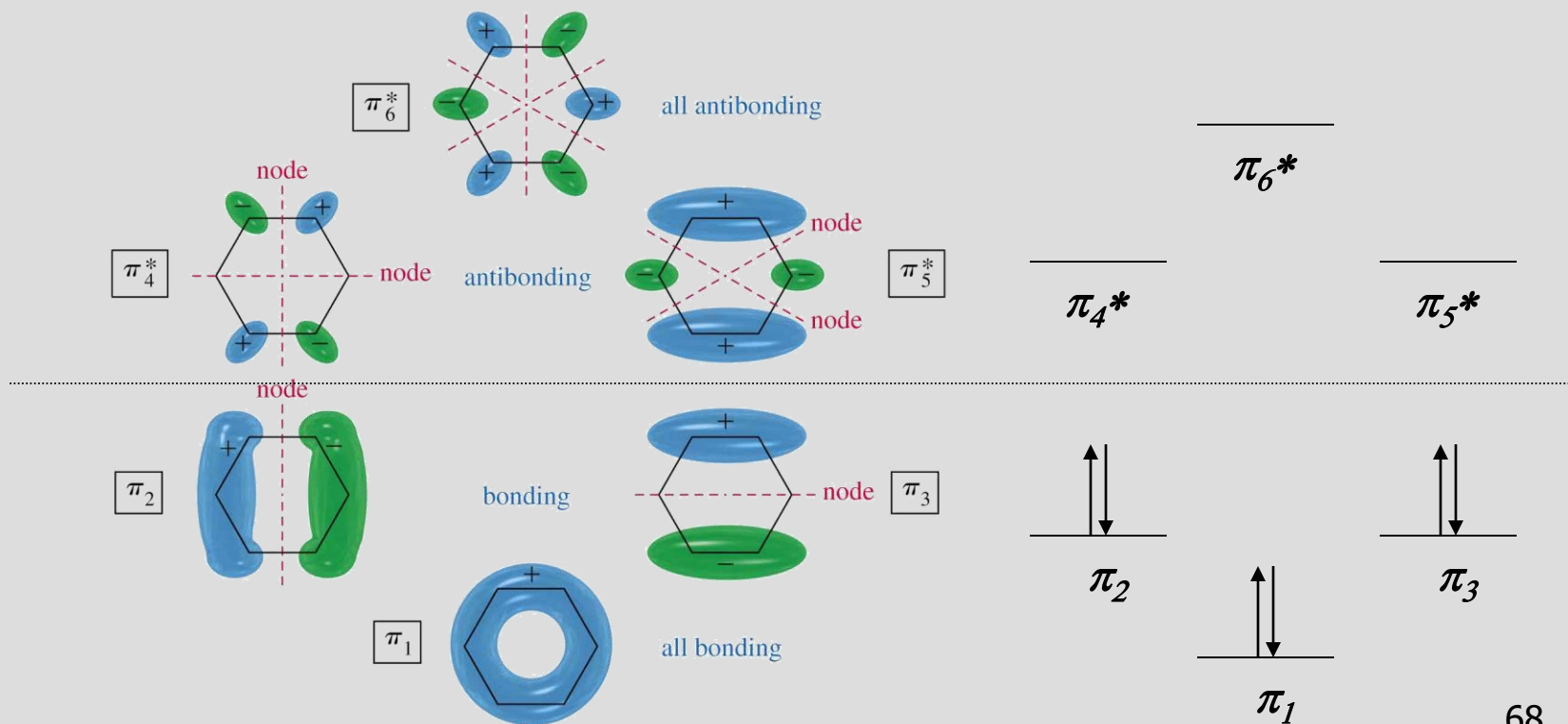

## IV. Structure Determination

### C. Aromatic Compounds

#### 1. General Features

One would expect there to be four possible HOMO-LUMO  $\pi \rightarrow \pi^*$  transitions at observable wavelengths (conjugation)

Due to symmetry concerns and selection rules, the actual transition energy states of benzene are illustrated at the right:

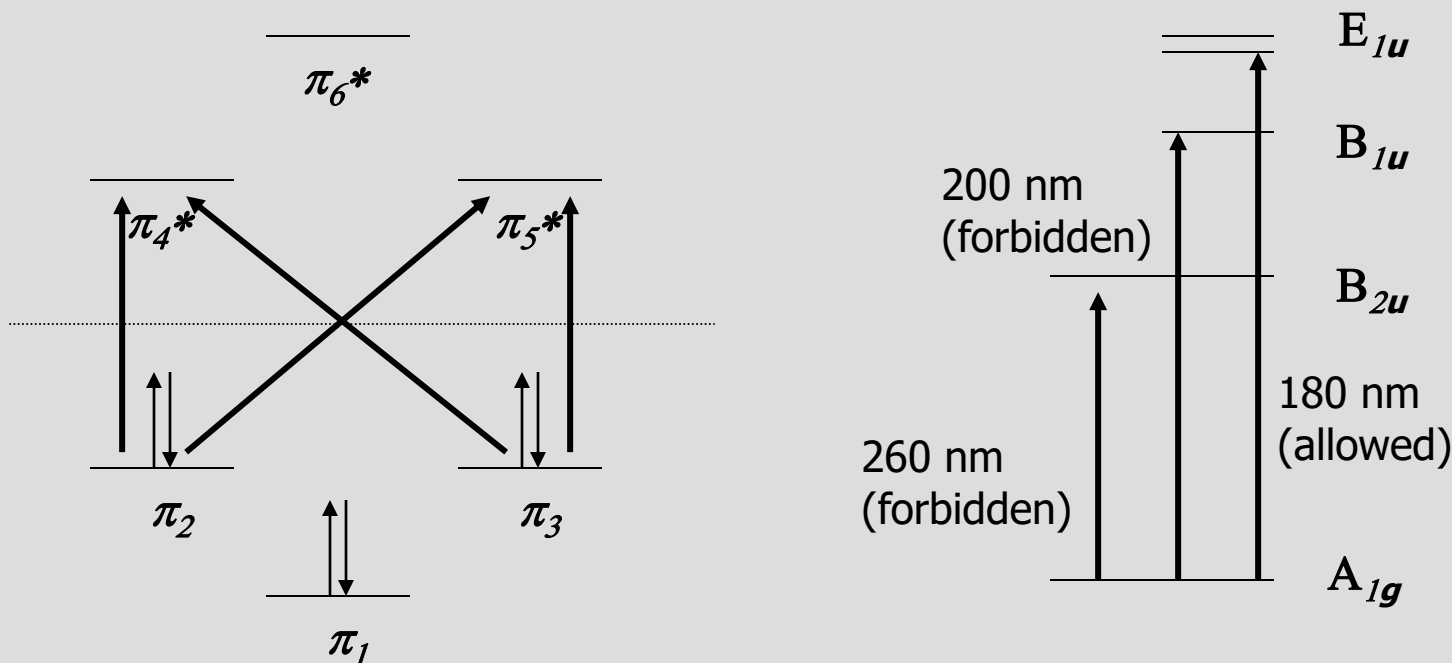

## IV. Structure Determination

### C. Aromatic Compounds

#### 1. General Features

The allowed transition ( $\epsilon = 47,000$ ) is not in the routine range of UV obs. at 180 nm, and is referred to as the *primary band*

The forbidden transition ( $\epsilon = 7400$ ) is observed if substituent effects shift it into the obs. region; this is referred to as the *second primary band*

At 260 nm is another forbidden transition ( $\epsilon = 230$ ), referred to as the *secondary band*.

This transition is fleetingly allowed due to the disruption of symmetry by the vibrational energy states, the overlap of which is observed in what is called *fine structure*

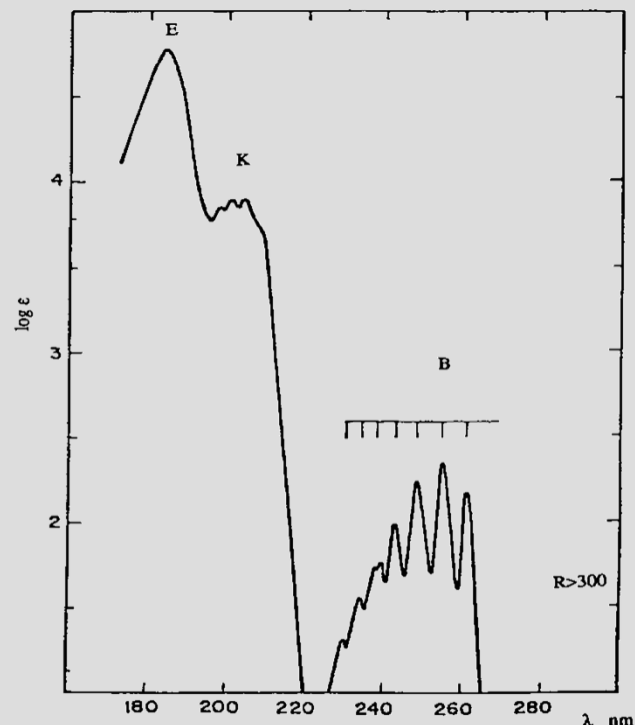

## IV. Structure Determination

### C. Aromatic Compounds

#### 1. General Features

Substitution, auxochromic, conjugation and solvent effects can cause shifts in wavelength and intensity of aromatic systems similar to dienes and enones

However, these shifts are difficult to predict – the formulation of empirical rules is for the most part is not efficient (there are more exceptions than rules)

There are some general qualitative observations that can be made by classifying substituent groups --

## IV. Structure Determination

### C. Aromatic Compounds

#### 2. Substituent Effects

##### a. Substituents with Unshared Electrons

- If the group attached to the ring bears  $n$  electrons, they can induce a shift in the primary and secondary absorption bands
- Non-bonding electrons extend the  $\pi$ -system through resonance – lowering the energy of transition  $\pi \rightarrow \pi^*$
- More available  $n$ -pairs of electrons give greater shifts

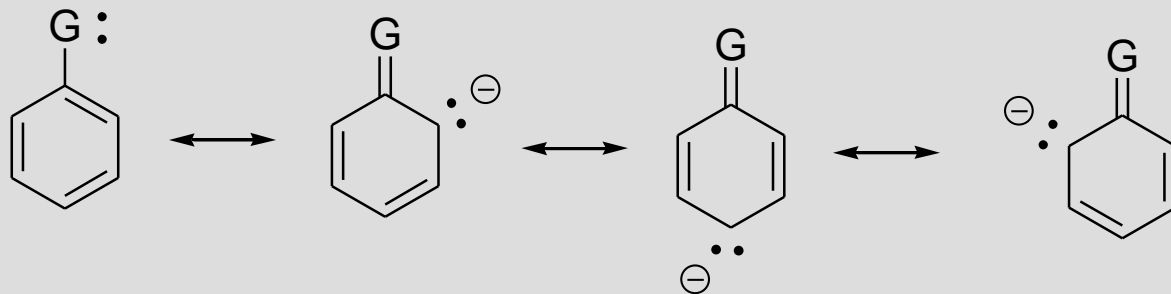



## IV. Structure Determination

### C. Aromatic Compounds

#### 2. Substituent Effects

##### a. Substituents with Unshared Electrons

- The presence of  $n$ -electrons gives the possibility of  $n \rightarrow \pi^*$  transitions
- If this occurs, the electron now removed from G, becomes an extra electron in the anti-bonding  $\pi^*$  orbital of the ring
- This state is referred to as a *charge-transfer excited state*

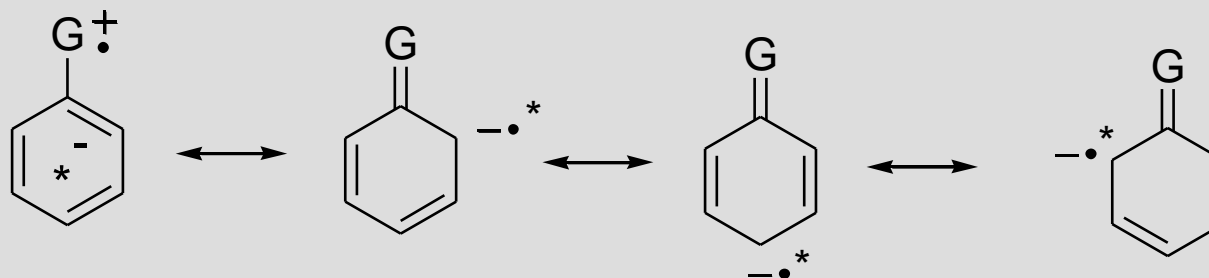

## IV. Structure Determination

### C. Aromatic Compounds

#### 2. Substituent Effects

##### a. Substituents with Unshared Electrons

- pH can change the nature of the substituent group
- deprotonation of oxygen gives more available  $n$ -pairs, *lowering* transition energy
- protonation of nitrogen eliminates the  $n$ -pair, *raising* transition energy

Substituent	Primary		Secondary	
	$\lambda_{\max}$	$\epsilon$	$\lambda_{\max}$	$\epsilon$
-H	203.5	7,400	254	204
-OH	211	6,200	270	1,450
-O <sup>-</sup>	235	9,400	287	2,600
-NH <sub>2</sub>	230	8,600	280	1,430
-NH <sub>3</sub> <sup>+</sup>	203	7,500	254	169
-C(O)OH	230	11,600	273	970
-C(O)O <sup>-</sup>	224	8,700	268	560

## IV. Structure Determination

### C. Aromatic Compounds

#### 2. Substituent Effects

##### b. Substituents Capable of $\pi$ -conjugation

- When the substituent is a  $\pi$ -chromophore, it can interact with the benzene  $\pi$ -system
- With benzoic acids, this causes an appreciable shift in the primary and secondary bands
- For the benzoate ion, the effect of extra  $n$ -electrons from the anion reduces the effect slightly

Substituent	Primary		Secondary	
	$\lambda_{\max}$	$\epsilon$	$\lambda_{\max}$	$\epsilon$
-C(O)OH	230	11,600	273	970
-C(O)O <sup>-</sup>	224	8,700	268	560

## IV. Structure Determination

### C. Aromatic Compounds

#### 2. Substituent Effects

- c. Electron-donating and electron-withdrawing effects
  - No matter what electronic influence a group exerts, the presence shifts the primary absorption band to longer  $\lambda$
  - Electron-withdrawing groups exert no influence on the position of the secondary absorption band
  - Electron-donating groups increase the  $\lambda$  and  $\epsilon$  of the secondary absorption band

## IV. Structure Determination

### C. Aromatic Compounds

#### 2. Substituent Effects

##### c. Electron-donating and electron-withdrawing effects

	Substituent	<i>Primary</i>		<i>Secondary</i>	
		$\lambda_{\text{max}}$	$\epsilon$	$\lambda_{\text{max}}$	$\epsilon$
Electron donating	-H	203.5	7,400	254	204
	-CH <sub>3</sub>	207	7,000	261	225
	-Cl	210	7,400	264	190
	-Br	210	7,900	261	192
	-OH	211	6,200	270	1,450
	-OCH <sub>3</sub>	217	6,400	269	1,480
	-NH <sub>2</sub>	230	8,600	280	1,430
Electron withdrawing	-CN	224	13,000	271	1,000
	C(O)OH	230	11,600	273	970
	-C(O)H	250	11,400		
	-C(O)CH <sub>3</sub>	224	9,800		
	-NO <sub>2</sub>	269	7,800		

## IV. Structure Determination

### C. Aromatic Compounds

#### 2. Substituent Effects

##### d. Di-substituted and multiple group effects

- With di-substituted aromatics, it is necessary to consider both groups
- If both groups are electron donating or withdrawing, the effect is similar to the effect of the stronger of the two groups as if it were a *mono*-substituted ring
- If one group is electron withdrawing and one group electron donating and they are *para*- to one another, the magnitude of the shift is greater than the sum of both the group effects
- Consider *p*-nitroaniline:

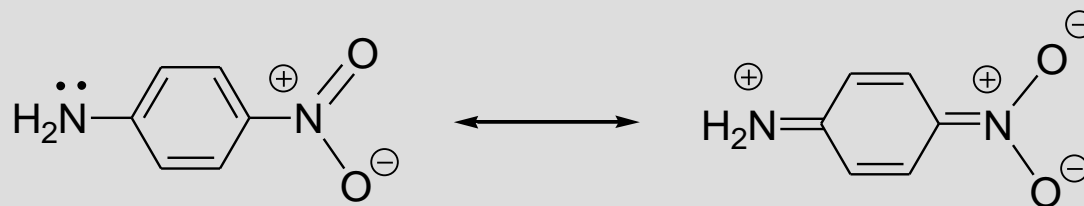

## IV. Structure Determination

### C. Aromatic Compounds

#### 2. Substituent Effects

##### d. Di-substituted and multiple group effects

- If the two electronically dissimilar groups are ortho- or meta- to one another, the effect is usually the sum of the two individual effects (*meta*- no resonance; *ortho*-steric hind.)
- For the case of substituted benzoyl derivatives, an empirical correlation of structure with observed  $\lambda_{\max}$  has been developed
- This is slightly less accurate than the Woodward-Fieser rules, but can usually predict within an error of 5 nm

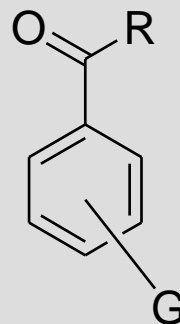

## IV. Structure Determination

### C. Aromatic Compounds

#### 2. Substituent Effects

##### d. Di-substituted and multiple group effects

Parent Chromophore	$\lambda_{\max}$
R = alkyl or ring residue	246
R = H	250
R = OH or O-Alkyl	230

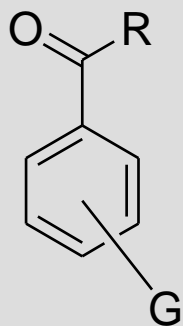

G	Substituent increment		
	<i>o</i>	<i>m</i>	<i>p</i>
Alkyl or ring residue	3	3	10
-O-Alkyl, -OH, -O-Ring	7	7	25
-O-	11	20	78
-Cl	0	0	10
-Br	2	2	15
-NH <sub>2</sub>	13	13	58
-NHC(O)CH <sub>3</sub>	20	20	45
-NHCH <sub>3</sub>			73
-N(CH <sub>3</sub> ) <sub>2</sub>	20	20	85



# Espectroscopia no UV

- A maioria dos flavonóides apresenta dois picos de absorção máxima, um na faixa de 240-285 nm (banda II) e o outro na faixa de 300-400 nm (banda I).

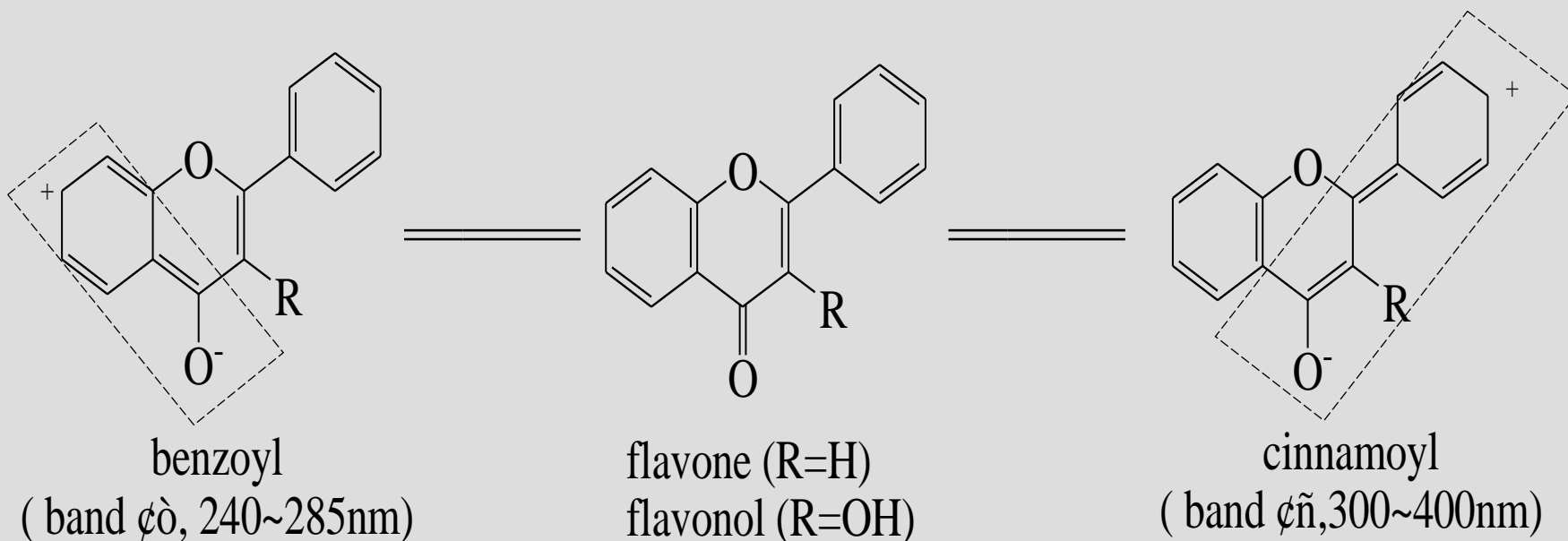

# Espectroscopia no UV

## Ex 1. Flavonas and Flavonóis

**Diferença: Banda I**

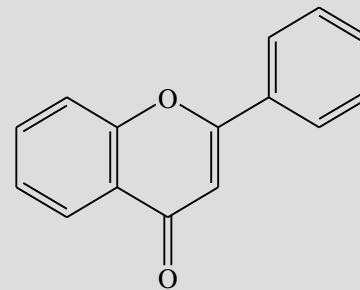
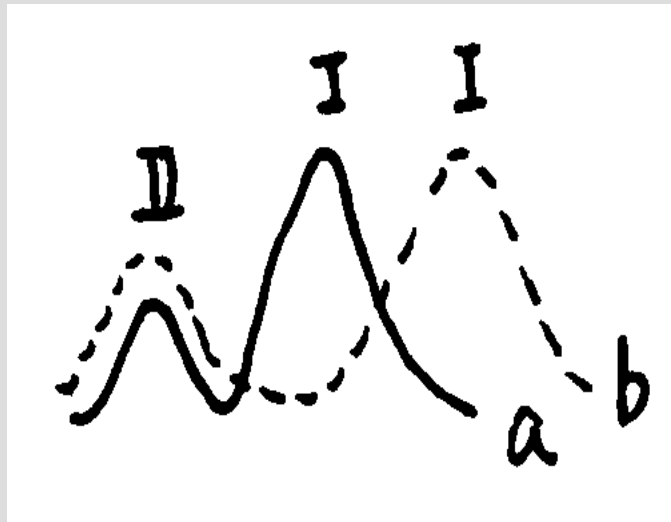

flavone

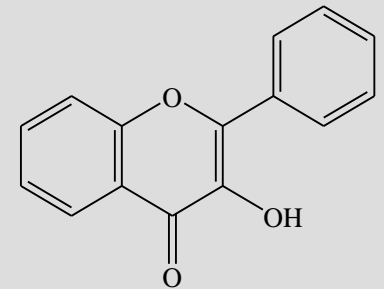

flavonol

*a. Flavonas*  
*b. Flavonóis*

# Espectroscopia no UV

*Mecanismo dos deslocamentos batocrômico e ipsocrômico*

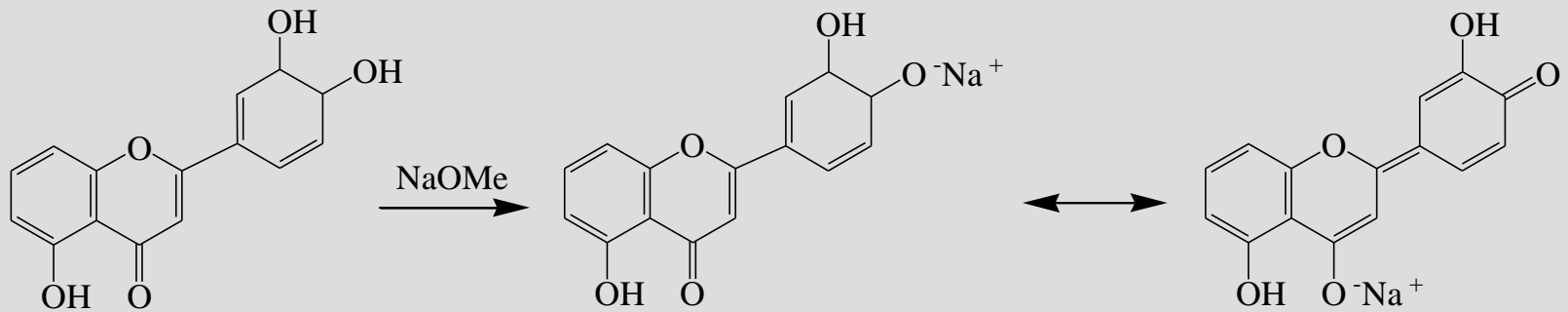

Flavone

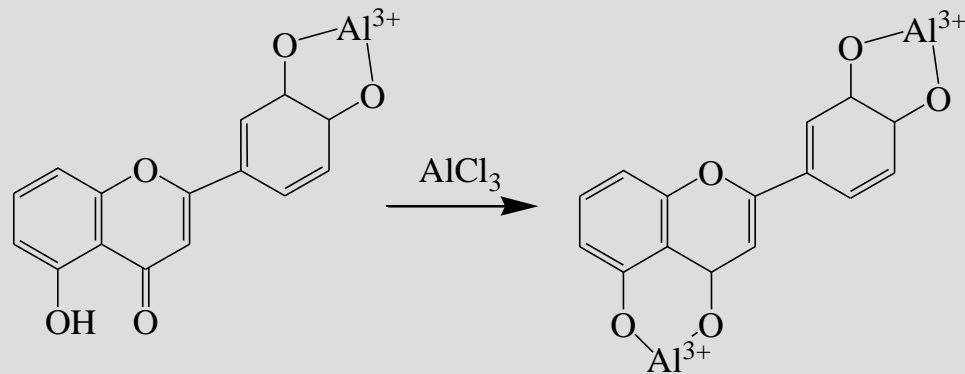

Flavone

# Espectroscopia no UV

## Deslocamentos de Absorção

<i>Position of the Substituent</i>	$\lambda_{max}$ nm (MeOH)	$\lambda_{max}$ nm (NaOMe)	$\lambda_{max}$ nm (AlCl <sub>3</sub> )
Parent flavone	250, 294, 307	250, 294, 309	-
5-hydroxy	268, 296, 333	272, 380	380
7-hydroxy	252, 268, 307	266, 307, 359	-
4'-Methoxy	253, 317	254, 316	-
3',4'-dihydroxy	242, 308, 340	249, 278, 302, 404	380
3',4'-dimethoxy	242, 314, 333	241, 314, 334	-
<i>Flavonol</i>			
5,7-dihydroxy	267, 305, 359	280, 327, 412	430
5,7,4'-trihydroxy	266, 294, 322, 367	278, 316, 416	-
5,7,3',4',5'-penta hydroxy	254, 272, 301, 371	262, 285, 322, 423	
<i>Isoflavone</i>			
7-hydroxy	242, 299, 305	264, 336	
5,7-dihydroxy	259, 303, 315	274, 329	
5,7-dimethoxy	251, 308	251, 309	

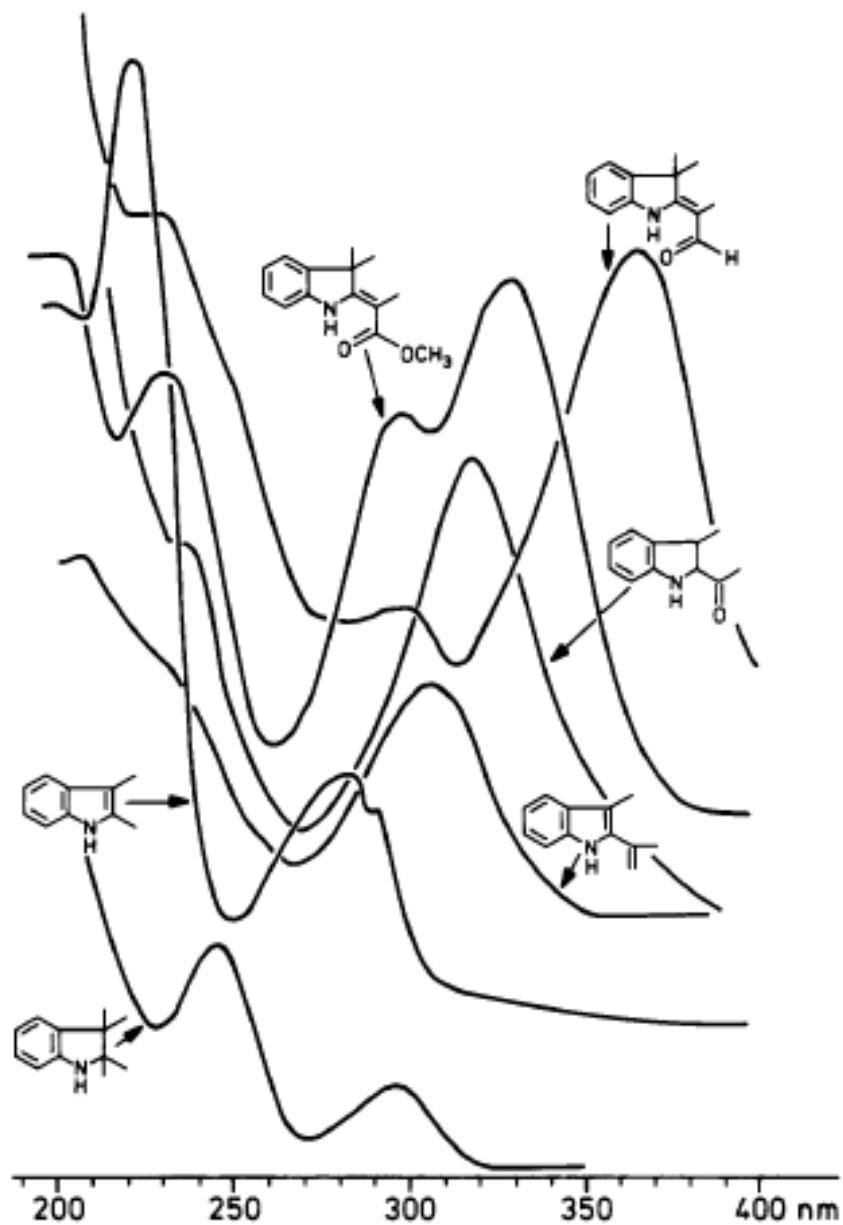

FIGURE 2. Uv spectra of some common indole chromophores (not normalized for concentrations)