

Electronic insert *FEL 50 A* for Liquiphant M/S (HT) PROFIBUS PA

Operating Instructions

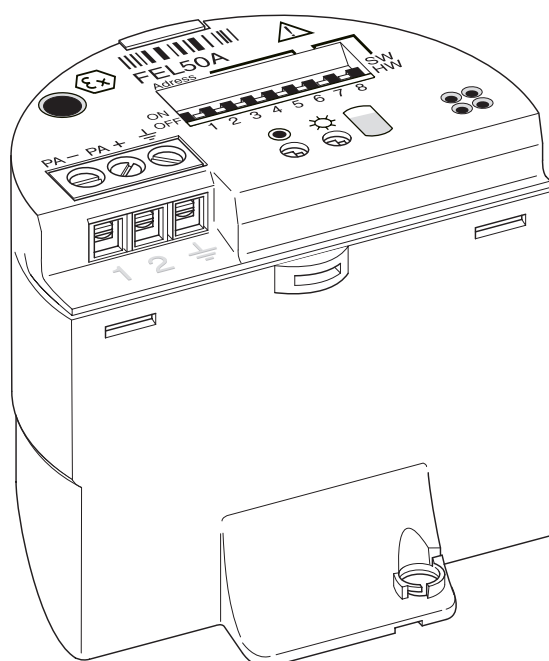

Brief operating instructions

These brief operating instructions (KA) show you how to configure your measuring device quickly and easily:

Safety instructions	page 4.
▼	
Mounting	See KA ... (Basic device), table "Supplementary documentation" p. 39
▼	
Wiring	page 9.
▼	
Commissioning / addressing	page 18/29
▼	
Operating elements	page 17.
▼	
Configuration	page 30.
▼	
Trouble-shooting	page 34.
<p>Always commence trouble-shooting with the checklist on page 34., and the trouble-shooting instructions in the Operating Instructions of the basic device (see table page 39.) if errors occur during commissioning or operation. The routine takes you directly to the cause of the problem and the appropriate remedial measures.</p> <p>Returning devices If you return a device to Endress+Hauser for repairs or calibration, please note the information in the Operating Instructions ... (basic device), see also the table on "Supplementary documentation" page 39</p>	

Contents

Brief operating instructions	2	9.5 Contact addresses of Endress+Hauser	36
Contents	3	10 Technical data	37
1 Safety instructions	4	10.1 Technical data at a glance	37
1.1 Intended application	4		
1.2 Mounting, commissioning, operation	4		
1.3 Operational safety	4		
1.4 Return	5		
1.5 Notes on safety conventions and icons	5		
2 Identification	6		
2.1 Device designation	6		
2.2 Delivery	6		
2.3 Certificates and approvals	6		
2.4 Registered trademarks	7		
3 Mounting	8		
3.1 Incoming acceptance, transport and storage	8		
3.2 Use and Mounting	8		
4 Wiring	9		
4.1 PROFIBUS PA Cable specifications	9		
4.2 Connection of the limit switch	11		
4.3 Connection data	13		
4.4 PROFIBUS PA M12 plug connector	13		
4.5 Potential equalisation	15		
4.6 Degree of protection	15		
4.7 Post connection check	16		
5 Operation	17		
5.1 Operation at a glance	17		
5.2 On-site configuration/operation	18		
5.3 Communication with PROFIBUS PA	20		
6 Commissioning	29		
6.1 Mounting and function testing	29		
6.2 Commissioning with Commuwin II	29		
7 Maintenance	32		
8 Accessories	33		
9 Trouble-shooting	34		
9.1 System error messages	34		
9.2 Spare parts	35		
9.3 Return	35		
9.4 Software history	36		

1 Safety instructions

1.1 Intended application

The Liquiphant M FTL 50 (H)/51 (H)/51 C and Liquiphant S (HT*), FTL 70/71 with electronic insert FEL 50 A may only be used as a limit switch for liquids. Other applications are not permitted. They may violate the appropriate regulations, particularly in explosion-hazardous areas.

1.2 Mounting, start-up, operation

The Liquiphant M and Liquiphant S (HT) with electronic insert FEL 50 A is built to the state-of-the-art and to be fail-safe and meets the appropriate rules and EC directives. However, if you use it improperly or other than for its designated use, it may pose application-specific hazards, e.g. product overflow through incorrect mounting or configuration. Mounting, electrical connection, start-up, operation and maintenance of the measuring device must therefore be carried out exclusively by trained specialists authorised by the system operator. Technical personnel must have read and understood these operating instructions and must adhere to them. You may only undertake modifications or repair work to the device when it is expressly permitted by the operating manual.

1.3 Operational safety

Explosion-hazardous area

When using the measuring system in explosion-hazardous areas, you must keep to the appropriate national standards. The device possesses separate Ex documents (XA 154F, XA 158F, XA 159F) which form a component part of this documentation. Always follow the mounting regulations, connection data and safety instructions therein.

- Make sure that the specialist personnel have received sufficient training.
- Always keep to the measuring and safety conditions at the measuring points.

* HT = High temperature



1.4 Return

See KA ... (Basic device), table "Supplementary documentation" page 39



1.5 Notes on safety conventions and icons

To highlight safety-relevant or alternative procedures, we have set the following safety instructions for which each individual instruction is indicated with an appropriate pictogram.





Safety instructions

Icon	Meaning
	Warning! "Warning" indicates activities or processes which - if improperly executed - could lead to serious injury to persons, to a safety risk or to destruction of the device.
	Caution! "Caution" indicates activities or processes which - if improperly executed - could lead to injury to persons or to incorrect functioning of the device.
	Note! "Note" indicates activities which - if improperly executed - could have an indirect impact on operation or trigger unexpected instrument actions.

Type of protection

	Explosion protected, design tested apparatus If this symbol appears on the nameplate of the device, the device can be used in a hazardous area or in a non-hazardous area, according to the approval.
	Hazardous area In the drawings of these operating instructions, this symbol indicates hazardous areas. – Devices located in hazardous areas or lines for such devices must possess an appropriate type of protection.
	Safe area (non-hazardous area) In the drawings of these operating instructions, this symbol indicates non-hazardous areas. – Devices in non-hazardous areas must also be certified, if the connecting lines run through a hazardous area.

Electrical symbols

	DC voltage A terminal at which DC voltage is applied or through which DC flows.
	AC A terminal at which (sine-form) alternating voltage is applied or through which AC flows.
	Ground connection A grounded terminal, which, from the user's point of view, is already grounded using a grounding system.
	Protective earth connection A terminal which must be grounded before other connections may be set up.
	Equipotential connection A connection which must be connected to the grounding system of the equipment: this can, for example, be a potential matching line of a starshaped grounding system, depending on national or company practice.

2 Identification

2.1 Device designation

2.1.1 Nameplate

On the nameplate, you can find the following technical information:

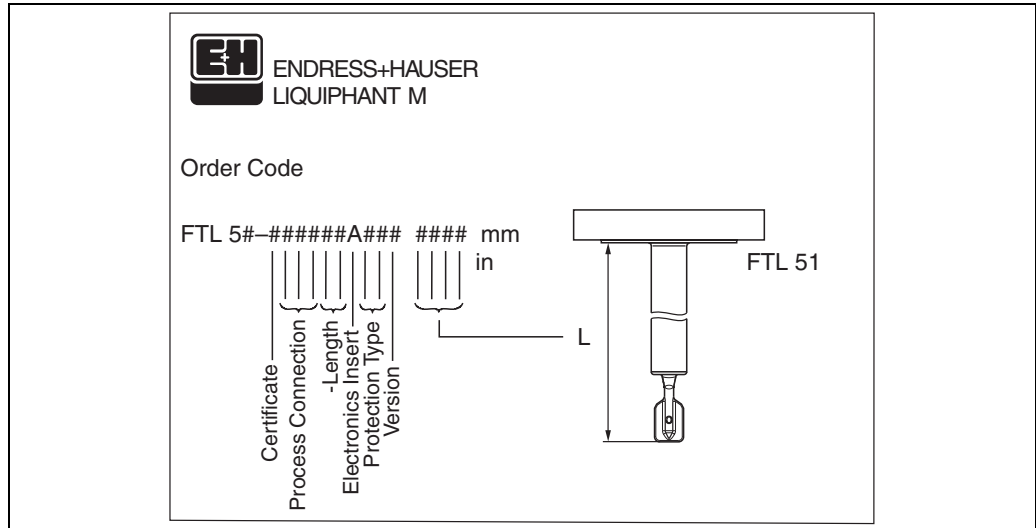

Fig. 1 Information on the nameplate of the Liquiphant M with electronic insert FEL 50 A (Example)

2.1.2 Product structure

See KA ... (Basic device), table "Supplementary documentation" page 39.

2.2 Delivery



Caution!

Always note the instructions in chapter "Incoming acceptance, transport and storage" on page 8 concerning the unpacking, transport and storage of devices!

The delivery consists of:

- Installed device
- poss. accessories (see Chapter 8)

Supplementary device documentation:

- Operating Instructions KA ... (Basic device)
- Operating manual (this booklet)
- Approval documentation: as far as not given in the operating manual

2.3 Certificates and approvals

CE symbol, Declaration of conformity

The instrument has been designed and tested according to the state of the art and left the factory in perfect functioning order. The device meets all the appropriate standards and regulations according to EN 61010 "Safety regulations for electrical measurement, control, and laboratory devices". Thus, the device meets the statutory requirements of

EC directives. Endress+Hauser confirms successful testing of the device by affixing the CE mark.

PNO Certification

The device was certified according to the PNO standard (Profile 3.0).

2.4 Registered trademarks

PROFIBUS®

is a registered trademark of PROFIBUS Nutzerorganisation e.V., Karlsruhe, Germany.

3 Installation

3.1 Incoming acceptance, transport and storage

3.1.1 Incoming acceptance

Check the packaging and the contents for damage.
Check the shipment, make sure nothing is missing and that the scope of supply matches your order.

3.1.2 Storage

For storage and transport purposes, pack the instrument so that it is protected against impacts. The original packaging provides optimum protection.
The permissible storage temperature is $-50\text{ °C} \dots +80\text{ °C}$.

3.2 Use and Mounting

See KA ... (Basic device), table "Supplementary documentation" page 39.

4 Wiring



Warning!

- When connecting Ex-certified devices, see the notes and wiring diagrams in the Ex-specific supplement to these Operating Instructions. Please do not hesitate to contact your E+H representative if you have any questions.

4.1 PROFIBUS PA Cable specifications

Always use a twisted, screened two-wire cable. When installing in the hazardous area, keep to the following characteristic values (EN 50020, FISCO model):

	Type A	Type B
Cable structure	twisted pair, screened	one or more twisted pairs, fully shielded
Wire size	0.8 mm ² (AWG 18)	0.32 mm ² (AWG 22)
Loop resistance (DC)	44 Ω/km	112 Ω/km
Impedance at 31.25 kHz	100 Ω ± 20%	100 Ω ± 30%
Attenuation constant at 39 kHz	3 dB/km	5 dB/km
Capacitive asymmetry	2 nF/km	2 nF/km
Envelope delay distortion (7.9 through 39 kHz)	1.7 μs/km	*
Shield coverage	90%	*
Maximum Cable length (incl. spurs > 1 m)	1900 m	1200 m
* not specified		

The following cable types are suitable, for example:

Non-Ex area:

- Siemens 6XV1 830-5BH10 (grey)
- Kerpen CEL-PE/OSCR/PVC/FRLA FB-02YS(ST)YFL (grey)
- Belden 3076F (orange)

Ex area:

- Siemens 6XV1 830-5AH10 (blue)
- Kerpen CEL-PE/OSCR/PVC/FRLA FB-02YS(ST+C)YFL (blue)

Maximum overall cable length

The maximum network expansion depends on the type of explosion protection and the cable specifications. The overall cable length is made up of the length of the main cable and the length of all spurs (> 1 m). Note the following points:

- The highest permissible cable length is dependent on the cable type used:

Type A	1900 m
Type B	1200 m

- If repeaters are used the maximum permissible cable length is doubled.
A maximum of four repeaters are permitted between user and master.

Maximum spur length

The line between distribution box and field unit is described as a spur.
In the case of non Ex-applications the maximum length of a spur depends on the number of spurs (> 1 m):

Number of spurs	1 ... 12	13... 14	15... 18	19... 24	25... 32
Maximum length per spur	120 m	90 m	60 m	30 m	1 m

Number of field devices

In systems that meet FISCO in the EEx ia type of protection, the line length is limited a maximum of 1000 m.

Up to 32 stations are possible per segment in non-Ex areas or maximum 10 stations in hazardous area (EEx ia IIC). The actual number of users must be determined during configuration.

Bus termination

The start and end of each field bus segment are always to be terminated with a bus terminator. With various junction boxes (not Ex-rated) the bus termination can be activated via a switch. If this is not the case a separate bus terminator must be installed. Note the following points in addition:

- In the case of a branched bus segment the device furthest from the segment coupler represents the end of the bus.
- If the field bus is extended with a repeater then the extension must also be terminated at both ends.

Shielding and grounding

When planning the shielding and grounding for a field bus system, there are three important points to consider:

- Electromagnetic compatibility (EMC)
- Explosion protection
- Safety of the personnel

To ensure the optimum electromagnetic compatibility of systems, it is important that the system components and above all the cables, which connect the components, are screened and that no portion of the system is unscreened.

Ideally, the cable screening will be connected to the field devices' housings, which are usually metal. Since these housings are generally connected to the protective earth, the shield of the bus cable will thus be grounded many times.

This approach, which provides the best electromagnetic compatibility and personnel safety, can be used without restriction in systems with good potential matching.

In the case of systems without potential matching, a mains frequency (50 Hz) equalising current can flow between two grounding points, which in unfavorable cases, e.g. when it exceeds the permissible shield current, may destroy the cable.

To prevent low-frequency equalising currents, it is wise with systems without potential matching system to connect the cable screening only on one side with the local ground (or protective earth) and connect all further ground points capacitively.

Further information

General information and further notes regarding the wiring can be found in the BA 198F.

4.2 Connection of the limit switch

4.2.1 Connection with cable gland

Procedure:

1. Unscrew connection compartment cover from transmitter housing.
2. Run the PROFIBUS cable through the appropriate cable entries.
3. Connect the cables in accordance with the wiring diagram: see Fig. 5 and Fig. 6



Caution!

- The PROFIBUS cable can be damaged!

In systems without additional potential matching systems, line-frequency equalising currents may occur which damage the cable and/or the screen, should the cable screening be grounded at several points.

In such cases the shielding of the cable is to be grounded on only one side, i.e. it must not be connected to the ground terminal of the housing. The shield that is not connected should be insulated!

- We recommend that the PROFIBUS not be looped using conventional cable glands. If you later replace even just one measuring device, the bus communication will have to be interrupted.



Note!

- The terminals for the PROFIBUS connection (1/2) possess integrated reverse polarity protection. This ensures correct signal transmission via the field bus even if lines are confused.
- Conductor cross-section: maximum 2.5 mm²
- Observe the system's grounding concept.
- Select the Bus address using the miniature switch.

4. Screw the connection compartment cover back onto the housing.

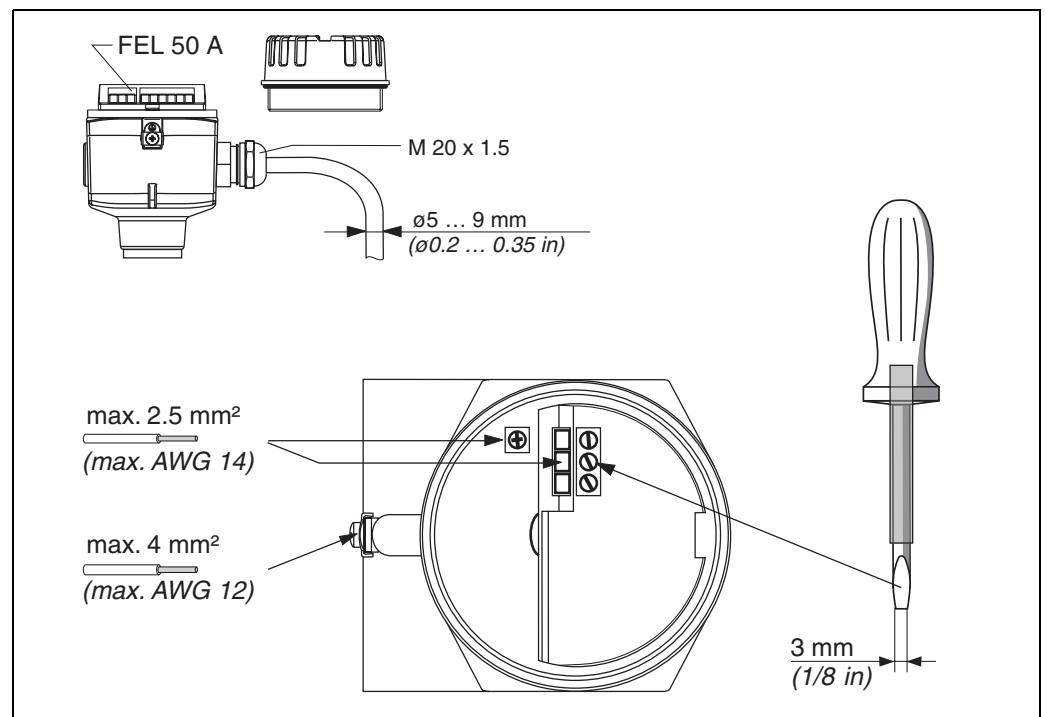

Fig. 5 Connection of transmitter with cable gland

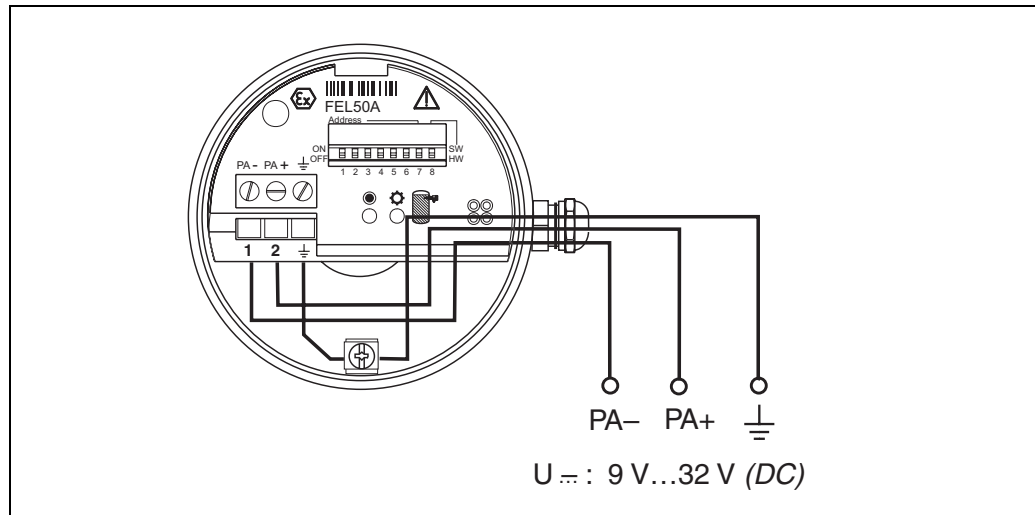

Fig. 6 Assignment of screw terminals

PROFIBUS PA line:

Terminal **No. 1: PA-**

Terminal **No. 2: PA+**

conductor cross-section: maximum 2.5 mm²

4.2.2 Connection with PROFIBUS PA M12 plug-in connector

The Liquiphant PROFIBUS PA version with M12 plug-in connector is supplied completely wired. All you need to do is connect it to the bus with a pre-terminated cable.

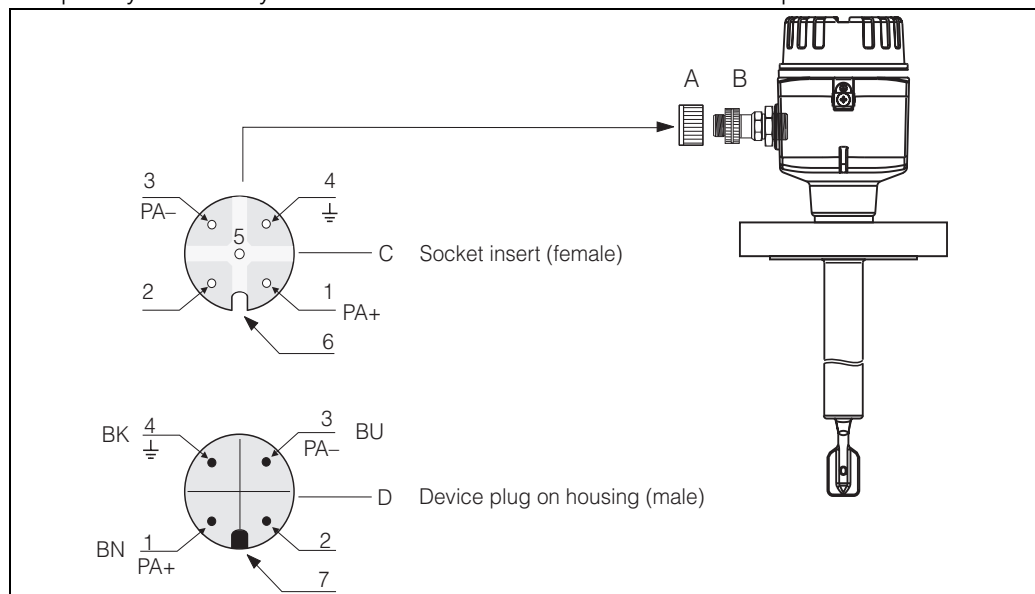

Fig. 7 PROFIBUS PA M12 pin assignment

A = Protection cap for device plug

B = Fieldbus device plug

C = Socket insert (female)

D = Device plug on housing (male)

Pin assignment / Colour codes:

1 = Brown wire: PA+

2 = Unconnected

3 = Blue line: PA-

4 = Black line: Ground (Notes for connection see page 15)

6 = Positioning slot

7 = Positioning lug

4.3 Connection data

Connection data PROFIBUS PA
$U_i \leq 30 \text{ VDC}$ $I_i \leq 500 \text{ mA}$ $P_i \leq 5.5 \text{ W}$ $L_i \leq 10.0 \text{ }\mu\text{H}$ $C_i \leq 5 \text{ nF}$

Cable entry

Cable gland: M20x1.5 or Pg 13.5

Cable entry: G 1/2 or 1/2 NPT

PROFIBUS PA M12 plug-in connector

Supply voltage

All the following voltages are terminal voltages directly at the device:

Variant	Terminal voltage	
	Minimum	Maximum
Standard	9 V	32 V
EEx ia (FISCO model)	9 V	17.5 V
EEx ia (Entity concept)	9 V	24 V

Current consumption

Current consumption over the whole voltage area is approx. 11 mA.

4.4 PROFIBUS PA M12 plug-in connector



Note!

This connector can only be used for a PROFIBUS PA device.

With PROFIBUS PA the connection system allows you to connect devices to the fieldbus using standardised mechanical connections such as branches and distributor elements. This connection technology using prefabricated distribution modules and plug-in connectors offers substantial advantages over conventional wiring:

- Field devices can be removed, replaced or added at any time during normal operation. Communications will not be interrupted.
- This simplifies mounting and maintenance significantly.
- Existing cable infrastructures can be used and expanded instantly, e.g. when constructing new star distributors using 4-channel or 8-channel junction boxes.

Optionally, the Liquiphant can be supplied from the factory with a pre-installed fieldbus device plug-in connector. Field bus connectors for retrofitting can be ordered from E+H as a spare part (see page 35).

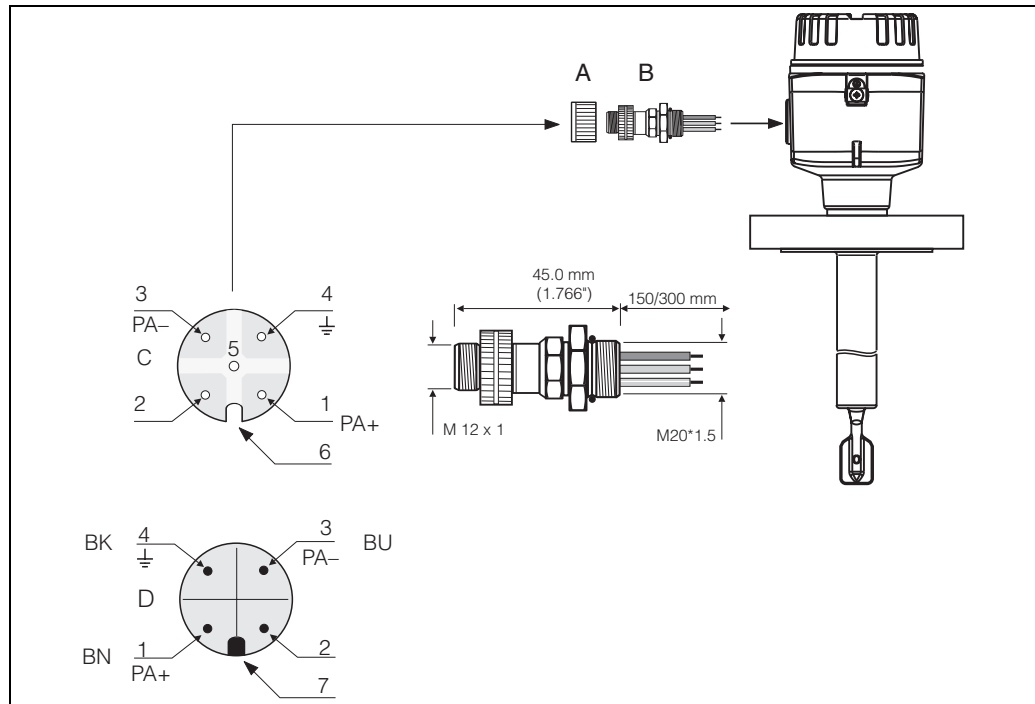

Fig. 8 Connectors for connecting to the PROFIBUS PA

A = Protection cap for device plug
 B = Fieldbus device plug
 C = Socket insert (female)
 D = Device plug on housing (male)

Pin assignment / color codes:

1 = Brown wire: PA+
 2 = Unconnected
 3 = Blue line: PA-
 4 = Black line: Ground (Notes for connection see page 15)
 6 = Positioning slot
 7 = Positioning lug

Technical data (field bus connector):

Connection cross section	0.75 mm ²
Connector thread	M20x1.5
Degree of protection	IP 67 in accordance with DIN 40050 IEC 529
Contact surface	CuZnAu
Housing material	CuZn, surface Ni
Flammability	V - 2 in accordance with UL - 94
Nominal current per contact	3 A
Nominal voltage	125...150 V DC in accordance with the VDE standard 01 10/ISO Group 10
Resistance to tracking	KC 600
Volume resistance	≤ 8 mΩ in accordance with IEC 512 Part 2
Insulation resistance	≤ 10 ¹² Ω in accordance with IEC 512 Part 2

4.5 Potential matching system

For maximum EMC protection, e.g. near frequency convertors, it is advisable to connect the housing and cable screening using a potential matching line (PAL) (maximum wire cross-sectional area: 4 mm², fixed conductor).

Please pay attention to the following points:

- Ground the device using the external ground terminal (only for devices in hazardous areas).
- The bus cable screening may not be interrupted.
- Ground the screening at each end of the cable, and always try to keep the connecting cable between the screening and ground as short as possible.
- With large potential differences between the individual ground points, only one point is connected with the reference ground. All the other screening ends are connected with an HF-compatible condenser with reference potential (e.g. ceramic condenser 10 nF/250 V~).



Caution!

Applications subject to explosion protection only have approval under certain conditions for multiple grounding of the protective screening, see EN 60079-14.

You can find further information on the structure and the grounding of the network in the operating manual BA 198F "PROFIBUS PA: Guideline on project planning and commissioning" and the PROFIBUS PA specification EN 50170 (DIN 19245).

4.6 Degree of protection

- Electronic insert: IP 20, NEMA 1
- Housing: depending on version, see KA ... (Basic device) table "Supplementary documentation" page 39

4.7 Post connection check

Perform the following checks after completing electrical mounting of the measuring device:

Device condition and specifications	Notes
Are cables or the device damaged (visual inspection)?	–
Electrical connection of meter	Notes
Does the supply voltage match the specifications on the nameplate?	9...32 V DC
Do the cables comply with the specifications?	see page 9
Do the cables have adequate strain relief?	–
Are the cables correctly segregated by type? Without loops and crossovers?	–
Are the fieldbus cables correctly connected?	See the wiring diagram inside the cover of the terminal compartment
Are all screw terminals firmly tightened?	–
Have all the measures pertaining to grounding and potential matching been carried out correctly?	see page 15
Are all cable entries installed, firmly tightened and correctly sealed? Cables looped as "water traps"?	–
Are all housing covers installed and firmly tightened?	–
PROFIBUS PA electrical connection	Notes
Are all the connecting components (T-boxes, junction boxes, connectors, etc.) connected together correctly?	–
Has each field bus segment been terminated at both ends with a bus terminator?	–
Has the maximum length of the field bus cable been observed in accordance with the PROFIBUS specifications?	see page 9
Has the maximum length of the spurs been observed in accordance with the PROFIBUS specifications?	see page 10
Is the field bus cable fully shielded and correctly grounded?	see page 10

5 Operation

5.1 Operation at a glance

You have a number of options for configuring and commissioning the measuring device:

1. Configuration programs

The profile and device-specific parameters are primarily configured using the PROFIBUS DP/PA interface. For this, there are special configuration and/or operating programs from different manufacturers available to the user.

2. Miniature switch

The settings from the PROFIBUS PA device bus address can be made using the miniature switch on the surface of the FEL 50 A.

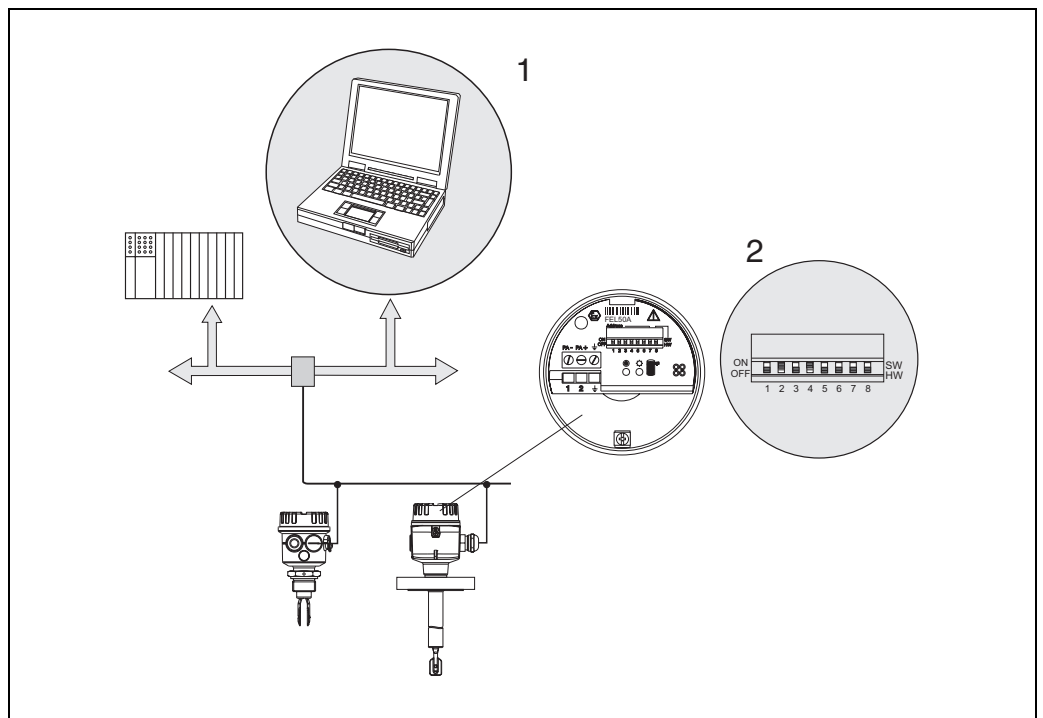

Fig. 9 Operation options for Liquiphant PROFIBUS PA

- 1 Configuration/operating programs for operation using PROFIBUS PA
- 2 Miniature switch for addressing

5.2 On-site configuration/operation

Only the device address can be set on the electronic insert.
The two light emitting diodes indicate standby or the status of the tuning fork (covered/free).

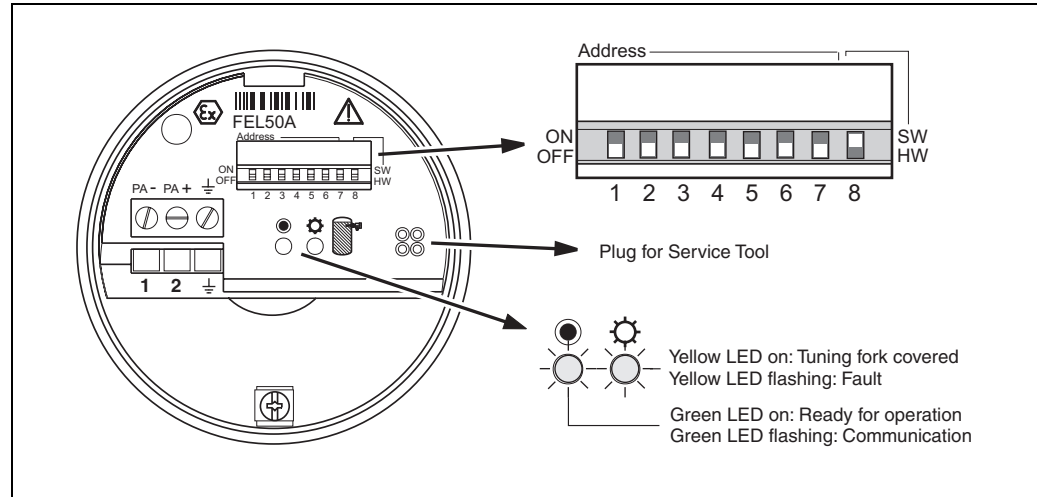

Fig. 10 On-site operation for Liquiphant PROFIBUS PA

5.2.1 Setting the device address

Choice of device address

- An address must be assigned to each PROFIBUS PA device. The process control system only recognises the device when the address is set correctly.
- In a PROFIBUS PA network, each address may be assigned only once.
- Valid device addresses are inside the range of 0 to 126. All the devices are supplied from the factory with the value 126.
- The factory-set address 126 can be used for a functional test of the device and for connections to a PROFIBUS PA network in operation. Subsequently, this address must be changed to be able to include additional devices.

Software Addressing

Software addressing is only effective if DIP switch 8 is in the "ON" position (factory setting).

For additional information on the addressing procedure, please consult operating manual BA198F, Chapter 5.7.

Hardware Addressing

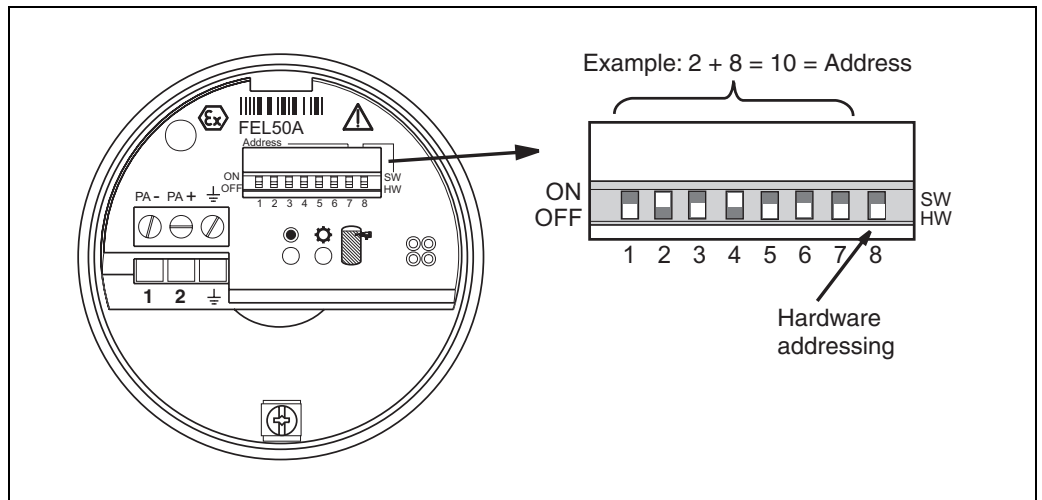

Fig. 11 Device addressing for Liquiphant PROFIBUS PA
(Example: Address 10 Hardware Addressing)

Hardware addressing is only effective if DIP switch 8 is in the "OFF" position. The address is then set using DIP switches 1 to 7 according to the following table:

Switch no.	1	2	3	4	5	6	7	8
Value in "ON" position	1	2	4	8	16	32	64	SW
Value in "OFF" position	0	0	0	0	0	0	0	HW
Example address	0	2	0	8	0	0	0	HW

The newly set address becomes valid 10 seconds after the change.

5.3 Communication PROFIBUS PA

5.3.1 System architecture

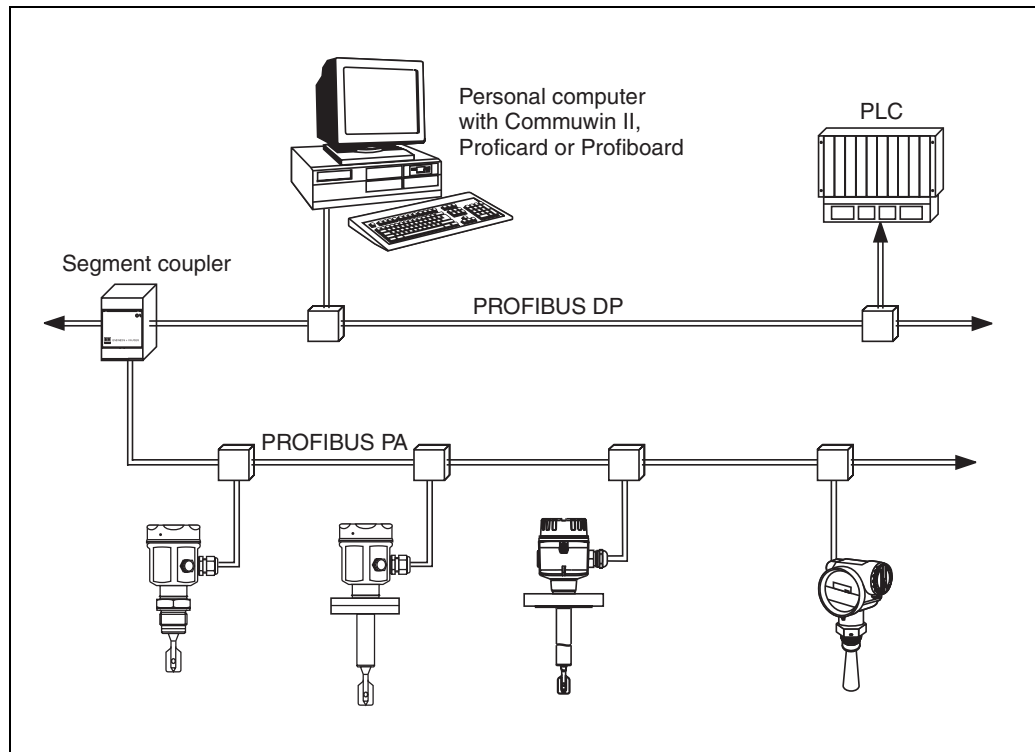

Fig. 12 System architecture PROFIBUS DP/PA

A maximum of 32 transmitters (10 in hazardous area EEx ia IIC acc. to FISCO model) can be connected to the bus per segment. The bus voltage is supplied by the segment coupler. Both on-site and remote operation are possible.

For more detailed information on the PROFIBUS PA standard, please consult the operating instructions BA 198F, and the standards EN 50170/DIN 19245 (PROFIBUS PA) and EN 50020 (FISCO model).

5.3.2 Device data bases (GSD)

The device data base (x.gsd) contains a description of the properties of a PROFIBUS PA device, e.g. which data transmission rate is supported by the device or which digital information in which format the PLC receives from the device. In addition, for project planning of a PROFIBUS DP network, you also require bitmap files with which the appropriate measuring point can be represented graphically in the project planning software.

Each device receives an ID number from the PROFIBUS User Organisation (PNO). The name of the device data base (GSD) and the appropriate files are derived from this. The Liquiphant has the ID number 0x152b (hex) = 5419 (dec).

Reference sources

- Internet (ftp server): <ftp://194.196.152.203/pub/communic/gsd/fel50a.exe>
- CD-ROM with all GSD files for E+H devices; Order No.: 50097200
- GSD library of the PROFIBUS User Organisation (PNO): <http://www.PROFIBUS.com>

Directory structure

The files are stored in the following directory structure:

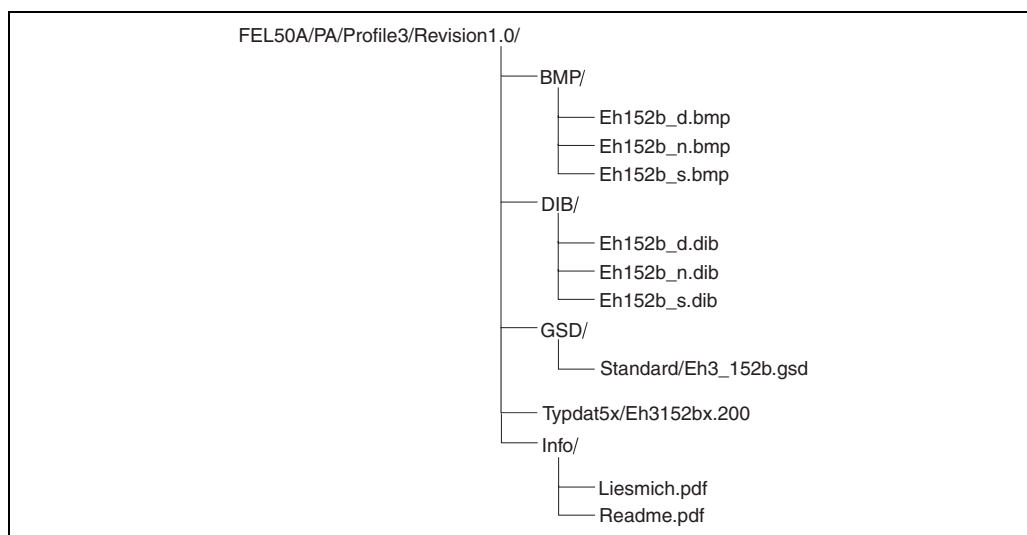

- The GSD file in the "Standard" directory is used for PLCs which do not support an "Identifier Format" but only an "Identifier Byte", e.g. PLC5 from Allen-Bradley.

General database file

Alternatively to the specific GSD, the PNO makes a general database file available with the designation PA139720.gsd for devices with a discrete input block. This file supports the transmission of the main measured value.

When using the general database file, in the function "**Ident Number**" (V6H0) you must select the setting "**Profile**".

5.3.3 Cyclical data exchange

Block model of the Liquiphant M/S (HT) with FEL 50 A

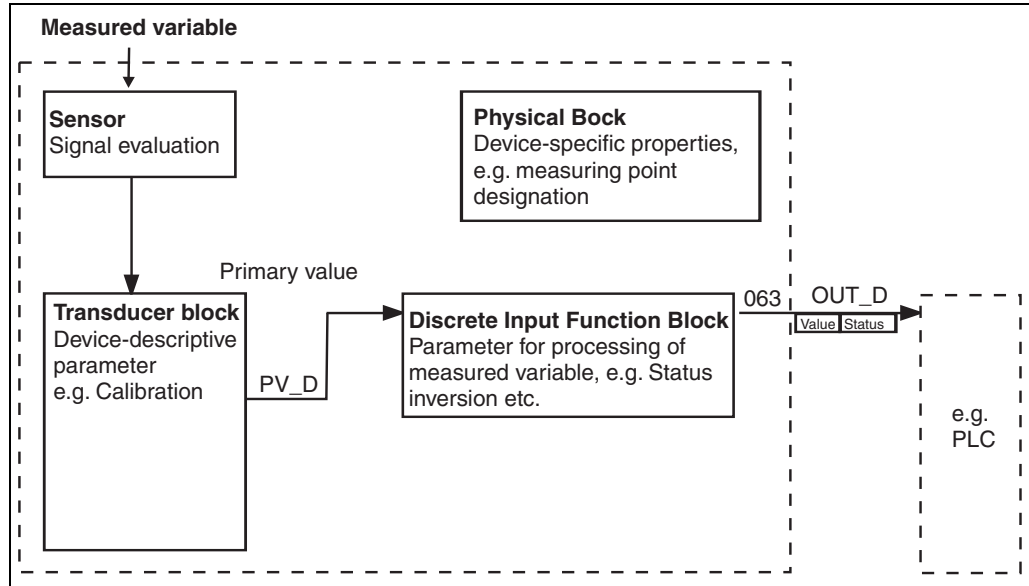

Fig. 13 Block model

The block model shows which data can be continuously exchanged during continuous operation (i.e. in cyclical data traffic) between the Liquiphant and the PLC.

- In the transducer block, a switching status and a status are derived from the measured variable (frequency of the oscillating fork) and the discrete input function block made available. There, it can be inverted and output to the PLC via **OUT_D**.

Configuration with Network Design Tool

Data exchange can be configured using a network design tool.

Use the network design tool for your PLC and add the Liquiphant to the network. Make sure that the assigned address agrees with the set device address.

Liquiphant → PLC (Input data)

With the Data_Exchange service, a PLC can read input data from the Liquiphant in the form of an answer mail. The cyclic data telegram has the following structure:

Index Input data	Data	Access	Data format/Remarks
0	Main measured value -> limit level: covered (1) / uncovered (0)	Read	1 Byte (0,1)
1	Status code for main measured value	Read	see "Status Codes"

Status Codes

The Status Codes OUT_D and PV_D are each 1byte in size and have the following meaning:

OUT_D (Discrete Input Function Block)

Status code	Device status	Meaning	Main measured value
80 Hex	GOOD	OK (error-free)	x
84 Hex	GOOD	Parameter changed (Static revision was increased)	x
51 Hex	UNCERTAIN	Signal conversion inaccurate Sensor EEPROM OK (Jam frequency reached, fork blocked or highly-viscous medium)	x
4C Hex	BAD	Initial value (Fail-safe-Mode aktiv)	Failsafe
44 Hex	BAD	Last usable value (Fail-safe-Mode aktiv)	Failsafe
10 Hex	BAD	Sensor Failure	Failsafe

PV_D (Transducer Block)

Status code	Device status	Meaning	Main measured value
80 Hex	GOOD	OK (error-free)	x
84 Hex	GOOD	Parameter changed (Static revision was increased)	x
51 Hex	UNCERTAIN	Signal conversion inaccurate Sensor EEPROM OK (Jam frequency reached, fork blocked or highly-viscous medium)	x
12 Hex	BAD	Sensor error (Corrosion alarm, frequency too high, fork corroded)	x
0D Hex	BAD	Device error (Jam frequency reached, Sensor EEPROM not OK, fork removed from EEPROM blocked)	x
04 Hex	BAD	Fork exchanged or false CS in the sensor EEPROM	x

5.3.4 Acyclical data exchange

With acyclic data exchange access, the instrument parameters in the physical, transducer and discrete input block can be accessed as can the device management with as PROFIBUS DP master class 2 (e.g. Commuwin II).

Slot/Index tables

The device parameters are listed in the table below. You can access the parameters using the slot and index numbers.

The individual blocks contain standard parameters, block parameters and manufacturer-specific parameters.

Device management

Parameter	E+H Matrix (CW II)	Slot	Index	Size [bytes]	Type	Read	Write	Storage Class
DIRECTORY_OBJECT_HEADER		1	0	12	Array of UNSIGNED16	x		constant
COMPOSITE_LIST_DIR_ENTRIES		1	1	24	Array of UNSIGNED16	x		constant

Discrete Input Function Block

Parameter	E+H Matrix (CW II)	Slot	Index	Size [bytes]	Type	Read	Write	Storage Class
Standard parameter								
BLOCK OBJECT		1	16	20	DS-32*	x		constant
ST_REVISION		1	17	2	UNSIGNED16	x		non-vol.
TAG_DESC		1	18	32	OSTRING	x	x	static
STRATEGY		1	19	2	UNSIGNED16	x	x	static
ALERT_KEY		1	20	1	UNSIGNED8	x	x	static
TARGET_MODE		1	21	1	UNSIGNED8	x	x	static
MODE_BLK		1	22	3	DS-37*	x		dynamic
ALARM_SUM		1	23	8	DS-42*	x		dynamic
BATCH		1	24	10	DS-67*	x	x	static
Gap		1	25					
Block parameter								
OUT_D	V6H2 (value) V6H3 (Status)	1	26	2	DS-34*	x		dynamic
CHANNEL		1	30	2	UNSIGNED16	x	x	static
INVERT	V3H3	1	31	1	UNSIGNED8	x	x	static
FAIL_SAFE_TYPE	V1H0	1	36	1	UNSIGNED8	x	x	static
FAIL_SAFE_VAL_D		1	37	1	UNSIGNED8	x	x	static
SIMULATE		1	40	3	DS-51	x	x	static
E+H Parameter								
VIEW_1 FB		1	56	13+2	OSTRING	x		

Discrete Input Transducer Block

Parameter	E+H Matrix (CW II)	Slot	Index	Size [bytes]	Type	Read	Write	Storage Class
Standard parameter								
BLOCK OBJECT		1	61	20	DS-32*	x		constant
ST_REVISION		1	62	2	UNSIGNED16	x		non-vol.
TAG_DESC		1	63	32	OSTRING	x	x	static
STRATEGY		1	64	2	UNSIGNED16	x	x	static
ALERT_KEY		1	65	1	UNSIGNED8	x	x	static

Parameter	E+H Matrix (CW II)	Slot	Index	Size [bytes]	Type	Read	Write	Storage Class
TARGET_MODE		1	66	1	UNSIGNED8	x	x	static
MODE_BLK		1	67	3	DS-37*	x		dynamic
ALARM_SUM		1	68	8	DS-42*	x		dynamic
Block parameter								
PV_D	V0H0	1	73		DS-34			constant
E+H Parameter								
FREQ_ACT_BASE	V0H8	1	84	4	FLOAT	x		dynamic
DENSITY_SWITCH	V3H2	1	85	1	UNSIGNED8	x	x	static
FREQ_AIR_BASE	V7H0	1	86	2	UNSIGNED16	x		non-vol.
FREQ_SWITCH_LOW_LD	V7H1	1	87	2	UNSIGNED16	x	x	static
FREQ_SWITCH_HIGH_LD	V7H2	1	88	2	UNSIGNED16	x	x	static
FREQ_SWITCH_LOW_HD	V7H1	1	89	2	UNSIGNED16	x	x	static
FREQ_SWITCH_HIGH_HD	V7H2	1	90	2	UNSIGNED16	x	x	static
TIME_DELAY_COVER	V3H0	1	95	4	FLOAT	x	x	static
TIME_DELAY_FREE	V3H1	1	96	4	FLOAT	x	x	static
OVERFILL_PROTECTION	V1H8	1	100	1	UNSIGNED8	x	x	static
VIEW_1 TB		1	105	13		x		

Physical Block

Parameter	E+H Matrix (CW II)	Slot	Index	Size [bytes]	Type	Read	Write	Storage Class
Standard Parameter								
BLOCK OBJECT		0	16	20	DS-32*	x		constant
ST_REVISION		0	17	2	UNSIGNED16	x		non-vol.
TAG_DESC		0	18	32	OSTRING	x	x	static
STRATEGY		0	19	2	UNSIGNED16	x	x	static
ALERT_KEY		0	20	1	UNSIGNED8	x	x	static
TARGET_MODE		0	21	1	UNSIGNED8	x	x	static
MODE_BLK		0	22	3	DS-37*	x		dynamic
ALARM_SUM		0	23	8	DS-42*	x		dynamic
SOFTWARE_REVISION		0	24	16	OSTRING	x		constant
HARDWARE_REVISION		0	25	16	OSTRING	x		constant
DEVICE_MAN_ID		0	26	2	UNSIGNED16	x		constant
DEVICE_ID		0	27	16	OSTRING	x		constant
DEVICE_SER_NUMBER	VAH5	0	28	16	OSTRING	x		constant
DIAGNOSIS		0	29	4	OSTRING	x		dynamic
DIAGNOSIS_EXTENSION		0	30	6	OSTRING	x		dynamic
DIAGNOSIS_MASK		0	31	4	OSTRING	x		constant
DIAGNOSIS_MASK_EXTENSION		0	32	6	OSTRING	x		constant
DEVICE_CERTIFICATION		0	33	32	OSTRING	x		constant
WRITE_LOCKING	V9H9	0	34	2	UNSIGNED16	x	x	non-vol.
FACTORY_RESET	V9H5	0	35	2	UNSIGNED16	x	x	static
DESCRIPTOR	VAH0	0	36	32	OSTRING	x	x	static
DEVICE_MESSAGE		0	37	32	OSTRING	x	x	static
DEVICE_INSTAL_DATE		0	38	8	OSTRING	x	x	static
LOCAL_OP_ENA		0	39	0	not supported	x	x	non-vol.
IDENT_NUMBER_SELECTOR	V6H0	0	40	1	UNSIGNED8	x	x	static

Parameter	E+H Matrix (CW II)	Slot	Index	Size [bytes]	Type	Read	Write	Storage Class
E+H Parameter								
ACTUAL_ERROR		0	54	2	UInteger16	x		dynamic
LAST_ERROR		0	55	2	UInteger16	x	x	dynamic/ non-vol.
UP_DOWN_FEAT_SUPPORT		0	56	1	OSTRING	x		constant
DEVICE_BAS_ADDRESS		0	59	1	Integer8	x		dynamic
DEVICE_SOFTWARE_NR		0	60	2	UInteger16	x		constant
DEVICE_ID_NUM		0	70	2	UInteger16	x		constant
VIEW_1 PB		0	71					

5.3.5 Parameter access with Commuwin II

Using a PROFIBUS DP master class 2 such as Commuwin II, you can access the block parameters. Commuwin II runs on an IBM compatible PC or Notebook. The computer must be equipped with a PROFIBUS interface, i.e. PROFIBOARD for PCs and PROFICARD for Notebooks. During system integration, the computer is logged-on as a master class 2.

Connection

- Profiboard for connection to PC
- Proficard for connection to laptop

Creation of device list

- Operation requires the mounting of the server PA-DPV1. Selecting "PA-DPV1" in the menu "Connection setup" sets up the connection and an empty device list appears.
- The device list with the tags is generated with the "Create with tag" checkbox.
- There are two operating modes:

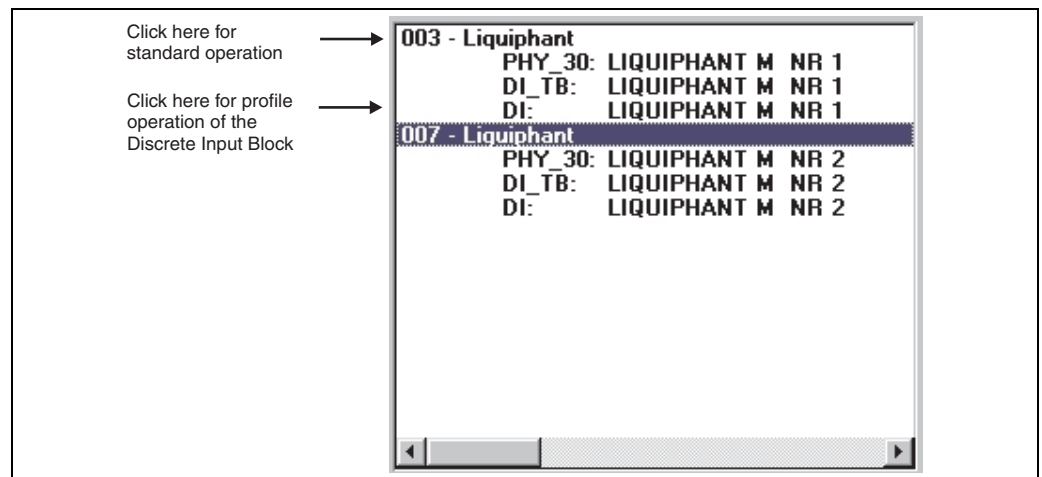

- Select **E+H standard operation** by clicking the device name.
- Select the **profile operation** of the PROFIBUS standard blocks by clicking the appropriate block (e.g. "DI" for the discrete input block of the Liquiphant). You can specify a tag name for each block.
- Configure the system using the "Device Data" menu.

"Device Data" menu

You can select between operation using a matrix or the graphic desktop using the Device Data menu.

- With **matrix operation**, the devices and/or the profile parameters are loaded into a matrix. In the case of standard option, this is the E+H standard matrix, in the case of profile operation, this is the block matrix of the selected block. You can change a parameter when the appropriate matrix field has been selected.
- With **graphical operation**, the operation sequence is represented in a series of images with parameters. The images "Status" and "Calibration" are available.

The meaning of the parameters and configuration sequence are described in Chap. 6.

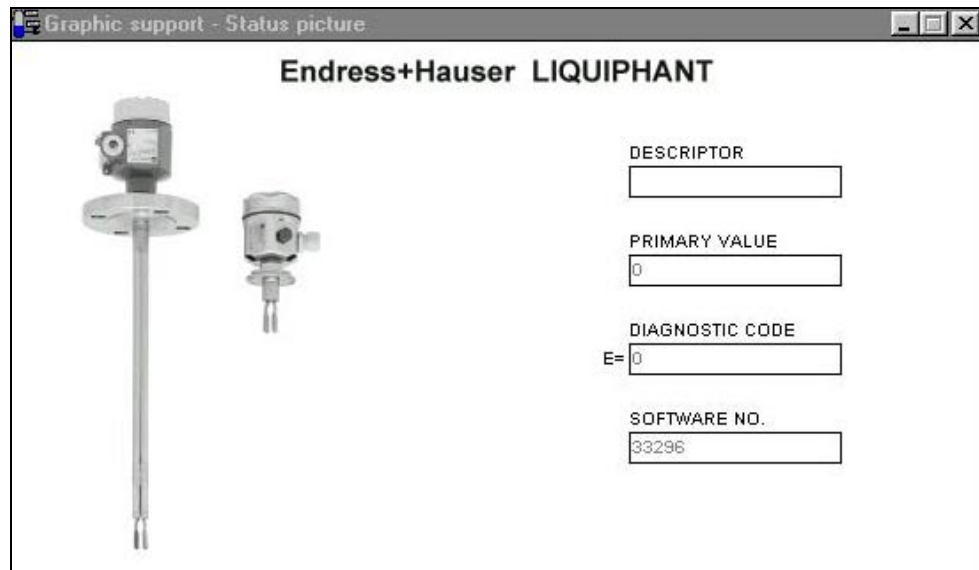

Fig. 14 Graphic operation with "Status"

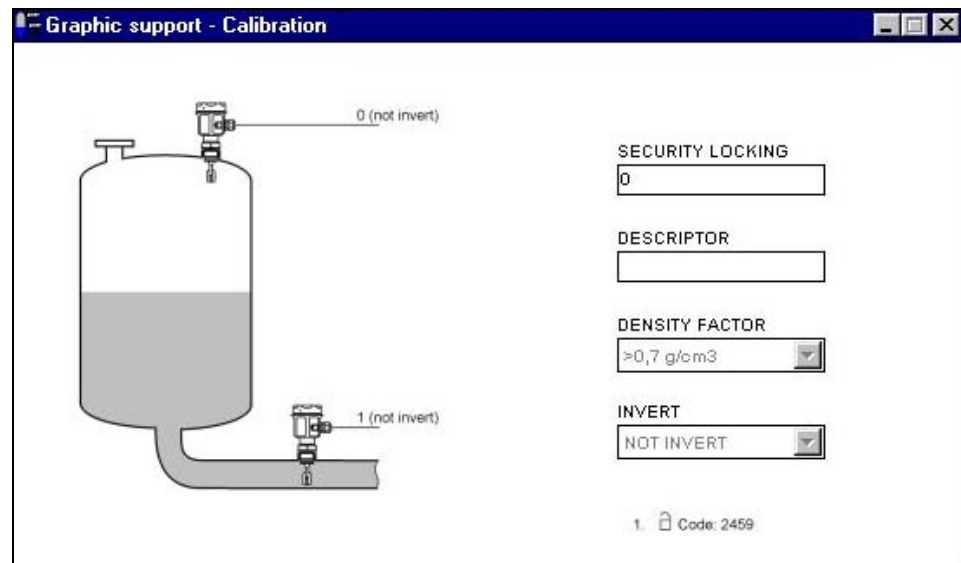

Fig. 15 Graphic operation with "Calibration"



Note!

You can find further information on the Commuwin II operating program in the operating instructions BA 124F.

6 Commissioning

6.1 Mounting and function check

Make sure that the Mounting and connection checks have been carried out before you commission your measuring point:

- "Connection check" checklist (see page 16).

6.2 Commissioning with Commuwin II

As soon as you have connected the device to the PA bus and switched on the power supply, the Liquiphant limit switch is operational. This is indicated by the green operation LED. If the LED is flashing, then the device is communicating. The device was preset before leaving the factory.

1. Start Commuwin II and set up the connection to the bus via the server PA-DPV1. After this, create the device list, define the device address and select "Liquiphant" by clicking.
2. Click the matrix icons. The Commuwin II operating matrix is displayed.

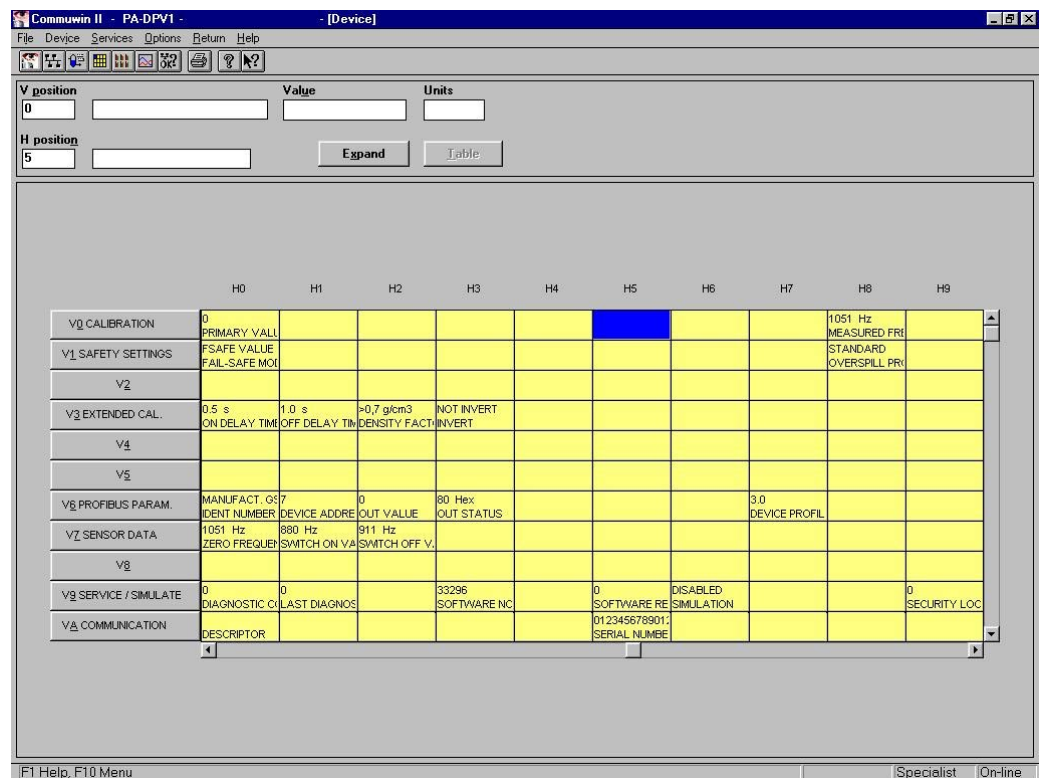

Fig. 3 Commuwin II user interface

6.2.1 Operation using Commuwin II matrix

Matrix field	Meaning	Selection/Input
V3H2	Changing the density factor	>0.7 g/cm ³ >0.5 g/cm ³
V3H3	Inversion of the output value	Not inverted: Sensor covered → Output "1" Inverted: Sensor covered → Output "0"
V3H0 V3H1	Setting the delay times	0.5...60 seconds
VAH0	Assignment of the TAG	Maximum 32 characters
V1H0	Failure response	FSAFE VALUE:→ Output of fail-safe value ~ VH21 input in the Discrete Input Block (FSAFE_VAL_D) WRONG VALUE:→ Output of detected value LAST_GOOD_VALUE:→ Output of the last valid value See page 23: → OUT_D Device status = BAD
VH99	Unlocking the matrix	0 - xxxx locks 2457 33998 enables VH18 selection
VH18	Operating mode	STANDARD WHG
VH96	Simulation	DISABLE ENABLE (VH00 is manipulated via VH97 (0.1))
VH97	Simulation value	0,1 → Simulation from VH00

Note:

If the device has been put into WHG mode, the matrix is automatically locked.
This lock can only be lifted with VH99 = 33998 + VH18 = STANDARD.

6.2.2 Commuwin II operating matrix

	H0	H1	H2	H3	H4	H5	H6	H7	H8	H9
V0 CALIBRATION	PRIMARY VALUE (Display)								MEASURED FREQ. (Display)	
V1 SAFETY SETTINGS	FSAFE VALUE FAIL-SAFE MODE (Selection)								OVERSPILL PROT. (Options)	
V2										
V3 EXTENDED CAL.	ON DELAY TIME (Input)	OFF DELAY TIME (Input)	DENSITY FACTOR (Selection)	INVERT (Selection)						
V4										
V5										
V6 PROFIBUS PARAM:	MANUFACT. GSD IDENT NUMBER (Selection)	DEVICE ADDRESS (Display)	OUT VALUE (Display)	OUT STATUS (Display)				DEVICE PROFILE (Display)		
V7 SENSOR DATA	ZERO FREQUENCY (Display, Service)	SWITCH-ON VALUE (Display, Service)	SWITCH-OFF VALUE (Display, Service)							
V8										
V9 SERVICE / SIMULATE	DIAGNOSTIC CODE (Display, Service)	LAST DIAGN. CODE (Display, Service)		SOFTWARE NO. (Display, Service)		SOFTWARE RESET (Input, Service)	SIMULATION (Selection, Service)	SIMULATION VALUE (Input, Service)		SECURITY LOCKING (Selection)
VA COMMUNICATION	DESCRIPTOR (Input)					SERIAL NUMBER (Display)				

7 Maintenance

See KA ... (Basic device), table "Supplementary documentation" page 39.

8 Accessories

There is a range of accessories available for the Liquiphant. These can be ordered separately from Endress+Hauser.

Commuwin II

Operating program for intelligent devices → Order No.: FXS 113-###

Proficard

For connection of a laptop to the PROFIBUS → Order No.: 016570-5260

Profiboard

For connection of a PC to the PROFIBUS → Order No.: 52005721

For additional accessories for the Liquiphant, see KA ... (Basic device) table page 39..

9 Troubleshooting

9.1 System error messages

Code	Error description	Cause	Action
101 A	Checksum error Total reset and recalib. req.		<ul style="list-style-type: none"> • Reset • If alarm still present after reset, replace electronics
102 A	Checksum error Total reset and recalib. req.	<ul style="list-style-type: none"> • Device switched off before data was saved • EMC problem • E2PROM defective 	<ul style="list-style-type: none"> • Reset • Avoid EMC problems • If alarm still present after reset, replace electronics
125 A	Sensor defective	<ul style="list-style-type: none"> • Fork removed • Chopping frequency reached 	<ul style="list-style-type: none"> • Insert fork • Check fork for blockage and remove same as necessary
W103	Initialisation active	Device start-up after reset	Wait

Tab. 1 System error messages

For other error possibilities, see KA ... (Basic device) table page 39.

9.2 Spare parts

For spare parts KA ... (Basic device) table "Supplementary documentation" page 39.



Note!

You can order spare parts directly from your E+H service organisation using the serial number which is printed on the transmitter nameplate (see page 6). The corresponding spare part number is found on every spare part. Installation instructions are printed on the enclosed package insert.

If the device designation changes, you must order a changed nameplate. You must then transfer the data for the new device to the changed nameplate and then fix the plate to the housing of the Liquiphant. See information in package insert.



Caution!

- It is not possible to convert a standard device into an Ex-system by replacing parts.
- When repairing certified device, keep to the appropriate regulations.
- With FM approved devices, it is forbidden to make changes to the device which are not expressly approved in the operating instructions. A violation of this ban may make the approval for operating this device null and void.

9.3 Return

See KA ... (Basic device) table "Supplementary documentation" page 39.

9.4 Software history

Software version / date	Changes to software	Changes to documentation
V 1.00 / 10.2001	Original software. Compatible with: – Commuwin II (version 2.05.03 and higher)	

9.5 Contact addresses of Endress+Hauser

On the rear page of these operating instructions, you can find the contact addresses of Endress+Hauser, to whom you should address your queries.

10 Technical data

10.1 Technical data at a glance

Application																								
<i>Application</i>	Maximum or minimum detection in tanks or piping with fluids of all types, also in hazardous areas and in the food and pharmaceuticals industries.																							
Function and system design																								
<i>Measuring principle</i>	The tuning fork of the sensor oscillates in resonance frequency. This frequency is reduced when covered with liquid. The change in frequency then activates a limit switch.																							
<i>Measuring device</i>	The device possesses a digital output with PROFIBUS PA protocol.																							
Input variables																								
<i>Measured variable</i>	Level (limit value)																							
<i>Fluid density</i>	Configuration using Commuwin II: > 0.5 g/cm ³ or > 0.7 g/cm ³																							
Output variables																								
<i>Output signal</i>	<ul style="list-style-type: none"> PROFIBUS PA <table border="1"> <thead> <tr> <th>Setting</th> <th>Level limit</th> <th>GN</th> <th>YE</th> <th>FEL 50A</th> </tr> </thead> <tbody> <tr> <td rowspan="2">not inverted</td> <td></td> <td></td> <td></td> <td>OUT_D = 0 PA-Bussignal</td> </tr> <tr> <td></td> <td></td> <td></td> <td>OUT_D = 1 PA-Bussignal</td> </tr> <tr> <td rowspan="2">inverted</td> <td></td> <td></td> <td></td> <td>OUT_D = 1 PA-Bussignal</td> </tr> <tr> <td></td> <td></td> <td></td> <td>OUT_D = 0 PA-Bussignal</td> </tr> </tbody> </table>	Setting	Level limit	GN	YE	FEL 50A	not inverted				OUT_D = 0 PA-Bussignal				OUT_D = 1 PA-Bussignal	inverted				OUT_D = 1 PA-Bussignal				OUT_D = 0 PA-Bussignal
Setting	Level limit	GN	YE	FEL 50A																				
not inverted				OUT_D = 0 PA-Bussignal																				
				OUT_D = 1 PA-Bussignal																				
inverted				OUT_D = 1 PA-Bussignal																				
				OUT_D = 0 PA-Bussignal																				
<i>Signal on alarm</i>	Failure information can be opened using the following interfaces: <ul style="list-style-type: none"> Flashing yellow LED Status code Diagnosis code 																							
Power supply																								
<i>Electrical connections</i>	<ul style="list-style-type: none"> 3 screw terminals PROFIBUS PA M12 plug-in connector 																							
<i>Cable entries</i>	Cable gland: M20x1.5 or Pg 13.5 Cable entry: G 1/2 or 1/2 NPT PROFIBUS PADiscrete-Input-Block M12 plug-in connector																							
<i>Supply voltage</i>	Two-core cable connection, 9...32 V DC																							
<i>Power consumption</i>	100...350 mW																							

Measuring accuracy	
<i>Reference operating conditions</i>	<ul style="list-style-type: none"> • Ambient temperature: 23 °C • Medium temperature: 23 °C • Fluid density: 1 g/cm³ (water) • Medium viscosity: 1 mm²/s • Medium pressure: 0 bar • Sensor Mounting: vertical from above • Density setting: > 0.7
<i>Accuracy</i>	<ul style="list-style-type: none"> • Measuring error: specified constructively max. ±1 mm • Repeatability: 0.1 mm • Switching hysteresis: approx. 2 mm • Impact of medium temperature: max. +1.4...-2.8 mm (-50...+150 °C) • Impact of medium density: max. +4.8...-3.5 mm (0.5...1.5 g/cm³) • Influence of medium pressure: max. 0...-2.5 mm (0 ...64 bar)
Operating conditions	
Installation conditions	
<i>Installation instructions</i>	See KA ... (Basic device) table page 39.
Environment conditions	
<i>Ambient temperature</i>	-50... +70 °C For operation outdoors with strong sunlight penetration, you should use a protective cover.
<i>Storage temperature</i>	-50...+80 °C
<i>Climate class</i>	IEC 68, Part 2-38, Fig. 2a
<i>Degree of protection</i>	Polyester, steel and aluminium housing: IP 66 / IP 67 to EN 60529 Aluminium housing (EEx d, EEx de): IP 66 / IP 68 to EN 60529 (1 m, 24h)
<i>Vibration resistance</i>	IEC 68, Part 2-6; (10...55 Hz, 0.15 mm, 100 cycles)
<i>Electromagnetic compatibility (EMC)</i>	<ul style="list-style-type: none"> • Interference emission to EN 61326; Equipment Class B • Interference immunity to EN 61326; Appendix A (Industrial sector, 10 V/m) and NAMUR recommendation NE 21 (EMC).
Process conditions	
<i>Process temperature range</i>	Liquiphant M: -50...+150 °C Liquiphant S (HT): -60...+280 °C (optionally 300 °C) (For exceptions, see Process Connections)
<i>Process pressure limits</i>	-1...+64 bar across complete temperature range (For exceptions, see Process Connections)
<i>State of aggregation</i>	Fluid
<i>Density</i>	min. 0.5 g/cm ³
<i>Viscosity</i>	maximum 10'000 mm ² /s
<i>Solid matter</i>	maximum dia. 5 mm
Mechanical construction	
<i>Design / dimensions</i>	See KA ... (Basic device) table "Supplementary documentation" page 39.
<i>Weight</i>	See KA ... (Basic device) table "Supplementary documentation" page 39.
<i>Materials</i>	See KA ... (Basic device) table "Supplementary documentation" page 39.

<i>Process connection</i>	See KA ... (Basic device) table page 39.
User interface	
<i>Operating concept</i>	<ul style="list-style-type: none"> On-site operation: Miniature switch for addressing Commuwin II
<i>Display</i>	<p>1 green LED: Standby/communication 1 yellow LED: Covered status of tuning fork/error display</p>
Certificates and approvals	
<i>CE mark</i>	The measuring system is in conformity with the statutory requirements of the EC Directives. Endress+Hauser confirms successful testing of the device by affixing the CE mark.
<i>Overspill protection</i>	to WHG
<i>External standards and guidelines</i>	<p>EN 60529 Degrees of protection by housing (IP code)</p> <p>EN 61010 Protection Measures for Electrical Equipment for Measurement, Control, Regulation and Laboratory Procedures.</p> <p>EN 61326 Interference emission (Equipment Class B), interference immunity (Appendix A - Industrial sector)</p> <p>NAMUR Association for Standards for Control and Regulation in the Chemical Industry</p>
<i>Ex Approvals</i>	<p>ATEX II 1/2 G+D EEx ia IIC T6 _____ XA 154F ATEX II 1/2 G EEx ia IIC T6 (Including warning "Electrostatic discharge") _____ XA 158F ATEX II 1 G EEx ia IIC T6 _____ XA 159F ATEX II 1/2 G EEx d IIC T6 _____ XA 031F ATEX II 1/2 G EEx de IIC T6 _____ XA 108F</p>
Ordering information	
	The E+H service organisation can provide detailed ordering information and information on the order codes on request.
Accessories	
	See page 33.
Supplementary documentation	
<i>Documentation</i>	<ul style="list-style-type: none"> SI 027F "PROFIBUS" (Systeminformation) TI 328F "Liquiphant M FTL 50/FTL 51 H" (Technical Information) TI 347F "Liquiphant M FTL 51 C" (Technical Information) TI 354F "Liquiphant S FTL 70/FTL 71" (Technical Information) KA 143F "Liquiphant M FTL 50/FTL 51" (Operating Instructions) KA 144F "Liquiphant M FTL 50 H/FTL 51 H" (Operating Instructions) KA 162F "Liquiphant M FTL 51 C" (Operating Instructions) KA 163F "Liquiphant M FTL 50-#####7#" (Operating Instructions) KA 164F "Liquiphant M FTL 50 H-#####7#" (Operating Instructions) KA 172F "Liquiphant S FTL 70/FTL 71" (Operating Instructions) KA 173F "Liquiphant S FTL 70/71 -#####7#" (Operating Instructions) BA 198F "PROFIBUS DP/PA: Guidelines on project planning and commissioning" (Operating Instructions)

Europe

Austria □ Endress+Hauser Ges.m.b.H. Wien Tel. (01) 88056-0, Fax (01) 88056-35
Belarus □ Belorgsintez Minsk Tel. (0172) 263166, Fax (0172) 263111
Belgium / Luxembourg □ Endress+Hauser N.V. Brussels Tel. (02) 2480600, Fax (02) 2480553
Bulgaria INTERTECH-AUTOMATION Sofia Tel. (02) 664869, Fax (02) 9631389
Croatia □ Endress+Hauser GmbH+Co. Zagreb Tel. (01) 6637785, Fax (01) 6637823
Cyprus I+G Electrical Services Co. Ltd. Nicosia Tel. (02) 484788, Fax (02) 484690
Czech Republic □ Endress+Hauser GmbH+Co. Praha Tel. (026) 6784200, Fax (026) 6784179
Denmark □ Endress+Hauser A/S Søborg Tel. (70) 131132, Fax (70) 132133
Estonia ELVI-Aqua Tartu Tel. (7) 441638, Fax (7) 441582
Finland □ Endress+Hauser Oy Espoo Tel. (09) 8676740, Fax (09) 86767440
France □ Endress+Hauser S.A. Huningue Tel. (389) 696768, Fax (389) 694802
Germany □ Endress+Hauser Messtechnik GmbH+Co. Weil am Rhein Tel. (07621) 975-01, Fax (07621) 975-555
Great Britain □ Endress+Hauser Ltd. Manchester Tel. (0161) 2865000, Fax (0161) 9981841
Greece I & G Building Services Automation S.A. Athens Tel. (01) 9241500, Fax (01) 9221714
Hungary Mile Ipari-Elektro Budapest Tel. (01) 2615535, Fax (01) 2615535
Iceland BIL ehf Reykjavik Tel. (05) 619616, Fax (05) 619617
Ireland Flomeaco Company Ltd. Kildare Tel. (045) 868615, Fax (045) 868182
Italy □ Endress+Hauser S.p.A. Cernusco s/N Milano Tel. (02) 921921, Fax (02) 92107153
Latvia Rino TK Riga Tel. (07) 312897, Fax (07) 312894
Lithuania UAB "Agava" Kaunas Tel. (07) 202410, Fax (07) 207414

Netherlands □ Endress+Hauser B.V. Naarden Tel. (035) 6958611, Fax (035) 6958825
Norway □ Endress+Hauser A/S Tranby Tel. (032) 859850, Fax (032) 859851
Poland □ Endress+Hauser Polska Sp. z o.o. Warszawa Tel. (022) 7201090, Fax (022) 7201085
Portugal Tecnisis - Tecnica de Sistemas Industriais Linda-a-Velha Tel. (21) 4267290, Fax (21) 4267299
Romania Romconseng S.R.L. Bucharest Tel. (01) 4101634, Fax (01) 4101634
Russia □ Endress+Hauser Moscow Office Moscow Tel. (095) 1587564, Fax (095) 1589871
Slovakia Transcom Technik s.r.o. Bratislava Tel. (7) 44888684, Fax (7) 44887112
Slovenia □ Endress+Hauser D.O.O. Ljubljana Tel. (061) 1592217, Fax (061) 1592298
Spain □ Endress+Hauser S.A. Sant Just Desvern Tel. (93) 4803366, Fax (93) 4733839
Sweden □ Endress+Hauser AB Sollentuna Tel. (08) 55511600, Fax (08) 55511655
Switzerland □ Endress+Hauser AG Reinach/BL 1 Tel. (061) 7157575, Fax (061) 7111650
Turkey Intek Endüstriyel Ölçü ve Kontrol Sistemleri tanbul Tel. (0212) 2751355, Fax (0212) 2662775
Ukraine Photonika GmbH Kiev Tel. (44) 26881, Fax (44) 26908
Yugoslavia Rep. Meris d.o.o. Beograd Tel. (11) 4441966, Fax (11) 4441966

Africa

Egypt Anasia Heliopolis/Cairo Tel. (02) 4179007, Fax (02) 4179008
Morocco Oussama S.A. Casablanca Tel. (02) 241338, Fax (02) 402657
South Africa □ Endress+Hauser Pty. Ltd. Sandton Tel. (011) 4441386, Fax (011) 4441977
Tunisia Controle, Maintenance et Regulation Tunis Tel. (01) 793077, Fax (01) 788595

America

Argentina □ Endress+Hauser Argentina S.A. Buenos Aires Tel. (01) 145227970, Fax (01) 145227909

Bolivia Tritec S.R.L. Cochabamba Tel. (042) 56993, Fax (042) 50981
Brazil □ Samson Endress+Hauser Ltda. Sao Paulo Tel. (011) 50313455, Fax (011) 50313067
Canada □ Endress+Hauser Ltd. Burlington, Ontario Tel. (905) 6819292, Fax (905) 6819444
Chile □ Endress+Hauser Chile Ltd. Santiago Tel. (02) 3213009, Fax (02) 3213025
Colombia Colsein Ltda. Bogota D.C. Tel. (01) 2367659, Fax (01) 6104186
Costa Rica EURO-TEC S.A. San Jose Tel. (02) 961542, Fax (02) 961542
Ecuador Insetec Cia. Ltda. Quito Tel. (02) 269148, Fax (02) 461833
Guatemala ACISAAutomatizacionYControlIndustrial S.A. Ciudad de Guatemala, C.A. Tel. (03) 345985, Fax (03) 327431
Mexico □ Endress+Hauser S.A. de C.V. Mexico City Tel. (5) 5682405, Fax (5) 5687459
Paraguay Incoel S.R.L. Asuncion Tel. (021) 213989, Fax (021) 226583
Uruguay Circular S.A. Montevideo Tel. (02) 925785, Fax (02) 929151
USA □ Endress+Hauser Inc. Greenwood, Indiana Tel. (317) 535-7138, Fax (317) 535-8498
Venezuela Control C.A. Caracas Tel. (02) 9440966, Fax (02) 9444554

Asia

China □ Endress+Hauser Shanghai Instrumentation Co. Ltd. Shanghai Tel. (021) 54902300, Fax (021) 54902303
□ Endress+Hauser Beijing Office Beijing Tel. (010) 68344058, Fax: (010) 68344068
Hong Kong □ Endress+Hauser HK Ltd. Hong Kong Tel. 25283120, Fax 28654171
India □ Endress+Hauser (India) Pvt Ltd. Mumbai Tel. (022) 8521458, Fax (022) 8521927
Indonesia PT Grama Bazita Jakarta Tel. (21) 7975083, Fax (21) 7975089
Japan □ Sakura Endress Co. Ltd. Tokyo Tel. (0422) 540613, Fax (0422) 550275
Malaysia □ Endress+Hauser (M) Sdn. Bhd. Petaling Jaya, Selangor Darul Ehsan Tel. (03) 7334848, Fax (03) 7338800

Pakistan Speedy Automation Karachi Tel. (021) 7722953, Fax (021) 7736884
Papua-Neuguinea SBS Electrical Pty Limited Port Moresby Tel. 3251188, Fax 3259556
Philippines □ Endress+Hauser Philippines Inc. Metro Manila Tel. (2) 3723601-05, Fax (2) 4121944
Singapore □ Endress+Hauser (S.E.A.) Pte., Ltd. Singapore Tel. 5668222, Fax 5666848
South Korea □ Endress+Hauser (Korea) Co., Ltd. Seoul Tel. (02) 6587200, Fax (02) 6592838
Taiwan Kingjari Corporation Taipei R.O.C. Tel. (02) 27183938, Fax (02) 27134190
Thailand □ Endress+Hauser Ltd. Bangkok Tel. (2) 9967811-20, Fax (2) 9967810
Vietnam Tan Viet Bao Co. Ltd. Ho Chi Minh City Tel. (08) 8335225, Fax (08) 8335227
Iran PATSA Co. Tehran Tel. (021) 8754748, Fax (021) 8747761
Israel Instrumetrics Industrial Control Ltd. Tel-Aviv Tel. (03) 6480205, Fax (03) 6471992
Jordan A.P. Parpas Engineering S.A. Amman Tel. (06) 4643246, Fax (06) 4645707
Kingdom of Saudi Arabia Anasia Ind. Agencies Jeddah Tel. (02) 6710014, Fax (02) 6725929
Lebanon Network Engineering Jbeil Tel. (3) 944080, Fax (9) 548038
Sultanate of Oman Mustafa & Jawad Science & Industry Co. L.L.C. Ruwi Tel. 602009, Fax 607066
United Arab Emirates Descon Trading EST. Dubai Tel. (04) 2653651, Fax (04) 2653264
Yemen YemenCompany for Ghee and Soap Industry Taiz Tel. (04) 230664, Fax (04) 212338

Australia + New Zealand

Australia ALSTOM Australia Limited Milperra Tel. (02) 97747444, Fax (02) 97744667
New Zealand EMC Industrial Group Limited Auckland Tel. (09) 4155110, Fax (09) 4155115

All other countries

□ Endress+Hauser GmbH+Co. Instruments International D-Weil am Rhein Germany Tel. (07621) 975-02, Fax (07621) 975345

□ Members of the Endress+Hauser Group

Endress + Hauser

The Power of Know How

