

ELECTRONICS

COMPLETING THE CIRCUIT



Unite Your Audience
The Martin Audio Experience



MARTIN AUDIO ELECTRONICS COMPLETING THE CIRCUIT





Top quality loudspeakers require top quality amplification and control. Martin Audio offers just that with our Power Amplifiers and System Controllers.

With Martin Audio's enviable reputation for producing loudspeakers with excellent performance and high durability it is no surprise that our name appears on an equally prestigious range of high quality amplifiers and controllers, offering optimised performance for our loudspeakers.

With models suited to both touring and installed audio environments, our electronic audio components supply the uncompromising sonic performance and unquestionable reliability required by the most demanding of today's sound reinforcement applications.

iKON

The iKON Series of 4 and 8-channel power amplifiers combine very high power density with superb audio performance, state-of-the-art DSP and network control. A dedicated controller amplifier for Martin Audio Wavefront Precision line arrays and XE Series stage monitors, the iKON series can also provide multi-channel amplification across the Martin Audio loudspeaker range.



iK42

Four-Channel Class D Amplifier



The iK42 can deliver a full 5000 watts per channel into 2Ω with all channels driven while remaining highly efficient. Its high efficiency reduces the energy drawn from the mains supply and ensures the power reserves needed to deliver superb sound under arduous live conditions.

Ethernet is used for system remote control and monitoring via Martin Audio's VU-NET software application, while a user friendly front panel interface allows full local control of all features. Dante digital audio network inputs are also provided for digital audio distribution and control.

Powerful DSP is fully integrated into the iK42 to provide a multitude of features that ensure maximum performance and worldwide compatibility of XE monitors. It also provides up to 1000 FIR filter taps @ 48kHz on each output channel, which is essential to implement DISPLAY's wide bandwidth optimisation process in WP line array systems.

The iK42 employs comprehensive protection functions to maintain safe operating conditions of both the amplifier and the loudspeakers driven — including a sophisticated loudspeaker limiter suite which incorporates peak, RMS and excursion limiting, as well as multiband limiting for passive 2-way systems.

FEATURES

- Four channels of efficient Class D amplification
- Very high power density in 2U rack height
- Up to 20,000 Watts total power output, depending on load impedance
- High performance 96kHz DSP on all inputs and outputs (48kHz on outputs when implementing FIR filters)
- Switch mode power supply
- Global mains operation, 85V to 240V auto-sensing
- Intuitive, user-friendly, front panel interface
- Analogue, AES3 and Dante™ digital audio network inputs
- Ethernet network for system operation, control and monitoring via Martin Audio VU-NET™ software
- Comprehensive protection and monitoring functions

APPLICATIONS

- Dedicated system amplifier for Martin Audio Wavefront Precision Series and XE Monitor Series
- Versatile multi-channel amplification for Martin Audio loudspeaker systems

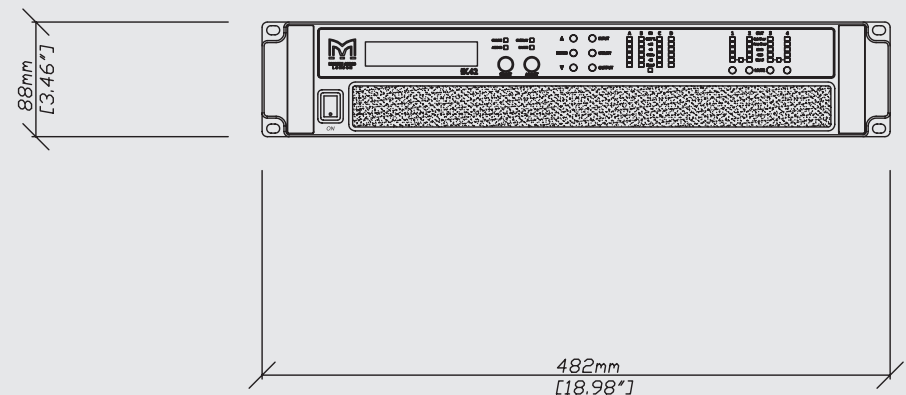

iK81

Eight Channel Class D Amplifier



The iK81 can deliver a full 1250 watts per channel into 2, 4 or 8 ohms with all channels driven while remaining highly efficient. Its high efficiency reduces the energy drawn from the mains supply and ensures the power reserves needed to deliver superb sound under arduous live conditions.

Ethernet is used for system remote control and monitoring via Martin Audio's VU-NET software application, while a user friendly front panel interface allows full local control of all features. Dante digital audio network inputs are also provided for digital audio distribution and control.

Powerful DSP is fully integrated into the iK81 to provide a multitude of features. It also provides up to 1000 FIR filter taps @ 48kHz on each output channel, which is essential to implement DISPLAY's wide bandwidth optimisation process in the WPM line array.

The iK81 employs comprehensive protection functions to maintain safe operating conditions of both the amplifier and the loudspeakers driven — including a sophisticated loudspeaker limiter suite which incorporates peak, RMS and excursion limiting, as well as multiband limiting for passive 2-way systems.

FEATURES

- Eight channels of efficient Class D amplification
- Very high power density in 2U rack height
- 10,000 Watts total power output
- High performance 96kHz DSP on all inputs and outputs (48kHz on outputs when implementing FIR filters)
- Switch mode power supply
- Global mains operation, 85V to 240V auto-sensing
- Intuitive, user-friendly, front panel interface
- Analogue, AES3 and Dante™ digital audio network inputs
- Ethernet network for system control and monitoring via Martin Audio VU-NET™ software application
- Comprehensive protection and monitoring functions

APPLICATIONS

- Dedicated system amplifier for the Wavefront Precision Series
- Versatile multi-channel amplification for Martin Audio loudspeaker systems

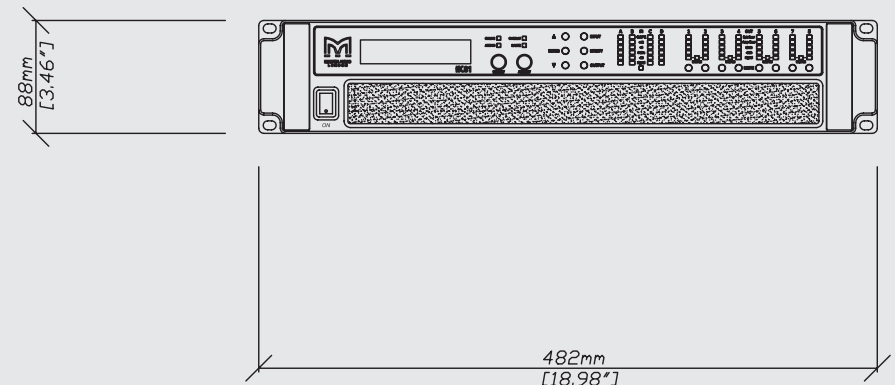

VIA^o

VIA is a new range of four high performance, cost effective power amplifiers designed primarily for installation use, but also suited to portable applications.



VIA2502

Two-Channel Class D Amplifier



The VIA2502 is an advanced 2-channel power amplifier which combines high power density with superb audio performance in a lightweight, cost-effective package. Delivering 2 x 1250 watts into 2 ohms, or 1 x 2500 watts into 4 ohms bridged, it is ideal for powering Blackline X, CDD and V. Series systems in small to medium-scale installations and portable sound applications.

Its high efficiency design reduces the energy drawn from the mains supply and ensures the power reserves needed to deliver superb sound in demanding environments with reliability and ease.

Comprehensive protection functions continuously monitor its performance to maintain safe operating conditions and full output capability in ambient temperatures up to 40°C.

For a wide variety of installations and portable situations, the VIA2502 is ideally partnered with the Martin Audio DX0.5 system processor. Larger installations will benefit from use with the DX4.0 processor with its onboard network capability and proprietary VU-NET software control.

FEATURES

- Two channels of efficient Class D amplification
- 2500 Watts total power output
- 2U rack height
- Exceptionally lightweight
- Switch mode power supply
- Variable speed cooling fans with front-to-back airflow
- Global mains operation, 100-240V auto-sensing
- Comprehensive protection systems
- Signal and clip limiter LEDs

APPLICATIONS

- Small to medium-scale installations
- Portable sound and stage monitoring
- Hotels, restaurants and bars
- Houses of Worship and auditoriums
- Educational facilities
- Live music and dance clubs
- Mobile DJ's

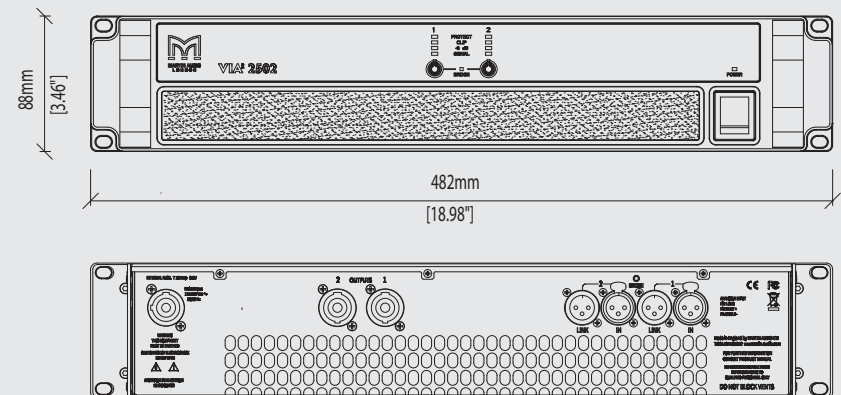

VIA5002

Two-Channel Class D Amplifier



The VIA5002 is an advanced 2-channel power amplifier which combines high power density with superb audio performance in a lightweight, cost-effective package. Delivering 2 x 2500 watts into 4 ohms or 2 x 1500 watts into 8 ohms, it is ideal for powering subwoofers in installations and portable sound systems.

Its high efficiency design reduces the energy drawn from the mains supply and ensures the power reserves needed to deliver superb sound in demanding environments with reliability and ease.

Comprehensive protection functions continuously monitor its performance to maintain safe operating conditions and full output capability in ambient temperatures up to 40°C.

For a wide variety of applications, the VIA5002 is ideally partnered with the Martin Audio DX0.5 system processor. Larger installations will benefit from use with the DX4.0 with its onboard network capability and proprietary VU-NET software control.

FEATURES

- Two channels of efficient Class D amplification
- 5000 Watts total power output
- 2U rack height
- Exceptionally lightweight
- Switch mode power supply
- Variable speed cooling fans with front-to-back airflow
- Global mains operation, 100-240V auto-sensing
- Comprehensive protection systems
- Signal and clip limiter LEDs

APPLICATIONS

- Subwoofer amplification
- Installations, portable sound and stage monitoring
- Hotels, restaurants and bars
- Houses of Worship and auditoriums
- Educational facilities
- Live music and dance clubs
- Mobile DJ's

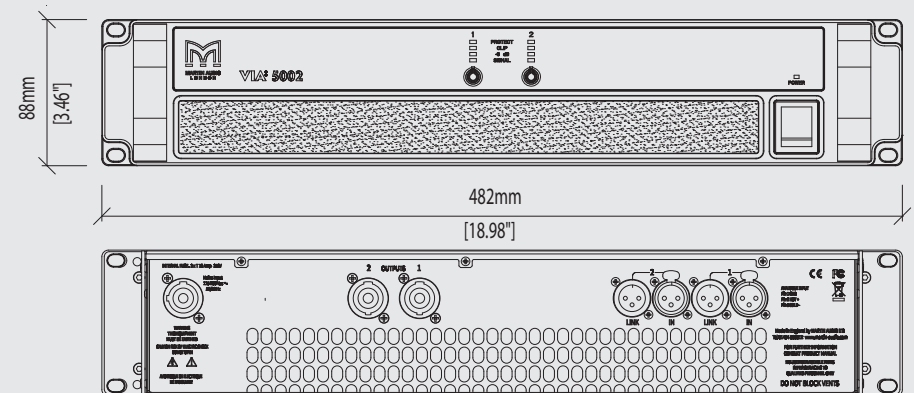

VIA2004

Four-Channel Class D Amplifier



The VIA2004 is an advanced 4-channel power amplifier which delivers superb audio performance in a lightweight, cost-effective package. Delivering 4 x 500 watts into 4 ohms, it is ideal for powering O-Line, ADORN and CDD Series installations in bars, auditoriums and HoW, as well as small-medium scale portable sound reinforcement and club use.

Its high efficiency design reduces the energy drawn from the mains supply and ensures the power reserves needed to deliver superb sound in demanding environments with reliability and ease.

Comprehensive protection functions continuously monitor its performance to maintain safe operating conditions and full output capability in ambient temperatures up to 40°C.

For a wide variety of installations and portable applications, the VIA2004 is ideally partnered with the Martin Audio DX0.5 system processor. Larger installations will benefit from use with the DX4.0 processor with its onboard network capability and proprietary VU-NET software control. The DX4.0 and VIA2004 combination is perfect for delivering cost-effective scalable resolution under VU-NET control to an installed O-Line array.

FEATURES

- Four channels of efficient Class D amplification
- 2000 Watts total power output
- 2U rack height
- Exceptionally lightweight
- Switch mode power supply
- Variable speed cooling fans with front-to-back airflow
- Global mains operation, 100-240V auto-sensing
- Comprehensive protection systems
- Signal and clip limiter LEDs

APPLICATIONS

- Small to medium-scale installations
- Portable sound and stage monitoring
- Hotels, restaurants and bars
- Houses of Worship and auditoriums
- Educational facilities
- Live music and dance clubs
- Mobile DJ's

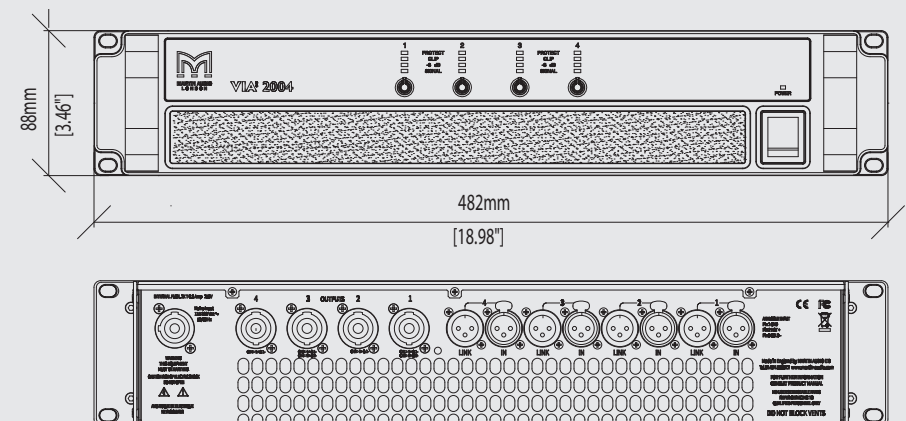

VIA5004

Four-Channel Class D Amplifier



The VIA5004 is an advanced 4-channel power amplifier which combines high power density with superb audio performance in a lightweight, cost-effective package. Delivering 4 x 1250 watts into 2 ohms, or 2 x 2500 watts into 4 ohms bridged, it is ideal for powering Blackline X, CDD and V. Series systems in small to medium-scale installations and portable sound applications. It can also be configured for 3-channel operation, for perfect compatibility with TH Series 3-way systems.

Its high efficiency design reduces the energy drawn from the mains supply and ensures the power reserves needed to deliver superb sound in demanding environments with reliability and ease.

Comprehensive protection functions continuously monitor its performance to maintain safe operating conditions and full output capability in ambient temperatures up to 40°C.

For a wide variety of installations and portable situations, the VIA5004 is ideally partnered with the Martin Audio DX0.5 system processor. Larger installations will benefit from use with the DX4.0 with its onboard network capability and proprietary VU-NET software control.

FEATURES

- Four channels of efficient Class D amplification
- 5000 Watts total power output
- 2U rack height
- Exceptionally lightweight
- Switch mode power supply
- Variable speed cooling fans with front-to-back airflow
- Global mains operation, 100-240V auto-sensing
- Comprehensive protection systems
- Signal and clip limiter LEDs

APPLICATIONS

- Small to medium-scale installations
- Portable sound and stage monitoring
- Hotels, restaurants and bars
- Houses of Worship and auditoriums
- Educational facilities
- Live music and dance clubs

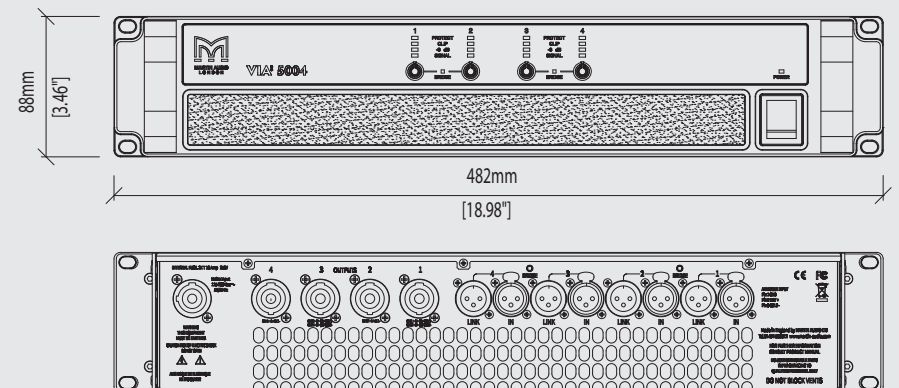

CONTROLLERS



DX0.5

Loudspeaker Management System



Offered to partner our ADORN, CDD or BlacklineX series, the DX0.5 adds affordable loudspeaker system management to our range of DX loudspeaker controllers. Delivering EQ, crossover, processing and system protection, this 2x6 speaker processor provides complete optimisation for both passive and powered loudspeaker systems.

Each input and output is loaded with a huge range of digital processing including flexible EQ, crossover, delay and limiting solutions. It delivers everything you need to professionally optimise loudspeaker systems of nearly any size.

The DX0.5 utilizes high-end 24-bit AKM® AD/DA converters with 120dB dynamic range for class-leading sound quality. With 24 memory locations users can recall pre-set files via the front panel, or using the free software application and front panel USB users can define and store their own settings. With simple I/O routing and configuration, the DX0.5 is an ultra-flexible processor, ideal for a wide range of portable and installed applications.

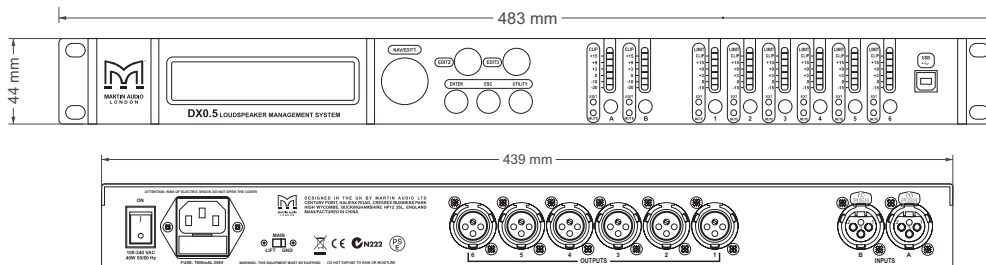

FEATURES

- Professional 2-input, 6-output system processor for passive and powered PAs
- Sophisticated, intuitive EQ, crossover, delay and dynamics processing optimises and protects your system
- High-end 24-bit AKM AD/DA converters with 120dB dynamic range
- Two balanced XLR inputs with level control, mute, 600ms delay and 5-band parametric/shelving EQ
- Six balanced XLR outputs with level control, mute, polarity invert, dedicated high and low pass filters, 7-band parametric/shelving EQ, 600ms delay, and limiting
- Convenient front-panel controls for parameter editing and input/output muting
- USB port for simple programming via PC
- Linkable inputs and outputs for easy stereo configuration
- 7-segment LED metering for input/output level or limiter activity
- 5 operating modes: 2 x stereo + sub, 3 x stereo, 2 x 2-way + sub, 2 x 3-way and 1 x 6-way
- 24 presets for storing your Martin Audio or other system parameters
- Switch mode power supply: 100V – 240V

APPLICATIONS

- Live sound loudspeaker management
- Active monitor systems
- Fixed installations

DX4.0

Networked System Controller



The Martin Audio DX4.0 is an advanced loudspeaker controller and system matrix with four input and eight output channels.

Class-leading sonic performance is achieved by state-of-the-art audio converters and DSP algorithms, with a 96kHz sampling frequency delivering a nominally flat response beyond 40kHz.

Connected via Ethernet, system remote control and monitoring is done via Martin Audio's VU-NET proprietary software application, while a front panel interface gives local control of features.

Four analogue/AES3 inputs and eight analogue/AES outputs are available, with AES3 inputs and outputs selected in pairs. Dante™ digital audio networking is also provided for digital audio distribution and control, with automatic fall back to analogue or AES3. By converting analogue or AES audio to Dante, the DX4.0 provides 'on-ramp' entry to digital audio networking.

The DX4.0 features a sophisticated loudspeaker limiter suite which incorporates peak, RMS and excursion limiting, as well as multiband limiting for passive two-way systems. High-pass filtering, three shelving filters and six parametric filters are provided for each input channel, with crossover filters, two shelving filters and eight parametric filters on each output channel.

The DX4.0 supports FIR filters for use with optimisation of Martin Audio's O-Line and can also be used with Martin Audio's U-Hub to feed digital audio and network to an MLA Series array/subwoofer array via a single cable.

FEATURES

- Four input channels and eight output channels loudspeaker processor and matrix
- Analogue, AES3 and Dante™ digital audio inputs
- High performance 96kHz DSP
- Remote control and monitoring over Ethernet via Martin Audio VU-NET software
- FIR optimisation for Martin Audio's O-Line
- VX limiting gives a passive enclosure the same protection as a fully active unit
- Comprehensive suite of EQ's, delays and all pass filters
- Global mains operation 100-240V, 50-60Hz

APPLICATIONS

- Loudspeaker system digital controller
- Front-of-house matrix to feed Dante digital audio to iKON amplifiers powering Martin Audio loudspeaker systems
- Use with Martin Audio O-Line for FIR Optimisation
- Use with Martin Audio U-Hub to feed digital audio and network to an MLA Series array/subwoofer array via a single cable

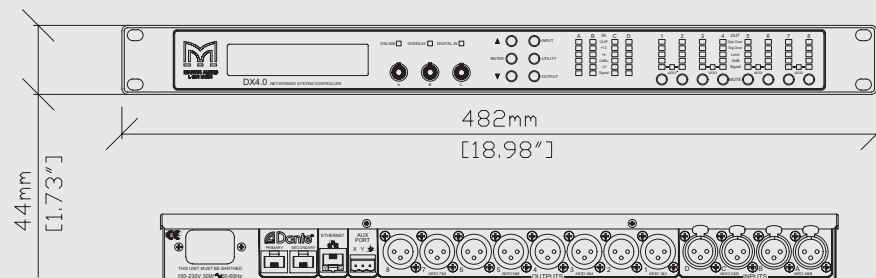

U-Hub

Ethernet to U-NET™ Bridge



U-Hub is an Ethernet to U-NET bridge equipped with analogue and AES3 digital audio transport. It facilitates PC connection and VU-NET™ software control of MLA Series arrays and subwoofers via their inbuilt proprietary U-NET network.

Converting TCP/IP to U-NET protocol, U-Hub allows MLA Series enclosures to self-address and identify their position within an array, as well as supporting a simple-to-use redundant loop. With U-Hub, an MLA Series system with onboard U-NET can be seamlessly integrated into a TCP/IP network and controlled via VU-NET software.

When used in conjunction with the Martin Audio DX4.0 networked system controller, U-Hub can connect audio and network to an MLA Series system with a single cable via a Dante™ digital audio network.

FEATURES

- Ethernet to U-NET™ bridge
- IP addressable (static and dynamic)
- Analogue and digital audio transport
- Designed to work with DX4.0 loudspeaker processor for Dante™ digital audio distribution

APPLICATIONS

- Network platform/converter for MLA Series systems

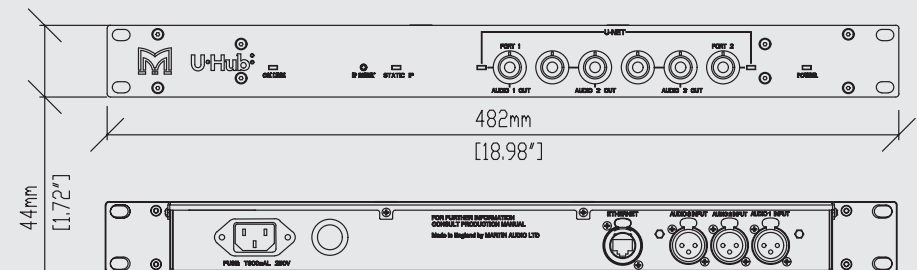

TECHNICAL SPECIFICATIONS – AMPLIFIERS

iK42

General	
TYPE	Four-channel Class D amplifier
POWER OUTPUT*	5000W into 2 ohms 3000W into 4 ohms 1500W into 8 ohms 10000W bridged per channel pair, 4 ohms
CV LINE OUTPUT*	1250W, 25V line 3500W, 70V line 5000W, 100V line
DIGITAL SIGNAL PROCESSING	96kHz/48kHz DSP on all inputs and outputs
COOLING	Dual vari-speed fans, front-to-back airflow
MAXIMUM AMBIENT TEMPERATURE	40°C (105°F)
Audio Inputs/Outputs	
ANALOGUE IN/LINK (4 CHANNELS)	4 x female, 4 x male Neutrik™ XLR
ANALOGUE INPUT IMPEDANCE	20kΩ balanced to ground
MAXIMUM ANALOGUE INPUT LEVEL	+20dBu
AES3 IN/LINK (2 CHANNELS)	1 x female, 1 x male Neutrik™ XLR, balanced
DANTE™ (4 CHANNELS)	2 x shielded RJ45, primary and secondary
AMPLIFIER OUTPUTS	4 x Neutrik Speakon™ NL4
Audio Performance	
DYNAMIC RANGE	>113dBA, analogue input >114dBA AES/Dante™ input
FREQUENCY RESPONSE	7Hz-30kHz (-2.5dB points, 4 ohm load)
TOTAL HARMONIC DISTORTION	<0.05% typical @ 1kHz, 4 ohm load
SLEW RATE	>60V per microsecond
DAMPING FACTOR	>800 at amplifier output, ref 8 ohms
Control and Monitoring Network	
PROTOCOL	Ethernet
CONTROL APPLICATION	Martin Audio VU-NET™
Digital Signal Processing	
SAMPLE RATE	96kHz (48kHz for FIR filter implementation)
PHYSICAL INPUTS	4 x analogue, 2 x AES, 4 x Dante™ inputs routable to four DSP drive modules
DRIVE MODULE INPUT DSP	Input signal routing, delay, gain, HPF, Phase, Mute EQ: 2 x low shelf, 6 x PEQ/bandpass and FIR shelving filters
DRIVE MODULE OUTPUT DSP	Source, delay, gain, Phase, Mute, crossover filters, limiters EQ: low shelf, 8 x PEQ / band pass and shelving filters
Power Supply	
TYPE	High performance Series Resonant
AC INPUT OPERATING RANGE	85 – 240V ~ AC, 47 - 63Hz
MAINS INRUSH CURRENT	6A at 115V, 12A at 230V (max for <10ms)
MAINS CONNECTOR	Neutrik 32A Powercon™
Physical	
DIMENSIONS	(W) 483 x (H) 2U/89mm x (D) 357mm (W) 19in x (H) 2U/3.5in x (D) 14.1in incl handles and optional rear support
WEIGHT	12.5kg (27.5lbs)

iK81

General	
TYPE	Eight-channel Class D amplifier
POWER OUTPUT*	1250W into 2 ohms 1250W into 4 ohms 1250W into 8 ohms 2500W bridged per channel pair, 4 or 8 ohms
CV LINE OUTPUT*	625W, 25V line 1250W, 70V line 1250W, 100V line
DIGITAL SIGNAL PROCESSING	96kHz/48kHz DSP on all inputs and outputs
COOLING	Dual vari-speed fans, front-to-back airflow
MAXIMUM AMBIENT TEMPERATURE	40°C (104°F)
Audio Inputs/Outputs	
ANALOGUE IN/LINK (4 CHANNELS)	4 x female, 4 x male Neutrik™ XLR
ANALOGUE INPUT IMPEDANCE	20kΩ balanced to ground
MAXIMUM ANALOGUE INPUT LEVEL	+20dBu
AES3 IN/LINK (2 CHANNELS)	1 x female, 1 x male Neutrik™ XLR, balanced
DANTE™ (4 CHANNELS)	2 x shielded RJ45, primary and secondary
AMPLIFIER OUTPUTS	4 x Neutrik Speakon™ NL4
Audio Performance	
DYNAMIC RANGE	>113dBA, analogue input >114dBA AES/Dante™ input
FREQUENCY RESPONSE	7Hz-30kHz (-2.5dB points, 4 ohm load)
TOTAL HARMONIC DISTORTION	<0.05% typical @ 1kHz, 4 ohm load
SLEW RATE	>60V per microsecond
DAMPING FACTOR	>800 at amplifier output, ref 8 ohms
Control and Monitoring Network	
PROTOCOL	Ethernet
CONTROL APPLICATION	Martin Audio VU-NET™
Digital Signal Processing	
SAMPLE RATE	96kHz (48kHz for FIR filter implementation)
PHYSICAL INPUTS	4 x analogue, 2 x AES, 4 x Dante™ inputs routable to four DSP drive modules
DRIVE MODULE INPUT DSP	Input signal routing, delay, gain, HPF, Phase, Mute EQ: 2 x low shelf, 6 x PEQ/bandpass and FIR shelving filters
DRIVE MODULE OUTPUT DSP	Source, delay, gain, Phase, Mute, crossover filters, limiters EQ: low shelf, 8 x PEQ / band pass and shelving filters
Power Supply	
TYPE	High performance Series Resonant
AC INPUT OPERATING RANGE	85 – 240V ~ AC, 47 - 63Hz
MAINS INRUSH CURRENT	6A at 115V, 12A at 230V (max for <10ms)
MAINS CONNECTOR	Neutrik 32A Powercon™
Physical	
DIMENSIONS	(W) 483 x (H) 2U/89mm x (D) 357mm (W) 19in x (H) 2U/3.5in x (D) 14.1in incl handles and optional rear support
WEIGHT	12.5kg (27.5lbs)

VIA2502

General	
TYPE	Two-channel Class D amplifier
POWER OUTPUT*	2 x 1250W into 2 ohms 2 x 800W into 4 ohms 2 x 450W into 8 ohms 1 x 2500W bridged into 4 ohms
COOLING	Vari-speed fans, front-to-back airflow
MAXIMUM AMBIENT TEMPERATURE	40°C (105°F)
Audio Inputs/Outputs	
ANALOGUE IN/LINK (4 CHANNELS)	2 x female, 2 x male Neutrik™ XLR
ANALOGUE INPUT IMPEDANCE	10kΩ Balanced
MAXIMUM ANALOGUE INPUT LEVEL	+20dBu
AMPLIFIER OUTPUTS	2 x Neutrik Speakon™ NL4
Audio Performance	
OUTPUT NOISE	-113dBA, referenced to max output (22kHz bandwidth)
FREQUENCY RESPONSE	<10Hz - >20kHz +/- 0.25dB
TOTAL HARMONIC DISTORTION	<0.05% typical @ 1kHz, -3dB output (22kHz bandwidth)
SLEW RATE	>80V per microsecond
DAMPING FACTOR	120 ref 8 ohms
Power Supply	
TYPE	High current, high frequency switch-mode
AC INPUT OPERATING RANGE	100-240V +/-10% 45 - 65Hz
TOTAL SYSTEM EFFICIENCY	>90% typical
MAINS CONNECTOR	1 x Neutrik Powercon™
Physical	
DIMENSIONS	(W) 482 x (H) 2U/88mm x (D) 441mm (W) 19in x (H) 2U/3.5in x (D) 17.4in incl handles and optional rear support
WEIGHT	8kg (17.6lbs)

* RMS output power per channel, all channels driven with continuous program material and a nominal ambient temperature of 40°C /105°F

VIA5002

General	
TYPE	Two-channel Class D amplifier
POWER OUTPUT*	2 x 2500W into 4 ohms 2 x 1600W into 8 ohms
COOLING	Vari-speed fans, front-to-back airflow
MAXIMUM AMBIENT TEMPERATURE	40°C (105°F)
Audio Inputs/Outputs	
ANALOGUE IN/LINK (4 CHANNELS)	2 x female, 2 x male Neutrik™ XLR
ANALOGUE INPUT IMPEDANCE	10KΩ balanced
MAXIMUM ANALOGUE INPUT LEVEL	+20dBu
AMPLIFIER OUTPUTS	2 x Neutrik Speakon™ NL4
Audio Performance	
OUTPUT NOISE	-113dBA, referenced to max output (22kHz bandwidth)
FREQUENCY RESPONSE	<10Hz - >20kHz +/- 0.25dB
TOTAL HARMONIC DISTORTION	<0.05% typical @ 1kHz, -3dB output (22kHz bandwidth)
SLEW RATE	>80V per microsecond
DAMPING FACTOR	120 ref 8 ohms
Power Supplies	
TYPE	2 x high current, high frequency switch-mode
AC INPUT OPERATING RANGE	100-240V +/-10% 45 - 65Hz
TOTAL SYSTEM EFFICIENCY	>90% typical
MAINS CONNECTOR	1 x Neutrik Powercon™
Physical	
DIMENSIONS	(W) 482 x (H) 2U/88mm x (D) 441mm (W) 19in x (H) 2U/3.5in x (D) 17.4in incl handles and optional rear support
WEIGHT	10kg (22lbs)

VIA2004

General	
TYPE	Four-channel Class D amplifier
POWER OUTPUT*	4 x 500W into 4 ohms 4 x 250W into 8 ohms
COOLING	Vari-speed fans, front-to-back airflow
MAXIMUM AMBIENT TEMPERATURE	40°C (105°F)
Audio Inputs/Outputs	
ANALOGUE IN/LINK (4 CHANNELS)	4 x female, 4 x male Neutrik™ XLR
ANALOGUE INPUT IMPEDANCE	5 kΩ typical, balanced
MAXIMUM ANALOGUE INPUT LEVEL	+20dBu
AMPLIFIER OUTPUTS	4 x Neutrik Speakon™ NL4
Audio Performance	
FREQUENCY RESPONSE	20Hz - 20kHz +/- 0.45dB, 4 ohm load
TOTAL HARMONIC DISTORTION	0.003% typical, 1kHz @ 1W
Power Supplies	
TYPE	2 x high current, high frequency switch-mode
AC INPUT OPERATING RANGE	100-240V +/-10% 45 - 65Hz
MAINS CONNECTOR	1 x Neutrik Powercon™
TOTAL SYSTEM EFFICIENCY	89% (4 x 250W into 8 ohms)
Physical	
DIMENSIONS	(W) 482 x (H) 2U/88mm x (D) 441mm (W) 19in x (H) 2U/3.5in x (D) 17.4in incl handles and optional rear support
WEIGHT	8kg (17.6lbs)

VIA5004

General	
TYPE	Four-channel Class D amplifier
POWER OUTPUT*	4 x 1250W into 2 ohms 4 x 800W into 4 ohms 4 x 450W into 8 ohms 2 x 2500W bridged into 4 ohms
COOLING	Vari-speed fans, front-to-back airflow
MAXIMUM AMBIENT TEMPERATURE	40°C (105°F)
Audio Inputs/Outputs	
ANALOGUE IN/LINK (4 CHANNELS)	4 x female, 4 x male Neutrik™ XLR
ANALOGUE INPUT IMPEDANCE	10KΩ balanced
MAXIMUM ANALOGUE INPUT LEVEL	+20dBu
AMPLIFIER OUTPUTS	4 x Neutrik Speakon™ NL4
Audio Performance	
OUTPUT NOISE	-113dBA, referenced to max output (22kHz bandwidth)
FREQUENCY RESPONSE	<10Hz - >20kHz +/- 0.25dB
TOTAL HARMONIC DISTORTION	<0.05% typical @ 1kHz, -3dB output (22kHz bandwidth)
SLEW RATE	>80V per microsecond
DAMPING FACTOR	120 ref 8 ohms
Power Supplies	
TYPE	2 x high current, high frequency switch-mode
AC INPUT OPERATING RANGE	100-240V +/-10% 45 - 65Hz
TOTAL SYSTEM EFFICIENCY	>90% typical
MAINS CONNECTOR	1 x Neutrik Powercon™
Physical	
DIMENSIONS	(W) 482 x (H) 2U/88mm x (D) 441mm (W) 19in x (H) 2U/3.5in x (D) 17.4in incl handles and optional rear support
WEIGHT	10kg (22lbs)

TECHNICAL SPECIFICATIONS – CONTROLLERS

DX0.5

INPUTS	2 electronically balanced analogue
CMRR	>58dB
OUTPUTS	6 electronically balanced analogue
MAX OUTPUT	+21dBu
FREQUENCY RESPONSE	20Hz-20kHz ± 0.2dB
DYNAMIC RANGE	120dB
DISTORTION	< .004% 20Hz-20kHz
MAXIMUM DELAY	>600 ms
MIN STEP SIZE	20 µS
INPUT GAIN	± 15dB in 0.1dB steps
OUTPUT GAIN	+6dB to -12dB in 0.1dB steps plus mute
PARAMETRIC EQUALISATION	
FILTERS	5 per input / 7 per output
FILTER GAIN	±15dB in 0.05dB steps
FREQUENCY RANGE	20Hz - 20kHz, 1/24 octave steps
FILTER BW	3 to 0.05 in 0.05 steps
HIGH AND LOWPASS FILTERS	
FREQUENCY RANGE	20Hz - 20kHz
RESPONSES	
BUTTERWORTH	6dB, 12dB, 18dB, 24dB / Octave
LINKWITZ-RILEY	12dB, 24dB / Octave
BESSEL	12dB, 24dB / Octave
LIMITERS	
THRESHOLD	+20dBu to -10dBu
ATTACK TIME	5ms to 200ms
RELEASE TIME	0.1 – 3.0s ±0.1s increments
DISPLAY	2 x 24 character blue LCD
INPUT METER	2 x 7 point, -20dB to +15dB
OUTPUT METER	6 x 7 point, -15dB to +15dB into limit
CONNECTORS	
INPUTS	3 pin female XLR
OUTPUTS	3 pin male XLR
EXTERNAL	USB TYPE-B (USB1.1)
	Program via Windows-based PC
	Download app and driver from:
	www.martin-audio.com/software/software
POWER	3 pin IEC
POWER	100 to 240V @ 50/60Hz
CONSUMPTION:	40 watts
DIMENSIONS	(W) 482mm x (H) 44mm x (D) 229mm
	(W) 19ins x (H) 1.75ins (1U) x (D) 9ins
WEIGHT	2.6kg (5.8lbs)

DX4.0

General	
TYPE	4 input/8 output digital loudspeaker processor
OPERATING TEMPERATURE	0 to 45°C
HUMIDITY RANGE	0 to 80% RH (non-condensing)
Audio Performance	
INPUT IMPEDANCE	>10kΩ balanced
OUTPUT IMPEDANCE	<100Ω balanced
MAX INPUT LEVEL	+20dBu
MAX OUTPUT LEVEL	+18dBu into 600Ω
FREQUENCY RESPONSE	10Hz - 40kHz
INPUT DYNAMIC RANGE	>120dBa typ.
OUTPUT DYNAMIC RANGE	>118dBa typ.
TOTAL HARMONIC DISTORTION	<0.008% typ. 20Hz-20kHz
Digital Signal Processing	
SAMPLE RATE	96kHz
AES3 INPUT SAMPLE RATE	28kHz – 108kHz
AES3 OUTPUT SAMPLE RATE	96kHz
Power Supply	
AC OPERATING RANGE	100-240V +/-10%
POWER CONSUMPTION	30W
Control and Monitoring	
PROTOCOL	Ethernet
CONTROL APPLICATION	Martin Audio VU-NET™
Connectors	
AUDIO INPUT	4 x 3 pin female XLR for analogue or AES3 pairs
AUDIO OUTPUT	8 x 3 pin male XLR for analogue or AES3 pairs
ETHERNET	1 x shielded RJ45
DANTE™ NETWORK	2 x shielded RJ45, primary and secondary
AUX PORT	Phoenix connector for contact closure
MAINS POWER	3 pin IEC
Physical	
DIMENSIONS	(W) 482mm x (H) 1U/44mm x (D) 184mm
	(W) 19in x (H) 1U/1.75in x (D) 7.2in
WEIGHT	2.7kg (6lbs)

U-Hub

General	
TYPE	Ethernet to U-NET™ bridge
SUPPORTED PROTOCOLS	Ethernet and U-NET™
CONTROL APPLICATION	Martin Audio VU-NET™
AC OPERATING RANGE	100-240VAC Nominal, 50-60Hz
Rear Panel	
AUDIO INPUTS 1, 2 and 3	3 x 3 pin female XLR type
ETHERNET	1 x Neutrik® Ethercon
MAINS POWER	3 pin IEC with cable locking mechanism
FUSE	User-replaceable 1A T-type 20mm
Front Panel	
AUDIO OUT AND U-NET	6 x ODU 8-pin connector ports
	Audio In 1, 2, 3, Out on ports 1, 3, 5
UNET STATUS	Bi-colour Green/Red LED on port 1 and 6
IP CONFIGURATION	Yellow LED: On = Static IP, Off = Dynamic
IP RESET (TO DYNAMIC)	Recessed push button
ETHERNET CONNECTION	Green LED = Online
MAINS POWER	Red LED = Mains power present
Physical	
DIMENSIONS	(W) 482mm x (H) 1U/44mm x (D) 268mm
	(W) 19in x (H) 1U/1.75in x (D) 10.6in
WEIGHT	3.5Kg (7.7lbs)



ELECTRONICS

COMPLETING THE CIRCUIT

Martin Audio Limited

Century Point

Halifax Road

Cressex Business Park

High Wycombe

Buckinghamshire

HP12 3SL

England

FOR SALES ENQUIRIES:

UK

Telephone: +44 (0)1494 535312

E-mail: info@martin-audio.com

NORTH AMERICA

Telephone: 323 381 5310

www.martin-audio.com

All information is Copyright © 2018 Martin Audio Ltd.

Martin Audio, the Martin Audio logo and Hybrid are registered trademarks of Martin Audio Ltd. in the United Kingdom, United States and other countries; all other Martin Audio trademarks are the property of Martin Audio Ltd.



Unite Your Audience
The Martin Audio Experience

Version 1.1