



**Electrospark Deposition for the Repair of  
Army Main Battle Tank Components**

**by Victor Champagne, Marc Pepi, and Brian Edwards**

**ARL-TR-3849**

**July 2006**

## **NOTICES**

### **Disclaimers**

The findings in this report are not to be construed as an official Department of the Army position unless so designated by other authorized documents.

Citation of manufacturer's or trade names does not constitute an official endorsement or approval of the use thereof.

Destroy this report when it is no longer needed. Do not return it to the originator.

# **Army Research Laboratory**

Aberdeen Proving Ground, MD 21005-5069

---

---

**ARL-TR-3849**

**July 2006**

---

## **Electrospark Deposition for the Repair of Army Main Battle Tank Components**

**Victor Champagne, Marc Pepi, and Brian Edwards  
Weapons and Materials Research Directorate, ARL**

<b>REPORT DOCUMENTATION PAGE</b>			<i>Form Approved</i> OMB No. 0704-0188		
Public reporting burden for this collection of information is estimated to average 1 hour per response, including the time for reviewing instructions, searching existing data sources, gathering and maintaining the data needed, and completing and reviewing the collection information. Send comments regarding this burden estimate or any other aspect of this collection of information, including suggestions for reducing the burden, to Department of Defense, Washington Headquarters Services, Directorate for Information Operations and Reports (0704-0188), 1215 Jefferson Davis Highway, Suite 1204, Arlington, VA 22202-4302. Respondents should be aware that notwithstanding any other provision of law, no person shall be subject to any penalty for failing to comply with a collection of information if it does not display a currently valid OMB control number. <b>PLEASE DO NOT RETURN YOUR FORM TO THE ABOVE ADDRESS.</b>					
<b>1. REPORT DATE (DD-MM-YYYY)</b> July 2006		<b>2. REPORT TYPE</b> Final		<b>3. DATES COVERED (From - To)</b> March 2005–March 2006	
<b>4. TITLE AND SUBTITLE</b> Electrospark Deposition for the Repair of Army Main Battle Tank Components			<b>5a. CONTRACT NUMBER</b>		
			<b>5b. GRANT NUMBER</b>		
			<b>5c. PROGRAM ELEMENT NUMBER</b>		
<b>6. AUTHOR(S)</b> Victor Champagne, Marc Pepi, and Brian Edwards			<b>5d. PROJECT NUMBER</b> EWU M159		
			<b>5e. TASK NUMBER</b>		
			<b>5f. WORK UNIT NUMBER</b>		
<b>7. PERFORMING ORGANIZATION NAME(S) AND ADDRESS(ES)</b> U.S. Army Research Laboratory ATTN: AMSRD-ARL-WM-MC Aberdeen Proving Ground, MD 21005-5069			<b>8. PERFORMING ORGANIZATION REPORT NUMBER</b> ARL-TR-3849		
<b>9. SPONSORING/MONITORING AGENCY NAME(S) AND ADDRESS(ES)</b>			<b>10. SPONSOR/MONITOR'S ACRONYM(S)</b>		
			<b>11. SPONSOR/MONITOR'S REPORT NUMBER(S)</b>		
<b>12. DISTRIBUTION/AVAILABILITY STATEMENT</b> Approved for public release; distribution is unlimited.					
<b>13. SUPPLEMENTARY NOTES</b>					
<b>14. ABSTRACT</b> This report discusses the successful application of electrospark deposition (ESD) to reclaim expensive U.S. Army main battle tank components which had no other means of being repaired. The components included the M1A1 main battle tank cradle (fabricated from AISI 4130 steel, then chrome plated) and the M1A1 helical (sun) gear shaft (chrome-plated AISI 9310). These parts had exhibited large corrosion pits and wear in service. Systems were dead-lined based on the discovery of these anomalies during inspection and the fact that insufficient replacement parts were available. There was no approved repair procedure for these components, and conventional weld repair technologies had been eliminated at Anniston Army Depot (ANAD), AL, to repair large pits. Approximately 8% of the vehicles overhauled at ANAD were defective, and deeply corroded parts were removed from the systems and put in storage. Emphasis of this report is placed upon the ESD process development and qualification.					
<b>15. SUBJECT TERMS</b> welding repair, electrospark deposition, ESD, reclamation, ESTCP					
<b>16. SECURITY CLASSIFICATION OF:</b>			<b>17. LIMITATION OF ABSTRACT</b>  UL	<b>18. NUMBER OF PAGES</b>  46	<b>19a. NAME OF RESPONSIBLE PERSON</b> Victor Champagne
<b>a. REPORT</b> UNCLASSIFIED	<b>b. ABSTRACT</b> UNCLASSIFIED	<b>c. THIS PAGE</b> UNCLASSIFIED			<b>19b. TELEPHONE NUMBER (Include area code)</b> 410-306-0822

---

## Contents

---

<b>List of Figures</b>	<b>v</b>
<b>List of Tables</b>	<b>vi</b>
<b>1. Introduction</b>	<b>1</b>
<b>2. Components</b>	<b>1</b>
<b>3. ESD</b>	<b>2</b>
<b>4. Objective</b>	<b>6</b>
<b>5. Problem</b>	<b>6</b>
<b>6. Approach</b>	<b>7</b>
6.1 Training .....	7
6.2 ESD Procedure Development (M1A1 Helical Gear Shaft).....	8
6.2 ESD Procedure Development (M1A1 Cannon Cradle) .....	12
6.3 Repair Qualification .....	13
6.3.1 Metallography .....	13
6.3.2 Hardness Testing .....	15
6.4 Inspection Criteria .....	15
6.5 Engineering Approval .....	17
<b>7. Discussion</b>	<b>18</b>
<b>8. Cost Analysis</b>	<b>20</b>
<b>9. Recommendations/Future Work</b>	<b>20</b>
<b>10. Conclusions</b>	<b>21</b>
<b>Appendix A. M1A1 Cradle Reclamation Procedure</b>	<b>23</b>

<b>Appendix B. M1A1 Helical (Sun) Gear Reclamation Procedure</b>	<b>29</b>
<b>Distribution List</b>	<b>36</b>

---

## List of Figures

---

Figure 1. M1A1 main battle tank cannon cradle (arrow).....	2
Figure 2. Cannon cradle disassembled from tank.....	3
Figure 3. Arrow indicates location of the helical gear shaft within the M1A1 main battle tank AGT-1500 engine. ....	3
Figure 4. Schematic of the helical gear shaft and its relation to other engine components.....	4
Figure 5. Photomicrograph of an M1A1 helical gear shaft (reduced 60%).....	4
Figure 6. Equipment utilized for ESD repair of components. ....	5
Figure 7. Photo showing ESD torch applying deposit on the inside diameter of a cradle with a rotating electrode.....	6
Figure 8. An example of corrosion pits noted on a helical gear shaft (magnified 20×). ....	7
Figure 9. Test samples used for ESD process parameter optimization for the M1A1 helical gear shaft repair. Top block is chrome plated, and bottom block is uncoated AISI 9310 steel (magnified 1.5×). ....	8
Figure 10. The ESD parameters chosen for condition 4 were selected as optimal.....	9
Figure 11. Optical macrograph showing two ESD-filled defects as well as one unfilled defect (magnified 2×).....	10
Figure 12. SEM micrograph of the surface of condition 4 after ESD repair (magnified 22×).....	10
Figure 13. SEM micrograph of a section through condition 4 after ESD repair (magnified 40×).....	11
Figure 14. ESD being performed on an actual helical gear shaft containing defects at ARL. ....	12
Figure 15. Photomicrograph showing interface between deposit and substrate. Substrate was AISI 9310 steel etched with 2% nital (magnified 200×). ....	14
Figure 16. Porosity around the ESD deposit (“halo effect”) of a chrome-plated sample (magnified 5×). ....	14
Figure 17. Magnified view of figure 16 utilizing the differential interference contrast mode for optical viewing (magnified 50×).....	15
Figure 18. Polished and etched cross section showing porosity associated with the “halo effect” in a chrome-plated 9310 steel sample. Etchant: 2% nital (magnified 500×).....	16
Figure 19. Polished sample cross section of an ESD-filled, chrome-plated defect showing no anomalies (magnified 200×). ....	16
Figure 20. Plot of hardness through ESD into the base metal, showing similar hardness values. ....	17
Figure 21. Micrographs of Knoop microhardness indents through the ESD into the base metal. Base metal etched with 2% nital (magnified 50× [left] and 100× [right]).....	18

Figure 22. Schematic of fatigue dog-bone specimen to be used to generate baseline data. ....19

Figure 23. Schematic of defect dimensions to be machined into fatigue dog-bone specimens.  
 These defects will be machined into one-half of the specimens, and subsequently filled  
 with ESD. ....19

**List of Tables**

Table 1. ESD parameter optimization for M1A1 helical gear shaft. ....9

Table 2. ESD parameter optimization for M1A1 cannon cradle. ....12

Table 3. Microhardness test results; Knoop scale; 500 gmf, 50× objective. ....17



---

## **1. Introduction**

---

This report describes the development of the electrospark deposition (ESD) repair for components from a U.S. Army main battle tank. This work was performed in support of the Environmental Security Technology Certification Program (ESTCP) FY02 project proposal titled “Electrospark Deposition as a Depot-Level Chromium Plating Replacement, Field-Level Brush Plating Replacement and In-Situ Repair Technology on Aircraft, Vehicle, and Ship Components.” The objectives of this project were as follows: (1) to demonstrate and validate ESD as a replacement for electrolytic hard chrome plating on complex, relatively small-area, line-of-sight applications for which high velocity oxy fuel is difficult or costly to utilize; (2) to demonstrate and validate ESD as a field repair technology to replace brush-plated chromium, cadmium, and nickel, and to repair other coatings (such as ion-vapor deposited aluminum) or base materials which have localized damage or defects; and (3) to utilize ESD for repair of damaged components for which there is no current repair procedure.

The components chosen for the demonstration clearly satisfied objectives 2 and 3 and were selected for the significant cost savings. Previous to the implementation of ESD technology, each part had been inspected, removed from service, and put into storage because of corrosion pits and wear. The rejection rate became an important issue, since there was a shortage of available replacement parts. The success of this effort was realized through cost avoidance by reclaiming these parts. Each cradle costs ~\$24,000 while a helical gear costs approximately \$2,000. Although these repairs do not directly address an environmental issue, it can be demonstrated that these costs savings would not have been realized had this ESTCP effort not been undertaken.

---

## **2. Components**

---

The two components utilized for ESD repair include the M1A1 cannon cradle and the M1A1 helical (sun) gear shaft. A cannon cradle on an actual M1A1 tank is shown in figure 1, while figure 2 shows a cradle that has been removed from a tank. The helical gear shaft is shown in an actual cut-away section of an AGT-1500 engine (figure 3), while figure 4 shows a schematic of the gear and its relation to other engine components. Figure 5 shows an actual gear shaft which was shipped from Anniston Army Depot (ANAD) to the U.S. Army Research Laboratory (ARL) for this project.



Figure 1. M1A1 main battle tank cannon cradle (arrow).

---

### 3. ESD

---

The equipment used for ESD is shown in figure 6 (taken from Price<sup>1</sup>). ESD is a pulsed-arc, microwelding process that uses short-duration, high-current electrical pulses to weld a consumable electrode material to a metallic substrate and is distinguished from other arc welding processes in that the spark duration is limited to a few microseconds and the spark frequency is 1000 Hz or less. ESD offers a particular advantage when coating or repairing materials considered difficult to weld because of heat-affected-zone (HAZ) issues. Further, many materials can be processed without heat treatment before or after ESD. Components can be restored to original dimensions as the substrate material remains near to ambient temperature and thermal

---

<sup>1</sup>Price, N. ASAP presentation, Global Leaders In Electrosark Deposition. Presented at the U.S. Army Research Laboratory, Aberdeen Proving Ground, MD, 25 October 2005.



Figure 2. Cannon cradle disassembled from tank.

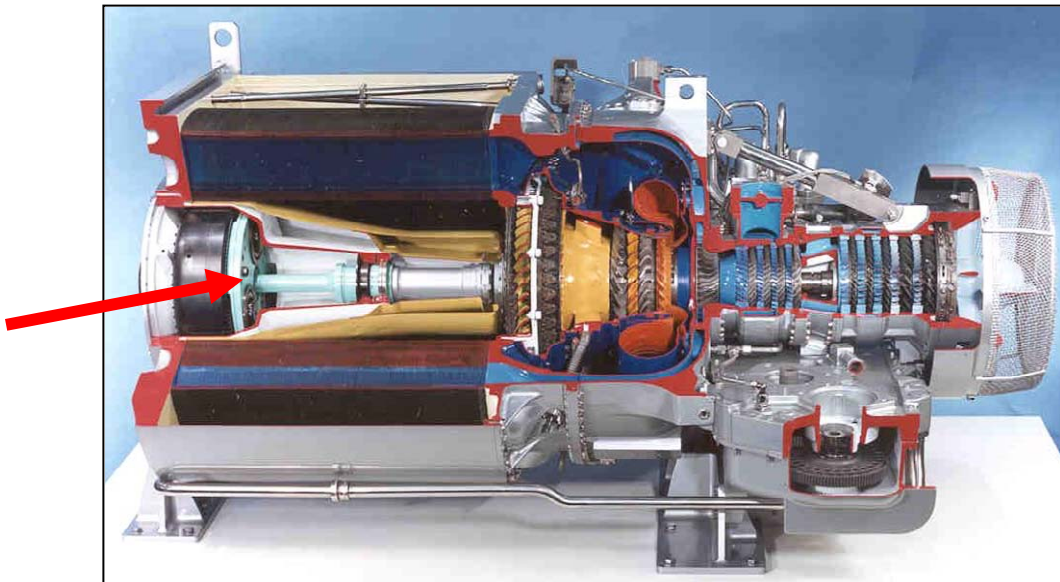

Figure 3. Arrow indicates location of the helical gear shaft within the M1A1 main battle tank AGT-1500 engine.

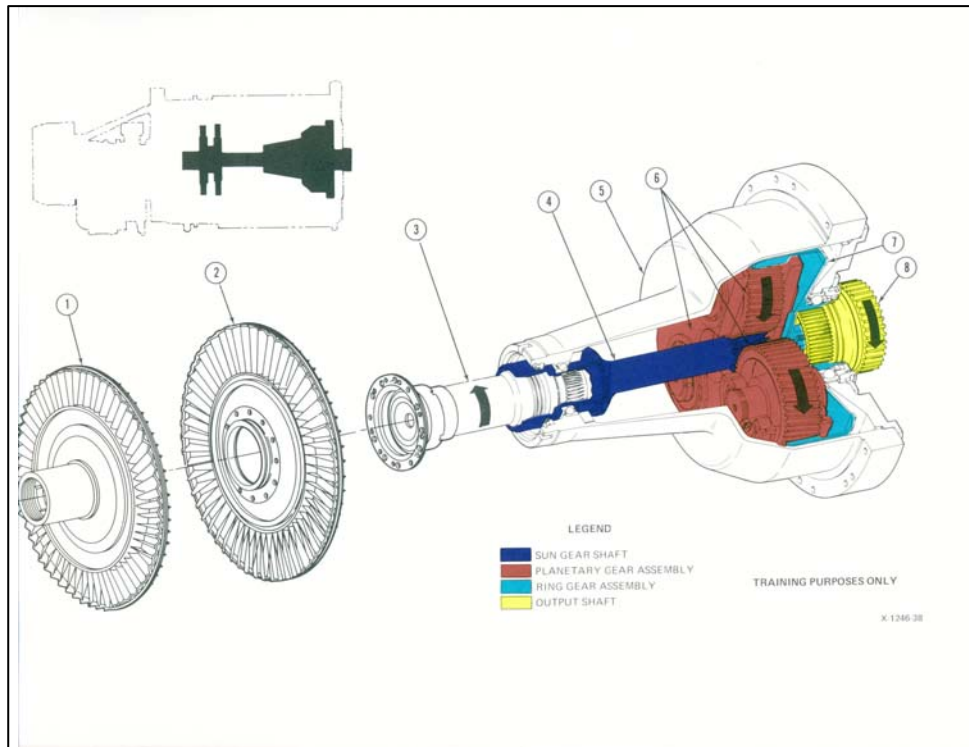

Figure 4. Schematic of the helical gear shaft and its relation to other engine components.



Figure 5. Photomicrograph of an M1A1 helical gear shaft (reduced 60%).



Figure 6. Equipment utilized for ESD repair of components.<sup>1</sup>

distortion; shrinkage and high residual stresses can be avoided.<sup>2</sup> Figure 7 shows the application of an ESD deposit. This provides extremely rapid solidification, resulting in a nanocrystalline structure or, in some cases, an amorphous surface layer that is extremely dense, forming a metallurgical bond to the substrate. The low heat input eliminates deleterious thermal stresses or changes in metallurgical structure, otherwise known as the HAZ, allowing it to be considered for heat-sensitive applications. ESD can be used for applications requiring corrosion and wear resistance as well as the build up of worn or damaged areas on parts. ESD is also an environmentally friendly process, and the deposition of toxic materials can be accomplished with the use of a fume hood to capture any dangerous gases that may evolve. ESD operators require no specialized safety protection other than eyewear and a dust mask in some cases. The only major disadvantage is that the ESD electrode is relatively small (~0.125 inches in diameter), making the repair of large surface areas impractical and expensive.

---

<sup>2</sup>[http://www.twi.co.uk/j32k/unprotected/band\\_1/power\\_electro.html](http://www.twi.co.uk/j32k/unprotected/band_1/power_electro.html) (accessed 6 March 2006).



Figure 7. Photo showing ESD torch applying deposit on the inside diameter of a cradle with a rotating electrode.

---

#### **4. Objective**

---

The objective of this ESTCP effort was to implement the ESD process for repairing M1A1 components under the Dem/Val in the ESTCP FY02 project proposal mentioned in section 1.

---

#### **5. Problem**

---

The M1A1 main battle tank components presented in this report were fabricated from alloy steels. After years of service, large corrosion pits ( $1/8 \times 3/8$  in and 0.060 in deep) and wear formed (figure 8). Systems were dead-lined based on surface anomalies discovered during inspection. Insufficient replacement parts were available. There was no approved repair procedure for these components, and conventional weld repair technologies had been eliminated at Anniston Army Depot (ANAD) to repair these large pits. Approximately 8% of the components overhauled at ANAD in 2003 were determined to be defective and were removed from the systems and put in storage.

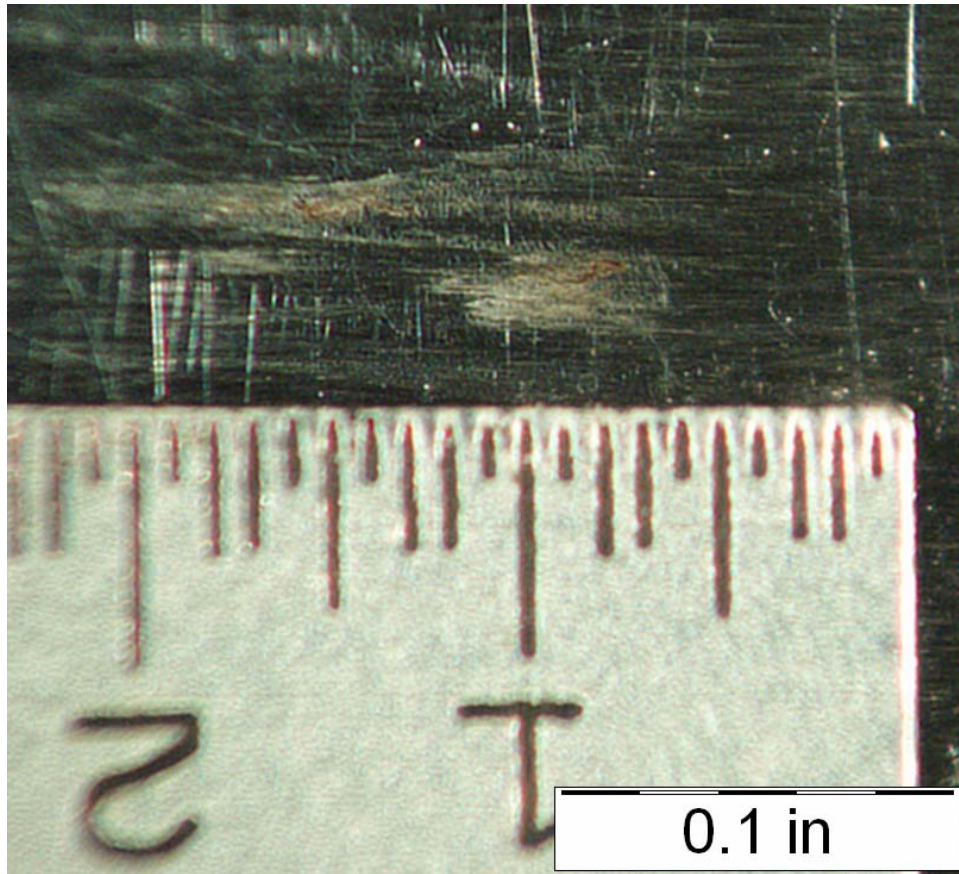

Figure 8. An example of corrosion pits noted on a helical gear shaft (magnified 20×).

---

## 6. Approach

---

The approach can be broken down into the following five major tasks:

1. Training,
2. ESD procedure development,
3. Repair qualification,
4. Inspection criteria, and
5. Engineering approval.

### 6.1 Training

Initial ESD training was completed at ARL and was attended by repair personnel, technicians, engineers, and first-line supervisors representing ARL, ANAD, and representatives from several major aerospace companies. ARL was chosen as the site for the initial training because it had

leveraged \$31,000 of internal research and development funds to purchase an ESD unit and was the only Army research facility to have a fully operational system. In addition, ARL was the monitor of the Army efforts in ESD and also responsible for coatings characterization for the Army. A follow-up training session was conducted at ANAD specifically designed to address the subject component. As part of this study, coatings of Stellite 21, Inconel 718, and Inconel 625 were deposited onto low-alloy carbon steel and Inconel 718 substrates.

## 6.2 ESD Procedure Development (M1A1 Helical Gear Shaft)

The ESD repair procedure was developed and proved out at ARL for the gear shaft. Numerous ESD trials were conducted at ARL in order to determine the optimal set of process parameters that would result in a dense, adherent deposit. These trials were performed on coupons representing the material of the sun gear (chrome-plated AISI 9310 steel). Defects were machined into test samples (figure 9), and subsequently filled using ESD. Table 1 summarizes the iterative process utilized for each of the six defects, while figure 10 shows a representative scanning electron micrograph (SEM) of a section of each defect. Condition 4 was considered to exhibit the optimal coating characteristics and is highlighted in table 1.

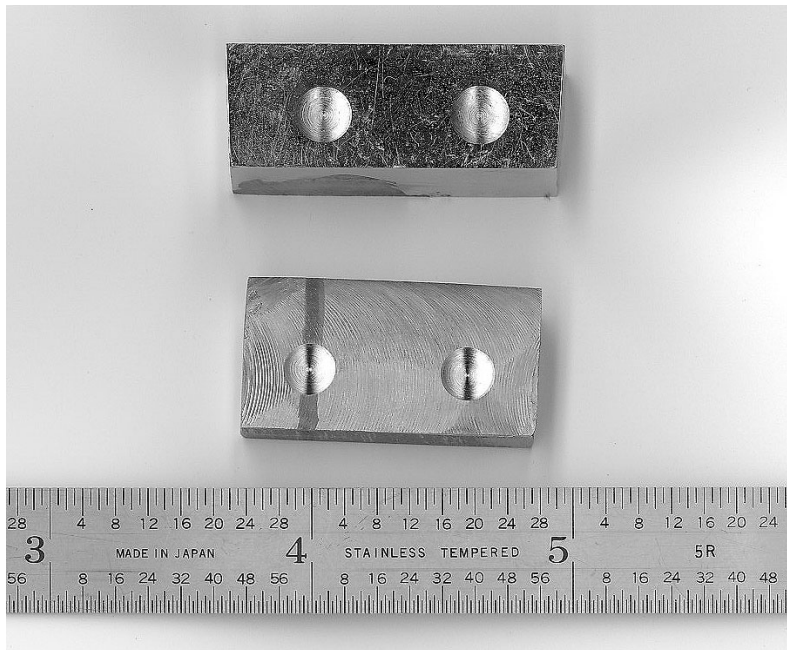

Figure 9. Test samples used for ESD process parameter optimization for the M1A1 helical gear shaft repair. Top block is chrome plated, and bottom block is uncoated AISI 9310 steel (magnified 1.5 $\times$ ).



Table 1. ESD parameter optimization for M1A1 helical gear shaft.

	Condition 1	Condition 2	Condition 3	Condition 4	Condition 5	Condition 6
Base material	9310 steel	9310 steel	9310 steel	9310 steel	9310 steel	9310 steel
Non-ESD coating	Chrome plating	Chrome plating	Chrome plating	Chrome plating	Chrome plating	Chrome plating
Electrode alloy	Inconel 718	Inconel 718	Inconel 625	Inconel 718	Inconel 718	Inconel 718
Electrode diameter (in)	0.125	0.125	0.125	.125	0.125	0.125
Pulse rate (Hz)	400	400	400	400	400	400
Capacitance (µF)	30	30	30	30	30	30
Voltage (V)	140	200	140	140	150	120
Step rate (Hz)	340	340	340	300	300	300
Swing	4	4	4	4	4	4
Rotate increment	4	4	4	4	4	4
Direction	CCW	CCW	CCW	CCW	CCW	CCW
Interval	8	8	8	8	8	8
Shielding gas	Argon	Argon	Argon	Argon	Argon	Argon
Shielding gas flow rate (CFH)	35	35	35	35	35	35

Note: CCW = counterclockwise, and CFH = cubic feet per hour.

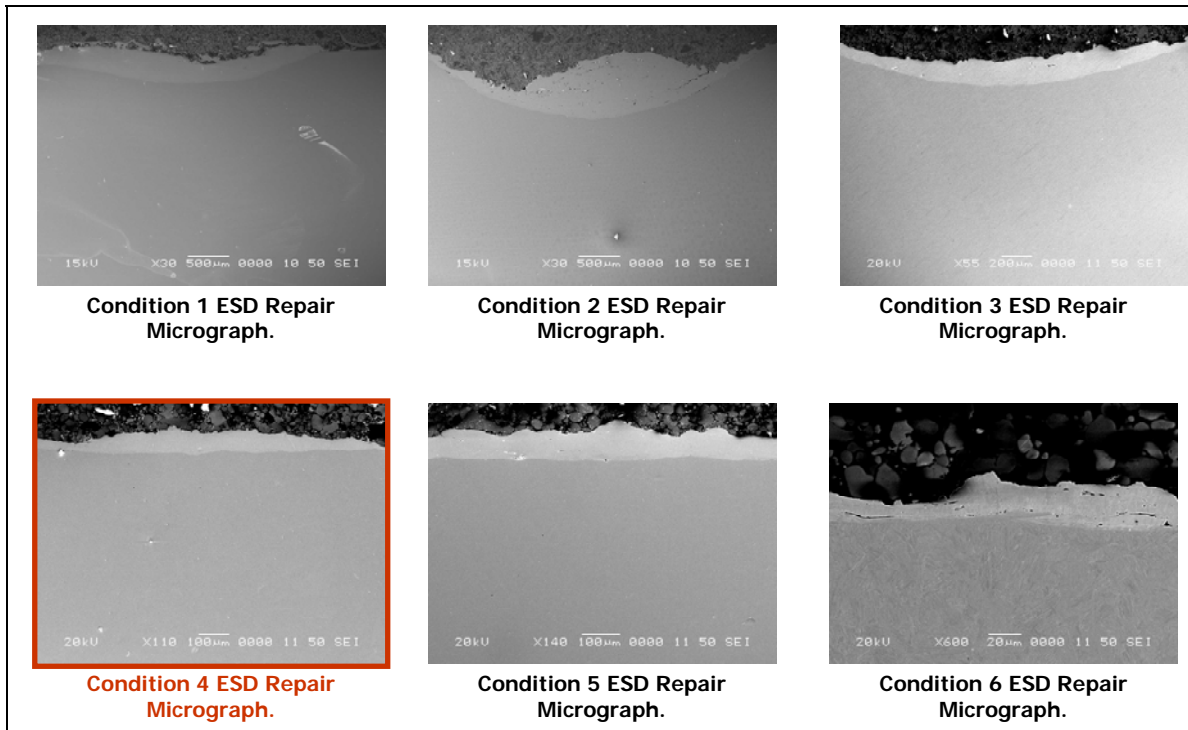

Figure 10. The ESD parameters chosen for condition 4 were selected as optimal.

The parameters used in condition 4 were chosen to be used for the repair of the helical gear shaft. These parameters were chosen for the uniformity and density of the coating, the clean interface between the coating and substrate, and the lack of voids and intergranular sites. Figure 11 shows an optical macrograph of two ESD-filled defects, as well as an unfilled defect, while figure 12 includes an SEM micrograph of the surface of condition 4. Figure 13 shows an SEM micrograph of a cross section of condition 4.

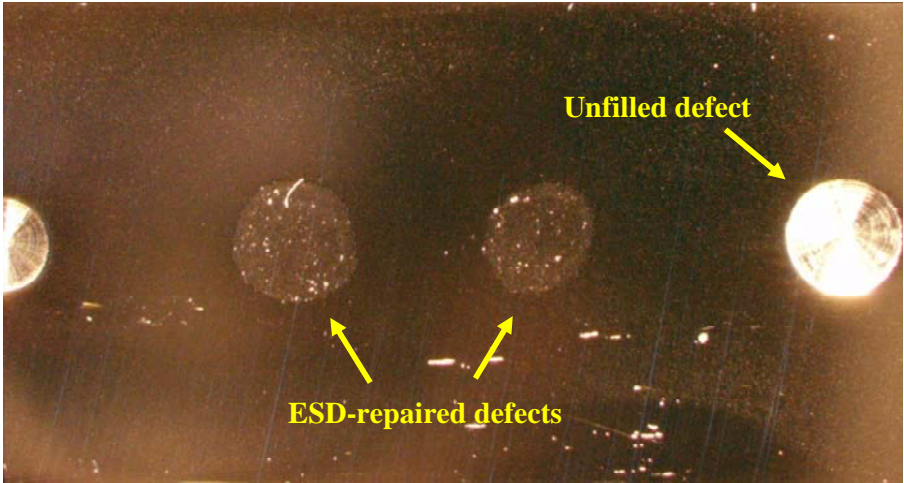

Figure 11. Optical macrograph showing two ESD-filled defects as well as one unfilled defect (magnified 2×).

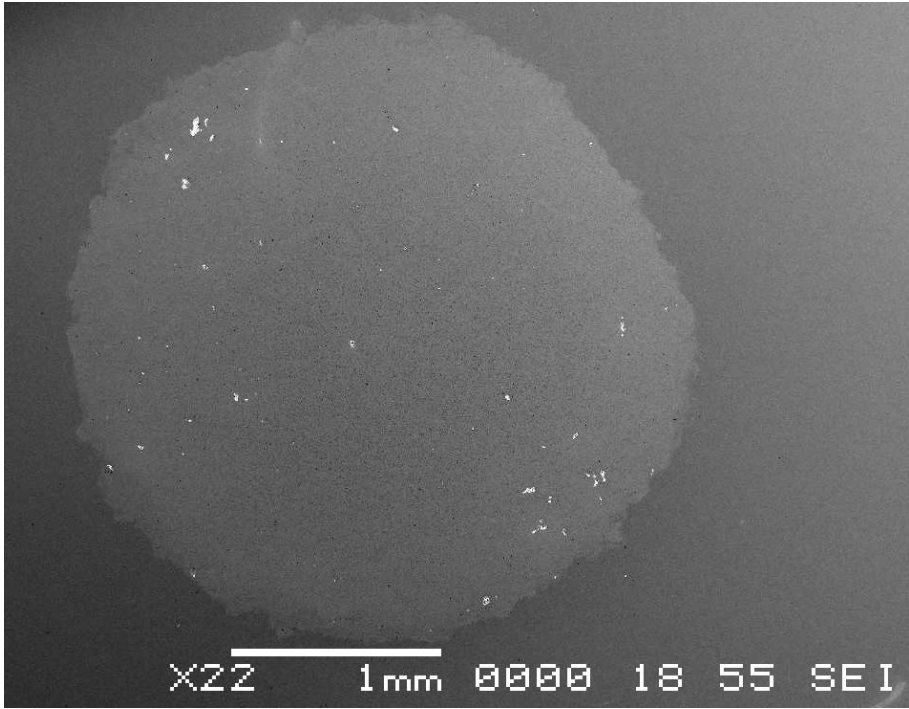

Figure 12. SEM micrograph of the surface of condition 4 after ESD repair (magnified 22×).

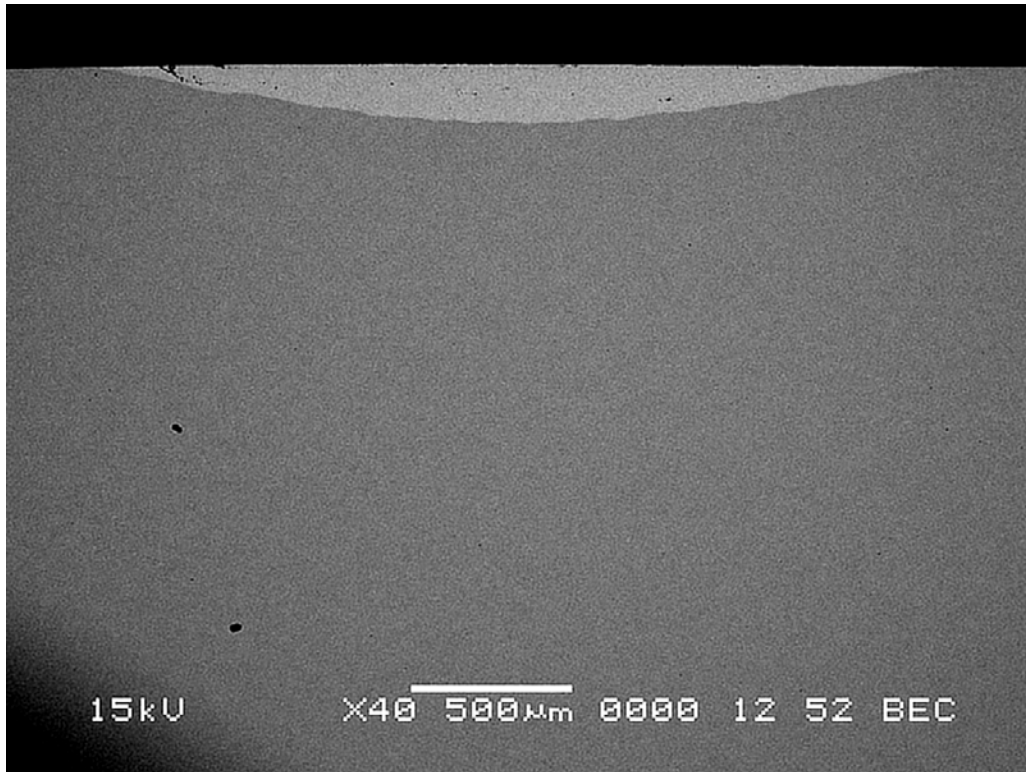

Figure 13. SEM micrograph of a section through condition 4 after ESD repair (magnified 40×).

The optimal ESD process parameters established through numerous iterations for the repairing of defects within the M1A1 helical gear shaft are those of condition 4:

- Material AISI 9310 steel
- Electrode: Inconel 718
- ESD unit settings:
  - Rotating torch
  - Pulse rate = 400 Hz
  - Capacitance = 30  $\mu$ F
  - Voltage = 140 V

Once these parameters were established, defects on actual helical gear shafts were repaired utilizing ESD (figure 14).



Figure 14. ESD being performed on an actual helical gear shaft containing defects at ARL.

## 6.2 ESD Procedure Development (M1A1 Cannon Cradle)

Determination of optimal parameters for the M1A1 cannon cradle repair was developed in a similar manner to the helical gear shaft. However, in this case, the ESD repair procedure was developed at ANAD and subsequently refined and proved out at ARL. Table 2 contains the iterations utilized.

Table 2. ESD parameter optimization for M1A1 cannon cradle.

	<b>Condition 1</b>	<b>Condition 2</b>
Base material	4130 steel	4130 steel
Non-ESD coating	Chrome plating	Chrome plating
Electrode alloy	Inconel 718	Inconel 718
Electrode diameter (in)	0.125	0.125
Pulse rate (Hz)	580	400
Capacitance ( $\mu$ F)	20	30
Voltage (V)	100	150
Step rate (Hz)	270	340
Swing	3	3
Rotate increment	3	3
Direction	CW	CW
Interval	6	6
Shielding gas	Argon	Argon
Shielding gas flow rate (CFH)	35	35

Note: CW = clockwise.

The optimal ESD process parameters established for the repairing of defects within the M1A1 cannon cradle were those of condition 2:

- Material AISI 4130 steel
- Electrode: Inconel 718
- ESD unit settings:
  - Rotating torch
  - Pulse rate = 400 Hz
  - Capacitance = 30  $\mu$ F
  - Voltage = 150 V

### **6.3 Repair Qualification**

The repair qualification of the components was based upon the ability of the coating to adhere adequately to the substrate to withstand a finish grinding procedure. ARL conducted tests where mechanical pits were machined into AISI 4130 steel blocks, representative of the base material and subsequently filled utilizing the ESD repair procedure developed for the component. Additional samples that were chrome plated were also repaired by ESD and compared to the initial test group to determine the feasibility of performing an ESD repair on chrome-plated parts. A subsequent grinding operation was performed, after the pits were completely filled, to simulate subsequent manufacturing to bring the part back to the final dimension and surface finish requirement. Metallographic examination and hardness testing were performed on the samples and compared to the substrate.

#### **6.3.1 Metallography**

Metallography was utilized to examine test pieces that had defects filled with ESD to ensure that the deposit did not contain significant voids, porosity, or cavities. This would give an indication that the adhesion to the substrate material was adequate. Specimens were sectioned through the deposit and mounted in phenolic powder. The mounted specimens were subsequently rough polished using silicon carbide paper ranging in grit size from 240 to 2400. Final polishing was accomplished with 1- $\mu$ m diamond followed by 0.05- $\mu$ m alumina. For the most part, the interface between the substrate and the ESD deposit was determined to be acceptable (figure 15, representative); however, areas of surface porosity were sometimes encountered with the chrome plated samples (figures 16 and 17, representative). Advanced Surfaces and Processes (ASAP), Inc., describes this phenomenon as, “small defects (named the “halo effect”) where ESD meets the chrome.”<sup>3</sup> ASAP, Inc. indicated that improvements are seen in reducing/eliminating this effect specifically when the ESD equipment parameters were maintained at low energy while

---

<sup>3</sup>Price, N. *ESD/Chrome Halo Effect*; Advanced Surfaces and Processes, Inc.: Cornelius, OR, 1 October 2004, p 1.

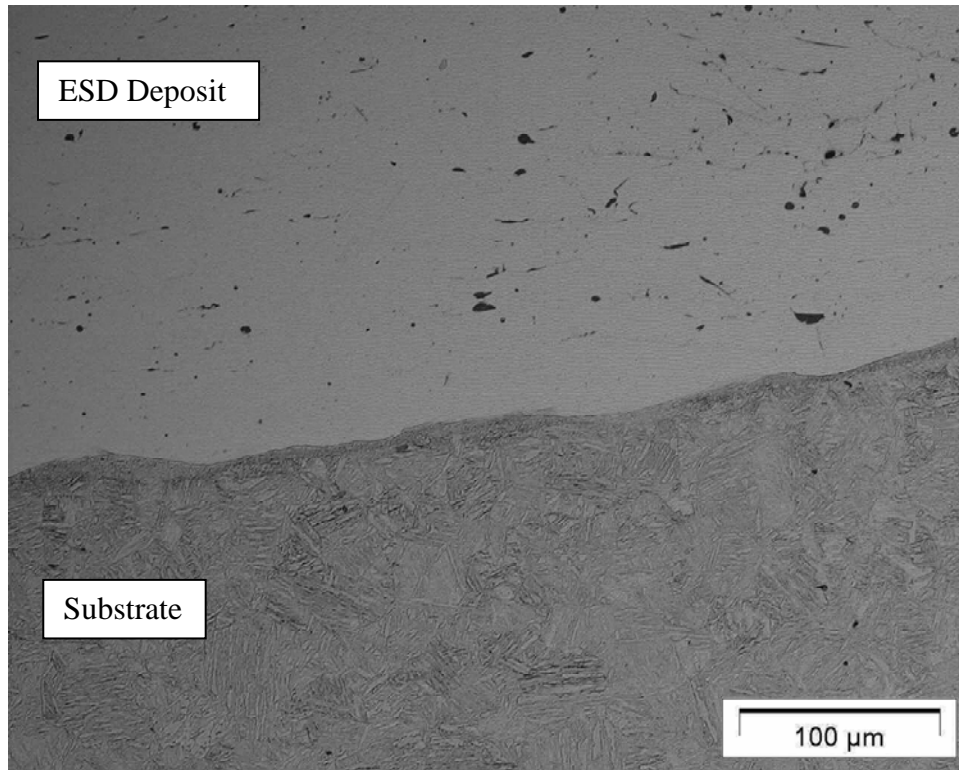

Figure 15. Photomicrograph showing interface between deposit and substrate. Substrate was AISI 9310 steel etched with 2% nital (magnified 200×).

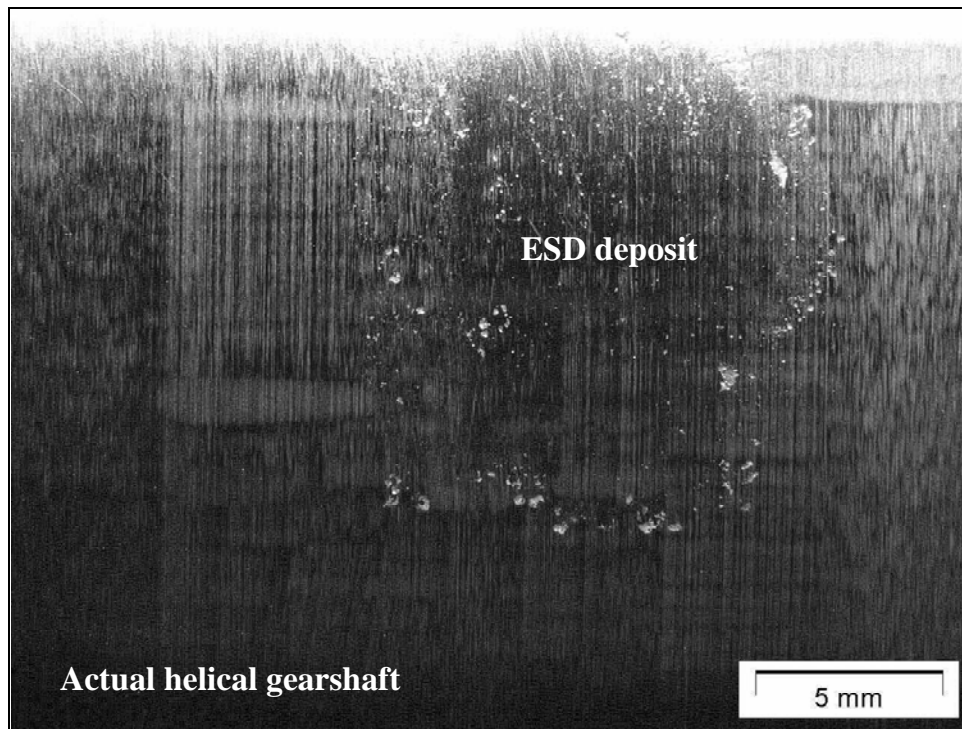

Figure 16. Porosity around the ESD deposit ("halo effect") of a chrome-plated sample (magnified 5×).

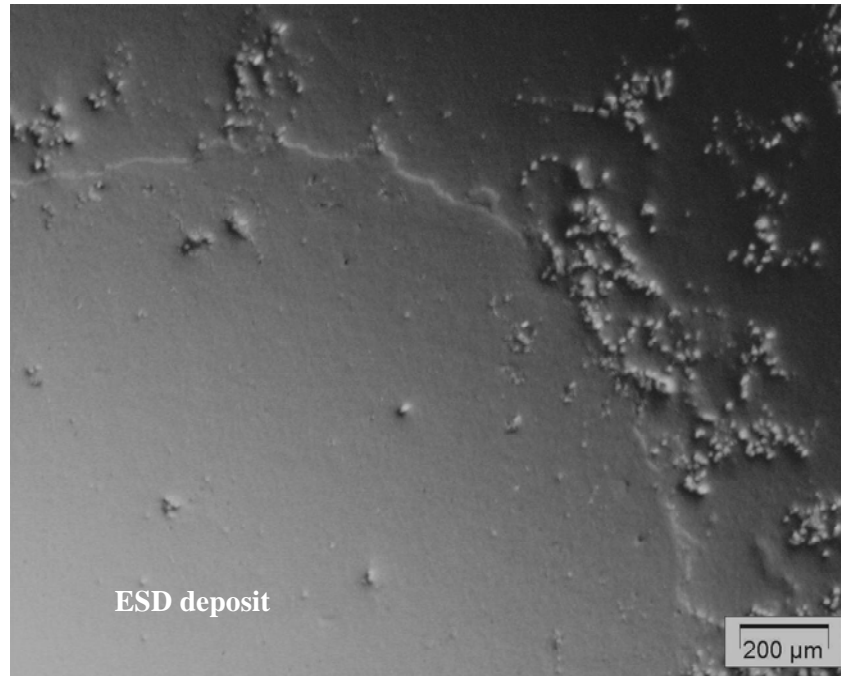

Figure 17. Magnified view of figure 16 utilizing the differential interference contrast mode for optical viewing (magnified 50×).

applying the ESD/chrome interface. Figure 18 shows a polished cross section displaying the porosity associated with the “halo effect,” while figure 19 shows no anomalies for a different chrome-plated ESD deposit.

### 6.3.2 Hardness Testing

The Knoop microhardness scale (with a major load of 500 gmf) was utilized to assess the hardness of the deposit and the substrate, even though it has been shown that the ESD process has little to no deleterious effect on the substrate.<sup>4</sup> The substrate was AISI 9310 steel heat treated to a hardness of ~40 HRC, as the results in table 3 show. The hardness of the deposit and the base metal was essentially the same. In addition, the hardness of the base metal was not altered as a result of the ESD process. Figure 20 shows a graph of the hardness data, and figure 21 includes a micrograph of the hardness indents through the deposit into the base metal.

## 6.4 Inspection Criteria

The methods of inspection employed for the repair of the cannon cradle reflect the concerns of serviceability (visual inspection), dimensional conformance, and surface finish, while an additional liquid penetrant inspection is required for the helical gear shaft. Stereoscopic inspection was performed utilizing a 10× lens to examine the repaired surface for evidence of blistering, peeling, and/or cracking, which is not allowed and is a cause for rejection.

---

<sup>4</sup>Wang, P. Z.; Pan, G. S.; Zhou, Y.; Qu, J. X.; Shao, H. S. Accelerated Electrospark Deposition and Wear Behavior of Coatings. *Journal of Materials Engineering and Performance* **1997**, 6 (6), 780–784.

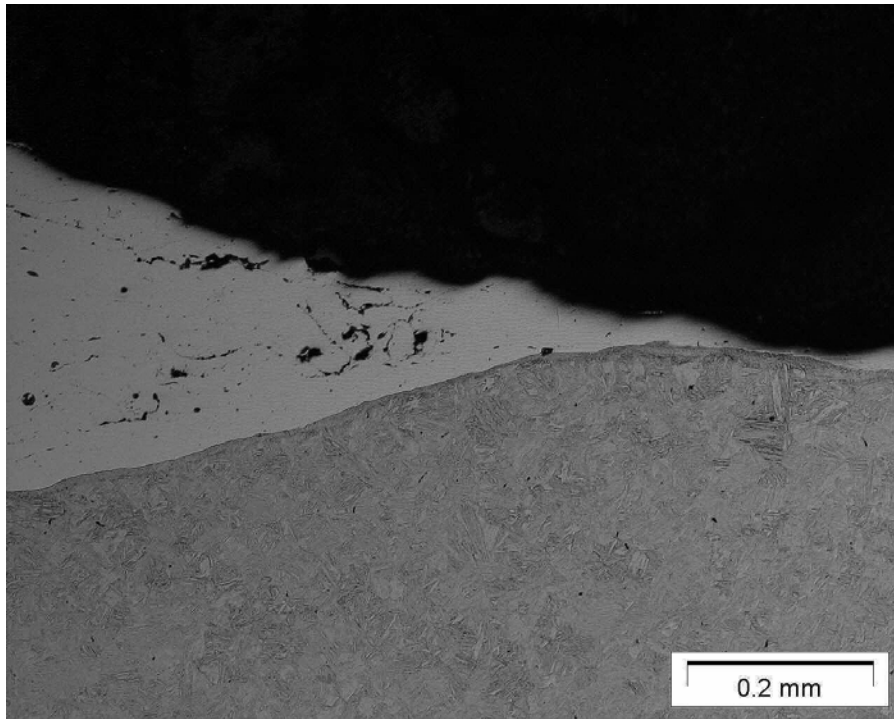

Figure 18. Polished and etched cross section showing porosity associated with the “halo effect” in a chrome-plated 9310 steel sample. Etchant: 2% nital (magnified 500×).

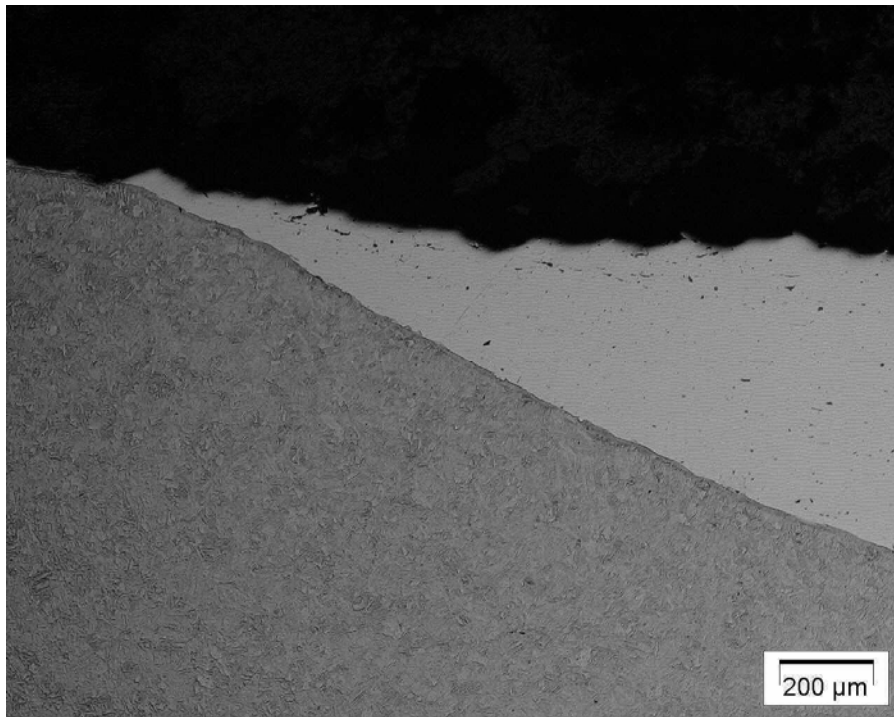

Figure 19. Polished sample cross section of an ESD-filled, chrome-plated defect showing no anomalies (magnified 200×).



Table 3. Microhardness test results; Knoop scale; 500 gmf, 50× objective.

Reading	Knoop	Approx. HRC	Reading	Knoop	Approx. HRC
1	331.0	32.6	13	313.6	30.3
2	326.1	32.0	14	372.4	37.2
3	361.4	36.1	15	390.9	38.9
4	390.9	38.9	16	377.3	37.7
5	361.9	36.1	17	381.8	38.1
6	365.0	36.5	18	395.0	39.3
7	390.3	38.9	19	397.9	39.6
8	364.5	36.4	20	395.0	39.3
9	405.2	40.2	21	396.8	39.5
10	405.8	40.3	22	392.6	39.1
11	390.3	38.9	23	401.5	39.9
12	391.5	39.0	24	397.9	39.6

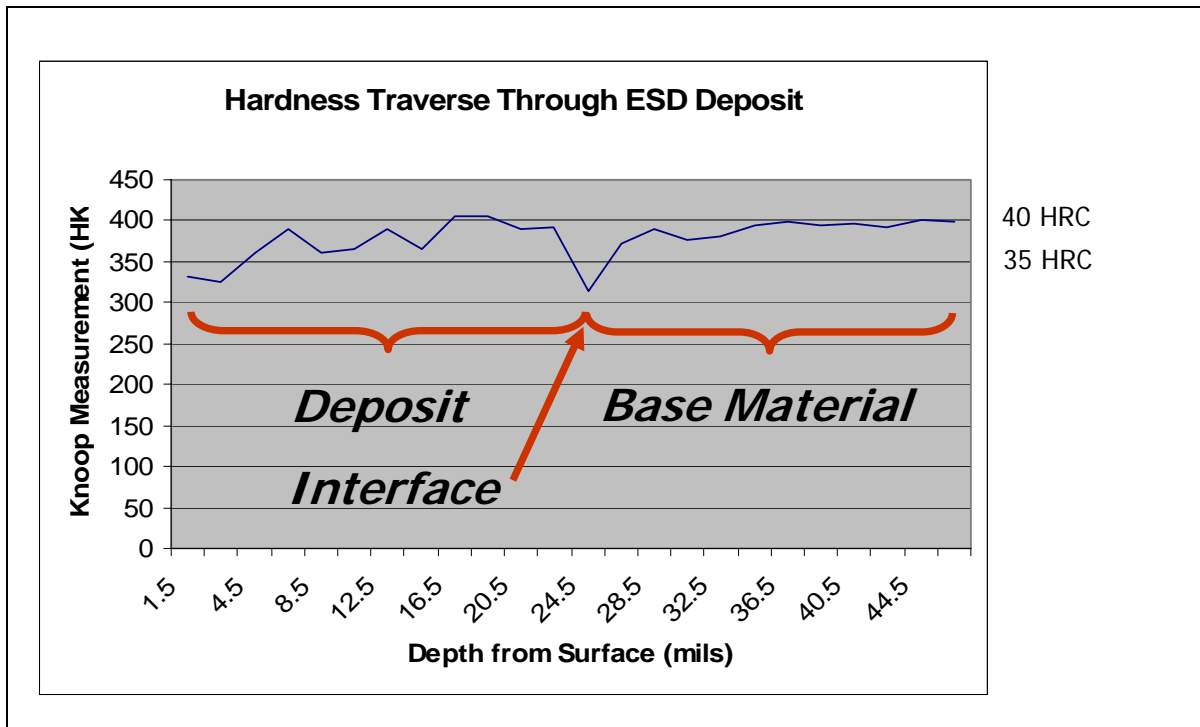

Figure 20. Plot of hardness through ESD into the base metal, showing similar hardness values.

## 6.5 Engineering Approval

The reclamation procedure for the cannon cradle was approved by ANAD Engineering and has been performed since 25 June 2003. The procedure for the helical gear shaft awaits the results of testing ESD repaired test gears within the AGT-1500 engine test stand at 25 and 100 hr. Additional components have been selected for possible ESD repair based on the success of this effort, including the M88/M60 roadwheel arm spindle, the M198 recoil rod, and the M1A1 converter shaft.

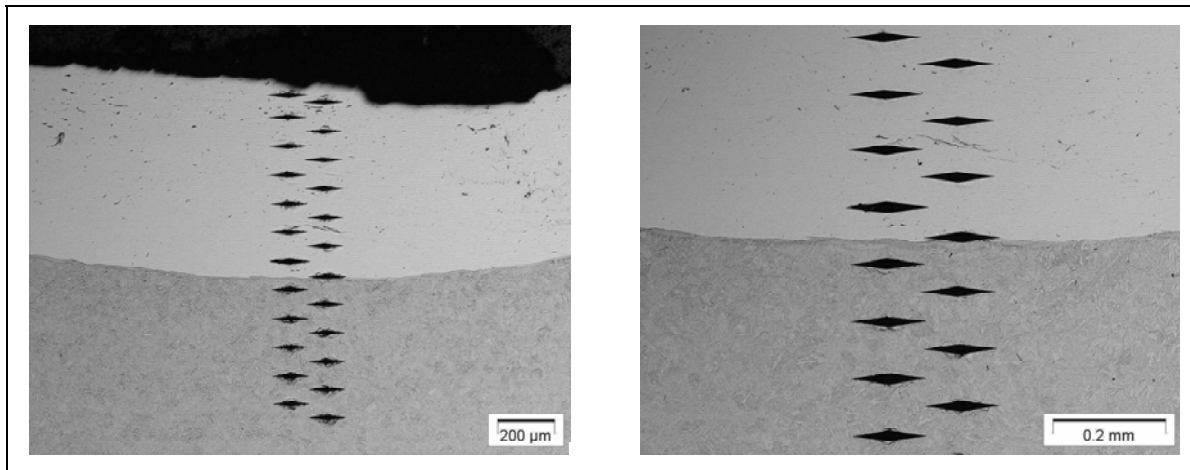

Figure 21. Micrographs of Knoop microhardness indents through the ESD into the base metal. Base metal etched with 2% nital (magnified 50× [left] and 100× [right]).

---

## 7. Discussion

---

The compact ESD equipment is so relatively easy to operate that it could be incorporated for use on U.S. Navy ships such as aircraft carriers and submarines, as well as at U.S. Air Force repair facilities and Army depots that perform intermediate-level maintenance activities. Components that would normally have to be removed from the weapons system and shipped back to a depot-level facility could be repaired on-site, eliminating costs and waste generation. There are also significant environmental benefits associated with the implementation of ESD technology including the elimination of brush and hard chromium plating and the wastes associated with its use. Fatigue testing should be performed for the qualification of loaded rotating components. Flat dog-bone fatigue specimens will be fabricated with and without ESD repair to produce baseline data. These specimens are schematically illustrated in figures 22 and 23.

Since the approval of the ESD repair for the M1A1 cannon cradle by the Tank Automotive Command (TACOM), there have been 15 parts identified for reclamation. This equates to a potential cost savings of ~\$360,000 to be realized by ANAD, based upon the rejection rates during the fourth quarter FY03 and the first half of FY04. A total of 189 parts was inspected, and 15 were identified for reclamation. To date, nine of these parts have been successfully repaired by ESD technology.

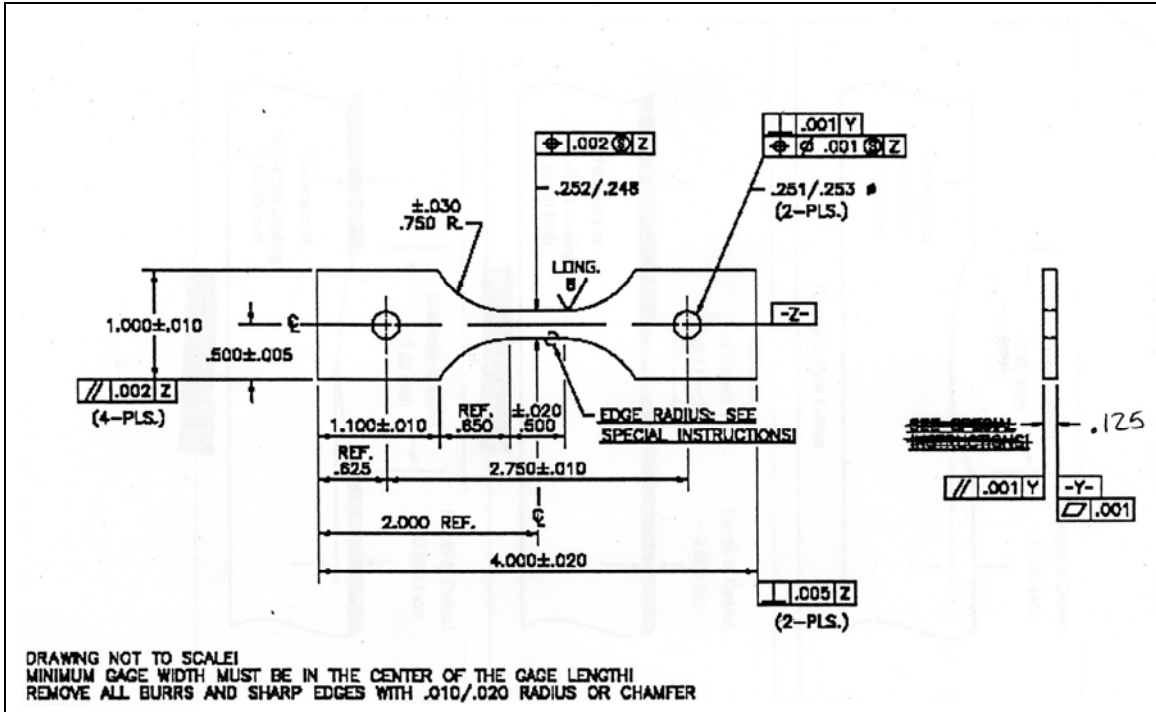

Figure 22. Schematic of fatigue dog-bone specimen to be used to generate baseline data.

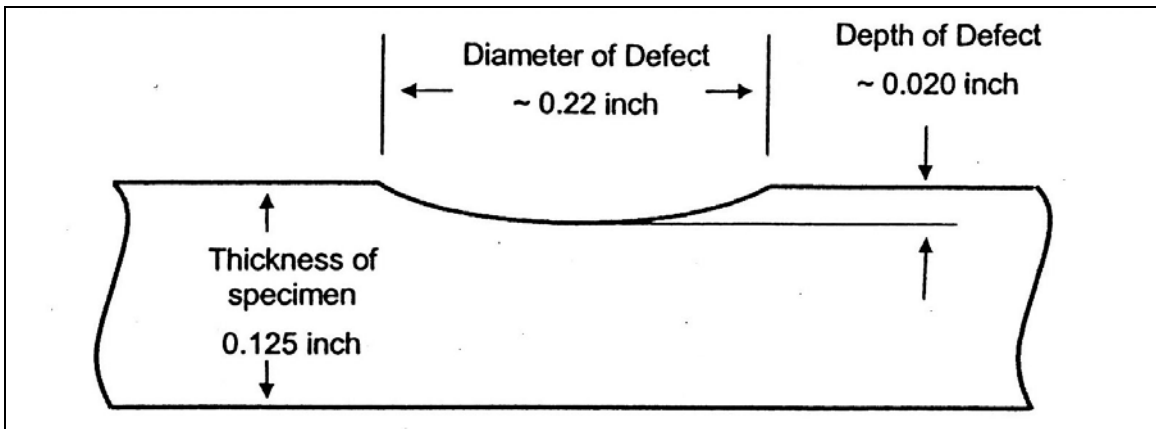

Figure 23. Schematic of defect dimensions to be machined into fatigue dog-bone specimens. These defects will be machined into one-half of the specimens, and subsequently filled with ESD.

---

## 8. Cost Analysis

---

The following analysis calculates the cost savings to date by the implementation of the repair of the Army fighting vehicle component at ANAD for the nine M1A1 cannon cradles that have been repaired, as well as the anticipated cost savings for all 15 parts that have been identified for repair. The cost to purchase a new component is \$24,636.00. The reclamation costs have been determined to be \$698.50, based on a labor rate of \$76.50/manhour for 9 hours and a material cost of \$10.00.

Using these facts, the cost savings for repairing nine components can be calculated as follows:

- The cost to purchase nine new parts:  $\$24,636.00 \times 9 = \$221,724.00$ .
- The cost to repair nine pitted parts:  $\$698.50 \times 9 = \$6,286.50$ .

The total cost savings *equals* the cost to purchase nine new parts *minus* the cost to repair nine pitted parts or  $\$221,724.00 - \$6,286.50 = \$215,437.50$ .

The cost savings for repairing 15 parts can be calculated as follows:

- The cost to purchase 15 new parts:  $\$24,636.00 \times 15 = \$369,540$ .
- The cost to repair 15 pitted parts:  $\$698.50 \times 15 = \$10,477.50$ .

The total cost savings *equals* the cost to purchase 15 new parts *minus* the cost to repair 15 pitted parts or  $\$369,540 - \$10,477.50 = \$359,062.50$ .

---

## 9. Recommendations/Future Work

---

ARL purchased and installed an audible feedback force control tool developed by Pacific National Laboratories to be used in conjunction with the ESD process. The audible pressure sensing device is intended to provide the operator feedback related to his or her technique. ARL discussed this apparatus with ASAP at a 5 August 2005 meeting. This effort was funded in part through a Congressional Plus-Up Program managed by Phil Darcey of Benet Labs.

Testing is underway at ASAP to evaluate the effectiveness of this instrument. The second system for ANAD has not been installed. ARL has not conducted a study to evaluate this system, but preliminary discussions revealed that the consensus is that it may be a good training tool in that it does prevent the operator from applying excess pressure but may be a hindrance to an experienced ESD operator. Regardless, at this time, the jury is still out since there is no quantifiable data available to make a sound decision.

At the last meeting at ARL, ASAP presented the progress to date on the project “Feasibility of Electrospark deposition (ESD) on Carburized 9310 Steel.” The ultrasonic consolidation method to improve the density of the ESD deposit was discussed. Preliminary results indicate that the UT technique can not only improve the density of the ESD deposit but also increase the hardness. This is a result of the compressive stresses imparted by the UT method, which is analogous to peening the surface. The fatigue data that was generated for the ESTCP Electrospark Deposition Demonstration Plan was discussed, and plans were made to test 10 fatigue specimens containing defects that are to be repaired by ESD and 10 fatigue samples without defects or ESD repair, as a baseline.

---

## **10. Conclusions**

---

- ESD has been demonstrated to be a viable repair of corrosion pits and wear on both AISI 4130 and 9310 steels for use on nonrotating components.
- Caution must be taken when repairing chrome-plated components in order to reduce/eliminate the “halo effect.”

INTENTIONALLY LEFT BLANK.

---

**Appendix A. M1A1 Cradle Reclamation Procedure**

---

**RECLAMATION PROCEDURE - M1A1 Cannon Cradle**  
**ANNISTON ARMY DEPOT**  
**PROCESS MANAGEMENT DIVISION**

<b>NUMBER:</b> PMD 03-39 (REV 1)	<b>PAGE 1 OF 4 PAGE</b>	<b>DATE:</b> 25 June 2003	
<b>NOUN:</b> Cradle	<b>NSN:</b> 1015-01-262-8613	<b>P/N:</b> 9377202	
	<b>UNIT PRICE:</b> \$24,636.00		
<b>END ITEM:</b> M1A1	<b>ESTIMATED RECLAMATION COST:</b>		
	<b>MANHOURS:</b> 9	@ \$76.50	= \$ 688.50
	<b>MATERIALS:</b>		= 10.00
<b>PREPARED BY:</b> Ivey		<b>TOTAL</b>	= \$ 698.50

**REMARKS:** Suggestion AMVA030051

**PURPOSE:** To repair pits in the 13.254"+ .003" ID of Cradle, P/N 9377202. The pits to be repaired are those that still remain after the cradle ID is ground the maximum amount allowed during the preparation phase of the ID chrome plating reclamation procedure found in DMWR 9-2350-264-2.

**NOTES:**

1. Disassembly, cleaning, and assembly to be IAW DMWR 9-2350-264-2.
2. Cradle must meet all other requirements of DMWR 9-2350-264-2 prior to becoming a candidate for repair using this procedure.
3. **IMPORTANT**-Repair only the pits that are in "Zone AR" and the .380" wide area of the ID between "Zone AR" and the end of the cradle (See Drawing 9377202). Pits in "Zone AT" of the ID are not to be repaired using this procedure.
4. Pits larger than .375"Ø x .050" cannot be repaired using this procedure.
5. No more than 10 pits may be repaired using this procedure.
6. This procedure has been successfully accomplished at ANAD (See attached photos).

**1. EQUIPMENT:**

- a. As required by DMWR 9-2350-264-2.
- b. ElectroSpark Deposition (ESD) Equipment as manufactured by Advanced Surfaces and Processes, Inc., or equal. <http://www.advanced-surfaces.com/>
- c. Hand-held, high-speed grinder w/grinding tool and wire brush.
- d. ID Grinder.

SIOAN FORM 750-127-E, Rev 12 Mar 97  
(RPLS SDSAN Form 1002)



**RECLAMATION PROCEDURE – M1A1 Cannon Cradle**  
**ANNISTON ARMY DEPOT**  
**PROCESS MANAGEMENT DIVISION**

---

**NUMBER:** PMD 03-39 (REV 1)

**PAGE 2 OF 4 PAGE**

**DATE:** 25 June 2003

---

**2. MATERIAL:**

- a. As required by DMWR 9-2350-264-2.
- b. Vapor degreaser.
- c. Inconel 718 bare electrode (.125" Diameter x 4" long).

**3. PROCEDURE:**

- a. Clean cradle using vapor degreaser.
- b. Using hand-held grinder w/wire brush, remove corrosion from pit.
- c. Using hand-held grinder w/grinding tool, break the sharp edges of the pit. If possible, maintain a width to depth ratio of 10:1 minimum to 20:1. The finish on the excavated defect should be in the 32-64 rms range for best ESD results.
- d. All excavated areas and areas immediately adjacent to areas to be ESD repaired should be aggressively rubbed with a suitable medium grade abrasive pad followed by an isopropyl alcohol wash using a clean, lint-free cloth. If ESD repairs are not made within 24 hours after cleaning, it is recommended that the area to be ESD repaired be re-cleaned using the method described in this paragraph.
- e. Grounding: All components requiring ESD repair must be properly grounded. The grounding clamp should be placed on an area of the part not designated to receive ESD and must be tightly clamped to prevent arcing between the ground clamp and the component. Place ground clamp as close to ESD work zone as practicable.
- f. Electrode Selection and Installation: A .125" diameter electrode shall be used for this repair, of either composition listed in paragraph 2c. The electrode selected should be evaluated for straightness as excessive run out will cause poor ESD. Electrode tip shall resemble a rounded cone geometry (shaped using Dremel® or similar tool), and shall stick out from torch by approximately 1-inch. The process of reshaping and cleaning the electrode tip will be done extensively during the ESD repair process as the electrode is consumed.
- g. Cover Gas: Shielding the ESD area with a cover gas is recommended whenever possible. For this procedure, argon gas with a flow rate of 35 CFH worked effectively.
- h. Electrode Rotational Speed and Stroke: An electrode rotation speed of approximately 1200 rpm is generally prescribed for affecting ESD repairs. The stroke utilized when repairing may include one or more of the following: 1) climbing only, 2) cutting only, 3) combination of cutting and climbing, 4) circular or semi-circular, and 5) zigzag.

**RECLAMATION PROCEDURE - M1A1 Cannon Cradle**  
**ANNISTON ARMY DEPOT**  
**PROCESS MANAGEMENT DIVISION**

<b>NUMBER:</b> PMD 03-39 (REV 1)	<b>PAGE 3 OF 4 PAGE</b>	<b>DATE:</b> 25 June 2003
----------------------------------	-------------------------	---------------------------

i. Using the ESD Equipment with the rotating torch (ASAP Model AH-98-MKIDD), the following settings/parameters and the electrode listed in paragraph 2c, fill the pit to .005" - .010" above the parent material surface. This will ensure complete cleanup during grinding.

- Pulse Rate - 580 Hz
- Capacitance - 20 mfd
- Voltage - 100 volts
- Shielding gas - Argon
- Shielding gas flowrate - 35 SCFH

j. Using ID grinder, grind ID to prepare for chroming IAW DMWR 9-2350-264-2.  
k. Chrome plate and finish grind ID IAW DMWR 9-2350-264-2.

**4. INSPECTION:**

<u>Characteristic</u>	<u>Method of Inspection</u>	<u>Requisite</u>
Serviceability	Visually (10X Microscope)	No blistering, peeling, cracking allowed.
Dimensional	Measure	IAW DMWR 9-2350-264-2
Surface Finish	Measure	IAW DMWR 9-2350-264-2

**RECLAMATION PROCEDURE – M1A1 Cannon Cradle**  
**ANNISTON ARMY DEPOT**  
**PROCESS MANAGEMENT DIVISION**

**NUMBER:** PMD 03-39 (REV 1)

**PAGE 4 OF 4 PAGE**

**DATE:** 25 June 2003



**PITS PREPARED FOR ESD REPAIR**

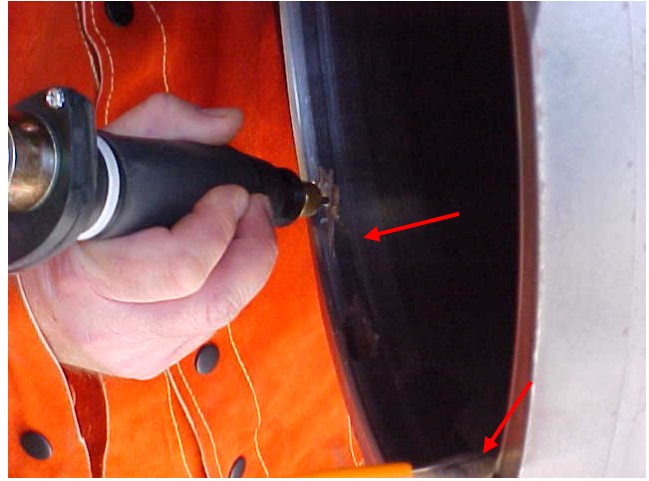

**REPAIR PROCESS**

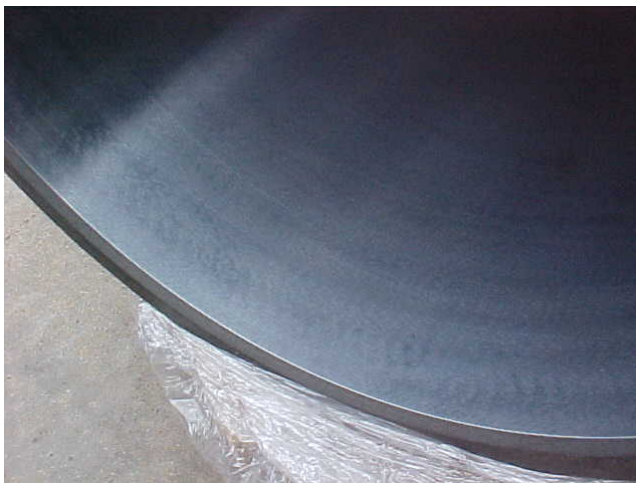

**AFTER ESD REPAIR, CHROME PLATING, AND FINISH GRINDING**

INTENTIONALLY LEFT BLANK.

---

**Appendix B. M1A1 Helical (Sun) Gear Reclamation Procedure**

---

**RECLAMATION PROCEDURE - M1A1 Helical (Sun) Gear shaft**  
**ANNISTON ARMY DEPOT**  
**PROCESS MANAGEMENT DIVISION**

<b>NUMBER:</b>	<b>PAGE 1 OF 6 PAGES</b>	<b>DATE:</b> January 11, 2006	
<b>NOUN:</b> helical gear	<b>NSN:</b>	<b>P/N:</b> 12284387	
	<b>UNIT PRICE:</b> \$2,195.00		
<b>END ITEM:</b> M1A1	<b>ESTIMATED RECLAMATION COST:</b>		
	<b>MANHOURS:</b> 8	@ \$76.50	= \$ 612.00
	<b>MATERIALS:</b>		= \$ 30.00
<b>PREPARED BY:</b>		<b>TOTAL</b>	= \$ 642.00

**REMARKS:**

**PURPOSE:** To repair pits and wear marks which extend through the chrome plating to the base metal in the 3.5005"+ .0005" OD of helical gear shaft, P/N 12284387.

**NOTES:**

1. Disassembly, cleaning, and assembly to be IAW NMWR 9-2835-255-5.
2. Gear shaft must meet all other requirements of NMWR 9-2835-255-5 prior to becoming a candidate for repair using this procedure.
3. **IMPORTANT-** Repair only corrosion pits and wear marks that are in "Zone 7" (See Drawing 12284387). Wear marks larger than 0.375" wide cannot be repaired using this procedure.
4. Pits larger than .375"Ø x .050" deep cannot be repaired using this procedure. Wear marks larger than .375" wide cannot be repaired using this procedure.
5. No more than 3 flaws may be repaired using this procedure.
6. This procedure has been successfully accomplished at ARL (See attached photos).

**1. EQUIPMENT:**

- a. As required by NMWR 9-2835-255-5.
- b. ElectroSpark Deposition (ESD) Equipment as manufactured by Advanced Surfaces and Processes, Inc., or equal (<http://www.advanced-surfaces.com/>)
- c. Hand-held, high-speed grinder w/grinding tool and wire brush.

SIOAN FORM 750-127-E, Rev 12 Mar 97  
(RPLS SDSAN Form 1002)

**RECLAMATION PROCEDURE - M1A1 Helical (Sun) Gear shaft**  
**ANNISTON ARMY DEPOT**  
**PROCESS MANAGEMENT DIVISION**

<b>NUMBER:</b>	<b>PAGE 2 OF 6 PAGES</b>	<b>DATE:</b> January 11, 2006
----------------	--------------------------	-------------------------------

**2. MATERIAL:**

- a. As required by NMWR 9-2835-255-5.
- b. Vapor degreaser.
- c. Inconel 718 bare electrode (.125" Diameter x 4" long).

**3. PROCEDURE:**

- a. Machine the 3.500 to 3.501 inch diameter (NMWR 9-2835-255-5, Figure G-2) removing the existing chrome plating down to the base metal.
- b. Measure machined diameter. If diameter is 3.490 inches or more, gear shaft may be reclaimed. If diameter is less than 3.490 inches, discard gear shaft.
- c. Use steel shot (NMWR 9-2835-255-5, item 26, Appx. C) at a peening intensity of 8 to 10A with a minimum coverage of 150% and shot peen area to be sprayed IAW AMS-S-13165. Mask features not to be chrome plated.
- d. Clean gear shaft using vapor degreaser.
- e. Using hand-held Dremel® tool (or equivalent), remove corrosion from pit.
- f. Using hand-held Dremel® tool (or equivalent), break the sharp edges of the pit or wear mark. If possible, maintain a width to depth ratio of 10:1 minimum to 20:1. The finish on the excavated defect should be in the 32-64 rms range for best ESD results.
- g. All excavated areas and areas immediately adjacent to areas to be ESD repaired should be aggressively rubbed with a suitable medium grade abrasive pad followed by an isopropyl alcohol wash using a clean, lint-free cloth. If ESD repairs are not made within 24 hours after cleaning, it is recommended that the area to be ESD repaired be re-cleaned using the method described in this paragraph.
- h. Grounding: All components requiring ESD repair must be properly grounded. The grounding clamp should be placed on an area of the part not designated to receive ESD and must be tightly clamped to prevent arcing between the ground clamp and the component. Place ground clamp as close to ESD work zone as practicable.
- i. Electrode Selection and Installation: A .125" diameter electrode shall be used for this repair, of either composition listed in paragraph 2c. The electrode selected should be evaluated for straightness as excessive run out will cause poor ESD. Electrode tip shall resemble a rounded cone geometry (shaped using Dremmel® or similar tool), and shall stick out from torch by approximately 1-inch. The process of reshaping and cleaning the electrode tip will be done extensively during the ESD repair process as the electrode is consumed.
- j. Cover Gas: Shielding the ESD area with a cover gas is recommended whenever possible. For this procedure, argon gas with a flow rate of 35 CFH worked effectively.

**RECLAMATION PROCEDURE - M1A1 Helical (Sun) Gear shaft**  
**ANNISTON ARMY DEPOT**  
**PROCESS MANAGEMENT DIVISION**

<b>NUMBER:</b>	<b>PAGE 3 OF 6 PAGES</b>	<b>DATE:</b> January 11, 2006
----------------	--------------------------	-------------------------------

k. Electrode Rotational Speed and Stroke: An electrode rotation speed of approximately 1200 rpm is generally prescribed for affecting ESD repairs. The stroke utilized when repairing may include one or more of the following: 1) climbing only, 2) cutting only, 3) combination of cutting and climbing, 4) circular or semi-circular, and 5) zigzag.

l. Using the ESD Equipment with the rotating torch (ASAP Model AH-98-MKIDD), the following settings/parameters and the electrode listed in paragraph 2c, fill the pit or wear mark to .005" - .010" above the parent material surface. This will ensure complete cleanup during grinding.

- Pulse Rate - 400 Hz
- Capacitance - 30 mfd
- Voltage - 140 volts
- Shielding gas - Argon
- Shielding gas flowrate - 35 SCFH

m. Finish grind OD IAW Eng. Dwg. 12284387.

n. Chrome plate gear shaft diameter in accordance with NMWR 9-2835-255-5 (Paragraph D.14, Appendix D) to exceed final diameter requirements shown on Figure G-2. Minimum chrome thickness must be 0.002 inch after final machining.

o. Place plated gear shaft in oven (IAW NMWR 9-2835-255-5; Paragraph 2.1) heated to  $265 \pm 10^{\circ}\text{F}$  for five (5) hours. Remove from oven. Machine chrome plated surface to meet dimensional and finish requirements shown in NMWR 9-2835-255-5 (Figure G-2). Chrome thickness after final machining must be from 0.002 to 0.005 inch.

p. Inspect gear shaft IAW NMWR 9-2835-255-5 (OIP-12284368/12284387, Table 4-6).

q. Inspect chrome plating IAW NMWR 9-2835-255-5 (Paragraph D.13, Appendix D).

r. Balance gear shaft IAW NMWR 9-2835-255-5 (Appendix L).



**RECLAMATION PROCEDURE - M1A1 Helical (Sun) Gear shaft**  
**ANNISTON ARMY DEPOT**  
**PROCESS MANAGEMENT DIVISION**

<b>NUMBER:</b>	<b>PAGE 4 OF 6 PAGES</b>	<b>DATE:</b> January 11, 2006
----------------	--------------------------	-------------------------------

**4. INSPECTION:**

<u>Characteristic</u>	<u>Method of Inspection</u>	<u>Requisite</u>
Serviceability	Visually (10X Microscope)	No blistering, peeling, or cracking allowed.
	Liquid Penetrant Inspection	IAW Eng. Dwg. 12284387
Dimensional	Measure	IAW Eng. Dwg. 12284387
Surface Finish	Measure	IAW Eng. Dwg. 12284387

RECLAMATION PROCEDURE - M1A1 Helical (Sun) Gear shaft  
ANNISTON ARMY DEPOT  
PROCESS MANAGEMENT DIVISION

NUMBER:	PAGE 5 OF 6 PAGES	DATE: January 11, 2006
---------	-------------------	------------------------

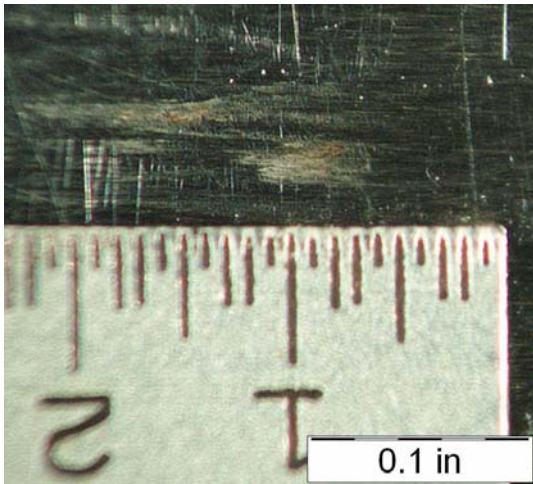

CORROSION PIT FOR ESD REPAIR

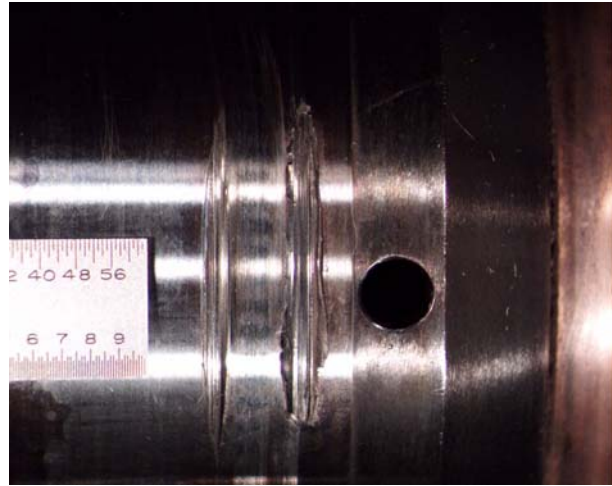

WEAR MARK FOR ESD REPAIR

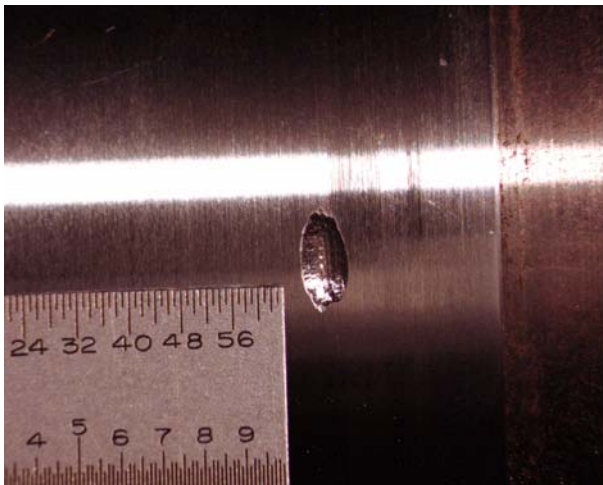

CORROSION PIT PREPARED FOR ESD

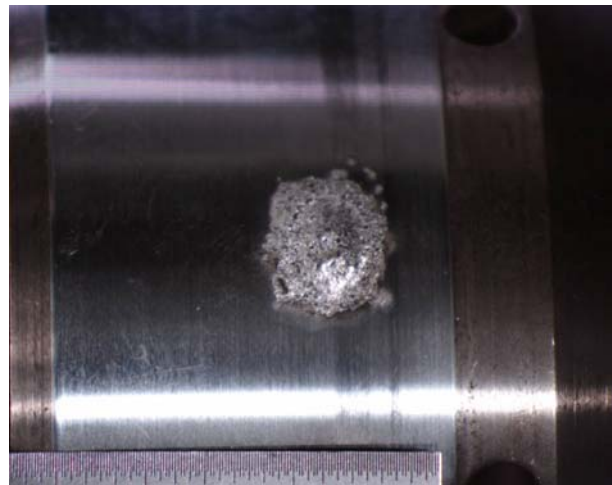

CORROSION PIT FILLED IN BY ESD

**RECLAMATION PROCEDURE - M1A1 Helical (Sun) Gear shaft**  
**ANNISTON ARMY DEPOT**  
**PROCESS MANAGEMENT DIVISION**

---

<b>NUMBER:</b>	<b>PAGE 6 OF 6 PAGES</b>	<b>DATE:</b> January 11, 2006
----------------	--------------------------	-------------------------------

---

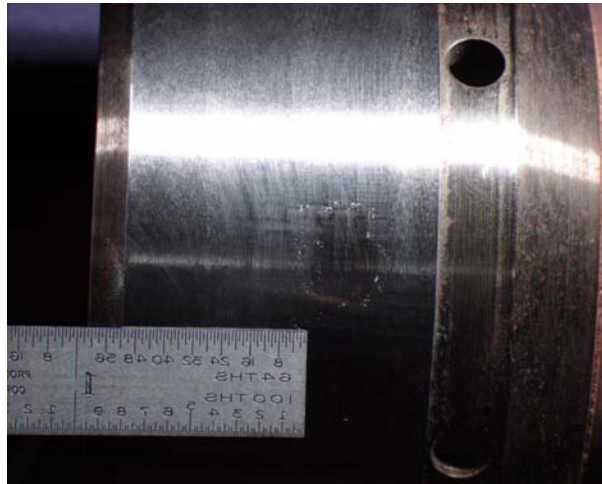

**CORROSION PIT AFTER ESD REPAIR AND FINISH GRINDING**

NO. OF  
COPIES ORGANIZATION

1 DEFENSE TECHNICAL  
(PDF INFORMATION CTR  
ONLY) DTIC OCA  
8725 JOHN J KINGMAN RD  
STE 0944  
FORT BELVOIR VA 22060-6218

1 US ARMY RSRCH DEV &  
ENGRG CMD  
SYSTEMS OF SYSTEMS  
INTEGRATION  
AMSRD SS T  
6000 6TH ST STE 100  
FORT BELVOIR VA 22060-5608

1 INST FOR ADVNCD TCHNLGY  
THE UNIV OF TEXAS  
AT AUSTIN  
3925 W BRAKER LN  
AUSTIN TX 78759-5316

1 DIRECTOR  
US ARMY RESEARCH LAB  
IMNE ALC IMS  
2800 POWDER MILL RD  
ADELPHI MD 20783-1197

3 DIRECTOR  
US ARMY RESEARCH LAB  
AMSRD ARL CI OK TL  
2800 POWDER MILL RD  
ADELPHI MD 20783-1197

ABERDEEN PROVING GROUND

1 DIR USARL  
AMSRD ARL CI OK TP (BLDG 4600)

<u>NO. OF</u> <u>COPIES</u>	<u>ORGANIZATION</u>
1	USA RDECOM AMSRD AMR AE F M K BHANSALI BLDG 4488 RM B276 REDSTONE ARSENAL AL 35898
1	NAVAL RSRCH LAB ENVIRON TECHN LGY PM B D SARTWELL CODE 6170 4555 OVERLOOK AVE SW WASHINGTON DC 20375
1	USA RDECOM AMSRD AMR AE F M G WECHSLER BLDG 4488 RM B269 REDSTONE ARSENAL AL 35898
1	USA RDECOM AMSRD AMR AE F M M KANE BLDG 4488 RM B266 REDSTONE ARSENAL AL 35898
1	USA RDECOM AMSRD AMR AE F M R MCFARLAND BLDG 4488 RM B272 REDSTONE ARSENAL AL 35898
1	USA RDECOM AMSRD AMR AE F M L D CRISP BLDG 4488 RM B274 REDSTONE ARSENAL AL 35898
1	US ARMY AVN AND MIS CMD AMSAM EN M FEATHERS BLDG 111 REDSTONE ARSENAL AL 35898
1	CMD AMCOM AMCOM G 4 LOGISTICS AMSAM EN EV W ALVAREZ REDSTONE ARSENAL AL 35898-5000

<u>NO. OF</u> <u>COPIES</u>	<u>ORGANIZATION</u>
1	NAVAL RSRCH LAB CTR FOR CORROSION SCI AND ENGRG B BAYLES CODE 6132 BLDG 3 RM 264 4555 OVERLOOK AVE SW WASHINGTON DC 20375-5342
1	NAVAIR J YADON CODE 4.9 NADEP JACKSONVILLE FL 32212
1	NAVAL AIR DEPOT MTRL ENGRG DIV G BARNETT AIR 4.9.7 CHERRY POINT NC 28533
1	NAVAIR W FRAZIER AIR 4.9T 48066 SHAW RD BLDG 2187 RM 1282 PATUXENT RIVER MD 20670
1	NAVAIR J BARONOWSKI CODE 497600D 1900 N KNOX RD STOP 6213 CHINA LAKE CA 93555

INTENTIONALLY LEFT BLANK.