

# Elevate Window Installation

## New Wood Frame Construction

---

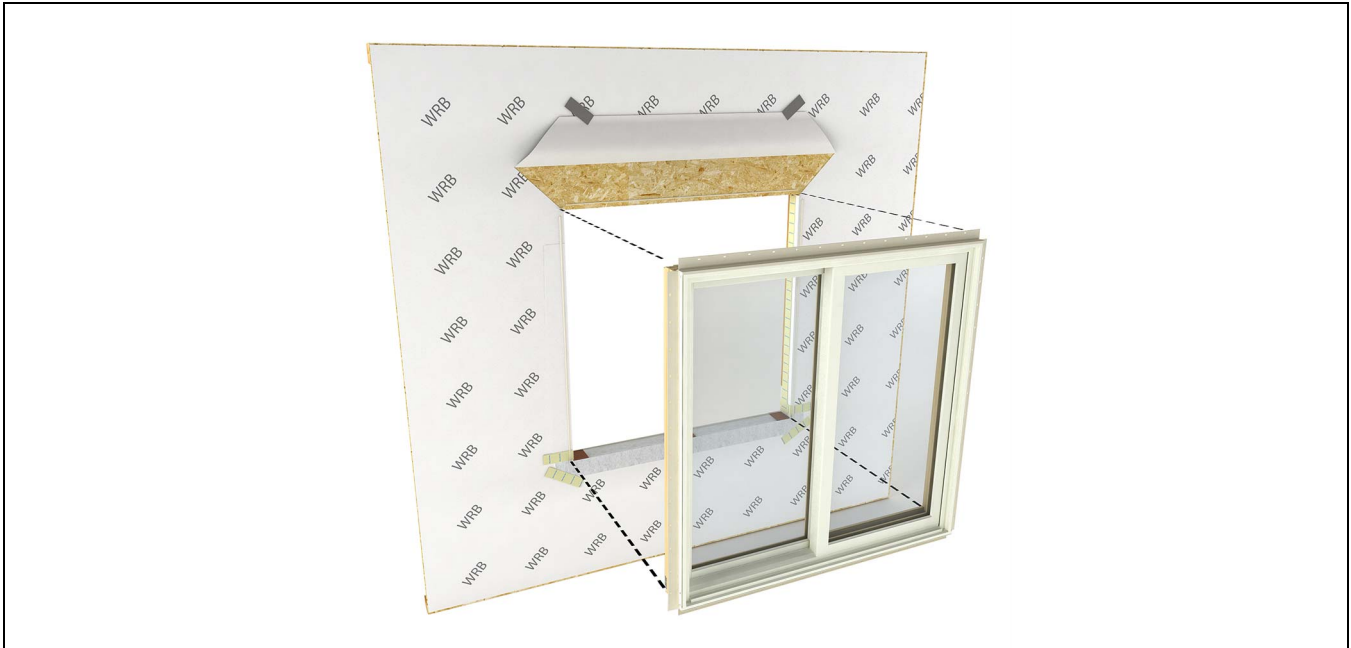

## Introduction

These instructions are applicable for the following window products:

- Casement Family
- Double Hung Family
- Round Top
- Polygon
- Glider

**ABSTRACT:** Please read these instructions in their entirety before beginning to install your Integrity window product. These installation instructions demonstrate the installation of a Elevate window in new wood frame construction using an industry approved water management system. For installation using other construction methods, such as remodeling, replacement, and recessed openings refer to “ASTM E2112-01, Standard Practice for Installation of Exterior Windows, Doors and Skylights,” for installation suggestions. Information for ASTM E2112 can be found on the ASTM website, [www.astm.org](http://www.astm.org).

For product specific issues, service instructions and other field service guides, refer to the Integrity Service Manual, visit our website at [www.marvin.com](http://www.marvin.com), or contact your Marvin representative.

Regional standard practices, environmental conditions, and codes may vary and supersede the procedures contained within. The responsibility for compliance is yours: the installer, inspector, and owner(s).

The procedures within these instructions are consistent with those used in testing to achieve the advertised DP rating.

The English language version of this Elevate Installation Instruction is the official version and shall take precedence over any translation

## WARNING

Always practice safety! Wear the appropriate eye, ear and hand protection, especially when working with power tools.

## WARNING

This product can expose you to chemicals including methanol, which is known to the state of California to cause birth defects or other reproductive harm. For more information, go to [www.P65Warnings.ca.gov](http://www.P65Warnings.ca.gov).

## WARNING

This product can expose you to chemicals including titanium oxide, which is known to the state of California to cause cancer. For more information, go to [www.P65Warnings.ca.gov](http://www.P65Warnings.ca.gov).

## WARNING

Drilling, sawing, sanding or machining wood products can expose you to wood dust, a substance known to the State of California to cause cancer. Avoid inhaling wood dust or use a dust mask or other safeguards for personal protection. For more information go to [www.P65Warnings.ca.gov/wood](http://www.P65Warnings.ca.gov/wood).

## IMPORTANT

Please consult with local authorities to properly dispose and/or recycle all packaging, materials, and waste.

## Table of Contents

<a href="#">Installer and Builder Information .....</a>	<a href="#">3</a>
<a href="#">After Market Products .....</a>	<a href="#">3</a>
<a href="#">Standard Parts Shipped .....</a>	<a href="#">3</a>
<a href="#">You Will Need to Supply .....</a>	<a href="#">3</a>
<a href="#">Rough and Masonry Opening Requirements.....</a>	<a href="#">4</a>
<a href="#">Rough Opening Preparation .....</a>	<a href="#">5</a>
<a href="#">Preparing the Unit for Installation.....</a>	<a href="#">6</a>
<a href="#">Installing the Window .....</a>	<a href="#">8</a>
<a href="#">Flashing the Installation - Air Barrier Applications.....</a>	<a href="#">11</a>
<a href="#">Insulating and Sealing the Installation .....</a>	<a href="#">12</a>
<a href="#">Final Installation Procedures.....</a>	<a href="#">12</a>
<a href="#">Final Installation Procedures.....</a>	<a href="#">14</a>
<a href="#">Technical Installation Specifications.....</a>	<a href="#">15</a>

# Installer and Builder Information

- Always provide a copy of these instructions for the current building owner.
- Plan sizing of rough opening and clearance from exterior finishing systems to allow for normal materials shrinkage or shifting (e.g. wood structure with brick veneer; allow adequate clearance at sill). Failure to do so can void the Integrity warranty coverage.
- Refer to the Technical Installation Specifications section for technical specifications regarding the installation of this product. These installation requirements as well as the details in this section must be followed to achieve the advertised design press (DP) rating of this product.
- It is the responsibility of the builder, installer and subcontractors to protect the interior and exterior of windows or doors from contact with harsh chemical washes, construction material contamination and moisture. Damage to glazing, hardware, weather strip and cladding/wood can occur. Protect with painters tape and/or protective sheathing as required. Follow all guidelines regarding material use, preparation, personal safety and disposal.
- Refer to the enclosed painting and staining instructions on the last page for exterior and interior finish instructions.
- Contact your Marvin supplier if you have any questions regarding product and materials used in manufacturing or questions on replacement parts.
- Please refer to the PDF version of this instruction for further information regarding best practices, installer and builder information, code, and other legal requirements. The PDF version is the official document of record

## After Market Products

Alterations to Marvin products including window films, insulating or reflective interior window treatments or additional glazings can cause excessive heat buildup and/or condensation. They may lead to premature failures not covered under warranty by Marvin Windows and Doors.

Before purchasing or applying any product that may affect the installation or performance of Integrity windows contact the manufacturer of after market product/glazings that are not supplied by Marvin and request written product use, associated warranties and damage coverage. Provide this information and warranties to the end user and/or building owner for future reference.

## Standard Parts Shipped

Units are sent with hardware and four (4) nailing fin corner gaskets. Follow installation instructions included with part.

Note: Numbers listed in parentheses ( ) are metric equivalents in millimeters rounded to the nearest whole number

## You Will Need to Supply

- Safety Glasses
- Hearing protection
- Level
- Square
- Hammer
- Wood shims
- 2" Roofing Nails
- Insulation
- Tape Measure
- Perimeter Sealant
- Sill Pan Flashing
- Backing Material (foam backing rod)
- Low Expansion Foam Insulation
- Flashing Materials
- Weather Resistive Barrier

## Rough and Masonry Opening Requirements

1. Rough openings (RO) should be 1/2" (13) higher and 1" (25) wider than the outside measurement of the frame (1/2" on each side of the frame). See [Figure 1](#).

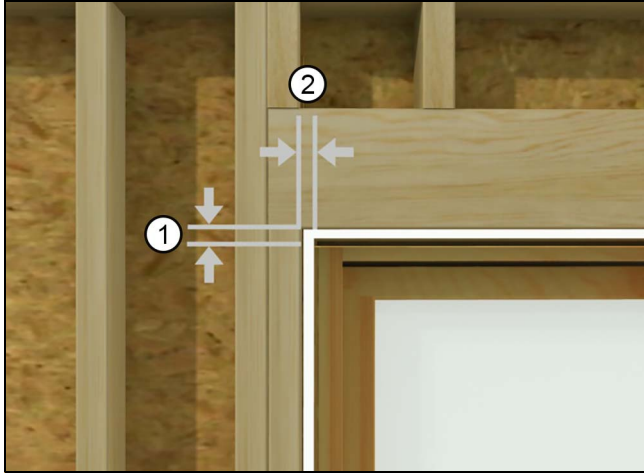

Figure 1

1	1/2" (13)
2	1/2" (13)

*NOTE: When framing rough opening, care should be taken to ensure the sill plate is level and the opening is square, straight and plumb.*

2. On shapes such as polygons, round tops, and octagons, make sure there is proper bracing. See [Figure 2](#).



Figure 2 Typical rough opening.

### ⚠ CAUTION

If the previous conditions are not met, the installer must take corrective actions to alter the opening(s) before proceeding. It is also essential that the sheathing behind the wall be a solid surface to ensure that the unit can be secured firmly to the wall.

3. Masonry openings (MO) should be 1/2" (13) wider than the outside measurement of the frame and casing (1/4" on each side) and 1/4" (6) higher than the outside measurement of the frame or casing. See [Figure 3](#).

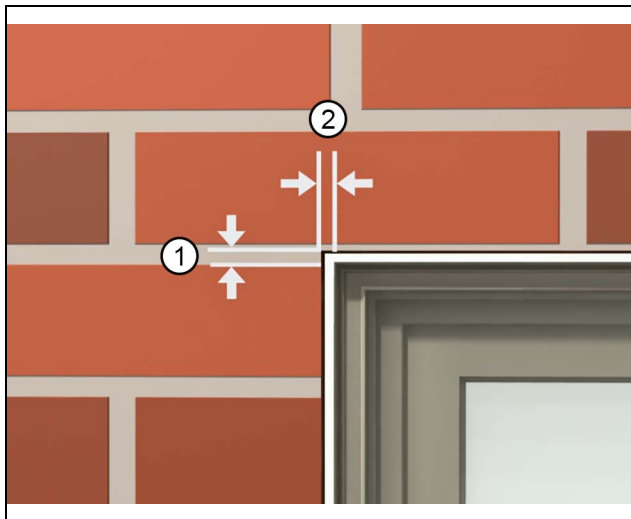

Figure 3 Typical Masonry Opening

1	1/4" (6)
2	1/4" (6)

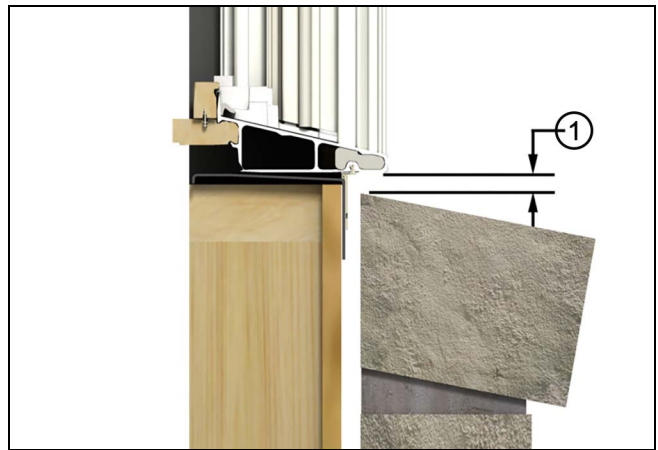

Figure 4 Avoid brick bind, maintain 1/2" gap

1	1/2" (13)
---	-----------

**NOTE:** On standard wood frame construction with brick veneer, make sure there is at least 1/2" (13) between bottom of window sill (or eventual placement of the window) and the top row of brick to avoid "brick bind". See [Figure 4](#).

## Rough Opening Preparation

1. The method shown below is Method A1 using a TYPE III flash pan. For step by step instructions on how to prepare an opening using this method, refer to [www.marvin.com/ROprep](http://www.marvin.com/ROprep) for instructions titled "Window Rough Opening Prep and Flashing Method A1-Membrane Drainage System". Refer to ASTM E2112-07 for other rough opening preparations that are more appropriate for your situation.

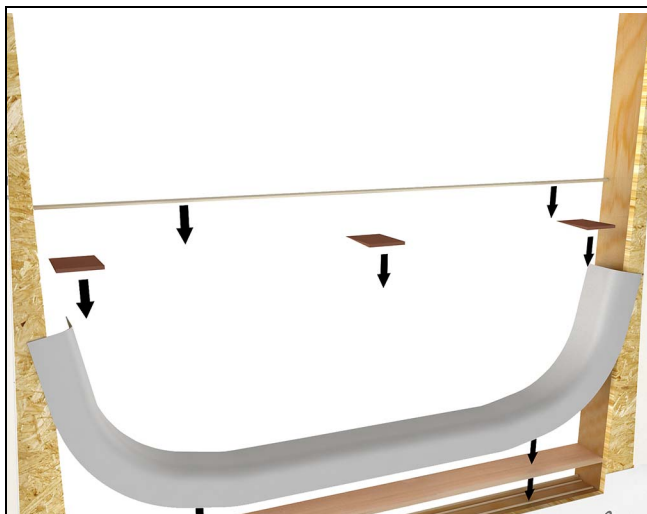

Figure 5

**NOTE:** Step-by-step instructions for Rough Opening Preparation can be found on-line at [www.marvin.com/ROprep](http://www.marvin.com/ROprep).

2. Starting in 3/4" from the side, apply 1/4" to 3/8" bead of sealant 1/2"- 3/4" across the top of the RO stopping 3/4" in from the end. Apply sealant down both sides of the window opening in the same manner. Do not apply sealant across the RO bottom. See [Figure 6](#).



Figure 6

3. Place a bead of sealant 1/4"- 3/8" from interior edge of the RO sill. [Figure 7](#)

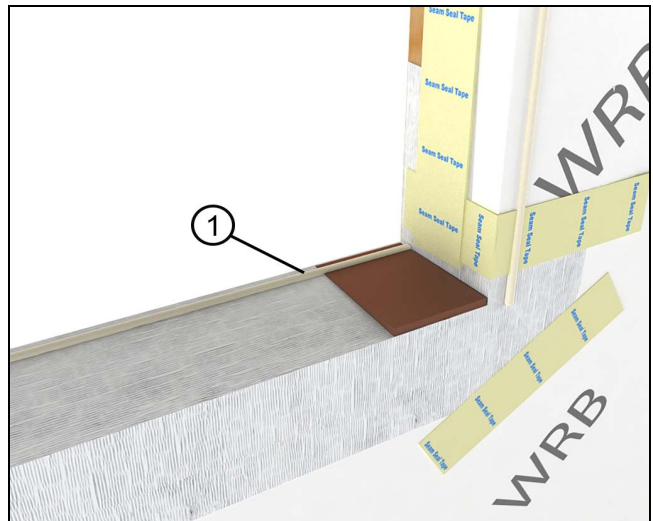

Figure 7

1	Sealant
---	---------

## Preparing the Unit for Installation

1. Remove the protective packaging from the unit and dispose/recycle properly. Inspect unit for any hidden damage and report immediately to your Marvin representative. Provide the customer service number etched on one of the top corners of the glass. See [Figure 8](#).



Figure 8

2. On casement and awning units, you may want to apply a filler board to the frame. This will allow for easier shimming during installation. See [Figure 9](#).

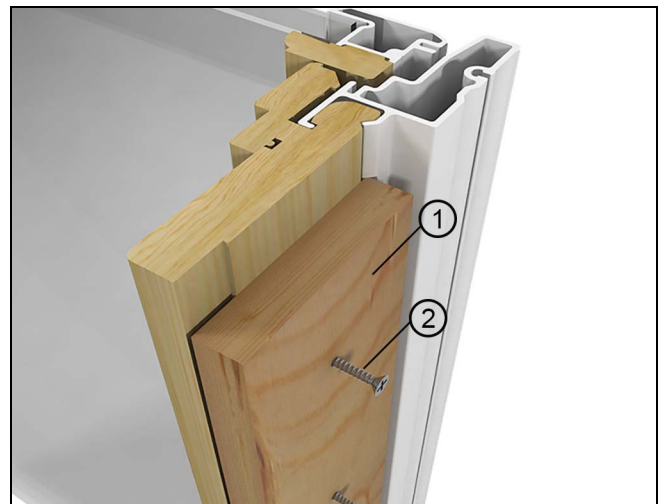

Figure 9

1	Filler board
2	Screw <= 1 1/4" (32)

3. Position the factory applied nailing fin/drip cap in the upright position. **DO NOT APPLY NAILING FIN CORNER GASKETS AT THIS TIME.**

4. If you are installing a unit that includes structural brackets, clips and/or additional fasteners, fasten them to unit now following supplemental instructions included. Additional fasteners are required for certain size ELCAP units. Brackets and instructions are sent with those units. **Certified mull installations with structural brackets are also covered in these instructions.**

5. On all units factory or field mullled, mullion joints must be sealed prior to installation. Apply silicone sealant at mullions from the frame exterior edge to the drip cap/ nailing fin kerf and across the kerf over the recessed mulling pin as shown in [Figure 10](#).



Figure 10

6. When installing factory mullled units in a two wide two high configuration, apply structural brackets on both sides of all mullion joints. See [Figure 11](#). Follow installation instructions supplied with brackets for specific placement.

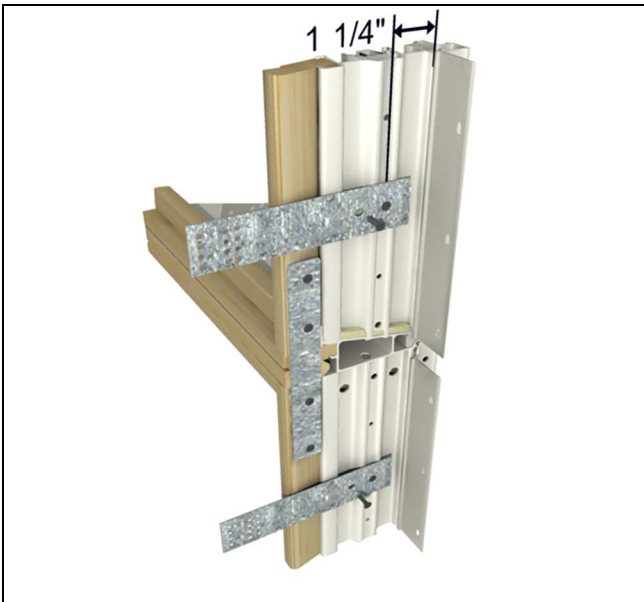

Figure 11

7. For certified mull with nail fin installation, see the **Certified Mull Anchoring** instructions that are included in the certified mull installation kit for further anchoring instructions.

8. Install jamb extension before installing the window in the rough or masonry opening. Follow instructions provided with the jamb extension.

## IMPORTANT

Unlocked windows can open during installation causing damage to the window unit or personal injury. Keeping the unit locked will assist in keeping the unit square until fastened into the opening.

## Installing the Window



### Seek Assistance

Some large windows and/or assemblies are very heavy. Avoid injury by getting help to lift and position the window into the rough opening.

9. Center the window in the opening. Level at the sill and plumb the frame (interior/exterior). Shim under the jambs to bring to level if necessary. See [Figure 12](#).



Figure 12

10. Once level, tack the jamb nailing fin with 2" (51) roofing nails within 4" (102) from the head jamb (or fasten top brackets if applicable, follow instructions sent with brackets). If fastening through the exterior casing, use 16d casing nails. See [Figure 13](#).



Figure 13

### ⚠ CAUTION

Proper shimming is extremely important. Under-shimming or over-shimming will result in bowed jambs and or head jamb. Both conditions can contribute to improper window operation



11. From the interior, shim about 4" (102) from the bottom to square the unit in the opening. Take diagonal measurements of the window. When equal, the window is square in the opening. Adjust the shims until the unit is square in the opening. [Figure 14](#).



Figure 14

12. Once square fasten the lower corners of the nailing fin and recheck for square. See [Figure 15](#).



Figure 15

## ATTENTION

For units installed with masonry clips or installation brackets. Bend bracket around framing member and attach with the #8 x 1 5/8" screws. Angle screws approximately 15° away from the window. Always shim above or below brackets. See [Figure 16](#).

*NOTE: Depending on construction method or wall type, you may need to modify the clip/bracket to fit the opening. Fastening holes should be no more than 1/4" from the bend in the bracket. If necessary, drill two 5/32" (3) holes in the bracket.*

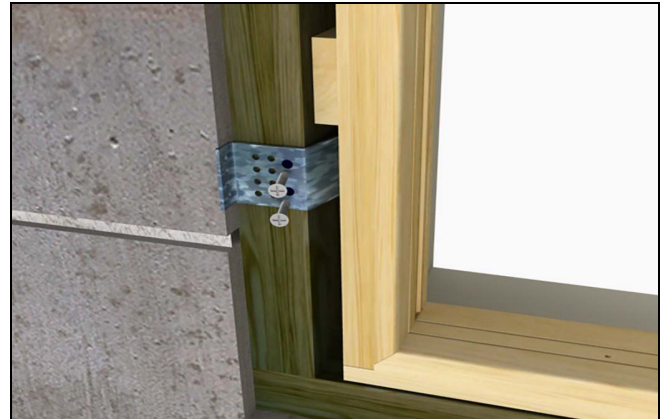

Figure 16

13. Recheck the diagonals one more time to make sure the unit is square in the opening. If square install additional shims at 15" intervals on center and at each lock point. Always shim at check rails and meeting stiles. See [Figure 17](#).



Figure 17

14. On round tops and other non-rectangular shapes, make sure to shim at bracing locations. See [Figure 18](#).



Figure 18

15. Measure at head jamb, center of unit, and sill to make sure all dimensions are equal. If they are not, you will have to adjust the shims accordingly. See [Figure 19](#).



Figure 19

16. Once the unit is square and plumb in the opening, operate the sash (on operable units) to make sure it is operating properly. If not, you may have to make some adjustments to the shims.



### Tip

On operating units, one way to make sure that the unit is installed square is to check the reveal (gap) between the operating sash and the frame. An even reveal around the entire sash generally means a squarely installed unit and will ensure smooth operation.

17. Complete fastening of the nailing fin around the perimeter of the unit with 2" (51) roofing nails 4" (102) from each corner and spaced every 6"- 8" (152-203) on center (or fasten remaining structural brackets).

## ! CAUTION

If building codes require foam type insulation to form an infiltration seal, use only low expansion type foam in combination with fiberglass insulation. Foam and foam application must conform to ASTM E2112. Follow all instructions and warnings from the foam manufacturer.

18. Apply nail fin corner gasket to each corner. Follow instructions on the back of the gasket.

For Picture units: See Elevate Double Hung Picture Supplemental Installation Instructions - Jamb Screws(19970063). Make sure there is a shim directly above or below the installation holes.

## Flashing the Installation - Air Barrier Applications

1. Flash the installation in a weather board fashion. For step by step instructions refer to [marvin.com/ROprep](http://marvin.com/ROprep) for instructions titled "Window Rough Opening Prep and Flashing Method A1-Membrane Drainage System".

Figure 20 shows the finished result.



Figure 20

## Insulating and Sealing the Installation

1. We recommend two possible ways of insulating the RO cavity. Both follow the principle that stopping air intrusion will aid in managing water intrusion into the RO. The first method uses a combination of one bead of low expansion/low compression/closed cell foam at the exterior plane of the RO in conjunction with loose fill fiberglass insulation. The second method uses two beads of low expansion foam (one at the exterior plane of the RO and another at the interior plane of the RO). See [Figure 21](#).



Figure 21 Apply low expansion foam between frame and rough opening.

## Final Installation Procedures

1. For ALL applications: Once the exterior finish such as siding or brick veneer is installed, apply bead of sealant between the finish and the frame exterior or casing along the sides. Apply additional beads approximately 1"- 2" (25-51) at the ends on top of the drip cap. Use a backer rod when necessary. See [Figure 22](#) and [Figure 23](#).

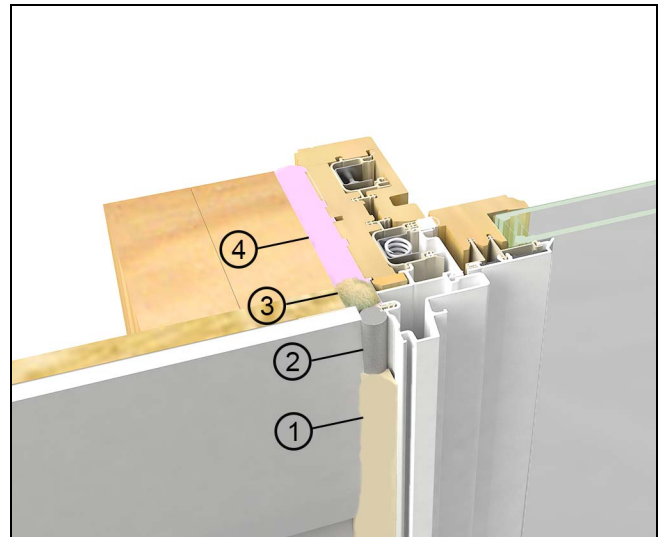

Figure 22

1	Sealant
2	Backer rod
3	Low expansion foam
4	Insulation



**Figure 23** Apply sealant between window and exterior finish.

**Loose Fill Fiberglass Insulation.** Insulate the RO cavity with loose fill fiberglass insulation. Install a backer rod and sealant at the interior plane of the RO to create a continuous air seal. See [Figure 24](#).

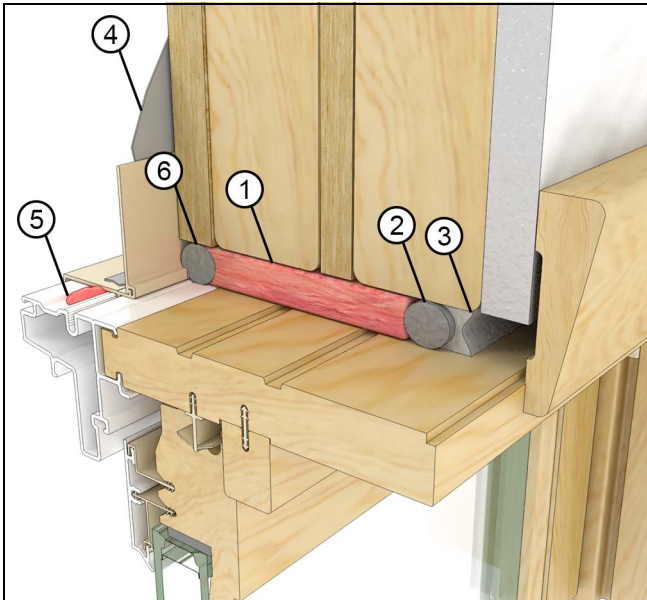

**Figure 24**

1	Loose fill fiberglass insulation
2	Backer rod
3	Continuous air seal (sealant)
4	Flashing
5	Sealant underneath drip
6	Backer rod

## ⚠ CAUTION

Perimeter sealant must be Grade NS Class 25 per ASTM C920 and compatible with the window product and the finished exterior(s) of the building. Using improper sealant could result in sealant failure causing air and water infiltration.

2. Install mullion trim after interior trim or casing is applied.

---

## Final Installation Procedures

1. Interior and mullion trim: Install mullion trim after interior trim or casing is applied.

On Double Hung raise the bottom sash and tilt in. Remove the red tabbed vinyl shipping blocks from each side. See [Figure 25](#).

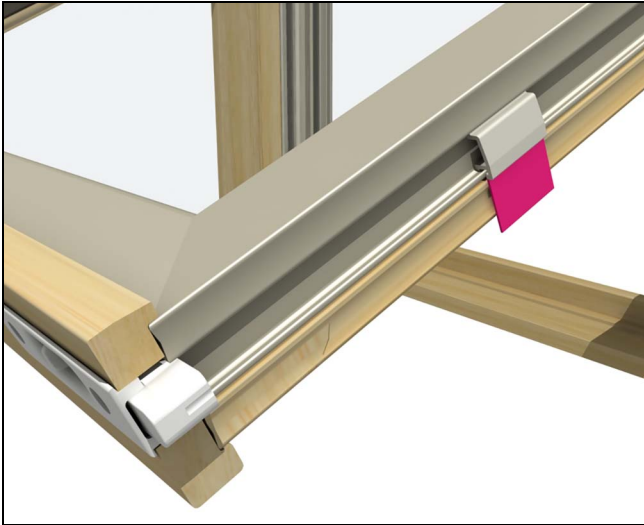

Figure 25

Sash must be raised at least 1" (25) before tilting. Tilt latches will not work unless sash is raised.

On Casement units, open the sash and remove the shipping blocks (2 or 4) located on the exterior lock-side. See [Figure 26](#).

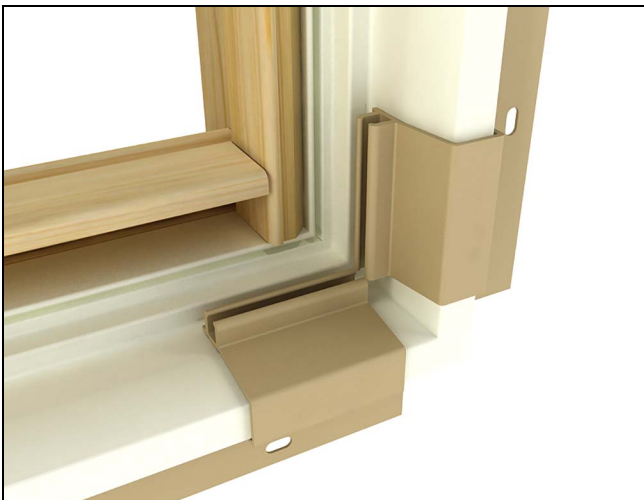

Figure 26

ELCA units less than 39" (991) in height will have 2 shipping blocks in sill/lock-side jamb corner. Units of 39" (991) heights and greater will have 2 additional shipping blocks in the head/lock-side jamb corner (total of 4 shipping blocks).

# Technical Installation Specifications

The following details are specified for proper installation and for the unit to meet the advertised design pressure (DP) rating.

- Rough Opening Width: 1/4" - 1" (6-25) wider than window/door frame outside measurement.
- Rough Opening Height: 1/4" - 1/2" (6-13) higher than window/door frame outside measurement.
- Masonry Opening Width: 1/4 - 1/2" (6-13) wider than window/door frame outside measurement.
- Masonry Opening Height: 1/8" - 1/4" (3-6) higher than window/door frame outside measurement.

## ATTENTION

**Architectural Detail Manual Specifications:**

Rough Opening: Width 1" (25); Height 1/2" (13).

Masonry Opening: Width 1/2" (13); Height 1/4" (6).

- The panning must drain water to the exterior of the cladding OR the exterior surface of a concealed weather resistive barrier.

## ⚠ CAUTION

Be aware that the use of sill pans and other barriers will decrease the rough opening height clearance. Adjust opening dimensions accordingly.

- The panning system used in these instructions is one component in a structure's overall water management system. It should be used in conjunction with an appropriate drainage plane compatible with the exterior cladding.
- Flashing materials must comply with ASTM E2112-01, section 5.13 and be compatible with all materials used in installation including panning systems, air barriers and building papers, sheathing, and the window unit.
- Properly flash and/or seal all windows at the exterior, perimeter.
- Sealants used for installation must be Grade NS Class 25 per ASTM C920 and compatible with the building exterior, window exterior surface, and flashing/water management materials.
- Optional foams used for installation must be low expansion only. Foam and foam application must comply with ASTM E2112-01, SEC 5.9.2

- For units with flat casing install with installation brackets, structural masonry brackets, or jamb screws.
- Shims 4" - 6" (102-152) from each corner on jambs and head jambs. Install additional shims at 15" (381) on center and at all locking points. always shim at the check rails and meeting stiles.
- Do not use chemically treated products for shim material.
- fasteners penetrating chemically treated lumber must be a minimum of 0.90 oz/ft<sup>2</sup> zinc hot dipped galvanized or stainless steel type 304 or 316.
- The window frame must not come into direct contact with chemically treated wood products.

## IMPORTANT

Flashing material must not contain asphalt and must be compatible with flexible PVC (vinyl) such as that found in Marvin vinyl nailing fin.