

Emissions Service Action - USA Only

Code: 21H2

Subject	Emissions System Component(s) (Parts Catalog Error)				
Release Date	November 20, 2019				
Affected Vehicles	Country	Beginning Model Year	Ending Model Year	Vehicle	Vehicle Count
	USA	2010	2013	GOLF	10
	USA	2012	2012	TOUAREG	7
	<p><i>Check Campaigns/Actions screen in Elsa on the day of repair to verify that a VIN qualifies for repair under this action. Elsa is the <u>only</u> valid campaign inquiry & verification source.</i></p> <ul style="list-style-type: none"> ✓ Campaign status must show "open." ✓ If Elsa shows other open action(s), inform your customer so that the work can also be completed at the same time the vehicle is in the workshop for this campaign. 				
Problem Description	Due to a parts catalog error, incorrect emissions related component(s) may have been installed on some vehicles during a past service repair visit. Dealers will inspect and, if needed, replace the component(s) as a proactive measure to ensure continued emissions compliance.				
Corrective Action	Inspect and, if needed, replace the component(s) as a proactive measure to ensure continued emissions compliance.				
IMPORTANT! AEM <u>Not</u> Required To Receive This Repair	This action is fully independent of the approved diesel modification recall on affected vehicles. For customer convenience, this action can be performed at the same time as other service work, but can also be done independent of the diesel modification (AEM). Customers do not need to receive the diesel modification (AEM) in order to receive this repair.				
Parts Information	Parts Control Type: Free Order		Parts will be managed by Free Order		
	Initial Allocation: (NO)		Please reference the Repair Projection Tool (below) to view your potential VIN population.		
	<p>Repair Projection Tool (right click to open): </p> <p>Dealers are urged to order parts only to support scheduled customer repairs.</p> <p>Dealers must ensure these customer repairs are scheduled so that the correct parts are on hand at the dealership when the customer presents their vehicle for this service.</p>				
Code Visibility	On or about November 20 2019, the campaign code will be applied to affected vehicles.				
Owner Notification	Owner notification will take place in November 2019. Owner letter examples are included in this bulletin for your reference.				
Emissions Campaigns Requirements (CALIFORNIA ONLY)	The California Air Resources Board and the Department of Motor Vehicles (DMV) require emissions-related campaigns to be completed prior to vehicle registration renewal. When campaign work is done you must provide the owner with a signed "Vehicle Emission Recall – Proof of Correction" certificate (RC EMISCAVWAU). Order certificates online via the Compliance Label Ordering portal at www.vwclub.com .				

The repair information in this document is intended for use only by skilled technicians who have the proper tools, equipment and training to correctly and safely maintain your vehicle. These procedures are not intended to be attempted by "do-it-yourselfers," and you should not assume this document applies to your vehicle, or that your vehicle has the condition described. To determine whether this information applies, contact an authorized Volkswagen dealer. ©2019 Volkswagen Group of America, Inc. All Rights Reserved.

**Additional
Information**

Please alert everyone in your dealership about this action, including Sales, Service, Parts and Accounting personnel. Contact Warranty if you have any questions.

Dealers must ensure that every affected inventory vehicle has this campaign completed before delivery to consumers.

Fill out and affix Campaign Completion Label (CAMP 010 000) after work is complete.
Labels can be ordered at no cost via the Compliance Label Ordering portal at www.vwhub.com.

Claim Entry Instructions

After campaign has been completed, enter claim as soon as possible to help prevent work from being duplicated elsewhere. Attach the Elsa screen print showing action open on the day of repair to the repair order.

If customer refused campaign work:

- ✓ U.S. dealers: Submit request via WISE under the *Campaigns/Update/Recall Closure* option.
- ✓ Canada dealers: Upload the repair order [signed by customer] to Volkswagen WIN/Operations/Campaign Closure.

Service Number	21H2																								
Damage Code	0099																								
Parts Vendor Code	WWO																								
Claim Type	Sold vehicle: 7 10 Unsold vehicle: 7 90																								
Causal Indicator	Select labor* as causal for inspection only -OR- Mark EGR filter*, or Injector for reduction agent *, or Catalyst* as causal part																								
Vehicle Wash/Loaner	Do not claim wash/loaner under this action U.S.A.: Loaner/rental coverage cannot be claimed under this action. However, loaner/rental may be covered under the mobility program. Please refer to the Volkswagen Warranty Policy and Procedures Manual for loaner claims information and reimbursement details.																								
Criteria I.D.	01																								
	<p>Inspect EGR Filter, correct part present, no further work required Labor operation: 2643 01 99* 30 T.U.</p> <table border="1"> <thead> <tr> <th>Quantity</th> <th>Part Number</th> <th>Description</th> </tr> </thead> <tbody> <tr> <td>3.00</td> <td>WHT000729A</td> <td>Hex Socket Head Bolt</td> </tr> </tbody> </table> <p>-OR-</p> <p>Inspect EGR Filter, incorrect part present, replace EGR Filter Labor operation: 2643 19 99 70 T.U.</p> <table border="1"> <thead> <tr> <th>Quantity</th> <th>Part Number</th> <th>Description</th> </tr> </thead> <tbody> <tr> <td>1.00</td> <td>1K0253120B</td> <td>Pipe (EGR Filter)*</td> </tr> <tr> <td>1.00</td> <td>03G131547H</td> <td>Gasket</td> </tr> <tr> <td>1.00</td> <td>1K0253115AG</td> <td>Gasket</td> </tr> <tr> <td>1.00</td> <td>1K0253725F</td> <td>Clamp</td> </tr> <tr> <td>3.00</td> <td>WHT000729A</td> <td>Hex Socket Head Bolt</td> </tr> </tbody> </table>	Quantity	Part Number	Description	3.00	WHT000729A	Hex Socket Head Bolt	Quantity	Part Number	Description	1.00	1K0253120B	Pipe (EGR Filter)*	1.00	03G131547H	Gasket	1.00	1K0253115AG	Gasket	1.00	1K0253725F	Clamp	3.00	WHT000729A	Hex Socket Head Bolt
Quantity	Part Number	Description																							
3.00	WHT000729A	Hex Socket Head Bolt																							
Quantity	Part Number	Description																							
1.00	1K0253120B	Pipe (EGR Filter)*																							
1.00	03G131547H	Gasket																							
1.00	1K0253115AG	Gasket																							
1.00	1K0253725F	Clamp																							
3.00	WHT000729A	Hex Socket Head Bolt																							

Continue to next page

Criteria I.D.	02																											
	<p>Inspect Reducing Agent Injector, correct part present, no further work required Labor operation: 2685 01 99* 30 T.U.</p> <table border="1"> <thead> <tr> <th>Quantity</th> <th>Part Number</th> <th>Description</th> </tr> </thead> <tbody> <tr> <td>1.00</td> <td>3C0253725</td> <td>Retaining clip</td> </tr> <tr> <td>1.00</td> <td>3C0253115A</td> <td>Gasket</td> </tr> </tbody> </table> <p>-OR-</p> <p>Inspect Reducing Agent Injector, incorrect part present, replace Reducing Agent Injector Labor operation: 2685 19 99 40 T.U.</p> <table border="1"> <thead> <tr> <th>Quantity</th> <th>Part Number</th> <th>Description</th> </tr> </thead> <tbody> <tr> <td>1.00</td> <td>4H0131113A</td> <td>Injector for reduction agent*</td> </tr> <tr> <td>1.00</td> <td>3C0253725</td> <td>Retaining clip</td> </tr> </tbody> </table>	Quantity	Part Number	Description	1.00	3C0253725	Retaining clip	1.00	3C0253115A	Gasket	Quantity	Part Number	Description	1.00	4H0131113A	Injector for reduction agent*	1.00	3C0253725	Retaining clip									
Quantity	Part Number	Description																										
1.00	3C0253725	Retaining clip																										
1.00	3C0253115A	Gasket																										
Quantity	Part Number	Description																										
1.00	4H0131113A	Injector for reduction agent*																										
1.00	3C0253725	Retaining clip																										
Criteria I.D.	03																											
	<p>Inspect SCR Catalyst, correct part present, no further work required Labor operation: 0183 00 99 30 T.U.</p> <p>-OR-</p> <p>Inspect SCR Catalyst, incorrect part present, replace SCR Catalyst Labor operation: 2673 19 99 80 T.U.</p> <table border="1"> <thead> <tr> <th>Quantity</th> <th>Part Number</th> <th>Description</th> </tr> </thead> <tbody> <tr> <td>1.00</td> <td>4L0254400AX</td> <td>Catalyst*</td> </tr> <tr> <td>1.00</td> <td>7L5253115C</td> <td>Gasket</td> </tr> <tr> <td>1.00</td> <td>3C0253115A</td> <td>Gasket</td> </tr> <tr> <td>1.00</td> <td>3C0253725</td> <td>Retaining clip</td> </tr> <tr> <td>1.00</td> <td>1K0253141AF</td> <td>Dual clamp</td> </tr> <tr> <td>Up to 3.00</td> <td>N 01024713</td> <td>Screw (if necessary)</td> </tr> <tr> <td>3.00</td> <td>N 91130802</td> <td>Shouldered Hex Nut Self-Locking</td> </tr> <tr> <td>1.00</td> <td>WHT003487A</td> <td>Threaded plug</td> </tr> </tbody> </table>	Quantity	Part Number	Description	1.00	4L0254400AX	Catalyst*	1.00	7L5253115C	Gasket	1.00	3C0253115A	Gasket	1.00	3C0253725	Retaining clip	1.00	1K0253141AF	Dual clamp	Up to 3.00	N 01024713	Screw (if necessary)	3.00	N 91130802	Shouldered Hex Nut Self-Locking	1.00	WHT003487A	Threaded plug
Quantity	Part Number	Description																										
1.00	4L0254400AX	Catalyst*																										
1.00	7L5253115C	Gasket																										
1.00	3C0253115A	Gasket																										
1.00	3C0253725	Retaining clip																										
1.00	1K0253141AF	Dual clamp																										
Up to 3.00	N 01024713	Screw (if necessary)																										
3.00	N 91130802	Shouldered Hex Nut Self-Locking																										
1.00	WHT003487A	Threaded plug																										

Customer Letter Example (United States)

<MONTH YEAR>

<CUSTOMER NAME>

<CUSTOMER ADDRESS>

<CUSTOMER CITY STATE ZIPCODE>

This notice applies to your vehicle: <VIN>

Subject: Emissions Service Action 21H2 – Emissions System Component(s) – Parts Catalog Error

Dear Volkswagen Owner,

In cooperation with the United States Environmental Protection Agency and the California Air Resources Board, we are informing you of our decision to conduct an emissions service action on certain 2010-2013 model year Volkswagen vehicles. Our records show that you are the owner of a vehicle affected by this action.

Please note: This service action is fully independent of the approved diesel modification recall on your vehicle. For your convenience, this action can be performed at the same time as other service work, but can also be done independent of the diesel modification. You do not need to receive the diesel modification in order to receive this repair.

What is the issue?	Due to a parts catalog error, certain incorrect emissions system component(s) may have been installed during a past service repair visit. Dealers will inspect, and if necessary, replace these component(s) as a proactive measure to ensure continued emissions compliance.
What will we do?	Your authorized Volkswagen dealer will install the correct emissions system components. This work will take up to two hours to complete and will be performed for you free of charge. Please keep in mind that your dealer may need additional time for the preparation of the repair, as well as to accommodate their daily workshop schedule.
What should you do?	Please contact your authorized Volkswagen dealer as soon as possible to schedule this service. To set up an appointment online, please visit www.vw.com/find-a-dealer .
Lease vehicles and address changes	If you are the lessor and registered owner of the vehicle identified in this action, please forward this letter immediately via first-class mail to the lessee within ten (10) days of receipt. If you have changed your address or sold the vehicle, please fill out the enclosed prepaid Owner Reply card and mail it to us so we can update our records.
Important information for California Vehicle Owners – California Regulations	California regulations require that this campaign be completed prior to the time you renew your vehicle registration. Therefore, please make sure that this campaign is completed prior to the renewal of your vehicle registration , and that you furnish proof of completion to the Department of Motor Vehicles (DMV) in the form of a copy of the dealer's repair order, including a signed "Proof of Correction" certificate. You obtain this from your dealer after the campaign has been completed. Please retain the signed "Proof of Correction Certificate" with your vehicle records. DO NOT MAIL THIS FORM to the DMV, unless requested.
Can we assist you further?	If your authorized Volkswagen dealer fails or is unable to complete this work free of charge within a reasonable time, or if you should have any questions about this communication, please reach out to us using your preferred method of communication at www.vw.com/contact or by calling us at 800-893-5298.
Checking your vehicle for open Recalls and Service Campaigns	To check your vehicle's eligibility for repair under this or any other recall/service campaign, please visit www.vw.com/owners/recalls and enter your Vehicle Identification Number (VIN) into the Recall/Service Campaign Lookup tool.

We apologize for any inconvenience this matter may cause; however we are taking this action to help ensure your vehicle continues to meet and exceed your expectations.

Sincerely,

Volkswagen Customer Protection

NOTE

- These repair instructions may differ from the labor operations and labor times listed in ELSA.
- Damages resulting from improper repair or failure to follow these work instructions are the dealer's responsibility and are not eligible for reimbursement under this action.
- This procedure must be read in its entirety prior to performing the repair.
- Due to variations in vehicle equipment and options, the steps/illustrations in this work procedure may not identically match all affected vehicles.
- Diagnosis and repair of pre-existing conditions in the vehicle are not covered under this action.
- When working during extreme temperatures, it is recommended that the vehicle be allowed to acclimate inside the shop to avoid temperature-related component damage/breakage.

Repair Overview



- Criteria 01:
 - Golf models
 - Inspect and if necessary, replace EGR filter.
- Criteria 02:
 - Touareg models.
 - Inspect and if necessary, replace reducing agent injector.
- Criteria 03:
 - Touareg models.
 - Inspect and if necessary, replace SCR catalyst.

- Section A - Check for Previous Repair
- Section B - EGR Filter Work Procedure (Criteria 01)
- Section C - Reducing Agent Injector Work Procedure (Criteria 02)
- Section D - SCR Catalyst Work Procedure (Criteria 03)
- Section E - Campaign Completion Label
- Section F - Parts Return
- Section G - California Only Requirements

Required Parts

<u>Criteria</u>	<u>Quantity</u>	<u>Part Number</u>	<u>Part Description</u>
01	1	1K0.253.120.B	EGR Filter
	1	03G.131.547.H	Gasket
	1	1K0.253.115.AG	Gasket
	1	1K0.253.725.F	Clamp
	3	WHT.000.729.A	Bolt
-OR-			
02	1	4H0.131.113.A	Reducing Agent Injector
	1	3C0.253.725	Retaining Clamp
-AND/OR-			
03	1	4L0.254.400.AX	SCR Catalyst
	1	7L5.253.115.C	Gasket
	1	3C0.253.115.A	Reducing Agent Injector Gasket
	1	3C0.253.725	Retaining Clamp
	1	1K0.253.141.AF	Dual Clamp
	3	N 010.247.13	Replacement Stud/Bolt (if necessary)
	3	N 911.308.02	Shouldered Hex Nut
	1	WHT.003.487.A	Threaded plug

NOTE

The specified part numbers reflect the status at the start of this action. Interim updates made in ETKA can cause a listed part number to become unavailable. In this case, the new part number specified in ETKA should be used.

Required Tools



	<p>Socket - 27mm -T40218- (or equivalent)</p>		<p>Special Tool # 582277 (or equivalent)</p>
---	---	--	--

Repair Instruction

Section A - Check for Previous Repair

TIP

If Campaign Completion label is present, no further work is required.

Applicable criteria ID(s)	Campaign/Action Status
01 	Open 

EXAMPLE

- Enter the VIN in Elsa and proceed to the “Campaign/Action” screen.

TIP

On the date of repair, print this screen and keep a copy with the repair order.

- Confirm the Campaign/Action is open <arrow 1>. If the status is closed, no further work is required.
- Note the Applicable Criteria ID <arrow 2> for use in determining the correct work to be done and corresponding parts associated.
- **All Safety Recalls MUST be completed before starting this Campaign.**

Vehicles with Criteria 01 - Proceed to Section B

Vehicles with Criteria 02 - Proceed to Section C

Vehicles with Criteria 03 - Proceed to Section D

Section B – EGR Filter Work Procedure (Criteria 01)

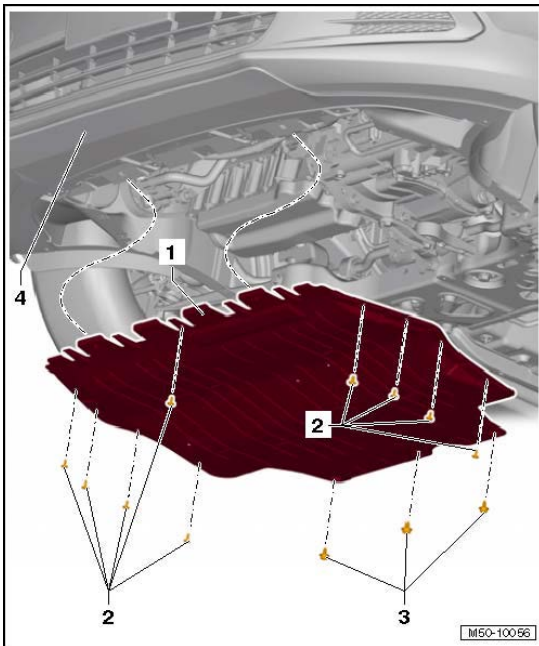

- Remove noise insulation.
- Inspect the EGR Filter part number.
 - If part number **1K0.253.120.B** is present, no further work is required.
 - Reinstall the noise insulation.
 - **Proceed to Section C.**
 - If any other part number is present or if the part number is unknown:
 - **Proceed to the next step and replace the EGR Filter.**

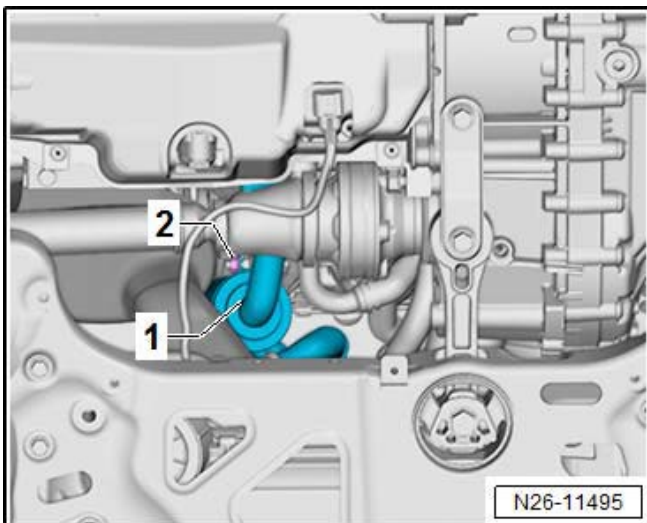

- Remove nut <2> from exhaust gas recirculation filter <1> from below using 13 mm ratchet box wrench.
- Wrap tape around the tip of a long screwdriver.

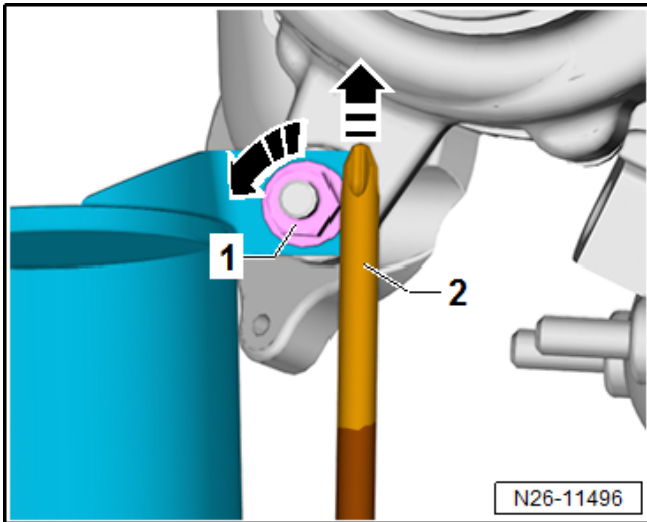

- Apply screwdriver <2> on side of nut <1> and unscrew nut while simultaneously pressing up on nut.

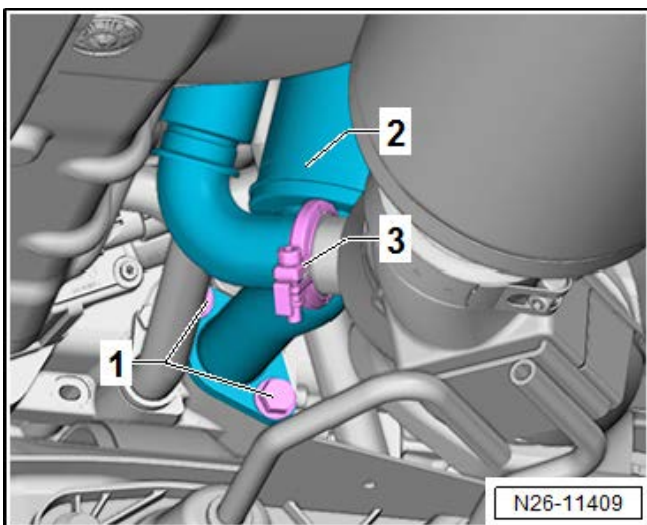

- Remove clamp <3>.
- Remove bolts <1> and remove EGR filter <2>.
- Install new EGR filter with new seals and clamp in the reverse order of removal.
- Torque bolts <1> to 9 Nm.
- Torque clamp <3> to 3.5 Nm.

Part Number	Description
1K0.253.120.B	EGR Filter
03G.131.547.H	Gasket
1K0.253.115.AG	Gasket
1K0.253.725.F	Clamp

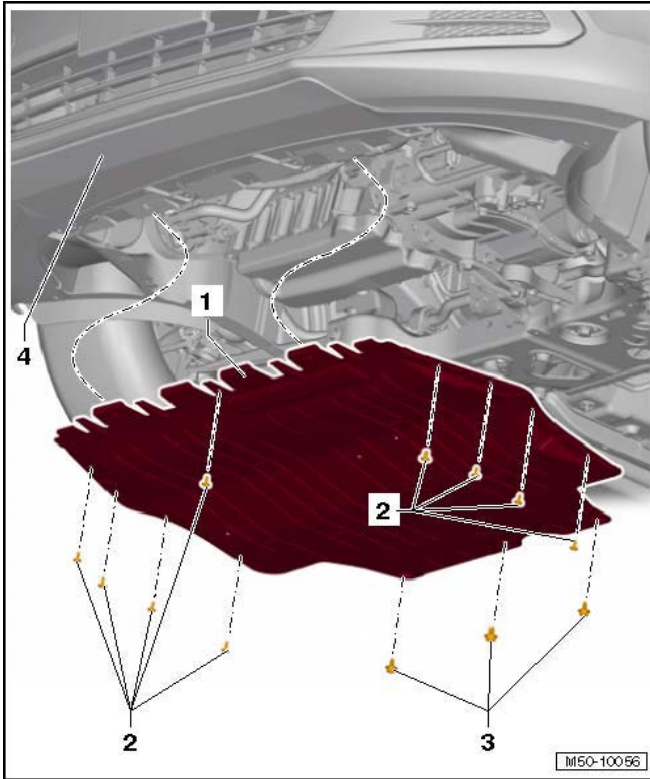

- Install noise insulation in the reverse order of removal.
- Replace bolts <3> and torque to 6 Nm.
- Torque bolts <2> to 2 Nm.

All Work Complete
Proceed to Section E

Section C – Reducing Agent Injector Work Procedure (Criteria 02)

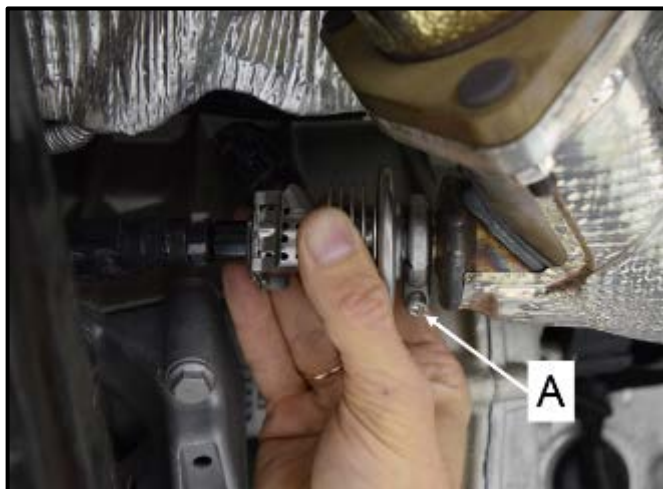

- Remove clamp <A>.
- Leave injector electrical connector plugged in and remove injector from the SCR catalyst.
- Inspect the injector part number:
 - If part number **4H0.131.113.A** is present, no further work is required.
 - **Vehicles with only Criteria 02 open, reinstall the injector with a new gasket and clamp and Proceed to Section E.**
 - **Vehicles with Criteria 03 open, Proceed to Section D.**
 - If any other part number is present or if the part number is unknown:
 - **Proceed to the next step and replace the injector.**

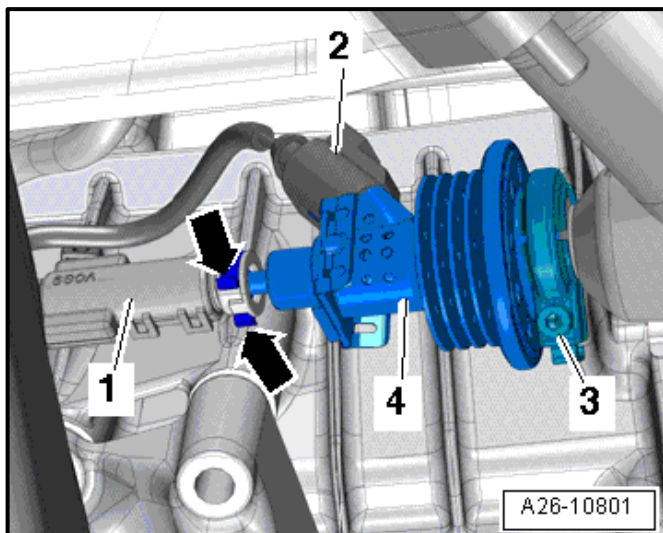

Replace Reducing Agent Injector:

! NOTE	
<ul style="list-style-type: none"> • Lay a cloth below to catch any escaping AdBlue reducing agent. • Make certain the electrical connector is installed into the new Reducing Agent Injector -N474- before disconnecting the AdBlue reducing agent feed hose. This will reduce the possibility of contaminating the electrical connection with AdBlue. 	

Part Number	Description
4H0.131.113.A	Reducing Agent Injector

- Disconnect the connector <2> from the existing Reducing Agent Injector -N474- <4>.
- Connect the connector <2> to the new Reducing Agent Injector -N474- <4> and set it aside.
- Make certain the electrical connector is installed into the new Reducing Agent Injector before disconnecting the AdBlue reducing agent feed hose. This will reduce the possibility of contaminating the electrical connection with AdBlue.
- Remove the AdBlue reducing agent feed hose <1> by pressing the release clasps <arrows> and remove the reducing agent hose <1>.

- Connect the AdBlue reducing agent hose <1> to the new Reducing Agent Injector -N474- <4>.



Install Reducing Agent Injector:

- Install Reducing Agent Injector -N474- into the SCR Catalyst pipe ensuring that the tabs in the Injector <arrows> fit into the corresponding mounts in the SCR catalytic converter.

i TIP

A new gasket comes pre-installed on a new injector.

- Install a new retaining clamp <A> and tighten the bolt to 5 Nm.

Part Number	Description
3C0.253.725	Retaining Clamp

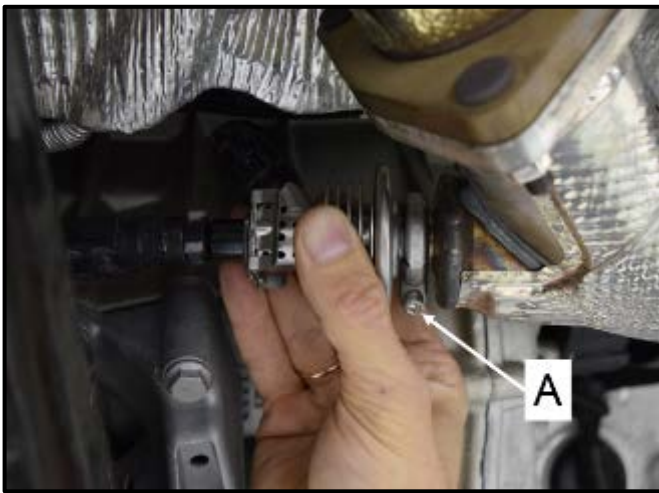

If Criteria 03 is open on the vehicle:

Proceed to Section D

If Criteria 03 is NOT open on the Vehicle:

All Work Complete, Proceed to Section E

Section D – SCR Catalyst Work Procedure (Criteria 03)

- Inspect the SCR catalyst part number:
 - If part number **4L0.254.400.AX** is present, no further work is required.
 - **Proceed to Section E.**
 - If any other part number is present or if the part number is unknown:
 - **Proceed to the next step and replace the SCR catalyst.**

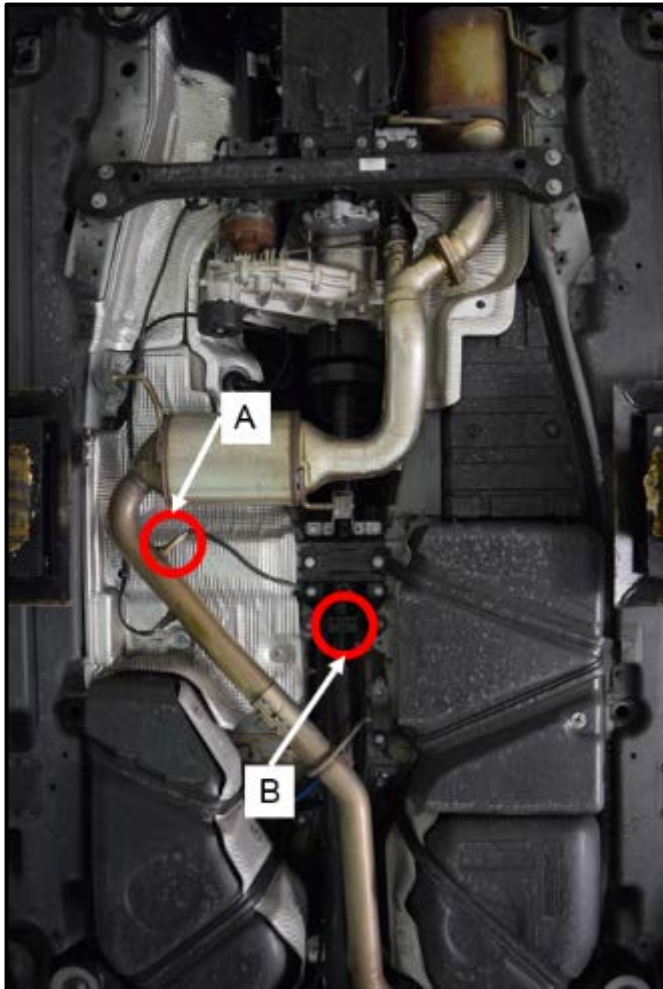

Figure <A>



Remove the NOx #2 sensor <1> from the catalyst pipe.

Figure



Cover the NOx #2 Sensor with a plastic bag (or equivalent) and secure it out of the way with a tie strap (or equivalent) attached through either one of two holes in the rear driveshaft mid-bearing bracket .

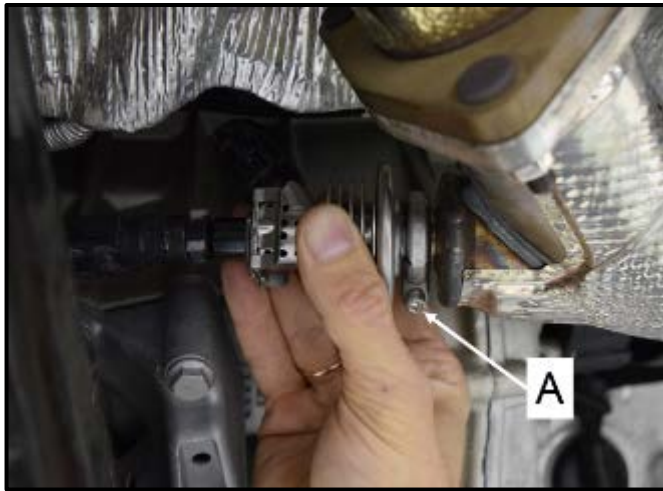

- Loosen the screw <A> and remove the clamp from the Reducing Agent Injector -N474-.
- Leave the electrical connector and the Reducing Agent Injector AdBlue feed line connected at this time. This will reduce the possibility of contaminating the electrical connection with AdBlue.
- Secure the Reducing Agent Injector out of the way with a tie strap (or equivalent).

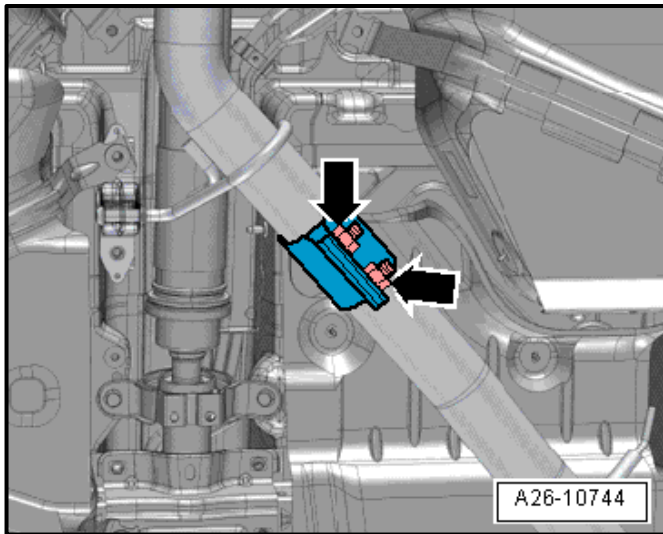

- Loosen the two nuts on the Dual Clamp <arrows> so the clamp can slide back and forth on the exhaust pipe.
- Leave the clamp in the installed position at this time. This will assist in holding the SCR Catalyst in place while removing the brackets in the next step.

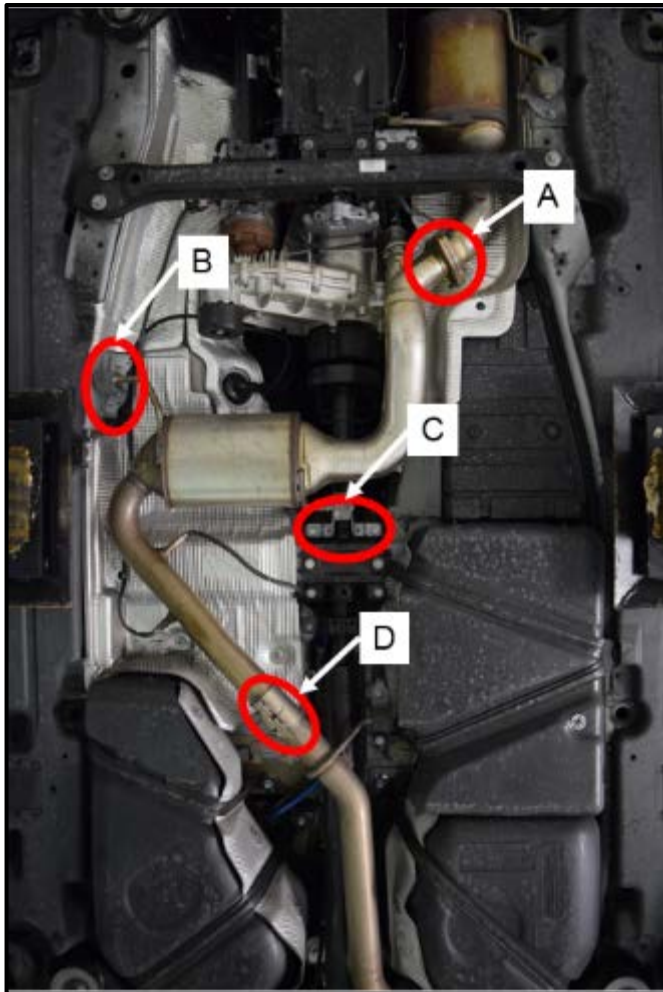

- With the assistance of a second technician, remove the three nuts <A> from the exhaust studs securing the SCR Catalyst to the Diesel Particulate Filter (DPF).
- Remove the bolts from SCR Catalyst brackets at locations <B and C> with assistance from second technician to support the SCR Catalyst while the brackets are removed.
- Slide the Dual Clamp <D> towards the rear of the vehicle, and with the assistance of a second technician, remove the SCR Catalyst from the vehicle.
- Remove the Dual Clamp <D> from the exhaust pipe and discard.

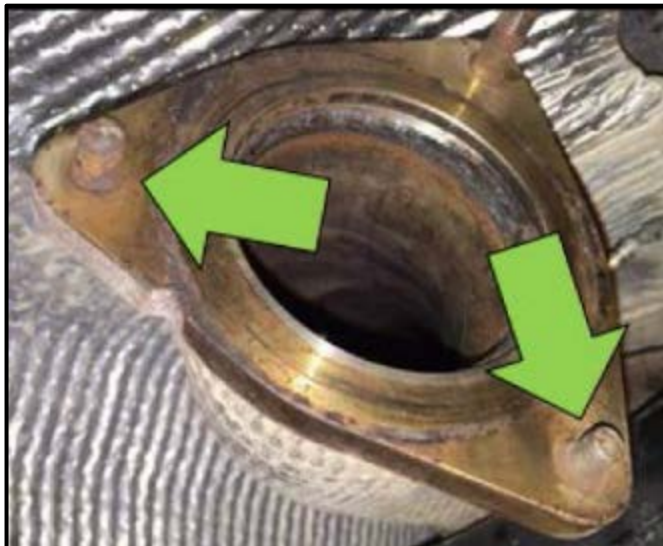

NOTE



Due to corrosion, one or more of the mounting studs may break <arrows> when removing the SCR catalytic converter from the Diesel Particulate Filter (DPF) flange.

DO NOT use a hammer and punch, heat, air hammer, or other method to remove the studs from the DPF. Consequential damage to Exhaust Gas Temperature Sensors, Diesel Particulate Filter, AdBlue Injector Feed

Line, or any other ancillary components **WILL NOT BE COVERED** under this action due to damage from heat, impact, or vibration.

Follow the steps below if one or more studs are broken or damaged.



Special Tool # 582277



OTC 5057

- If stud replacement is necessary use Special Tool # 582277, or a commercially available clevis pin press such as an OTC 5057 or equivalent to press any broken or damaged studs out of the DPF flange.
- It is advised if one stud breaks that all three studs are pressed out and replaced with the bolts/nuts included in the parts kit.
- Install the replacement bolts and corresponding nuts into the rear DPF flange.

Part Number	Description	Quantity
N 010.247.13	Replacement Exhaust Bolt	3
N 911.308.02	Shouldered Hex Nut	3

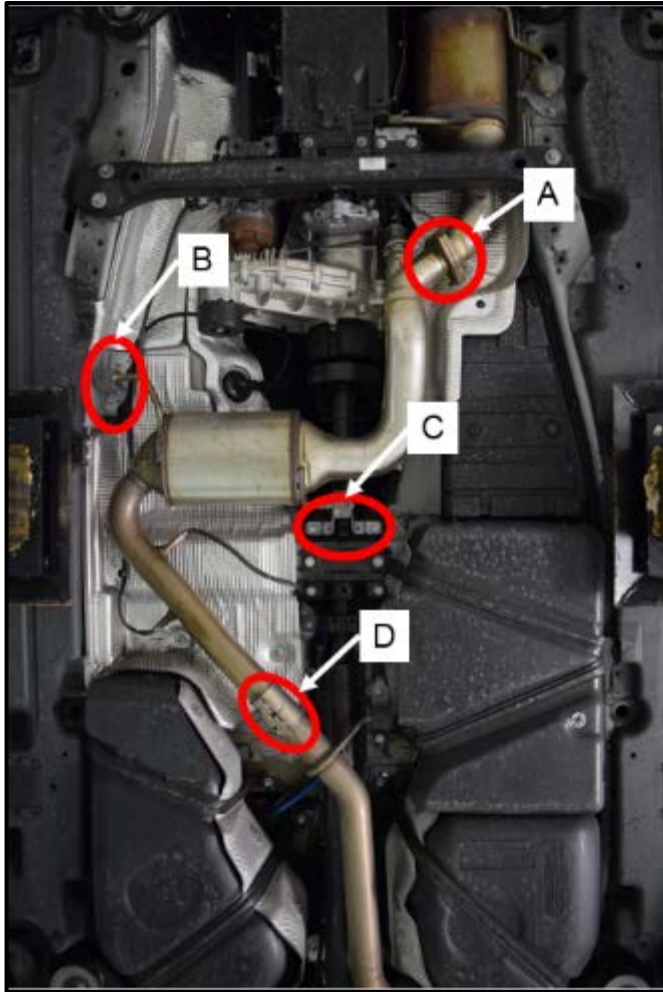

NOTE

Coat the threads on the nuts and exhaust studs/bolts <A> with hot bolt paste prior to installation. Refer to the Parts Catalog.

- Install the new exhaust Dual Clamp onto the exhaust pipe at location <D> and slide the clamp to the rear of the vehicle, but do not tighten.
- With the assistance of a second technician, install the new SCR Catalyst with a new gasket between the SCR Catalyst and DPF <A>. Fit the SCR Catalyst onto the DPF flange studs/bolts and install new nuts and tighten to 23 Nm.
- Slide the Dual Clamp into the installed position on the SCR Catalyst, but do not tighten. This will assist in holding the SCR Catalyst in place while the exhaust system is properly tensioned.
- Install the bolts for the SCR Catalyst brackets <B and C> and tighten by hand.

Part Number	Description	Quantity
4L0.254.400.AX	SCR Catalyst	1
1K0.253.141.AF	Dual Clamp	1
7L5.253.115.C	Gasket	1
N 911.308.02	Shouldered Hex Nut	3
N 010.247.13	Replacement Stud/Bolt (if necessary)	3

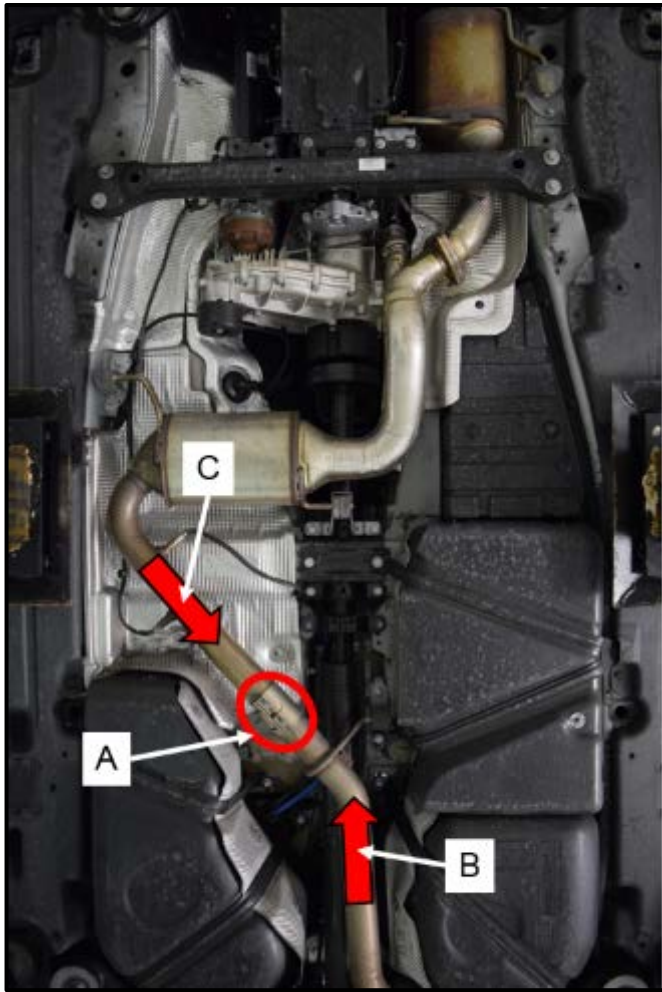

- Tighten the Dual Clamp <A> until there is a slight dragging resistance on both the SCR Catalyst pipe <arrow C> and the rear resonator/muffler pipe <arrow B>, but do not tighten so much that the pipes cannot slide in and out of the Dual Clamp <A>.
- Pretension the rear resonator/muffler hanging straps by pulling the rear resonator/muffler pipe towards the front of the vehicle <arrow B> and pulling the SCR Catalyst pipe towards the rear of the vehicle <arrow C>.

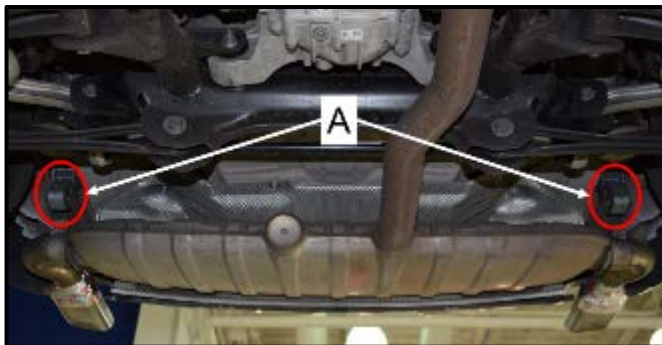

<A> = Rear Resonator Hanging Straps

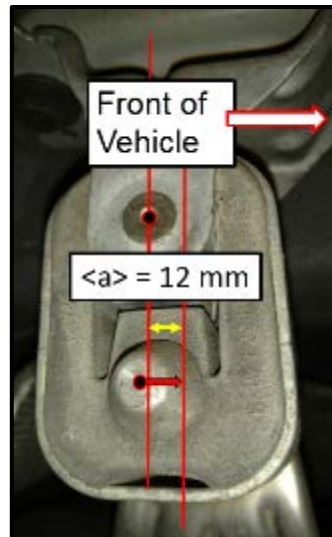

In order to reduce harmonic vibration, the rear muffler/resonator straps <A> require 12 mm of forward tension, as shown in the sub-photo. Pull forward on the rear muffler/resonator pipe and insert the pipe deeper into the Dual Clamp until this dimension is achieved.

- Once the desired dimension of <a> = 12 mm is achieved, tighten the Dual Clamp nuts to 23 Nm.

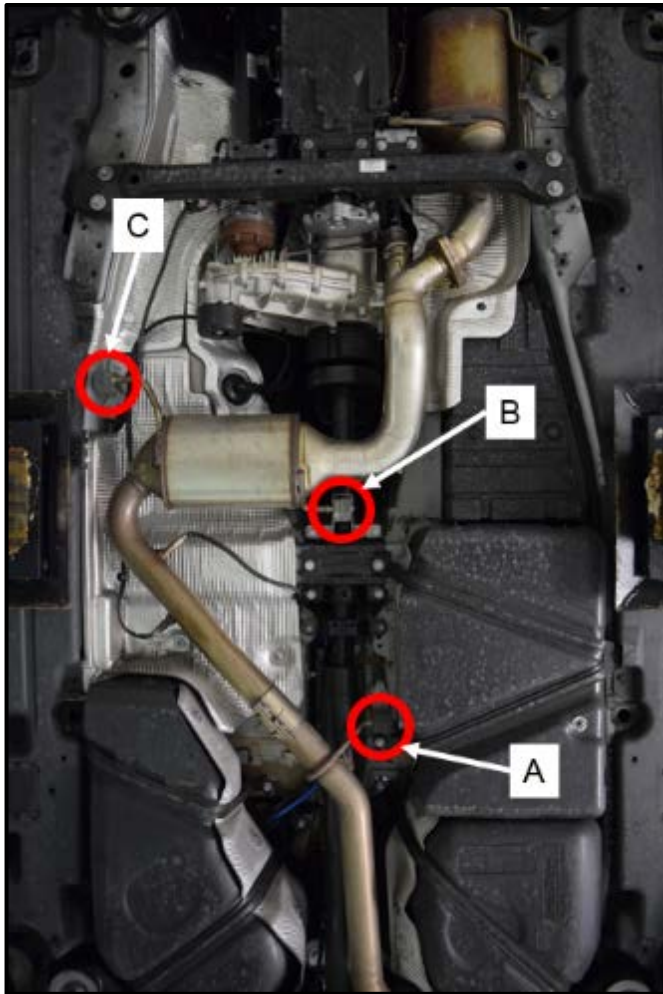
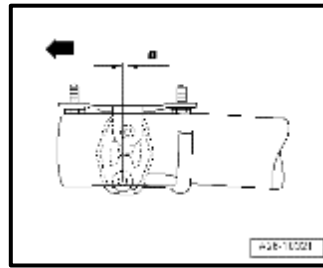

Figure <A>



Front Muffler/Resonator hanging strap: <a> = 4 mm

If equipped, loosen the bolts at the forward resonator pipe hanging strap <A> and adjust the bracket until <a> = 4 mm of forward tension.

- Tighten the two hanging strap bolts to 23 Nm.

Figures <B and C>



Left and Right SCR hanging straps: <a> = 0.00 mm, install without tension.

If necessary, loosen the bolts at the left and right SCR Cat hanging straps <B and C> and adjust the brackets until <a> = 0.00 mm. The SCR Catalyst hanging straps are installed tension free.

- Tighten the two hanging strap bracket bolts to 60 Nm.
- Tighten the two hanging strap bracket bolts <C> to 23 Nm.

- Install threaded plug in the bung for the particle sensor and torque to 50 Nm.



Part Number	Description
WHT.003.487.A	Threaded plug

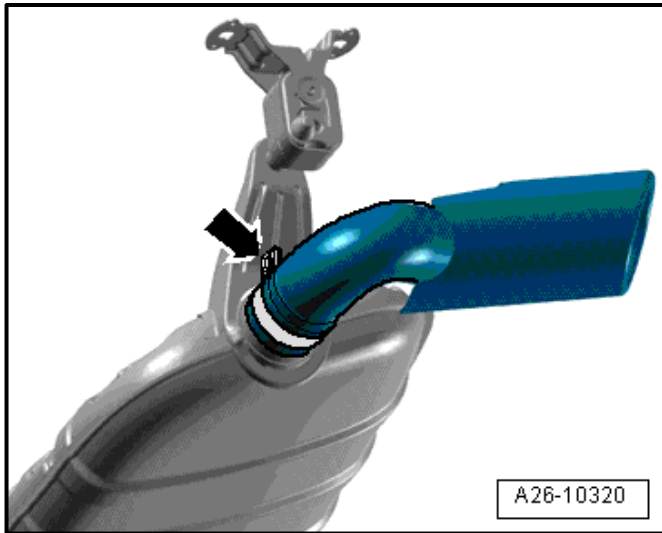

- If necessary, align the tailpipes by first loosening the screw-type clamp <arrow> on the tail pipes.

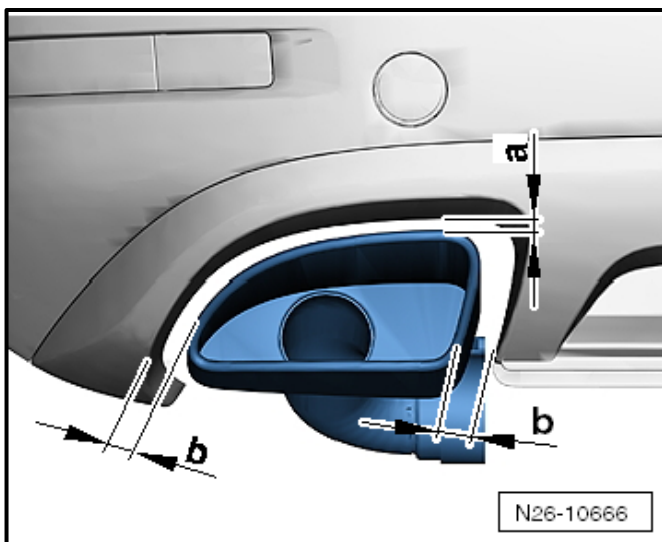

- Adjust the tailpipes to the specifications below.
 - Dimension -a- = 20 mm minimum.
 - Dimension -b- = align evenly.

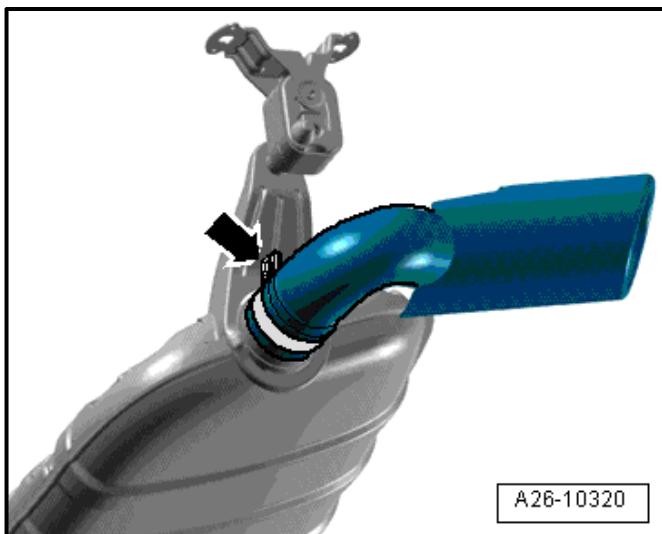

- Once the tail pipe is properly aligned to the bumper cover, tighten the screw-type clamps <arrow> to 60 Nm.



- If required, install new gasket into the Reducing Agent Injector -N474-.
- Install the Reducing Agent Injector -N474- into the SCR Catalyst pipe ensuring that the tabs in the Injector <arrows> fit into the corresponding mounts in the SCR catalytic converter.
- Install a new retaining clamp <A> and tighten the bolt to 5 Nm.

Part Number	Description	Quantity
3C0.253.725	Retaining Clamp	1
3C0.253.115.A	Reducing Agent Injector Gasket (only if required)	1



**All Work Complete.
Proceed to Section E.**

Section E – Campaign Completion Label

Install Campaign Completion Label

- Fill out and affix Campaign Completion Label, part number CAMP 010 000, next to the vehicle emission control information label.

TIP

Ensure Campaign Completion Label does not cover any existing label(s).

Proceed to Section F

Section F - Parts Return/Disposal



Parts Return/Disposal

SCR Catalyst:

- The SCR Catalyst must be tagged with a blue zip tie <as shown> and returned in order to be considered for core charge reimbursement.

All other parts:

- Properly store (retain), destroy or dispose of removed parts in accordance with all state and local requirements, unless otherwise indicated and/or requested through the Warranty Parts Portal (WPP).

Proceed to Section G (California only).

Section G – California Only Requirements

CALIFORNIA ONLY Requirements for Emissions Campaigns Having Customer Notification

The California Air Resources Board and the Department of Motor Vehicles (DMV) require emissions-related campaigns to be completed prior to vehicle registration renewal. **When campaign work is done you must provide the owner with a signed “Vehicle Emission Recall – Proof of Correction” certificate (RC EMIS_CAL VW).** Certificates can be ordered at no cost online via the Compliance Label Ordering portal at www.vwhub.com.