

# Energy Futures

MIT ENERGY INITIATIVE

MIT

SPRING 2012

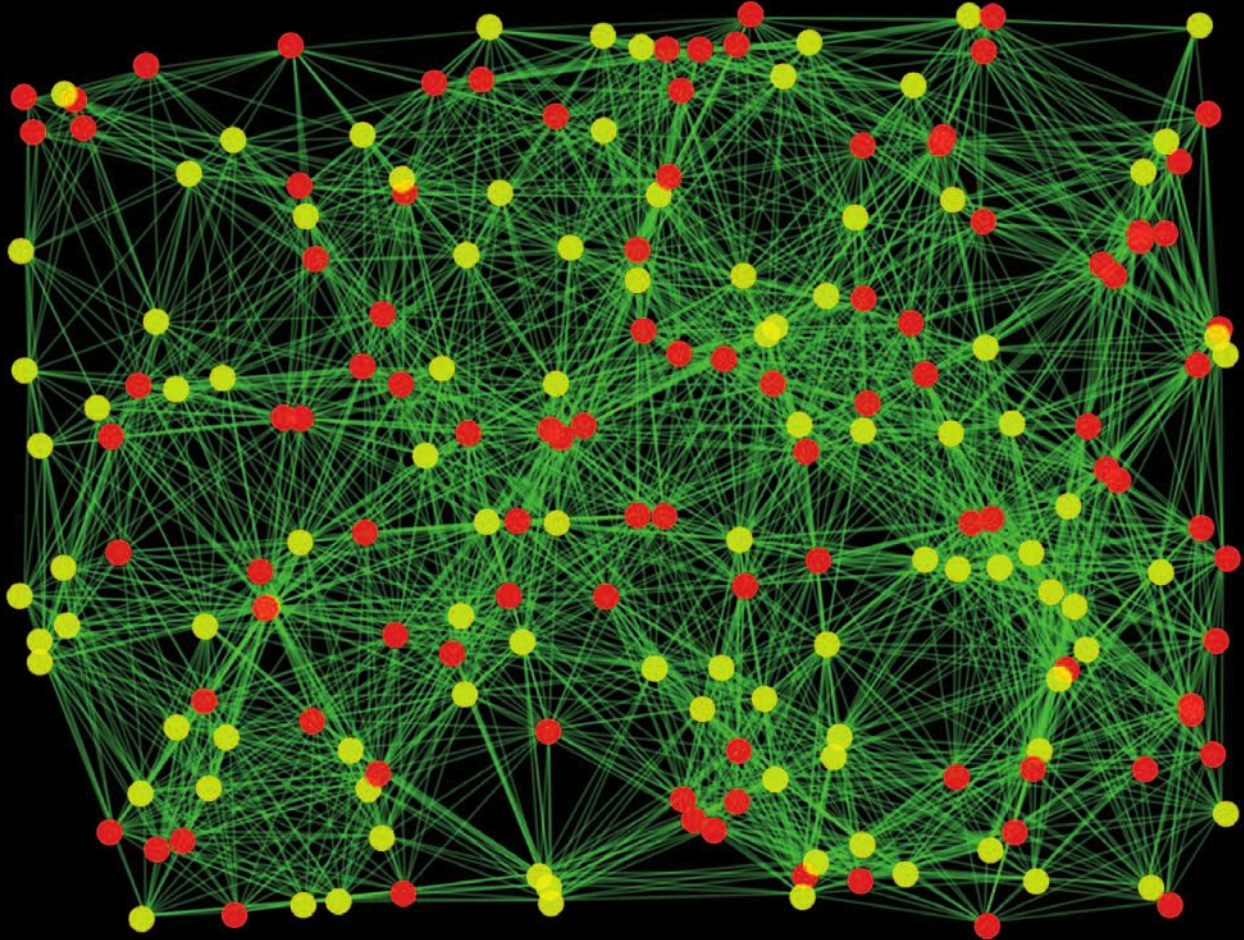

## Tomorrow's power grid: Adjusting demand to meet supply

### IN THIS ISSUE



A novel ultracapacitor: Energy when and where you need it

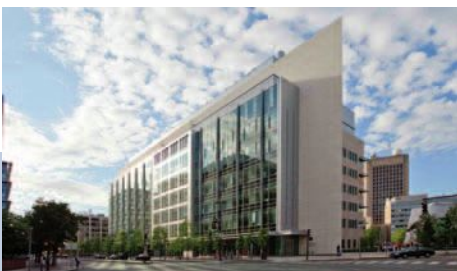

Converting plant waste into biofuels: Promising advances using yeast and fungi

MIT study of the electric grid: With new policies, grid can handle electric cars, wind, solar

Turning green to gold: Koch building leads lab energy performance



# Energy Futures

**Energy Futures** is published twice yearly by the MIT Energy Initiative. It reports on research results and energy-related activities across the Institute. To subscribe, send your address to [stauffer@mit.edu](mailto:stauffer@mit.edu).

Copyright © 2012  
Massachusetts Institute of  
Technology. For permission  
to reproduce material  
in this magazine, please  
contact the editor.

Nancy W. Stauffer, editor  
[stauffer@mit.edu](mailto:stauffer@mit.edu)  
617.253.3405

ISSN 1942-4671  
(Online ISSN 1942-468X)



## MIT Energy Initiative

The MIT Energy Initiative is designed to accelerate energy innovation by integrating the Institute's cutting-edge capabilities in science, engineering, management, planning, and policy.

MIT Energy Initiative  
Massachusetts Institute of Technology  
77 Massachusetts Avenue, E19-307  
Cambridge, MA 02139-4307

617.258.8891

[web.mit.edu/mitei](http://web.mit.edu/mitei)



Main cover image: Jacob Beal PhD '07, MIT  
Design: Tim Blackburn  
Proofreading: Kathryn M. O'Neill  
Printing: Puritan Press, Inc.

Printed on paper containing 30% post-consumer recycled content, with the balance coming from responsibly managed sources.

## A LETTER FROM THE DIRECTORS

- 2 Update on the MIT Energy Initiative

## RESEARCH REPORTS

- 4 A novel ultracapacitor: Energy when and where you need it
- 8 Revealing how a battery material works
- 11 Tomorrow's power grid: Adjusting demand to meet supply
- 16 Converting plant waste into biofuels: Promising advances using yeast and fungi
- 20 Programs for green cities: Finding out what works
- 24 Reaching underground resources: Vaporize the rock—no drilling required

## RESEARCH NEWS

- 28 MIT Energy Initiative announces latest seed grant awards
- 31 MIT and Tsinghua University launch the China Energy and Climate Project

## FOCUS ON FACULTY

- 32 Paula T. Hammond: Making new materials, solving critical problems

## EDUCATION

- 34 Knight Fellows offer tips on tackling energy/climate science beat
- 36 MIT students pursue energy challenges globally
- 36 MITEI awards research and education travel grants to 19 MIT graduate students
- 39 An inside look at international climate negotiations at COP17
- 40 MIT undergrad meets with other future energy leaders in Abu Dhabi
- 41 International internship opens doors for MIT engineering undergrad

## CAMPUS ENERGY ACTIVITIES

- 43 Turning green to gold: Koch building leads lab energy performance
- 45 MIT-NSTAR program proves model of efficiency

## OUTREACH

- 47 MIT study of the electric grid: With new policies, the grid can handle electric cars, wind, solar
- 49 MITEI report: Integrating large-scale intermittent energy sources into electric grid
- 51 DOE and MITEI announce US Women in Clean Energy program
- 51 Recent colloquia of note

## LFEE • Laboratory for Energy and the Environment

- 52 Chinese train station and airport surveys assess commuter travel decisions
- 54 Martin Fellows, 2012–2013
- 55 The Martin Fellows: Building a community of scholars for sustainability

## MITEI MEMBERS

- 56 MITEI Founding, Sustaining, Associate, and Affiliate Members

# Update on the MIT Energy Initiative

## Dear Friends,

In our last issue of *Energy Futures*, MIT President Susan Hockfield highlighted several significant events and trends that have dramatically altered the global energy marketplace since the MIT Energy Initiative (MITEI) was launched in late 2006—and the energy scene continues to bring surprises, most recently in the form of a dramatic drop in US natural gas prices.

Indeed, gas prices are now fully an order of magnitude less than oil prices on an energy equivalent basis. Some consequences of that shift are already being seen. For example, industries that rely on natural gas as a feedstock are gaining a competitive advantage against oil-based alternatives; and interest is being revived in natural gas as a transportation fuel that can substitute for oil, either directly or through conversion to liquid fuels. Also, as a result of low gas prices, electric power plants are switching from coal to natural gas. These trends have the potential to fairly dramatically reduce both emissions and oil dependence.

Some observers, however, perceive a negative side to these seemingly positive changes, namely, diminishing the drive toward new carbon-free energy sources. This concern was highlighted in MIT's Future of Natural Gas study released last year, which noted that abundant natural gas supplies and reduced energy demand should be welcomed as essential bridges to a low-carbon future but not as the ultimate destination.

In short, we can't become complacent. Innovation in transformative energy technologies—renewables, advanced nuclear power, carbon capture and sequestration, vehicle electrification

using decarbonized electricity sources—must continue aggressively, with strong research investments in both public and private sectors to drive down costs. This combination—focusing on using current energy supply options effectively and efficiently while developing breakthrough clean energy technologies—continues to characterize the MITEI research portfolio. We believe that this is a resilient strategy for moving toward widely shared environmental, economic, and security goals.

In this issue of *Energy Futures*, we highlight selected outcomes and opportunities from MITEI-supported activities, with a special focus on two areas—innovation and education—that are central to our mission.

Since its founding, MITEI has been fostering innovation by providing funds to MIT faculty for early-stage or novel research. The MITEI Seed Fund Program has now supported more than a hundred projects, and many are showing significant results, demonstrating that relatively small levels of financial support can forge key links in the energy innovation value chain. Some seed grant recipients have gone on to attract additional public and private funding, while others have entered the marketplace aided by venture capital funding. For instance, seed funds for millimeter-wave drilling have helped MIT researchers secure a commercial partner for the project as well as three years of federal funding. Seed funds for developing techniques to balance electricity supply and demand on the power grid have led to a startup company. And MITEI support for the initial analysis of the effectiveness of urban energy initiatives has attracted additional foundation funding. These and other research projects supported by the Seed Fund Program are described

beginning on page 4. MITEI just finalized its most recent round of seed fund awards; see pages 28–30 for a description and list of the new projects. The Seed Fund Program is supported generously by MITEI's Founding and Sustaining Members, and its reach across campus is extended further by philanthropic contributions from our alumni and friends.

The education section of this issue (pages 34–42) showcases MITEI's support of international educational and networking opportunities for MIT students beyond the classroom and research laboratory. Articles describe the MITEI-supported experiences of MIT students at climate change and energy meetings in Durban and Abu Dhabi, an undergrad's career-changing internship in Paris, and a graduate student's on-the-ground data collection project in China. Of particular note is a story about a pilot program—designed by MITEI's Energy Education Task Force—that is now providing funding for 19 students to perform field studies critical to their research or to share their research results at conferences around the world. Given the success of this pilot effort, MITEI is now establishing an ongoing program to support international opportunities for MIT graduate students in energy disciplines. This program—Energy Education Without Borders—underscores the truly global nature of our energy challenges and MITEI's commitment to developing the next generation of world energy leaders.

Outreach activities have continued on several fronts. MITEI launched, through the Joint Program on the Science and Policy of Global Change, a new collaboration with Tsinghua University in China, a five-year project to analyze the impacts of energy and climate

Photo: Justin Knight



**MITEI's research, education, campus energy, and outreach programs are spearheaded by Professor Ernest J. Moniz (right), director, and Professor Robert C. Armstrong, deputy director.**

policies—both existing and proposed—on technologies, energy consumption, the environment, and the economy. This project was the first to be advanced by a “mini-consortium” of MITEI members: Eni S.p.A., Shell, and ICF International.

In late March, MITEI collaborated with MIT's Industrial Liaison Program to sponsor a conference focused on energy challenges and policies and technologies to address them. The conference was held in Rome and hosted by Eni S.p.A., a Founding Member of MITEI (see the right-hand column for more details).

Work also continues on MITEI's goal of providing policymakers with technically grounded and informed analysis. MITEI released a multidisciplinary study called *The Future of the Electric Grid* at the National Press Club late last year and a report titled *Managing Large-Scale Penetration of Intermittent Renewables* at an on-campus press briefing in March. Key findings of those studies appear on pages 47–50.

Finally, MIT took a major step forward in “walking the talk” on more efficient energy use on campus. The David H. Koch Institute for Integrative Cancer

Research building is the first laboratory research facility at MIT to receive a Leadership in Energy and Environmental Design (LEED) Gold certification, as rated by the US Green Building Council. What went into receiving this rating and its implications for reducing energy consumption on campus are detailed on pages 43–45.

Faculty, staff, and students continue to be engaged across a wide spectrum of research and educational activities, and we hope you find these stories interesting, informative, and inspiring.

Sincerely,

**Professor Ernest J. Moniz**  
MITEI Director

**Professor Robert C. Armstrong**  
MITEI Deputy Director

June 2012

## Major conference in Rome explores energy mix of the future



**On March 28 and 29, MITEI and MIT's Industrial Liaison Program co-sponsored an energy conference held in Rome and hosted by MITEI Founding Member Eni S.p.A. The 2012 MIT Europe Energy Conference was opened by MIT President Susan Hockfield and Eni Board Chairman Giuseppe Recchi (shown above). MIT Institute Professor John M. Deutch delivered the keynote address, speaking about the geopolitical implications of Iran's nuclear program and its impacts on global energy markets. Other energy experts from industry and academia presented talks focusing on critical energy issues such as accommodating intermittent renewable generation into the power grid, growing concerns over the use of energy for water and water for energy, advanced solar concepts and technologies, new nanoengineered materials for energy, transportation fuel options, and energy and the built environment. A panel discussion focused on the future of natural gas.**



**Eni Board Chairman Giuseppe Recchi (left) and MIT President Susan Hockfield at the Rome conference.**

Photos courtesy of Eni S.p.A.

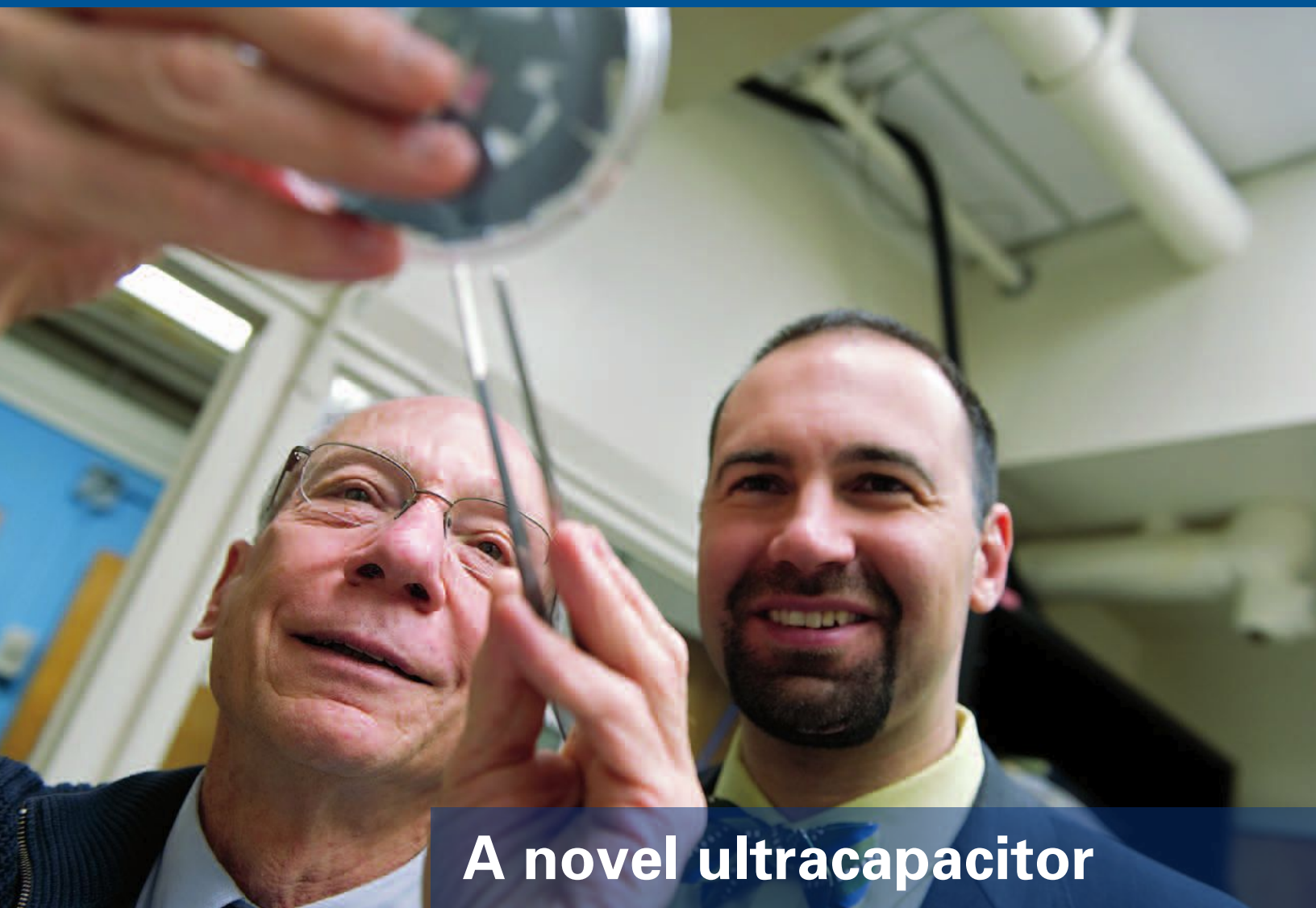

## A novel ultracapacitor

# Energy when and where you need it

**Joel Schindall of electrical engineering and computer science (left) and Riccardo Signorelli PhD '09 of FastCAP Systems examine carbon-nanotube-coated samples that proved key to the development of the full-scale, high-performance ultracapacitors now being marketed by FastCAP.**

**This research was supported in part by a seed grant from the MIT Energy Initiative. For a complete list of sponsors and publications, see page 7.**

Photo: Stuart Darsch

In the race to develop the perfect energy storage solution, ultracapacitors are an exciting horse to bet on. They deliver energy quickly, can be recharged in seconds, and have a long life span—but their capacity for storing energy is limited. An MIT startup company has now unveiled a novel version that can store twice as much energy and deliver about 10 times as much power as a conventional device can. Equipped with carbon-nanotube-coated electrodes, the new ultracapacitor uses low-cost, domestically abundant materials and a manufacturing process similar to those used at large scale by the solar industry. Among the first likely technologies enabled by the new ultracapacitor: a new hybrid electric vehicle that combines fuel efficiency with high performance and dramatically lower cost.

In the growing effort to run cars on electricity and generate power from solar and wind resources, a major stumbling block is energy storage. One promising energy-storage technology is the ultracapacitor, a device that offers significant advantages over the best of today's batteries. For example, ultracapacitors can provide high power—that is, they can deliver energy quickly; they can be recharged in seconds rather than hours; they can withstand cold temperatures, shocks, and vibrations; and they can be charged and discharged hundreds of thousands of times before they wear out. They also contain earth-abundant and nontoxic materials, so they are much easier on the environment than today's batteries are.

Ultracapacitors do, however, have one serious drawback: their low energy-storage capacity. At an equivalent size, an ultracapacitor can store only about 5% as much energy as a lithium ion battery can. Today, millions of ultracapacitors are used in battery-powered consumer products, providing backup power or brief bursts of energy in microcomputers, cellphones, and cameras. But an ultracapacitor capable of high energy storage could transform the energy scene, making possible high-performance, energy-efficient hybrid and electric vehicles, smoothly operating solar- and wind-powered grids, and more.

### A question of storing ions

The key to energy storage—whether in a battery or an ultracapacitor—is the ability to transfer and store charged particles called ions, says Joel Schindall, the Bernard Gordon Professor of the Practice in MIT's Department of Electrical Engineering and Computer Science. Both devices have at their core an

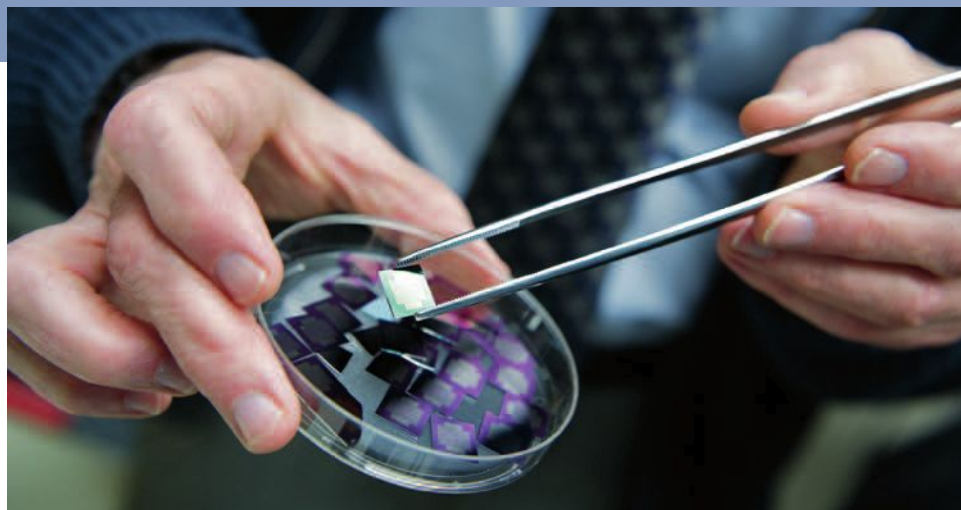

Photo: Stuart Darsch

**Carbon-nanotube-coated chips made at MIT ultimately led to the development of enhanced ultracapacitors for large-scale energy storage. Now, MIT researchers are looking into using them at a tiny scale, embedded within integrated circuits for power switching.**

electrolyte, a mixture of positive and negative ions. In a battery, chemical reactions move ions from the electrolyte into and out of the atomic structure of the electrode material as the battery is charged and discharged. In contrast, in an ultracapacitor, an electric field causes the ions to move to and from the surfaces of the electrodes. Because the ions just cling on and then let go—with no chemical reaction involved—an ultracapacitor can charge and discharge quickly, again and again. But while the battery stores ions throughout its electrodes—where there are many spaces for them to reside until the battery is discharged—the ultracapacitor stores them only on its surfaces.

In theory, then, the solution to ultracapacitor energy storage is simple: provide more electrode surface area for ions to cling onto. In today's commercial ultracapacitors, electrode surfaces are coated with activated charcoal, a material that is full of pores, providing surface area for clinging ions. But energy storage is still low.

In 2004, Schindall proposed a different solution: coat the electrodes instead with vertically aligned carbon nanotubes. A tightly packed array of tall, thin nanotubes on the electrode could provide lots of surface area for the clinging ions. Also, while the pores in activated carbon are irregular in size

and shape, a nanotube “forest” would provide straight pathways so the ions could come in and out easily and pack together neatly—like sucking up paint with a paintbrush rather than a sponge, says Schindall. He began to explore the concept with collaborators John G. Kassakian, professor of electrical engineering, and Riccardo Signorelli, then a graduate student in electrical engineering and computer science and subsequently a postdoctoral associate in the Laboratory for Electromagnetic and Electronic Systems (now part of MIT's Research Laboratory of Electronics).

### The concept and first steps

The diagram on page 6 shows the researchers' “nanotube-enhanced ultracapacitor.” At the top and bottom are the two electrode plates with carbon nanotubes attached vertically. A liquid electrolyte fills the space between them, and a porous separator down the middle keeps the plates from electrically shorting together. In this diagram, a voltage across the two plates has induced an excess of negative charge (electrons) on the top plate and an excess of positive charge (the absence of electrons) on the bottom one. As a result, the nanotubes are coated by ions of the opposite charge. When the two plates are connected by an external loop of wire, electrons will flow through that external circuit from the negative to the positive

electrode, powering an electricity-consuming device along the way. Over time, both plates will lose their charge, and the positive and negative ions will break away and mix back into the electrolyte.

With funding from the Ford-MIT Alliance, the MIT team performed detailed simulation studies that confirmed the potential benefits of the proposed concept. The simulations showed that the nanotube-enhanced ultracapacitor should be able to store more ions than conventional activated-carbon ones can, thereby achieving higher energy storage.

Encouraged by those findings, Schindall and Signorelli proceeded to the next challenge: making nanotube-enhanced electrodes. Within a year, they had learned to grow carbon nanotubes on silicon—but silicon is not a good conductor. Growing nanotubes on a conducting surface proved to be more difficult. After testing many materials, designs, and methods, they found a combination that worked. They used a layer of tungsten, then a thin layer of aluminum—the conductor—and finally a top layer of iron oxide, the catalyst for the process. Using the specially designed furnace shown on page 7 (left), they heated up their sample, and the iron oxide separated into droplets. They then blew dilute acetylene gas across the surface. The droplets of iron oxide grabbed carbon out of the gas, and carbon nanotubes began to grow upward out of the droplets. “Each droplet served as a follicle—almost like a hair follicle—for the nanotube growth,” says Schindall. Experiments showed that starting with a very thin layer of iron oxide led to the formation of tiny droplets and the growth of nanotubes that were tall, thin, and closely packed—a configuration that maximizes available surface

### Schematic diagram of the nanotube-enhanced ultracapacitor

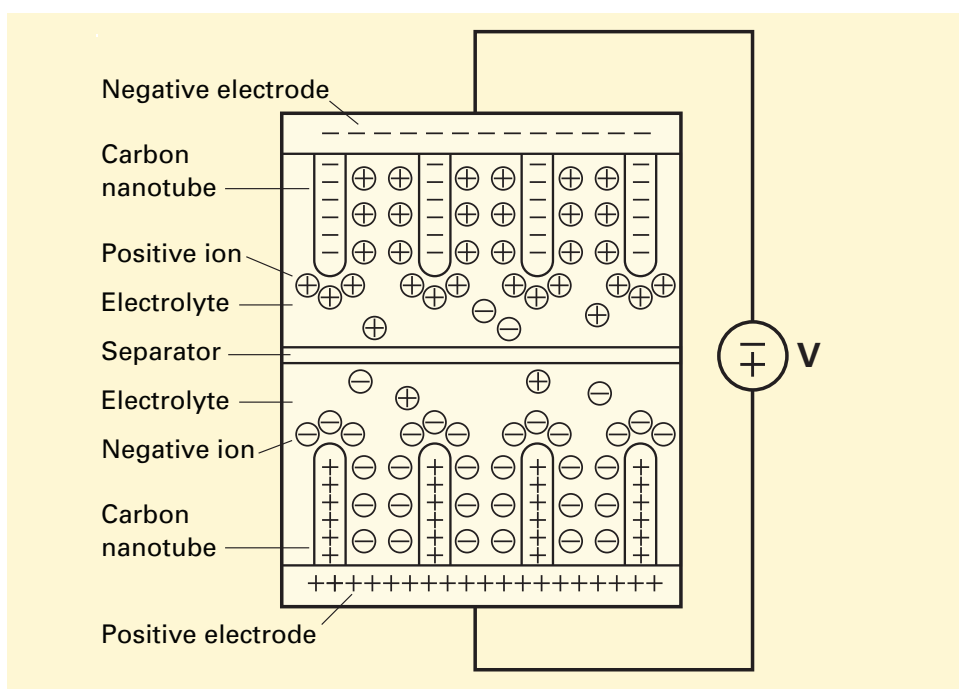

**At the top and bottom of the device are electrode plates with vertically oriented carbon nanotubes. (The nanotubes are relatively much longer and denser than indicated in this schematic.) Because of the applied voltage, the electrodes are coated with ions of the opposite charge and act as capacitors to produce voltage and store charge. They remain that way until the external circuit is connected. Electrons then flow from the negative to the positive electrode, powering a device along the way. The electrodes gradually lose their charge, and the ions let go and once again distribute themselves throughout the electrolyte.**

area on the electrode (see right-hand image on page 7).

#### The ultimate test: making a device

The next step was to integrate their nanotube-enhanced electrodes into a device and test its function. “We had grown nanotubes of about the right dimensions on a conducting substrate, but we didn’t know how they would work electrically,” says Schindall. He had a list of possible “showstoppers” that could crop up when they tried to assemble a device. For example, could they get the electrolyte to go down between the nanotubes and coat their surfaces? Carbon nanotubes are known to be highly water repellent. In addition, in this application, adjacent nanotubes hold the same charge, and their tips are close together. Would ions be able to pass through the electric field created by those charged tips? And would the nanotubes be able to pick up charge from the base? After all, they are grown

on iron oxide, which is an insulator, not a conductor. Answer any of those questions “no,” and the nanotube-enhanced ultracapacitor was not destined for success.

With funding from an MIT Energy Initiative seed grant, the researchers were able to fabricate a prototype test cell that allayed those concerns. They started with their nanotube-coated electrodes in a vacuum and then let air push the electrolyte down past the nanotube tips to fill the space. The ions were able to access and coat all the nanotube surfaces, and the nanotubes were electrically connected. Further studies showed that the base of each nanotube extended beyond the iron oxide droplet from which it had grown. Ultimately, its “foot” surrounded and encompassed the droplet; as a result, it was directly connected to the aluminum substrate below. The prototype thus proved the practical viability of the nanotube-enhanced ultracapacitor.



Photo: Stuart Darsch

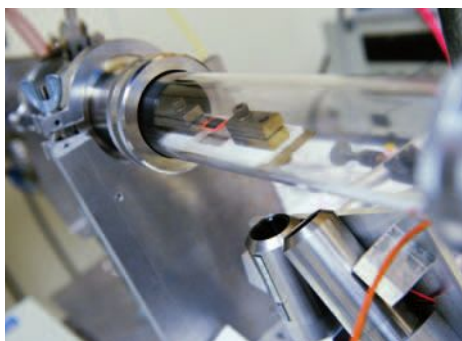

The MIT reaction chamber with a 1 cm by 1 cm carbon nanotube sample in place. The quartz tube is about 50 mm wide and 200 mm long, and carries dilute acetylene gas across the multilayer sample substrate, which lies on top of a heating element that is suspended by two clamps. The heating element glows red, while the nanotube sample appears dark because carbon nanotubes have grown and now coat the surface.

### Getting it to market

The MIT work showed that the new ultracapacitor could store energy, but the demonstration devices were each the size of a thumbnail and could charge and discharge only tiny amounts of energy. Nevertheless, Signorelli believed that they had potential. “Transforming that proof of concept into a full-scale, high-performance, marketable device would require much more development work—but we were confident we could make it happen,” he says.

During the past four years, Signorelli and his colleagues have done just that. In 2008, Signorelli PhD '09 and John Cooley PhD '11 founded FastCAP Systems, a company aimed at commercializing the nanotube-enhanced capacitor along with systems to enable its practical implementation. In fall 2009, FastCAP won a \$5.3 million award in the first round of the US Department of Energy (DOE) Advanced Research Projects Agency-Energy (ARPA-E) grants—one of just 37 successful proposals out of 3,600 initial submissions. Funding from other sources followed, and in fall 2011, the company received a second DOE grant for deploying the ultracapacitor in the energy market. FastCAP is now housed

Image courtesy of Riccardo Signorelli PhD '09, MIT

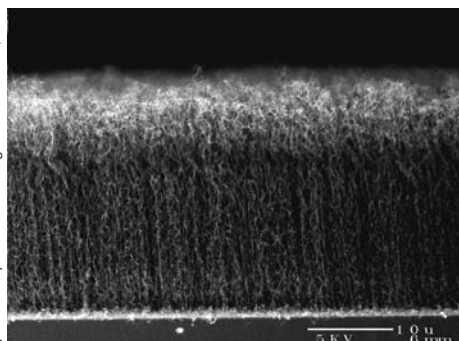

This cross section shows a “forest” of carbon nanotubes grown on an aluminum electrode. Each nanotube is about 250 microns long—about twice as long as a human hair is thick. The densely packed nanotubes significantly increase the surface area of the electrode—the key to the enhanced energy-storage capacity of the new ultracapacitor.

in a 17,000-square-foot R&D and pilot production facility in the Seaport District of Boston. It has 25 employees and recently sold and shipped its first generation of products.

The latest FastCAP ultracapacitor stores twice as much energy as its competitors can and delivers 7 to 15 times more power. It also costs less. It uses raw materials that are both inexpensive and abundant within the United States. (The electrode material, for instance, costs about one-fiftieth as much as that used in conventional capacitors.) The manufacturing process is based on methods used for large-scale production of solar photovoltaic components. As a result, it is both low-cost and scalable—and as a bonus, the necessary equipment and expertise are highly developed and readily available.

While the new ultracapacitor has potential applications in many fields, the immediate focus is on transportation. Signorelli cites significant opportunities for improving vehicle technology. For example, in an electric car, high-energy-density batteries can provide enough energy to travel 200 miles before recharging. But adding nanotube-enhanced ultracapacitors to such systems would provide high power for acceleration and deceleration and would allow the batteries to be optimized for range rather than for power.

In a hybrid-electric vehicle, the ultracapacitor could be the best option, providing power for rapid acceleration and deceleration and instant discharging and charging—a million or more times over the lifetime of the vehicle. “Most people don’t associate the word ‘hybrid’ with a high-performance vehicle, but our ultracapacitors could change that,” says Signorelli. “Integrating them into today’s hybrid technology could yield new hybrids that are fuel efficient, high performance, and cost competitive with non-hybrid vehicles on the market today.”

• • •

By Nancy W. Stauffer, MITEI

Funding for the MIT research came initially in part from the Ford-MIT Alliance and subsequently from a seed grant from the MIT Energy Initiative. In 2009-2010, John Cooley received support as a Martin Family Fellow for Sustainability. FastCAP has received two grants from the US Department of Energy—one from the Advanced Research Projects Agency and the other from the Office of Energy Efficiency and Renewable Energy—with additional funding through the Chesonis Family Foundation and the Massachusetts Clean Energy Center. Further information can be found on the FastCAP website at [www.fastcapsystems.com](http://www.fastcapsystems.com) and in the following publications:

J. Schindall. “What’s in a name? A new model for regenerative electrical energy storage.” *IEEE Power Electronics Society Newsletter*, first quarter 2008, pages 32–34.

J. Schindall. “The charge of the ultracapacitors.” *IEEE Spectrum*, November 2007.

R. Signorelli. *High Energy and Power Density Nanotube-Enhanced Ultracapacitor Design, Modeling, Testing, and Predicted Performance*. PhD thesis, MIT Department of Electrical Engineering and Computer Science, June 2009.



## Revealing how a battery material works

**Martin Z. Bazant of chemical engineering and mathematics (left) and Daniel A. Cogswell of chemical engineering display results from new computer simulations that help explain why the hottest new material for rechargeable batteries works so well.**

**This research was supported in part by a grant from the MIT Energy Initiative. For a complete list of sponsors and publications, see page 10.**

Photo: Stuart Darsch

Since its discovery 15 years ago, lithium iron phosphate ( $\text{LiFePO}_4$ ) has become one of the most promising materials for rechargeable batteries because of its stability, durability, safety, and ability to deliver a lot of energy at once. It has been the focus of major research projects around the world and is a leading technology used in everything from power tools to electric vehicles. Despite this widespread interest, the reasons for  $\text{LiFePO}_4$ 's unusual charging and discharging characteristics have remained unclear. Now, research by MIT associate professor of chemical engineering and mathematics Martin Z. Bazant and post-doctoral associate of chemical engineering Daniel A. Cogswell has provided surprising new results showing that the material behaves quite differently than had been thought, helping to explain its performance and possibly opening the door to the discovery of even more effective battery materials.

## Simulated structure of $\text{LiFePO}_4$ particles during battery discharge

When  $\text{LiFePO}_4$  was first discovered, it was considered a good material for the electrodes of lithium-ion batteries but useful only for low-power applications. When a lithium-ion battery discharges and charges, lithium ions must move into and out of its electrodes, and the rate at which that process occurs in  $\text{LiFePO}_4$  is relatively slow, which limits the battery's power (the speed at which energy is delivered). Later developments—by researchers including MIT's Yet-Ming Chiang, the Kyocera Professor of Ceramics—showed that the power capacity of  $\text{LiFePO}_4$  could be improved dramatically by using it in nanoparticle form, an approach that made it one of the best materials known for high-power applications.

But the reasons why nanoparticles of  $\text{LiFePO}_4$  worked so well remained elusive. It was widely believed that while being charged or discharged, the material within a particle separated into different crystalline phases with very different concentrations of lithium. That phase separation, it was thought, always occurred during discharge, limiting power capacity. But the new research shows that, under many real-world conditions, that separation never happens.

Bazant's theory predicts that above a critical current, the reaction is so fast that the material loses its tendency for the phase separation that happens at lower power levels. Approaching the critical current, the material passes through a new, unstable "quasi-solid solution" state, where it "doesn't have time to complete the phase separation," he says. That characteristic helps explain why  $\text{LiFePO}_4$  material is so good for rechargeable batteries. In addition, the incoming lithium ions create mechanical stress on the "host" crystals of iron phosphate, which

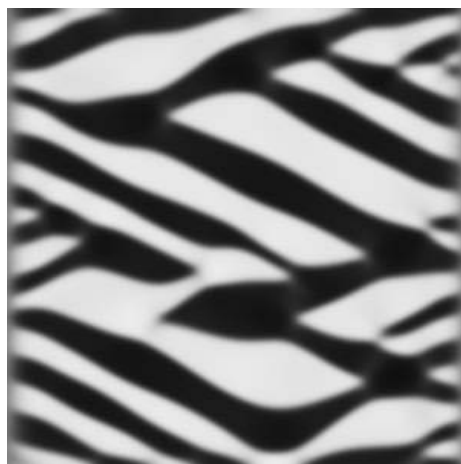

**An MIT simulation predicts the behavior of iron phosphate particles in an electrode of a lithium ion battery. As the battery discharges at low current, lithium ions move into an iron phosphate particle, separating into areas that are either lithium-rich or lithium-poor (left image). Over time those regions evolve into parallel bands (right). That structure—observed in experimental samples—can lead to cracking at the boundaries and degradation in performance over time. But when the battery is discharged at a high enough current level, that separation never occurs, according to the simulation results.**

further helps suppress phase separation. Including that phenomenon in the MIT calculations led to a quantitatively accurate model of  $\text{LiFePO}_4$  behavior, says Bazant.

The findings resulted from a combination of theoretical analysis, computer modeling, and laboratory experiments, Bazant explains—a cross-disciplinary approach that reflects his own joint appointments in MIT's Departments of Chemical Engineering and Mathematics.

Previous analyses of this material had examined its characteristics at single points in time, ignoring the dynamics of its behavior. But Bazant and Cogswell studied how the material changes while in use, either while charging or discharging a battery—and its changing properties over time turned out to be crucial to understanding its performance.

"This hasn't been done before," Bazant says. What they found, he adds, is a whole new phenomenon, and one that

could be important for understanding the performance of many battery materials—meaning this work could be significant even if  $\text{LiFePO}_4$  ends up being abandoned in favor of other new materials.

### Taking a closer look

Widely accepted mathematical models of  $\text{LiFePO}_4$  are based on the following hypothesis: As a lithium ion battery discharges, lithium gradually soaks into the iron phosphate particles of the electrode from the outside in, producing a shrinking core of lithium-poor material at the center surrounded by a gradually increasing shell of lithium-rich material. What the MIT team found was quite different. According to their simulations, as discharging progresses at low current, the lithium travels across a given particle, forming straight parallel bands of enriched material within the particle. Their new model thus predicts, for the first time, striped patterns of lithium in

partially filled particles, consistent with experimental observations.

But at higher current-discharge levels there is no separation at all, either in bands or in layers. Instead, a particle soaks up the lithium all at once, transforming almost instantaneously from lithium-poor to lithium-rich. But every particle in an electrode does not change at once. Instead, they take turns. Certain particles take in lithium, and when they are fully saturated, others follow suit. Thus, each particle remains homogeneous, and as a group they form a mosaic pattern, with some existing at low lithium concentration and others at high lithium concentration. Moreover, increasing the current causes larger numbers of particles to fill uniformly and smoothly, promoting “ultrafast” discharging.

The new finding helps explain lithium iron phosphate’s durability at high current. When stripes of different phases are present, the boundaries between those stripes are a source of strain that can cause cracking and a gradual degradation in performance. But when the whole material changes at once, there are no such boundaries and thus less degradation.

That’s an unusual finding, Bazant says: “Usually, if you’re doing something faster, you do more damage, but in this case it’s the opposite.” Similarly, he and Cogswell predict that operating at a slightly higher temperature would actually make the material last longer, which runs counter to typical material behavior.

In addition to seeing how the material changes over time, understanding how it works involved looking at the material at scales that others had not examined. While much analysis had been done at

## Fundamental calculation of strain energy between lithium-rich and lithium-poor regions in $\text{LiFePO}_4$ particles

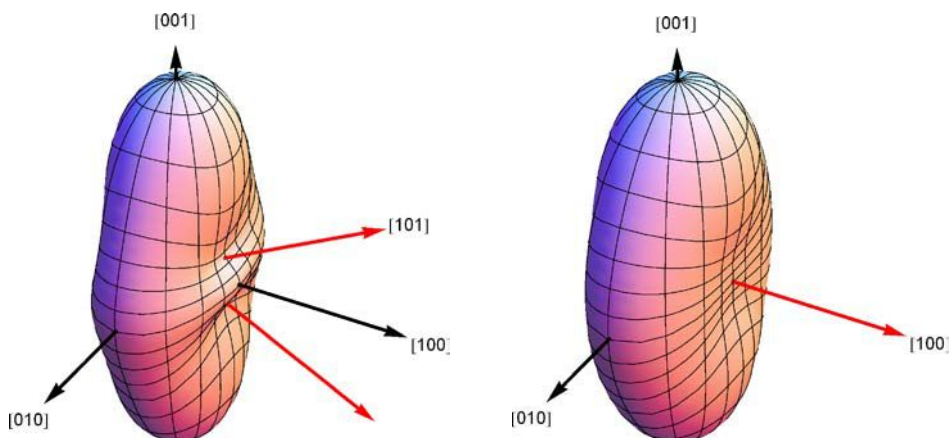

These plots display key fundamental theoretical predictions underlying the structures pictured on page 9. The elastic strain energy at the boundaries between lithium-rich and lithium-poor regions depends on the angle at which those boundaries align relative to the iron phosphate crystal structure. The figures above plot that energy as a function of orientation, offering an explanation of experimental observations. If all orientations had the same energy, the plot would be a perfect sphere. In this case, the red arrows show orientations that minimize interfacial energy and are preferred angles of alignment. The left plot shows two low-energy orientations; accordingly, in the left image on page 9, the boundaries tend to run at two distinct angles. The right plot above shows just one low-energy orientation; as a result, in the right-hand image on page 9, the layers all tilt in the same direction.

the level of atoms and molecules, it turned out that the key phenomena could only be seen at the scale of the nanoparticles themselves, Bazant says—many thousands of times larger. “It’s a size-dependent effect,” he says.

Understanding why lithium iron phosphate works so well was “one of the most interesting scientific puzzles I’ve encountered,” Bazant says. “It took five years to figure this out.” But the impacts of his findings could be significant. The insights gained may help scientists develop new materials and structures, leading to batteries with longer life, higher energy density, and higher power—characteristics needed for electric vehicle power systems, renewable energy storage, and other important emerging technologies.

• • •

By David L. Chandler, MIT News Office, with additional reporting by Nancy W. Stauffer, MITEI

This research was supported by a seed grant from the MIT Energy Initiative and a grant from the National Science Foundation. Further information can be found in:

D. Cogswell and M. Bazant. “Coherency strain and the kinetics of phase separation in  $\text{LiFePO}_4$  nanoparticles.” *ACS Nano*, vol. 6, no. 3, pages 2215–2225, 2012.

P. Bai, D. Cogswell, and M. Bazant. “Suppression of phase separation in  $\text{LiFePO}_4$  nanoparticles during battery discharge.” *Nano Letters*, vol. 11, pages 4890–4896, 2011.



## Tomorrow's power grid

### Adjusting demand to meet supply

An MIT startup company will soon release a tool that could profoundly change the way electric utilities operate. Here's how: When the grid becomes overloaded, the utility sends out a call to reduce demand. In response, selected appliances in millions of households talk among themselves and decide—based on random but coordinated selection—which of them will shut off to achieve the needed cuts. The shutdowns cause little or no inconvenience to residents; they affect only customers who have agreed to participate; and there is no central server storing private information or threatening to crash if the participant base gets too large or a hacker gets too successful. Simulations and early trials show that the response to calls for demand reduction will be fast, accurate, and smooth, even on a grid with a high level of constantly fluctuating solar and wind power generation.

**Jacob Beal PhD '07 (right) and Brad Kayton of ZOME Energy Networks review simulation results demonstrating how their novel distributed control system—called ColorPower—could reduce electricity demand on a power grid by adjusting the operation of major energy-consuming appliances such as water heaters.**

**This research was supported in part by a seed grant from the MIT Energy Initiative. See page 15 for more information about funding and a list of publications.**

Photo: Stuart Darsch

A major impediment to widespread deployment of renewable generators is the inability of today's power grids to deal with their constantly varying output. Without large-scale storage capability, that output can be as changeable and unpredictable as the sun and the wind. The ability to adjust electricity demand in response to changing supply would ease the situation, and the most promising sources of demand flexibility are the residential and light commercial sectors, with their many energy consumers and energy-using appliances, which combined make up almost half of the electricity usage in the country. (The light commercial sector includes small offices, shops, restaurants, and the like.) Studies suggest that people would be willing to cut back their energy consumption when the grid is short on supply. Consumers in some regions of the United States are already getting "smart meters" installed and control devices put on their appliances. But those early trials are not working well from most people's perspectives. Electric utilities are getting unreliable information, and changes in demand are not fast enough to help for most of their energy-reduction needs. Meanwhile, consumers are strenuously objecting that their privacy is being invaded.

The problem, according to Jacob Beal PhD '07, research affiliate in MIT's Computer Science and Artificial Intelligence Laboratory and scientist at Raytheon BBN Technologies, stems from the current need to connect all consumers to a central controller. Moving all the data to and from a central point takes time; the problem gets worse as more people are connected; and the central controller knows everything about everyone—a setup ripe for central failure and abuse of private information. Beal's solution is

### ColorPower outlet for major appliances

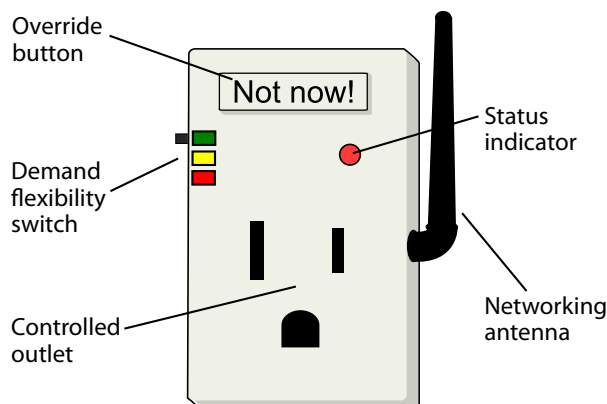

**In the ColorPower system, major appliances or their outlets are equipped with switches that enable owners to select colors indicating their willingness to have that appliance shut off or down. As with a stoplight, green means go ahead; yellow is proceed with caution; and red is stop (or in this case, switch only in case of emergency). A large override button temporarily keeps the appliance on, regardless of its assigned color. The networking antenna communicates wirelessly with other outlets and appliances and with the household demand controller to report its status and receive instructions.**

simple: Get rid of the central controller. Instead, capture a little of each person's preferences and willingness to volunteer on their appliances and then set up a network that enables the millions of appliances to work together to shape demand, taking into account their owners' recorded flexibility.

Beal has long been fascinated by the problem of how to get large numbers of computers or other devices to work together directly, with no central control. Like others working in "amorphous computing," he began writing computer procedures, or algorithms, based on principles inspired by self-organizing biological systems such as swarms of bees or the human body, which "works well, even though it's made of many individually faulty pieces," he explains.

In 2008, Beal realized that his algorithms could have an important energy-related application: They could provide a novel

means of controlling the millions of distributed energy-consuming devices that make up residential demand. Under a seed grant from the MIT Energy Initiative, Beal, then-graduate student Vinayak V. Ranade SB '09, MEng '10, and others pursued that idea. Their achievements led to the formation of a startup company called ZOME Energy Networks. Co-founded by entrepreneurs Brad Kayton and Jon Rappaport, ZOME has been further developing, demonstrating, and marketing products based on the MIT algorithms, some of which have already been purchased by utility companies worldwide.

#### Making consumer choices easy

The usual approach to assessing flexibility in consumer demand is to ask people how much money would induce them to change their habits and which of several appliances they value more. While the responses provide fodder for optimization studies and economic

calculations, the questions do not make sense to the consumer. Says Beal, “We really want to elicit information from people about convenience—convenience versus citizenship, volunteerism, and community spiritedness.”

Their approach—called ColorPower— involves equipping major energy-consuming appliances (or their outlets) with switches that enable the owner to select colors that mimic the messages conveyed by a stoplight (see the illustration on page 12). The owner can deem an appliance green, meaning “I can do without this any time, so turn it off or down whenever you need to.” Examples might be turning off the water heater for five minutes or turning up the air conditioner by a degree or two—changes that an individual occupant is unlikely to notice but which, multiplied by thousands of households, will significantly reduce demand.

The owner could instead choose yellow (adjust this device only if the grid is under strain) or red (turn this one off only to prevent a blackout or other emergency). Finally, a large override switch enables the customer to say, “Not now!” Regardless of the assigned color, the device becomes black—“not an option”—but only temporarily. The goal is to discourage the consumer from switching, say, the air conditioner from yellow to red to make sure it keeps running during a crowded Super Bowl party.

Beal stresses the importance of giving consumers choices that they can relate to. “You want to get their real feelings about their energy use, but you don’t want them to make hard decisions,” he says. “The most important thing is not to annoy the customer.”

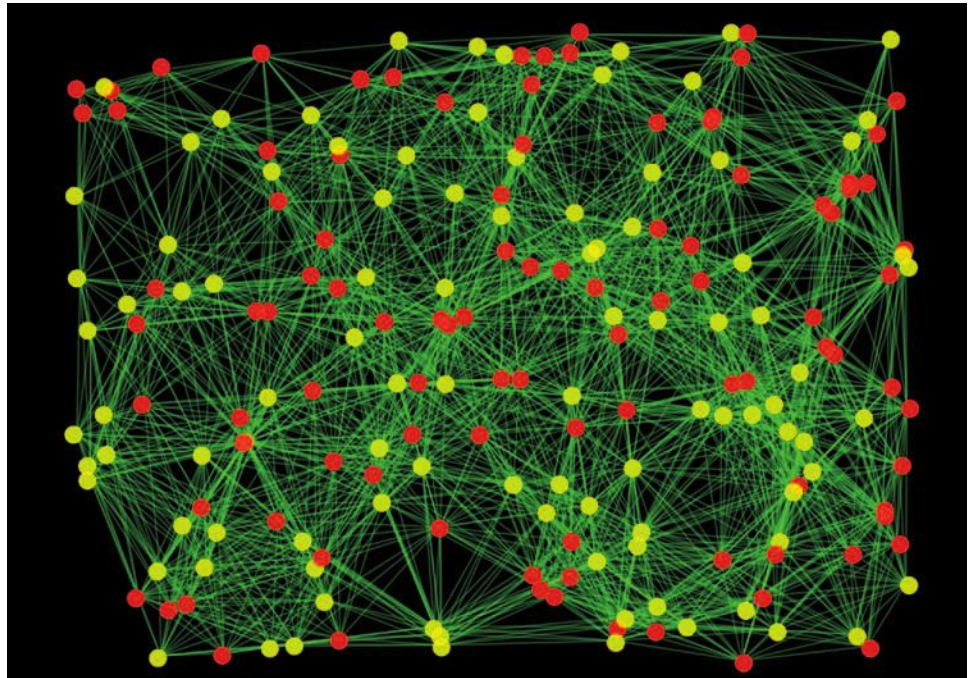

In this visualization, the colored dots show what mode individual houses are in after a call for demand reduction. The yellow houses have their green devices turned off but their yellow devices still on. The red houses have both their green and yellow devices turned off, but their red devices are on. The green lines show the communication links from house to house.

### Controlling demand without a central controller

The information conveyed by color choice drives the second part of the ColorPower system: the algorithms that enable millions of appliances—regardless of their location—to cooperate to achieve the needed total reduction in demand. Each household has a “demand controller” that talks to all the targeted appliances in the house, constantly receiving updates on the color and status of each device. (I’m yellow, and I’m running.) Every household demand controller uses a distributed aggregation algorithm to continually track overall flexibility on the multi-house network. All operations proceed in a decentralized fashion—except when the grid becomes stressed and a central server sends all participants a call to reduce demand.

When that rallying cry is issued, the collective must respond. “Here’s where the ‘coin flipping’ comes in—the feature that makes the system both random and fair,” explains Beal. Say the utility calls for a 30% reduction in demand. In response, each participating appliance flips a coin to determine whether it should stay on or shut off. To get the needed outcome, the coin is weighted so that it has a 30% chance of coming up heads (shut off) and a 70% chance of coming up tails (stay on). On average, 30% of the devices will shut off.

But there are wrinkles that make the calculation not quite so straightforward. For example, the coin flipping is unlikely to yield the exact outcome intended. If the weighting is 30% heads, maybe 25% will come up heads and be switched off. So the distributed aggregator runs again, reports the 5% shortfall, and the

still-running devices flip again, aiming for 5% heads. Individual devices will, of course, vary in the amount of power they consume. But the large number of devices and the constant adjustments enable the system to tolerate that variability.

Another complication is that devices should not turn off and on again very quickly, both to prevent damaging the equipment and to keep from annoying the consumer. So an appliance that has been switched—either off or on—cannot be switched again for a set period of time. Slight variability in that delay time ensures that not all subsequent changes happen at once, which could destabilize the grid.

Computing the exact weighting of the coins to be flipped while taking into account the color status of every device “is where all the magic happens,” says Beal. “You throw a lot of algebra and control analysis at it, turn the crank really hard, and get the right probability.” Every household controller has enough information to perform that computation locally and then communicate the outcome so that all devices have access to aggregated information on the network’s current status. The aggregation of data from all households protects the privacy of each household, and the more households there are, the greater that protection.

Thus, while a centrally controlled system starts to break down as the number of participants expands, the ColorPower system only gets better: It becomes increasingly responsive and accurate, and separating out the behavior of an individual household from the aggregated data gets more and more difficult.

### Simulation of emergency reduction in electricity demand achieved by ColorPower system

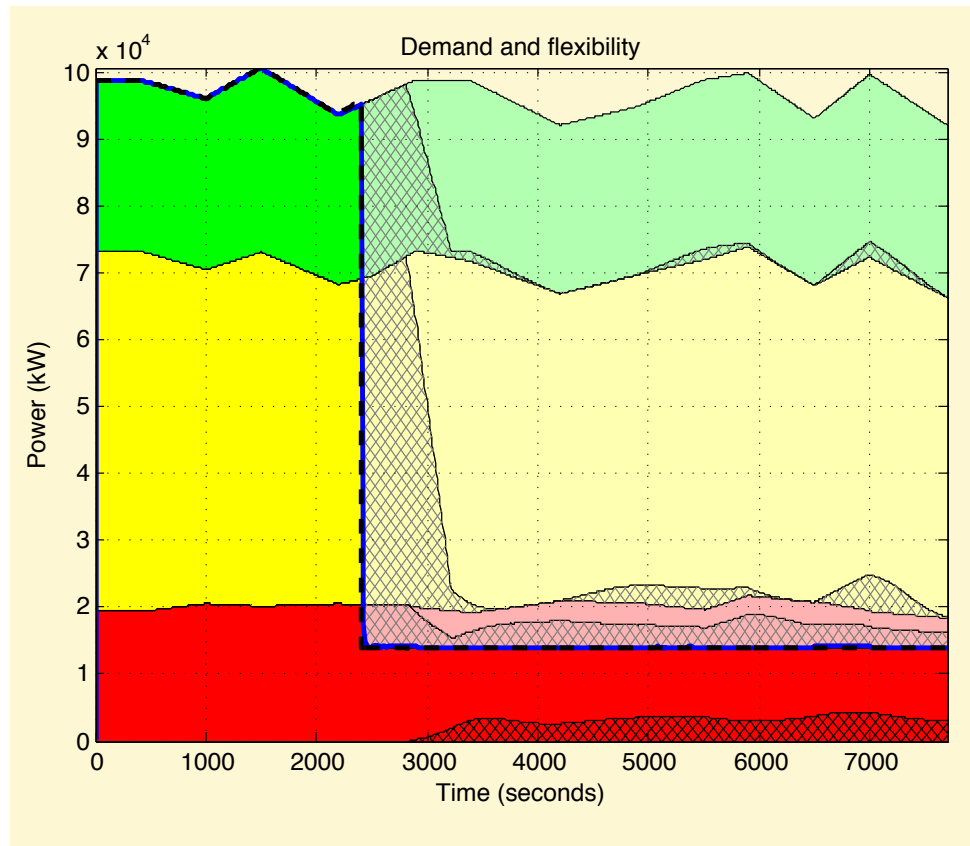

This figure shows results from a simulation in which the ColorPower system was used to dramatically reduce power demand on a grid of 100,000 interconnected devices. The black dashed line is the demand-reduction goal during this simulated emergency; the blue line is the reduction achieved by the system. The colors indicate the order in which devices can be shut off, based on stated owner preferences: Green devices shut off first, then yellow, then red. Bright colors show power being consumed; faint colors show demand that has been shut off; cross-hatched regions represent devices that have recently been switched on or off and are therefore unavailable for switching. The response time is fast, and the adjustments are accurate.

To test the system, Beal created a simulator and performed runs to see how quickly and accurately the millions of “appliances” on the simulated network would respond to calls for demand reduction. The figure above presents sample results from one run. Based on his simulations, Beal concluded that the ColorPower system should be able to shape power demand with a high level of accuracy and a delay

time of tens of seconds. Such responsiveness makes the widespread use of renewables a practical option. Assume, for example, a grid with significant solar generation. When the sun goes behind a cloud and the power supply abruptly drops, within a minute, appliances turn down or off to reduce demand to match the new level of supply. When sunshine returns, those appliances switch on with almost no delay.



## Going commercial

ZOME Energy Networks is now rolling out products based on the ColorPower approach. Interestingly, their first product is based on Beal's simulation software. Released in November 2011, the ZOMEimpact Analytic Simulator is now being used by utilities in the United States, Canada, and India to forecast the effects on their power grids of implementing programs to control demand—a new practice in an industry in which simulation has been used only to explore issues on the supply side. In addition, the utilities are using economic models included in the simulation software to help them design new customer-incentive programs.

The demand control product—called ZOMEbalance—is now being demonstrated, and later in 2012, utilities will be able to buy it and offer it as a service to their customers. A working demo presented at the Consumer Electronics Show in January in Las Vegas was well received. ZOMEbalance puts a tenth as much signaling on the network and is up to 100 times faster (in the aggregate) than other products on the market, all of which rely completely on centralized control. The reduced network traffic saves operational costs associated with the smart meter networks, and the fast response time allows for important new uses of demand control.

Kayton and Beal believe that utility programs based on the ColorPower system will appeal to consumers. When the program is available, customers can choose to sign up. After the necessary hardware is installed (about an hour-long job), customers will experience little follow-up other than small but measurable rebates on their bills. While just a few percent of customers have

signed up for currently offered demand-management programs, Kayton hopes that with ZOMEbalance the opt-in rate will reach 20% or more. “After all, if you didn't notice it, you got a benefit, you helped the environment, and it was fair, private, and secure—why wouldn't you sign up?” says Kayton.

• • •

*By Nancy W. Stauffer, MITEI*

This research was supported initially by a seed grant from the MIT Energy Initiative. Subsequent work is ongoing at ZOME Energy Networks, with support from its investors. Further information can be found in:

V. Ranade and J. Beal. “Distributed control for small customer energy demand management.” *Proceedings of the 2010 Fourth IEEE International Conference on Self-Adaptive and Self-Organizing Systems*, pages 11–20.

V. Ranade. *Model and Control for Cooperative Energy Management*. MEng thesis, MIT Department of Electrical Engineering and Computer Science, May 2010.

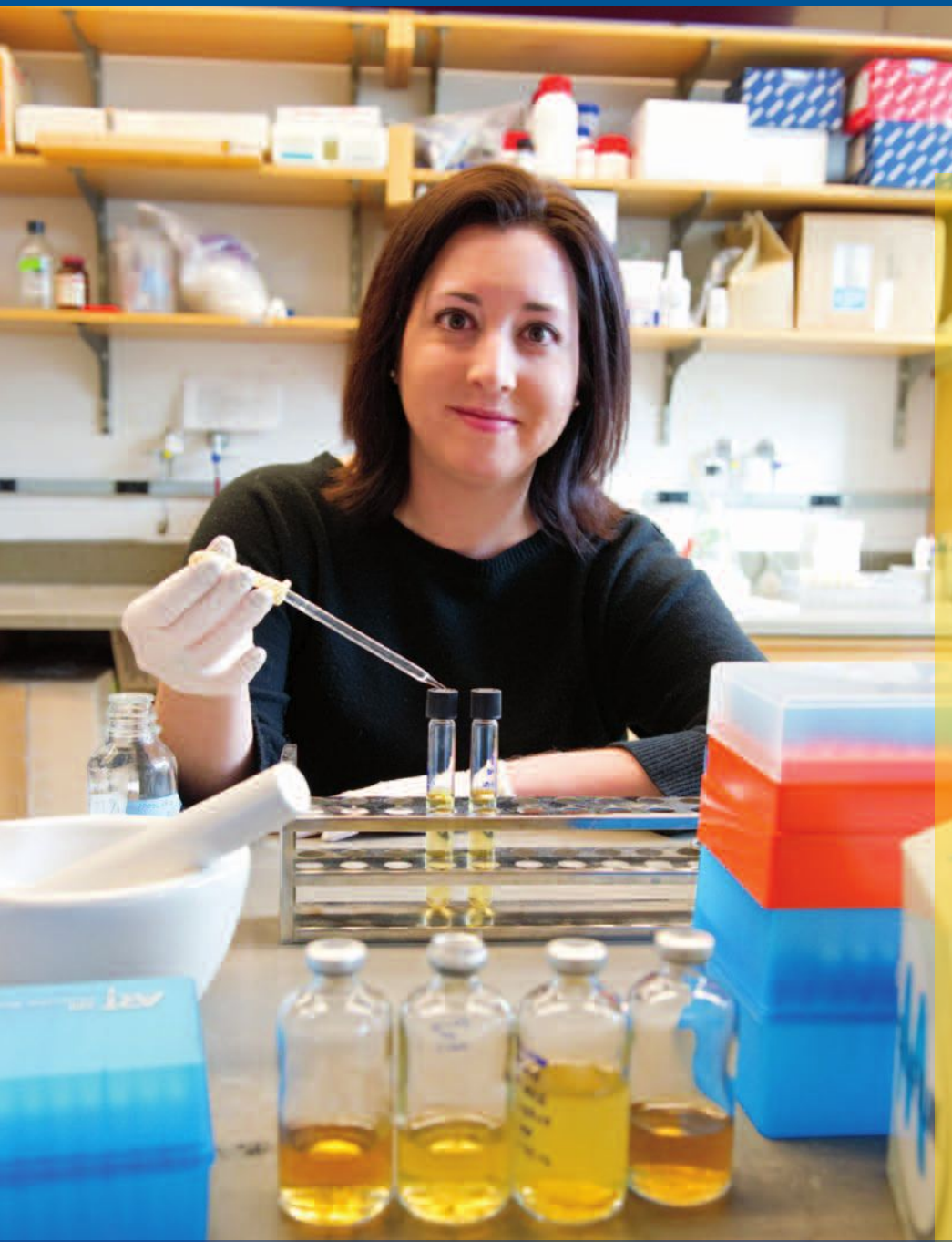

## Converting plant waste into biofuels

Promising advances using yeast and fungi

MIT researchers are genetically engineering yeast to break down stubborn plant fibers into sugars that it can then ferment—a first step toward a potentially cost-effective single-organism process for manufacturing cellulosic biofuels. The source of the genetic material: anaerobic fungi from the digestive system of a horse on a hay-only diet. By teaming up with genetic-sequencing experts at MIT, the researchers have developed a novel analytical approach that will enable them to determine which enzymes in gut fungi are key players in plant digestion and how those enzymes are made and assembled—information that will help them replicate the fungi's cellulose-destroying capabilities in yeast. Their approach could reveal new enzymes that are champion cellulose degraders but naturally occur only in unknown organisms that cannot be grown in a lab.

**Michelle O'Malley (above) and Chris Kaiser, both of biology, are figuring out exactly how fungi from the digestive tract of a horse break down tough fibers in grasses—understanding that could lead to better methods of making biofuels from cellulosic biomass.**

**This research was supported in part by a seed grant from the MIT Energy Initiative. More information about funding and a publication can be found on page 19.**

Photo: Justin Knight

One promising source of renewable fuels is biomass from agricultural residues, grasses, and other dedicated energy crops. Methods exist to convert such cellulosic biomass into energy-rich fuels that could substitute for petroleum, particularly in transportation systems. In general, those methods use enzymes and chemicals to break plant biomass down into sugars such as glucose, which are then fed to a microorganism to ferment the sugars to make ethanol, butanol, and other end products. But such methods are not economically viable for widespread use, largely due to the expense associated with enzyme production and activity and the costs associated with separating cellulosic processing into so many steps.

Chris Kaiser, the MacVicar Professor of Biology, believes that a better approach is to genetically engineer a single organism that can both break down the cellulose and ferment the product—and he believes that the best organism for the job is yeast. “We already know how to genetically modify yeast to control its metabolic pathways, and we have vast experience with using yeast to conduct fermentation on an industrial scale,” says Kaiser. The steps needed to implement his idea are known: Select an organism that naturally digests cellulose, identify the key enzymes involved in that process, determine which genes express those enzymes, retrieve those genes, and insert them into yeast. Such engineered yeast could readily be put into an industrial process and scaled up for biofuel production.

Researchers in Kaiser’s lab know yeast: They use it as a model organism for studying many fundamental cellular processes. But genetically engineering yeast to process cellulosic biomass was



**In this image, anaerobic fungi that MIT researchers isolated from horse feces are seen colonizing wheat straw. The fungi appear as dark oval shapes burrowing into the straw—behavior typical of anaerobic fungi in the digestive system. Because such gut fungi tend to be associated with solids, they are not found in analyses of liquid gut samples. As a result, their presence and their contribution to cellulose degradation in the gut are generally significantly underestimated.**

a novel concept and a new direction for them. Says Kaiser, the idea “was sparked by MIT Energy Initiative seed funding and has blossomed into a broader MIT research endeavor and a new way of thinking about finding improved organisms and enzymes for use in manufacturing biofuels.”

### Looking for enzymes

The first task was to find cellulose-degrading, or “cellulolytic,” enzymes that would work well in yeast. A good place to look is in the digestive tracts of large herbivores such as cows and horses. Such animals consume large quantities of grass and hay, and parts of their digestive tract contain a mixture of bacteria, fungi, and protozoa optimized to digest those difficult materials.

The idea of seeking cellulolytic enzymes in the rumen or hindgut is not new, but usually the focus is on bacteria—the workhorse of the industrial microbiology world. However, genes from bacteria generally will not express

enzymes efficiently in yeast. Genes from fungi would work better, but relatively little is known about the fungi in large mammalian herbivores. A widely accepted view is that they are present in very low concentrations in the digestive tract of large herbivores, so they cannot be critical players in cellulose digestion. In addition, they are extremely difficult to isolate and culture in a lab since they require carefully controlled growing conditions, including the absence of oxygen. Expose this “obligate anaerobe” to oxygen and it dies. The result: anaerobic fungi have largely been ignored.

Kaiser and his colleague Michelle O’Malley, USDA-NIFA Postdoctoral Fellow in biology and now an assistant professor of chemical engineering at the University of California, Santa Barbara, argue that these fungi should not be dismissed so readily. For one thing, the analyses that detect low concentrations of gut fungi test only liquid samples. “But the anaerobic fungi we’re interested in are almost always

found burrowed into the cellulosic fibers they're digesting," says O'Malley (see the image on page 17). Indeed, analyses that include both liquid and solid fractions show that fungi can be up to 20% of the microbial population.

Moreover, those fungi are thought to be among the most efficient and robust known digesters of "lignocellulosic" material—that is, not only cellulose but also other materials that occur with it, notably hemicellulose and lignin, polymers in plant cell walls that are extremely tough and can block access to the cellulose itself, further complicating its breakdown. In anaerobic fungi, the activity of key enzymes is aided by the action of mycelium—branching, thread-like filaments that can penetrate the plant material and break it up mechanically. While fungi may not be the dominant microbial population in the digestive tract, they clearly play a major role in degrading cellulose in the gut.

Given anaerobic fungi's remarkable capabilities and their potential compatibility with yeast, Kaiser and O'Malley decided that they should learn to work with them. In winter 2011, O'Malley spent five weeks at a laboratory in the United Kingdom studying with Professor Michael Theodorou, now of Durham University and the Centre for Process Innovation, UK—one of a "handful of people in the world" who could teach her the skills and techniques needed to isolate, classify, and culture these challenging organisms.

### First steps, new challenges

To start out, the MIT team aimed simply to determine whether genes from fungi would express cellulolytic enzymes in yeast. For the screening, O'Malley inserted known cellulolytic genes from

the best-understood type of ruminal fungus, *Piromyces*, into yeast, where they grew and expressed the enzymes of interest at high levels. However, some of the expressed enzymes were not reactive toward cellulose, and it was difficult to determine why not. O'Malley and Kaiser agreed that they needed to better understand how the cellulolytic enzymes are made and operate in their native environment—that is, inside *Piromyces*.

In fact, for the best outcome, they needed to understand that process in detail. It takes at least three types of enzymes to cut cellulose polymers into shorter segments. If those enzymes acted by random collision with the cellulosic material, the process would be extremely inefficient. To speed things up, over millions of years, gut bacteria and fungi learned to assemble groups of enzyme-producing genes on a supporting molecule called a scaffoldin. Kaiser likens this overall structure—the cellulosome—to a workbench on which the genes are tethered and spaced so that the expressed enzymes can degrade all components of the cellulose fibers synergistically.

Ideally, the researchers would replicate the assembly and operation of such fungal cellulosomes inside yeast. But first they needed to define the composition and structure of complete cellulosomes in *Piromyces*—a task best accomplished in a pure sample of the fungus.

To prepare such a sample, O'Malley collected feces from a horse called Finn at Verrill Farm Stables in Concord, Massachusetts. Finn eats only grass and hay, so his digestive system is well tuned for cellulose destruction and his feces are high in cellulose-degrading

microbes. To begin, O'Malley grew samples on grass plus antibiotics to suppress the growth of both bacteria and bacteria-consuming protozoa. She then withdrew a small sample from the mixture and grew it in the presence of cellulosic substrates. Performing that process several times over two months yielded an "isolate"—a single type of fungus that appears to be a new species of *Piromyces*, never before characterized or named.

To search for cellulolytic enzymes and cellulosomes in the new species, the researchers are exploiting a natural process called catabolic regulation. In general, organisms will not expend the energy to produce enzymes for digesting difficult materials like cellulose if they have available something easier to digest, such as glucose. "So we can get the organism to tell us what its most valuable enzymes are for breaking down cellulose," says O'Malley. Accordingly, she is growing some fungi on glucose—a setup that should turn off the genes required for cellulose destruction. Other samples get only cellulose, which should switch on all those genes for maximum expression. The cultures that result will give her a "logical, focused way to hunt for the actual enzymes and cellulosomes that are important to the organism for degrading cellulose," says O'Malley—perhaps including some that are new and radically different from those known to date.

### Genetic analysis

The next step—now ongoing—is to define the important genes and groups of genes and where they occur on the DNA of the organism. The good news, says Kaiser, is that he has MIT colleagues nearby who are among the world's leading experts at accom-

## Variation in fungal growth on different substrates

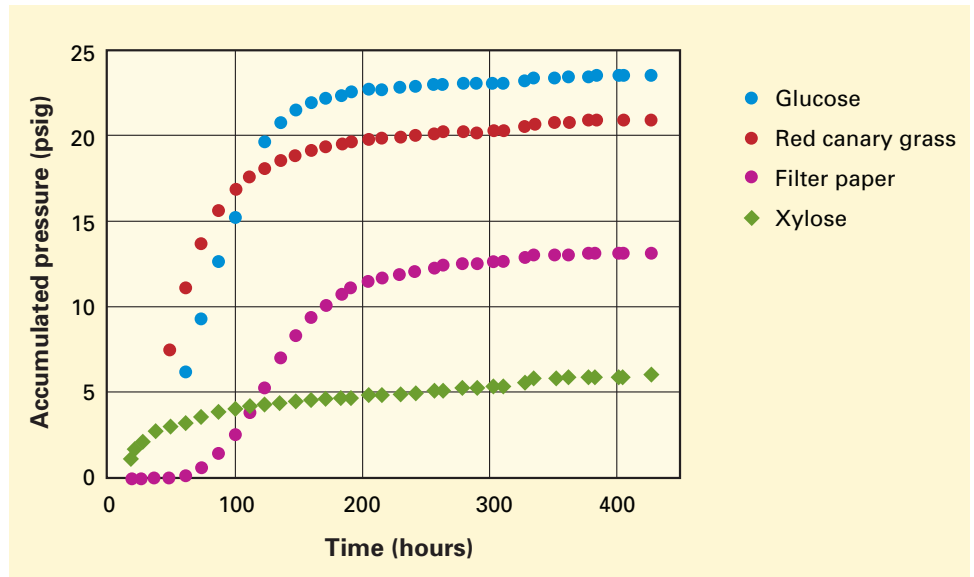

These curves show how quickly anaerobic gut fungi grow on various substrates. (The growing fungi generate gaseous byproducts that increase pressure inside the closed test tube. Accumulated pressure is therefore an indicator of growth rate.) As expected, growth is fastest on easy-to-digest glucose and slowest on xylose, a precursor to hemicellulose found in tough plant walls. Analysis of these cultures will help the MIT researchers determine which enzymes are switched on for digestion of specific substrates, including recalcitrant materials present in cellulosic biomass.

plishing those tasks. Researchers in the MIT BioMicro Center are performing next-generation genome sequencing of O'Malley's samples, specifically, of the messenger RNA (mRNA), which are copies of the sections of the DNA responsible for making enzymes. However, the genetic readings will represent isolated snippets of mRNA rather than full genes, so another task is to figure out which snippets belong together. At the Broad Institute of MIT and Harvard, Aviv Regev, associate professor of biology, and her team have developed new "assembly algorithms" that are ideally suited to performing that reconstruction. "Taken together, these methods will give us a concise inventory of what's there because the mRNA copies only the part of the DNA needed to make the enzyme," says Kaiser. "And the number of copies present tells you something about the level of expression. There should be many, many more copies of the mRNA corresponding to the cellulolytic gene in the sample growing on cellulose than in the sample growing on glucose. It's a very powerful approach."

One more technique being brought to bear is cluster analysis. A computer can be programmed to examine the millions of data points from genetic studies and look for correlations in expression levels. With no regard for other factors, it simply groups genes that are expressing at the same level—an indication that those genes are being "co-regulated" by the organism and are therefore likely to function together on some level. Based on that assumption, a group including known cellulolytic genes could also include unknown ones, among them perhaps some components of the cellulosome.

While O'Malley is studying the genes in a single pure fungus, others in Kaiser's lab are using similar methods to quantify the expression of specific gene families in complex mixtures that are good at digesting cellulose. From there, they can extract novel genetic sequences of interest, insert them into yeast, and examine the enzymatic activity that results—a method of discovering promising new genes without having to identify or culture their parent organisms.

"The beauty of this approach is that we could find cellulolytic genes that come from organisms we can't grow in the laboratory," says Kaiser. "This is one of the exciting new areas in microbiology. It's a way of circumventing the limitation of the classical approach in which you can only study things you can culture—and that's just a small fraction of the living things that are out there." Taken together, the new MIT activities should expand the list of known organisms and enzymes that degrade plant material into fermentable products—whether in the digestive

system of a horse, in the muck on the floor of a pond, or in a biofuels manufacturing plant.

• • •

By Nancy W. Stauffer, MITEI

This research was supported initially by a seed grant from the MIT Energy Initiative. Postdoctoral fellow Michelle O'Malley was subsequently supported by a Whiting Foundation Fellowship and a US Department of Agriculture–National Institute of Food and Agriculture Postdoctoral Fellowship. A travel fellowship from the Company of Biologists supported her work with Professor Michael Theodorou at Durham University and the Centre for Process Innovation in the United Kingdom. Further information can be found in:

M. O'Malley, M. Theodorou, and C. Kaiser. "Evaluating expression and catalytic activity of anaerobic fungal fibrolytic enzymes native to *Piromyces sp E2* in *Saccharomyces cerevisiae*." *Environmental Progress and Sustainable Energy*, vol. 31, no. 1, pages 37–46, April 2012.

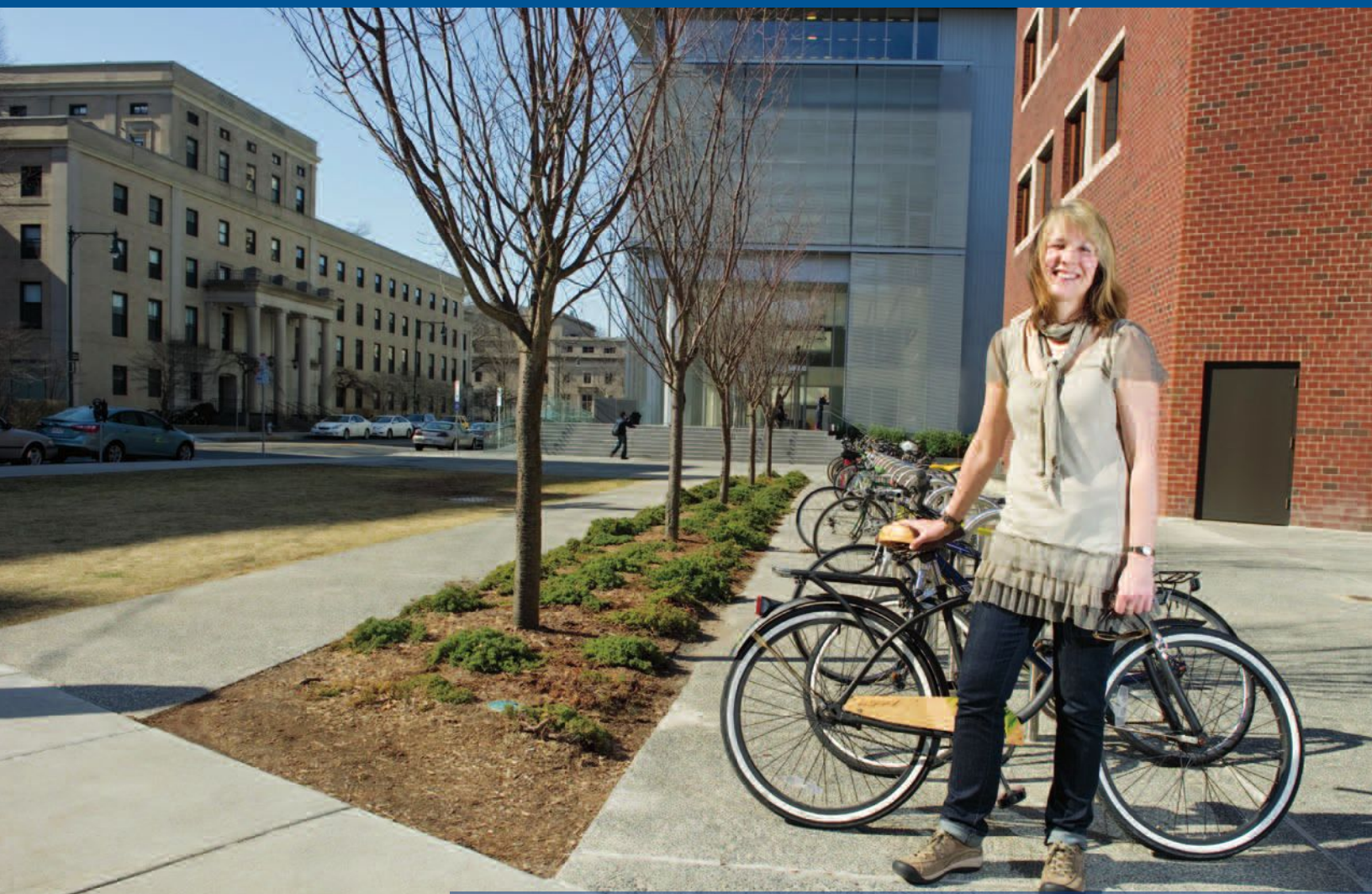

## Programs for green cities

### Finding out what works

**Judy Layzer of urban studies and planning is exploring why programs such as bike sharing and tree planting are working well in some cities and not so well in others—and how cities can best learn from one another's experiences.**

**This research was supported by a seed grant from the MIT Energy Initiative. Information about follow-on funding and a publication can be found on page 23.**

Photo: Justin Knight

In cities across the country, bike-sharing plans, tree-planting initiatives, and other programs aimed at enhancing urban sustainability are becoming increasingly popular. As mayors consider how to design and implement their own programs, they can turn for guidance to a series of MIT assessments of what kinds of programs have worked—and not worked—in other cities and why. The MIT director of the assessment project is now developing a systematic, user-friendly method of presenting this information as well as a protocol that will permit easy or even automatic updating of the content. Her next task: determining the environmental benefits that actually accrue from specific urban sustainability programs.

Urban sustainability program areas

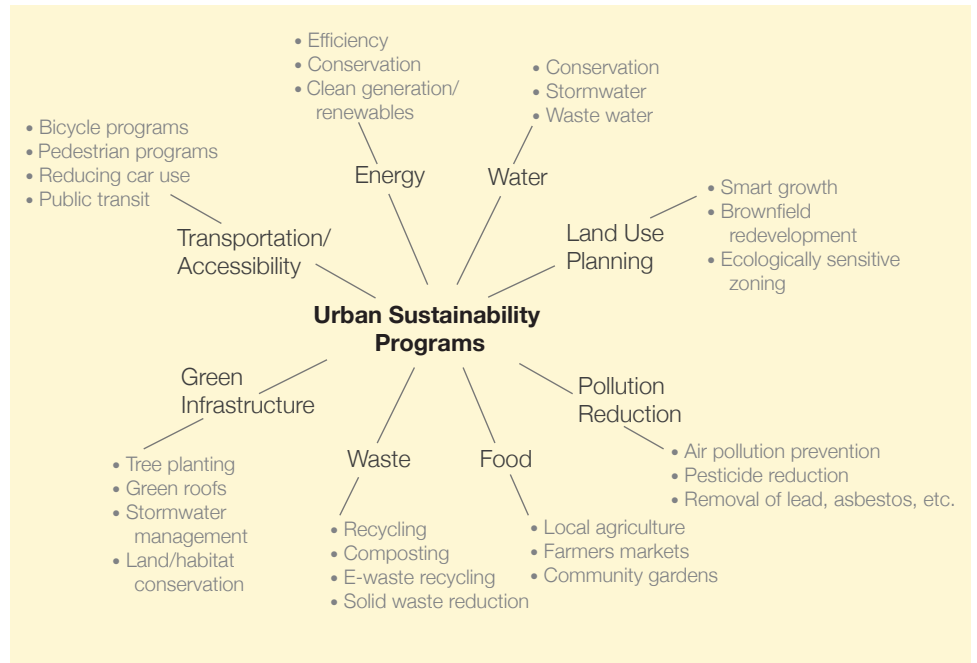

Diagram: Stephanie Stern MA '11, MIT

At one time, cities were seen as dark, dirty hubs of consumption, degrading to both people and the environment. But recently, environmentalists have recognized that dense, compact cities are, in many ways, environmentally friendly. For example, people reside in relatively small spaces and close together; shared walls and short travel distances make for efficient energy use. What is more, urban leaders have stepped in where national-level politicians have been unwilling to act. As a result, cities are now leaders in the pursuit of sustainability. More than 1,000 mayors have signed the Mayors' Climate Protection Agreement, vowing to meet the targets of the Kyoto Protocol. While that agreement was initially a response to federal inaction on climate change, city leaders have since realized that "being green" has multiple benefits: It makes cities more sustainable, enhances their livability, and attracts new residents, drawing people back into urban areas that are inherently more efficient. "By the mid-2000s, US cities were competing to see who could be the most green," says Judy Layzer, associate professor of environmental policy and head of Environmental Policy and Planning in MIT's Department of Urban Studies and Planning.

Many US cities are now devising and implementing sustainability programs aimed at everything from increasing bicycle use to expanding renewable power generation to cleaning up and conserving water. In 2008, Layzer became intrigued with such urban programs. Supported by a seed grant from the MIT Energy Initiative, she began to develop the first systematic assessment of ongoing sustainability programs—a source of integrated information that city leaders interested in sustainability will find invaluable.

"Imagine that you're a mayor and you want to start a bike-share program," says Layzer. "If it fails, you don't get to try it again. Politics is very unforgiving." To design the best possible program, you would read case studies, search the Internet, and call your mayoral counterparts in other cities. But that is a scattershot way to gather information. When Layzer's work is finished, you will instead consult a website created by her group and find a systematic analysis of how different approaches have led to different results in different settings or contexts.

**Gathering data**

To begin, Layzer assembled a team of students to assess five types of programs: tree-planting, light-rail systems, green stormwater infrastructure, urban parks, and composting. Each assessment started with a careful selection of US cities to target—some that have effective programs, some that have less-effective programs, and some that have tried and failed. The students then reviewed relevant documents and performed in-depth interviews to get details about the design of each city's program; the political and social factors that may have affected its

implementation; how program officials overcame any obstacles (if they did); and the program's actual operation. After more than a year's work, the students are now finalizing their assessments and thinking about how best to present the information they gathered.

Two examples demonstrate what a city leader can learn from the assessments. Suppose you want to start a tree-planting program—a good way to improve local air quality, reduce the need for cooling, and enhance the livability of your city. You face two big problems: inadequate funding and finding places to plant thousands of new trees. Giving away seedlings at public events might seem an effective and popular way to deal with both of those problems—but the MIT assessment of tree-planting initiatives shows that others have run into trouble with such programs. In Los Angeles, for example, a tree giveaway elicited a public outcry and unfavorable press citing the irresponsibility of giving away trees that would end up in people's apartments or trash or—if they were actually planted—left to die untended. Portland required recipients to pay a small fee to show their commitment

to planting and maintenance, but then there were few takers. One place to watch is Philadelphia, which has been piloting various tree-giveaway models to test what works and what doesn't before initiating a large-scale effort. Several cities are undertaking demonstration plantings at publicly controlled sites such as libraries to show people the benefits of trees and build community support. (See below for a summary of tree-siting methods and strategies for success.)

Now consider a program to install a light-rail system—a move that could help relieve highway congestion, expand commuting choices, reinvigorate urban centers, and more. You know that getting voter approval to fund and implement the new light-rail line will

be difficult. According to the MIT assessment, you can increase your odds of success by having a referendum that addresses multiple transportation modes rather than just light rail. But your best bet is to use existing funds to build a demonstration line and then present a referendum to fund future expansion. In Dallas and Salt Lake City, for example, people who initially opposed light-rail construction in their communities saw the success of the initial line elsewhere and subsequently lobbied for an extension into their areas. To improve your chances of winning over voters, you should place your new line on a corridor with many potential riders, avoid delays and cost overruns during construction, and involve the affected community in the design process.

**General advice for planners**

What general messages can mayors glean from the work to date? According to Layzer, a critical first step is to know your city. "The part I find fascinating that's not often discussed or researched is all the ways that implementation can fail because you didn't think about some aspect of the target—the entity whose behavior you're trying to influence," she says.

One key variable is a city's attitude toward environmental action. San Francisco, Austin, Boulder, and Minneapolis, for example, are thought to have a strong environmental ethic, which may contribute to those cities' ability to adopt aggressive sustainability policies. Indeed, in some cases, environmental ethic may trump other seemingly obvious influences, such as climate. Minneapolis, for instance, has cold, snowy winters and yet is a leader in bicycle programs; when winter comes, the bike-share stations are simply removed until spring.

The propensity to accept or resist rules may also influence the form of a city's programs. New York, for example, has a culture of rules, fines, and compliance. In 2009, New York City instituted a rule prohibiting retail establishments that are running air conditioners from propping their doors open on hot days. Few stores complied—until the city began fining stores and issuing warnings, and compliance began to rise. "If you tried that approach in San Diego or Houston, you might get a lot more pushback," says Layzer. In such cities, successful environmental programs are more likely to take the form of incentives or education than mandates.

**Tree-siting methods and strategies for success**

Method	Strategies
Tree giveaways	<ul style="list-style-type: none"> <li>• Use sparingly</li> <li>• Test pilot models</li> <li>• Charge small fees to boost commitment</li> <li>• Use more established trees</li> <li>• Piggyback on street tree effort</li> <li>• Collect contact information</li> <li>• Conduct follow-ups via email</li> <li>• Conduct 10% random sample site visits</li> </ul>
Tree rebates	<ul style="list-style-type: none"> <li>• Advertise widely through community partners, libraries, recreational centers, etc.</li> </ul>
Right-of-way planting	<ul style="list-style-type: none"> <li>• Use opt-out strategies instead of opt-in</li> <li>• Develop educational and public engagement projects through community partners in target neighborhoods</li> <li>• Focus initial program resources on replacement planting and public sites to build community support</li> <li>• Plant with contractual maintenance</li> </ul>
Other	<ul style="list-style-type: none"> <li>• Provide incentives to large private landholders</li> <li>• Form planting agreements with other municipal landholders</li> <li>• Look for project synergies with other agencies</li> </ul>



In the end, different variables and city attributes matter for different kinds of programs—a complicating factor that the MIT teams try to address in their assessments. “One thing we talk about is that for this policy area, these kinds of city attributes can really matter,” says Layzer. “So it may be in the realm of, say, bike planning, New York can learn from Minneapolis but not from Chattanooga.” And while putting values on such attributes as environmental ethic may seem subjective, Layzer believes that long-term residents have a “pretty accurate sense” of their city’s culture and what would work and what would not.

### Continuing work

Layzer and her team are now grappling with how best to present the assessment information so that people can use it and learn from it. Her goal is to produce a series of web-based tools that gives the visitor easy access to relevant, action-oriented analyses incorporating prose, graphics, and links to detailed supporting information. When those tools are available, she will ask various sustainability organizations to post them so that others can use, refine, and expand them.

She is also seeking a means of constantly updating the data so as to generate new assessments and analyses every few years. Her original concept was to have cities and students collaborate. “Cities have no money, but there are lots of universities with students who want real-world experience,” says Layzer. But as her own experience has shown, students have many demands on their time, and progress can be slow—and that is a problem for urban planners. “Wait too long and the political moment will have passed,” notes Layzer. She

is hoping to speed the process by incorporating methods of automated data collection. “While the time-consuming, labor-intensive interviews would still be necessary, certain types of data could be collected automatically that could tell you a lot about a city,” she says.

Once she’s finished “inventing the method” and others are using and improving it, she plans to move onto the next piece: determining whether urban programs actually make a difference. It may seem obvious that they would—but perhaps not always. For example, if people get appliances that are more energy-efficient, they might use them more, causing overall energy use to increase rather than decrease. Similarly, the energy and environmental gains from requiring new buildings to be green may be less than predicted if those buildings are not used as efficiently as possible. Layzer recognizes that establishing a clear link between sustainability programs and measurable environmental impacts will be tricky. “You have to be clever about what you measure and how you figure out whether it was the program that caused the outcome or not,” she says. “It’ll be a totally different kind of challenge, but I think it’s worth a try.”

• • •

By Nancy W. Stauffer, MITEI

This research was funded by a seed grant from the MIT Energy Initiative. Work continues under a grant from the Summit Foundation. Further information can be found in:

J. Layzer and S. Stern. *What Works and Why? Evaluating the Effectiveness of Cities’ Sustainability Initiatives*. American Political Science Association Meeting, September 2–5, 2010, Washington, DC. Available at [papers.ssrn.com/sol3/papers.cfm?abstract\\_id=1644156](http://papers.ssrn.com/sol3/papers.cfm?abstract_id=1644156).



## Reaching underground resources

Accessing critical resources such as geothermal energy and natural gas requires drilling—an expensive, energy-intensive, messy process with today’s technology. An MIT team has been looking into a more elegant approach. Instead of grinding rock to bits, they would use a continuous beam of energy to vaporize it and then blow out the tiny particles that form with a high-pressure stream of injected gas. Using a novel experimental setup and a device used in fusion experiments, the researchers have now vaporized rock for the first time. Based on their experimental and theoretical findings, they conclude that the energy generated by that device—beams of millimeter-long waves—could do what lasers have never done: serve as a cost-effective, efficient means of drilling our way to a cleaner and more sustainable energy future.

# Vaporize the rock—no drilling required

Using a device borrowed from fusion research, Paul P. Woskov of MIT’s Plasma Science and Fusion Center has vaporized rock for the first time, confirming the feasibility of his proposal to use energy beams rather than drill bits to access underground energy resources.

This research was funded by a seed grant from the MIT Energy Initiative. For information about follow-on funding and a publication, see page 27.

Photo: Justin Knight

## Practical implementation of millimeter-wave drilling concept

Within the United States, the top 10 kilometers of the Earth's crust contain vast geothermal resources that could increase near-term energy supplies, improve energy security, and reduce greenhouse gas emissions. However, the high cost of drilling hampers the economic exploitation of those resources. According to a 2006 MIT assessment, drilling is responsible for at least half the cost of tapping into geothermal energy. Drilling also plays a key role in the recovery of other energy resources, including the vast deposits of unconventional natural gas recently developed in the United States. Despite the importance of drilling, research to advance the technology focuses largely on improving mechanical approaches—better cutting bits for rotary drills or improved methods of steering—which at best will lead to small, incremental improvements in a mature technology.

“What’s really needed is to look at some new technologies that could potentially make a much bigger breakthrough in the capability for drilling—one that would increase the speed of drilling and lower the cost,” says Paul P. Woskov, senior research engineer at MIT’s Plasma Science and Fusion Center (PSFC). Drilling solely with a directed beam of energy such as a laser would have obvious advantages: There would be no mechanical systems in the borehole to break or wear out, no temperature limit, and equal ease penetrating any type of rock at any depth. But almost five decades of research on laser drilling have not produced a practical system. Indeed, nobody has ever drilled a hole deeper than about a meter using only a laser.

Several years ago, Woskov suggested something that might work better: a beam of electromagnetic radiation with a wavelength of one or a few

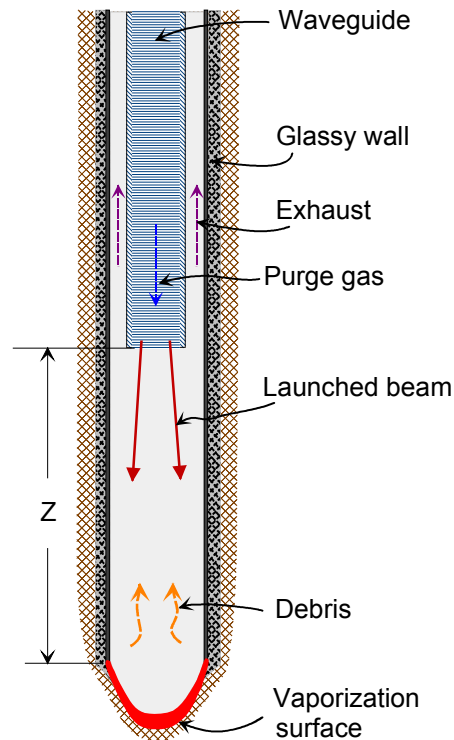

**This diagram shows a circular borehole with a metallic waveguide inserted down its center. A beam of millimeter waves launched from the top travels down through the waveguide and emerges to melt and vaporize the bottom of the borehole. A purge gas injected through the waveguide solidifies the vapors into nanoparticles and then blows them from the bottom upward along the outside of the waveguide to the surface. The beam also heats the walls of the borehole, making them glassy and strong enough to prevent collapse, even under high pressures.**

millimeters—1,000 times longer than the typical wavelengths of infrared laser beams. Most engineers are not aware of “millimeter waves,” but in fusion research—Woskov’s field for 30 years—they are critical for heating and controlling plasmas to the extreme temperatures needed for fusion to occur.

The devices used to produce such waves—called gyrotrons—are highly developed. They can generate a megawatt or more of millimeter-wave power continuously at energy conversion efficiencies of 50%. In contrast, lasers

are typically about 10% efficient and do not achieve such high power output when operating in continuous mode. Moreover, continuous-wave, 1-megawatt gyrotron systems are commercially available, rugged enough for field use, and potentially readily adapted for drilling. And some of the world’s leading designers of gyrotrons are located in the PSFC.

In late 2008, Woskov and Dan Cohn, a PSFC research scientist who is now at the MIT Energy Initiative (MITEI), received a seed grant from MITEI to investigate Woskov’s novel concept. Results of initial theoretical analyses confirmed the validity of Woskov’s idea—so convincingly that he received a follow-on grant from MITEI, attracted new MIT and industry collaborators, and received major funding from the geothermal division of the US Department of Energy.

### Promising theoretical results

The diagram on this page presents a practical design for Woskov’s concept. The cross section shows a circular borehole, with the vaporization front at the bottom. A metallic waveguide inserted into the borehole directs a millimeter-wave beam from a gyrotron as well as an injected “purge” gas such as air or nitrogen. When the beam reaches the bottom of the borehole, it vaporizes the rock. The vapors formed are quickly cooled by the purge gas and solidify into a plume of nanoparticles. The purge gas blows that debris upward, around the outside of the waveguide, to the surface. Conventional filters cannot capture such tiny particles, so the exhaust would then be bubbled through a collection pond to trap the solids. Recycling the nanoparticles is also a possibility. The particles would

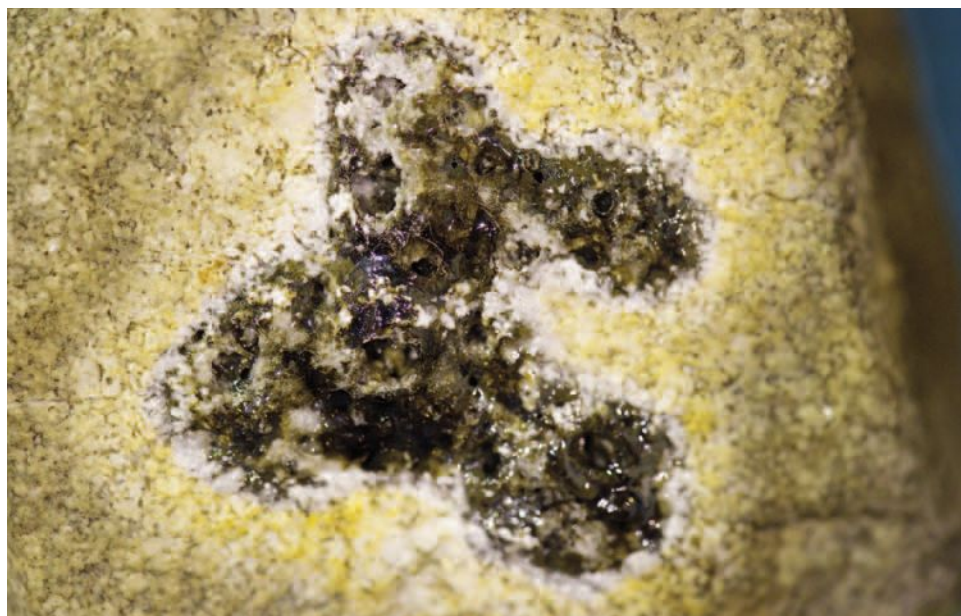
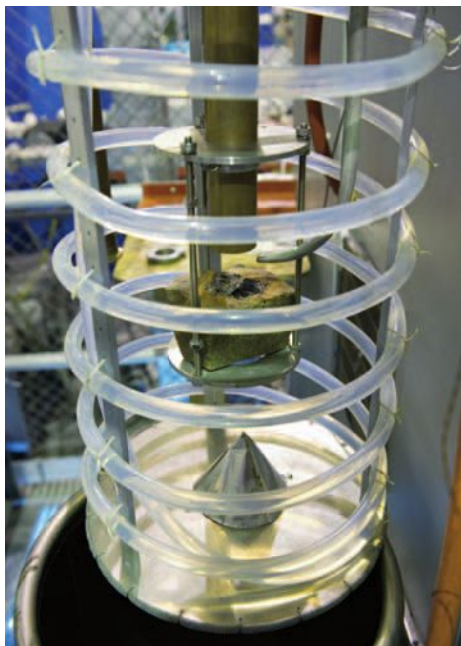

Photos: Justin Knight

**Left:** In this setup, a gyrotron at the top sends a continuous millimeter-wave beam through the copper tube toward the rock sample at the center, and water flows through the surrounding coil. During operation, the device is lowered into the steel chamber below and sealed. Based on the flow volume and temperature rise of the water, the researchers can deduce how much of the incoming energy is absorbed by the rock. **Above:** The dark pattern on this granite sample shows where the beam hit the rock, causing it to bubble and vaporize. The new setup enabled the team not only to vaporize rock for the first time but also to take real-time measurements that provided new insights into key thermodynamic properties of rock up to extremely high temperatures.

be rich in silicon dioxide—a major constituent of vaporized rock—so they could prove valuable to the electronics industry as feedstock for making circuit chips.

Key to this design is the behavior of the millimeter-wave beam. As it emerges from the waveguide, it naturally diverges. It therefore heats up the walls of the hole and makes them glassy, turning the borehole itself into a waveguide that can be effective for kilometers. The glassy walls also seal the borehole as it develops, protecting the underground formation and preventing undesirable leaks. In addition, today's waveguides for transmitting millimeter-wave beams can be adjusted to concentrate energy at the beam's edges or center or some combination of the two. That choice, along with the power level, determines the borehole dimensions and rate of penetration. Put more energy at the beam's edges, and the hole is wider; put more energy in the center, and the hole gets deeper faster. Such beam control cannot be easily achieved when

drilling with a stationary laser beam, which inevitably creates a hole that gets narrower with distance.

To investigate the viability of millimeter-wave drilling, the researchers performed theoretical analyses of the energy required to heat solid rock until it not just melts but completely vaporizes. Based on those results, they concluded that—unlike a laser—an off-the-shelf gyrotron could cost-effectively deliver enough energy to vaporize rock.

The analyses also confirmed another advantage of millimeter waves: They would pass efficiently through the outward-flowing micron- and submicron-sized particles. When bombarded by particles of that size, energy beams with relatively short wavelengths such as lasers readily scatter. That scattering effect drops off as wavelengths get longer. As a result, the beam of millimeter waves would remain far more cohesive and could deliver more of its energy to the drilling surface.

### New experiments, new insights

Given the novelty of the approach, theoretical analysis was not enough. Woskov needed experimental evidence. So he borrowed a 10-kilowatt continuous millimeter-wave gyrotron system used at the PSFC for fusion research and—with help from several PSFC experts—set up an experiment to melt and vaporize rock.

To challenge his concept, they tested one of the hardest, most difficult-to-drill crystalline rocks—granite. They placed the rock inside a specially built test chamber (above left), just below the opening of a copper tube that served as a waveguide, and switched on the gyrotron at the top. The millimeter-wave beam quickly melted and vaporized the rock. Using sensitive diagnostic instruments, they monitored the temperature of the rock's surface as it became mushy, melted, and finally vaporized. The photo above shows the result: an irregular black area of glass melt that has bubbled up and flowed out under the beam.

Woskov was pleased with their experiments for two reasons: “Not only did we vaporize rock for the first time,” he says, “but we also demonstrated a new laboratory technique that combines localized, high-power heating with sensitive measurements of the dynamics of the material being heated to extreme temperatures—much higher than you could get to in the past in real time.”

The new experimental results brought an unexpected observation: Hot molten rock absorbs millimeter-wave energy far more efficiently than it absorbs infrared radiation from lasers. Thus, as a drilling tool, a millimeter-wave beam has two advantages over lasers: It is less disrupted by outgoing particles, and the energy it delivers is more efficiently absorbed by the melted rock surface. Woskov stresses the importance of those findings for minimizing cost. For a drilling technology to be economical it needs to deliver as much energy as possible to the drilling surface, and the drilling surface needs to take up that energy efficiently.

Based on their new thermodynamic measurements, the researchers estimate that they will be able to drill through hard crystalline rock at rates of up to 100 meters per hour—10 times faster than with current mechanical drilling systems in deep holes. The cost per cubic meter of rock removed (in this case, primarily the cost of electricity) would be lower than with conventional methods and should remain constant with depth, independent of rock hardness or temperature.

### Convincing the industry

For industry audiences, a key source of skepticism about the proposed approach is the absence of “drilling

muds”—fluids that are carefully tailored to both remove debris and strengthen the walls by plugging up pores in the rock and providing back pressure that counters inward pressures on the hole. “Deep drilling without drilling mud is unheard of,” says Woskov. Yet he suggests that the glassy, or “vitrified,” walls in his system could be strong enough not only to keep the hole open during drilling but also to withstand the extreme pressures on the finished borehole with no added cement or metal liner.

In the next three years, Woskov and his collaborators will be testing those claims. Their project, now under way, is led by Impact Technologies (Tulsa, Oklahoma), a company with extensive experience and expertise in drilling and related applications in the field. At MIT, Woskov’s group is continuing to investigate the impacts of millimeter waves on rocks; and Herbert H. Einstein, professor of civil engineering, and his group in the MIT Rock Mechanics Laboratory are testing the behavior of the vitrified samples under extreme pressures comparable to those encountered by a borehole. If all goes well, three years from now the MIT and Impact teams will test the millimeter-wave system in an existing borehole, inserting a waveguide, launching a beam, and vitrifying the walls of the hole.

Woskov is pleased to have a drilling company interested in one aspect of his concept—using millimeter waves to seal and strengthen borehole walls. “If we get into one niche of the current established process, we’ll have a foot in the door with this technology,” he says. Given that foot in the door, he is confident that the drilling will come later.

“I think we have the potential to revolutionize drilling, but it’s a completely new approach that will throw out a lot of conventional wisdom. That’s the problem,” says Woskov. He likens it to the 1940s when the aircraft industry was working with mechanical rotary engines and propeller technologies. When the jet engine came along, it was a completely new approach that took away all the mechanics and worked on a jet stream of air. Says Woskov, “It’s the same thing. Drilling technology is in the mechanical age right now, and we want to move it into the jet age”—in this case, the age of directed energy.

• • •

*By Nancy W. Stauffer, MITEI*

This research was supported initially by seed grants from the MIT Energy Initiative. Continuing work is being supported by the US Department of Energy under a subcontract from Impact Technologies (Tulsa, Oklahoma). For further information on the research, see:

P. Woskov and P. Michael. “Millimeter-wave heating, radiometry, and calorimetry of granite rock to vaporization.” *Journal of Infrared, Millimeter, and Terahertz Waves*, vol. 31, no. 1, pages 82–95.

# MIT Energy Initiative announces latest seed grant awards

The MIT Energy Initiative's latest round of seed grants for energy research is supporting early-stage or novel work in areas including energy and water, hydraulic fracturing, solar energy, biofuels, energy storage, electricity generation and distribution, and building systems.

A total of \$1.9 million was awarded to 13 research projects lasting up to two years. The funded projects span eight departments and three schools.

As in the past, the call for proposals welcomed submissions on any energy-related topic, but this year it expressed particular interest in proposals addressing the energy-water nexus. In response, proposals were submitted on water desalination, oil-water interfaces, and water use and recovery during natural gas and oil development. Six of the water-related projects were funded. The table on page 30 lists all the funded projects, some of which are highlighted in the following paragraphs.

- The effectiveness of enhanced-oil recovery (EOR) techniques depends critically on the use of surfactants to reduce tension at oil-water interfaces. However, the optimal surfactant formulation for a given EOR application depends on the selection of surfactants and the specific reservoir conditions. Daniel Blank-shtein of chemical engineering is developing a computational methodology that can predict the effect of a specific surfactant formulation on interfacial tension at the molecular level, given only the chemical structure of the surfactant molecules and key reservoir conditions. The new computational methodology will expedite the search for the best surfactant(s) for a given situation and will also provide fundamental knowledge that may lead to further advances in EOR techniques.
- Mircea Dinca of chemistry is working on porous materials specially designed for use in water desalination and in adsorption-based heating and cooling systems. One promising class of such materials is metal-organic frameworks (MOFs)—crystalline materials with large surface areas, extensive free internal volumes, and nanometer-range pores whose size and surface composition can be tuned to modulate the energy of their interaction with water. Despite these attractive features, MOFs are rarely explored as adsorbents for water because most decompose when exposed to moisture. Dinca is formulating new molecular building blocks that will help mitigate the water sensitivity and make possible the development of water-stable MOFs tailored for use in water-adsorption-based devices.
- Eugene Fitzgerald and Mayank Bulsara of materials science and engineering are advancing methods of making multi-junction solar cells on silicon (rather than germanium) substrates for use in terrestrial solar concentrator systems—an approach that will combine high efficiency with low cost and enable more advanced solar power system-level concepts. Key components are a multi-junction solar cell made with novel materials and band gaps, and a graded-layer technology that will prevent the high defect formation that usually occurs when solar cell stacks are deposited on silicon substrates. The researchers will also pursue a novel solar cell architecture and integration sequence aimed at achieving voltage-matching of the sub-cells, thereby reducing the power losses and voltage drops associated with traditional designs.
- Cullen Buie of mechanical engineering and Martin Bazant of chemical engineering are developing a high-efficiency hydrogen bromine battery for large-scale energy storage. Their innovative design relies on laminar flow—layers of fluid flowing in parallel without mixing—to separate the reactants. This approach eliminates the membrane separator that poses technical challenges in conventional electrochemical cell design. Other benefits include the superior mass transfer characteristics of concentrated liquid bromine and the fast reaction kinetics of hydrogen-halogen electrochemistry. Given its potential ultra-high power density and low cost, this technology could be a game-changer in large-scale energy storage—and perhaps in the economic viability of intermittent power sources such as solar and wind.
- Commercial buildings and data centers are filled with direct current (dc) loads such as computers, electronic devices, and lighting. Supplying electricity to such sites from a dc power distribution system rather than the alternating current (ac) power grid could significantly cut energy losses. To support that practice, David Perreault and Khurram Afridi of electrical engineering and computer science are developing small dc-dc converters that can convert the incoming electricity to the significantly lower voltages required by computers, electronics, and LED lights. The converters will provide ultra-high efficiencies and high performance across wide ranges of input voltage and output power.

- To help urban planners and architects develop new urban sustainability concepts, Christoph Reinhart and Leslie Norford of architecture are developing improved methods of analyzing building energy use, water runoff patterns, and walkability in new and existing developments at the neighborhood and city scale. To support those analyses, they are expanding their current urban modeling interface by integrating models that can analyze local microclimates (including temperatures and wind pressures on buildings) and three-dimensional (rather than flat) terrains. They will evaluate their expanded tool by applying it to an urban energy model of Cambridge and by testing it in a new MIT class called Modeling Urban Energy Flows.
- Jing Kong of electrical engineering and computer science and Tingying Zeng of the Research Laboratory of Electronics propose a novel method of transferring graphene onto transparent, flexible substrates for energy-related devices—an alternative to the expensive indium tin oxide (ITO) now widely used. Their approach calls for using chemical vapor deposition to grow large-area graphene films on copper foil and then transferring the films onto the desired surfaces. They will investigate the chemical modification of the substrate surfaces for strong adhesion as well as possible ways to reuse the copper. If successful, their approach could be environmentally benign, cost-effective, and suitable for industrial applications.
- Much work has focused on using algae to produce high-energy lipid compounds that can be readily processed into biodiesel. These lipids are typically found within cells, and

efficiently extracting them has proved a challenge. Sallie Chisholm and Steven Biller of civil and environmental engineering are exploring a new approach inspired by their discovery that a common marine bacterium naturally releases lipids into the growth medium in the form of small vesicles—budded-off cellular material enclosed by a lipid layer (see the image on page 30). Biller is examining that cellular capability with a goal of developing a biofuel production scheme wherein the lipid-rich vesicles are collected from the medium without the need to harvest cells or separate lipids from the bulk biomass.

Funding for the new grants comes chiefly from MITEI's Founding and Sustaining Members, supplemented by funds from the Grantham Foundation, David desJardins '83, and John Bradley, and gifts from other generous alumni. Alumni contributions particularly serve to enhance the reach of the MITEI Seed Fund Program across campus.

To date, the Seed Fund Program has supported 103 early-stage research proposals, with total funding of more than \$12 million.

• • •

*By Karen L. Gibson and Nancy W. Stauffer, MITEI*

## Best poster awards



Photo: Justin Knight

**At a special poster session, Ernest Moniz (far right), director of the MIT Energy Initiative, announces the recipients of best poster awards. The session featured 23 posters describing research projects funded by MITEI seed grants.**

In conjunction with this year's seed grant review meeting, MITEI organized a day of oral and poster presentations on completed or nearly completed seed grant research projects. Three awards were given for best poster.

**Harold Au and Michael Boutilier, Mechanical Engineering:** "Graphene Membranes for Energy Efficient, Highly Selective Gas Separation"

**Lirong Broderick, Materials Processing Center:** "Multi-Scale Photonic Structures for Optimized, Highly Efficient LED Light Extraction"

**Ali Faghih, Electrical Engineering and Computer Science:** "Towards Efficient Integration of Renewables Using Energy Storage: Optimal Sizing and Management"

Awards were given for especially noteworthy poster presentations, judged on the basis of content and quality of presentation. The poster session and awards are held twice a year in conjunction with special events for the MITEI members that sponsor the Seed Fund Program.

## Recipients of MITEI seed grants, spring 2012

**Predicting interfacial tension reduction at oil-water interfaces to facilitate surfactant design for enhanced-oil recovery applications**

**Daniel Blankschtein**  
Chemical Engineering

**Hydrogen-bromine laminar flow battery for large-scale energy storage**

**Cullen Buie**  
Mechanical Engineering  
**Martin Bazant**  
Chemical Engineering

**A novel mechanism for production of energy-rich compounds from a minimal photosynthetic cell**

**Sallie Chisholm**  
Civil and Environmental Engineering

**Designer microporous materials for water desalination and adsorption heat pumps**

**Mircea Dinca**  
Chemistry

**High efficiency, low cost voltage matched solar cell circuits for solar concentration application**

**Eugene Fitzgerald, Mayank Bulsara**  
Materials Science and Engineering

**Nanoporous membranes for energy-efficient water desalination**

**Jeffrey Grossman**  
Materials Science and Engineering

**A new green method to transfer CVD graphene in large scale onto PET as alternative ITO substrate for energy-related device uses**

**Jing Kong**  
Electrical Engineering and  
Computer Science  
**Tingying Zeng**  
Research Laboratory of Electronics

**An analysis of the water sourcing and treatment requirements for unconventional natural gas and oil development**

**Francis O'Sullivan**  
MIT Energy Initiative

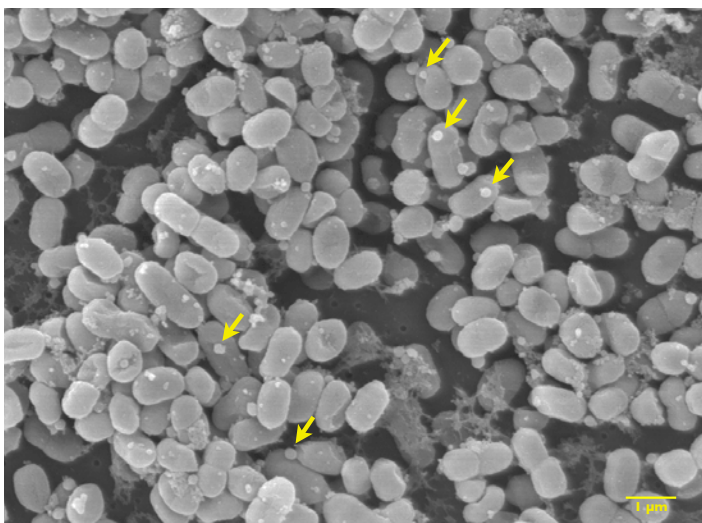

Image courtesy of Steven Biller, MIT

MIT researchers in the Chisholm lab discovered that a common marine bacterium naturally releases lipid vesicles, indicated by yellow arrows in this scanning electron microscope image. Such lipids could be removed for biofuel processing without needing to first extract them from a “parent” organism—a possibility being explored in a MITEI seed grant project (see page 29, last bulleted item). Even better, the bacterium grows on solar energy alone—no need to add organic carbon.

**Ultra-high efficiency power converter architecture for dc distribution systems**

**David Perreault, Khurram Afridi**  
Electrical Engineering and  
Computer Science

**Urban Modeling Initiative (UMI)—Operational building energy use, water runoff, and walkability in new and existing cities and neighborhoods**

**Christoph Reinhart, Leslie Norford**  
Architecture

**Direct solar to hydrogen conversion: Low-cost photoelectrodes**

**Harry Tuller**  
Materials Science and Engineering

**Enhanced clean water recovery in unconventional natural gas production**

**Kripa Varanasi**  
Mechanical Engineering

**Assessment of novel hydraulic fracturing fluids and proppants in unconventional gas production**

**John Williams,**  
**Christopher Leonardi**  
Civil and Environmental Engineering



# MIT and Tsinghua University launch the China Energy and Climate Project

Multiple forecasts suggest that rapidly developing nations such as China will be responsible for most of the growth in carbon dioxide emissions over the next 50 years. This expectation is the driving force behind the formation of the China Energy and Climate Project (CECP), which officially launched in fall 2011 and involves researchers from MIT and China.

The CECP will involve close collaboration and personnel exchange between the MIT Joint Program on the Science and Policy of Global Change and the Institute for Energy, Environment, and Economy at Tsinghua University in Beijing, China. In collaboration with the MIT Energy Initiative (MITEI), the five-year project is based out of MIT and directed by Valerie Karplus PhD '11, a recent graduate of MIT's Engineering Systems Division. John Reilly, senior lecturer in the Sloan School of Management, supports the project as co-director of the MIT Joint Program.

The goal of the CECP is to analyze the impact of existing and proposed energy and climate policies in China on technology, energy use, the environment, and economic welfare by applying—and, where necessary, developing—both quantitative and qualitative analysis tools.

The development and application of such new tools will include both national and regional energy-economic models of China. Growing out of the MIT Joint Program's Emissions Prediction and Policy Analysis (EPPA) model, these new tools will be informed by three major components: First, researchers will study the behaviors and trends that drive micro-level decisions made by households and firms to better understand supply and demand within energy-intensive sectors. Second, the



Photos: Valerie Karplus PhD '11, MIT

researchers will analyze specific technology prospects, including electric vehicles, advanced fuels, and alternative sources of electricity, to determine China's technology potential. Finally, current and proposed climate and energy policies in China will be evaluated for environmental and economic impact. These evaluations will be conducted primarily through the use of the models developed for the project, which will be based on similar methods employed in the MIT Joint Program over the last 20 years.

"We are building a strong trans-Pacific research team that brings expertise in economics, engineering, and public policy to this exciting new project," Karplus says. "Both sides are eager to develop a strong collaboration, to learn from each other, and to produce rigorous analysis on important policy questions."

The research carried out at MIT has four sponsors: MITEI members Eni S.p.A., ICF International, and Shell, and the Agence Française de Développement (AFD). The project will present its findings at an annual meeting in Beijing to influential



**Top: The Sino-Italian Ecological and Energy Efficient Building at Tsinghua University, which houses the offices of CECP's research partners in the Institute for Energy, Environment, and Economy. Above: Entrance to the Beijing Guozijian (国子监), the highest institution of learning in imperial China.**

members of the academic, industry, and policy communities in China. The project will inform dialogue on future climate and energy policy options in China and their global implications.

For further information and updates about the CECP, go to [globalchange.mit.edu/CECP](http://globalchange.mit.edu/CECP).

• • •

*By Allison Crimmins, Joint Program on the Science and Policy of Global Change*

# Paula T. Hammond: Making new materials, solving critical problems

Making things that didn't exist before. It was that possibility that initially led Paula T. Hammond, the David H. Koch Professor in Engineering, to study the sciences. Growing up in Detroit, she had a wide range of interests. She thought she might become a writer, but a chemistry course her junior year of high school gave her a glimpse into a possible future in science. "I was really intrigued by [the course] because it had a lab that allowed me to actually *make* new materials and look at color changes and transformations that were created just through chemistry," she remembers. Nowadays, Hammond has her own lab and is using materials science to create novel solutions to today's energy challenges. In exploring different material properties, she came to recognize that materials could have a major impact on a range of energy systems. Indeed, she believes that innovation in materials science could "allow us to get past some of the barriers that are known for batteries... for fuel cells...and for photovoltaic and solar applications. A lot of those limitations are materials science limitations."

To that end, much of Hammond's work involves creating and deploying polymers, a tool she first became interested in while an undergraduate at MIT. Broadly speaking, a polymer is a macromolecule made up of repeating structural units. Polymers can be either naturally occurring (natural rubber, cellulose) or synthetic (nylon, polyethylene) and can have a wide variety of properties and uses. Chemically modifying those polymers further expands the possibilities. "You can think of a polymer chain as something upon which you can hang different functional groups by attaching them to the side groups of polymers and still retain the property of the primary

polymer, which has a flexible backbone," she explains. Hammond is fascinated by the potential for using polymers to create dynamic, functional materials. "The fact that polymers can be extremely active—can be the active component in the system—always got me excited," she says.

To achieve the benefits of combined polymers, Hammond and her team have pioneered new methods of "layer-by-layer assembly." Normally, polymers do not mix readily. "The rules of thermodynamics are such that two large molecules have a very low driving force for mixing because there's no real gain in entropy—unlike with a bunch of small molecules mixing together," she explains. Her team's novel approach uses electrical charge to assemble macromolecules that have unique properties. Applying this design concept, they have greatly improved the performance of methanol fuel cells and of carbon nanotube thin films for battery electrodes.

The fuel cell work serves as a striking example of Hammond's research approach. Methanol fuel cells have many favorable characteristics: Methanol has high energy density, is easy to transport, and is much more stable than hydrogen, which is also used in fuel cell systems. But today's devices have a major drawback. The most commonly used electrolyte material—Nafion—efficiently carries ions from electrode to electrode, but it is expensive, and it is permeable to methanol, which causes fuel seepage and efficiency losses. To preserve the high ion conductivity of the Nafion membrane while reducing its permeability, Hammond and her team tried coating it with a thin film. They found that just six layers yielded a 50% increase in power—a major gain

requiring little material use. In collaborations with colleagues, her group is also developing a fuel cell with no Nafion at all. In its place they use a porous membrane coupled with a membrane interface of their own design and construction.

Clearly, Hammond and her group do not shoot only for incremental improvement. Indeed, they push themselves to the edge to develop novel systems—and then consider how to make them practical at large scale. Says Hammond, "With most of our systems, we're thinking about how we can go big. Can we roll this out—literally? Can we spray-manufacture a system that does this? Can we develop a system that uses a small amount of a unique or unusual material but gets high value and high gain from that small amount?"

For Hammond, part of the appeal of working with polymers is their aesthetic beauty and the thrill of interacting so closely with potent natural forces. Her PhD research—also at MIT—involved polymers that change color when they are stretched. "There's a visceral joy in watching that happen or in looking under the optical microscope and observing a liquid crystalline phase, which is just gorgeous," she says. "And the topper is...knowing that your research can have this huge potential impact on humankind. That makes you push to find the system that works."

Hammond relishes the fact that her neighbors on campus are similarly inspired. "The thing that gets me about MIT is that you can turn to your left or your right and you'll find someone interesting and engaging who's doing top-of-the-line work, who's at the edge, pushing a frontier, and you can engage with them and find something to work on," she says. Hammond has

Photo: Webb Chappell



**Paula T. Hammond,**  
the David H. Koch  
Professor in  
Engineering

been an active collaborator, notably teaming up with Angela Belcher, W.M. Keck Professor of Energy, and Yet-Ming Chiang, Kyocera Professor of Ceramics, to develop and construct microbatteries using, for the first time, a microcontact printing and virus-based process to assemble the battery's anodes. "It's an extremely collaborative community and also a continually stimulating one," she says with a laugh. "Some days you almost get a little overwhelmed by how stimulating it is."

Recently, Hammond was part of a faculty team, led by colleague Clark Colton, professor of chemical engineering, that developed a new class for undergraduates. In 2009, the Energy Education Task Force launched MIT's new Energy Studies Minor and was looking to expand the set of interdisciplinary, energy-related, project-based classes. Hammond worked with Colton and others to put together a curriculum for 10.27, Energy Engineering Projects Laboratory. Each faculty member devised plans that would both draw on ongoing research and engage students from across the

Institute. In Hammond's case, the students worked on the methanol fuel cell, a front-line project. "It ended up being a really synergistic group because we got to talk about fundamental engineering questions—transport through the membrane and why changing this parameter is going to give us this effect, for example—but we also tried entirely different things than we would normally try." Based on their own ideas, the students made membranes and performed experiments to see how well their systems worked. Says Hammond, "The class allowed them to have their hands on everything."

Energy is not the only field in which Hammond's novel techniques are proving valuable. In other work, she is developing a new drug delivery system that uses a nanoparticle, built using layer-by-layer assembly, to target cancerous tumors based on their acidity. She also has helped develop bandages that utilize a nanoscale coating of thrombin, a clotting agent, to quickly stop bleeding. When beginning her career, Hammond did not

expect to be active in fields as diverse as energy and biomaterials, but both share a common feature: ample opportunity to make something that didn't exist before, and to make it count. "The thing that really gets me going is the ability to create a polymer material that is able to adjust, adapt, or perform because of its response to light, to a field, to human physiological pH, or to the endosome of a cancer cell in a way that gives you the desired effect," she says. "It's the ability to design a polymer to do what you want, essentially, that really excites me."

• • •

*By Jameson Twomey, MITEI*

# Knight Fellows offer tips on tackling energy/climate science beat

Times are tough for science reporters, perhaps especially for those covering the energy and climate science beat. During a January 31, 2012, panel discussion, MIT's Knight Science Journalism Fellows chronicled the challenges of negotiating a terrain where, in the words of Knight Fellowship Director Philip J. Hilts, "everything is so toxic and partisan." A capacity audience at the event—which was co-sponsored by the MIT Energy Initiative and the MIT Program in Science, Technology, and Society—engaged the four fellows in a lively discussion that touched not only on the hazards of science writing in a politically charged environment, but also on the changing nature of the profession in an age of blogs and social networks.

Panel moderator Hilts led by citing a provocative opinion article from *The Wall Street Journal* that denied evidence of global warming in the past decade—the kind of "attack piece," said Hilts, that generates noise and confusion around the nation's climate and energy discourse. Panelists, well acquainted with this clamor, offered some strategies for cutting through it.

"A lot of our job is dealing with snake oil salesmen," said Reuters environment correspondent Alister Doyle, as reporters "navigat[e] among the competing claims" about energy technologies, for instance. Although the "daily bombardment of advertisements from lobby groups" complicates the picture, Doyle said he focuses on a careful accounting of the costs and benefits of new technologies, whether renewable or fossil fuel. But he admitted that "trying to get enough sources for a proper view of what is real here is very difficult."



Photos: Justin Knight

**During a January 31 panel discussion on science communications, Hepeng Jia (second from left) tells the audience about climate change reporting in his home country of China. Looking on are (from left) Alister Doyle, Eli Kintisch, and Joyce Murdoch. All are experienced energy and climate science reporters and 2011–2012 Knight Fellows at MIT.**

Hepeng Jia, founder of China's *Science News Magazine*, noted that while climate change is broadly accepted as a reality in his country, "The reporting on it is remote; there is no relationship to the ordinary lives of human beings." He relishes communicating the debate on energy policy taking place in the United States—including on the editorial pages of its newspapers—because "good energy journalism should not simply tell facts." Disputes can make voices supported by strong evidence become stronger, he said.

*Science* magazine policy reporter Eli Kintisch scans a "daily onslaught of hundreds of articles" seeking scientific findings that are "truly important, surprising, and newsworthy." He gains insight from "independent scientists uninvolved in the research," whose judgment he trusts. But Kintisch admitted he is worried that the audience for his carefully vetted pieces is narrowing, as people increasingly "get the news they want," making selections

based on whether they like "the Sarah Palin or Al Gore view of the world."

For Joyce Murdoch, former managing editor of the *National Journal*, "what happens in Washington in terms of energy policy totally reflects elected officials' personal assessments of their own political needs." One notable example, said Murdoch: the ethanol subsidy, which exists "because Iowa holds the first presidential caucuses." She advises journalists to "get beyond political posturing and come up with coverage that is more scientifically based."

Some audience members offered their own prescriptions for strengthening the voice of scientists and science reporters on matters of climate change and energy. "Follow the money," said one. Given the powerful interests vying for attention in Washington, "just explain to us who's paying for the arguments." Others suggested that journalists play a more active role in



**Knight Fellow and Reuters environment correspondent Alister Doyle (left) continues a conversation after the panel discussion with BP-MIT Energy Fellow Adam Freedman, a graduate student in civil and environmental engineering whose work focuses on the microbial conversion of wastes to produce clean fuels and energy sources.**

influencing the public, because facts about energy and climate matters are so often misrepresented.

While the Knight panelists expressed little enthusiasm for joining the political fray—a partial reporter is a less authoritative and trustworthy source, after all—they encouraged audience members to step in. “That job is up to you, to put more voices in the system,” said Hilts. “Blogs may be what matter most in the end.” And Kintisch added that at a time when there are fewer traditional positions available to journalists, it is “perhaps easier for scientists with a PhD or master’s, with some expertise, to make a name for themselves by writing a blog.” Former Knight Fellowship Director Victor McElheny drove home the point, reminding MIT students that “all of you are or will be practicing popularization of science without a license.”

One attendee, PhD candidate Rebecca Gianotti, was taking all this advice to

heart. A hydrologist and Martin Fellow for Sustainability, Gianotti plans shifting to a career in science journalism. While the panel confirmed her suspicions about the challenges involved, she remains intent on “finding stories that connect people to science in their everyday lives.” In her own new blog, “Science and the World” ([scienceandtheworld.com](http://scienceandtheworld.com)), she hopes to pique the interest of a public that may not already choose to read about important matters in science such as climate change. “If these stories were told in a more entertaining way, that was more about storytelling than conveying technical information, people would appreciate the relevance of science,” said Gianotti. “As soon as they have a connection to an issue, they can get invested in doing something about it.”

• • •

*By Leda Zimmerman,  
MITEI correspondent*

# MIT students pursue energy challenges globally

To tackle the world’s energy challenges, tomorrow’s leaders need an in-depth understanding not only of technology and policy relating to energy, climate change, and sustainability, but also of how situations and potential solutions vary around the globe. Accordingly, the MIT Energy Initiative (MITEI) and its collaborators have been extending MIT energy education beyond the Cambridge campus, providing students with opportunities to:

- **Perform field studies and participate in world-class conferences and meetings.** This year, a MITEI pilot program supported 19 graduate students from four of MIT’s five schools as they traveled for energy research and scholarship (see the article to the right and the table on pages 37 and 38). With separate funding, one graduate student traveled to China to find out first-hand about commuters’ travel decisions—data critical to her thesis research (pages 52–53).
- **Join the global energy discourse.** With MITEI’s help, a graduate student participated in the UN Framework Convention on Climate Change in Durban, South Africa, and an undergrad attended the fifth World Future Energy Summit in Abu Dhabi and its parallel student event, the Young Future Energy Leaders program (pages 39–41).
- **Engage in energy-related internships with leading companies around the world.** International internships can be a powerful learning and career-shaping opportunity for students, as illustrated by an MIT undergrad’s three-month experience working at MITEI Associate Member Électricité de France in Paris (pages 41–42).

## MITEI awards research and education travel grants to 19 MIT graduate students

This year, the MIT Energy Initiative (MITEI) ventured into new territory by providing research and education travel grants to 19 graduate students from across the Institute (see the table on pages 37–38). The short-term pilot program was created and implemented by the Energy Education Task Force to support graduate students performing field studies or presenting their research results at conferences around the world. The grants allowed students to carry

out vital research for theses, to build new scholarly and professional networks, and to bring new insights on global energy challenges and opportunities back to MIT. Given the success of the pilot program, MITEI has established Energy Education Without Borders, an ongoing program to support student travel for energy research and education.



Photo courtesy of Patricio Zambrano-Barragán G., MIT

**With funding from MITEI and the Department of Urban Studies and Planning, graduate student Patricio Zambrano-Barragán visited the Coca River in Ecuador in January 2012, gathering quantitative and qualitative data relating to the Coca-Codo Sinclair Hydroelectric Project. Zambrano is studying potential social and environmental impacts of large-scale hydroelectric dams, with a focus on case studies in Ecuador, Peru, and Chile.**

## Student research and education travel grants, 2011–2012

Name	Destination	Event/purpose	Title or area of research/interest
<b>Anna Agarwal</b> Civil and Environmental Engineering	Perth, Australia	International Association of Energy Economics Conference	Commercial policy and risk management in large energy projects
<b>Elena Alschuler</b> Urban Studies and Planning	San Francisco, California	Field research	Evaluation of Duke Energy's smart metering pilot program, providing real-time energy information for office buildings in Charlotte, North Carolina
<b>D. Kwabena Bediako</b> Chemistry	Lucca, Italy	Gordon Research Conference on Renewable Energy: Solar Fuels	Electrocatalytic water splitting for solar energy storage
<b>J. Cressica Brazier</b> Urban Studies and Planning	Shenzhen and Jinan, China	Field research	Energy and urban form, urban design policy, participatory technology, and real estate development and urbanization in China
<b>David Cohen-Tanugi</b> Materials Science and Engineering	Barcelona, Spain	Conference on Desalination for the Environment, Water, and Energy	Designing novel nanomaterials for highly energy-efficient water purification
<b>Florence Guiraud</b> Architecture	New Orleans, Louisiana	Field research	Energy flows: Empowering New Orleans—developing alternative energy-harvesting systems
<b>Samantha Gunter</b> Electrical Engineering and Computer Science	Washington, DC	2012 IEEE PES Innovative Smart Grid Technologies Conference	Charging stations in microgrids
<b>Jason Jackson</b> Urban Studies and Planning	New Delhi, Mumbai, and Pune, India	Field research	Data gathering for analysis of the political economy of foreign direct investment in India
<b>Jouya Jadidian</b> Electrical Engineering and Computer Science	San Diego, California	2012 IEEE International Power Modulator and High Voltage Conference	Positive and negative streamer initiation and propagation in dielectric liquids
<b>Rhonda Jordan</b> Engineering Systems Division	Nairobi, Kenya	International Conference on Power Systems Operation	Incorporating electricity demand dynamics into capacity expansion and electrification planning models in developing countries: the case of Tanzania
<b>Alex Kalmikov</b> Mechanical Engineering	Seattle, Washington	American Wind Energy Association Wind Resource and Project Energy Assessment Workshop	Project analysis for the MIT Wind Energy student team and the MIT Bates Wind Energy Assessment Project
<b>Nancy Kim</b> Architecture	Blue Fields, Nicaragua	Field research and presentations	Construction and implementation of a biodigester

**Student research and education travel grants, 2011–2012, continued**

<b>Bin Lu</b> Electrical Engineering and Computer Science	Bruges, Belgium	IEEE International Symposium on Power Semiconductor Devices and ICs	High-performance GaN-based power transistor
<b>Matthew Orosz</b> Civil and Environmental Engineering	Nottingham, United Kingdom	SCORE International Conference	Comparative analysis of traditional and solar thermal technologies for heating/cooling/powering rural health facilities in Africa
<b>Canay Ozden</b> Science, Technology, and Society	San Francisco, California	Field research	A social study of electricity markets in the United States
<b>Alan Ransil</b> Materials Science and Engineering	Jeju, South Korea	International Meeting on Lithium-Ion Batteries	Novel electrode materials for lithium-ion batteries
<b>Lennon Rogers</b> Mechanical Engineering	Los Angeles, California	Electric Vehicle Symposium	Electric vehicle parameter identification
<b>Nathaniel Deshmukh Towery</b> Science, Technology, and Society	Texas, Ohio, North Carolina	Field research	Citizen interpretations of and responses to climate change
<b>Patricio Zambrano-Barragán</b> Urban Studies and Planning	Ecuador, Peru, Chile	Field research	Data gathering for large-scale hydroelectric dam development in Ecuador, Peru, and Chile

Photo courtesy of Rhonda Jordan G., MIT



During the 9th International Conference on Power Systems Operation and Planning, Rhonda Jordan (second from right), graduate student in MIT's Engineering Systems Division, and faculty and students from the United States, the United Kingdom, Sweden, Nigeria, Kenya, and South Africa discussed their research interests and shared new ideas about power system planning in developing countries. MITEI provided funding for Jordan—pictured here with participants from Nigeria—to attend the conference in Nairobi, Kenya, on January 16–19, where she presented a paper on her research.



## An inside look at international climate negotiations at COP17

*Matthew Orosz is a PhD student in civil and environmental engineering whose research focuses on photovoltaic and solar thermal power systems. The MIT Energy Initiative sponsored Orosz to attend COP17 as part of the MIT delegation.*

In December 2011, I joined 17,000 people from around the world as an observer at the UN Framework Convention on Climate Change (UNFCCC) Conference of the Parties (COP) 17, which convened in Durban, South Africa. Through the sponsorship of the MIT Energy Initiative, I represented the MIT student body and engaged with the policy process that determines the international response to climate change.

As a doctoral student in civil and environmental engineering at MIT, I had both personal and professional motivation to experience and learn from the Durban COP. My research involves the application of solar thermal power to off-grid health and education institutions in the developing world. Central to this topic are sustainable energy and technology transfer—issues that make having a real impact on the ground challenging from both a technical and a political-economic perspective. Sustainable energy and technology transfer are likewise critical to the theme of the UNFCCC. Therefore, I was eager to absorb the strategies discussed at the highest levels of the UN agencies and international organizations represented at the conference.

Participating in the COP afforded me unprecedented access to decisionmakers relevant to my field. I was able to sit down one-on-one with high-level representatives from the World Health Organization, the World Bank, and the US National Renewable Energy Labora-

tory to discuss my work. The networking opportunities alone made my participation worthwhile. In addition to watching climate policy thought leaders in action, I was able to gain exposure for my decade-long renewable energy efforts in Africa and lay the groundwork for potential collaborations in the future.

The COP is overwhelming: It hardly fits in your field of vision. Negotiations by the UNFCCC member governments are frequently closed to observers and the media. But there are open negotiation sessions, plenaries, and other formal and informal events that sprawl across several acres and last well into the night. Countless groups strive to make their voices heard, aligning climate change with their particular issues: poverty, gender mainstreaming, preservation of indigenous cultures, and so forth.

Students from around the world are present at the COP, many researching topics across the spectrum of climate



Photo: Justin Knight

**Matthew Orosz, graduate student in civil and environmental engineering and Martin Fellow for Sustainability, 2008–2009.**

change. While many universities—like MIT—send one or two student delegates, some send platoons. I met dozens of Yale and Duke students, including some veterans of several COPs who were kind enough to get me up to speed. On my second day at the COP, Jeff Gustafson, a master’s student leading the Duke delegation, joined me on a video-conference call to the Global Environmental Science and



Photo: Matthew Orosz G, MIT

**The delegation from Nigeria speaks at the December 5, 2011, session for the Ad Hoc Working Group on Long-term Cooperative Action, held in the Baobab Plenary Hall of the Albert Luthuli International Convention Centre in Durban, South Africa.**

## MIT undergrad meets with other future energy leaders in Abu Dhabi

Politics class at MIT, where we reported on the conference and engaged the class in a lively discussion.

In the end, the outcome of two weeks of intense wrangling in Durban fit on a slender two pages, and by many standards it lacked ambition. The fact that a UNFCCC protocol is about as binding as a New Year's resolution is frustrating for everyone, but especially for those feeling vulnerable to the perils of climate change. The UN process may not be adequate to the challenge, but an alternate platform for bridging the differences between nations is hard to envision. COP17 proved once again that incremental consensus-building efforts demand patience and determination.

• • •

By Matthew Orosz G, Department of Civil and Environmental Engineering

*Uuganbayar Otgonbaatar '12 is double majoring in nuclear science and engineering and physics, and minoring in energy studies. The MIT Energy Initiative nominated Otgonbaatar for a trip to Abu Dhabi in the United Arab Emirates (UAE) during the World Future Energy Summit to take part in an international energy leadership program.*

In January, I attended the Young Future Energy Leaders (YFEL) program, a five-day event held in Abu Dhabi designed to promote the participation of students from around the world in the clean energy discussion. YFEL is part of the World Future Energy Summit (WFES), an annual gathering of policymakers and industry leaders organized by Masdar Institute in collaboration with the International Renewable Energy Agency (IRENA). Students from more than 20 countries participated in YFEL this year, and I had the privilege of being the first student from MIT's Energy Studies Minor program to attend.

Distinguished speakers are the core of the YFEL program. Among the speakers this year were First Minister of Scotland Alex Salmond; polar explorer and environmental leader Sir Robert Swan, OBE; and IRENA Director Adnan Amin. Other YFEL talks focused on how students can take an active role in raising climate change awareness and contribute to a change of public attitude toward cleaner energy generation.

Ten YFEL participants gave presentations describing their own research projects, which ranged from developing a solar-powered wheelchair to smart grid planning for the UAE. Each day, students also took part in debates on such energy-related topics as "Should countries be required to



Photo courtesy of Uuganbayar Otgonbaatar '12, MIT

**Uuganbayar (Ogie) Otgonbaatar '12 in front of the Sheikh Zayed Mosque in Abu Dhabi. The Young Future Energy Leaders program featured tours to significant historical destinations such as this mosque, which can accommodate up to 40,000 worshippers.**

implement population control to deal with climate change?" and "Should China and the US be required to place legally binding limits on carbon emissions?"

I was also able to attend WFES talks and panels. As a nuclear science and engineering major, I was particularly interested in a panel on the role of nuclear power in a sustainable energy future. I was surprised to learn that government and industry leaders of the UAE have very positive outlooks regarding the development and use of nuclear power, in contrast to leaders of many other nations, some of whom have banned the construction of new nuclear plants.

## International internship opens doors for MIT engineering undergrad

Participating in YFEL 2012 made me realize the importance that the world is attaching to clean energy and, more particularly, that the UAE is placing on developing carbon-free energy sources. Although the UAE is one of the richest countries in fossil fuels, its leaders fully recognize the unsustainable nature of fossil-fuel-based energy and understand that investment in clean energy is an investment in the future. As an MIT student interested in energy, I learned that there is a lot of opportunity for students and young professionals to work on renewable energy projects and R&D, and a lot of it is happening in the UAE.

• • •

By Uuganbayar Otgonbaatar '12

*Tasked with finding paid international internships for MIT students at all levels, MIT-France Program Manager Erin Baumgartner welcomes a growing partnership with the MIT Energy Initiative (MITEI). As increasing numbers of students gravitate toward energy and environment studies, says Baumgartner, "being able to work with MITEI on placing interns and finding excellent innovative projects for students makes my job so much easier." An early beneficiary of the burgeoning collaboration between MITEI and the MIT-France Program is Anna (Kate) Kelly '12 of the Department of Civil and Environmental Engineering, who spent the summer of 2011 working as an intern for Électricité de France.*

Several intense semesters of French, not to mention hours streaming French movies on Netflix, helped make Anna (Kate) Kelly's internship last summer with Électricité de France (EDF), Europe's largest utility and a member of the MIT Energy Initiative, an "overwhelmingly positive experience"—one that she believes has already made an impact on her academic and career track.

Kelly '12, an environmental engineering major, was one of 100 students who qualified for a fully paid internship abroad through the MIT-France Program, part of the MIT International Science and Technology Initiatives (MISTI). After meeting an EDF representative at an information session, Kelly was intrigued. The company's sample research project descriptions clinched it for her: "Based on my coursework, I knew I was well qualified and could fit in there."

After a competitive selection and interviewing process, Kelly was accepted by EDF for a three-month



Photo: Justin Knight

**Anna (Kate) Kelly '12 of civil and environmental engineering spent summer 2011 as an intern with Électricité de France—an experience that has made her an enthusiastic advocate of overseas work/study opportunities for MIT undergrads.**

position in Paris. With other France-bound students, she participated in MISTI's brisk training regimen in French politics, history, culture, and such routine but crucial matters as opening a bank account and dealing with medical emergencies.

EDF's lab, located on an island in the Seine, was engaged in fluid dynamics modeling, work that Kelly at first found "incredibly theoretical." Her supervisor tasked her with running software simulations of experiments involving circular flow of fluids in a cavity, part of a broader research effort aimed at improved understanding of turbulence-structure interaction—work that might someday enhance nuclear power plant cooling and ocean-based green energy projects. "I chose mathematical models that best matched the data and that were most computationally efficient," she says. This kind of

Photo courtesy of Anna (Kate) Kelly '12, MIT



**An internship with Electricité de France (EDF) led Anna (Kate) Kelly (fourth from right) and her EDF and student colleagues to the Flamanville Nuclear Power Plant in northern France, where EDF plans to build the first French European Pressurized Reactor near two existing pressurized water reactors.**

research was a far cry from Kelly's experience working for Chevron in Houston, Texas, the previous summer, where she investigated groundwater vapor intrusions from leaking oil storage tanks and helped restore refinery sites into wildlife habitat.

Kelly, who typically "prefers doing work that has immediate applications," nevertheless found her French lab assignment absorbing. She also appreciated opportunities to explore other EDF research and business ventures. She was invited to tour the construction site of the utility giant's European Pressurized Reactor, the first nuclear facility of its kind in France, and the plant's environmental engineers talked to her about applying for a job. She also came to appreciate the French attitude toward energy: "I was impressed by how it's not a

political issue, just a matter of fact that we need alternatives to coal and oil."

As the summer wore on, lab work progressed, and the pleasures of Paris grew on her, she decided to extend her time in France and won acceptance to the prestigious École Polytechnique for a fall semester of environmental physics and climate and radiation dynamics.

Back for her final semester at MIT, Kelly is determined to build on her overseas work/study experience. She plans to pursue a master's degree in environmental and water quality engineering, and figures that her work in computational flow dynamics will help. Later, she envisions a career in international energy policy. She will serve as an ambassador to the next round of MIT-France interns, a pool

that may significantly expand in the context of the recent partnership between MIT and the French Ministry of Higher Education and Research focused on energy projects. To her classmates considering time abroad, Kelly advises, "Absolutely do it. It is unlike anything else you can do with your summer."

• • •

*By Leda Zimmerman,  
MITEI correspondent*

# Turning green to gold: Koch building leads lab energy performance

The David H. Koch Institute for Integrative Cancer Research is not only MIT's first shared home for life scientists and engineers battling the disease, but also its first Leadership in Energy and Environmental Design (LEED) Gold-certified research laboratory facility, as rated by the US Green Building Council.

A host of sustainable design elements lies behind the LEED Gold designation, from storm water filtration and construction-waste management, to ductwork and heating, ventilation, and air conditioning (HVAC) systems engineered to do the job with the greatest efficiency. These all add up to top-notch energy performance—in fact, a building that “substantially exceeds already aggressive expectations,” according to Walter E. Henry, director of the Systems Engineering Group in the MIT Department of Facilities. After nearly 18 months in operation, the Koch Institute—a 357,000-gross-square-foot structure with more than 25 faculty labs and hundreds of researchers utilizing high-power equipment—consumes dramatically less energy during peak loads than predicted across the board: Electrical peak demand, anticipated by engineers at 14.6 watts per square foot, landed at 3.8 watts per square foot; steam heat was forecast at 35,000 pounds per hour for the coldest days and turned out to be around 20,000 pounds per hour; and the building's peak cooling demand is actually 2,354 tons of chilled water, compared to the 3,350 tons predicted by engineers. The building reduces total energy use by more than 35% as compared to a standard laboratory research building.

If the Koch Institute represents a new paradigm for MIT—a massive research facility with a modest appetite for energy—it is no accident; years of planning led to this union of sustainable



Photo: Peter Vandewalker

**The David H. Koch Institute for Integrative Cancer Research building, completed in October 2010, is the first laboratory research building at MIT to receive LEED Gold certification.**

form and scientific function. In 2007, before architects even began developing blueprints, a team of experts tapped from inside and outside MIT engaged in a deliberative process to weave sustainability into the fabric of the Koch Institute. “I came to see the building as the ‘Koch Institute for integrative building planning and design,’” says Steven Mahler SB ’80, MArch ’83, a principal at the architecture firm Ellenzweig, which designed the structure. “The process we went through in designing for sustainability was emblematic of the whole Koch Institute planning enterprise and is now perceived to be the way to design smarter buildings.”

The sustainability and engineering design team, consisting of Ellenzweig, BR+A Consulting Engineers, and MIT, aiming to combine in a single building both next-generation research and the highest possible standards for energy conservation, confronted some challenges from the very start: an “extremely tight timetable,” according to Henry, as well as a firm budget

ceiling. The team also had to accommodate the laboratory demands of both engineers and biologists, notes Mahler, as well as offer space for the kind of serendipitous encounters that scientists need to kindle major new insights. As a hub for harnessing biotechnology to medical science, the institute requires the use of potentially hazardous materials for life science research as well as novel engineered nanomaterials. Pamela Greenley, associate director of MIT's Environment, Health, and Safety (EHS) Headquarters Office, collaborated with the design team to establish appropriate safety standards for these materials. These various requirements and constraints all had impacts on energy-consuming building systems, and it was the job of MIT Project Manager Arne Abramson MCP ’82 to make sure they “didn't get in the way of a reasonable, sustainable design.”

The project's tight deadline meant determining a finite set of high-impact objectives. Says Henry, “We had to be aggressive in our thinking and focus on a limited number of strategies for

sustainability.” In areas such as lighting, opportunities emerged early on for implementing practical, energy-efficient systems. First, there was the good fortune of having an open site on campus, says Mahler, which permitted the architects to “orient a pretty wide building—145 feet deep—directly east to west” to maximize useful heat and light from the sun. This also meant sun shades could be used in the most energy and cost-efficient manner, placed exclusively on the south side of the building. Another opening for energy conservation, says Mahler, evolved from Koch researchers’ desire to “maximize the number of times they might encounter each other.” This pointed the way to a large central zone containing faculty offices, meeting rooms, and lounges. Says Mahler, “You don’t need as energy-intensive a mechanical system for those spaces when you group them together this way; you can save a lot of energy.” They also zeroed in quickly on ventilation, a major source of energy consumption in research buildings. One



Photo: Richard Howard

**The Koch Institute building hosts a variety of energy-efficient and high-performance features, including key design elements integrated into its heating, ventilation, and air conditioning (HVAC) systems. Here, Steven Lanou (left), deputy director for sustainability in the Environment, Health, and Safety Headquarters Office, and Frank Higson, senior engineer, Department of Facilities, view the building’s low-velocity ductwork.**

key area involved Koch’s 100 or so fume hoods, which flush contaminated air away from researchers. The aim, says Greenley, was to be “aggressive on energy savings without compromising the health and safety of researchers.” To find the right balance, Henry says, “We did a lot of modeling.”

The standard airflow for fume hoods on campus had always been 100 feet

per minute. But recently completed studies carried out with significant input from members of the MIT Energy Initiative’s Campus Energy Task Force demonstrated that it was possible to reduce airflow velocities while rigorously observing EHS guidelines. “We looked at the testing standards, and in our design assumptions were able to lower the flow rate to 80 feet per minute with no measurable impact on user safety,” says Abramson. At the end of construction, he notes, mannequins emerged unscathed from a tracer gas test, successfully demonstrating the vapor containment viability of hoods with lower airflow rates. If safety standards evolve and suggest still lower rates of airflow, the fume hoods can be adjusted later for even greater energy savings.

The team also found it possible to deploy a cascading ventilation system—a first for MIT—where air used to cool offices could be reused for the hoods in lab areas. They accomplished this neat trick of airflow management by laying out lab spaces identically, with equipment like fume hoods lined up along a given wall, which allowed engineers to “rationalize duct and pipe

Photo courtesy of Ellenzweig Associates



**The high-performance laboratory fume hoods used in the Koch building—shown above—have an improved aerodynamic design so a lower volume of air can be passed through and still provide the same or better level of protection to the user. Energy savings accrue from having to filter, move, cool or heat, and clean less air.**

# MIT-NSTAR program proves model of efficiency

distribution so it didn't take odd twists and turns," Abramson says.

Setting sustainability targets, modeling outcomes, and revisiting and revising goals, before and even during construction, "took a lot more thinking and integration and creativity," says Abramson, but ultimately paid off. "[It] was a partnership, where we discussed different approaches, took guidelines, and played them out in the lab.... The iterative process we used was the best part of it," says Greenley. For Mahler, engaging in integrated design with the Koch Institute not only proved "unusually synergistic" but also generated useful practices that can be shared.

Capping off construction with a LEED Gold rating is gratifying, but for Henry, an even better outcome might be the dissemination of Koch's sustainable design strategies throughout the MIT campus, with its concentration of energy-intensive research facilities. Koch's ensemble of high-energy performance features translates into "hundreds of thousands of dollars" in annual savings for MIT, says Henry, as well as confirmation that a collaborative approach to design and construction can yield superlative results without compromising health, safety, or productivity. People should learn from Koch, Henry concludes, that "to get a building that performs well requires only that you make intelligent choices about what you do. It doesn't require extra money, or take longer, and doesn't require that you adopt strange, new, and untried strategies."

• • •

By Leda Zimmerman,  
MITEI correspondent

Just two years in, MIT's groundbreaking collaboration with gas and electric utility NSTAR has produced cumulative electricity savings of 23 million kilowatt hours (kWh). The program has exceeded its combined two-year goal and is increasingly drawing attention from other large energy users as a model conservation program.

MIT's progress has been "absolutely fantastic," says John Kibbee, program manager for NSTAR. "We now have three major universities in addition to MIT in similar kinds of agreements, and I expect that number will continue to grow."

Launched in 2010, the NSTAR-MIT Efficiency Forward Program is a first-of-its-kind partnership designed to support the Commonwealth of Massachusetts' aggressive energy-efficiency strategy for reducing greenhouse gas (GHG) emissions. The three-year, \$13 million program, in which NSTAR provides incentives and expertise to support MIT's own energy conservation efforts, is expected to produce lifetime savings of \$50 million and prevent a total of over 20,000 metric tons of GHG emissions each year.

"The lessons we've learned [through the pilot program] at MIT have been really valuable," says Kibbee. "The biggest takeaway is that at MIT we have an Institute-wide commitment with

high-level management involved. When that happens, more attention is paid, more resources are put in, and whenever difficulties come up, it's certain roadblocks will be cleared."

## Meeting goals

MIT is currently on target to meet its goal of reducing annual campus electricity consumption 15% to 34 million kWh by the end of 2012, according to Megan Kefalis, the program's project manager in MIT's Department of Facilities.

"The first year we looked at buildings we knew needed lighting upgrades. In the second year, we decided to walk through all the buildings, get as many lighting audits as we could, and go from there," she says. More than 2.6 million square feet of campus buildings were audited in 2011, with lighting upgrades made as needed. Most of the lighting work performed in 2011 was to re-lamp and re-ballast existing fixtures, as well as to install sensors to ensure that lights are turned off when rooms are not occupied. Many areas also received LED installations.

"[Efficiency Forward] is making a big difference on campus," says Kefalis. "We would not have had the funding to blanket the campus like this without this initiative. It's beneficial on every level—to get the job done, to make



Photo: Ruth T. Davis, MIT



**An Efficiency Forward review focusing on the operation of MIT’s Building 14 (above) led to the identification and implementation of several energy-saving changes. One finding, for example, was that fans could be run at a lower speed and still supply the correct amount of fresh air to the building.**

[energy conservation] more visible to everyone on campus, and to focus on [the optimal] operation of buildings.”

According to Department of Facilities figures, the major energy savings in 2011 came from:

- Full floor-to-ceiling renovations designed to save energy in existing buildings (4.36 million kWh/year)
- Lighting and mechanical retrofit and upgrade projects (5.78 million kWh/year)

While lighting changes were “low-hanging fruit,” Kefalis says that Efficiency Forward has also enabled MIT to optimize heating, ventilation, and air conditioning (HVAC) systems on campus. Facilities is looking at when buildings are in use and when heated, cooled, or fresh air is most needed, then implementing energy-saving measures to provide HVAC services more efficiently. “In the review of Building 14 operation [for example], we found we could turn the fans down and supply the correct amount of fresh air,” says Kefalis. “We also upgraded dampers and control mechanisms.”

In the coming year, Kefalis says, the Department of Facilities plans to examine whole building systems to find additional savings. One focus will be the recalibration of sensing equipment, since faulty systems can cause HVAC systems to function incorrectly and therefore inefficiently.

**Outreach to the community**

In the past several months, the facilities staff has also been asked to brief several organizations on Efficiency Forward and to share MIT’s experience, according to Steven Lanou, MIT’s deputy director for sustainability in the Environment, Health, and Safety Headquarters Office. “Everyone has a strong interest in learning what is working and what is not working to identify, develop, finance, and implement large-scale energy-efficiency measures,” says Lanou.

He notes that a great deal of interest was spurred by MIT’s 2011 Efficiency Forward Forum, which was attended by over 100 local leaders. More recently, MIT gave a presentation on Efficiency Forward to the General Services Administration, which manages federal buildings, and organized a workshop

on the program for the Greater Boston Chamber of Commerce. The latter meeting, held on March 29 at the new Sloan School of Management building, welcomed nearly 100 chamber members. Paul Guzzi, president and chief executive officer of the Greater Boston Chamber, says he is optimistic that lessons learned from Efficiency Forward will encourage companies in the area to address energy efficiency in their own operations. “There could be no better partner for such a program than MIT—a university whose global leadership can be seen not just in the cutting-edge research that is done there each day, but in the very facilities in which this work is conducted,” says Guzzi.

“We are very pleased to see this strong uptick in interest in our campus energy programs, and I am excited that we are starting to see an impact well beyond our own campus walls,” says Lanou, stressing that “MIT is dedicated to continuing its outreach efforts.”

• • •

*By Kathryn M. O’Neill, MITEI correspondent*



# MIT study of the electric grid: With new policies, grid can handle electric cars, wind, solar

Over the next two decades, the US electric grid will face unprecedented technological challenges stemming from the growth of distributed and intermittent new energy sources such as solar and wind power, as well as an expected influx of electric and hybrid vehicles that require frequent recharging. But a new MIT study concludes that—as long as some specific policy changes are made—the grid is most likely up to the challenge.

Study co-chair Richard Schmalensee, the Howard W. Johnson Professor of Economics and Management at the MIT Sloan School of Management, says the two-year study came about “because a number of us were hearing two sorts of rhetoric” about the US power grid: that it’s on the brink of widespread failure, or that simply installing some new technology could open up wonderful new opportunities.

“The most important broad finding was that both of these are false,” Schmalensee says. While the grid is not in any imminent danger, he says, “the current regulatory framework, largely established in the 1930s, is mismatched to today’s grid.” Moreover, he adds, today’s regulations are “highly unlikely [to] give us the grid of the future—a grid that by 2030 will support a range of new technologies and consumer services that will be essential for a strong and competitive US economy.”

The report was commissioned by the MIT Energy Initiative (MITEI) and carried out by a panel of 13 faculty members from MIT and one from Harvard University, along with 10 graduate students and an advisory panel of 19 leaders from academia, industry, and government.

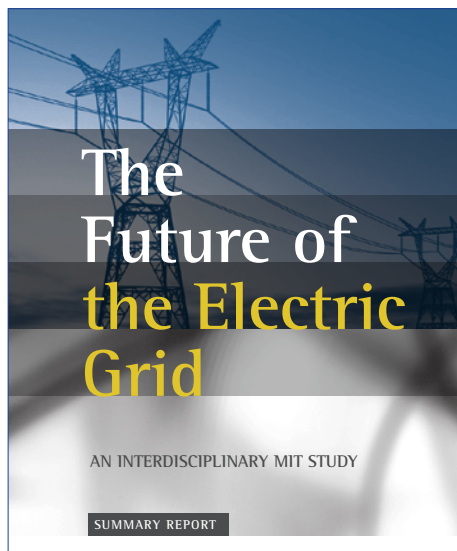

While the grid’s performance is adequate today, decisions made now will shape that grid over the next 20 years. The MIT report recommends a series of changes in the regulatory environment to facilitate and exploit technological innovation. Among the report’s specific recommendations: To enable the grid of the future to handle intermittent renewables, the United States will need effective and enhanced federal authority over decisions on the routing of new interstate transmission lines. This is especially needed, the report says, in cases where power is produced by solar or wind farms located far from where that power is to be used, requiring long-distance transmission lines to be built across multiple regulatory jurisdictions.

“It is a real issue, a chicken-and-egg problem,” says John Kassakian, a professor of electrical engineering at MIT and the study’s other co-chair. “Nobody’s going to build these new renewable energy plants unless they know there will be transmission lines to get the power to load centers. And nobody’s going to build transmission lines unless the difficulty of siting lines across multiple jurisdictions is eased.”

Currently, when new transmission lines cross state boundaries, each state involved—and federal agencies as well, if federal lands are crossed—can make its own decisions about permission for the siting of these lines, with no centralized authority.

“There are many people who can say no, and nobody who can say yes,” Schmalensee explains. “That’s strategically untenable, especially since some of these authorities would have little incentive ever to say yes.”

The MITEI report recommends that the Federal Energy Regulatory Commission (FERC) either be given the authority to make decisions in such cases, or be designated as the “backstop” authority in cases where there are disputes.

The grid would also benefit from a restructuring of the way customers pay for its costs, the study found. Payment for electric distribution, like payment for generation, is currently calculated based on usage. But most of the costs involved are fixed; they do not depend on usage. This gives utilities incentives to resist distributed generation, such as homeowners installing rooftop solar panels, and gives consumers excessive incentives to install such systems—and thereby to shift their share of fixed network costs to their neighbors. Fixed network costs, the reports says, should be recovered primarily through customer charges that do not depend on electricity consumption.

In addition, while many utilities have begun to install “smart meters” for their customers, most of these are not yet being used to provide feedback to customers that could shift electricity usage to off-peak hours.

“We haven’t done as much as we could to develop this capability, to learn how to do this,” Schmalensee says. “It could save everybody money by cutting down the need to build new generators.” While overall growth in demand is expected to be modest and easily accommodated, without new policies, peak demand will rise much faster, requiring new generating capacity. “We continue to build capacity that’s only used a few hours a year,” he says. Providing consumers with better price signals and the ability to play a more active role in managing their demand could significantly improve this imbalance, the report says.

Another area that will require restructuring, the study concluded, is cybersecurity: The more thoroughly the grid is interconnected, and the more smart meters are added to gather data about usage patterns, the greater the risk of security breaches or cyberattacks on the system.

At the moment, no agency has responsibility and authority for the entire grid. The report strongly recommends that some agency—perhaps the US Department of Homeland Security—be given such responsibility and authority, but thorny issues related to authority over local distribution systems would need to be resolved. In addition, the report notes, it will be important to develop rules and systems to maintain the privacy of data on customers’ electricity usage.

Requiring the sharing of data, especially data collected as a result of federal investments through the American Recovery and Reinvestment Act of 2009, should be a significant priority, the report says. The government “spent a lot of money on pilot programs and

experiments, and installations of a lot of new equipment that can improve the efficiency and reliability of the grid and the management of demand,” Kassakian says. But there needs to be more cooperation and communication about the results of those programs in order to get the benefits, he says.

In fact, widespread sharing of data from real-time monitoring of the grid could help prevent some failures before they happen, Kassakian says: “If you’re aware of what’s happening at the same time everywhere, you can observe trends and see what might be an incipient failure. That’s very useful to know and allows better control of the system.”

The MITEI study found that growth in the number of electric vehicles (EVs) on the road is likely to be slow enough, and widely distributed enough, that it shouldn’t create significant strain on the grid—although there may be a few locations where a particularly high penetration of such vehicles could require extra generating capacity. Some other effects could be subtle: For example, in some hot regions of the Southwest, grid components such as transformers are designed to cool off overnight when demand is ordinarily low. But a sudden influx of EVs charging at night could necessitate bigger transformers or cooling systems, while charging them at the end of the workday could significantly increase peak demand and thus the need for new capacity.

Utilities now spend very little on research, the study found, because regulators provide little incentive for them to do so. The report recommends that utilities put more money into research and development—both to

make effective use of new technologies for monitoring and controlling the grid, and to understand how customers respond to pricing policies or incentives.



*By David L. Chandler, MIT News Office*

This study was sponsored by ABB Group, American Electric Power, Bechtel Foundation, Larry Birenbaum, Cisco Systems, Exelon Corporation, General Electric Company, Iberdrola SA, Microsoft Corporation, National Institute of Standards and Technology, and Southern California Edison. To download a copy of the report, go to [web.mit.edu/mitei/research/studies/the-electric-grid-2011.shtml](http://web.mit.edu/mitei/research/studies/the-electric-grid-2011.shtml).

Other *Future of...* reports are available at [web.mit.edu/mitei/research/studies/index.shtml](http://web.mit.edu/mitei/research/studies/index.shtml).

# MITEI report: Integrating large-scale intermittent energy sources into the electric grid

The impacts of the large-scale deployment of intermittent renewables—wind and solar—on conventional generation technologies, as well as on the power grid, was the topic of a report released by the MIT Energy Initiative (MITEI) at a panel discussion and press briefing on March 12.

The report, *Managing the Large-Scale Penetration of Intermittent Renewables*, summarizes the discussion and findings of a group of subject-matter experts who participated in a MITEI symposium on the topic held on campus last year. Highlights from the symposium and report were discussed at the March event by a panel of MIT experts that included MITEI Director Professor Ernest Moniz, who moderated the panel; MIT Institute Professor John Deutch; Howard Herzog, MITEI senior research engineer and director of the MIT Carbon Capture and Sequestration Technologies Program; Visiting Professor Ignacio Perez-Arriaga, Engineering Systems Division and Center for Energy and Environmental Policy Research; MITEI Executive Director Melanie Kenderdine; and John Michael Hagerty, graduate student in MIT's Engineering Systems Division.

## Symposium/report focus, findings

Twenty-nine US states, the European Union, and a number of other countries have adopted policy mandates and incentives to promote wind and solar power generation, both of which are intermittent. Absent large-scale storage options, these sources must be accommodated by the power delivery system as well as by the traditional thermal (coal, oil, natural gas, nuclear) generation units. The intermittent nature of wind and solar complicates the balancing of supply and demand while preserving reliability and economically



**At the press briefing, Ernest Moniz, director of the MIT Energy Initiative, discusses the role of conventional thermal generation plants in providing flexibility in a power system with large-scale penetration of intermittent renewables in the absence of pervasive utility-scale storage systems. Providing generation flexibility entails fast ramping times, short startup times, and efficient partial load operation.**

efficient dispatch from the range of generation units within a service area or system. The proper allocation of costs requires an understanding of the system impacts of intermittent sources, including the need for backup capacity. The premise of the symposium was that implementation of appropriate cost allocation and operational protocols is a key enabler for future large-scale deployment of intermittent renewables.

The symposium examined several key areas of concern related to such mandates, including their emissions impacts, unintended consequences for system planners and market participants, impacts on the future generation mix and electricity markets, and the adequacy of existing regulatory frameworks and requirements. The following are some of the key findings in the symposium report:

### Generation units

- **Coal:** Coal units are mostly not designed for flexible operation and

will have efficiency reductions, increased emissions, and operational issues when pushed to operate flexibly. It is technically possible to design and retrofit coal units for flexible operation, but the required changes would be significant for existing plants.

- **Nuclear:** Relatively new nuclear reactors ramp “asymmetrically,” meaning plants can ramp down relatively quickly but take much longer to ramp back up to full load. Some nuclear plants in France were designed specifically to follow load. Also, nuclear plant ramping is not fully automated, increasing the potential for human error.
- **Natural gas:** Natural gas power plants provide the greatest generation flexibility to help manage intermittent renewable generation. New natural gas combined cycle (NGCC) plants continue to improve this capability, including rapid changes in power levels.

*Economic impacts*

- Absent the availability of utility-scale storage, incentives will likely be necessary to encourage investment in flexible generation.
- Flexible operation of nuclear plants dramatically impacts their profitability. Very high capital costs mean that nuclear plants need to run at high capacities to recoup investment costs.
- For economic reasons, plant owners will likely operate existing coal plants with minimal flexibility upgrades.
- The higher fuel cost for NGCC units generally places them last in the dispatch order; policies that mandate the dispatch of renewable generation, combined with the relatively low capacity factors for NGCC units, makes cost recovery more difficult because capital is amortized over fewer hours.

*Transmission grid and system operations*

- Intermittent renewables present integration challenges at all timescales for the power system. As renewable penetration increases, system stability on the timescales of a fraction of a second will increasingly matter, much like backup capacity currently matters at timescales of minutes and hours.
- Current algorithms to manage intermittent renewables do not accommodate the uncertainties involved in forecasting wind, load, and other variables. New algorithms and tools need to be developed to conduct geographic and temporal analyses and simulations that are of sufficient scale for power systems. Acquiring useful data from industry for such work is difficult.



**John Michael Hagerty, graduate student in MIT’s Engineering Systems Division and Exelon-MIT Energy Fellow, describes the impacts of mandated dispatch of renewable generation on the economics of conventional plants. For example, higher levels of wind generation are expected to force coal plants to shut down more often.**

*Policies and regulation*

- Policy challenges for integrating intermittent renewables exist in both short-term operations and long-term planning in order to maintain a reliable, economically efficient power system.
- The major areas being considered for policy/regulatory changes are reliability criteria, capacity markets, and cost allocation. New incentives that promote flexibility are needed.
- Too much generation from intermittent renewables is as much of a problem as too little; many renewables mandates require the dispatch of wind energy regardless of demand.
- Policy solutions need to be regionally focused because of vast geographic differences in resources, demand, and markets. Regions will need research to produce careful regulation that meets the needs of stakeholders and ensures overall system reliability and efficiency.

**MITEI Symposium Series**

This symposium is part of a series at MITEI designed to provide policy-makers with technically grounded information and findings on topical energy issues. The series also provides

graduate fellowships to support the symposium; graduate students Michael Hagerty and Tommy Leung served as rapporteurs for this symposium and are completing their master’s theses on related topics. MITEI Associate Members Cummins, Entergy, Exelon, and Hess provide support for the series.

Earlier reports in the series include *Retrofitting of Coal-Fired Power Plants for CO<sub>2</sub> Emission Reductions* and *The Electrification of the Transportation System*. The next symposium will address the prospects for alternative fueled light-duty vehicles.

The symposium report on intermittent renewables includes seven white papers commissioned by MITEI from various experts to inform the discussion and the findings. To download a copy of the report and the white papers, go to: [web.mit.edu/mitei/research/reports/intermittent-renewables.html](http://web.mit.edu/mitei/research/reports/intermittent-renewables.html). To order a copy of the report, send an email message including your name and postal address to [askmitei@mit.edu](mailto:askmitei@mit.edu).

• • •

*By Teresa Hill and  
Melanie Kenderdine, MITEI*

## DOE and MITEI announce US Women in Clean Energy program

On April 26 at the Third Clean Energy Ministerial in London, the US Department of Energy (DOE) announced a three-part plan to help implement the Clean Energy Education and Empowerment (C3E) initiative, a Ministerial program aimed at attracting more women to clean energy careers and supporting their advancement into leadership positions. This new program, pursued in partnership with the MIT Energy Initiative (MITEI), is designed to translate the goals of C3E into concrete, meaningful action in the United States.

Highlighting the importance of this partnership, MIT President Susan Hockfield said, "Inventing a sustainable energy future represents the defining challenge of our time. To make progress against a problem of such scale, complexity, and global scope demands the fullest range and depth of talent, ideas, and commitment; by definition, then, women must play essential roles in the drive toward transformative energy innovations. MIT is pleased to join with DOE to help develop and implement the C3E initiative, and to sponsor both the Women in Clean Energy Symposium and the awards program this fall."

C3E was launched in July 2010 at the first Clean Energy Ministerial, a global forum of the energy ministers and leaders of 23 governments.

Nine governments—Australia, Denmark, Mexico, Norway, South Africa, Sweden, the United Arab Emirates, the United Kingdom, and the United States—committed to undertake meaningful activities to advance women in clean energy and close the gender gap in their own national contexts and link their efforts wherever possible.

Specific features of the US C3E action plan include:

**Ambassadors:** The ambassadors will be a cohort of distinguished senior professionals who share an interest in broadening the recruitment, retention, and advancement of highly qualified women in the field of clean energy and are committed to acting as champions for the goals of C3E. Ambassadors will also serve as the selection panel for the awards program outlined below. The inaugural group of ambassadors includes Maxine Savitz, vice president of the National Academy of Engineering and member of the President's Council of Advisors on Science and Technology; Melanie Kenderdine, executive director of MITEI; and Sue Tierney, managing principal, Analysis Group.

**Awards:** The DOE C3E Awards program will recognize mid-career individuals who advance the leadership and accomplishments of women in clean energy. Six awards will be given; each will include a cash prize of \$10,000. Nominations will be accepted in categories including innovation and technology development, entrepreneurship and innovative business models, corporate implementation, policy and advocacy, and advancements for the developing world. Nomination instructions will be available in the coming weeks, with the goal of announcing the award winners at the C3E symposium.

**Symposium:** This invitation-only symposium, to be held on September 28, 2012, will focus on helping to build a strong national and international community of professionals who support women in clean energy. MITEI, in partnership with DOE, will sponsor the event.

For a fact sheet about the US C3E program and a list of ambassadors, go to: [web.mit.edu/press/2012/mitei-doe-women-in-clean-energy.html](http://web.mit.edu/press/2012/mitei-doe-women-in-clean-energy.html).

## Recent colloquia of note



Photos: Justin Knight

At this year's Earth Day colloquium on April 23, *New York Times* writer Andrew Revkin, author of the *Dot Earth* blog ([dotearth.blogs.nytimes.com](http://dotearth.blogs.nytimes.com)), described how new ways of sharing and shaping ideas are fundamentally altering the way climate change can be both communicated and confronted. He stressed the need to move to a new model of action based not on international climate deals but rather on work that comes from the bottom up. Using advanced web capabilities, organizations and individuals can connect to share ideas and discover best practices. Unconventional approaches such as music videos and art exhibits can explain the climate challenge in new ways, helping to increase public understanding and support. (More at [web.mit.edu/newsoffice/2012/communicating-the-climate-challenge.html](http://web.mit.edu/newsoffice/2012/communicating-the-climate-challenge.html).)



At an April 18 colloquium, Tom Stricker of Toyota Motor North America considered a proposal now being debated in Washington that would call for automakers to phase in cars running on something other than just gasoline starting in 2014. Advocates claim that automakers could respond to the mandate with flexible-fuel vehicles (using ethanol or methanol plus gasoline). But Stricker argued that costs would be high, the necessary fuels would not always be available, and—when they are—consumers would not necessarily use them. A better route is to focus on more-efficient vehicles, such as the already-popular hybrid and electric vehicles. (More at [web.mit.edu/newsoffice/2012/our-gasoline-free-future-and-how-to-get-there.html](http://web.mit.edu/newsoffice/2012/our-gasoline-free-future-and-how-to-get-there.html).)

# Chinese train station and airport surveys assess commuter travel decisions

*In fall 2010, the Jack C. Tang '49 Fund provided funding to the Laboratory for Energy and the Environment for travel grants to be awarded to MIT graduate students working to promote environmentally sustainable practices in China. Among those supported in summer 2011 was Regina Clewlow, graduate student in the Engineering Systems Division, who traveled to Beijing to gather data on how Chinese commuters choose between high-speed rail and air for their intercity travel.*

Interviewing commuters in Beijing's summer swelter, Regina Clewlow was "won over" by the willingness of complete strangers to answer her detailed questions about air and high-speed rail. Her survey on the travel preferences of Chinese commuters provided essential data for Clewlow's Engineering Systems Division dissertation on the links between transportation infrastructure and climate change. What happens in China, Clewlow suggests, has great import for the rest of the world.

Global aviation accounts for 3% of greenhouse gas emissions and is growing steadily. Decisions made now by nations to accommodate expanded air travel will have significant implications for local air quality and global climate change for decades to come. Clewlow has been studying whether the introduction of lower-carbon alternatives such as high-speed rail (HSR) might curb an international appetite for air travel. While she had pursued this question in the United States and Europe, she was finally able to extend her investigations to China as a result of the Tang grant. The stakes are especially high in China, which experienced a 16% increase in air travel between 1978 and 2009, and where the population clamors for new and better routes between major cities.

Clewlow's research, grounded in both econometrics and civil engineering, aims to understand how demands for transportation systems evolve. In China, she was most interested in learning whether environmental concerns have



Photos courtesy of Regina Clewlow G., MIT

**During summer 2011, Regina Clewlow G. of the Engineering Systems Division conducted surveys to determine how Chinese commuters decide whether to travel by high-speed rail or air—data she is using in her thesis research on links between transportation infrastructure and climate change.**

any impact on passengers' selection of transportation, specifically between HSR and air travel. Clewlow arrived in Beijing at the beginning of June 2011 and set up camp at Tsingua University, where she developed her survey and posted ads on RenRen, China's Facebook, to recruit a team of undergraduate helpers.

Before the trip, she read translated Chinese transportation studies, which mainly focused on "assessing people's sensitivities to travel time and price," she says. Clewlow's survey aimed to assess the common factors that impact people's travel decisions, including income level, education, profession, and reasons for traveling, as well as their attitudes toward the environment and safety.

In July, Clewlow set out with volunteers in Beijing, and another group went to work in Shanghai, to collar commuters at the cities' HSR stations and airports. "Some people might have felt sorry for



**With help from a team of Chinese undergraduate volunteers, Clewlow surveyed travelers in the Beijing South Rail Station (above) and other major train stations and airports in Beijing and Shanghai. Preliminary results indicate that Chinese commuters generally prefer to travel by high-speed trains such as the one shown on page 53, which runs from Beijing to Tianjin.**



or intrigued by the American who was trying to collect surveys in poorly spoken Mandarin," she says. In fact, Clewlow is proud that she communicated well enough to gather "quite a few surveys" on her own, and found "people surprisingly open to filling them out." She speculates that many might have been happy to kill time with her survey since they were stuck for hours waiting at the airport or train station: "There can be a lot of uncertainty about how long it takes to get around in Beijing and Shanghai. Local traffic is often so bad you have to leave really, really early."

One major hitch to the research: the devastating July 23, 2011, accident in Wenzhou, when two HSR trains collided, killing 40 and injuring hundreds. Infused with billions of government dollars in the previous decade, China's

HSR program had been touted as a reliable and reasonably priced alternative to air travel. Now, it appeared to have grown too fast, with construction tainted by possible shortcuts and shoddy safeguards. While China immediately slowed down the maximum speeds for HSR lines (from a blazing fast 385 kilometers per hour to 350 or less) and launched investigations, commuter confidence was nonetheless seriously shaken. Clewlow realized that her questions and analysis of the tradeoffs commuters make among safety, cost, and environmental concerns would have to take this event into consideration.

Although she is only partly through digesting the data from 550 surveys, Clewlow believes her Chinese travelers in general show a greater preference for HSR. Clewlow also finds that "although

there were encouraging results related to environmental issues and their influence on traveler choice," commuters weighed reliability and safety heavily into their decisions. Whatever the final results, Clewlow's China research will play a pivotal part in a larger examination of international policy and investment in transportation infrastructure, an analysis she hopes "will help policymakers make educated decisions."

• • •

*By Leda Zimmerman,  
MITEI correspondent*

# Martin Fellows, 2012–2013

The Martin Family Society of Fellows for Sustainability, established at MIT in 1996 through the generous support of the Martin Foundation, fosters graduate-level research, education, and collaboration in sustainability. The society supports and connects MIT's top graduate students in environmental studies and fosters opportunities for multidisciplinary cooperation in both the short and long term.

## **D. Kwabena Bediako**

Chemistry  
*Solar-driven water splitting as the basis for renewable energy conversion and storage*

## **Matthew Branham**

Mechanical Engineering  
*Fabricating light-trapping structures to enable thin-film silicon photovoltaics*

## **Fabio Caiazzo**

Aeronautics and Astronautics  
*Novel computation of climate and air quality impacts of aerosols and aerosol-cloud interactions*

## **Fernando de Sisternes**

Engineering Systems Division  
*Designing market rules for electric power systems with renewables*

## **Wanli Fang**

Urban Studies and Planning  
*Impacts of high-speed rail on China's energy consumption and carbon emissions*

## **Marcus Gibson**

Chemistry  
*Characterizing enzymatic conversion for carbon dioxide emissions reduction and energy storage*

## **Nicholas Macfarlane**

Woods Hole Oceanographic Institute  
*Understanding the mechanisms of anthropogenic noise exposure on marine mammals*

## **Ronan McGovern**

Mechanical Engineering  
*Tackling issues of sustainability in desalination and wastewater treatment*

## **Canay Ozden**

Science, Technology, and Society  
*Evaluating technical and behavioral implications of demand-side management for the electric grid*

## **Atul Pokharel**

Urban Studies and Planning  
*Understanding technology adoption in rural Nepalese agriculture*

## **David Ramberg**

Engineering Systems Division  
*Assessing system-wide impacts of fossil fuel conversion technologies*

## **Todd Schenk**

Urban Studies and Planning  
*Relationship between cross-sectoral cooperation and climate change risk management*

## **Mark Smith**

Biology  
*Evaluating genetic pathways that facilitate bio-mediation of uranium from nuclear waste sites*

## **Mike Szulczewski**

Civil and Environmental Engineering  
*Clarifying the storage capacity and lifetime of carbon capture and sequestration in the United States*

## **Alexandra Patricia Tcaciuc**

Woods Hole Oceanographic Institute  
*Developing an integrative approach for evaluating baseline toxicity in sediments*

## **Gregory Thiel**

Mechanical Engineering  
*Improving the efficiency of humidification-dehumidification systems for desalination and water treatment*

## **Jiankang Wang**

Electrical Engineering and Computer Science  
*Improving efficiency and reliability of modern power systems*

## **Yuan Xiao**

Urban Studies and Planning  
*Understanding the institutional dynamics and governance issues behind land use conflicts in China*

## **Despina Zymnis**

Civil and Environmental Engineering  
*Examining the impacts of large geothermal energy installations on soil and overlying structures*



# The Martin Fellows: Building a community of scholars for sustainability

The Martin Family Society of Fellows for Sustainability was established at MIT in 1996 by Lee '42 and Geraldine Martin. Since then, the society has supported hundreds of doctoral students pursuing research on environmental and sustainability topics. In 2006, the Martin Foundation made an additional generous gift to MIT to foster informal multidisciplinary interaction among these young scholars and to engage undergraduate researchers in the Martin Fellows' research. The gift has supported annual offsite retreats and induction dinners, numerous informal gatherings, and 37 undergraduate research projects.



**Left to right: Elizabeth Martin; Sallie (Penny) Chisholm, the Lee and Geraldine Martin Professor of Environmental Studies; Geraldine Martin; and Hallie Martin at the May 2008 induction dinner and celebration of the 10th anniversary of the Martin Fellows program.**



**Alexandra Patricia Tcaciuc '08 displays an underwater gas-collection trap she helped design and build during her 2007 Martin Family UROP with Martin Fellow Charuleka Varadharajan (Civil and Environmental Engineering). Using these devices, they measured bubbling methane fluxes in Upper Mystic Lake in Woburn, Massachusetts, as part of a larger effort to quantify this source of greenhouse gas emissions. Tcaciuc is now a Martin Fellow herself.**



**In September 2010, the Martin Fellows retreat (left) focused on coastal ecosystems and bird migration and how both are impacted by climate change. Here, the fellows look on as Ben Flemer of the Joppa Flats Education Center demonstrates how to examine a bird (above) that was retrieved from mist nets near the center's bird banding station.**



**Martin Fellows Timothy Heidel (left, Engineering Systems Division) and Zhe Lu (Chemistry) discuss Heidel's research on organic photovoltaics at a Martin Fellows research exchange in February 2008.**



**During the September 2009 Martin Fellows retreat to Thompson Island, Joseph Shapiro (Economics) takes his turn describing a memorable environmental experience. The fellows jointly constructed the US map, which helped illustrate the geographical diversity of their activities.**

This photo: Beth Conlin, MIT/EE. All other photos: Justin Knight

## MITEI Founding and Sustaining Members

MITEI's Founding and Sustaining Members support "flagship" energy research programs or individual research projects that help them meet their strategic energy objectives. They also provide seed funding for early-stage innovative research projects and support named Energy Fellows at MIT. To date, members have made possible 103 seed grant projects across the campus as well as fellowships for more than 200 graduate students in 20 MIT departments and divisions.

### FOUNDING MEMBERS

BP  
Eni S.p.A.  
Shell



### FOUNDING PUBLIC MEMBER

Masdar Institute



### SUSTAINING MEMBERS

ABB Research Ltd.  
Robert Bosch  
Chevron U.S.A. Inc.  
Enel Produzione SpA  
Ferrovial  
Lockheed Martin  
Saudi Aramco  
Schlumberger  
Siemens  
Total  
United Technologies Corporation  
Weatherford International Ltd.



## MITEI Associate and Affiliate Members

MITEI's Associate and Affiliate Members support a range of MIT energy research, education, and campus activities that are of interest to them. Current members are now supporting various energy-related MIT centers, laboratories, and initiatives; fellowships for graduate students; research opportunities for undergraduates; campus energy management projects; outreach activities, including seminars and colloquia; and more.

### Associate Members

Cummins  
EDF  
Entergy  
Exelon  
Fundació Barcelona Tecnologia (b\_TEC)  
Hess  
ICF International

### Affiliate Members

8 Rivers Capital  
Albachiara Rinnovabili S.r.l.  
Angeleno Group  
Asociación Nacional de Empresas Generadoras  
Aspen Technology, Inc.  
Larry Birenbaum '69  
Bloomberg New Energy Finance  
Constellation Energy  
Jerome I. Elkind '51, ScD '56  
EnerNOC, Inc.  
Gas Technology Institute  
Natalie M. Givans '84  
A. Thomas Guertin PhD '60  
Harris Interactive  
Hogan Lovells US LLP  
IHS Cambridge Energy Research Associates  
Paul Mashikian '95, '97  
Nexant, Inc.

NGP Energy Technology Partners, LP  
NYS Energy Research and Development Authority  
Osaka Gas Co., Ltd.  
Patriot Renewables  
Praxair, Inc.  
Joseph M. Rault '48, President, Rault Resources Group  
Redpoint Ventures  
Philip Rettger '80  
Rockport Capital Partners  
S. Kinnie Smith, Jr.  
Doug Spreng '65  
Steptoe and Johnson, LLP  
George R. Thompson, Jr. '53  
The Tremont Group, LLC  
Tomas Truzzi  
Westport Innovations, Inc.

Members as of May 1, 2012





**Preparing tomorrow's leaders to tackle global energy challenges**

This year, the MIT Energy Initiative (MITEI) awarded grants to 19 MIT graduate students to participate in world-class conferences and meetings or to perform field studies critical to their research. Their destinations and areas of interest are indicated on the map above; details about the students and their activities appear on pages 36–38. Based on the success of that pilot program, MITEI recently established Energy Education Without Borders, an ongoing program of funding to enable MIT graduate students to pursue their work in energy studies across the nation and the globe.