

Energy Recovery Application Manual

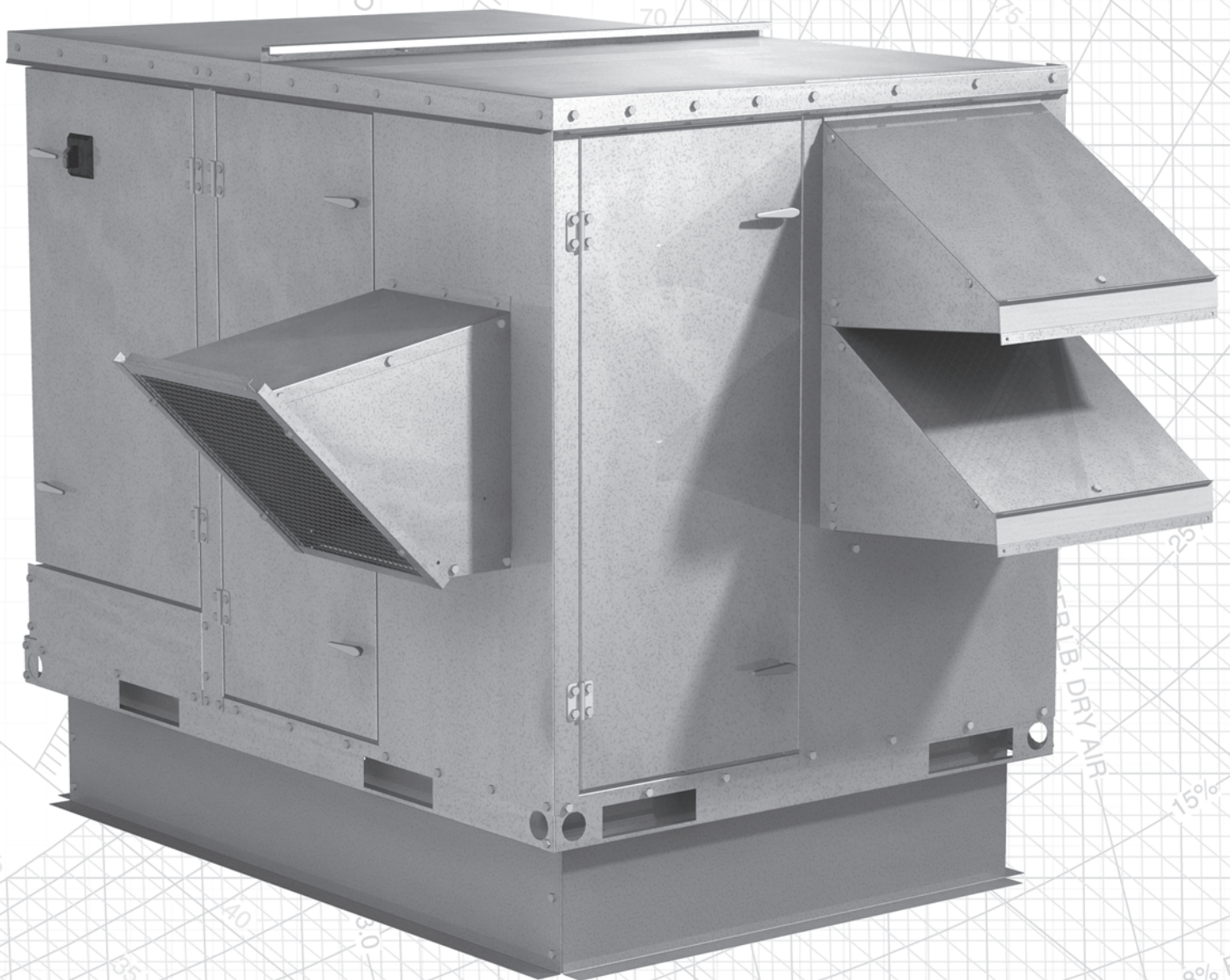

Table of Contents

Chapter 1: The Need for Mechanical Ventilation	3
Chapter 2: The Enthalpy Wheel.....	8
Chapter 3: Product Application - ERV Integrated with the HVAC Equipment	13
Chapter 4: Product Application - ERV De-coupled from the HVAC Equipment.....	21
Chapter 5: Understanding and Calculating Payback Periods.....	27
Chapter 6: Humidity and Its Importance in IAQ	35
Chapter 7: CO2 and Its Importance in IAQ.....	37
Chapter 8: Basics of Psychrometry.....	41

CHAPTER 1

THE NEED FOR MECHANICAL VENTILATION

Modern buildings are tightly sealed from the outside elements for energy conservation purposes. This tight construction means buildings now rely solely on mechanical ventilation to bring in and condition outside air. To provide acceptable Indoor Air Quality (IAQ), ventilation rates must be adequate. This chapter will discuss the need for adequate ventilation and outline the history of ventilation rates.

Indoor Air Quality (IAQ) Facts

- **HEALTH** – Half of all illness in the USA, including cancer, coronary, and respiratory diseases are caused by the pollutants we breath indoors. (National Health Survey 1981, U.S. Department of Health and Human Services).
- **BUILDING CONSTRUCTION** – Energy efficient construction practices mean “tighter” structures that restrict natural ventilation. Mechanical ventilation provides a means to control indoor pollutants including cigarette smoke, volatile organic compounds, solvents, bioaerosols, combustion products and carbon dioxide which would otherwise accumulate in the indoor air.
- **OUTSIDE AIR** – Introducing outside air reduces contaminant concentrations, thereby reducing the health risk.
- **RECYCLING OF COLDS AND FLUS** – Transmission of airborne virus and bacteria among occupants can be reduced with improved ventilation and humidity control, resulting in reduced absenteeism.
- **OCCUPANT COMFORT** – Outside air ventilation provides a more comfortable and productive environment.
- **EXCESS HUMIDITY** – Mechanical ventilation with drier outside air helps to control indoor humidity levels to avoid condensation on cold surfaces resulting in deterioration of windows, walls and structural materials.

Figure 1-1 SBS Symptoms and Ventilation Rates

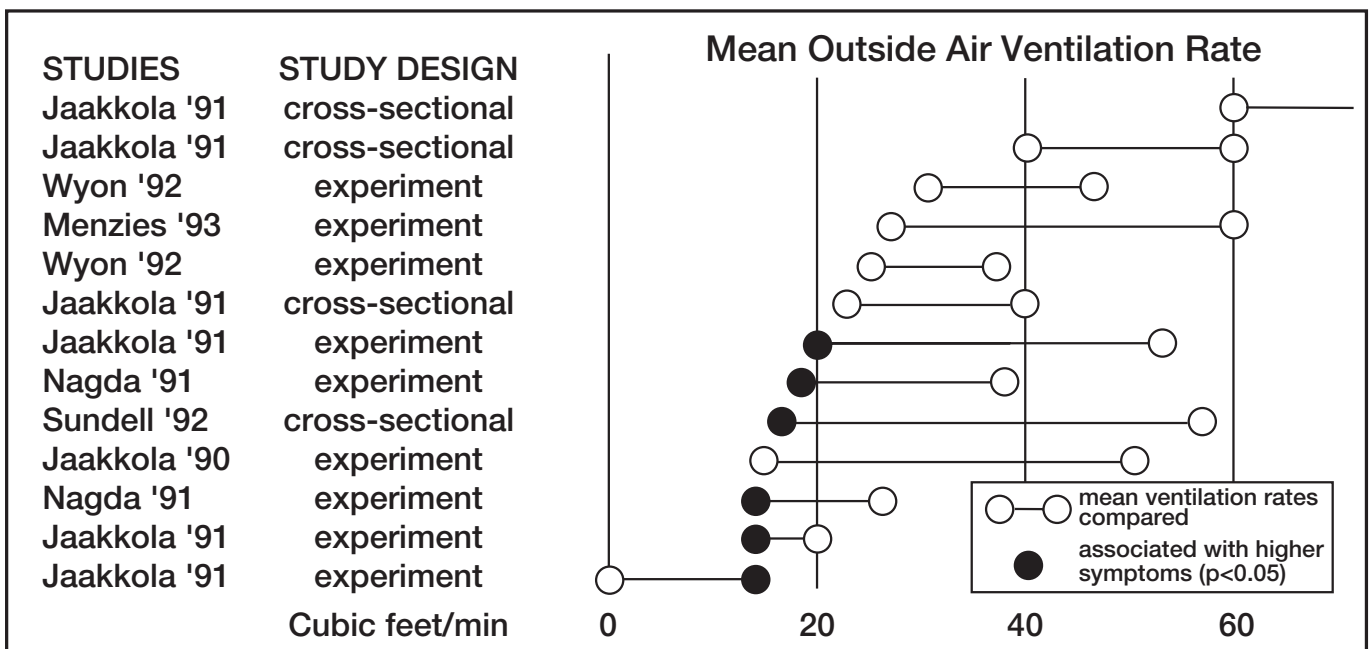

Source: Mendell, 232.

Figure 1-1 above illustrates a direct correlation between ventilation rates and Sick Building Syndrome (SBS) symptoms. The black dots indicate instances of higher SBS symptoms, notice no black dots appear above 20 cfm. Increasing ventilation rates up to 20 cfm per person significantly reduces the frequency of SBS symptoms.

History of Ventilation Rates

For the three decades prior to the energy crisis of the 1970s, mechanical ventilation provided outside air quantities of at least 10 cfm per person. In addition to the mechanical ventilation, natural infiltration and exfiltration helped building ventilation. As a result, indoor air quality was acceptable.

In reaction to the energy crunch, two key changes in building construction were primary contributors to

Sick Building Syndrome and Building Related Illness; tighter construction and reduced ventilation rates. Increased off-gassing of indoor contaminants from office machines and furnishings compounded the problem.

To solve the new set of problems, ASHRAE Standard 62-1989 was developed which prescribes a minimum of 15 cfm per person (ASHRAE 1989).

Figure 1-2 Minimum Ventilation Rates

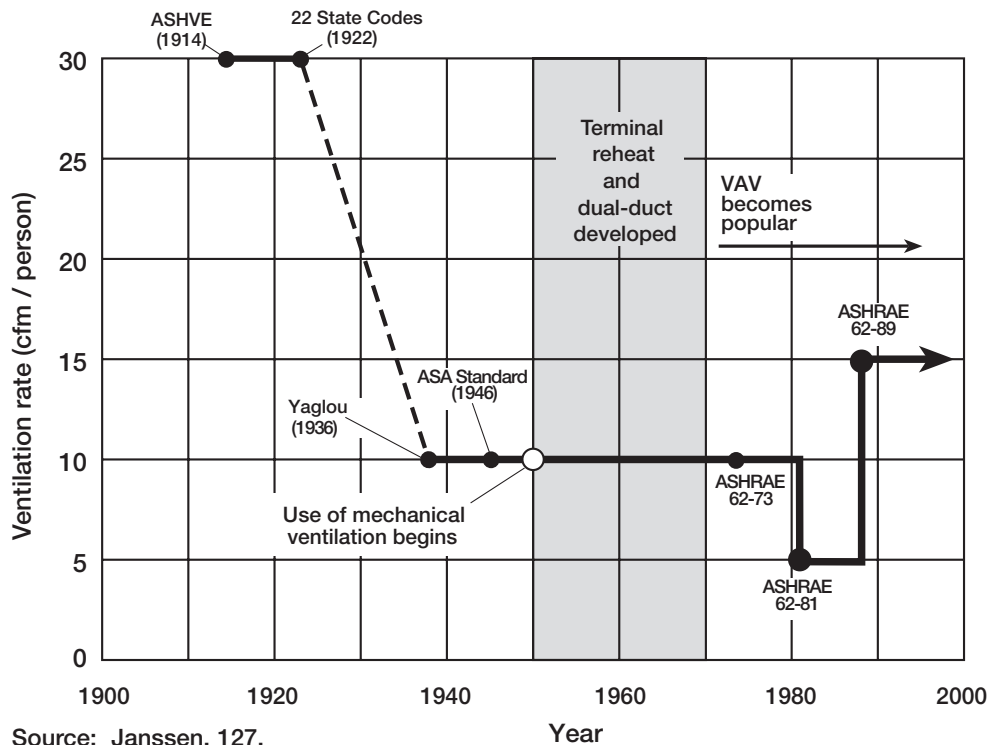

- 1950** Widespread use of mechanical ventilation begins (Mechanical ventilation dates back to the early 1900s).
- 1973** American Society of Heating, Refrigeration and Air Conditioning Engineers (ASHRAE) wrote Standard 62-73, *Standard for Natural and Mechanical Ventilation*. This Standard required a minimum of 10 cfm per person of outside air, but “recommended” outside air ventilation rates in the 15 to 25 cfm per person range. However, the 10 cfm minimum reduced to 5 cfm with properly filtered recirculated air. This Standard was endorsed by the American National Standards Institute (ANSI) and adopted in whole or in part by many state and city building codes.
- 1975** With the Arab Oil Embargo and energy crisis, ASHRAE wrote Standard 90-75, *Energy Conservation in New Building Design*, which specified the minimum rates in Standard 62-73. Thus, ventilation was reduced to 5 cfm of outside air per person. (Janssen 130).
- 1981** ASHRAE Standard 62-73 was revised as Standard 62-81. Standard 62-81 required 5 cfm per person of outside air, but required three to five times as much ventilation where smoking was allowed (Janssen 130). This Standard was not endorsed by ANSI, because of the Standard’s lack of plausible explanation for the difference in ventilation rate.
- 1989** ANSI/ASHRAE Standard 62-89 was written and specifies 15 cfm per person of outside air as the minimum using the Ventilation Rate Procedure. Standard 62-89 does not discriminate between smoking-allowed and smoking-prohibited. The new Standard did prescribe high ventilation rates in bars, cocktail lounges, and smoking lounges. (Janssen 130).

ASHRAE Standard 62-1989

The ventilation rates that Standard 62-89 prescribes are based on research that linked ventilation rates to acceptable indoor air quality. Studies produced charts like Figure 1-1 and Figure 1-3 below.

Figure 1-3: Odds of SBS Symptoms vs. Outside Airflow Rate

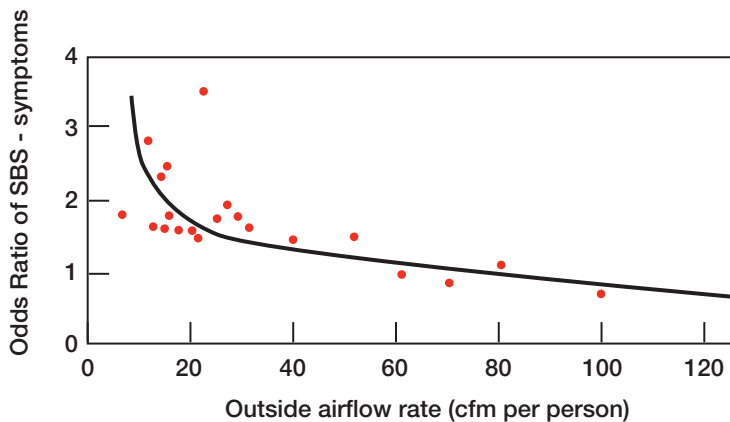

Figure 1-3 compares the statistical odds that SBS (SBS) and Building Related Illness (BRI) symptoms will occur at various ventilation rates. Note that below 20 cfm per person the probability of SBS symptoms increases dramatically.

Source: Sundell, 56.

Compliance to Standard 62

- **Architects, Engineers, Environmental Agencies, State and Model Building Codes** are specifying the increased outside air ventilation requirements of ASHRAE Standard 62-1989, *Ventilation for Acceptable Indoor Air Quality*. As of the summer of 1996, 33 states have adopted Standard 62 in their building code.

- **Compliance with ASHRAE 62-1989** is an engineer's only defense against litigation for claims of Sick Building Syndrome.

- **Comments on the standard from one lawyer:** "What lawyers see in this document is quite different from what engineers perceive in this helpful design standard. This standard provides the engineering community with guidelines; it also provides the lawyers with ammunition. The obvious implication of ASHRAE Standard 62-1989 is that failure to meet these outlined ventilation standards results in unacceptable indoor air quality. If someone has a building-related illness and you have not complied with this standard, the courts and juries are probably going to find you liable." (Dozier 116).

- **Comments from another lawyer:** "ASHRAE standards are being used as minimum criteria by which to judge the quality of any engineer's ventilation design. If an engineer fails to design a system in conformity with the appropriate ASHRAE standards, it will be virtually impossible for him to defeat a claim of negligence." (Dozier 116).

- **Federal update:** It was recently confirmed that several federal agencies require conformance with ASHRAE Standard 62-1989 in new design and some retrofit. Among these are the General Services Administration, the Dept. of Defense, the Veterans Administration, the Dept. of Energy, the Environmental Protection Agency, and the U.S. Postal Service. (Dozier 116).

The expressed purpose of ASHRAE Standard 62-1989 is to specify minimum ventilation rates and indoor air quality that will be acceptable to human occupants and are intended to minimize the potential for adverse health effects. To accomplish this, the standard specifies two alternative procedures to obtain acceptable air quality. They are:

1. Ventilation Rate Procedure
2. Indoor Air Quality Procedure

Why the “Indoor Air Quality” Procedure is Rarely Used

Very few engineers are using the Indoor Air Quality Procedure because of its indefinite nature, and most engineers feel it is not possible to “control known and specifiable contaminants” in the space. Although there is information available regarding limits on levels of specified contaminants, it is not complete or specific enough to ensure acceptable air quality. (Harper 1).

Standard 62-1989 states that the rates for outside airflow in Table 2 are absolute values and cannot be reduced unless the Indoor Air Quality Procedure is also used; then “clean recirculated air should be used to reduce particulate, and WHERE NECESSARY AND FEASIBLE, GASEOUS CONTAMINANTS.”(Harper 2).

To engineers the Indoor Air Quality Procedure means carbon or chemical air filter media. The Standard diagrams the use of filtration in the recirculated or mixed airstream. However, several other options are available, including (Harper 2):

1. Use a carbon by-pass on a true supply to return by-pass (Harper 2).
2. Send the amount of reduced outside air (from Table 2) through the carbon in the return and allow the balance of recirculated air to go to the particulate filters in the air handling unit (Harper 2).

These solutions have not been popular because of relatively high first cost, space requirements (limitations), and difficult maintenance due to sampling, handling, etc. The lack of complete or specific information on contaminant concentrations suggest this option is a poor defense against litigation.

Therefore, most engineers use the Ventilation Rate Procedure.

Ventilation Rate Procedure

By far, the most commonly practiced procedure, the Ventilation Rate Procedure prescribes the rate at which ventilation (outside) air must be delivered to a space. Table 2 lists the ventilation air required for various spaces in terms of CFM/person or CFM/ft². Some of these values are listed below:

Table 1-1 ASHRAE 62-89 Recommended Ventilation Rates

Application	Ventilation Rate per person	Application	Ventilation Rate per person
Office Space	20 cfm	Smoking	60 cfm
Restaurants	20 cfm	Beauty Salon	25 cfm
Bars/Cocktail	30 cfm	Supermarkets	15 cfm
Hotel Rooms	30 cfm/room	Auditorium	15 cfm
Conference Rooms	20 cfm	Classrooms	15 cfm
Hospital Rooms	25 cfm	Laboratory	20 cfm
Operating Rooms	30 cfm	General Retail	15 cfm

Source: Schell, 58.

Engineers perceive that complying to this procedure is easier to do and easier to defend against litigation. The solution, in simple terms, is to increase the amount of ventilation air.

The main challenge engineers have with designing an HVAC system that complies with the Ventilation Rate Procedure is controlling the equipment and energy consumption costs.

The Role of Energy Recovery

The current Standard (62-1989) requires three to four times more outside air than the previous Standard (62-1981). Using a traditional HVAC system, the increase in outside air translates into higher first cost, and higher operating costs. Additionally in high humidity climates, like the southeastern United States, the traditional HVAC system is not capable of maintaining desired indoor humidity levels throughout the day.

Incorporating Energy Recovery Ventilators into HVAC Systems is becoming a popular choice for engineers to economically comply to ASHRAE Standard 62-1989.

Energy Recovery Ventilators benefit HVAC systems in the following areas:

- **Humidity Control** – Energy recovery ventilators are perfectly suited to help control humidity. In the summer, when outside humidity is high, the energy wheel dehumidifies the outside air. This greatly reduces the latent load on the air conditioning equipment and also eliminates rising indoor humidity levels that can occur in hot, humid climates. In the winter, when outside air is dry, the energy wheel humidifies the outside air. This increases comfort and reduces the amount of humidification required.

Humidity is an important factor to consider for providing both comfortable room conditions and a healthy environment. More than 75% of all IAQ problems start with comfort complaints. If these are not addressed, employees will continue to complain and become less productive. From the health perspective, humidity levels that are too high may promote growth of mold, bacteria, viruses and fungi. Low humidity may cause irritation and increase respiratory symptoms.

- **Economic Solution** – Low first cost and maximum energy savings combine to yield an extremely attractive payback on Greenheck Energy Recovery Ventilators. By incorporating ERVs into the HVAC system, air conditioning and heating equipment can be downsized considerably. In the hot and humid climates that surround the gulf coast, the energy recovery ventilator cost is offset by the avoided increase in air conditioning equipment cost alone; payback is immediate. In many other climates, payback is typically less than one year.

See Chapter 5 for initial cost and pay back for Greenheck ERV products.

- **Maintenance** – Proper maintenance is the key to extending the life of any component within an HVAC system and also improves Indoor Air Quality. Greenheck energy recovery ventilators are extremely low maintenance with blower, motor, energy wheel and drive components all readily accessible through removable side panels.

CHAPTER 2

THE ENTHALPY WHEEL

Greenheck's energy recovery ventilators incorporate an enthalpy or "total energy" wheel to transfer energy from the warm airstream to the cool air stream and vice-versa. The silica gel desiccant bonded to the wheel enables both sensible and latent energy to be transferred between airstreams with effectiveness up to 83%.

How It Works

The sensible energy transfer occurs simply because the wheel heats up in the warm air stream and then transfers the heat to the cool airstream. The warm airstream cools down and the cool airstream warms up. Moisture is transferred in a similar manner. The enthalpy wheel saves energy in both summer and winter conditions. During the summer, the wheel cools the fresh outside air and rejects moisture. During the winter, the wheel heats and humidifies the fresh outside air.

Summer

The energy recovery wheel pre-conditions the fresh ventilation air from the "Outside Air" point to the "Air Leaving Wheel" point. Seen in Figure 2-1.

The dashed line shows a typical air conditioning cycle.

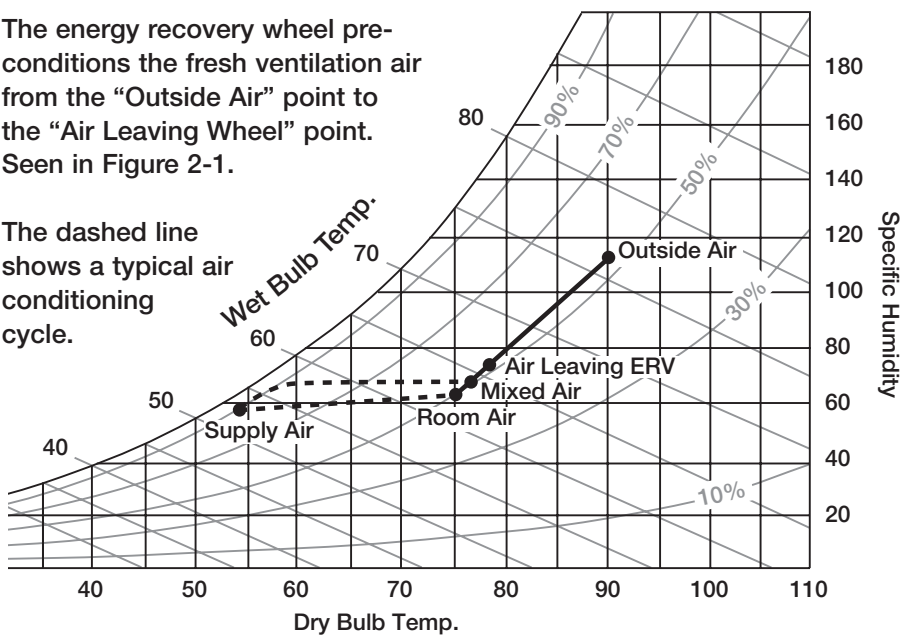

Figure 2-1

Greenheck ERV

- Cools outside air with up to 83% effectiveness of sensible heat transfer.
- Extracts moisture from outside air with up to 83% effectiveness of latent energy transfer.
- Reduces ventilation cooling load up to 4 tons per 1000 cfm.

Figure 2-2 illustrates the sensible cooling of an 80% effective wheel, which cools outside air from 90°F DB to 78°F DB. Additionally, moisture is stripped out of the outside air. The outside conditions are 76°F wet bulb and 113 grains of moisture per pound of dry air. After passing through the energy recovery wheel, the air conditions are 65.5°F wet bulb and only 74 grains of moisture per pound of dry air.

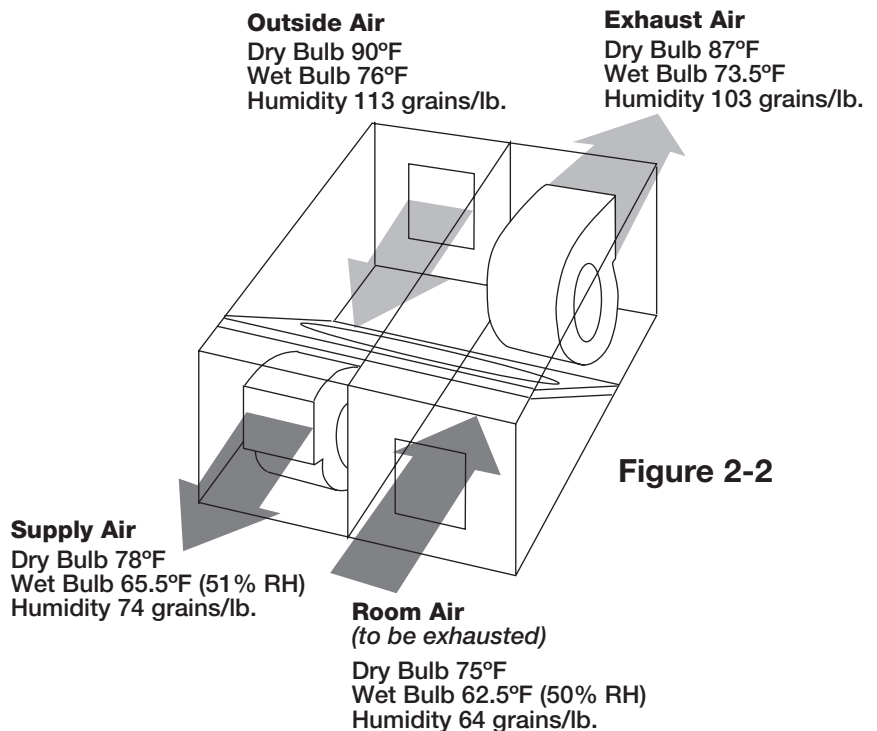

Figure 2-2

Table showing tons reduction per 1000 cfm for various cities in the U.S.

CITY	EQUIPMENT SIZE REDUCTION COOLING EQUIPMENT (Tons)	CITY	EQUIPMENT SIZE REDUCTION COOLING EQUIPMENT (Tons)
Albany, GA	4.3	LaCrosse, WI	3.2
Boise, ID	2.3	Los Angeles, CA	1.6
Brunswick, ME	2.9	Miami, FL	4.3
Chicago, IL	3.4	Minneapolis, MN	3.1
Cincinnati, OH	3.1	Nashville, TN	2.9
Denver, CO	2.1	Niagara Falls, NY	2.3
Des Moines, IA	3.7	Phoenix, AZ	4.0
Duluth, MN	1.8	San Francisco, CA	1.1
Ft. Bragg, NC	3.7	Seattle, WA	1.1
Ft. Worth/Dallas, TX	3.7	Spokane, WA	1.8
Houston, TX	4.3	Tucson, AZ	3.1
Kansas City, MO	3.7	Washington, DC	3.4

Calculations are based on indoor conditions of 70°F in winter and 75°F in summer. Outside conditions were obtained from the ASHRAE Fundamentals Handbook 1993.

Winter

The energy recovery wheel pre-conditions the fresh ventilation air with recovered heat to increase air temperature from the “Outside Air” point to the “Supply Air” point. Seen in Figure 2-3.

Supplemental heating may be required to bring the supply air up to the desired temperature.

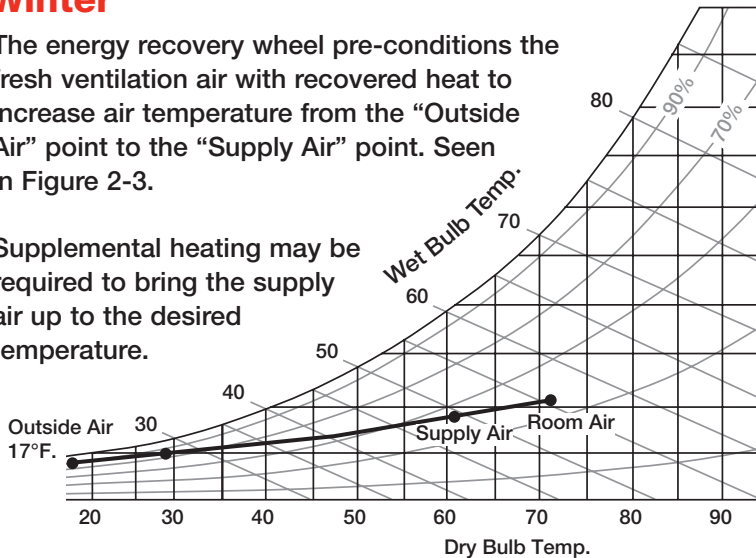

Figure 2-3

Figure 2-4 illustrates the sensible heating of a 80% effective wheel, which warms outside air from 17°F DB to 61°F DB. Additionally, moisture is added to the outside air. The outside moisture content is only 11 grains per pound of dry air. After passing through the wheel, the supply air is humidified to 35 grains per pound of dry air.

Greenheck ERV

- Heats outside air with up to 83% effectiveness of sensible heat transfer.
- Adds moisture from outside air with up to 83% of latent energy transfer.
- Reduces heating and humidification costs by up to 50,000 Btu-h per 1000 cfm at design temperature cfm.

Outside Air
Dry Bulb 17°F
Humidity 11 grains/lb.

Exhaust Air
Dry Bulb 28°F
Humidity 17 grains/lb.

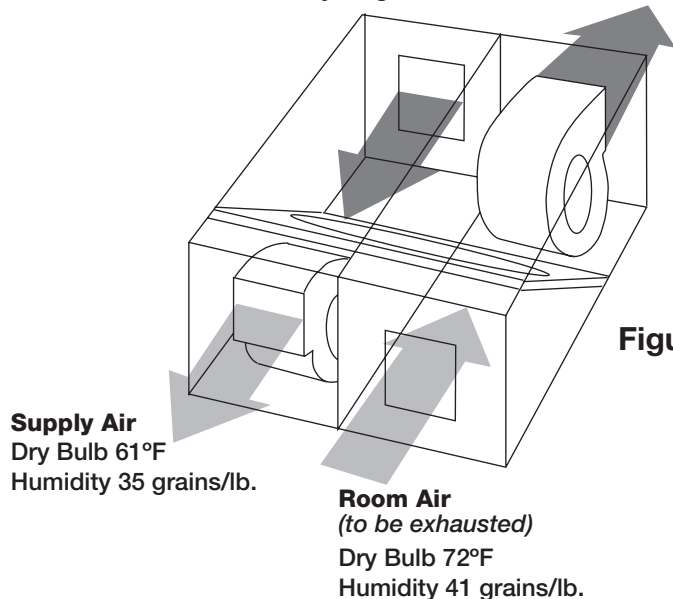

Figure 2-4

Supply Air
Dry Bulb 61°F
Humidity 35 grains/lb.

Room Air
(to be exhausted)
Dry Bulb 72°F
Humidity 41 grains/lb.

Power of the Wheel

The powerful function of the total energy wheel is that it works on **any** outside air condition. Whether at full load or part load, high or low relative humidity, winter or summer. The wheel always transforms outside air into near room conditions. When outside air is mixed with return air, the mixture is usually within 2°F of the room air. Figure 2-5 illustrates the energy wheels function for both winter and summer.

Figure 2-5

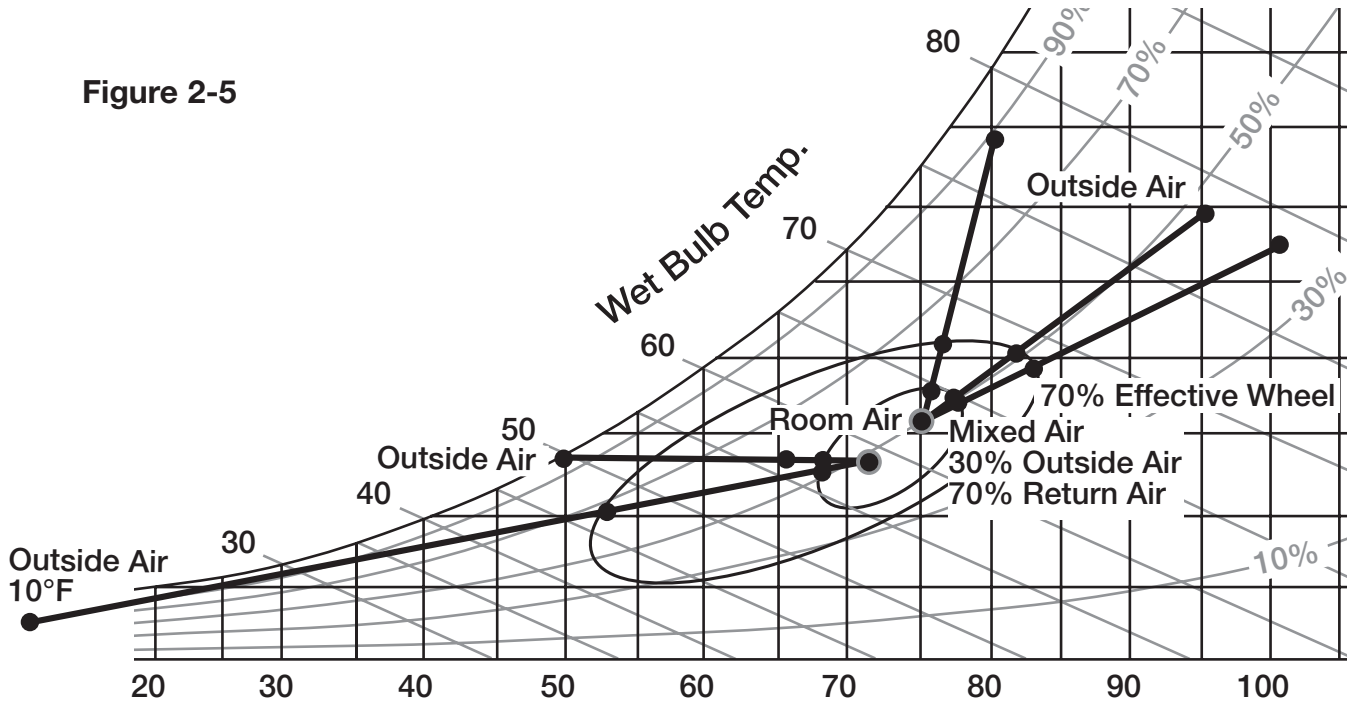

Wheel Technology

Then

Industry veterans may recall all of the problems with energy wheels when they were used following the 1970s energy crisis. Keep in mind, these wheels were designed for industrial applications with their size and weight, purge sections and calibrated labyrinth seals. They required continual, difficult maintenance and adjustment to perform properly.

When overly eager sales people saw an opportunity for energy recovery that was created by the energy crisis, they promoted their product within the commercial market. However, it's not surprising that the approach floundered; most commercial facilities have neither the desire nor the staff to maintain an industrial wheel. The **concept** was sound, but the **product** was wrong.

Now

Greenheck's wheels are designed specifically for commercial and institutional installations with minimal maintenance in mind. The energy exchange media is a light-weight polymer that minimizes bearing load and greatly increases wheel reliability. Silica gel desiccant is permanently bonded to the polymer, which provides a long energy transfer life. When inspection or cleaning is required, wheel cassettes easily slide out of the ventilators and wheel segments are easily removed in seconds without the use of tools.



Low Maintenance

Proper maintenance is the key to extending the life of any component within an HVAC system and also improves Indoor Air Quality.

One way to help assure that maintenance is done properly is to minimize the work involved for the people who do it. With this in mind, we designed our energy recovery ventilators so that they require minimal maintenance. When it is required, we make access and servicing as simple as possible. Here's how:

- Removable side panels enable easy access to energy wheel, blowers, motors and drive components.
- Wheel cassette slides out easily for inspection and maintenance.
- Wheel sections are easily removable, without tools, for periodic cleaning.
- Filters are easily accessible.
- No need for condensate drains. Moisture is transferred entirely in the vapor phase.
- Light weight polymer enthalpy wheel contributes to low shaft and bearing loads, resulting in reliable, long life operation.

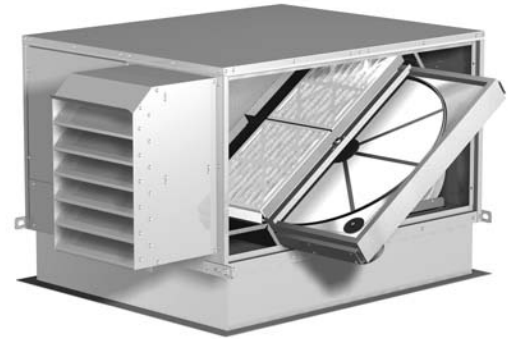

No Condensation

During both summer and winter, Greenheck's energy recovery wheel transfers moisture entirely in the vapor phase. This eliminates wet surfaces that retain dust and promote fungal growth. It also eliminates the need for a condensate pan and drain to carry away water.

Self Cleaning

Because it is constantly rotating, the energy recovery wheel is always being cleaned by counterflowing air streams. Because the wheel is always dry, dust and other particles impinging on the surface during one half cycle are automatically removed during the next half cycle. This cleaning process occurs with every wheel revolution, approximately 30 and 60 times per minute for standard flow and high flow wheels, respectively.

Cross Leakage

Cross Leakage between air stream is in the 3-5% range. For most commercial and institutional applications, recirculating a small percentage of air is not a concern. Cross leakage simply means that 3-5% of the air to be exhausted never left the building.

Cross leakage is a concern for critical applications such as hospital operating rooms, laboratories and clean rooms. In these applications, it is Greenheck's opinion that energy recovery wheels (with or without purge sections) should not be use, if the system serving discrete, different spaces where harmful pathogens or toxins might be transferred from one space to another.

Low Frost Threshold

The frost threshold is the outside temperature at which frost will begin to form on the energy recovery wheel. Greenheck energy recovery ventilators have a low frost threshold, typically below 5°F. Frost threshold is dependent on the indoor temperature and humidity. The table at right shows how frost threshold temperatures vary depending on indoor conditions.

Indoor RH at 70°F	Frost Threshold Temperature
20%	0°F
30%	5°F
40%	10°F

Desiccant Characteristics

Figure 2-6 shows characteristic curves of weight percent adsorbed versus relative humidity of the airstream for various desiccants. For relative humidities above 35%, silica gel provides by far the most effective method of transferring moisture. This characteristic of silica gel makes it the logical choice for commercial and institutional comfort ventilation applications, where relative humidities of supply and exhaust air typically range from 35% to 80%.

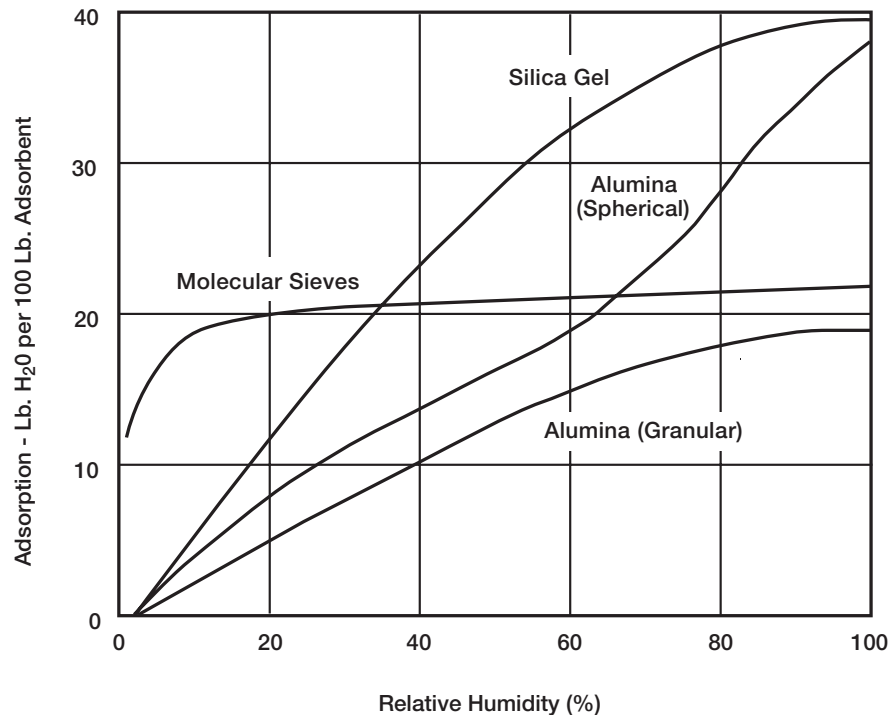

Source: Davison Chemical Co.

Figure 2-6

Latent Energy Transfer

Silica gel is a highly porous solid adsorbent material that structurally resembles a rigid sponge. It has a very large internal surface area composed of myriad microscopic cavities and a vast system of capillary channels that provide pathways connecting the internal microscopic cavities to the outside surface of the “sponge.” (Hoagland 1).

Adsorption of water vapor occurs principally by two different mechanisms. On a completely dry or clean silica gel, water vapor molecules are first adsorbed onto the surface by “molecular attraction.” This adsorption mechanism causes a mono-molecular layer of water molecules to attach to the silica gel surface. After all of the surface is coated with this single molecular layer of water, more water is attracted and stored in the capillary channels by the mechanism of “capillary condensation.” (Hoagland 1).

Capillary condensation works in the following manner. The water wets the walls of the capillary channel and forms a meniscus concave to the vapor phase. The vapor pressure over the meniscus is lower than the normal vapor pressure of the liquid by an amount proportional to the degree of curvature of the meniscus. Hence small capillaries such as the narrow sections of the pore channels, vapors can condense at pressure far below normal vapor pressure. Small diameter pores give larger lowering of the pressure resulting in more adsorption at lower pressures and relative humidities. (Hoagland 1).

Selective Adsorption of Water

Desiccants, such as silica gel, are capable of adsorbing many different chemical species in addition to water vapor. This characteristic has led to some people to question whether or not the silica coated energy recovery wheel would transfer other gaseous contaminants in addition to water vapor. Many different chemical species can be adsorbed onto silica gel, however, highly polar molecules such as water vapor have a much stronger attraction for the silica surface. (Hoagland 2).

In other words, the forces of attraction between silica gel and water vapor are much stronger than the forces of attraction between silica gel and other chemical species. These forces of attraction lead to competition for adsorption sites between water vapor and other chemical species. Adsorption sites are locations on the silica gel surface to which water molecules adhere. In the process of competing for adsorption sites, the highly polar water molecule wins out over virtually all other chemical species. In fact, if a water molecule comes along, it will chase off the other molecule and move into the adsorption site because its attractive forces are so much stronger. (Hoagland 2).

CHAPTER 3

PRODUCT APPLICATION: ERV INTEGRATED WITH THE HVAC EQUIPMENT

Energy Recovery Ventilators (ERVs) may be applied in many HVAC installations. Integrating the energy recovery ventilator into the air conditioning duct system is a common installation. This approach enables the specifying engineer to use the same basic design as traditional HVAC systems, but with the savings provided by energy recovery. The main modifications, as compared to traditional systems, simply involve routing fresh outside and stale exhaust air through the energy recovery ventilator. In most cases, additional ductwork is minimal.

This means of providing adequate outside air to the occupied spaces is the same in concept no matter how the air conditioning equipment is configured. Since the energy recovery ventilator and air conditioning equipment are integrated, or coupled together, the appropriate amount of fresh outside air is provided whenever the air conditioning equipment fan is operating.

There are many system configurations that utilize this concept. Two sample installations are shown below.

With Packaged Rooftop Equipment

Figure 3-1 illustrates how energy recovery ventilators may be used in conjunction with packaged rooftop equipment. Fresh, outside air enters the energy recovery ventilator and is pre-treated before entering the heating / cooling equipment. The energy source for pre-treating the outside air is the portion of the return air to be exhausted through the energy recovery ventilator.

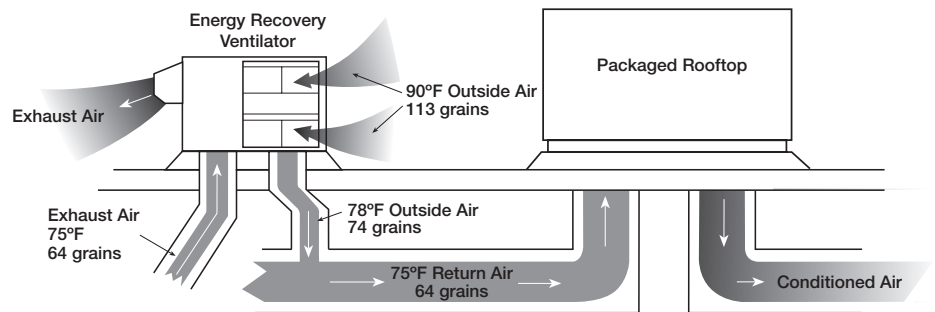

Figure 3-1

With Ducted Air Handlers

Energy recovery ventilators may be used in conjunction with ducted air handling or fan coil units. A single energy recovery ventilator may provide fresh outside air for multiple air handling units (as shown below) or in a one-to-one ratio where a single energy recovery ventilator and air handler serves only one space. For maximum design flexibility, the energy recovery ventilator may be roof mounted or duct mounted.

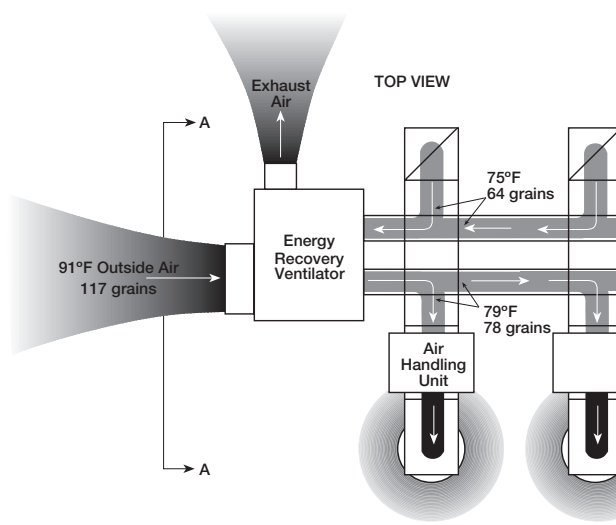

Figure 3-2

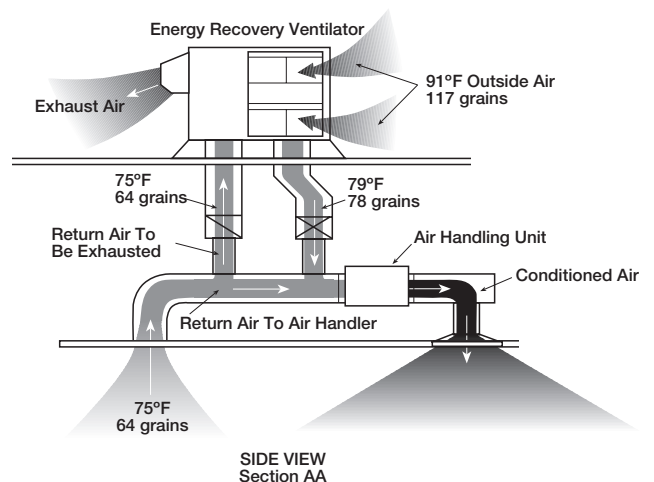

Figure 3-2 above shows the plan view of a single energy recovery ventilator providing fresh outside air to multiple air handling units.

Figure 3-2 shows the elevation view of the energy recovery ventilator and air handler in an integrated duct system.

CONTROLLING EQUIPMENT COSTS IN NEW CONSTRUCTION

Besides the obvious benefit of reducing operating costs, total enthalpy wheels can significantly reduce the size of air conditioning equipment. Our examples will concentrate on the air conditioning cycle to demonstrate this point. It should be noted that these are simple examples intended to focus on the impact of energy recovery in HVAC design.

To illustrate the impact of sensible and latent recovery ventilators, two examples are provided. The first example is a “traditional” system **without** the use of energy recovery. The second example shows the energy recovery solution to the same design challenge.

Example **without** Energy Recovery

Our summer design condition is 91°F DB/77°F WB. At these conditions, the HVAC system was sized for 10,000 cfm, and to comply with ASHRAE 62-89, an outside air volume of 3,000 cfm air is specified. A 40 ton HVAC unit is required to handle the building room and outside air loads.

Design conditions:

Outside Air	Room Air	Supply Air
91°F DB	75°F DB	55°F DB
77°F WB	50% RH	53°F WB
40.4 Btu/lb.	28.2 Btu/lb.	22.0 Btu/lb.

Note: Supply air condition determined from room load calculation.

Mixed Air

Room Air (7,000 cfm) and Outside Air (3,000 cfm) combine to become Mixed Air (10,000 cfm). The Mixed Air point on the psychrometric chart lies on a straight line between the Room Air and Outside Air points. Since the Room Air is 70% of the total airflow after mixing, the Mixed Air point is located at a point 70% of the distance from Outside Air to Room Air. At this point, the air properties are:

79.8°F DB 67.4°F WB 31.9 Btu/lb

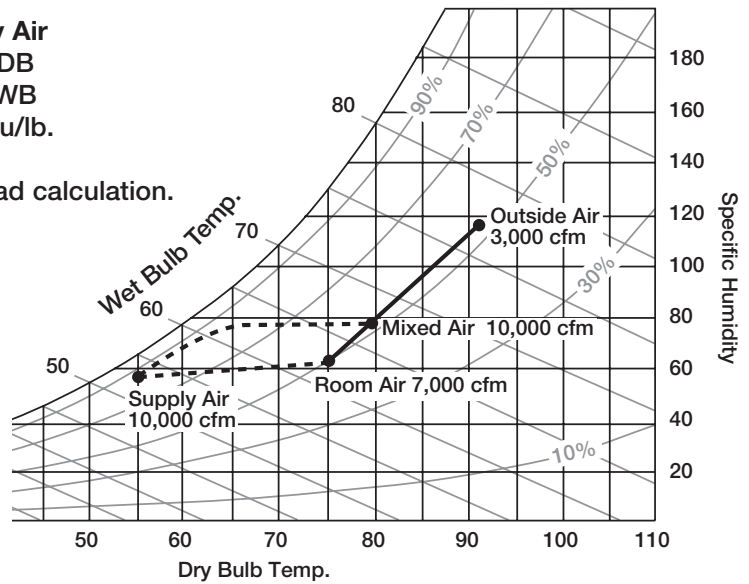

Figure 3-3

The air conditioning unit must be capable of cooling the 10,000 CFM from mixed air conditions down to supply air conditions to handle both room load and outside air loads. The total cooling load is dependent on cfm and enthalpy difference.

In this case, the enthalpy difference (Δh) from mixed air (79.8°F DB/67.4°F WB) to supply air (55°F DB/53°F WB) is:

$$\Delta h = h_{\text{mixed air}} - h_{\text{supply air}} = 31.9 \text{ Btu/lb.} - 22.0 \text{ Btu/lb.} = 9.9 \text{ Btu/lb.}$$

Therefore, the air conditioning load is:

$$\text{Total Cooling Load} = \frac{4.5 * \text{Airflow Rate (CFM)} * \Delta h}{12,000} = \frac{4.5 * 10,000 \text{ CFM} * 9.9 \text{ Btu/lb.}}{12,000} = 37.1 \text{ tons}$$

Example with Energy Recovery

Incorporating energy recovery into the HVAC system is a good design practice for providing adequate indoor air quality while controlling costs. To optimize the benefits, energy recovery and air conditioning/heating equipment should be sized simultaneously. Energy recovery significantly reduces the outside air load, which enables reduction in the total cooling tonnage required. The credit for air conditioning equipment reduction should be taken for two important reasons:

1. Air conditioning equipment reduction is a major component of the payback analysis.
2. If air conditioning equipment is not downsized as energy recovery allows, it will be oversized. Oversized equipment will have shorter “on cycles”, which reduces the ability to drain water from the coil and enables more moisture to evaporate off the coils. This leads to raised indoor humidity levels.

This example uses the same design conditions as the previous example. The only difference is that this case will incorporate energy recovery into the system design. Model ERV-521S will be used to recover the energy from the 3,000 cfm exhaust airstream with an efficiency of 75%. This will result in pre-treating the Outside Air prior to entering the air conditioning equipment.

Design conditions:

Outside Air	Room Air	Supply Air
91°F DB	75°F DB	55°F DB
77°F WB	50% RH	53°F WB
40.4 Btu/lb.	28.2 Btu/lb.	22.0 Btu/lb.

Air Leaving Wheel

The ERV-521S exhausts 3,000 cfm of return air and supplies 3,000 cfm of fresh, Outside Air. As this happens, the properties of the exhaust air are transferred to the outside air with an efficiency of 75%. The result is outside air leaving the wheel at a point 75% of the way from the outside air point to the room air point. Therefore, the Air Leaving Wheel conditions are:

79°F DB	66.5°F WB	31.1 Btu/lb
---------	-----------	-------------

Mixed Air

After the outside air is pre-conditioned by the energy wheel, it mixes with the return air. The Mixed Air point is located 70% of the way from the Air Leaving Wheel point to the Room Air point. At this point, the conditions are:

76.2°F DB	63.9°F WB	29.0 Btu/lb
-----------	-----------	-------------

In this case the enthalpy difference from mixed air (29.0 Btu/lb.) to supply air (22.0 Btu/lb.) is 7.0 Btu/lb. Therefore, the air conditioning load is:

$$\text{Total Cooling Load} = \frac{4.5 * \text{Airflow Rate (CFM)} * \Delta h}{12,000} = \frac{4.5 * 10,000 \text{ CFM} * 7.0 \text{ Btu/lb.}}{12,000} = 26.25 \text{ tons}$$

This system would require a 30 ton HVAC unit. The ERV reduces the total cooling load by over 10 tons. For this example, most of the ERV cost is offset by reducing the size of the HVAC equipment. For details on payback, see chapter 5. Note: for simplicity, both examples are considered to use 10,000 cfm supply air; in fact, the smaller system will have the capacity to meet the load at a reduced air flow, saving additional fan power.

New Construction Summary

Energy recovery ventilators are an excellent mechanism for providing indoor air quality while controlling costs in new construction applications. The previous two examples show how a Greenheck ERV significantly reduces the outside air load in an HVAC system. This reduction allows for reductions in equipment size, which translates to large savings in HVAC equipment, installation and operating costs.

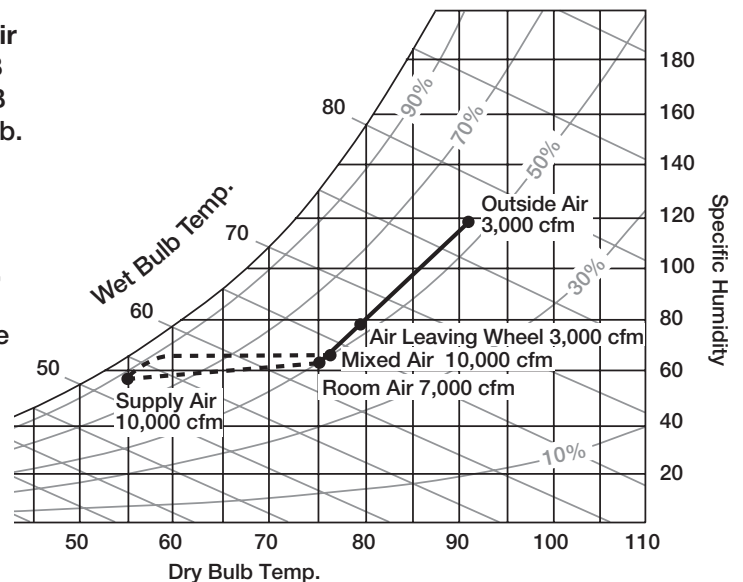

Figure 3-4

IAQ GAINS AND ENERGY SAVINGS IN RETROFIT APPLICATIONS

Cases that require increased outside air quantities in existing buildings provide an ideal application for ERVs. The ERV makes it possible to increase the outside air volumes by three to four times without changing out or adding to the HVAC equipment.

We will demonstrate how this works using an example with summer design conditions of 91°F DB/ 77°F WB. At design conditions, the system was originally sized for 10,000 total cfm with 1,000 cfm of outside air. Now, the outside air requirements need to be increased to 3,000 cfm. Our challenge is to increase the outside air requirements while controlling first cost, operating cost and indoor humidity levels.

Let's start out by looking at the existing system on a psychrometric chart. As in the New Construction section, we will focus on the air conditioning cycle.

Existing System: 30 ton capacity

Design conditions:

Outside Air	Room Air	Supply Air
91°F DB	75°F DB	55°F DB
77°F WB	50% RH	53°F WB
40.4 Btu/lb.	28.2 Btu/lb.	22.0 Btu/lb.

Mixed Air

Room Air (9,000 cfm) and Outside Air (1,000 cfm) combine to become Mixed Air (10,000 cfm). Since the Room Air is 90% of the total airflow after mixing, the Mixed Air point is located at a point 90% of the distance from Outside Air to Room Air. At this point, the air properties are:

76.6°F DB	64.3°F WB	29.3 Btu/lb
-----------	-----------	-------------

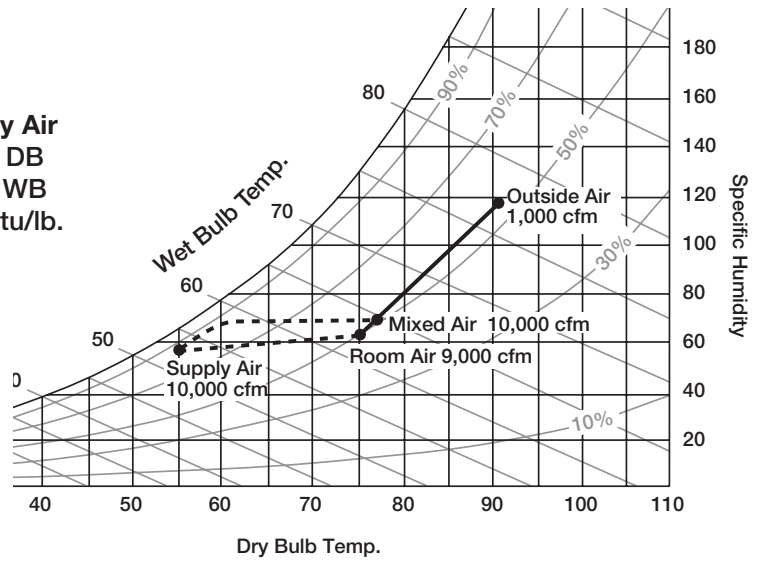

Figure 3-5

The HVAC unit was sized to provide cooling of the 10,000 CFM from mixed air conditions down to supply air conditions.

In this case, the enthalpy difference (Δh) from mixed air (29.3 Btu/lb.) to supply air (22.0 Btu/lb.) is 7.3 Btu/lb.

Therefore, the total cooling load is:

$$\text{Total Cooling Load} = \frac{4.5 * \text{Airflow Rate (CFM)} * \Delta h}{12,000} = \frac{4.5 * 10,000 \text{ CFM} * 7.3 \text{ Btu/lb.}}{12,000} = 27.38 \text{ tons}$$

The original 30 ton unit has enough capacity for this case. Now let's look at what happens to the cooling load when the outside air volume increases to 3,000 cfm.

Cooling Load with Increased Outside Air Volume

The design conditions of Outside Air, Room Air and Supply Air are the same as in the previous example. The only change is that the outside air volume has been increased from 1,000 cfm to 3,000 cfm. The total airflow for the air conditioning unit has remained at 10,000 cfm (the building load has not changed).

Let's see what impact the increased outside air volume has on the cooling load.

Modified System **without** Energy Recovery

Design conditions:

Outside Air	Room Air	Supply Air
91°F DB	75°F DB	55°F DB
77°F WB	50% RH	53°F WB
40.4 Btu/lb.	28.2 Btu/lb.	22.0 Btu/lb.

Mixed Air

The Mixed Air point has changed from the previous example. Room air is now only 7,000 cfm and outside air is now 3,000 cfm. Since the Room Air is 70% of the total airflow after mixing, the Mixed Air point is located at a point 70% of the distance from Outside Air to Room Air. At this point, the air properties are:

79.8°F DB 67.2°F WB 31.9 Btu/lb

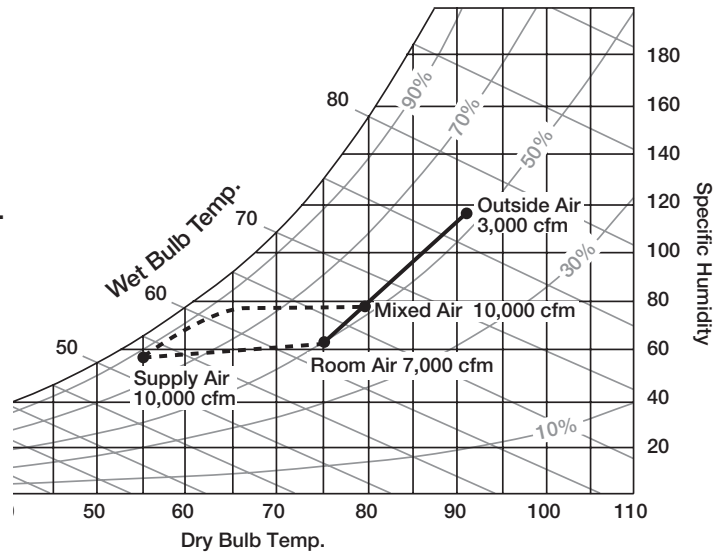

Figure 3-6

For this modified system, the enthalpy difference (Δh) from mixed air (31.9 Btu/lb.) to room air (22.0 Btu/lb.) is: 9.9 Btu/lb.

Therefore, the air conditioning load is:

$$\text{Total Cooling Load} = \frac{4.5 * 10,000 \text{ CFM} * 9.9 \text{ Btu/lb.}}{12,000} = 37.1 \text{ tons}$$

The 30 ton unit is no longer capable of handling the new requirements. Therefore, the HVAC equipment must either be added to or replaced to provide the thermal conditioning required. If an extra 10 tons of air conditioning was added, the retrofit cost would be a minimum of \$1,000 per ton or \$10,000 total. Additionally, energy consumption costs would increase significantly.

Fortunately, there is a much better solution for solving this problem than adding cooling tonnage or replacing the existing air conditioning unit. The better solution includes Greenheck energy recovery ventilators. The next section shows how we enable an existing system to triple outside air volumes and reduce the total cooling load.

Retrofit With ERV

This example has the same Outside Air, Room Air and Supply Air design conditions as the previous examples. The outside air volume is 3,000 cfm to meet the requirement of the modified system. However, in this case a model ERV-521S Greenheck energy recovery ventilator will pre-condition the outside air before it enters the air conditioner. The total airflow for the air conditioning unit is still 10,000 cfm.

Modified System with Energy Recovery

Design conditions:

Outside Air	Room Air	Supply Air
91°F DB	75°F DB	55°F DB
77°F WB	50% RH	53°F WB
40.4 Btu/lb.	28.2 Btu/lb.	22.0 Btu/lb.

Air Leaving Wheel

The ERV-521S exhausts 3,000 cfm of return air and supplies 3,000 cfm of fresh, outside air. As this happens, the properties of the exhaust air are transferred to the outside air with an efficiency of 75%. The result is outside air leaving the wheel at a point 75% of the way from the outside air point to the room air point. Therefore, the Air Leaving Wheel conditions are:

79°F DB 66.5°F WB 31.1 Btu/lb

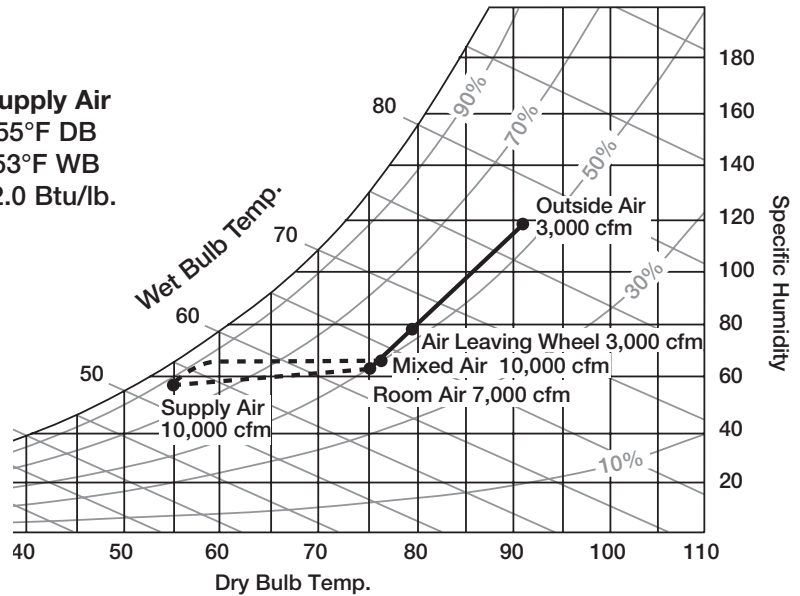

Figure 3-7

Mixed Air

After the outside air is pre-conditioned by the energy wheel, it mixes with the return air. Since the Room Air is 70% of the total airflow after mixing, the Mixed Air point is located 70% of the way from the Air Leaving Wheel point to the Room Air point. At this point, the conditions are:

76.2°F DB 63.8°F WB 29.0 Btu/lb

For this case that incorporates energy recovery into the system, the enthalpy difference (Δh) from mixed air (29.0 Btu/lb.) to supply air (22.0 Btu/lb.) is: 7.0 Btu/lb.

Therefore, the air conditioning load is:

$$\text{Total Cooling Load} = \frac{4.5 * 10,000 \text{ CFM} * 7.0 \text{ Btu/lb.}}{12,000} = 26.25 \text{ tons}$$

The existing 30 ton unit is still capable of cooling 10,000 cfm from mixed air to supply air conditions to handle both the building and room load. In fact, the total cooling load for the example with 3,000 cfm of outside air using energy recovery (26.25 tons) is actually less than the cooling load for the example of the existing system with only 1,000 cfm of outside air (27.38 tons).

Retrofit Summary

Energy recovery ventilators provide an excellent means for increasing outside air quantities without increasing cooling equipment size. In many climates, the first cost of the retrofit with energy recovery will be less than if additional tonnage is used. Also, the energy recovery route will lead to lower energy bills.

How to Determine the Minimum Wheel Effectiveness for Retrofit Applications

Greenheck has developed a simple equation for determining the minimum wheel effectiveness required for increasing outside air quantities without increasing air conditioning or heating capacities. The equation assumes that total supply air volume does not change.

Balanced Airflow

For equal supply and exhaust airflow:

$$\text{Minimum Wheel Effectiveness} = 1 - \frac{\text{CFM Outside Air INITIAL}}{\text{CFM Outside Air FINAL}}$$

Example:

For a case where outside air is being increased from 1,000 to 3,000 cfm.
The minimum wheel effectiveness required to avoid additional HVAC capacity is:

$$\text{Wheel Effectiveness} = 1 - \frac{1,000}{3,000} = 0.67 = 67\%$$

The wheel effectiveness must be above 67% to avoid increasing HVAC capacity. Greenheck feels it is good practice to use a 2-3 percentage point safety factor to select wheel effectiveness. In this case, an ERV with an effectiveness of 70% or greater is required.

CHAPTER 4

ERV APPLICATION: ERV DE-COUPLED FROM THE HVAC EQUIPMENT

This chapter was written using many excerpts from “Meeting ASHRAE 62-89 at Lowest Cost,” by Jack Dozier published in the January 1995 issue of *HEATING / PIPING / AIR CONDITIONING*.

This section applies to systems where a single thermal conditioning unit services multiple spaces that require different percentages of outside air in the supply airstream. This type of system is specifically addressed in ASHRAE Standard 62-1989, section 6.1.3.1 Multiple Spaces.

Background

The integrated system concept, previously discussed in Chapter 3, provides the simplest, lowest cost application for ERVs when the outside air to total supply air percentage (i.e., 25%) is the same for all spaces. However, when a single HVAC unit services multiple spaces where outside air requirements (as a percent of total supply air) differ significantly, the integrated system is not the best approach.

Simple Example

An example may help illustrate the deficiencies of the integrated system. Assume that a packaged rooftop unit serves an office building and provides supply air that is made up of 25% outside air and 75% return. Employee A, in an office with a high thermal load, receives 200 cfm of supply air which includes 50 cfm of outside air. Employee B, in an office with a low thermal load, receives only 40 cfm of supply air which includes just 10 cfm of outside air. In this example, employee A receives far more than the 20 cfm per person prescribed by ASHRAE Standard 62-1989, which translates into higher energy and equipment costs to condition the extra 30 cfm. Conversely, employee B received far less than the Standard prescribes, which translates into lower productivity and potential lawsuits.

In the case described above, an integrated system is unable to effectively address both the indoor air quality and energy conservation issues.

The De-coupled System

Figure 4-1 below illustrates the de-coupled design concept with energy recovery. In this example, the ventilation air is supplied at 78°F and 74 grains/lb of moisture without supplemental cooling.

Figure 4-1

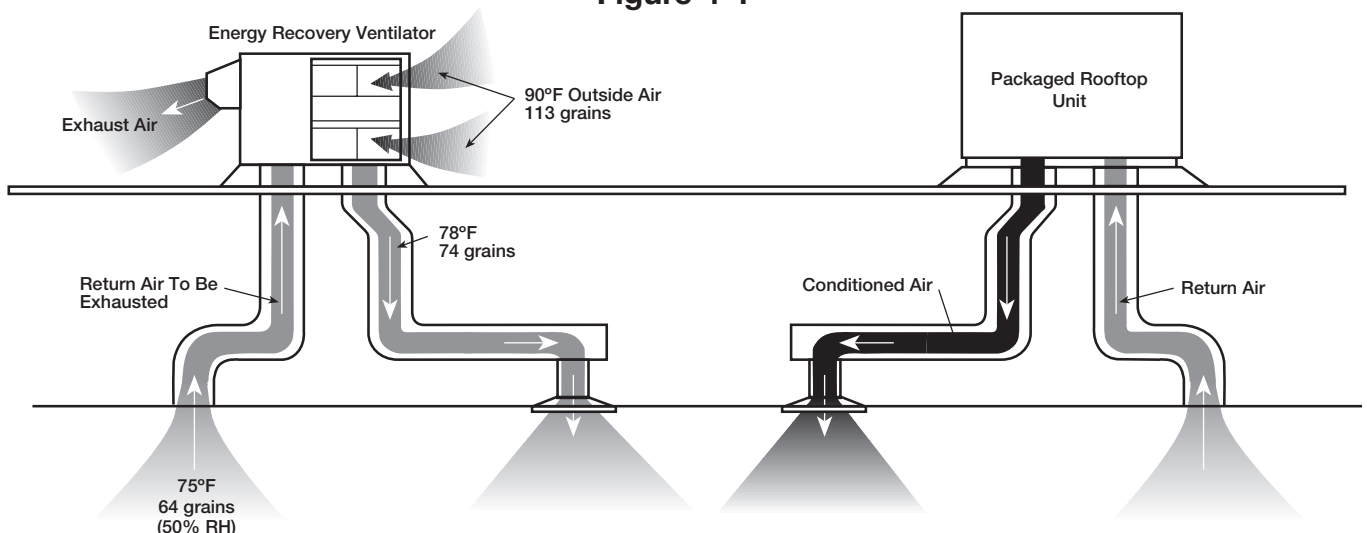

Starting on the next page, a more detailed example will be reviewed which more completely describes the application and advantages of the de-coupled system.

Detailed Example

Figure 4-2 shows part of a “common” system that serves five identically sized, identically lighted single occupant interior offices. According to the ASHRAE Standard 62-1989, each of these rooms requires 20 cfm of outside air.

At full load each room gets the total airflow shown whether constant volume or VAV is chosen. These loads are based on actual observations in buildings.

Figure 4-2: Common System

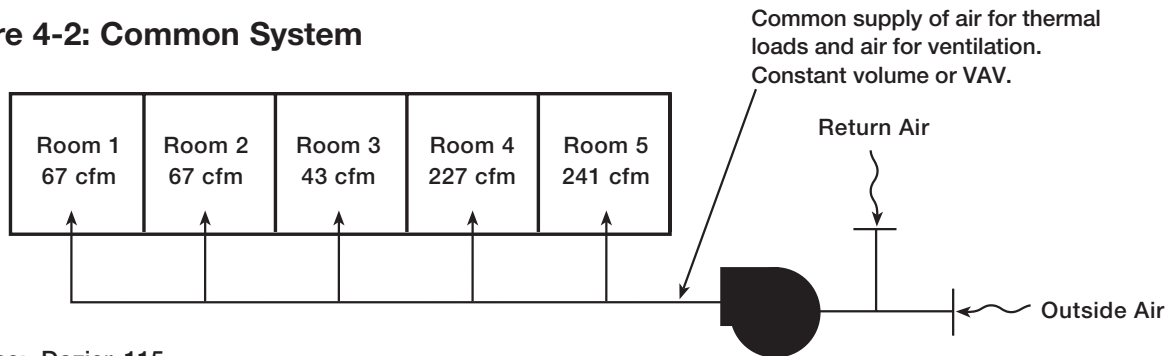

Source: Dozier, 115.

Table 4-1 – COMPARISON OF THREE COMMON SYSTEMS

System Concept	Outside Air (OA), cfm					Total System OA, cfm	Remarks
	Room 1	Room 2	Room 3	Room 4	Room 5		
Common System: total air includes 20 cfm OA per person	10.4	10.4	6.7	35	37.5	100	100 cfm of OA introduced (or 20 cfm for each of 5 people) blended with air that conditions thermally. Low first and energy costs, maximum legal exposure. Under-ventilation to 60% of the occupants.
Common System: adequate OA to provide 20 cfm to Room 3	31	31	20	105.5	112	299.5	Adequate OA to all occupants, but gross over-ventilation in some rooms. Maximum equipment first cost and energy cost.
Common System: designed using ASHRAE Equation 6-1	15	15	9.6	50.8	53.9	144.3	60% of occupants receive less OA than called for by Standard's Table 2. High first and energy costs. Possible legal vulnerability due to apparent conflict in standard.

Source: Dozier, 118.

Common System Concept Deficiencies

The first option simply introduces into the system 100 cfm of outside air, intending 20 cfm for each of five people. However, 60 percent of the occupants get much less than 20 cfm of outside air while the others get much more, even if a perfect mixture is assumed.

In the second concept, the mixture contains a high enough percentage of outside air to provide 20 cfm to the occupant of Room 3, which has the lowest load and lowest total airflow. All spaces are adequately ventilated, but the system must be designed and operated to condition almost three times the outside air that the standard has prescribed for five people.

The standard recognizes that unequal loads exist and in Section 6.1.3.1 provides Equation 6-1 to determine the fraction of outside air that is to be in the mixture. The third system in Table 1 shows the results of applying this 1989 equation to our 1994 example of load distribution: 60 percent of the occupants still get less than the standard prescribes, and the system is burdened with 44.3 percent more outside air than is required for its occupants.

The third system has generated debate as to whether or not Section 6.1.3.2 of the standard conflicts with the authority of equation 6-1 to reduce outside air below the levels set in Table 2 of the standard. In IAQ-related litigation, the legal profession tends to see this system as discriminating, since 60% of the occupants are getting less outside air than Table 2 of the standard prescribes and much less outside air than the other 40%.

De-Coupled System in Detail

De-coupled systems should be strongly considered where thermal loads vary significantly from space to space. The de-coupled concept uses a dedicated system for ventilation air delivery, which allows independent control of ventilation air and thermal conditioning. The air conditioning equipment processes 100% return air and supplies it back to the occupied space. Exhausting stale air and supplying fresh outside air is handled by the energy recovery ventilator.

For multiple space applications where outside air requirements vary significantly from space to space, the de-coupled system has the following advantages:

- Adequate outside air is supplied to all occupied spaces.
- Compliance with ASHRAE Standard 62 for all spaces can be easily demonstrated.
- Requires the lowest total outside air quantities, which results in the lowest energy consumption.
- Provides the lowest initial cost in most cases.

The energy recovery ventilator conditions the outside air to temperature and humidity values at, or near, room conditions. Depending on the climate and preference of the specifying engineer, supplemental heating or cooling for the ventilation air may not be necessary. Figure 4-3 below illustrates the de-coupled system concept.

Figure 4-3: De-coupled System

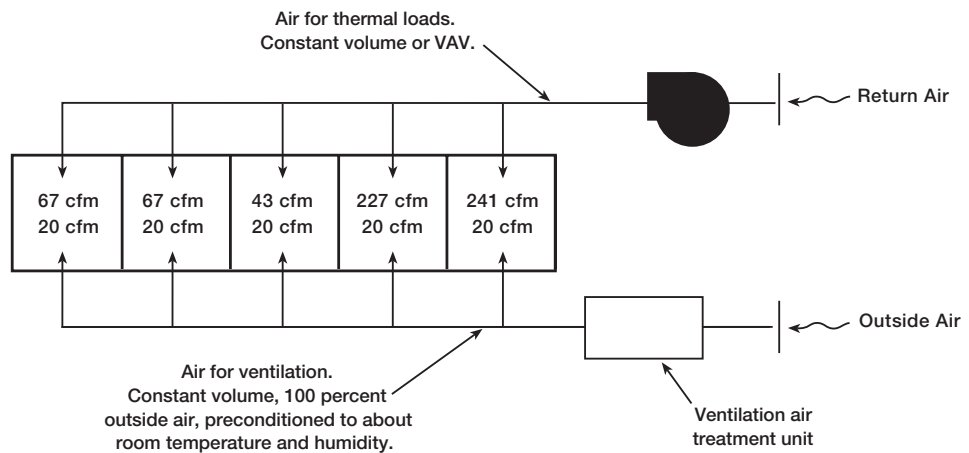

Source: Dozier, 118.

Table 4-2 below shows the de-coupled system ventilation air delivery. In this system, 100 percent outside air is treated to about room conditions and delivered in constant volume to each occupied zone. The thermal conditioning system and the ventilation system perform their functions independently of one another.

Table 4-2 – DE-COUPLED SYSTEM

System Concept	Outside Air (OA), cfm					Total System OA, cfm	Remarks
	Room 1	Room 2	Room 3	Room 4	Room 5		
De-coupled System: 20 cfm treated OA to each room	20	20	20	20	20	100	Adequate ventilation to all occupants with minimum equipment first cost and operating cost. Clear, demonstratable compliance with Standard for minimum legal exposure. Opportunity to add OA to actual need per occupancy sensor. High cost of ductwork, less refrigeration capacity and lower first and operating costs.

Source: Dozier, 118.

For systems like this example, the de-coupled system is superior to all three concepts in Table 1 for common systems. Here's why:

1. The proper amount of outside air (20 CFM/person) is supplied to 100% of the occupants. Compliance with ASHRAE Standard 62 for all spaces can be easily demonstrated.
2. The total system outside air is minimized, reducing operating costs.
3. It's simple. The constant volume outside air eliminates complex control strategies. Accordingly, maintenance costs are low.
4. The first cost of the additional duct work and energy recovery ventilator is offset (entirely or partially) by the first cost reduction of the air conditioning and heating equipment. Payback is within one year for many U.S. markets.

Maintenance cost

To meet the standard, especially in VAV systems, complex control strategies are being proposed. For example, one system would monitor the loads of all zones and (by computer) continuously solve Equation 6-1 to regulate the fraction of outside air in the common system. This is intended to minimize wasteful over-ventilation. In estimating maintenance cost, consider the price of personnel who can understand and cope with such a strategy and equipment. Contrast this with the simplicity of the de-coupled system.

Also, considering the example in Figure 4-2, unless individual room temperature control is used, the strategy just described would be inadequate. The load variation is between individual rooms, not just between multi-room zones.

Internal office loads

Equipment is a dominant factor in today's interior load. Unlike the heavy lighting that dominated the interior in the past, the equipment load is anything but evenly distributed. The loads may vary widely from room to room. Precise information on office equipment selection and location is seldom available at the time of design. Some engineers allow for equipment loads on a per-square-foot basis, relying on field adjustment of airflow to match the actual load distribution that develops.

After the system is built and balanced to follow such design assumptions, airflow is adjusted to meet the actual loads that appear. When the loads are present and air flow adjustments have caused room temperature to hold steadily, the room capacities have been tailored to meet the loads.

For an idea of the variety of office equipment loads, refer to Table 9 on page 26.14 of the 1993 ASHRAE Fundamentals Handbook. Many of these items would dominate the interior load of a single-occupant office. Any of these loads might be in one office while an adjacent office has only a telephone and one occupant. This table has 47 categories of equipment listed as "appliances." The same table in the 1989 Handbook showed only 20 categories, providing some insight into this change. A major contributor to this change has been the move of electronic data processing from the computer room to PCs, printers, and the like scattered all over the building.

Meanwhile, the stabilizing influence (on load distribution) of lighting continues to decrease. A spokesman for the EPA Green Lights Program estimated that the typical office building lighting load is being reduced by half due to improved illumination.

We have no crystal ball to predict load distribution, but to base ventilation strategy on evenly distributed interior loads is unrealistic.

Reheat option

Local reheat can keep total airflow high enough to support ventilation. Most certainly, reheat could provide excellent room conditions. Constant volume reheat (CVRH) is rare enough in office application today that some may not have closely examined its inefficiencies. A simplistic example might serve.

Assume that a CVRH zone requires 10,000 Btu-h at full cooling and 10,000 Btu-h at full heating. The only efficient point of CVRH is full cooling. As the cooling load is reduced from that point, reheat is added. At zero net load (gains are in balance with losses), 10,000 Btu-h of cooling is countered with 10,000 Btu-h of heating. The plant extracts and adds a total of 20,000 Btu-h to deliver zero to the space. At full heating, the 10,000 Btu-h of cooling is canceled by 10,000 Btu-h of heating, but 10,000 Btu-h of heating is needed. To meet this, the plant must extract and add a total of 30,000 Btu-h.

VAV reheat is efficient in the VAV part of the sequence. However, at lower cooling loads and into heating, this sequence suffers the inefficiencies of reheat.

Many control strategies have been offered to minimize the waste of reheat systems, but something that resets cold air supply seldom gains much. Latent cooling needs and/or the sensible needs of some space (interior perhaps) seem to cause cold air to be needed year round.

There is the cost of reheat components to consider as well, both interior and exterior if the goal is to support ventilation. The CVRH design has almost no diversity of load. Equipment must be sized to deal with the sum of the peaks of the zones.

Finally, the human factor may be the greatest failing of reheat. Imagine explaining to an office building owner why his system must add heat year round while the Environmental Protection Agency is persuading him to join the fight to reduce atmospheric pollution by cutting energy consumption.

Notes on ASHRAE Standard 62-1989

In the example presented in this article, 20 cfm of outside air is to be delivered into each room, not simply into the system, because:

- Section 5.2 of the standard calls for ventilation air to be “supplied throughout the occupied zone.”
- The occupied zone is defined by dimensions within the occupied space (page 3 of the standard).
- Section 6.1.3.3 discusses ventilation effectiveness, or the fraction of outside air that is actually delivered into the occupied zone, a part of the outside air that is actually delivered into the occupied space. For this comparison, ventilation effectiveness is considered to be 100 percent.
- Table 2 of the standard specifies the minimum outside air flow for several types of spaces. The office is to receive 20 cfm per person.

Source: Dozier 116.

CHAPTER 5

UNDERSTANDING AND CALCULATING PAYBACK PERIODS

There are many choices that engineers have when considering possible solutions to providing adequate Indoor Air Quality. However, most alternatives are expensive. One of the attractive benefits of Greenheck energy recovery ventilators is that they are very economical. Low first cost and exceptional energy savings combine to provide payback periods of less than one year in many U.S. markets.

This chapter is a tool to understand how payback can be calculated. To obtain a general feel for the economics of Greenheck ERVs, a payback map is shown for the following assumptions:

- Office building with HVAC system operating 16 hrs/day, 5 days/week
- ERV installed cost of \$3.60 per cfm
- Air Conditioning equipment installed cost of \$1,000 per ton
- Energy costs of \$0.06 per kW-h and \$0.60 per Therm
- Energy recovery effectiveness of 75%

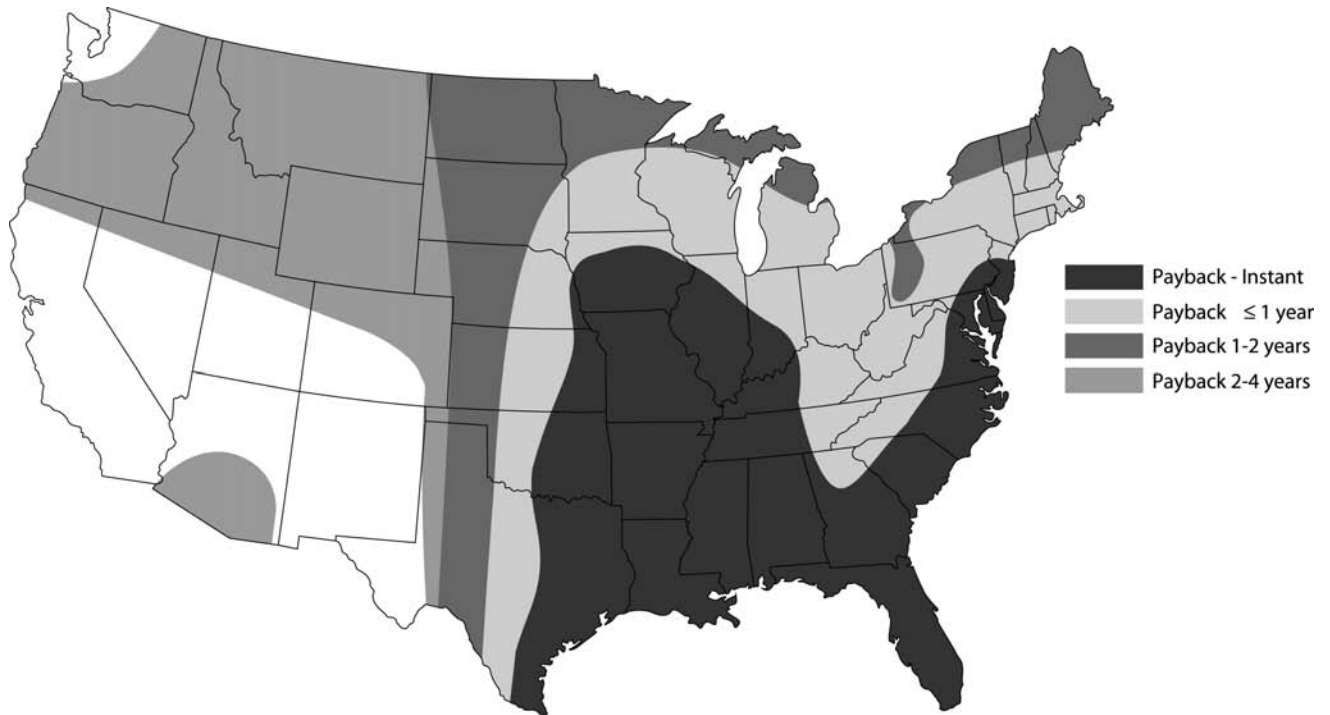

Every installation is unique and has many elements that contribute to the total installed cost of the HVAC system. We did not attempt to account for every aspect of cost. Instead, we simplified the payback analysis to the following major components:

1. Initial equipment purchase for Air Conditioning and Energy Recovery.
2. Annual energy consumption.

In most U.S. climates, energy recovery ventilators enable air conditioning equipment to be down sized considerably. With this in mind, net first cost is determined by subtracting the savings due to A/C equipment reduction from the ERV first cost.

For the map shown above, areas in red (southeast U.S.) have a negative first cost. That means payback is immediate. For the other regions, net first cost is divided by annual energy savings to arrive at payback.

Example

The following example will guide you through a payback analysis. The location is Chicago. The outside air requirements are 3000 cfm. The following information is available to us:

Summer Design Conditions	
Outside Air	Room Air
91 DB	75 DB
77 WB	50% RH
40.4 Btu/lb.	28.2 Btu/lb.

Winter Design Conditions	
Outside Air	Room Air
2 DB	70 DB
	35% RH

- Room air conditioning load is 24 tons
- Outside air requirement is 3,000 cfm

NET FIRST COST

ERV Installed Cost

The first step in calculating net first cost is to determine the first cost of the ERV. For this example, we will be using an ERV-521S which has an energy transfer efficiency of 75%. The installed cost for the ERV-521S is \$10,800.

Air Conditioning First Cost Reduction

The reduction in air conditioning equipment is due to the pre-conditioning of the outside air by the ERV. To quantify the reduction, we need to compare the outside air load for a system without an ERV to a system with an ERV.

This comparison begins with a comparison between the enthalpies of outside air and room air. Below, we can see the reduction in the enthalpy difference between the system without the ERV and the system with the ERV.

$$\text{OUTSIDE AIR LOAD WITHOUT ERV} = \frac{4.5 * \text{Airflow Rate (CFM)} * \Delta h}{12,000} = \frac{4.5 * 3,000 \text{ CFM} * 12.2 \text{ Btu/lb.}}{12,000} = 13.7 \text{ tons}$$

$$\Delta h = h_{\text{outside air}} - h_{\text{room air}} = 40.4 \text{ Btu/lb.} - 28.2 \text{ Btu/lb.} = 12.2 \text{ Btu/lb.}$$

Now, by adding the outside air load to the room load (24 tons), we can determine the air conditioning equipment size for each scenario.

WITHOUT ERV: 13.7 + 24 = 37.7 tons; size for 40 ton A/C unit

$$\text{OUTSIDE AIR LOAD WITH ERV} = \frac{4.5 * \text{Airflow Rate (CFM)} * \Delta h}{12,000} = \frac{4.5 * 3,000 \text{ CFM} * 2.9 \text{ Btu/lb.}}{12,000} = 3.3 \text{ tons}$$

$$\Delta h = h_{\text{wheel}} - h_{\text{room air}} = 31.1 \text{ Btu/lb.} - 28.2 \text{ Btu/lb.} = 2.9 \text{ Btu/lb.}$$

WITH ERV: 3.3 + 24 = 27.3 tons; size for 30 ton A/C unit

By using the ERV, the air conditioning equipment can be down sized by 10 tons. At \$1,000 per ton installed, that translates into an avoided air conditioning cost of \$10,000.

Net First Cost

By subtracting the avoided air conditioning cost from the ERV first cost, we arrive at the net first cost. In this case, the net first cost is only \$800.

$$\begin{aligned} \text{NET FIRST COST} &= \text{ERV Initial Cost} - \text{Avoided Cooling (A/C) Equipment Cost} \\ &= \$10,800 - \$10,000 = \underline{\underline{\$800.00}} \end{aligned}$$

Annual Energy Savings

Annual energy savings are based on climatic conditions. The Weather Bin Data, compiled by the U.S. Air Force, consists of the average temperature information for various locations in the U.S. Some general information is necessary to determine the proper weather bin data for the payback analysis.

General Information:	This sample analysis will use the below values.
Location	Chicago
ERV operating time (Hours/Day and Days/Year)	16 hours per day, 260 days per year
Dollars per Kilowatt-Hour	\$0.06 per kW-h
Dollars per Therm	\$0.60 per therm
Type of heat: Gas or Electric	Gas

Table 5-1 below shows the detail for the calculation of annual energy savings for Chicago, Illinois.

Table 5-1 Weather Bin Data – (Chicago)

Annual Energy Savings Calculations per Ventilation Rate						
Temp. Range +/- 2°F	Total Hours Annually	Enthalpy	Load w/o Energy Recovery (BTU)	Load with Energy Recovery (BTU)	Annual Savings (BTU)	Annual Savings (Dollars)
107	0	NA	0	0	0	0
102	0	NA	0	0	0	0
97	4	39.37	644,880	161,220	483,660	4
92	41	37.50	5,189,075	1,297,269	3,891,806	31
87	117	35.72	11,849,647	2,962,412	8,887,235	71
82	224	34.01	17,469,316	4,367,329	13,101,987	105
77	298	31.58	13,530,810	3,382,703	10,148,108	81
Cooling Totals			48,683,728	12,170,932	36,512,796	\$292

67	349		5,658,547	1,414,637	4,243,910	34
62	300		9,720,202	2,430,051	7,290,151	58
57	265		12,879,268	3,219,817	9,659,451	77
52	256		16,616,916	4,154,229	12,462,687	100
47	252		20,423,996	5,105,999	15,317,997	122
42	263		25,550,248	6,387,562	19,162,686	153
37	344		39,042,811	9,760,703	29,282,108	234
32	393		50,915,345	12,728,836	38,186,509	305
27	259		37,700,503	9,425,126	28,275,377	226
22	155		25,110,523	6,277,631	18,832,892	150
17	95		16,929,353	4,232,338	12,697,015	101
12	68		13,191,704	3,297,926	9,893,778	79
Heating Totals			273,739,416	68,434,854	205,304,562	\$1,641

Total Annual Savings \$1,933

Weather Bin Data

Weather bin data reports the annual number of hours a city's outside conditions are at specific temperatures. This data is averaged over a fifteen year period for accuracy. A **bin** is simply an abbreviation for a range of values, in this case temperatures. The temperature ranges or bins are 5°F degrees wide, or +/- 2°F from the mean temperature. Bins are identified by their mean temperature, see Figure 5-1.

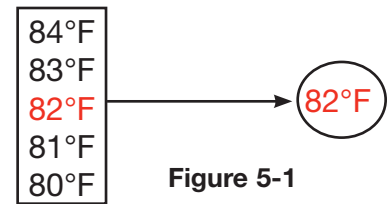

Figure 5-1

For the payback analysis we are interested in the annual outside temperature and enthalpy measurements. The temperature bins are divided into heating and cooling ranges. Annual energy consumption can be calculated using this data.

Annual Energy Savings

The energy recovery unit in this example has an effectiveness of 75%. The annual energy savings calculations take into account the annual temperature and enthalpy differences between outside air and room air. Due to the energy recovery ventilator, 75% of these differences between outside air and room air will be saved.

Energy cost savings are divided into cooling and heating season components. For our example, the cooling and heating savings are:

Annual Cooling Energy Saved = 36,512,796 Btu

Annual Heating Energy Saved = 205,304,562 Btu

Annual Energy Cost Savings for Cooling and Gas Heat = \$292 + \$1,641 = \$1,933

Determining the Cost of Power Consumption by the ERV

Internal static pressure losses caused by the energy recovery wheel result in the consumption of otherwise unneeded fan power. This power consumption should be subtracted from the savings realized from the energy recovery. The power that is being calculated does not include the energy to move the air through the HVAC system, since that energy would be required even without an ERV.

Both blowers consume some amount of horsepower to overcome internal losses. Power consumption due to the energy wheel and its drive motor is approximately **one third** of the cataloged brake horsepower (BHP).

The cataloged BHP per blower for a ERV-521S operating at 3000 cfm with external static pressure of 0.75 inches wg is 2.26 horsepower.

$$\text{Annual cost of power consumed by the ERV} = \frac{(4.52 \text{ hp})}{3} \times 0.7457 \text{ kW/hp} \times 4160 \text{ hours/year} \times \$0.06 / \text{kW-h} = \$280$$

Net Operating Savings

Total Annual Energy Cost Savings - Annual Cost of Power Consumed by the ERV = **Net Operating Savings**

$$\$1,933 - \$280 = \$1,653$$

Payback Period

Below is the calculation for this samples payback period.

$$\text{Payback Period (in years)} = \frac{\text{Net First Cost}}{\text{Net Operating Savings}} = \frac{\$800.00}{\$1,653 / \text{year}} = 0.48 \text{ years}$$

Payback Analysis Worksheet

Model	Supply Volume (CFM)	Exhaust Volume (CFM)	Supply Efficiency	Exhaust Efficiency
ERV-521S	3,000	3,000	75%	75%

First Cost Analysis:

ERV First Cost (Installed)

\$ 10,800.00

A/C First Cost Reduction	w/o ERV	w/ ERV
Outside Air Load (tons)	13.7	3.3
Room Load (tons)	24	24
Total Load (tons)	37.7	27.3
Equipment Size (tons)	40	30
Equipment Reduction (tons)		10
Cost per A/C Ton (installed)		\$1,000

Avoided A/C Equipment Cost

\$ 10,000.00

ERV First Cost

\$ 800.00

Annual Energy Savings:

Energy Cost Savings	\$1,933
Cost of Energy Consumed	\$ 280

Net Operating Savings

\$ 1,653.00

Payback Period:

0.48 years

Notes:

1. Payback Based on Net First Cost Divided by Net Operating Savings
2. Operating Time **16** hours per day
3. Dollars per Kilowatt-Hour **\$ 0.06** per kW-h
4. Type of heat **Gas**
5. Dollars per Therm **\$ 0.60** per therm

ADDITIONAL CALCULATIONS

For reference purposes, we have listed the calculations for determining energy costs based on fuel consumption.

$$\begin{aligned}
 \text{for Cooling} &= \text{Annual Cooling Energy Saved} \times (0.000293) \times \text{Energy Price} \times \frac{1}{\text{COP}} \\
 &= 36,512,796 \text{ Btu} \times 0.000293 \text{ kW-h/Btu} \times \$0.06/\text{kW-h} \times 1/2.2 \\
 &= \underline{\$292.00}
 \end{aligned}$$

$$\begin{aligned}
 \text{for Heating (Gas)} &= \text{Annual Heating Energy Saved} \times (0.000293) \times \text{Energy Price} \times \frac{1}{\text{Efficiency}} \\
 &= 205,304,562 \text{ Btu} \times 0.00000999 \text{ therm/Btu} \times \$0.60/\text{therm} \times 1/0.70 \\
 &= \underline{\$1,641.00}
 \end{aligned}$$

$$\begin{aligned}
 \text{for Heating (Electric)} &= \text{Annual Heating Energy Saved} \times (0.000293) \times \text{Energy Price} \times \frac{1}{\text{COP}} \\
 &= 205,304,562 \text{ Btu} \times 0.000293 \text{ kW-h/Btu} \times \$0.06/\text{kW-h} \times 1/1.0 \\
 &= \underline{\$3,609.00}
 \end{aligned}$$

- Calculations based on heating equipment efficiencies of 70% and COP = 1.0
- Electric and Cooling Equipment ratings of COP = 2.2
- COP is the Coefficient of Performance

CHAPTER 6

HUMIDITY AND ITS IMPORTANCE IN IAQ

Humidity is an important factor to consider for providing both comfortable room conditions and a healthy environment. From the comfort standpoint, the room humidity as well as temperature must be considered. From the health perspective, humidity levels that are too high permit bacteria, viruses and fungi opportunity to harm building occupants.

Comfort

More than 75% of all IAQ problems start with comfort complaints. If these are not addressed, employees will continue to complain and become less productive.

The main guideline regarding humidity is incorporated in ASHRAE Standard 62-1989. Based on a 1985 study by E.M. Sterling, the ideal humidity range for a building in the summer is between 40% and 60%. It is the range where most people feel comfortable.

It must be noted here that the ASHRAE Guide (Equipment Manual) warns against too high a humidity level indoors during winter; 40% to 60% RH results in condensation forming on windows, even on thermopane windows, when the outside air is 25°F.

The ASHRAE Guide (Fundamentals) indicates that you can have space comfort in the winter with 20% to 30% RH, based on specific dry bulb space temperatures. Accordingly, there are engineers who will not design for more than 25% RH ($\pm 5\%$ RH) in northern areas of the U.S.

Health

The following chart illustrates the effects of various human health parameters over the relative humidity range of 0 to 100%. The optimum range for human health (and comfort) in conditioned spaces is 40% to 60%.

Adverse health effects increase as the relative humidity deviates above and below the optimum range. These health effects are depicted in Figure 6-1 by the increasing width of the black area for each indoor air quality problem listed.

Effect of Room Humidity on Selected Human Health Parameters

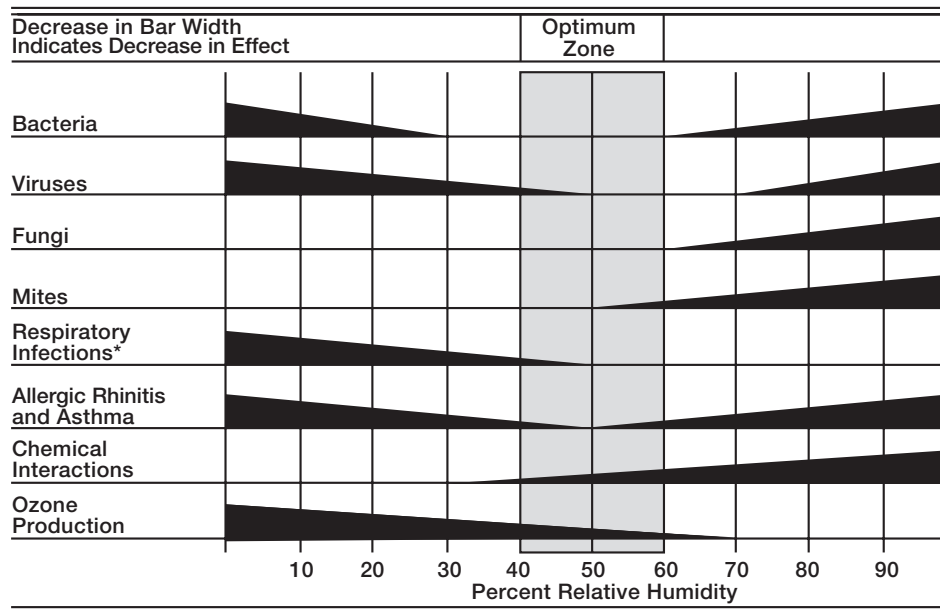

*Insufficient data above 50% R.H.

Source: Sterling: ASHRAE 1985

Figure 6-1

Relative Humidity Guidelines

Relative Humidity Level	Description
0% – 30%	Most fungi will not grow at these humidities.
40% – 55%	Optimal Building Humidity for all parts of the occupied space, chases, dropped ceilings, plenums and behind drywall.
60% – 70%	Approaching optimal range of humidity for growth; mold growth likely in such areas.
Above 70%	Optimal humidity levels for most fungal growth.
Above 90%	Typical humidity level downstream of cooling coils during cooling season without reheat. (Unavoidable tempering condition due to cooling process. Mixing and off cycles restore RH to acceptable levels.)

Source: American Heat Pipes, 1994.

1. Relative humidity need only be elevated for a period of hours to start mold growth. Pore production may begin within about 24 hours for common species. (American Heat Pipes, 1994.)
2. Depending on the building construction and ventilation system, plenums or spaces behind drywall may be in the HVAC system flow path and should therefore be considered to be part of the occupied space. (American Heat Pipes, 1994.)
3. Because high humidity is unavoidable downstream of cooling coils without reheat, such areas should be able to be cleaned with liquid disinfectant and should allow easy inspection at least twice per year, before and after the cooling season. (American Heat Pipes, 1994.)

NOTE: According to Section 5.12 of ASHRAE Standard 62-1989, the relative humidity in duct work should be maintained below 70%. In cooling systems, the relative humidity in supply ducts cannot be maintained below 70% without either active or passive reheat.

The Enthalpy Wheel and Humidity Control

The enthalpy wheel is perfectly suited to help control humidity. In the summer, when outside humidity is high, the wheel dehumidifies the outside air as it passes through the wheel. This greatly reduces the latent load on the air conditioning equipment and also eliminates rising indoor humidity levels that can occur in hot, humid climates.

In the winter, the wheel retains the indoor moisture. The dry outside air is humidified as it passes through the wheel. This increases comfort and reduces the amount of humidification required.

Modern Air Conditioning Equipment

Today's air conditioning equipment is regulated to meet minimum SEER values, which correspond to efficiency. In designing for this criteria, air conditioning manufacturers have developed more efficient equipment for sensible cooling, but have sacrificed the equipment ability for latent cooling. This means that the equipment is not always capable of handling high latent loads that exist in humid climates. The result is higher than desired indoor humidity levels, even when the equipment is running.

Indoor humidity can be raised even higher when the air conditioning compressor cycles off and moisture evaporates off the coil as recirculation of air continues in order to meet ventilation requirements.

Pre-conditioning the outside ventilation air with a total energy wheel is a highly effective method of helping to control indoor humidity. Stripping much of the moisture out of the outside air enables the air conditioning equipment to become significantly more effective at controlling indoor humidity.

CHAPTER 7

CO₂ AND ITS IMPORTANCE IN IAQ

This chapter is an excerpt from “Measure and Control CO₂,” by Mike Schell published in the September 1994 issue of *CONTRACTING BUSINESS*.

Carbon dioxide (CO₂) is one of the most common gases found on the face of this planet, it's an integral component of the life support system that sustains all living beings. When used and applied in the proper manner, CO₂ measurement and control can help us evaluate and control the air quality and overall comfort within our buildings.

Measurement and control of CO₂ doesn't provide the complete answer to evaluating and sustaining a healthy level of indoor air quality in buildings; however, it can be an essential component of a well designed and operated building that maximizes the health and comfort of its occupants. Properly controlling CO₂ can also save energy.

What is CO₂? It's a naturally occurring gas that's produced by combustion processes, or it's a byproduct of the natural metabolism of living organisms.

Outside concentrations of CO₂ tend to be fairly constant at 350 to 425 PPM. Heavily industrialized or polluted areas may have periodic outside CO₂ concentration peaks as high as 500 to 800 PPM. Measurements near busy highways will almost always find elevated CO₂ levels.

Carbon dioxide shouldn't be confused with carbon monoxide (CO) a highly toxic gas that's also a byproduct of incomplete combustion in furnaces and automobiles. Very low levels (e.g. 25 to 50 PPM) of CO can be dangerous.

Humans inhale oxygen and exhale CO₂. The concentration of CO₂ in exhaled breath is typically around 3.8% (38,000 PPM). Once this CO₂ leaves the mouth or nose, the concentration dissipates and mixes in the surrounding air very quickly. Indoor concentration of CO₂ in occupied spaces typically ranges from 500 PPM to 2,000 PPM.

The difference between inside and outside concentration in most non-industrial workplaces is primarily due to the CO₂ produced by people.

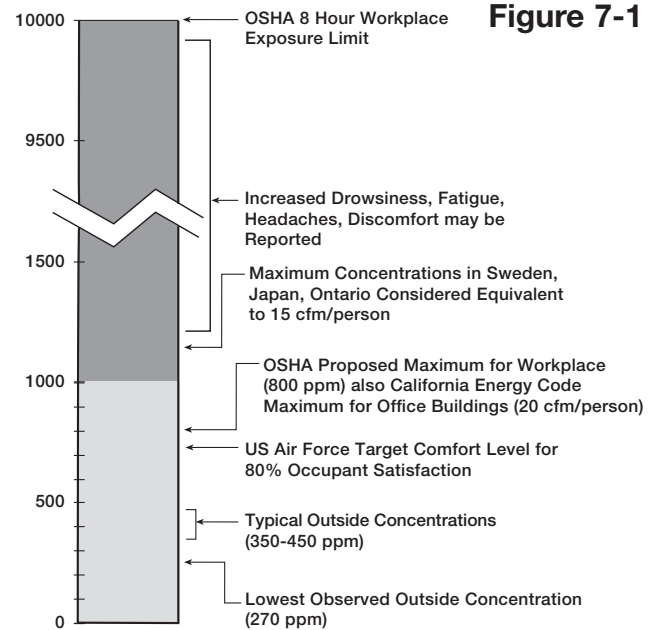

Source: Schell, 64.

Various organizations have established recommended levels of CO₂ concentrations in indoor spaces. Figure 7-1 gives you a summary of the most recently published recommendations and requirements.

A widely used rule of thumb says that an indoor space will be considered under ventilated if the indoor CO₂ concentrations exceed 1,000 PPM (assuming an outside concentration of 300 PPM).

You can trace references to 1,000 PPM of CO₂ as an indicator of the minimum amount of ventilation in a space as far back as the 1929 New York Building Code (Section 31) and as recently as the American Society of Heating, Refrigerating and Air-Conditioning Engineers (ASHRAE) Standard 62-1989 Ventilation Standard for Acceptable Air

The absolute CO₂ values these codes and standards establish provide a useful rule of thumb. However, like many such rules, oversimplification can undermine the original intent.

In the case of CO₂ the important indicator of adequate ventilation is not necessarily the absolute CO₂ concentration, but rather the difference between inside and outside concentrations.

This has become important only in the past few years as human fabricated CO₂ levels rose around the planet. Outside concentration of 300 PPM, once assumed fairly common, can now only be found in the most remote areas, far from urbanization and industrialization. For example, Los Angeles outside levels often exceed 600 PPM.

So, the old rule of thumb is valid, it must just be expressed in a different way: “If inside concentrations exceed outside concentrations by more than 700 PPM, a building space is considered under-ventilated for the number of occupants in the space.”

Is CO₂ an Indoor Air Contaminant? Carbon Dioxide itself isn’t considered a contaminant at typical indoor levels. In fact, in industrial environments where process or non-human generated CO₂ is dominant (i.e. breweries, frozen food processing facilities) maximum CO₂ concentrations established by the Occupational Health & Safety Administration (OSHA) are allowed to reach up to 10,000 PPM over an eight hour work period.

Concentrations this high would likely never be found in a home or office where humans are the principal source of CO₂. In contrast to the OSHA recommended maximum, look at the ASHRAE recommendations for maximum CO₂ concentrations in occupied buildings.

Why are these recommended levels of exposure so different? In offices and non-industrial buildings, the concern is not avoiding toxic or harmful CO₂ levels. In those buildings, CO₂ can act as an indicator or surrogate of other factors that impact indoor air quality.

More importantly, knowing the difference between inside and outside concentrations can help us determine how much outside air is being introduced to an occupied room or building zone, if we know the occupancy. Later we’ll discuss both these features of CO₂ further.

As people exhale CO₂, they also exhale and off-gas a wide range of other bioeffluents. These effluents can include gases, odors, pherons, particulate, bacteria, and viruses. Think of the Pigpen character in the Peanuts comic strip and you’ll get a pretty good idea of the invisible plume of bioeffluents that trail behind all of us.

When these bioeffluents are allowed to build up in a space, say as a result of poor ventilation, occupants complain of fatigue, headaches, and general discomfort. When occupant-generated CO₂ is elevated more than 700 PPM above outside concentrations, research indicates that bioeffluent levels are high enough to cause discomfort and the perception of body odor in 20% or more of building occupants.

Many of our current building ventilation standards are based on this simple test of perceiving body odor. The assumption is that if you ventilate sufficiently to remove the perception of human odors, the HVAC system is probably ventilating enough to take care of the non-human contaminants. This is providing there are no unusual non-human sources such as stored chemicals in a mechanical room.

Carbon dioxide is not the cause of indoor discomfort. Rather, carbon dioxide is a convenient trace element to denote the possible presence and concentration of human generated contaminants that can cause discomfort. This is why allowable levels of pure CO₂ in industrial environments are much higher than in buildings where people-generated, bioeffluent-laden CO₂ is the principal concern.

Outside levels of CO₂ are relatively constant and predictably range between 350 and 500 ppm. Inside levels never drop below outside levels. In most building environments, the CO₂ in indoor air above outside levels is contributed by people breathing. Given that all people exhale CO₂ in similar concentrations based on their level of activity, the amount of CO₂ above outside levels can indicate to us the number of people in the space.

Figure 7-2 shows the relationship between human activity and CO₂ production that forms the basis for using CO₂ as a ventilation indicator. The graph shows that the production of CO₂ is very predictable, if the building occupants' activity level is known. Most office work falls in the very light activity level category.

If no ventilation existed in a building, CO₂ concentrations would continue to rise. However, if outside air at a lower and known concentration is introduced into the space, CO₂ concentrations will be diluted. The amount of dilution is directly related to the amount of ventilation.

An indoor CO₂ measurement provides us with a dynamic measure of the combined effect of lower concentrations of CO₂ representing outside ventilation and the constant generation of CO₂ by building occupants. Assuming good air mixing within the space, the concentration of CO₂ can provide an indication of the actual ventilation rate.

CO₂ Production and Human Activity

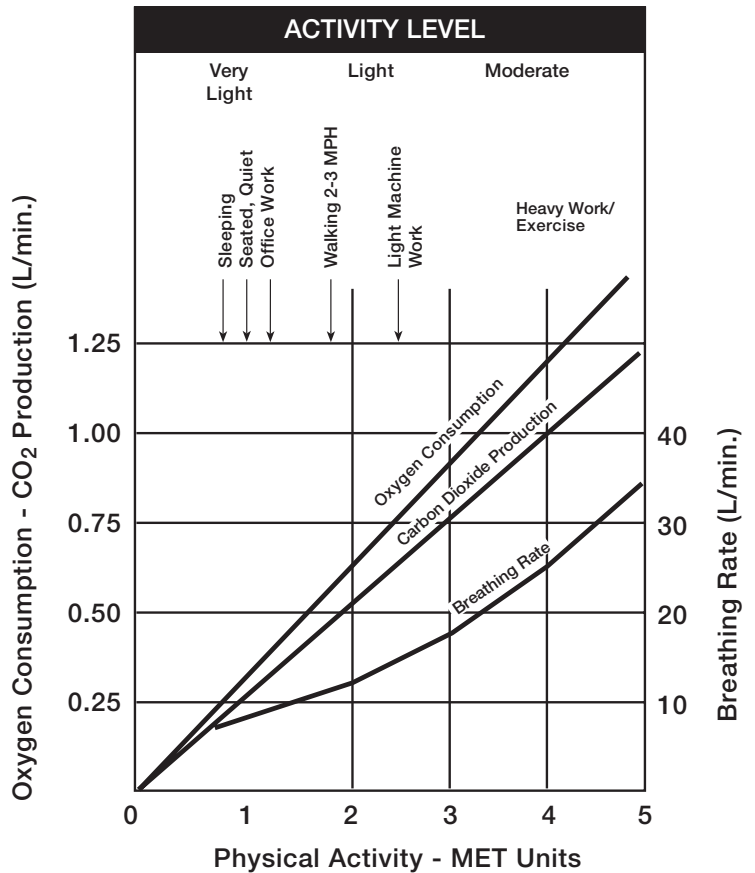

Source: Schell, 66.

Figure 7-2

Figure 7-3 shows the relationship between inside and outside CO₂ concentrations and the per-person ventilation rate. In this case the outside concentrations were assumed to be 350 ppm. The curved line on the graph can be used to translate an indoor concentration of CO₂ into the ventilation rate on a per-person basis (CFM/person).

Relationship Between CO₂ and Ventilation Rates

Predicting Ventilation Rates Based on CO₂ Concentrations
(Assumes Outside CO₂ 350 ppm and Office Type Environment)

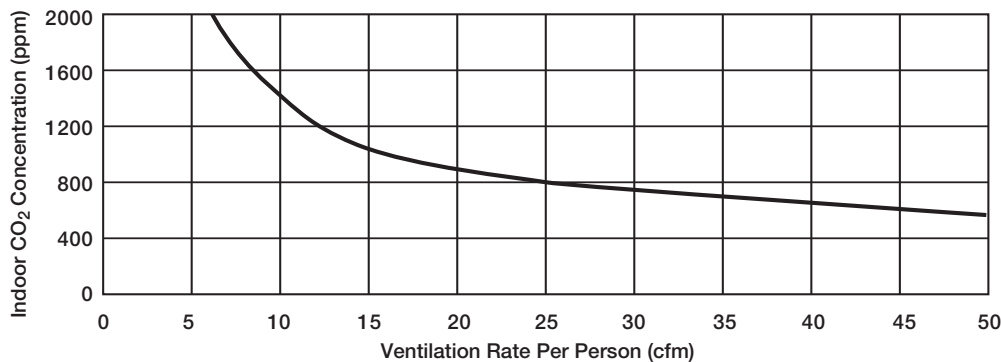

Source: Schell, 66.

Figure 7-3

An important factor influencing the use of CO₂ for ventilation assessment and control is the principal of equilibrium. Consider a number of people entering a room at the beginning of a work day. Initial CO₂ levels in the space would be very low, probably close to the outside level, because the room wasn't occupied during the night.

Carbon dioxide levels begin to rise as people enter the room. Figure 7-4 provides a graphical representation of what happens to CO₂ concentration over the first part of the day. It examines the buildup of CO₂ under a variety of ventilation conditions.

As time goes on, concentrations continue to rise but eventually level off. The leveling point is the point of equilibrium (also called the steady state condition) where the amount of gas exhaled by the room's occupants is in balance with the ventilation rate. When measuring CO₂ concentrations in a space, equilibrium levels will have been reached when concentrations in a space stabilize within a 100 PPM range (e.g. 900 and 1,000 PPM).

When you know the concentration of CO₂ above outside levels at equilibrium, you can use it to determine the ventilation rate per person being delivered to the space. It's important to remember that the main factor in determining ventilation rate isn't the absolute level of CO₂ but rather the difference in concentration between inside and outside.

**Equilibrium Time Lag Under Various Ventilation Conditions
(Office Space)**

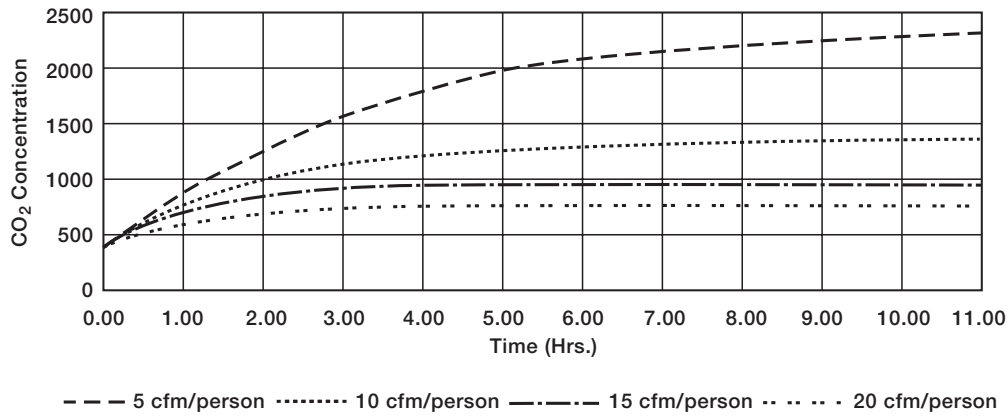

Source: Schell, 68.

Figure 7-4

Figure 7-4 shows the relationship between ventilation and inside/outside CO₂ differential concentration.

The time it takes for a space to reach equilibrium is dependent on the number of people in it, the volume of the space, and the ventilation rate.

If the room is poorly ventilated but has very low occupant densities, it may take a number of hours to reach equilibrium. However, once inside concentrations exceed a certain inside/outside differential, (say a 700 PPM differential equal to 15 CFM per person in Figure 7-4) you can conclude the ventilation rate is probably below acceptable levels.

If, on the other hand, a space has a high occupant density (e.g. a school classroom, bar, or theater), or if ventilation rates are very high, equilibrium levels will be reached rapidly probably within 10 to 20 minutes or less.

CHAPTER 8

BASICS OF PSYCHROMETRY

This chapter covers the basic knowledge of psychrometry, which is the particular branch of thermodynamics devoted to the study of air and water vapor mixtures (Haines 249). To understand the application of energy recovery ventilators, a basic knowledge level of psychrometrics and the air conditioning and heating cycles is required.

Properties of air/water vapor mixtures which are used in HVAC design are defined below. Description of psychrometric charts will be covered on the following pages with a sample application.

Definitions

Dry Bulb Temperature (DB) is measured with an ordinary thermometer.

Dry bulb temperature lines are the vertical lines shown in Figure 8-1.

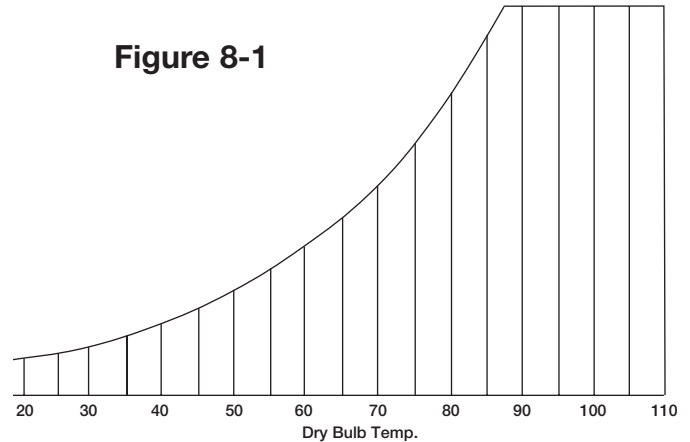

Figure 8-1

Wet Bulb Temperature (WB) is measured using a thermometer with a wet sock wrapped around the bulb. The air being measured is blown across the sock (or thermometer is moved through the air) allowing moisture to evaporate. Evaporation has a cooling effect which is directly related to the moisture content of the air. Wet bulb temperature will thus be lower than dry bulb temperatures unless the air is saturated (100 percent relative humidity). The difference between the two temperatures is termed the *wet bulb depression*. (Haines 250).

Figure 8-2 shows the wet bulb temperature lines on the psychrometric chart.

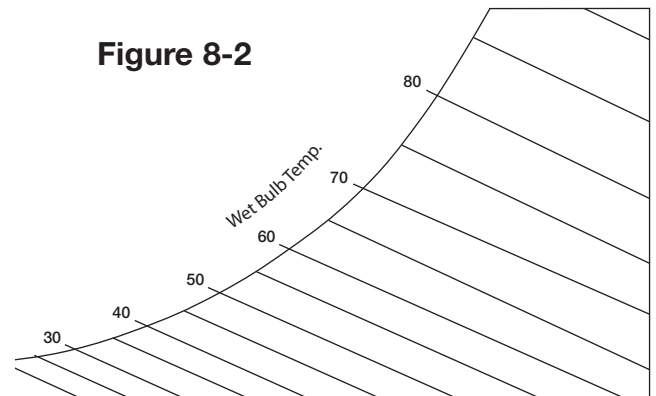

Figure 8-2

Dew Point Temperature (DP) is the temperature to which a given sample of air must be cooled so that moisture will start condensing out of it. When air is saturated, the dry bulb, wet bulb and dew point temperatures will all be equal. (Haines 250).

Dew point temperatures are shown in Figure 8-3.

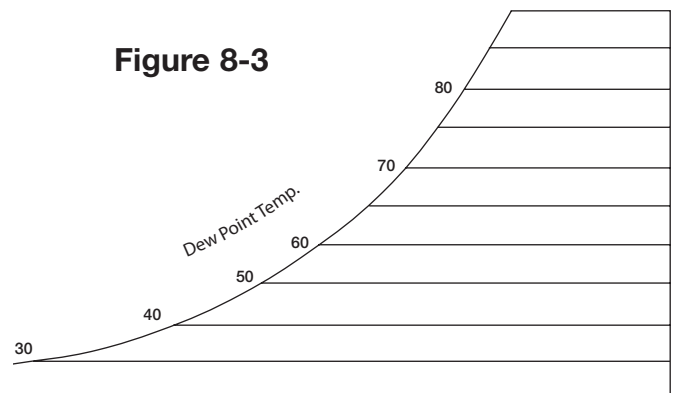
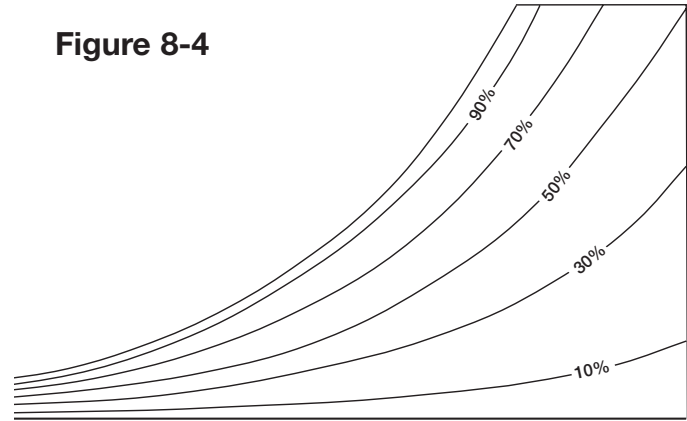

Figure 8-3

Relative Humidity (RH) expresses the amount of moisture in the air relative to the amount the air would hold if saturated at that dry bulb temperature. It is defined as the ratio of partial pressures of water vapor at the two conditions. Beware, *Percent Humidity* is not the same as relative humidity, and is not used in HVAC design. (Haines 250).

Figure 8-4 shows the relative humidity curves on the psychrometric chart.

Figure 8-4



Specific Humidity, sometimes called *humidity ratio*, designated by the symbol “w,” is the amount of water in the air expressed as a ratio: pounds of water per pound of dry air. In some places grains of water per pound of dry air is used. 7,000 grains equal one pound. (Haines 250).

The horizontal lines in Figure 8-5 represent specific humidity.

Figure 8-5

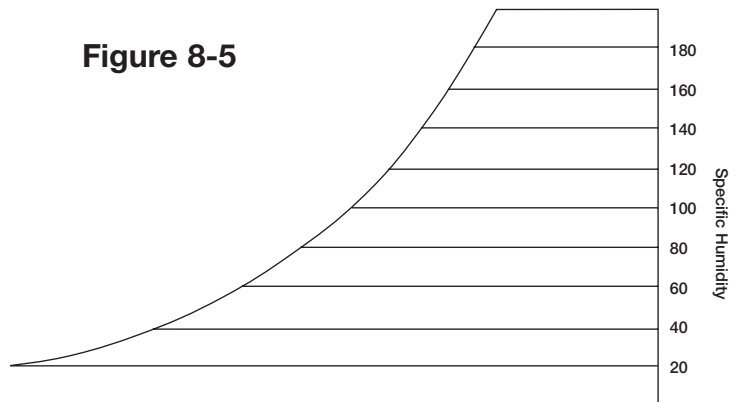

Enthalpy, designated by the symbol “h,” refers to the heat content of the moist air, in Btu per pound of dry air and associated moisture. As used in psychrometrics it is not an absolute value, it relates to an arbitrary zero, usually at 0°F. For this reason, differences between two values of h are valid, but ratios are not. (Haines 250).

Figure 8-6 shows the enthalpy lines on a psychrometric chart.

Figure 8-6

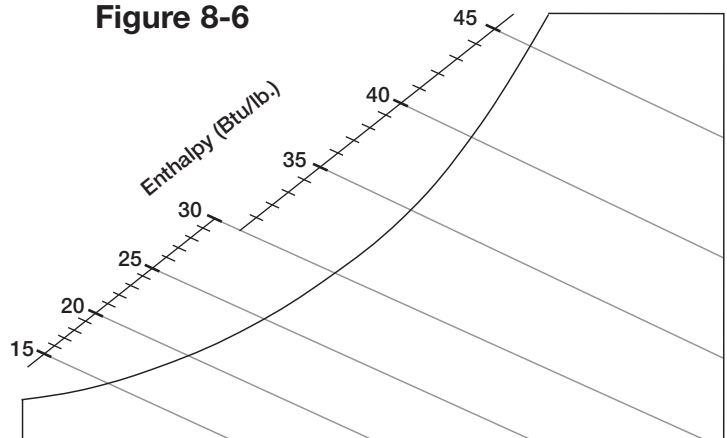

Density and Specific Volume

Density refers to the weight of the moist air, with units of pounds of dry air per cubic foot. Specific volume is the reciprocal of density. (Haines 251).

Atmospheric Pressure

Variations in atmospheric pressure due to elevation above or below sea level have an important effect on the value of the various properties. This is because the total pressure of the mixture varies with atmospheric pressure while the partial pressure of the water vapor in the mixture is a function only of dry bulb temperature. (Haines 251).

Psychrometric Charts

A basic tool used in HVAC design is the psychrometric chart. This chart is simply a graphical representation of the properties described on previous two pages (Haines 251). The psychrometric charts used in this chapter are the Mollier-type, which is a chart ASHRAE uses for illustrating HVAC cycles.

State Points

Any point on the chart can be a state point. It can be defined and located by the values of any two properties. Once the point is located, the values of all other properties can be read. (Haines 251)
See Figure 8-7 and 8-8.

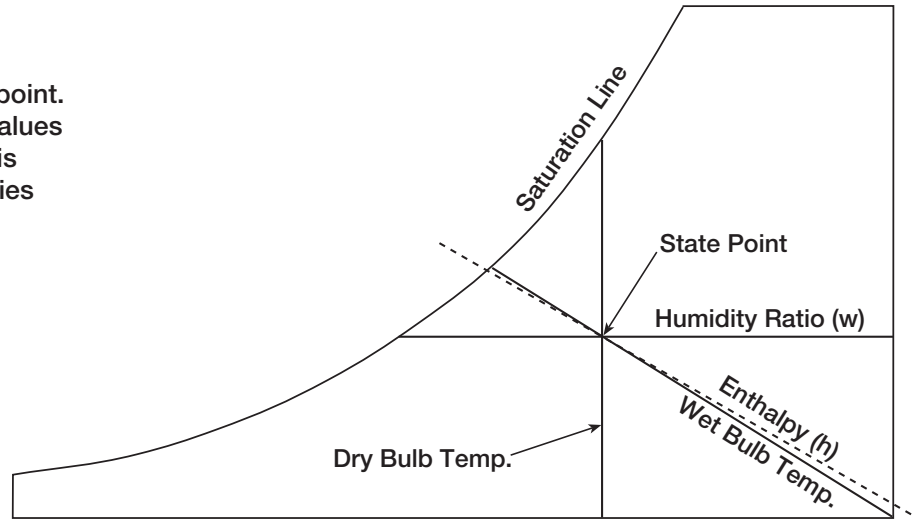

Source: Haines: Control Systems for Heating, Ventilating and Air Conditioning, 253.

Figure 8-7

Known:

Dry Bulb Temperature is **97°F**.

Wet Bulb Temperature is **78°F**.

The other air properties at this point:

Enthalpy is **41.3 Btu/lb.**

Dew Point Temperature is **71°F**.

Relative Humidity is **43%**.

Specific Humidity is **114 grains/lb.**

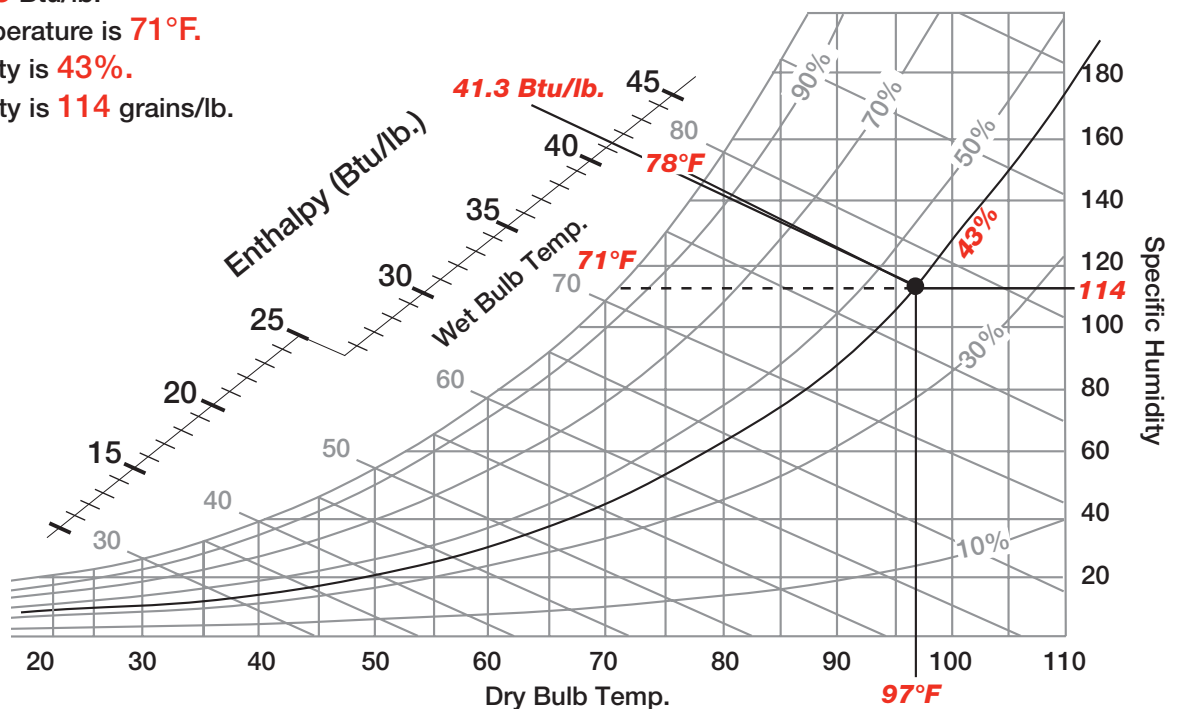

Figure 8-8

Basic Processes on the Psychrometric Chart

Air mixtures are influenced by sensible and latent (moist) heat. State point movement on the psychrometric chart depends on changes in either heat and/or moisture content of the air. The following section shows the directions and reasons that a state point will move on the psychrometric chart.

Examples of State Point Movement on the Psychrometric Chart

Figure 8-9 shows movement of a state point for heating, cooling, humidifying and dehumidifying. **Sensible heating or cooling** (horizontal movement of the air mixture) occurs by adding or removing heat, therefore causing a temperature change without changing the moisture content.

Latent heat transfer (vertical movement) occurs by increasing or decreasing the moisture content of the air mixture, which results in humidifying or dehumidifying. **Latent heat** is energy associated with the moisture content of the air mixture and cannot be measured with a thermometer.

Combinations of heat and moisture changes will cause diagonal movements on the psychrometric chart.

Figure 8-9

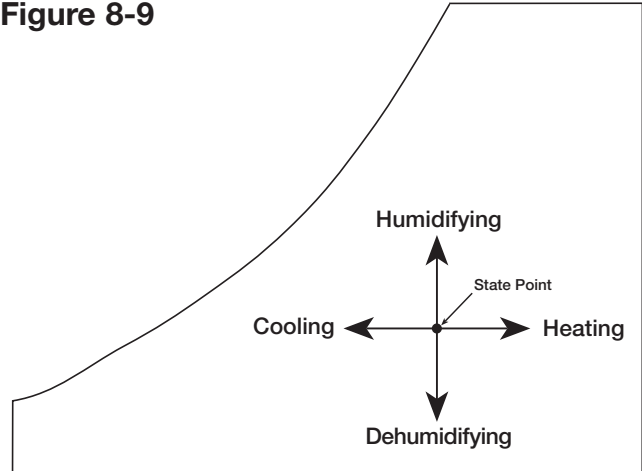

Mixing Airstreams

Mixing two air streams is common in HVAC systems. To determine the properties of the mixture, an illustration using the psychrometric chart is helpful. Let's assume that Outside Air and Return Air from an air conditioning system are being mixed. The Mixed Air point will lie on a straight line connecting the state points of the individual airstreams. The location of the Mixed Air point will be in proportion to the air volumes of the two airstreams.

Mixtures of three or more airstreams require that any two points be used first, with the resulting mixture combined with the third point, and so on.

Figure 8-10

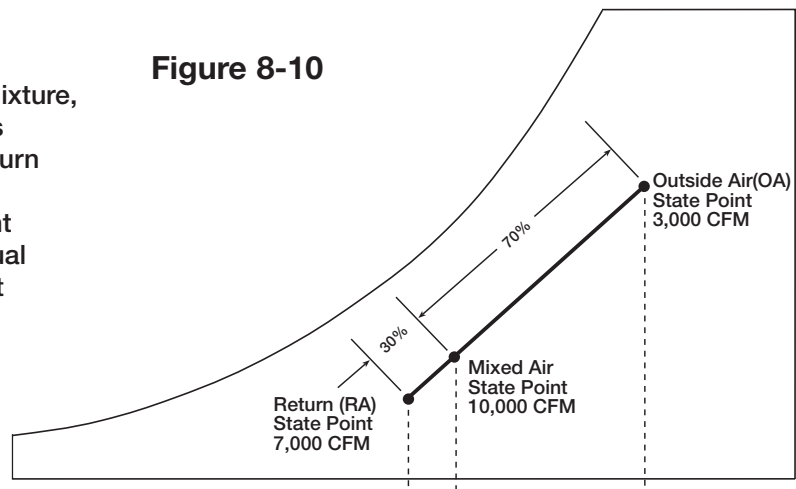

In Figure 8-10, the Mixed Air point is located 70% of the way from the Outside Air point to the Return Air point, because the Return Air (7,000 cfm) represents 70% of the total mixed volume (10,000 cfm). Note that the Mixed Air point is closer to the state point representing the larger air volume.

The Greenheck Energy Recovery Process

Greenheck's energy recovery ventilators transfer sensible and latent heat with virtually the same effectiveness. (In general sensible effectiveness is slightly higher, than total effectiveness, while latent effectiveness is slightly lower.) This characteristic of Greenheck energy wheels allows us to plot the process line on the psychrometric chart as we would plot the mixing of two airstreams.

Let's assume that an energy recovery ventilator is used to transfer energy from Exhaust Air to Outside Air. The properties of the Outside Air after passing through the energy recovery wheel will lie on a straight line connecting the state points of the Outside Air and Exhaust Air. The location of the Outside Air Leaving Wheel point is dependent on the wheel effectiveness. For the example in Figure 8-11, a 75% effective wheel will position the Outside Air Leaving Wheel point 75% of the way from the Outside Air point to Exhaust Air point.

Figure 8-11

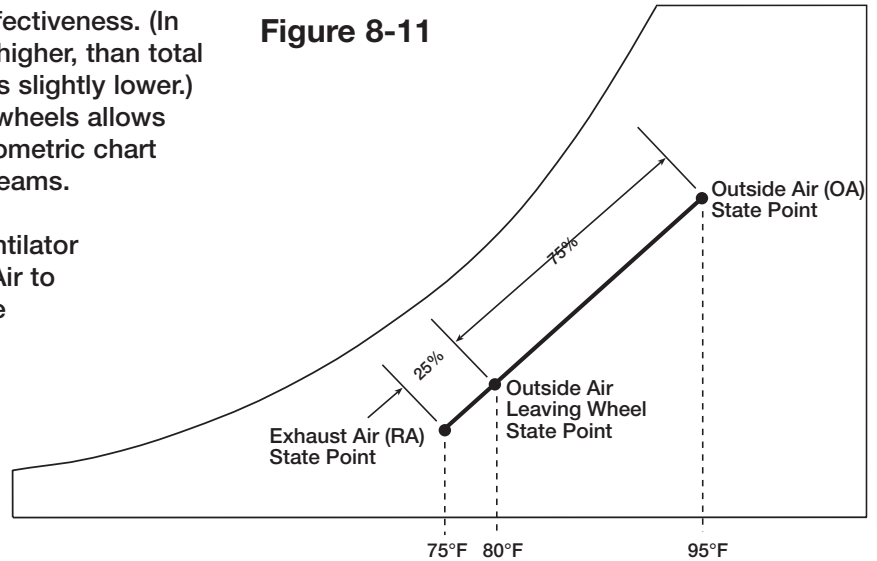

Energy Recovery and Mixing

For many energy recovery applications, both energy recovery and mixing are occurring within the same system. The example shown in Figure 8-12 illustrates this two step process on a psychrometric chart.

Step one is energy recovery, which involves the Outside Air and Exhaust Air. A volume of 3,000 cfm of Outside Air will be supplied, which will replace 3,000 cfm of Room Air that will be exhausted. As the outside air and exhaust air pass through the energy recovery ventilator with a 75% effectiveness, the Outside Air properties move toward the Room Air state point. The position of the outside air is now at the Outside Air Leaving Wheel point.

Step two is mixing, which involves the Outside Air Leaving Wheel (3,000 cfm) and Return Air (7,000 cfm). When the two airstreams mix, the resulting Mixed Air point lies 70% of the way from the Outside Air Leaving Wheel point to the Room Air point.

Figure 8-12

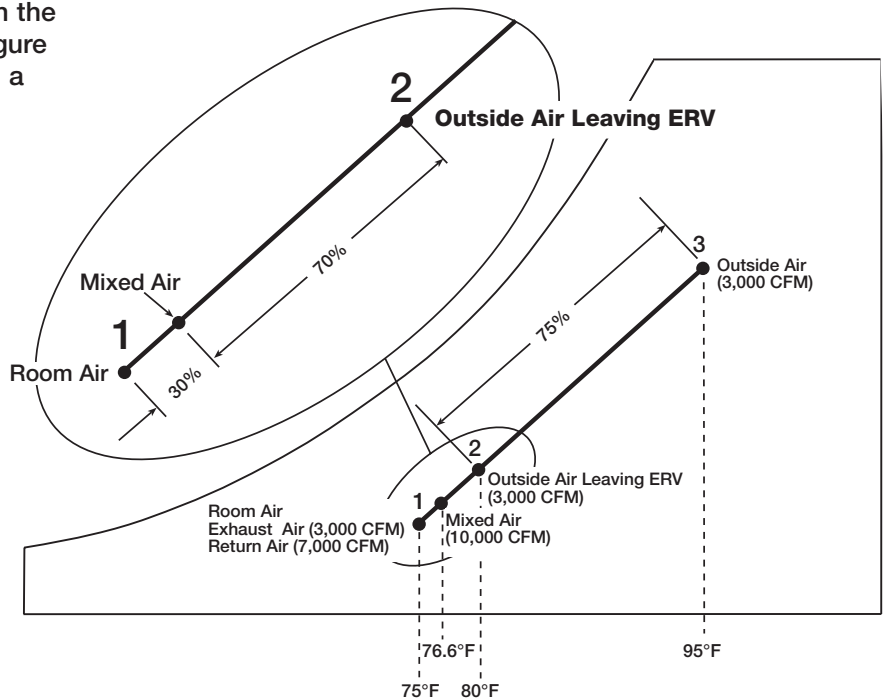

Air Conditioning Process

The air conditioning process cools and dehumidifies air with cooling coils. The process is represented on psychrometric charts by lines commonly referred to as coil lines, shown on Figure 8-13. These lines are the paths of state points as they are cooled and dehumidified (from right to left).

Air leaves the coils at supply conditions, which typically have temperatures and specific humidity values well below the room conditions (i.e. 55°F DB/54°F WB). The room load, which is the total heat given off by items such as office equipment, people and lights, warms the supply air up to room conditions (75°F DB, 50% RH).

Figure 8-13

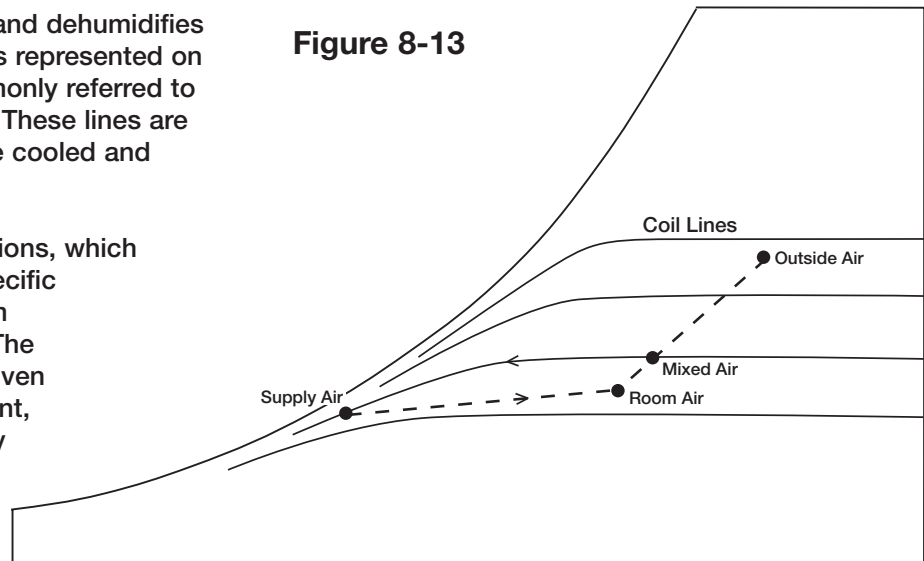

Effects of Altitude on Psychrometric Charts

Many locations where air conditioning is used are at altitudes of several thousand feet above sea level. The difference in atmospheric pressure due to altitude becomes significant about 2,000 feet above sea level. Data obtained from a standard pressure chart may be in error at higher altitudes. Higher altitude charts are available and should be used when appropriate. (Haines 260)

The effect of decreasing atmospheric pressure is to “expand” the chart. That is, given an unchanged coordinate grid of enthalpy and specific humidity, as total pressure decreases the chart is affected in the following manner. (Haines 260):

1. Dry bulb lines are unchanged.
2. The saturation curve and RH curves move upward and farther apart.
3. Wet bulb lines move farther apart.
4. Volume lines move to the right and upward.

Now, we have a basic understanding of the mechanics that govern air-water vapor mixtures. On the following pages are some examples of HVAC cooling and heating cycles. Examples are shown both without and with energy recovery.

COOLING PROCESSES

The following cooling process examples provide a general understanding of the air conditioning cycle as well as sizing of air conditioning equipment.

To size air conditioning equipment, there are several variables that need to be determined. At a basic level, they are:

- Outside Air Design Condition (determined by climate)
- Outside Air Volume (determined by fresh air requirement for occupants)
- Room Air Conditions (indoor temperatures and humidity)
- Supply Air Condition and Volume (calculated by engineer to offset building load)

When these items are known, the air conditioning cycle can be plotted on the psychrometric chart and the air conditioning unit can be sized.

For our example, we will use the following values shown in Figure 8-14:

- Outside Air: 91°F Dry Bulb (DB)
77°F Wet Bulb (WB)
- Outside Air Volume: 3,000 CFM
- Room Air : 75°F DB
50% Relative Humidity (RH)
- Supply Air: 55°F DB
53°F WB
- Supply Air Volume: 10,000 CFM

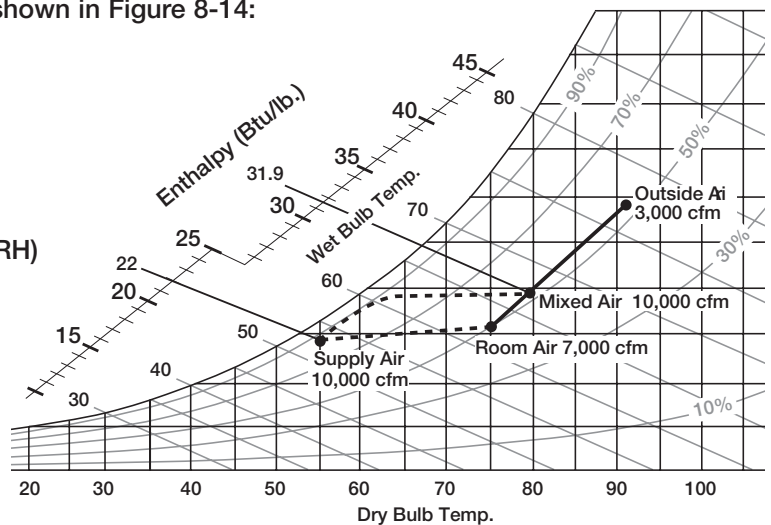

Figure 8-14

Example **without** Energy Recovery

At this point, the 3,000 cfm of Outside Air mixed with 7,000 cfm of returning Room Air. Therefore, the Mixed Air entering the HVAC unit is:

79.8°F DB 67.4°F WB

The HVAC equipment performs the cooling operation on the mixed air. This process moves the air conditions from the mixed air state point to the supply air state point. The supply air is then delivered to the building where the room load warms the air to Room Air conditions.

Note: The cycle shown applies to design conditions (maximum cooling). At part load, the cycle supply air temperature and/or volume will change to match the cooling requirement.

To size the air conditioning coil, we need to determine the enthalpy difference between the Mixed Air point and the Supply Air point. From the psychrometric chart, the enthalpy values are:

Mixed Air: 31.9 Btu/lb. Supply Air: 22.0 Btu/lb.

The enthalpy difference (Δh) is: $\Delta h = h_{\text{mixed air}} - h_{\text{supply air}} = 31.9 \text{ Btu/lb.} - 22.0 \text{ Btu/lb.} = 9.9 \text{ Btu/lb.}$

Now the cooling load can be calculated with the following equation:

$$\text{Total Cooling Load} = \frac{4.5 * \text{Airflow Rate (CFM)} * \Delta h}{12,000} = \frac{4.5 * 10,000 \text{ CFM} * 9.9 \text{ Btu/lb.}}{12,000} = 37.1 \text{ tons}$$

In this case, a 40 ton HVAC unit is required to handle the buildings room and outside air loads.

Example with ERV

This example, seen in Figure 8-15, uses the same design conditions and airflow volumes as the previous example. The only difference is that this example will incorporate a Greenheck model ERV-521S energy recovery ventilator into the system. The ERV-521S has an energy transfer effectiveness of 75% at 3,000 cfm.

Like in the previous example, we need to determine the Mixed Air conditions. But to do this, we need to determine the Air Leaving Wheel conditions first. At 75% effective the ERV pre-conditions the outside air to a point 75% of the distance from outside air to room air. The Outside Air Leaving Wheel point is:

79°F DB 66.5°F WB

Now the Mixed Air point can be determined. After mixing 3,000 cfm of Outside Air Leaving Wheel with 7,000 cfm of return air from the Room, the Mixed Air point is:

76.2°F DB 63.9°F WB

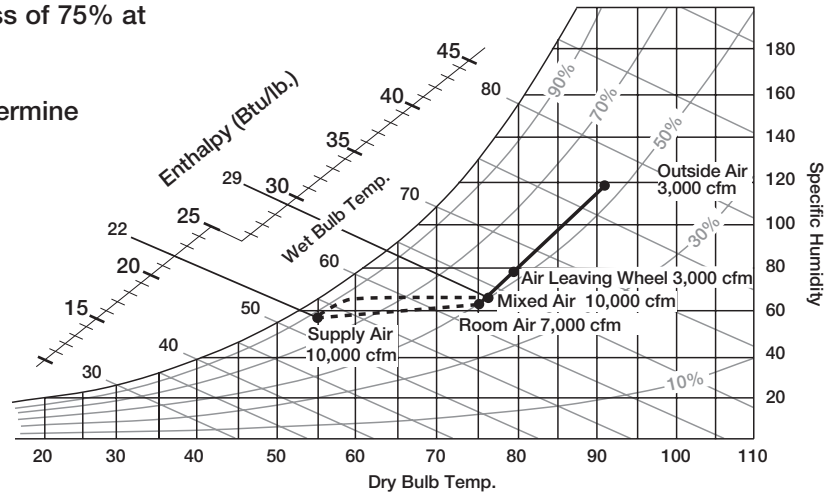

Figure 8-15

The cooling operation of the coil and heating due to the room load is the same as in the previous example. Also, the air conditioning coil is still sized based on the enthalpy difference. Again, from the psychrometric chart, the enthalpy values are:

Mixed Air: 29.0 Btu/lb. Supply Air: 22.0 Btu/lb.

This gives an enthalpy difference of 7.0 Btu/lb.

Plugging the Δh into the equation, the cooling load is:

$$\text{Total Cooling Load} = \frac{4.5 * \text{Airflow Rate (CFM)} * \Delta h}{12,000} = \frac{4.5 * 10,000 \text{ CFM} * 7.0 \text{ Btu/lb.}}{12,000} = 26.25 \text{ tons}$$

This system would require a 30 ton HVAC unit. Notice what happens when we use energy recovery. The mixed air condition is located closer to the room air condition. This corresponds to a lower enthalpy value for the mixed air. As a result, the air conditioning load is reduced dramatically (from 40 tons to 30 tons).

HEATING PROCESSES

The heating process starts with cold, dry outside air (state 1) mixing with the warmer, more moist room air (state 2). The heater (electric, steam, etc) performs a sensible heating operation and warms the Mixed Air to state 4. The moisture content of the air at state 4 is too low and requires humidification to state 5. State 5 conditions equalize back to room conditions because of the room's probable negative thermal load. This process is depicted in Figure 8-16.

In these examples and in most applications, only the sensible portion of the heating load is considered important. The latent component is usually very small and can be ignored.

Figure 8-16

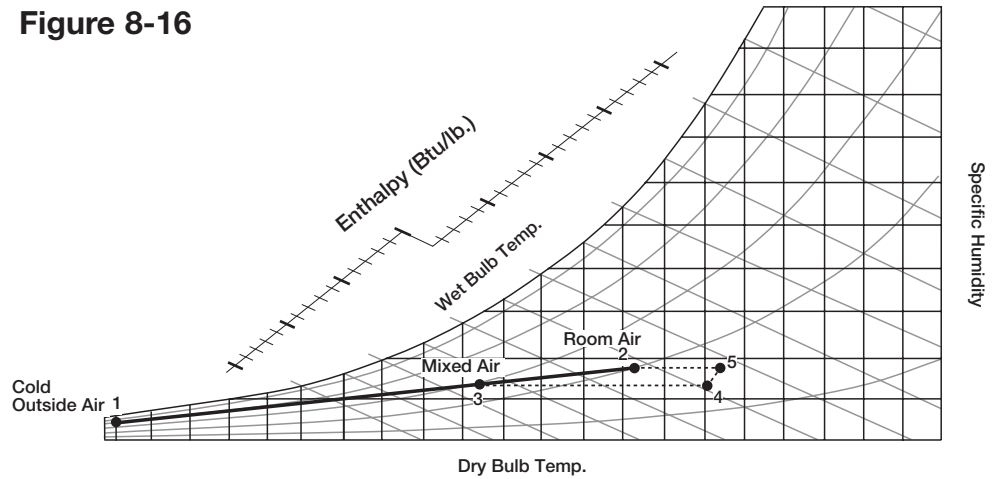

Example **without** ERV

For our example, we will use the following values shown in Figure 8-17:

- Outside Air: 5°F
- Outside Air Volume: 3,000 CFM
- Room Air : 72°F DB
35% Relative Humidity (RH)
- Room Air Volume: 7,000 CFM

Note: The flatness of the mixing line between outside air and room air makes the latent component of the heating load negligible. The latent component is measured by wet bulb temperature and enthalpy.

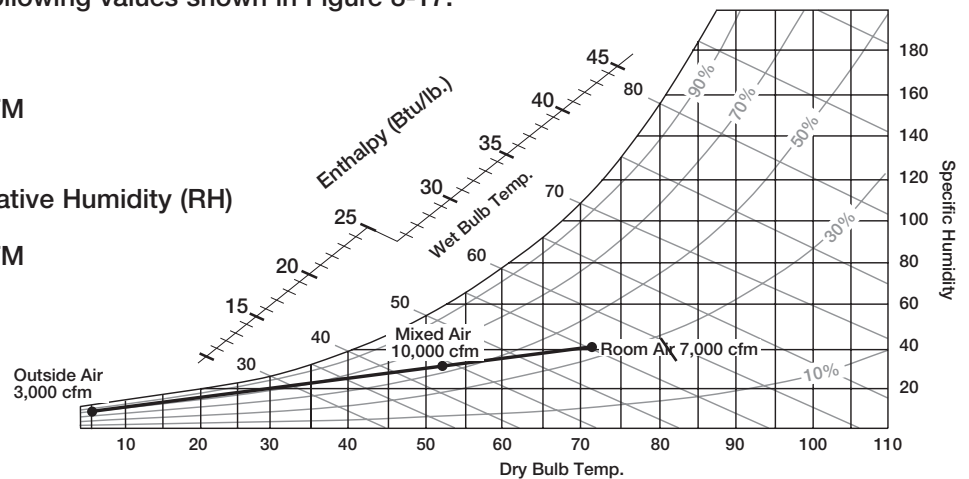

Figure 8-17

Figure 8-17 shows the mixing process with 3,000 cfm outside air and 7,000 cfm return air. Without an energy recovery ventilator the Mixed Air temperature is 52°F DB.

In heating applications, latent load plays no role in the load calculation. The sensible component of the load is dominant and the following equation shows this simplified calculation. Here the ΔT is the temperature difference between the Mixed Air and the Room Air. The room load for this calculation is also assumed to be zero.

$$\begin{aligned}
 \text{Sensible Heating Load (Btu-h)} &= 1.085 \times \text{CFM} \times \Delta T \\
 \text{without ERV} &= 1.085 \times 10,000 \text{ cfm} \times (72^\circ\text{F} - 52^\circ\text{F}) \\
 &= 218,085 \text{ Btu-h}
 \end{aligned}$$

Example with ERV

This example uses the same design conditions and airflow volumes as the previous example, see Figure 8-18. The only difference is that this example will incorporate a Greenheck model ERV-521S energy recovery ventilator into the system. The ERV-521S has an energy transfer effectiveness of 75% at 3,000 cfm.

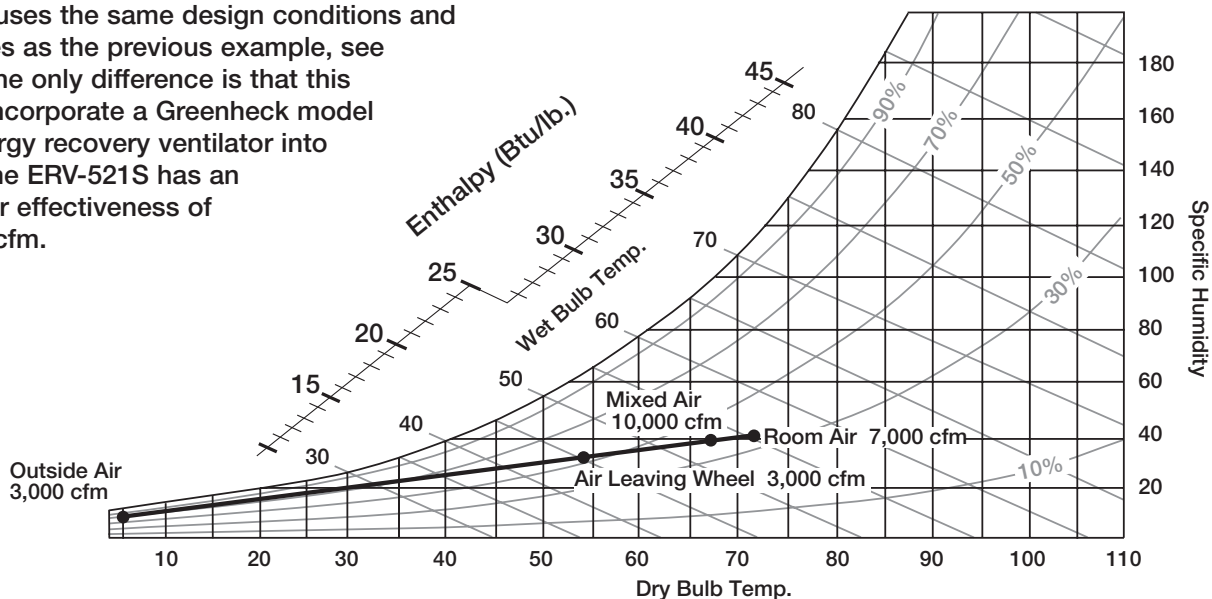

Figure 8-18

As in the previous example, we need to determine the Mixed Air conditions. But to do this, we need to determine the Air Leaving Wheel conditions first. At 75% effective the ERV pre-conditions the outside air to a point 75% of the distance from outside air to room air. The Outside Air Leaving Wheel point is:

54°F DB

Now the Mixed Air point can be determined. After mixing 3,000 cfm of Outside Air Leaving Wheel Air with 7,000 cfm of return air from the Room, the Mixed Air point is:

66.7°F DB

The return air mixture is still 10,000 cfm, 30% outside air and 70% inside air, however the energy recovery wheel has drastically reduced the temperature difference between the outside air and the returning room air. The mixed air is now at a dry bulb temperature of 66.7°F compared to 52°F without the ERV. The difference between heating loads is shown below.

This ΔT , as in the previous example, is the temperature difference between the mixed air and the room air. The room load was also assumed to be zero in this example.

$$\begin{aligned}
 \text{Sensible Heating Load (Btu-h)} &= 1.085 \times \text{CFM} \times \Delta T \\
 \text{with ERV} &= 1.085 \times 10,000 \text{ cfm} \times (72^\circ\text{F} - 66.7^\circ\text{F}) \\
 &= 57,505 \text{ Btu-h}
 \end{aligned}$$

The ERV reduces the design heating load by 160,580 Btu-h.

REFERENCE PAGE

ASHRAE. 1989. *ANSI/ASHRAE Standard 62-1989, Ventilation for Acceptable Indoor Air Quality*. Atlanta, Georgia: ASHRAE

“Davison Molecular Sieves,” publication of Davison Chemical Company, Baltimore, Maryland.

Jack Dozier, “ Meeting ASHRAE 62-89 at Lowest Cost,” *HEATING / PIPING/ AIR CONDITIONING*, January 1995, pp. 115-116, 118-119.

Robert Eade, “Humidification Looming Larger in IAQ,” *Engineering Systems*, January 1996, p. 49.

Roger W. Haines, *Control Systems for Heating, Ventilating and Air Conditioning* (New York: Van Nostrand Reinhold Company, 1983), pp. 249-254, 260-261.

Sam Harper, “ Available Equipment and Applications for IAQ.”

Lawrence C. Hoagland, Ph.D, “Gas Phase Adsorption on Silica Gel,” publication of Airxchange, Incorporated, Rockland, Massachusetts. pp. 1-2.

John E. Janssen, P.E., “The V in ASHRAE: An Historical Perspective,” *ASHRAE Journal*, 1994, pp. 126-132.

Mark J. Mendell, “ Non-specific Symptoms in Office Workers: A Review and Summary of the Epidemiologic Literature,” *Indoor Air*, Munksgaard 1993, p. 232.

National Health Survey 1981; U.S. Department of Health and Human Services.

“Relative Humidity Guidelines,” *American Heat Pipes*, February 1994.

Mike Schell, “Measure and Control CO₂,” *CONTRACTING BUSINESS*, September 1994, pp. 64-68.

Mike Schell, “Measure and Control CO₂,” *CONTRACTING BUSINESS*, October 1994, pp. 58.

E.M. Sterling, “Criteria for Human Exposure to Humidity in Occupied Buildings,” *ASHRAE*, 1985.

Jan Sundell, Ph.D, “What We Know, and Don’t Know About Sick Building Syndrome,” *ASHRAE Journal*, 1996, p. 56.

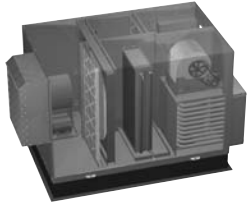

Models ERH / ERCH

Combine the advantages of the energy wheel with supplemental heating or cooling.



Model ERT

Combines the benefits of the energy wheel and a wrap around heatpipe with supplemental heating and cooling.



Model ERM

The Model ERM energy recovery modules offer the advantages of Greenheck's energy recovery wheel for use in built-up ventilation systems.

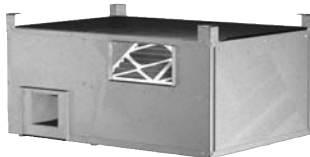

MiniVent

The MiniVent energy recovery ventilator is designed for applications requiring 300-750 cfm. The unit is designed for floor mount, wall mount or hanging from the ceiling.

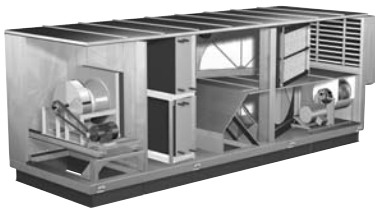

Model APEX

The Model APEX is designed for energy recovery applications requiring up to 20,000 cfm. Supplemental heating or cooling is available.

Our Warranty

Greenheck warrants this equipment to be free from defects in material and workmanship for a period of one year from the purchase date. The energy recovery wheel is warranted to be free from defects in material and workmanship for a period of five years from the purchase date. Any units or parts which prove defective during the warranty period will be replaced at our option when returned to our factory, transportation prepaid. Motors are warranted by the motor manufacturer for a period of one year. Should motors furnished by Greenheck prove defective during this period, they should be returned to the nearest authorized motor service station. Greenheck will not be responsible for any removal or installation costs. As a result of our commitment to continuous improvement, Greenheck reserves the right to change specifications without notice.

P.O. Box 410 • Schofield, WI 54476-0410 • Phone (715) 359-6171 • greenheck.com

