

Energy Storage 101

A Quick-Reference Handbook

Prepared By The Energy Transition Lab, University of Minnesota

Introduction



Image source: Andy Armstrong (CC BY-SA 2.0), Battery, via Flickr.

Energy Storage

Batteries are a huge part of energy storage, particularly when it comes to integrating and adding value to variable renewable sources like wind and solar. Energy storage is so much more than the latest advancement in lithium battery technology, though – from pumped hydro to magnetic fields, energy can be stored in a multitude of ways and put to a wide variety of uses.

In broad terms, four families of energy storage populate today's market: chemical, thermal, mechanical, and electrical.¹

Chemical storage includes such well-known technologies as **dry-cell batteries** (for example, Duracell and Tesla) and traditional fuels (gasoline is a highly convenient form of stored energy). It also includes less-traditional battery and fuel technologies, such as **flow cell batteries**, **fuel cells**, and hydrogen **fuel**. These forms of energy storage are valued for both their versatility and portability. Batteries can range in scale from smaller than a bacterium to as large as a house, and can be used individually or connected to form great battery banks that store a significant amount of energy. Fuels, especially liquid fuels, are easily transported and stored so that their energy is available where and when it is needed. Flow batteries and fuel cells essentially combine the two, resulting in batteries with nearly unlimited useful lives that can also be recharged quickly. Common issues with chemical energy storage include the costs of scaling up, as well as efficiency and capacity limitations inherent in the technology in use today.

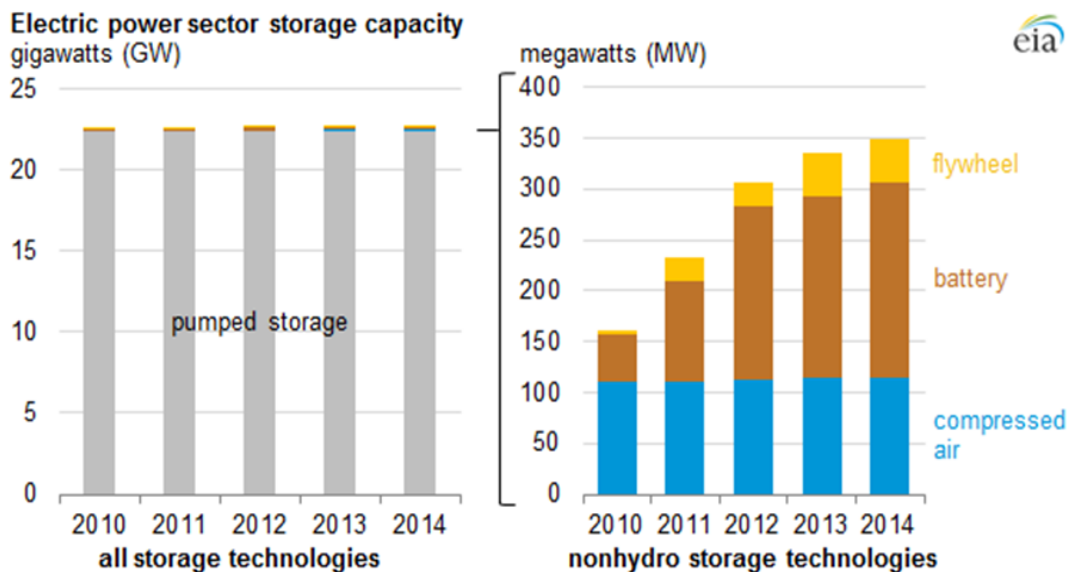

Image source: U.S. Energy Information Administration, EIA-860 Survey (2015).

¹ ENERGYSTORAGE, *Types of Energy Storage* (2012), <http://www.energystorage.org.uk/types-of-energy-storage.html>.

Types of Energy Storage

Thermal storage is already commonly available. There's a program in Minnesota employing over a gigawatt-hour of energy storage every night.² It works by distributing large-capacity, well-insulated **water heaters** to residents and then giving them a discount for allowing the utility to heat the water only when energy is plentiful. The electricity from the grid is then stored as heat, which the customer makes use of throughout the day. This kind of storage works with **water, sand, gravel, ceramics**, and even **molten salt**, a popular grid-scale option. Additionally, the heat can be stored through a **phase change**, such as freezing water to ice at night when electricity is inexpensive, to be used for space cooling the following day.³

Mechanical energy storage, which often makes use of gravitational potential energy, is deceptively simple. It generally involves moving a solid or a liquid (or compressing a gas) when energy supply is high, and allowing it to return (or decompress) when demand is high. **Pumped hydro** is the largest form of energy storage in the United States, accounting for 95% of grid-scale projects as of 2013.⁴ Water is pumped behind a dam using electricity when prices are low, and then allowed to flow through the turbines to generate electricity for the grid when demand pushes prices up. **Compressed air** works similarly, through the use of large underground caverns. One energy services corporation even uses **rail cars** loaded with gravel to accomplish grid-scale storage – electricity drives the heavy train cars uphill, and gravity pulls them back down. Work is currently underway to improve the efficiency of many of these technologies.

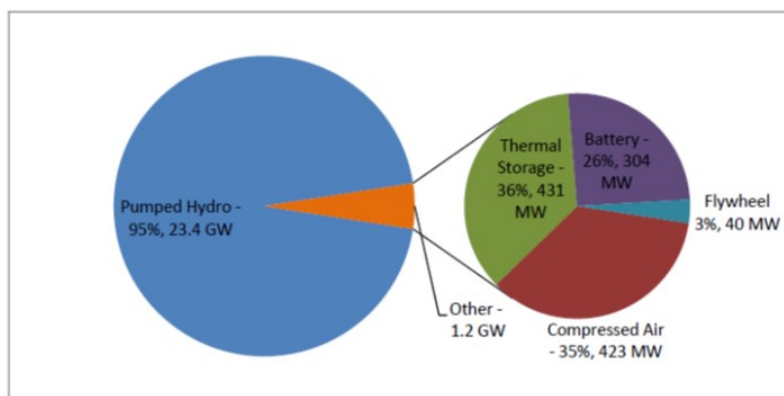

Image source: U.S. Dep't of Energy, *Grid Energy Storage* (2013).

² GREAT RIVER NEWS, *Co-ops Push Back on Water Heater Issues* (Jan. 2013).

³ International Renewable Energy Agency, *THERMAL ENERGY STORAGE: TECHNOLOGY BRIEF* (Jan. 2013).

⁴ U.S. Dep't of Energy, *GRID ENERGY STORAGE* (Dec. 2013).



Types of Energy Storage

One highly specialized use of mechanical energy storage comes in the form of **flywheels**. Flywheels are large, heavy cylinders that spin in near frictionless environments. Large banks of such flywheels provide grid stabilization services in much the same way as other forms of mechanical energy, but for very different purposes: energy is stored as kinetic energy as the cylinders are sped up to over 50,000 rpm; when rapid fluctuations in the balance of generation and load on the grid work to destabilize the system, the energy from the flywheels can be harvested very quickly to offset these fluctuations, maintaining **system stability** and **power quality**.⁵

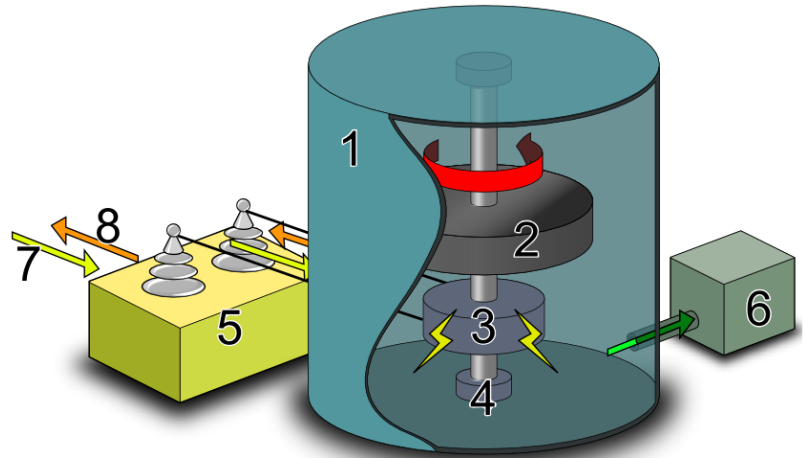

Flywheel Battery

- | | |
|---------------------|----------------|
| 1. Case | 5. Inverter |
| 2. Flywheel (Rotor) | 6. Vacuum Pump |
| 3. Generator/Motor | 7. Charge |
| 4. Bearing | 8. Discharge |

Image source: Tosaka (CC BY 3.0), *Flywheel-battery (Model)*, via Wikimedia Commons.

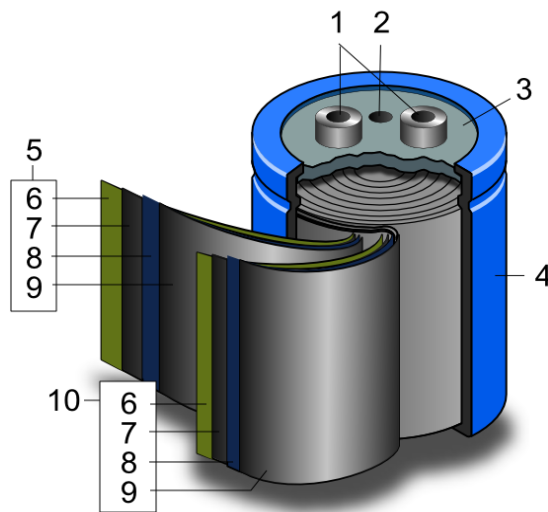

Wound Supercapacitor

- | | |
|------------------|---------------------|
| 1. Terminals | 6. Separator |
| 2. Safety vent | 7. Carbon electrode |
| 3. Sealing disc | 8. Collector |
| 4. Aluminum can | 9. Carbon |
| 5. Positive pole | 10. Negative pole |

Finally, electricity can be stored **directly**, through the use of **electromagnetic fields**, **capacitors** and **supercapacitors**. Outside of their specialized uses in advanced electronics, these forms of storage are best suited to grid stabilization and power quality purposes.

Image source: Tosaka (CC BY 3.0), *Electric double-layer capacitor*, via Wikimedia Commons.

⁵ ENERGY STORAGE ASSOCIATION, *Flywheels* (2015), <http://energystorage.org>.

Uses for Energy Storage

As you can see, storage has the potential to bring a number of benefits to the grid beyond simply storing electric energy for later use. Integration of the electricity grid with complementary systems (thermal energy, electric vehicles, etc) allows storage to serve many useful functions at several levels, including the transmission, distribution and customer scales:

- “
- **Managing Supply and Demand** – energy customers [on demand-based rates] can reduce their bills by shifting energy use to low demand periods or by reducing their maximum energy use in a given month. Energy storage can cost effectively supply capacity and backup power that has historically been provided by expensive quick response fossil fuel power plants.
 - **Delivering Ancillary Services** – at every moment supply and demand of electricity must be in balance. Energy storage can respond more quickly than most existing technologies, helping maintain the voltage and frequency of the electricity system to avoid damage to connected electronics and motors, and avoid power outages.
 - **Reinforcing Infrastructure** – power lines, transformers and other grid infrastructure wear more quickly when operating at peak capacity. Energy storage can shift energy demand to ease stress on expensive equipment. It also allows energy users to manage their own energy use.
 - **Supporting Renewable Energy** – [...] Energy storage responds quickly and effectively to variations in renewable energy output, enabling [cost-effective integration of] penetrations of wind and solar on the electric grid [in excess of 50%].⁶
- ”

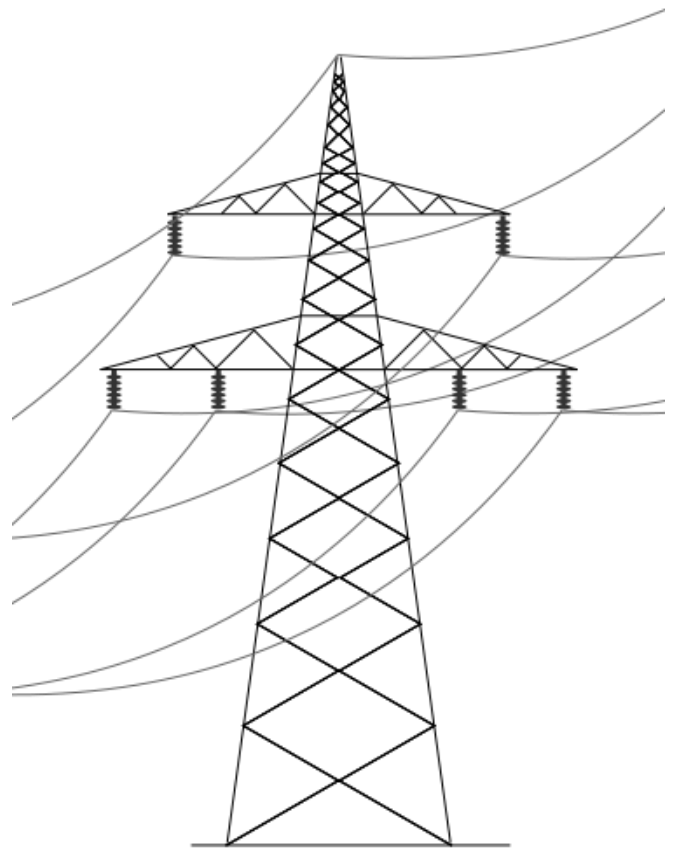

Image source: Benoit Serrier (GFDL, CC-BY-SA-3.0), *Power line*, via Wikimedia Commons.

⁶John Farrell, Institute for Local Self-Reliance, *ENERGY STORAGE: THE NEXT CHARGE FOR DISTRIBUTED ENERGY* (Mar. 2014), *used with permission*.

Uses for Energy Storage

Storage will be an integral part of the **smarter grid**. As our grid modernizes, it will be more flexible, able to integrate large amounts of distributed energy generated by multiple parties, more efficient, and controlled by real-time, two-way digital communication and control. New utility business models will be needed to reward these services and outcomes, rather than traditional metrics such as growing electricity sales and investment in large centralized power plants. Rate and pricing reforms, like time of use rates, are needed to enable grid innovation. **Ancillary services** that storage can provide in a modernized grid include:

- “
- **Load Following/Ramping:** Load following is the matching of generation to load as it fluctuates during the day. Historically the market for this service required the device be capable of altering its power output as frequently as every five minutes, however recent standards now also allow for markets with some resources responding in seconds. The output changes in response to the changing balance between electric supply and load within a specific region or area. Load following is a particularly valuable service that storage can provide as the system accommodates greater amounts of variable generation. Storage has the ability to respond within seconds, which makes its service particularly valuable. It may also reduce the wear-and-tear associated with using traditional generators for this service.
 - **Electric Supply Reserve Capacity:** Operation of an electric grid requires reserve capacity that can be called upon when some portion of the normal electric supply resources becomes unavailable unexpectedly. There are three types of reserve: spinning reserve (synchronized), non-spinning reserve (non-synchronized), and supplemental reserve. When serving as electric supply reserve capacity, storage cannot typically serve other applications simultaneously.
 - **Voltage Regulation/Support:** The purpose of voltage support is to maintain voltage levels on the electric system by providing or absorbing reactive power or through the use of voltage tap changers that mechanically adjust voltage. The provision and absorption of reactive power is an application for which distributed storage may be especially attractive, because reactive power cannot be transmitted efficaciously over long distances. Notably, many major power outages are at least partially attributable to problems related to transmitting reactive power to load centers. So, distributed storage – located within load centers where need for reactive power is greatest – can be especially helpful in managing voltage.⁷ ”

⁷Sky Stanfield & Amanda Vanega, Interstate Renewable Energy Council, **DEPLOYING DISTRIBUTED ENERGY STORAGE: NEAR-TERM REGULATORY CONSIDERATIONS TO MAXIMIZE BENEFITS 16** (Feb. 2015), *used with permission*.

Uses for Energy Storage

When our energy systems begin to merge electricity and thermal energy management, they can become far more efficient and versatile.⁸ In Germany, for example, “Power to X” refers to the idea of converting excess electricity produced by wind and sun to another useful, storeable energy product (for example, fuel for your vehicle).⁹



Image source: Jacob Edwards (CC BY-NC-ND 2.0), Thunder Storm, via Flickr.

While energy storage can add value to **renewable energy** generation, the transmission grid does not necessarily need additional storage to accommodate near-term growth of renewables in Minnesota. Solar and wind tend to have a complementary relationship, and the distribution of renewable sources geographically reduces the impact of localized weather disturbances on overall generation. A recent engineering study published by the Minnesota Department of Commerce concludes that Minnesota’s current power system, with transmission upgrades, could handle up to **forty percent** wind and solar without impacting reliability – even if no additional storage is added.¹⁰ Rather, the growth of energy storage could help to **push beyond these limits, decarbonize transportation, maintain the stability and affordability of the electric grid, and enable the growth of innovative community-based solutions like microgrids.**¹¹

⁸ INTERNATIONAL DISTRICT ENERGY ASSOCIATION, *What is CHP?* (last visited July), <http://www.districtenergy.org/what-is-chp>.

⁹ Daniel Fürstenwerth & Lars Waldmann, Agora Energiewende, *ELECTRICITY STORAGE IN THE GERMAN ENERGY TRANSITION* (Dec. 2014).

¹⁰ GE Energy Consulting et al., *MINNESOTA RENEWABLE ENERGY INTEGRATION AND TRANSMISSION STUDY* (Prepared for Minn. Utils. & Transmission Cos. and Minn. Dep’t of Commerce, Oct. 2014).

¹¹ John Farrell, *supra* note 6.



Policy, Regulatory and Market Drivers

Storage has many intriguing possibilities for improving energy systems, but not all of them are the most cost effective strategies.¹²

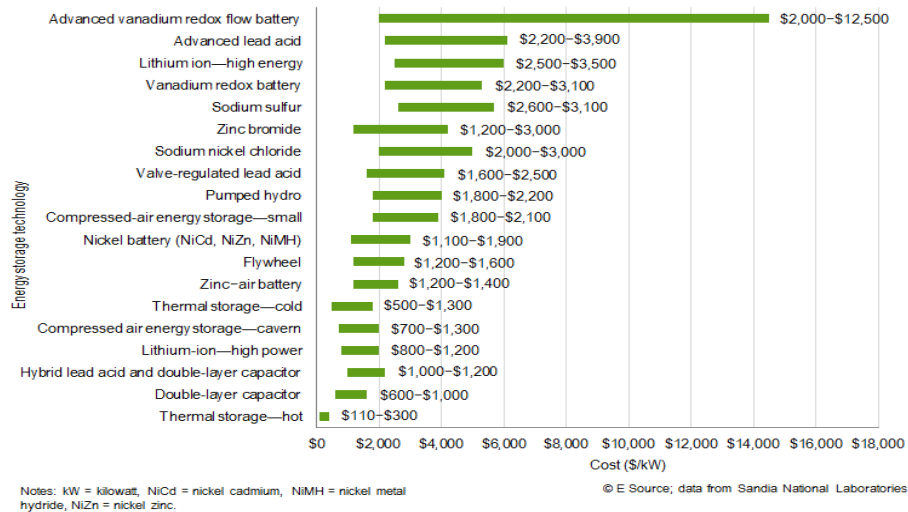

Image source: David Podorson, *E Source White Paper ES-WP-18* (2014).

Policy goals that could be considered in storage deployment are whether its use:

- Is Cost-effective
- Reduces Greenhouse Gases
- Adds value to renewable generation (e.g., as alternative to curtailment)
- Strengthens the grid (ancillary services, etc.)
- Allows energy independence (microgrids, off-the-grid systems)
- Increases resiliency (back-up power for critical infrastructure or vulnerable populations)
- Enables other valuable innovations (e.g., electrification of transportation)

Policy or regulatory incentives should be tailored to meet public policy goals such as these, but should allow for a variety of technology platforms. Policy-makers and regulators need to determine the real value of storage, and **create market mechanisms** to monetize that value, in order to prepare for a rapidly emerging future with very high levels of renewable energy, carbon constraints, and smart technology.

¹² Bentham Paulos, GREENTECH MEDIA, *Why You Should Question the Value Proposition of Energy Storage*, <http://www.greentechmedia.com/articles/read/questioning-the-value-proposition-of-energy-storage> (Oct. 17, 2014).

Policy, Regulatory and Market Drivers

Energy storage is a unique hybrid in that it can both save energy and supply energy, and it can be used at the customer, distribution, or utility scale—so **conventional laws and rules may not fit well**.¹³ Depending on whether a storage resource provides services that act like a generation, transmission, or distribution asset, the governing jurisdiction and cost-recovery rules will vary.¹⁴ Storage can be deployed at the customer, distribution, and utility generation and transmission level. These different arenas may be governed by state regulators (Public Utilities Commissions or PUCs) or the Federal Regulatory Energy Commission (FERC). Regional transmission organizations (RTOs/ISOs) also set market-based rules that determine dispatch order of different resources. Getting the rules right is complicated and will continue to evolve.

A number of **state, regional (ISO/RTO), and federal policy** and **regulatory actions** are attempting to address the regulatory and economic issues in energy storage.¹⁵ California has led the nation in energy storage policy and regulatory incentives.¹⁶ Under AB 2514, the California Public Utilities Commission set utility procurement target of 1.325 gigawatts of cost-effective energy storage systems by 2020.¹⁷ At the distribution level, advanced energy storage projects are eligible for an incentive payment per kwh under the Self-Generation Incentive Program, which supports customer-side generation.¹⁸ Other states are promoting storage with grants and incentives, demonstration and pilot projects, and procurement targets.¹⁹

During Minnesota's 2015 Session, legislation was considered that would create a statewide incentive program for energy storage.²⁰ The bill called for a rebate for utility-controlled, customer-sited energy storage equipment if manufactured in Minnesota. This approach was based in part on a White Paper mandated by 2013 legislation to be commissioned by the Minnesota Department of Commerce to evaluate costs and benefits of different storage use cases.²¹ The 2015 bill enjoyed bipartisan support, but died in conference committee.

¹³ Penelope Crossley, *Defining the Greatest Legal and Policy Obstacle to 'Energy Storage'*, 2013 RENEWABLE ENERGY L. & POL'Y REV., no. 4, 2014, at 268; Amy L. Stein, *Reconsidering Regulatory Uncertainty: Making a Case for Energy Storage*, 41 FLA. ST. U. L. REV. 697 (2014).

¹⁴ Amy Stein, *supra* note 13.

¹⁵ Sky Stanfield & Amanda Vanega, *supra* note 8, at 19-27; Mike Munsell, GREENTECH MEDIA, *GTM Research: 5 States Where Energy Storage Could Thrive*, <http://www.greentechmedia.com/articles/read/GTM-Research-5-States-Where-Energy-Storage-Could-Thrive> (June 3, 2015); Thomas J. Dougherty, NATIONAL LAW REVIEW, *Will 2015 Be 'Just Right' For Energy Storage?* (Jan. 22, 2015); Shelley Welton, Sabin Center for Climate Change Law, Columbia Law School, CLIMATE LAW BLOG, *California Creates First State Energy Storage Mandate* (Oct. 19, 2013).

¹⁶ California ISO, *ADVANCING AND MAXIMIZING THE VALUE OF ENERGY STORAGE TECHNOLOGY: A CALIFORNIA ROADMAP* (Dec. 2014), available at http://www.caiso.com/Documents/Advancing-MaximizingValueofEnergyStorageTechnology_CaliforniaRoadmap.pdf.

¹⁷ Melicia Charles, CAL. PUB. UTILS. COMM'N, *California's Energy Storage Mandate: Electricity Advisory Committee Meeting* (June 17, 2014), available at <http://energy.gov/sites/prod/files/2014/06/f17/EACJune2014-3Charles.pdf>.

¹⁸ ENERGY.GOV, *Self-Generation Incentive Program*, <http://energy.gov/savings/self-generation-incentive-program> (last visited July 13, 2015).

¹⁹ Mike Munsell, *supra* note 15.

²⁰ H.F. 1320/S.F. 1178, 89th Leg (Minn. 2015).

²¹ Strategen Consulting, et al., *WHITE PAPER ANALYSIS OF UTILITY-MANAGED, ON-SITE ENERGY STORAGE IN MINNESOTA* (Prepared for Minn. Dep't of Commerce, Dec. 2013), available at <http://mn.gov/commerce/energy/images/MNStorageStudy-2014-01-03-final.pdf>.



The Future

Here's where Tesla comes in: CEO Elon Musk has put a big bet on batteries, and is building a "gigafactory" in Nevada. The company plans to make a "mass market" affordable version of the Tesla automobile, powered by mass production of lithium ion batteries. Tesla projects the economies of scale will dramatically drive down the cost of storage batteries, knocking as much as 30% off the sales price.²² Tesla is just one example of the many energy storage innovations underway across the nation and globe.



Image source: Christopher DeMorro, *Can The Gigafactory Run On Just Renewable Energy?* <http://gas2.org> (2014); used with permission.

National and global trends are strong: deployment is going up and costs down. Many predict huge future growth in the storage market.²³

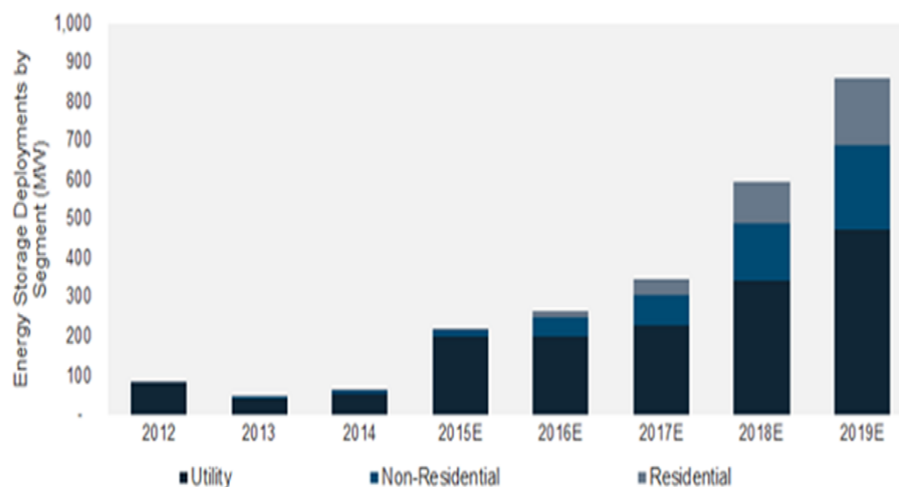

Image source: GTM Research, *U.S. Energy Storage Monitor*, <http://www.energystoragemonitor.com> (2015).

²² TESLA MOTORS, *Blog: Gigafactory*, <http://www.teslamotors.com/blog/gigafactory> (Feb. 26, 2014);

²³ Dougherty, *supra* note 15.

Glossary

Ancillary Services – Services necessary to support the transmission of energy from resources to loads, while maintaining reliable operation of the grid; such services include scheduling, dispatch, reactive power-voltage control, frequency response, and operating reserves.ⁱ

Cogeneration (sometimes co-gen)/Combined Heat and Power (CHP) – A system which generates electricity and useful thermal energy in a single, integrated system, most often fueled by natural gas or biomass; highly efficient.ⁱⁱ

Dispatchable Generation/Load – A DER that can be quickly dispatched to meet needs identified by grid operators, either by increasing available supply or reducing current load.

Distributed Energy Resource (DER) – Electricity source connected to the grid which:

- Generates electricity (from any source);
- Stores energy and can supply that energy to the grid; OR
- Involves load changes by end users in response to price signals or other policy incentives.ⁱⁱⁱ

Flywheel – A heavy, cylindrical body that rotates rapidly around a central axis, storing energy as motion; advantages include very fast ramping and outstanding ability to weather frequent charge-discharge cycles; best for high-power, low-energy applications such as frequency response.^{iv}

Frequency Response – The ability to stabilize grid operating frequency immediately following the sudden loss of generation or load.^v

Ramping – The rate at which energy generation increases or decreases over time.^{iv}

Operating Reserves – Spinning reserve plus additional generation that can respond within up to 30 minutes of request; generally sufficient to offset the capacity of the largest single generator on the grid.^{vi}

Spinning Reserve – Generation capacity connected to the grid that can respond within 10 minutes of request; compensates for temporary, unexpected outages in the system.^{iv}

Thermal Storage – Energy stored as heat; methods include:

- Heating or cooling a storage medium (water, molten salt, ceramics, sand molten salt);
- Phase changes (ice to water, water to steam, etc.); and
- Chemical reactions (adsorption to silica gel, etc.).^{vii}

Variable Generation – Electricity source that depends on fluctuating factors and thus is not continuously available and cannot be dispatched at will; includes renewables such as wind and solar.

Sources:

- i. FERC, *Market Oversight Glossary*, <http://www.ferc.gov/market-oversight/guide/glossary.asp>.
- ii. American Council for an Energy-Efficient Economy, [aceee.org](http://www.aceee.org).
- iii. EPRI, *The Integrated Grid: A Benefit-Cost Framework*.
- iv. Energy Storage Association, energystorage.org.
- v. MISO, <http://www.misoenergy.org>.
- vi. NREL, *Glossary of Transmission Grid Integration Terms*, <http://www.nrel.gov/electricity/transmission/glossary.html>.
- vii. International Renewable Energy Agency, *Thermal Energy Storage: Technology Brief* (Jan. 2013).



Additional Resources

- ⇒ EPRI Rep. No. 3002004878, THE INTEGRATED GRID: A BENEFIT-COST FRAMEWORK, (Feb. 2015), <http://www.epri.com/abstracts/Pages/ProductAbstract.aspx?ProductId=000000003002005177>
- ⇒ DOE Global Energy Storage Database, <http://www.energystorageexchange.org/>
- ⇒ Strategen Consulting et al., WHITE PAPER ANALYSIS OF UTILITY-MANAGED, ON-SITE ENERGY STORAGE IN MINNESOTA (Prepared for Minn. Dep't of Commerce, Dec. 2013), <http://mn.gov/commerce/energy/businesses/energy-leg-initiatives/studies-and-reports/energy-storage-study.jsp>
- ⇒ National Renewable Energy Laboratory, <http://www.nrel.gov/about/>
- ⇒ Global Energy Storage Alliance, <http://www.globalesa.org/>



Image source: Michael Coghlan (CC BY-SA 2.0),
Facebook Connections, via Flickr.

- ⇒ California Energy Storage Alliance, <http://www.storagealliance.org/>
- ⇒ Energy Storage Association, <http://www.energystorage.org>
- ⇒ Alex Davies, WIRED, *Elon Musk's Grand Plan to Power the World with Batteries* (May 1, 2015), <http://www.wired.com/2015/05/tesla-batteries/>
- ⇒ Tim Mullaney, CNBC, *Tesla's New Bet: A Home Batter to Slash Energy Costs* (May 7, 2015), <http://www.cnbc.com/id/102654345>
- ⇒ Uclia Wang, FORBES, *Why Big Companies Want to Invest in Energy Storage Startups* (Jan. 7, 2015), <http://www.forbes.com/sites/uciliawang/2015/01/07/why-big-energy-companies-want-to-invest-in-energy-storage-startups>
- ⇒ IEA, *Opportunities and Investment for Energy Storage Technologies* (Mar. 19, 2014), <http://www.iea.org/newsroomandevents/news/2014/march/opportunities-and-investment-for-energy-storage-technologies-.html>

About the Energy Transition Lab

A strategic initiative of the University's **Institute on the Environment** with funding from the Office of the Vice President for Research, the Energy Transition Lab brings together leaders in government, business and nonprofit organizations to develop new energy policy pathways, institutions and regulations. The Lab, led by Faculty Director Hari Osofsky and Executive Director Ellen Anderson, leverages University expertise in building collaborations with these leaders to create a focal point for innovative solutions.

This report prepared by:

- ⇒ **Ellen Anderson**, Executive Director, Energy Transition Lab
- ⇒ **Erin Sikkink**, Program Assistant
- ⇒ **Jennifer Purdes**, Research Assistant
- ⇒ **Megan Butler**, Research Assistant
- ⇒ **Laura Burrington**, Research Assistant

July 2015

Energy Transition Lab

UNIVERSITY OF MINNESOTA

Driven to DiscoverSM

@UMNenergylab | <http://energytransition.umn.edu/>



Notes

Notes



Sponsors



**PAR Energy Solutions LLC—
Policy Analysis and Regulatory Advice**

Special thanks to our Media Sponsor, Midwest Energy News



@MWenergynews

Energy Transition Lab

UNIVERSITY OF MINNESOTA
Driven to Discover™

@UMNenergylab | <http://energytransition.umn.edu/>

