

ENGINE POWERED FORKLIFT
8FG/8FD 1.0 to 8.0 ton

TOYOTA

8

SERIES



 **TOYOTA**

LIFTING ON TO THE FUTURE

Excellent reliability, durability, stability, and operability cultivated by Toyota – the 8 Series has all this, and can enhance efficiency at your worksite.

ENGINE POWERED FORKLIFT **8SERIES** 8FG/8FD 1.0to8.0ton

Environment

Durability

Stability

Operability



Features and equipment may vary depending on market.





Built with Toyota Engine - tough, reliable, and environmentally friendly

The 8 Series deploys a high-reliability Toyota engine, with the power and durability to support all your operations.

Uncompromising and ample functioning is also delivered by Toyota engines.

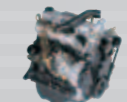
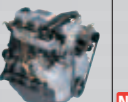

Line-up of Reliable Toyota Engines

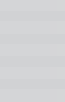
	 TOYOTA 4Y Gasoline 1-K3 ton models	 TOYOTA 1DZ-II Diesel 3-J3.5 ton models	 TOYOTA 2Z Diesel 1-K2.5 ton models	 NEW TOYOTA 1F5 Gasoline 2-J3.5 ton models	 TOYOTA 14Z-II Diesel 3.5-5 ton models	 TOYOTA 14Z-II Diesel 6-8 ton models
Rated Power	40kW /2,400rpm	43kW /2,600rpm	40kW /2,400rpm	44kW /2,600rpm	49kW/2,200rpm	65kW/2,350rpm
Rated Torque	162Nm/1,800rpm	167Nm/1,600rpm	167Nm/1,600rpm	216Nm/1,600rpm	276Nm/1,600rpm	269Nm /1,000rpm
Displacement	2,237cc	2,468cc	2,468cc	3,469cc	3,685cc	5,204cc

Low Fuel Consumption

With new engine(gasoline models) and Load-sensing power steering, 8FG/D35-80 achieves low fuel consumption.

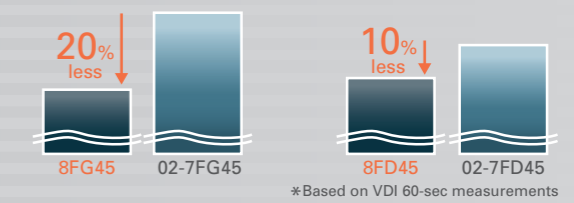

NEW Load-sensing Power Steering (LSPS)

3.5 - 8 ton models

This adjusts the amount of power-steering fluid according to the load burden on the rear axle, reducing energy loss and helping to enhance fuel economy.

NEW 2-stator Torque-converter and Transmission

3.5 - 8 ton models

A 2-stator torque-converter is used to achieved optimal drive power and travel speed with no gear-change. The high-efficiency torque-converter and transmission help to reduce fuel consumption.

NEW Eco-mode OPT

3.5 - 5 ton gasoline models

This restricts acceleration for traveling and load handling, further helping to improve fuel efficiency.

Note: This is included in Multifunction Display (OPT) and Deluxe Multifunction Display (OPT).

NEW Engine Auto Stop OPT

3.5 - 5 ton gasoline models

This feature automatically stops the engine if the operator sets the parking brake but forgets to turn off the engine and leaves seat longer than a preset time. This contributes to lower fuel consumption.

Note: This is included in Deluxe Multifunction Display (OPT) .
 Make sure to follow proper parking process when parking the forklift. (e.g. turn off the engine)

Diesel Particulate Filter DPF-II OPT

This uses an enhanced filtering system to provide excellent black smoke particle elimination.

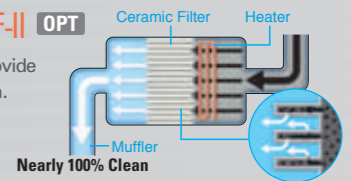

Nearly 100% Clean

Features and equipment may vary depending on market.



Toyota's original safety technology to boost work efficiency

The 8 Series incorporates Toyota's own innovative safety equipment, including SAS and OPS. These features provide stable and smooth operation, and can even help boost work efficiency.



System of Active Stability SAS OPT

Active Control Rear Stabilizer

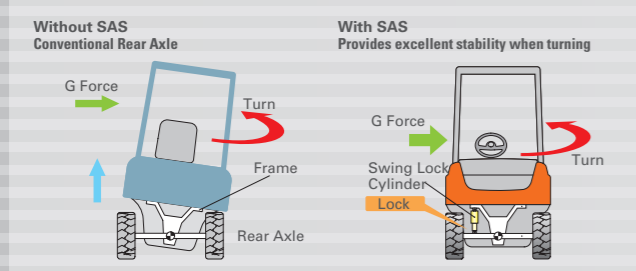

An onboard computer monitors the movement of the forklift and locks the swing of the rear axle when necessary, such as during turns.

Note: This function is not installed when the forklift is equipped with dual front tires. (Includes 6-8ton models)

Active Steering Synchronizer

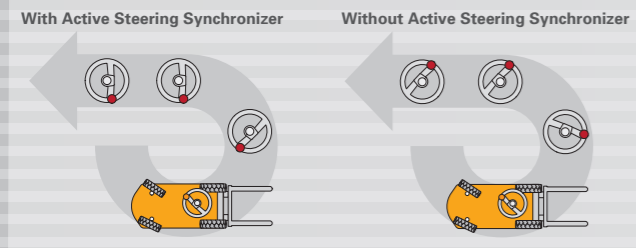

This feature ensures that the angle of the steering wheel corresponds to the angle of the rear steered wheels.

Active Mast Function Controller

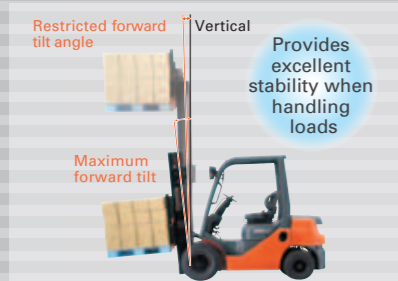

Active Mast Front-tilt Angle Control
The angle of the forward mast tilt is automatically controlled to match the lift height and load weight, helping to prevent dropped loads or tip-overs.

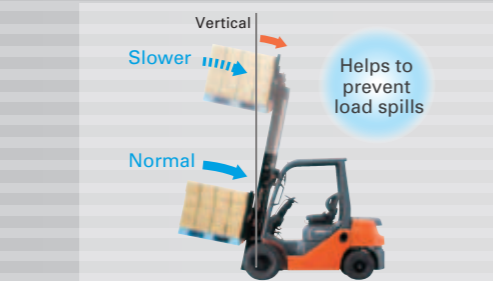

Active Mast Tilt Speed Control
Automatic control of the mast tilt speed at high mast heights, helps to prevent load spills.



Automatic Fork-leveling Control
Pressing a switch during forward tilt automatically stops the forks at a level position. This makes load-handling operations easier, helping to achieve high productivity.

Operator Presence Sensing System OPS

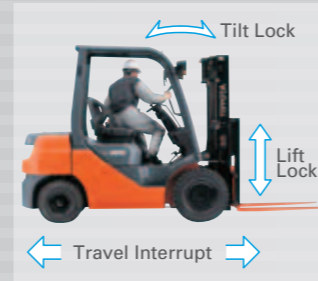

This system uses a switch sensor built into the operator's seat to detect the presence of the operator. If the operator is not in the normal operating position, travel power is interrupted and load handling operations are stopped.

Note: OPS does not operate the brakes. Make sure to follow proper process when you leave the forklift. (e.g. set the parking brake) Travel OPS is not available on manual transmission models.

Key-lift InterLock

This locks fork-lifting down operation when the key switch is off, preventing fork descent in the event of inadvertent lever operation.

Travel and Load-handling Control

Maximum Speed Limitation

1 - J3.5 ton models OPT* 3.5 - 5 ton gasoline models OPT*
This feature enables to limit the maximum speed to a preset level. This helps operators maintain certain speed limits in the work area.

Low-speed Setting

1 - J3.5 ton models OPT* 3.5 - 5 ton gasoline models OPT*
This feature limits the maximum speed to a preset level when the switch is pressed. This can be useful at locations such as customer worksites that have different speed rules for outdoor and indoor operations.

Lift-height and Load-sensing Vehicle Speed Control

1 - J3.5 ton models / Powershift models OPT*
This feature limits the maximum speed depending on lift-height and load weight, thereby helping to reduce the likelihood of instability.

Lift-height and Load-sensing Sudden Start Off Prevention Feature

1 - J3.5 ton models / Powershift models OPT*
This feature suppresses sudden acceleration of the vehicle to help to reduce the risk of load spills when starting to the forklift after loading at high lift height.

Automatic Idle-up Device

1 - J3.5 ton models OPT*
The idle revolution of the engine is automatically increased during lifting operations so that loads will be smoothly lifted without depressing the accelerator.

*Selection of these features requires installation of additional options as well. For details, please see the option chart on page 13.
Note: The vehicle may not reach or may exceed set speed. This feature does not eliminate the possibility of tip-over, but helps reduce the potential of forklift instability.

Features and equipment may vary depending on market.



Outstanding visibility for high performance

The 8 Series, designed from a workplace perspective, provides a clear view of the fork tips and areas around the forklift. This outstanding visibility supports safe and accurate operation.



Upward visibility
An optimally designed overhead guard provides a good upward view.

Forward visibility
Optimal mast width and hose layout ensure a clear view of the front of the forklift.

Fork-tip visibility
Equipped with a small-diameter steering wheel, optimally positioned display, and an angled lower stay for the backrest, the 8 Series achieves excellent visibility of the fork tips.

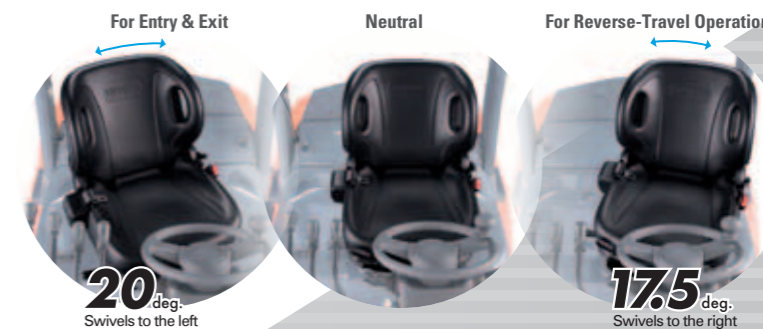

Swivel Seat **OPT**

The seat swivels 17.5 degrees to the right, enabling the operator to maintain a comfortable posture when reversing. The seat also swivels 20 degrees to the left, makes getting off even easier.



Rear-pillar Assist Grip **OPT**

This assist grip with horn button supports the driving position and offers easy horn operation while traveling in reverse.

Features and equipment may vary depending on market.



Designed for outstanding operability and operator comfort

You find an outstanding comfort as soon as you get on the 8 Series. A compact but roomy body, a small-diameter steering wheel, and other operator-friendly design features of the 8 Series provide you with comfortable and efficient operation.



Easy Entry and Exit



Large Assist Grips
Large assist grips are used to enable operators of all sizes get on and off smoothly.

Low and Wide Step
Along with adopting a low height for the step, it has also been made wider, facilitating frequency entry and exit.



Small-diameter Steering Wheel

The small-diameter steering wheel teams up with the full hydraulic power steering system to provide excellent maneuverability. The steering column offers stepless adjustment to accommodate a wide range of operator preferences.



Wide Floor Space
The spacious floor space enables a more relaxed operating position that contributes to comfort.

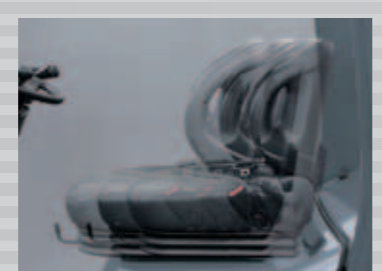

ORS Seat
The ORS seat can be adjusted 150 mm and supports a comfortable operating posture by means of side wings and a seatbelt.
*ORS: Operator Restraint System



Foot-activated Parking Brake
1-J3.5 ton Powershift models
Activate
Release

Parking Brake
The 8 Series uses a double-action parking brake that has a release button to prevent inadvertent disengagement. The 8FG/D10 to J35 Powershift models use a foot-operated parking brake that can be engaged with just a single foot-press.

Easy-down System

1-J3.5 ton V mast models
When the forks are lowered, this system controls the speed of descent before the forks touch with the ground, contributing to reducing the noise of impact.

Mini Lever **OPT**

These small, easy-to-operate levers provide total load handling operation and travel direction selection. A fatigue-reducing armrest is provided.

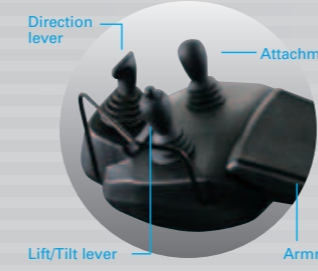
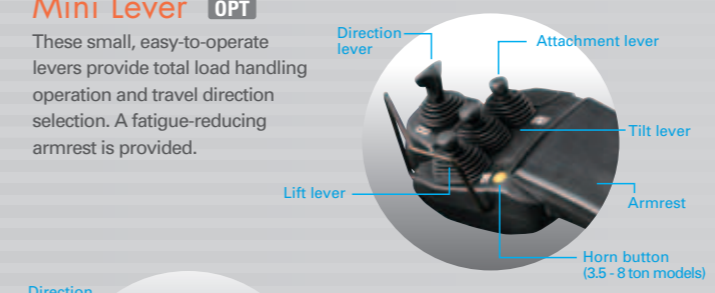

Joystick **OPT**

Both lift and tilt operations are controlled by a single lever. Simultaneous lifting and tilting can be operated.

Cabin with Folding Door **1 - J3.5 ton models OPT** Steel Cabin **3.5 - 8 ton models OPT**

This helps ensure comfort by shielding the operator against low temperatures, wind, and precipitation in cold climates.



The model shown is the 8FG25.

Features and equipment may vary depending on market.



Features for high durability and reliability

High water resistance, self-protective features such as an engine-protection function, and other features of the 8 Series boost reliability and durability. What's more, the 8 Series is equipped with many ease-of-service features. These all help extend vehicle life.



Multifunction Display **OPT** Deluxe Multifunction Display **OPT**

The Multifunctional Display offers useful information for operations. The following are some of the display screens.

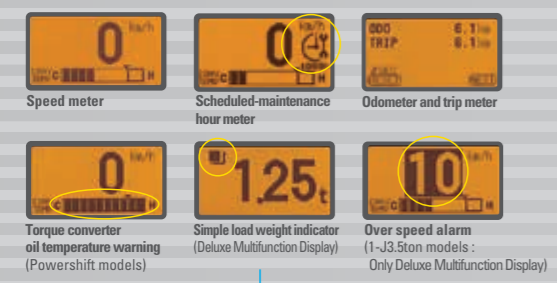

Combination Meter

Necessary instrumentation, such as the fuel meter, water temperature indicator and hour meter are shown in an easy-to-monitor digital format.

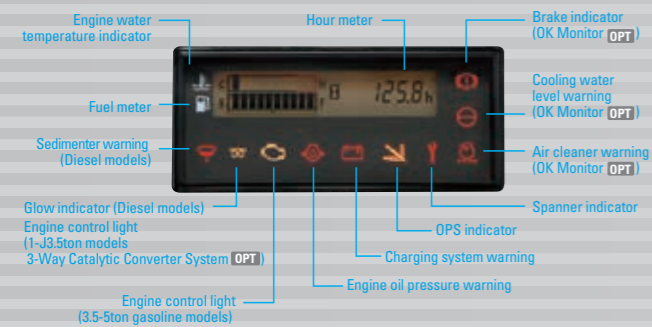

Engine-protection Function

3.5-5 ton gasoline models
When the engine controller detects a malfunction such as high engine water temperature, this function automatically restricts engine output or stops the engine and informs the operator by the combination meters, to help prevent further malfunction.

Torque-converter Interlock **OPT**

3.5-8 ton models
When the operator attempts switchback during high-speed travel, this automatically shifts the vehicle into neutral. After vehicle speed is reduced to below a preset level, the vehicle changes its driving direction. This reduces excessive strain on the torque converter, and also reduces tire wear due to wheelspin.



Radiator Cover

No tools are needed to remove the radiator cover. The fastening knobs can easily be turned by hand to enable quick inspections or servicing.



Water-resistant Connectors

Connectors for most electrical components are highly water-resistant, increasing the reliability of the electrical system.



LED Headlights **OPT** LED Rear Working Lights **OPT**

Power-saving, long-life LED lights are available for the headlights and rear working lights.

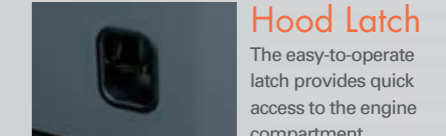

Hood Latch

The easy-to-operate latch provides quick access to the engine compartment.



Floorboard of Two-piece Design

The rear boards can be removed without using tools, providing easy access during daily operator checks.

Features and equipment may vary depending on market.



STANDARD EQUIPMENT

- Wide Visible Mast ● Load backrest (V and FSV masts) ● Easy-down system (8FG/D10J35 V mast) ● Alternator with IC regulator ● Intake heater (2Z, 14Z-II engine models) ● Super glow control system (1DZ-II engine models)
- Sedimenter (Diesel models) ● Same key for multiple forklifts ● 2-stator T/C (8FG/D35-80) ● Tilt cylinder boots ● Radiator screen(8FG/D35-80) ● Cyclone air cleaner with snorkel air intake
- Engine protection system (8FG35-50 Gasoline models) ● Electronic fuel injection system (8FG35-50 Gasoline models) ● Radiator reservoir tank ● Operator Presence Sensing System (OPS)
- Double-action parking brake (8FG/D10J35 Powershift models, 8FG/D35-80) / Foot-activated parking brake (8FG/D10J35 Manual transmission models) ● Assist grip ● Neutral safety switch
- Electrical shift control (Powershift models) ● Full hydraulic power steering ● Tilt steering column ● Overhead guard sheet ● Overhead guard ● Hidden tilt cylinder ● Engine hood damper (Lockable) ● Jack point
- Drawbar pin ● Engine hood insulation ● Headlights ● Headlights guard ● Rear combination lights (8FG/D35-80) ● Integrated light & turn signal switch ● Hour meter ● Engine water temperature indicator ● Fuel meter
- Engine oil pressure warning light ● Charge warning lights ● Pre-heat indicator light (Diesel engine models) ● Sediment warning light (Diesel engine models) ● Electric horn ● Cup holder ● ORS seat

MAIN OPTIONS

●:OPT ○:STD

ITEM	8FG/8FD10-J35		8FG/8FD35N-50N		8FD60N-80N	NECESSARY OPTION (Option must be chosen with)
	Gasoline	Diesel	Gasoline	Diesel	Diesel	
Environment						
Eco-mode (Deluxe Multifunction Display or Multifunction Display)	●	●	●	●	●	
Engine Auto Stop (Deluxe Multifunction Display)	●	●	●	●	●	
Catalytic Muffler	●	●	●	●	●	
3-way Catalytic Converter System	●	●	●	●	●	SAS(8FG10-J35)
Diesel Particulate Filter DPF-II	●	●	●	●	●	
LPG Fuel System	●	●	●	●	●	
Spark Guard Net	●	●	●	●	●	
Upswept Exhaust	●	●	●	●	●	
Safety & Stability						
System of Active Stability (SAS)	●	●	●	●	●	
Fan Guard	●	●	●	●	●	
Yellow Beacon On Overhead Guard	●	●	●	●	●	
Yellow Strobe Light On Overhead Guard	●	●	●	●	●	
Front Combination Lights	●	●	●	●	●	
Rear Combination Lights	●	●	○	○	○	
Back-up Buzzer	●	●	●	●	●	
Rear-view Mirrors (Right and left sides)	●	●	●	●	●	
Travel and Load-handling Control						
Maximum Speed Limitation	●	●	●	●	●	8FG/D10-J35: SAS, Catalytic Muffler (Gasoline models), Deluxe Multifunction Display
Low-speed Setting	●	●	●	●	●	8FG35-50: SAS (For Maximum Speed Limitation)
Lift-height and Load-sensing Vehicle Speed Control	●	●	●	●	●	(Deluxe) Multifunction Display
Lift-height and Load-sensing Sudden Start Off Prevention Feature	●	●	●	●	●	(For Low-speed Setting)
Automatic Idle-up Device	●	●	●	●	●	
Operability & Comfort						
Rear-pillar Assist Grip	●	●	●	●	●	
Swivel Seat	●	●	●	●	●	
Suspension Seat w/ Damper	●	●	●	●	●	
Mini Lever	●	●	●	●	●	
Joystick	●	●	●	●	●	SAS, (Deluxe) Multifunction Display, 3-Way Catalytic Converter System (8FG/D10-J35)
Steel Cabin	●	●	●	●	●	
Cabin w/ Folding Door	●	●	●	●	●	
Deluxe Cabin	● (Only 2-J35)	● (Only 2-J35)	●	●	●	
Front Windshield w/ Wiper and Washer	●	●	●	●	●	
Canvas Cabin w/ Wiper and Washer	●	●	●	●	●	
Heater	●	●	●	●	●	Heater, Cabin option
Defroster	●	●	●	●	●	
Floor Mat	●	●	●	●	●	
Mast Tilt Indication	●	●	●	●	●	
Document Box	●	●	●	●	●	
Fork Noise Reducer	●	●	●	●	●	
Fork Vibration Damper	●	●	●	●	●	
Oil Clutch (Manual Transmission)	●	●	●	●	●	
2-stator Torque-converter	● (Only 2-J35)	● (Only 2-J35)	○	○	○	
LSD (Limited-Slip Differential)	● (Only 2, 2.5T)	● (Only 2, 2.5T)	●	●	●	
Durability						
Torque-converter Interlock	●	●	●	●	●	SAS, (Deluxe) Multifunction Display
Fully Oil Charged Lift Cylinder	●	●	●	●	●	
Tilt Cylinder Hole Boots	●	●	●	●	●	
Power Steering Cylinder Boots	●	●	●	●	●	
Long Life Coolant 50%	●	●	●	●	●	
LED Head Lights / LED Rear Working Light	●*	●*	●	●	●	
Head Lights Guard (for Front Combination Lights)	●	●	●	●	●	Front Combination Lights
Anti-restart Ignition Key Switch	●	●	●	●	●	
Service & Management						
Multifunction Display	●	●	●	●	●	SAS
Deluxe Multifunction Display	●	●	●	●	●	SAS
OK Monitor	●	●	●	●	●	SAS(8FG/D10-J35)
Key off Head Lights off System	●	●	●	●	●	
Key-less Ignition Switch	●	●	●	●	●	
Fuel Tank Cap with Key	●	●	●	●	●	
Special Edition						
High-capacity Cooling Spec	●	●	●	●	●	Oil Clutch (8FG/D10-J35)
Cooling Fan Booster Kit	●	●	●	●	●	
Cold Area Package	●	● (Only 2Z)	●	●	●	
Low-noise Model	●	●	●	●	●	
Rust-proof Model	●	●	●	●	●	
Cyclone Air Cleaner (Dual Elements)	●	●	●	●	●	
Pre-Cleaner	●	●	●	●	●	
Plate Fin Type Radiator	●	●	●	●	●	
Radiator Screen	●	●	○	○	○	
Heavy Duty Mast	●	●	● (Only 3.5, 4t)	● (Only 3.5, 4t)	●	Vmast, 4or5 way valve
High-capacity Alternator	●	●	●	●	●	
High-capacity Battery	●	●	●	●	●	
Low Height Headguard (2200mm)	●	●	● (Only 4.5, 5t)	● (Only 4.5, 5t)	●	
Front Mud Guard	●	●	●	●	●	

*Bulb Rear Working Light is also available



8FG/8FD
1.0to 3.5ton

Features and equipment may vary depending on market.



8FG/8FD
3.5to 5.0ton

Features and equipment may vary depending on market.



8FD
6.0to 8.0ton

Features and equipment may vary depending on market.

MODEL VARIATION

1-J3.5 Ton Models



The model shown is 8FD25

3.5-5 Ton Models



The model shown is 8FD35

6-8 Ton Models



The model shown is 8FD70

MAIN SPECIFICATIONS

Model		8FG10 8FD10	8FG15 8FD15	8FG18 8FD18	8FGK20 8FDK20	8FG20 8FD20	8FGK25 8FDK25	8FG25 8FD25	8FGK30 8FDK30	8FG30 8FD30	8FGJ35 8FDJ35	
Engine Model	Gasoline	4Y	4Y	4Y	4Y	4Y	4Y	4Y	4Y	4Y	4Y	
	Diesel	1DZ-II	1DZ-II	1DZ-II	1DZ-II	1DZ-II,2Z	1DZ-II	1DZ-II,2Z	1DZ-II	1DZ-II,2Z	1DZ-II,2Z	
Load Capacity	kg	1,000	1,500	1,750	2,000	2,000	2,500	2,500	3,000	3,000	3,500	
Load Center	mm	500	500	500	500	500	500	500	500	500	500	
Overall Width	A	mm	1,045	1,070	1,070	1,155	1,150	1,155	1,150	1,255	1,240	1,290
Turning Radius (outside)	B	mm	1,910	1,990	2,010	2,040	2,200	2,090	2,280	2,130	2,430	2,490
Overhead Guard Height	C	mm	2,080	2,080	2,080	2,085	2,110	2,085	2,110	2,085	2,170	2,180
Length to Fork Face	D	mm	2,240	2,285	2,310	2,360	2,550	2,420	2,620	2,505	2,775	2,845

NOTE: For Transmission, please see Specification Sheet for the 8FG/8FD10-J35 series.

Model		8FG35N 8FD35N	8FG40N 8FD40N	8FG45N 8FD45N	8FG50N 8FD50N	8FD60N	8FD70N	8FD80N	
Engine Model	Gasoline	1FS	1FS	1FS	1FS	-	-	-	
	Diesel	14Z-II	14Z-II	14Z-II	14Z-II	14Z-II	14Z-II	14Z-II	
Load Capacity	kg	3,500	4,000	4,500	5,000	6,000	7,000	8,000	
Load Center	mm	600	600	600	600	600	600	600	
Overall Width	A	mm	1,350	1,350	1,450	1,450	1,965	1,965	
Turning Radius (outside)	B	mm	2,610	2,660	2,750	2,810	3,230	3,280	3,320
Overhead Guard Height	C	mm	2,210	2,210	2,300	2,300	2,310	2,310	2,310
Length to Fork Face	D	mm	2,925	2,980	3,110	3,170	3,490	3,545	3,590

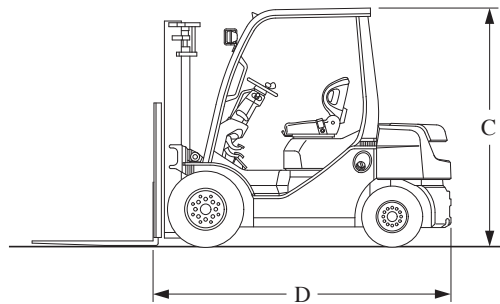
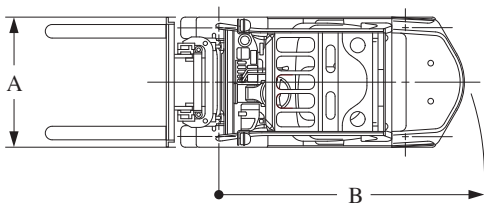

The model shown is 8FG25

The data in this brochure is determined based on our standard testing condition.
The performance may vary depending on the actual specification and condition of the vehicle as well as the condition of the operating area.
Availability and specifications depend on region and are subject to change without notice.
Due to photography and printing, color of actual vehicle may vary from this brochure. Some photos have been computer-enhanced.
Please consult your Toyota representative for details.

All rights reserved by Toyota Industries Corporation.