

Enphase AC Battery

(IQ7-B1200-LN-I-INT01-RV0)



Contact Information

Enphase Energy, Inc.
47281 Bayside Pkwy.
Fremont, CA 94538

enphase.com

enphase.com/en-us/support/global-contact

Environmental Protection

ELECTRONIC DEVICE: DO NOT THROW AWAY. Waste electrical products should not be disposed of with household waste. Proper disposal of batteries is required. Refer to your local codes for disposal requirements.



Other Information

For third-party license information, refer to enphase.com/licenses.

For Enphase patent information, refer to enphase.com/company/patents/.

Product information is subject to change without notice. All trademarks are recognised as the property of their respective owners.

For warranty text, refer to enphase.com/en-au/warranty.

User documentation is updated frequently; Check the Enphase website enphase.com/en-au/support/solar-professionals for the latest information.

Read the Enphase Enlighten terms of service at enphase.com/en-us/legal/terms-of-service.

Copyright © 2019 Enphase Energy Inc. All rights reserved.

Audience



This manual is intended for use only by qualified electricians.

Table of Contents

SAFETY	4
In Case of Fire or Other Emergency	4
Safety Instructions	4
The Enphase AC Battery	7
Planning	8
Preparation	8
Installing the AC Battery	10
1. Choose a Location for the AC Battery	10
2. Install the Wall-Mount Bracket	11
3. Install the AC Isolator (if required)	12
4. Wire the Junction Box	13
5. Mount the AC Battery on the Wall	14
6. Energise and Commission the System	15
Operation	16
Charging and Discharging	16
LED Overview	16
Troubleshooting	17
LED is Rapidly Flashing Yellow or Not Lit	17
Battery Information is Incorrect or Absent in Installer Toolkit or Enlighten	17
Check the Internet Connection	17
Run a Device Scan	17
Relocate the Envoy	17
Ensure that Meters are Properly Configured	18
Ensure that the Grid Profile and Rate Tariff are Set	18
Enable Charging From and Discharging To the Grid	18
Battery LED is Off or Flashing Red	18
Battery LED is Solid Yellow	18
System Alert: "AC Battery(ies) with Critical Temperature"	19
Removing or Replacing an AC Battery	20
Removing the AC Battery	20
Re-installing the AC Battery	21
Replacing the AC Battery	22
Technical Data	24

SAFETY

To ensure safe installation and operation of the AC Battery, note the following safety symbols that appear throughout this document to indicate dangerous conditions and important safety instructions.

	DANGER:	This indicates a hazardous situation, which if not avoided, will result in death or serious injury.
	WARNING:	This indicates a situation where failure to follow instructions may result in a safety hazard, or cause equipment malfunction. Use extreme caution and follow instructions carefully.
	NOTE:	This indicates information that is very important for optimal system operation. Follow instructions closely.

In Case of Fire or Other Emergency

In all cases:

- If safe to do so, switch off the AC breaker for the AC Battery circuit, and if an isolator switch is present, switch off the AC isolator for the AC Battery circuit.
- Contact the fire department or other required emergency response team.
- Evacuate the area.

In case of fire:

- When safe, use a fire extinguisher. Suitable types are A, B, and C dry chemical fire extinguishers. Additional extinguishing media include carbon dioxide, or alcohol-resistant foams.

In case of flooding:



- Stay out of water if any part of the AC Battery or wiring is submerged.
- If possible, protect the system by finding and stopping the source of the water, and pumping it away.
- If water has contacted the battery, call your installer to arrange a replacement. If not, let the area dry completely before use.



In case of unusual noise, smell or smoke:

- Ensure that nothing is in contact with the AC Battery or in the venting area on top of the AC Battery.
- Ventilate the room.
- Contact Enphase Customer Support at enphase.com/en-us/support/global-contact
- .

Safety Instructions

IMPORTANT SAFETY INSTRUCTIONS. SAVE THESE INSTRUCTIONS. This guide contains important instructions that you must follow during installation and maintenance of the Enphase AC Battery. Failing to follow any of these instructions may void the warranty (enphase.com/en-au/warranty). Follow all of the instructions in this manual. These instructions are key to the installation and maintenance of the Enphase AC Battery™. These instructions are not meant to be a complete explanation of how to design and install an energy storage system. All installations must comply with national and local electrical codes and standards.

	DANGER: Risk of electric shock. Risk of fire.	Do not attempt to repair the AC Battery; it contains no user-serviceable parts. Tampering with or opening the AC Battery will void the warranty. Warranty is void if enclosure is removed. If the AC Battery fails, contact Enphase Customer Support for assistance at enphase.com/en-au/support/contact .
		Only qualified electricians should install, troubleshoot, or replace the AC Battery.
	DANGER: Risk of fire or explosion.	Only qualified personnel, using personal protective equipment (PPE) should transport or handle the AC Battery.
		Do not dispose of AC Battery (ies) in a fire or by burning. The AC Battery(ies) can explode.

	DANGER: Risk of fire.	During use, or while transporting, keep the AC Battery in an area that is well ventilated and protected from the elements, where ambient temperature is between -20° C and 30° C, away from moisture and sources of heat, and/or flames. Do not install the AC Battery at elevations of over 2,000 m above sea level.
		If the AC Battery generates smoke, remove AC power from the Enphase System so that charging/discharging stops.
		Do not allow or place flammable, sparking, or explosive items near the AC Battery.
	DANGER: Risk of electric shock.	Do not use Enphase equipment in a manner not specified by the manufacturer. Doing so may cause death or injury to persons, or damage to equipment.
		Be aware that installing this equipment includes risk of electric shock. Do not install the AC Battery without first removing AC power from the photovoltaic system. Disconnect the power coming from the photovoltaics before installing.
		In areas where flooding is possible, install the AC Battery at a height that prevents water ingress.
		Always de-energise the AC branch circuit during an emergency. Never disconnect the DC connectors under load.
		A battery can also present risk of high short-circuit current. Observe the following precautions when working on batteries:
		<ul style="list-style-type: none"> • Remove watches, rings, or other metal objects. • Use tools with insulated handles. • Wear rubber gloves and boots. • Do not lay tools or metal parts on top of batteries.
		Do not work alone. Someone should be within hearing distance or close enough to come to your aid when you work with or near electrical equipment.
	WARNINGS: Risk of property or equipment damage	Do not use the CAN port on the AC Battery. It is intended to be used by Enphase technicians only.
		Install the AC Battery only on a structurally suitable wall using an Enphase wall-mount bracket.
		Before installing or using the AC Battery, read all instructions and cautionary markings in the technical description and on the equipment.
		Do not install or use the AC Battery if it has been damaged in any way.
		Do not exceed the maximum number (13) of AC batteries in a 20A AC branch circuit.
		Do not sit on, step on, place objects on, or insert objects into the AC Battery.
		The AC Battery is not waterproof. Do not place beverages or liquid containers on top of the AC Battery. Do not expose the AC Battery to liquids or flooding.
		Damage to the battery can occur from over-discharge. While in storage, the AC Battery will discharge. If the battery state of charge falls to 0%, the AC Battery can be damaged or destroyed. Because of this, the AC Battery must only be stored for a limited amount of time.
		<ul style="list-style-type: none"> • The battery must be installed and energised by the “Must Energize By” date on the shipping box label. • The battery must have a charge of no more than 30% when placed in storage. To do this, place the AC Battery in Sleep Mode. • If the AC Battery has already been installed, place the battery in Sleep Mode before uninstalling. An AC Battery in Sleep Mode can be stored for a maximum of two months from the date it was placed in Sleep Mode. • When storing the AC Battery, ensure that there is no AC power flow to the battery, and that the DC connector is unplugged.

**NOTES:**

Anti-islanding protection: The AC Battery monitors for sudden changes in the impedance of the grid by looking for changes in the second to the eighth harmonic. If significant changes are detected, then the internal microinverter is de-energized thus preventing islanding.

Perform installation and wiring in accordance with all applicable local electrical codes and standards.

Protection against lightning and resulting voltage surge must conform to local standards.

Using unauthorised attachments or accessories could result in damage or injury.

Use Class 1 wiring methods for field wiring connections to terminals of a Class 2 circuit. Use only 2.5mm² to 4mm² wire in the junction box terminal block. Select wire size based on the protection provided by the circuit breakers/fuses. Install properly rated over-current protection as part of the system installation.

To ensure optimal reliability and to meet warranty requirements, the AC Battery must be installed and/or stored according to the instructions in this guide.

The Enphase AC Battery is compatible only with the Enphase Envoy-S Metered communications gateway (SW version 4.10 or later) with properly installed production and consumption CTs. The Envoy-S Metered (SW version 4.10 or later) is required for operation of the AC Battery. Earlier versions of the Enphase Envoy communications gateway, and the Envoy-S Standard gateway are incompatible.

The Enphase AC Battery is intended to operate with an Internet connection. Failure to maintain an Internet connection may have an impact on the warranty. See enphase.com/en-au/warranty for full terms and services.

When replacing an Enphase AC Battery, you must replace it with an AC Battery of the same type, with the same AC current rating.

When stored, the AC Battery is not connected to the grid and no automatic charge of the battery is possible.

Properly mount the AC Battery or place it on a flat, plain surface that can bear heavy weights. Ensure that the mounting location is structurally suited to bearing the weight of the AC Battery.

During use, storage, and transport, keep the AC Battery:

- properly ventilated
 - away from water, other liquids, heat, sparks, and direct sunlight
 - away from excessive dust, corrosive and explosive gases, and oil smoke
 - away from direct exposure to gas exhaust, such as from motor vehicles
 - free of vibrations
 - away from falling or moving objects, including motor vehicles. If mounted in the direct path of a motor vehicle, we recommend a 91 cm minimum mounting height
 - at an elevation lower than 2,000 m above sea-level
 - in a location compliant with fire safety regulations (has a smoke detector)
 - in a location compliant with local building codes and standards
-

Conditions for the AC Battery installation site apply also to storage conditions.

The Enphase AC Battery

The **Enphase AC Battery™** is the heart of the Enphase Storage System. The AC Battery is simple to install, safe, very reliable, and provides a low lifetime energy cost for customers with both, new solar installations and retrofitted installations. You can install as many batteries as needed to meet the needs of the system owner.

The **Enphase Storage System** includes the Enphase AC Battery with integrated Enphase Microinverter™. The system uses the Enphase Envoy-S Metered™ to measure PV production and home energy consumption. The system is programmed to optimise charging or discharging the battery, so that energy is stored when it is abundant and used when scarce.

The **Enphase Envoy-S Metered** operates as a gateway between the storage system and Enphase Enlighten™ web-based monitoring and analysis software. The Envoy-S monitors and controls the AC Battery through the integrated Enphase Microinverter. It collects energy and performance data from all Enphase Microinverters at the site over on-site AC power lines, and forwards that data to Enlighten, via the Internet, for statistical reporting and system control. The Enphase Envoy-S Metered communications gateway with properly installed production and consumption CTs is required for operation of the AC Battery.

When used with non-Enphase PV systems, the Envoy-S can collect production and consumption data, but it does not control grid management functions of non-Enphase PV system components.

The **Enphase Enlighten™** web-based monitoring and analysis software analyses the data collected by the AC integrated microinverter in the AC Battery. Enlighten constantly monitors every Enphase Microinverter connected to the Envoy-S and is essential for system monitoring and troubleshooting. Enlighten provides a wide range of information on system performance. You can access Enlighten on your computer or mobile device at any time.

The **Enphase Microinverter** converts the DC output of the PV module into grid-compliant AC power. In addition to performing the DC to AC conversion, it maximises energy production by using a sophisticated Maximum Power Point Tracking (MPPT) algorithm.

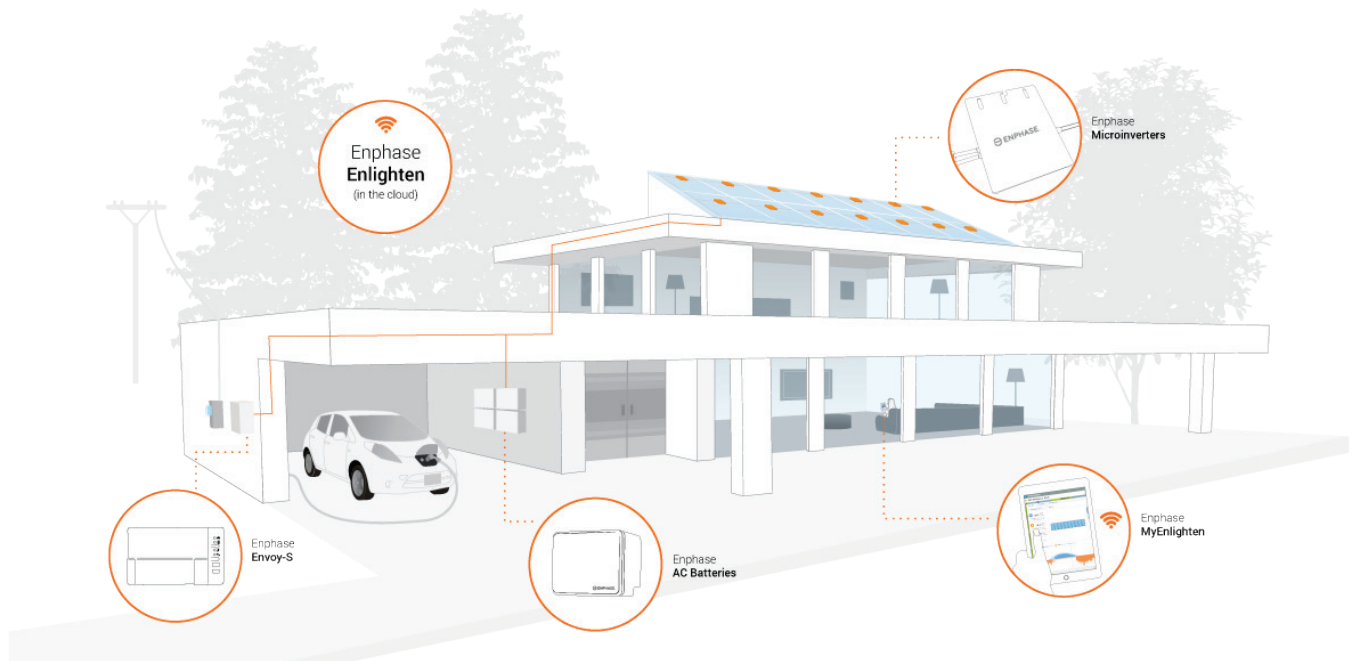

Planning

The Enphase AC Battery is controlled by the Enphase Envoy-S Metered gateway. The AC Battery cannot function without receiving commands from the Envoy-S. It is, therefore, critical that the Envoy-S and AC Battery(ies) are located as close as possible to each other. The Envoy should be located within 20m (electrically) from the AC Battery(ies).

However, this may not always be practical since the Envoy-S Metered also needs to be connected to the production and consumption CTs that are installed around the main service and solar production circuits. In this case, you may need to extend the CTs and reroute the solar circuit closer to the AC Battery(ies). One solution is to install the AC Battery, the solar production circuits, and the Envoy-S on a common panel board.

Preparation

a. Ensure that you have both of the following:

- One or more Enphase AC Battery(ies) (Model IQ7-B1200-LN-I-INT01-RV0): the AC Battery shipping box contains an Enphase AC Battery and an access panel cover.



NOTE: Check the “Must Energize By” label on the shipping box to ensure that the AC Battery is installed by the date shown.

- One Enphase Wall-Mount Bracket for each battery. The wall-mount bracket shipping box includes only the bracket. Brackets are available in two widths to accommodate 450mm and 600mm stud-spacing.

b. Ensure that you have the following **required** items:

- Enphase Envoy-S Metered (4.10 or later) communications gateway with production CT(s) and consumption CT(s) installed and configured as described in the Enphase Envoy-S Metered Quick Install Guide. When used with Enphase devices, the Envoy-S can control grid management functions and monitor PV production and site consumption. When used with non-Enphase PV systems, it can collect production and consumption data, but it does not control grid management functions of non-Enphase PV system components.



NOTE: The Enphase AC Battery requires an Internet connection (through the Envoy-S). Maintaining this connection is important, for updating software and firmware, and for measuring the health of the battery. Failure to maintain an Internet connection may have an impact on the warranty. See enphase.com/en-au/warranty for full terms and services.

- Mounting location that is structurally suited to bearing the weight of the AC Battery. The wall must have appropriately spaced studs (450 mm or 600 mm) or can be of masonry or other suitable structure.



NOTE: If the wall is not structured in a way that allows wall mount brackets to be attached directly to the studs, a substructure is required, such as **1**) metal strut, 6 mm (¼ inch) spring nuts, and 6 mm (¼ inch) bolts or **2**) horizontally mounted wood studs or strong plywood.

- Tools and accessories:
 - Conduit fitting tools, drill, 4mm pilot bit, screwdriver, socket, adjustable spanner, torque wrench, level, 4mm Allen key, and wire stripper.
 - Four 6mm diameter lag bolts/screws, 25 to 50mm long depending on attachment wall, for each wall-mount bracket. Check with a structural engineer and local standards for requirements specific to your site.
 - Washers for use between fastener heads and wall-mount bracket.

-
- Copper conductors for push terminals: 2.5mm² to 4mm² (11mm strip length) rated at 75° C or 90° C.
 - Gland or strain relief fitting: one for each used conduit opening in the AC junction box.
 - OCPD: 20A maximum over current protection and readily accessible disconnecting means in accordance with local standards.
 - Personal protective equipment (PPE) for handling lithium ion batteries as required by local safety standards.
- c.** Ensure that you have the following **optional** items, if needed:
- 20A maximum AC isolator
 - Conduit and fittings
 - Stud finder
- d.** Install the PV system and the Envoy-S as directed by the installation manuals.
- e.** To record the location(s) of the AC Battery(ies), peel the removable serial number label from each battery and affix it to the respective location on a paper installation map. You will scan this map later using the Enphase Installer Toolkit™ and your mobile device.

Installing the AC Battery

Steps one through four describe how to install the wall-mount bracket and junction box wiring, while steps five and six describe mounting the battery and energising the system.

1. Choose a Location for the AC Battery

The AC Battery housing is an IP-20 rated metallic enclosure. The terminal blocks on the wall-mount bracket accept a maximum conductor size of 4mm².

- a. **Following local standards**, choose a wall in a well-ventilated, indoor location (like a garage) that is shielded from direct sunlight, away from moisture, and where the ambient temperature and humidity are within -20° C to 45° C and 5% to 95% RH, non-condensing.



NOTE: If the AC Battery heats up, it responds by reducing operation to correct the internal temperature of the battery.

- b. Ensure that the mounting location can sustain the weight of the AC Battery and wall-mount bracket (*25 kg or 55 lbs per battery*).
- c. Plan the mounting location to be at least 300 mm (one foot) off the ground and 300 mm (one foot) from the ceiling. Keep the battery(ies) away from falling or moving objects, including motor vehicles.



WARNING: If mounted in the direct path of a motor vehicle, we recommend a 36-inch minimum (91 cm) mounting height.

- d. Ensure that there are no pipes or electrical wires where you plan to drill.
- e. Plan to maintain at least 300 mm (one foot) of clearance in front of each battery.
- f. Consider the dimensions of the AC Battery, easy access, height, and length of cable when selecting the location.
- g. Do not block the vents or allow liquids to contact the AC Battery. The AC Battery is not waterproof.
- h. Select a location where you can interconnect with the site's switchboard (load centre) using an appropriate branch circuit.
- i. **Following local standards**, decide whether to connect using external conduit or by wiring inside the walls. This determines which knockouts to use in the junction box. Check if an AC isolator is needed. Plan the location for the AC isolation switch, if needed.
- j. If you are installing more than one AC Battery, continue to maintain minimum required clearances as shown in Step 2.

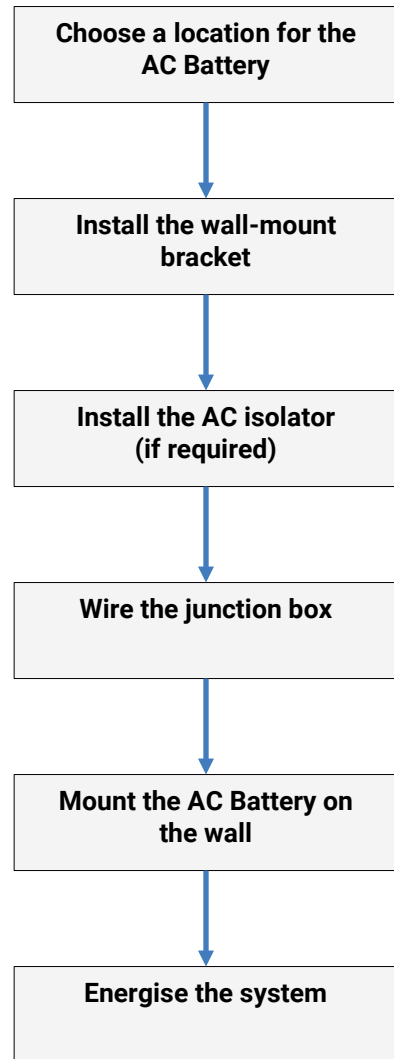

2. Install the Wall-Mount Bracket

- a. Make sure that the wall-mount bracket matches the wall stud spacing and that the lowest wall-mount bracket position meets clearance requirements as shown.



WARNING! Risk of injury and equipment damage. Protect the AC Battery from damage and improper use.

- b. Remove the appropriate knockout(s) for the planned entry into the wall-mount bracket junction box:
- If wiring inside the walls, use the knockout(s) at the back of each junction box. If using a conduit, use the knockouts at the bottom of the junction box.
 - If installing only one battery or if installing the last battery in an array, use only one knockout.
 - Loosen the screw securing the junction box cover and remove the cover. Keep the cover handy as you will need it later.

- c. Starting at battery position closest to the power source, mark a level line on the wall as a guide.



WARNING! Multiple risks. Make sure not to drill or attach into electric wiring or pipes that are in the wall!

- d. Place the wall-mount bracket on the wall so that the mark on the bracket aligns with the centre of the stud. Use a level to keep the top of the wall-mount bracket flat, and attach each corner of the wall-mount bracket using one screw and washer for each slot.

- e. Verify that the wall-mount bracket is solidly attached to the wall.



WARNING! Risk of injury and equipment damage. Do not mount an AC Battery on a bracket that is not properly mounted.

- f. If installing additional batteries, install the adjacent wall-mount brackets in an interleaved fashion, as needed. Be sure to align the mark on the adjacent wall-mount bracket to the centre of the wall stud. A small gap in between the adjacent wall-mount brackets is normal. You may install another row of wall-mount brackets above the one already installed. Maintain at least 300 mm (one foot) clearance between rows.

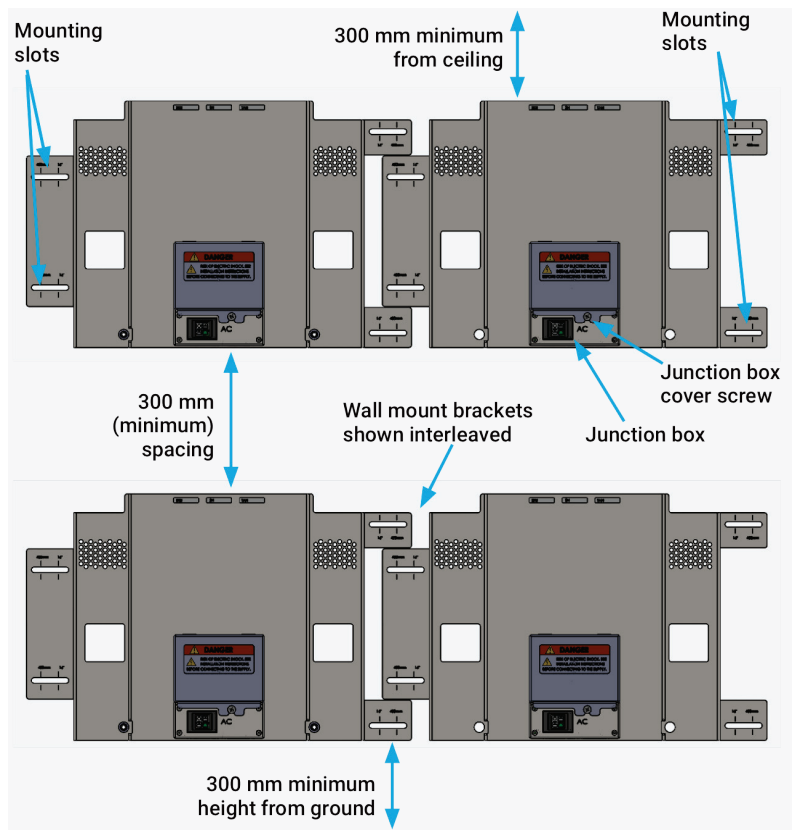

Brackets are available in two widths to accommodate 450mm and 600mm stud-spacing. Bracket types and dimensions are shown.

BWM-450MM-A allows 450 mm battery-to-battery spacing:

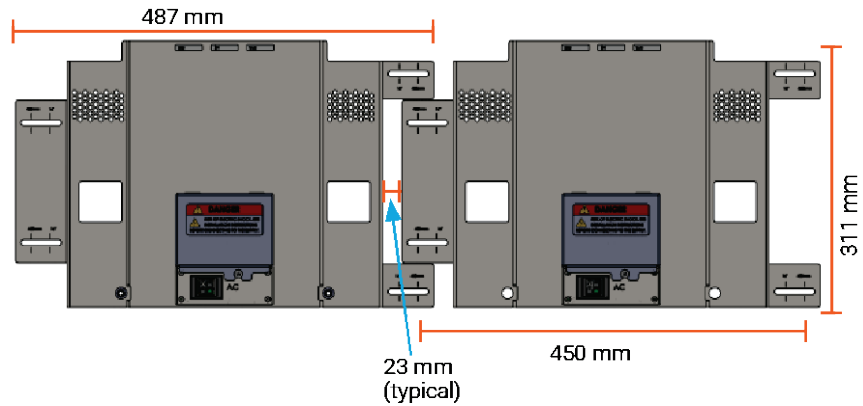

BWM-600MM-A allows 600 mm battery-to-battery spacing:

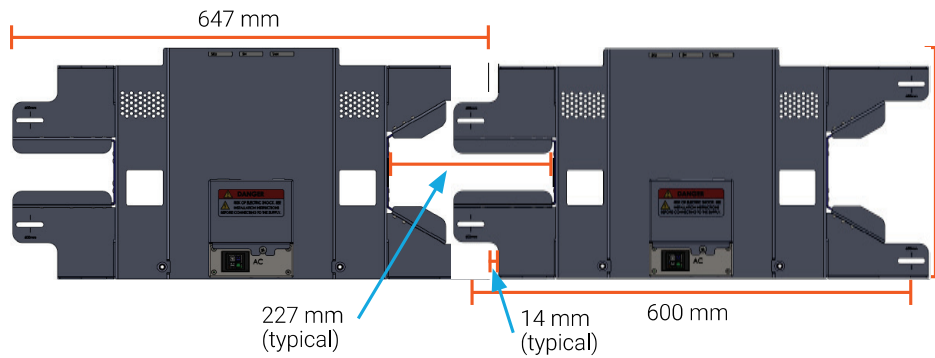

3. Install the AC Isolator (if required)

Following all local codes and standards:

- Choose an AC Isolator that can break the maximum rated current of the branch circuit under load (20 A maximum).
- Connect one side of the isolator to the switchboard (load centre):
- Verify that AC voltage at the site is within range. Single-phase L1 (Active) to N must measure between 200 and 270 VAC).



WARNING! Risk of equipment failure. Size the conductor gauge to account for voltage rise for both the branch circuit and all upstream conductors leading back to the PCC (point of common coupling). Refer to the technical brief on voltage rise at enphase.com/support.

4. Wire the Junction Box



DANGER! Risk of electric shock. Check that the dedicated circuit breaker protecting the branch where the AC Battery is to be connected is turned off before wiring.



WARNING! Risk of equipment damage. Never connect an Enphase AC Battery junction box to two active conductors. Always connect to one Line (active) and one Neutral.

Junction box colour code	Colour code (AU)
Brown – L1 (Active)	Red – L1 (Active)
Blue – Neutral	Black – Neutral
Green/Yellow – Ground/PE	Green – Ground/PE

- Size the conductors (Line, Neutral and Earth) depending on the upstream breaker or fuse. Use 2.5mm² to 4mm² wire with maximum 20A branch circuit protection.
- Using the conductors and suitable conduits, connect the AC isolator (if used) and the first adjacent AC Battery junction box. Use the openings provided by the knockouts to connect the conduits and pass the wires through them.



NOTE: Do not modify or rewire the pre-installed wiring or bonding connections in the junction box.

- Connect each wire in the junction box to its corresponding conductor (Line, Neutral and Earth). Each push terminal accepts two 2.5mm² to 4mm² conductors (11mm strip length). **For each, use a screw driver to depress and open the terminal, then insert the stripped conductor.**
- After all wires in the junction box are connected and secured, check that there are no exposed conductors.
- If connecting additional AC batteries, use another conduit and set of wires to connect out of the junction box to the next junction box.
- Gently arrange all the wires and connectors inside the junction box and replace the cover. Tighten the cover screw using a Phillips screw driver.

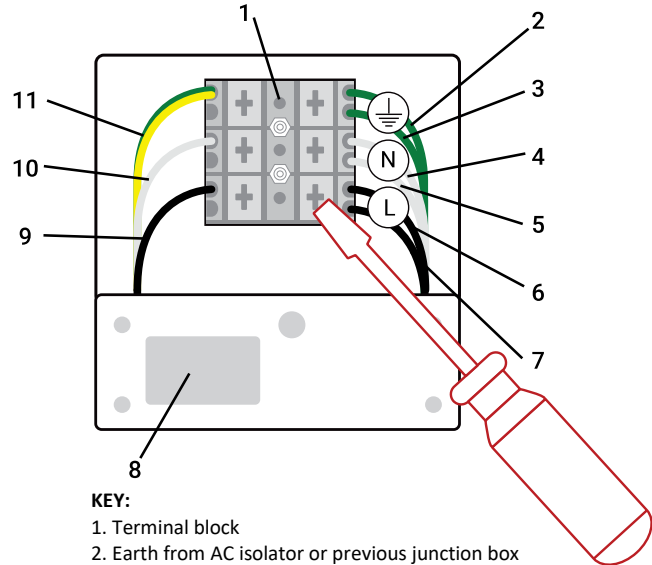

KEY:

- Terminal block
- Earth from AC isolator or previous junction box
- Earth to next junction box, if needed
- Neutral from previous junction box
- Neutral to next junction box, if needed
- Line from previous junction box
- Line to next junction box, if needed
- Junction box AC connector
- Line from this junction box, to connector
- Neutral from this junction box to connector
- Earth from this junction box, to chassis screw



DANGER! Risk of electric shock. The system is not ready to be energised! Do not close the circuit breaker yet.

5. Mount the AC Battery on the Wall



WARNING: Risk of injury and equipment damage. You must mount the AC Battery on a suitable wall.



WARNING: Risk of injury and equipment damage. Avoid dropping the AC Battery. Doing so may create a hazard, cause serious injury, and/or damage the equipment.



WARNING: Before mounting the Enphase AC Battery, ensure that the junction box cover is secured!



WARNING: Take care when lifting the AC Battery. The AC Battery is heavy and may require two persons to lift.

- a. Using both hands, lift the AC Battery from the packaging and place it right side up on a flat surface. Be sure that the AC connector is not pinched underneath.
- b. Begin by installing the AC Battery located closest to the main supply. Using the two grip insets on the side of the AC Battery, lift and carry the AC Battery to the installed wall-mount bracket.
- c. While fitting the AC Battery onto the wall-mount bracket, ensure that the four tabs on the AC Battery are inserted into their corresponding openings in the wall-mount bracket. After the tabs are inserted, begin lowering the AC Battery slowly to ensure that the tabs have latched onto the wall-mount bracket.

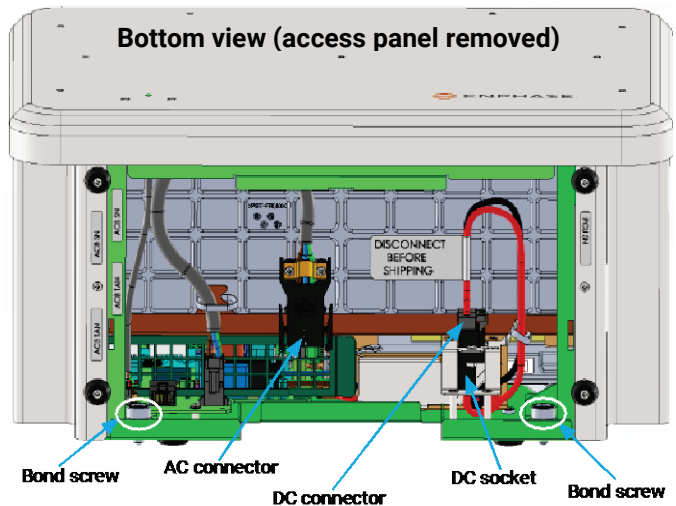

WARNING: Risk of injury and equipment damage. Do not release the AC Battery until you ensure that all four tabs have safely latched onto the wall-mount bracket.



WARNING: Risk of equipment damage. When placing the AC Battery on the wall-mount bracket, ensure that the junction box does not pinch the DC connector, the AC connector, or its cable.

- d. Use a Phillips #2 screwdriver to secure the two bond screws into the wall-mount bracket. The bond screws are accessible from the bottom access compartment. The bond screws provide an earthing (grounding) bond between the AC Battery and the wall-mount bracket.



WARNING: Always secure the bond screws to ensure earthing (grounding) bond and that the AC Battery is firmly attached to the wall-mount bracket.

- e. Plug the DC connector into DC socket. Listen for a click as the connectors engage.



WARNING: Risk of equipment damage. Do not connect the AC connector until the DC connector is completely engaged.



NOTE: This action connects the internal battery to the internal electronics; you **must** disconnect it if you move or transport the AC Battery.



NOTE: Check to ensure that the wall-mount bracket junction box is fully inside the access compartment of the AC Battery. The AC Battery **must not** rest on the junction box or rely on it for support.

- f. Connect the battery AC connector into the AC connector on the junction box. Listen for a clicking sound as the connectors engage.
- g. Attach the bottom access plate and secure the two compression half-turn latches using a 4mm Allen key.

6. Energise and Commission the System



WARNING: Before energizing the system, check to ensure that ALL of the AC batteries in the system are properly installed and conductors terminated.

- a. Check to ensure that the AC Battery bottom access plates on all AC batteries in the system are closed and secured.
- b. Switch on the circuit feeding the AC Battery(ies).
- c. The AC Battery LED should flash yellow for the duration of the start-up process. If the LED does not flash yellow, see the corresponding section under Troubleshooting.
- d. Use the Enphase Installer Toolkit to commission the AC Battery(ies). Once connected to the Envoy, refer to the Installer Toolkit help topics for more information.
- e. After the Envoy-S has detected the AC Battery(ies), the AC Battery LEDs operate as described in the following section.

Operation

The following sections describe AC Battery operations.

Charging and Discharging

Envoy-S controls the charging and discharging of the AC Battery as follows:

Charging: The AC Battery typically charges during daylight hours when the solar production exceeds home consumption. The AC Battery can also be programmed to charge from the electric grid at any time by enabling Force Charge.

Discharging: The AC battery discharges power only to service local loads by default. It can discharge power through the utility meter onto the electric grid by enabling 'Allow discharging to grid' and configuring the time of use. The AC Battery discharges for use by the home when **all** of the following occur:

- The consumption exceeds production
- The time of day is after **peak start time**, if **time of use** is configured
- The batteries are not fully discharged. If the batteries are fully discharged, then they must recharge before they can discharge again.

LED Overview

The LED flashes yellow while the AC Battery boots up. If the LED rapidly flashes green for more than two minutes, the battery is in trickle charge mode and will remain so until it reaches a minimum state of charge (up to 30 minutes). After the AC Battery boots up, the LED glows blue or green depending on the charge level. If the LED flashes yellow after one hour or changes to flashing red, contact Enphase Customer Support enphase.com/en-us/support/global-contact

Other LED states include:

State	Description
Rapidly flashing yellow	Starting up / Establishing communications
Red flashes in sequences of two	Error. See "Troubleshooting".
Solid yellow	Not operating due to high temperature. See "Troubleshooting".
Solid blue or green	Idle. Color transitions from blue to green as state of charge increases. You can check Enlighten for charge status.
Slowly flashing blue	Discharging
Slowly flashing green	Charging
Slowly flashing yellow	Sleep mode activated
Off	Not operating. See "Troubleshooting".

Troubleshooting

The following sections describe possible problems and solutions.

During installation, use the Enphase Installer Toolkit mobile app to verify AC Battery operation. The Installer Toolkit, when used with Envoy-S provides information about the AC Battery status, PV production, and home energy consumption.

LED is Rapidly Flashing Yellow or Not Lit

If, after starting up, the AC Battery LED rapidly flashes yellow or is not lit, check that the proper voltage (230V line-to-neutral) is provided to the AC Battery. To do this:

- Remove the access cover on the bottom of the battery.
- Check whether both the AC and DC connectors are fully seated in the receptacles.
- Unplug the AC connector and test the voltage and frequency at the terminals of the junction box. You should detect approximately 230V/50Hz between the blue and white terminals and approximately 230V between the blue and green terminals.

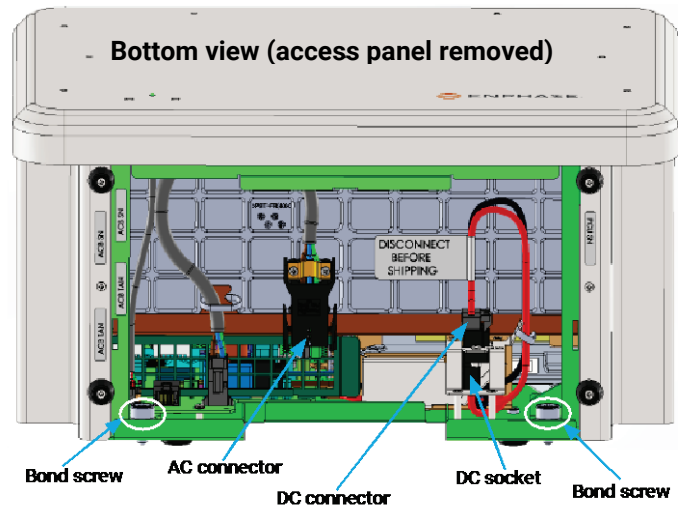

Battery Information is Incorrect or Absent in Installer Toolkit or Enlighten

The Envoy-S manages the charging and discharging of the AC Battery. Ensure that the Envoy-S current transformers (CTs) are correctly installed and that production and consumption metering are configured correctly in Installer Toolkit. Once this is done, you can use Installer Toolkit to check that the Envoy-S has detected the connected devices and that they are communicating.

Check the Internet Connection

If you do not see AC Battery information in Enlighten, check whether the Envoy-S and the Internet connection are working.

Run a Device Scan

If needed, you can also provision devices either by scanning the AC Battery(ies) bar code(s) or by performing a device scan. If the AC Battery(ies) cannot be detected by the device scan or if the AC Battery(ies) are not communicating, you need to relocate the Envoy-S to be closer to the AC Battery(ies). This is because the Envoy-S communicates with the AC Battery using power line communications. The Envoy-S and AC Battery(ies) must be installed on the same phase.

Relocate the Envoy

When possible, locate the Envoy-S within 20 meters or 65 feet (electrically) from the AC batteries. This may not always be practical since the Envoy-S must also be connected to the production and consumption CTs that are installed around the main service and solar production circuits. If so, you can extend the CT leads as described in the *Envoy-S Installation and Operation Manual*. In addition, the solar circuit may need to be

rerouted to a location closer to the AC batteries. One solution is to install the AC Battery, the solar production circuits and the Envoy-S Metered off a common panel board.

Ensure that Meters are Properly Configured

If the consumption and production metering are not configured and operating properly, the AC Battery will not operate or will operate improperly. The Envoy-S Metered uses the consumption and production meter readings to determine if the AC Battery should be charging or discharging. Confirm in Installer Toolkit that the consumption and production metering are both **Enabled**. A check next to both production and consumption metering verifies that the metering is enabled. Additional checks include:

- a. To check that the consumption meter is installed correctly, shut off both the solar production and AC Battery circuits. The consumption meter reading should closely match the utility meter's reported power reading.
- b. If the consumption meter is installed and operating correctly, turn on the solar production circuits, but leave the AC Battery circuit(s) off. The solar production reading should be positive.
- c. Turn on the AC Battery circuit(s). Note that the consumption readings are impacted by the battery operation. AC Battery charging increases the consumption reading. Since a portion of the PV production is used to charge the batteries, the home's consumption will appear to increase during charging. When the batteries are discharging, the consumption metering reports the load consumption lower than actual.

If any of these checks show incorrect results, check the Envoy-S and CT wiring against the appropriate wiring diagram in the *Envoy-S Installation and Operation Manual*

Ensure that the Grid Profile and Rate Tariff are Set

Check that the **Grid Profile** has been set in Installer Toolkit. If needed, set the **Peak Start Time** and the **Time of Use** rate tariff in Installer Toolkit to control the time of day that the batteries begin to discharge to feed loads.

Enable Charging From and Discharging To the Grid

In the Installer Toolkit:

Enable **Allow discharging to grid**, for batteries to feed power to the grid

Enable **Allow charging from grid**, for batteries to be charged from the grid

Enable **force charge**, and set the time, to charge the batteries irrespective of other priorities.

Battery LED is Off or Flashing Red

If the AC Battery is not working correctly, perform the following steps. If the issue persists, contact Enphase Customer Support at enphase.com/en-us/support/global-contact.

- If the AC Battery LED is off or flashing red, turn off the breaker for the branch circuit, wait for at least one minute, and turn it back on.



NOTE: During a brownout or blackout, the AC Battery powers down automatically. This is normal. When power is restored, it automatically starts up again.

Battery LED is Solid Yellow

- Check the temperature in the room and increase cooling and/or ventilation as required to meet temperature requirements. The Battery requires an ambient temperature between -20° C and 45° C, and where relative humidity is between 5 and 95 percent.

-
- Check that the front, top, and sides of the AC Battery array have at least 300 mm of unobstructed clearance.



NOTE: If the AC Battery registers a high temperature event, it responds by reducing operation to correct internal temperature.

System Alert: “AC Battery(ies) with Critical Temperature”

- Check the temperature in the room and increase cooling and/or ventilation as required to meet temperature requirements. The AC Battery requires an ambient temperature between -20° C and 45° C, and where relative humidity is between 5 and 95 percent.
- Check that the front, top, and sides of the AC Battery array have at least 300 mm of unobstructed clearance.



NOTE: If the AC Battery registers a high temperature event, it responds by reducing operation to correct internal temperature.

Removing or Replacing an AC Battery

If problems remain after following the troubleshooting steps above, contact Enphase at enphase.com/en-us/support/global-contact



DANGER! Risk of electrocution! Do not disconnect the consumption CT leads from the terminal block while the sensed circuit is energised.



DANGER! Risk of electric shock. Risk of fire. Do not attempt to repair the Enphase AC Battery; it contains no user-serviceable parts. Tampering with or opening the Enphase AC Battery will void the warranty. If the AC Battery fails, contact Enphase Customer Support for assistance at enphase.com/en-us/support/global-contact

- Warranty void if the Enphase AC Battery housing is removed.



DANGER! Risk of electric shock. Always de-energise the switchboard before beginning wiring.



WARNING! The AC Battery must have a charge state of no more than 30% when placed in storage. After the AC Battery has been installed, you can store it subsequently for a maximum of two months. When placing the AC Battery in storage, ensure that the DC connector is unplugged from the DC socket.

Removing the AC Battery

In the event that one or more AC batteries needs to be temporarily uninstalled, or if Enphase Customer Support authorises an AC Battery replacement (RMA), perform the following steps.

1. Before you uninstall an AC Battery, you must place the battery in Sleep Mode to ensure that the charge is neither too high nor too low for storage or transport. Once Sleep Mode is initiated, the AC Battery will continue to operate until it reaches the desired charge. Since the rate at which the AC Battery can charge or discharge is governed by the loads connected at the point of coupling, it can take several hours to get to the desired charge. Therefore, Enphase recommends that you initiate Sleep Mode 24-48 hours in advance of the physical removal of the AC Battery. This is to ensure that sufficient time has elapsed to allow the AC Battery to enter Sleep Mode. You can initiate Sleep Mode in one of three ways:
 - Remotely (Recommended). Using Enlighten Manager, you can remotely initiate Sleep Mode on one or more AC batteries by selecting this option under the **Devices** tab.
 - At the site. Using the Installer Toolkit App, you can connect to Envoy and initiate Sleep Mode on one or more AC batteries using the **Storage** button on the App.
 - Enphase Support. Contact Enphase Support at enphase.com/en-us/support/global-contact for assistance to initiate Sleep Mode for one or more AC batteries.

Once the desired charge is reached for the AC Battery(ies) operating in Sleep Mode, the AC Battery is idle and you will be alerted that the battery is in Sleep Mode.

2. Once you have confirmed that the AC Battery is in Sleep Mode, switch off power to the AC Battery at the main switchboard. Verify that all sources of AC power are disconnected from the system before attempting to remove the AC Battery.
3. Remove the bottom access plate on the AC Battery using a 4mm Allen key.
4. Disconnect the AC connector from the wall-mount bracket junction box.



WARNING: Risk of equipment damage. Always disconnect the AC connector before disconnecting the DC connector.

5. Disconnect the DC connector from the DC socket.
6. Using a Phillips #2 screwdriver, loosen the two bond screws on the AC Battery.



WARNING: Carefully lift the AC Battery. The AC Battery is heavy and may require two persons to lift.

7. Using both hands on the grip insets, slowly lift the AC Battery up and away from the wall-mount bracket. Ensure that no loose wires are caught in the process.
8. In a temperature controlled indoor location, gently rest the AC Battery in upright position on a stable and flat surface, ensuring that the cables are not pinched under the AC Battery.
9. Inspect all wiring and terminal connections in the junction box of the wall-mount bracket. Ensure that the junction box cover on the wall-mount bracket is securely fastened.
10. If additional AC batteries are installed, re-energise the system at the main switchboard.
11. If an Enphase Customer Support has authorised an AC Battery replacement (RMA), follow the instructions provided by Enphase Customer Support for arranging the collection and transportation of the AC Battery.

Re-installing the AC Battery

If you have temporarily removed one or more AC batteries and placed them in Sleep Mode, perform the following steps to place each AC Battery back into service:

1. Follow the steps in “5. Mount the AC Battery on the Wall” starting on page 14.
2. After re-installing the AC Battery(ies), you will need to disable Sleep Mode to place the unit(s) back into service. You can disable Sleep Mode in one of three ways:
 - At the site (Recommended). Using the Installer Toolkit App, you can connect to the Envoy on-site and disable Sleep Mode for one or more AC batteries using the **Storage** button on the App.
 - Remotely. Using Enlighten Manager, you can remotely command one or more AC batteries to disable Sleep Mode by selecting this option under the **Devices** tab.
 - Enphase Support. Contact Enphase Support at enphase.com/en-us/support/global-contact for assistance in disabling Sleep Mode for one or more AC batteries.

Replacing the AC Battery



NOTE: When replacing an Enphase AC Battery, you must replace it with an AC Battery of the same type, with the same AC current rating.

Follow the steps in “5. Mount the AC Battery on the Wall” starting on page 14. After installing the new AC Battery, do the following:

1. Verify operation of the replacement AC Battery by checking the LED.
2. Use the Installer Toolkit mobile app to delete the old AC Battery serial number from the Envoy-S database. In Installer Toolkit, once connected to the Envoy:

a. Tap **Storage** at the bottom of the screen.



b. Tap **Manage**.

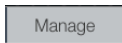

c. Tap the checkbox to the right of the device serial number that you replaced.



d. Tap  to delete the device from the Envoy-S database.

3. Add the new AC Battery serial number to the Envoy database by initiating a device scan using one of the following methods:

Method 1: Initiate a scan using the Installer Toolkit mobile app

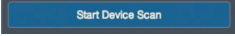
- In Installer Toolkit, once connected to the Envoy, navigate to the Overview screen.
- From the Overview screen under **AC batteries**, tap **Detected > Start Device Scan** to start a new 30-minute device scan. 
- If device scanning on the Envoy is inhibited, the app displays **Scan Inhibited**. If you need to add more devices to the system when device scanning is inhibited on the Envoy, you must use the Installer Toolkit scanning tool to provision them on the Envoy, rather than using the Envoy’s device scanning function to discover them. If this is not possible and you need to enable device scanning on the Envoy, contact Enphase Customer Support at enphase.com/en-us/support/global-contact.

a. Method 2: Use an Envoy-S

- In **Envoy-S**, press the **Device Scan** button on the Envoy-S. The Envoy-S begins a 15-minute scan to identify all of the devices deployed at the site. The Device Communications LED ↔ flashes green during the scan.

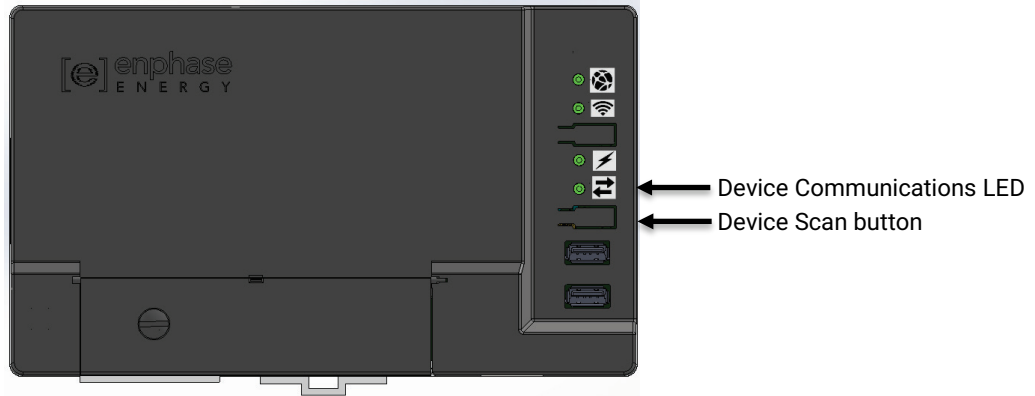

4. Log in to Enlighten to use Enlighten's Array Builder to add the newly detected device to the virtual array.

Technical Data

Model Number	
Enphase AC Battery	IQ7-1200-LN-I-INT01-RV0
Accessories	
Enphase wall-mount bracket	Order separately: BWM-450MM-A: 450 mm (W) x 311 mm (H) BWM-600MM-A: 647 mm (W) x 311 mm (H)
Input / Output Data	
Peak input / output power	270 VA
Rated (continuous) output power	260 VA
Extended line to neutral voltage range	184 to 276 VAC
Nominal frequency	50 Hz
Extended frequency range	45 to 55 Hz
Power factor (adjustable)	1.0 / 0.7 leading to 0.7 lagging
Maximum units per 20 A branch circuit	13
Peak inverter efficiency	96.9%
Battery Chemistry	
Capacity	1.2 kWh
Depth of discharge (usable capacity)	100%
Ambient temperature range	-20°C to 45°C
Chemistry	Lithium Iron Phosphate (LFP)
Cell safety certifications	TUV Rheinland
Roundtrip cell efficiency ¹	96%
Mechanical Data	
Dimensions	390 mm (W) x 325 mm (H) x 220 mm (D) (without bracket)
Weight	23 kg
Installation	Wall-mounted in an indoor space using standard AC wiring in conduit or in wall, where allowed.
Enclosure	Indoor – IP20
Cooling	Natural convection: No active or passive cooling infrastructure required
Grid configuration	TN-C-S
Features and Compliance	
Compatibility	Compatible with grid-tied PV systems using the Enphase Envoy-S™ Metered gateway.
Communication	Power Line Communication (PLC), TCP/IP through Envoy-S ² .
Services	Maximising self-consumption of solar, time-of-use bill management, power export limiting ³
Monitoring	Enlighten Manager and MyEnlighten monitoring options
Compliance	AS/NZS 4777.2:2015 AS/NZS CISPR 22, IEC/BS EN/AS 62040-1, UN38.3, CEC Australia Battery Assurance Program

¹ At 30°C

² With software version 4.10

³ Optional. Requires Enphase S/IQ-Series Microinverters to implement.