

Ergo Tools Pricing and Specification Guide

Price Guide - Canada Prices effective January 2009



keyboard systems

lighting

laptop holders

cpu holders

document holders

foot rests

glare filters

input devices

Table of Contents

Best-Selling Keyboard Systems	3
Build Your Keyboard System Product Code	4
Mechanism Options	5
Keyboard Platform Options	6
Mouse Platform Options	8
Palm Support Options	9
Track Options	9
Keyboard System Accessories	10
Ergonomic Accessories	11
Build Your Diffrient Light Product Code	14
Humanscale and the Environment	16
Terms & Conditions	18

Other Humanscale price guides available:

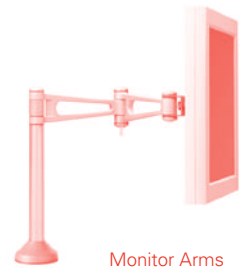

For the most updated information on available Humanscale products, please visit www.humanscale.com



Best-Selling Keyboard Systems

With advanced technology, award-winning designs and hundreds of options, Humanscale has remained the market leader in keyboard supports for nine years running. We pioneered intuitive adjustability and eliminated knee obstruction. And these best-sellers remain several steps ahead of the pack.

All keyboard systems are available to ship within 72 hours.

Platinum 5G System

- Contemporary Platinum color scheme
- Standard 5G or 5G Short Mechanism
- 900 or 950 Platform
- High Clip Mouse* (8.5" or 10" Mousing Surface)
- 8.5" or 10" Gel Mouse Pad
- Synthetic Leather Gel Palm Support

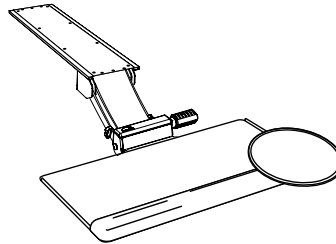

Std 5G/8.5"	5GV 900 90H G	\$629
	5GV 950 90H G	\$629
Std 5G/10"	5GV 900 91H G	\$629
	5GV 950 91H G	\$629
Short 5G/8.5"	5GSV 900 90H G	\$629
	5GSV 950 90H G	\$629
Short 5G/10"	5GSV 900 91H G	\$629
	5GSV 950 91H G	\$629

Clip Mouse System

- 2G or 5G Mechanism
- Standard 900 Platform
- High Clip Mouse (8.5" or 10" Mousing Surface)
- Synthetic Leather Palm Support (Gel or Foam)

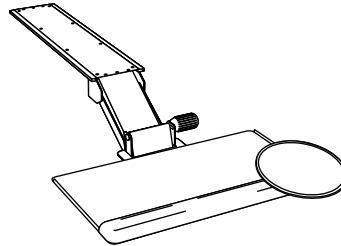

Shown with 2G mechanism

8.5"/Gel	2G 900 90H G	\$528
	5G 900 90H G	\$561
10"/Gel	2G 900 91H G	\$528
	5G 900 91H G	\$561
8.5"/Foam	2G 900 90H F	\$507
	5G 900 90H F	\$540
10"/Foam	2G 900 91H F	\$507
	5G 900 91H F	\$540

Swivel Mouse System

- 2G or 5G Mechanism
- Standard 900 Platform
- 8" Swivel Mouse (Right or Dual)
- Synthetic Leather Palm Support (Gel or Foam)

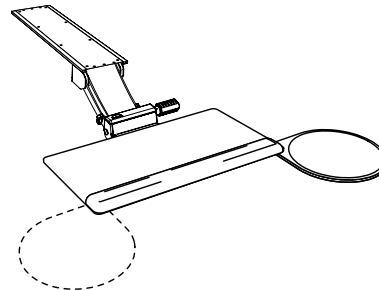

Shown with 5G mechanism

Right/Gel	2G 900 11R G	\$503
	5G 900 11R G	\$536
Dual/Gel	2G 900 11D G	\$561
	5G 900 11D G	\$594
Right/Foam	2G 900 11R F	\$482
	5G 900 11R F	\$515
Dual/Foam	2G 900 11D F	\$540
	5G 900 11D F	\$573

Build Your Keyboard System Product Code

Choose from our many mechanisms, keyboard platforms, mouse platforms, palm supports and track lengths to configure your own customized keyboard system.

Keyboard System Product Code:

Mechanism	Keyboard Platform	Mouse Platform	Palm Support	Track (optional)
1	2	3	4	5
_____	_____	_____	_____	_____

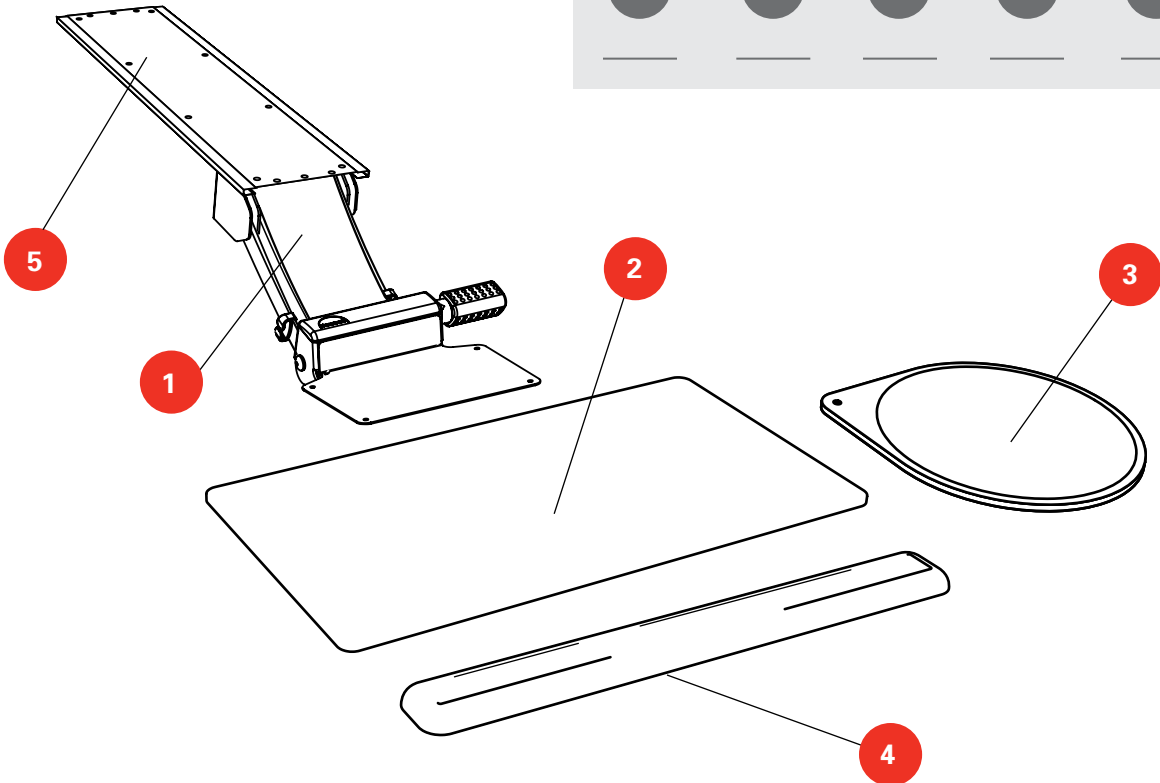



1

Mechanism Options

All keyboard mechanisms, with the exception of the KM, offer 0° to -15° tilt for low-risk typing postures.
Build-Your-Own configurations are available in Black only.

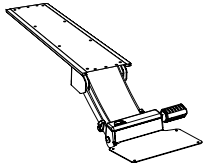

5G \$316 The world's best-selling keyboard mechanism, the 5G combines easy dial-a-tilt and height adjustability with the strongest arm on the market.
*6.25" height adjustment
(1.25" above track to 5" below track)
Comes standard with 21.625" track*

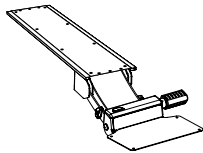

5GSM \$316 The 5G Short Mechanism provides 5G functionality with a shorter arm for small workstations and tight spaces.
*4" height adjustment
(0.5" above track to 3.5" below track)
Comes standard with 18" track*

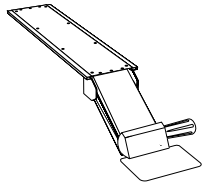

4G \$442 The 4G represents revolutionary keyboard technology with simple dial-a-tilt keyboard angle adjustability.
*6.25" height adjustment
(1.25" above track to 5" below track)
Comes standard with 21.625" track*

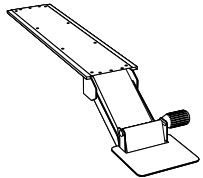

2G \$283 The original standard bearer, the 2G offers independent height and tilt adjustment and unmatched stability.
*6.25" height adjustment
(1.25" above track to 5" below track)
Comes standard with 21.625" track*

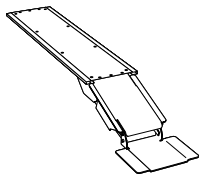

KM \$258 The Standard Pre-Set Tilt Arm offers total knee clearance, knob-free adjustment and 0° tilt.
*6.25" height adjustment
(1.25" above track to 5" below track)
Comes standard with 21.625" track*

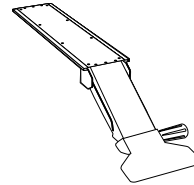

4GAD \$391 The 4G Above Desk mechanism provides 4G functionality with a longer arm for use above the work surface.
*11.5" height adjustment
(8.5" above track to 3" below track)
Comes standard with 27" track*

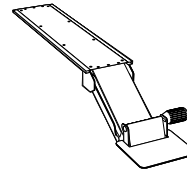

AD \$359 The Above Desk mechanism provides 2G functionality with a longer arm for use above the work surface.
*10" height adjustment
(5" above track to 5" below track)
Comes standard with 25" track*

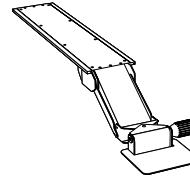

DS \$422 The Double Swivel provides an additional pivot point for increased adjustability.
*80° swivel at platform
6.25" height adjustment
(1.25" above track to 5" below track)
Comes standard with 25" track*

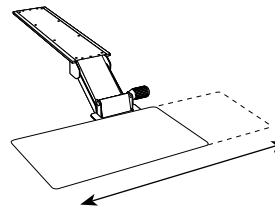

Mechanism Accessory

LS \$101 The Lateral Slider allows the platform to be adjusted left or right a total of 8" for optimal keyboard positioning. It can be ordered with any keyboard mechanism by indicating "LS" after the mechanism code (e.g., 2GLS).

2

Keyboard Platform Options

All Build-Your-Own platforms are available in Black only.

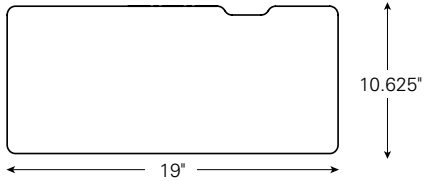

900 Standard \$116

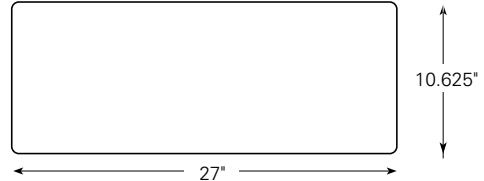

500 Big \$174

*Comes with built-in mousing surface.
Not available with other mouse platform options.*

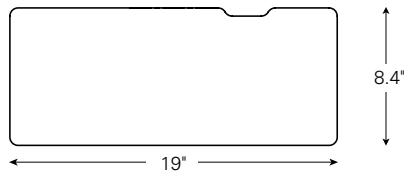

950 Standard Compact \$116

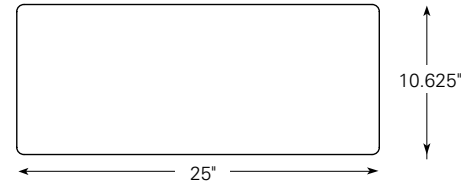

550 Big Compact \$174

*Comes with built-in mousing surface.
Not available with other mouse platform options.*

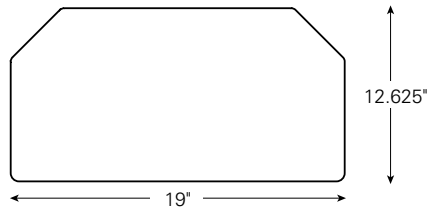

700 Diagonal \$116

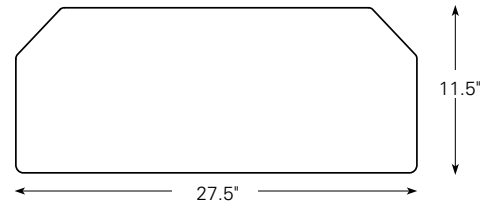

400 Diagonal Big \$174

*Comes with built-in mousing surface.
Not available with other mouse platform options.*

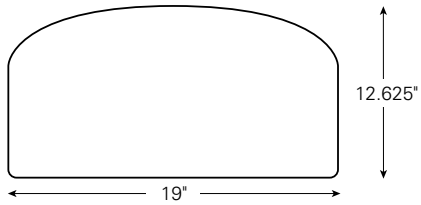

800 Radiused \$116

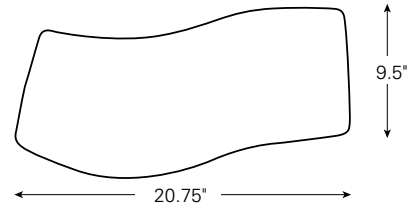

300 Curved \$116

Not available with a palm support.

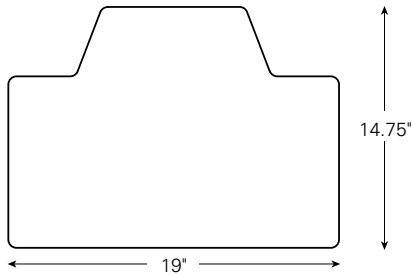

600 Extender \$142

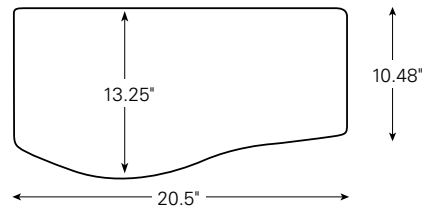

100 Combo \$116

3

Mouse Platform Options

All Build-Your-Own mouse platforms are available in Black only.

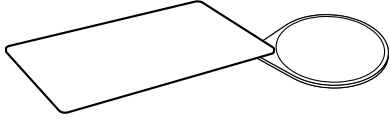

11R	8" Swivel Right	\$58
11L	8" Swivel Left <i>(not pictured)</i>	\$58
11D	8" Swivel Dual <i>(not pictured)</i>	\$116

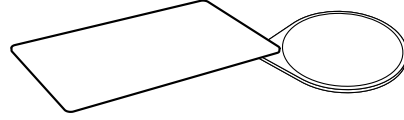

12R	10" Swivel Right	\$58
12L	10" Swivel Left <i>(not pictured)</i>	\$58
12D	10" Swivel Dual <i>(not pictured)</i>	\$116

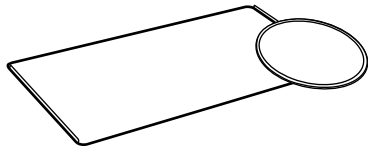

90	8.5" Clip	\$83
90H	8.5" High Clip	\$83

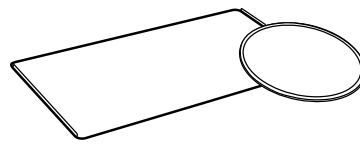

91	10" Clip	\$83
91H	10" High Clip	\$83

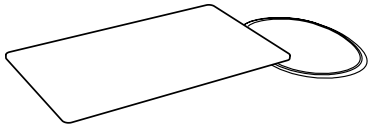

81R	M² Right	\$58
81L	M² Left <i>(not pictured)</i>	\$58
81D	M² Dual <i>(not pictured)</i>	\$116



4

Palm Support Options

All Build-Your-Own palm supports are available in Black only.

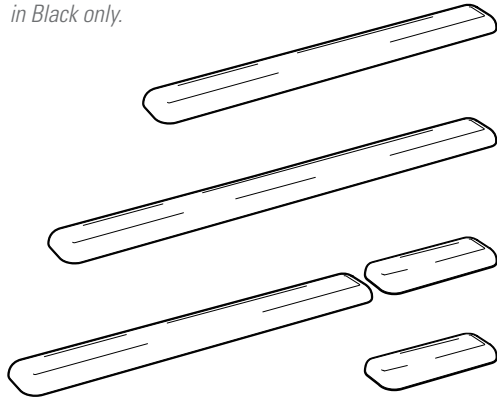

F	19" Foam with synthetic leather cover	\$25
G	19" Gel with synthetic leather cover	\$46
F20	20" Foam with synthetic leather cover	\$25
G20	20" Gel with synthetic leather cover	\$46
F25	25" Foam with synthetic leather cover	\$32
G25	25" Gel with synthetic leather cover	\$54
<i>For 550 boards only</i>		
F27	27" Foam with synthetic leather cover	\$32
G27	27" Gel with Lycra knit cover	\$52
<i>For 400 and 500 boards only</i>		
FMP	20" and 7" Foam with synthetic leather cover	\$40
GMP	20" and 7" Gel with synthetic leather cover	\$64
<i>For 400 and 500 boards only</i>		
MP7F	7" Foam with synthetic leather cover	\$16
MP7G	7" Gel with synthetic leather cover	\$20

5

Track Options

All keyboard systems ship with track lengths noted on page 5. Please use the following codes to order a specific track for your system.

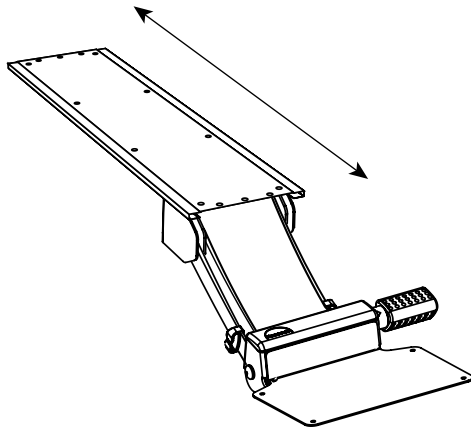

27	27" track	N/C
25	25" track	N/C
22	Standard 21.625" track	N/C
18	18" track	N/C
16	16" track	N/C
14	14" track	N/C
11	11" track	N/C

Replacement Tracks with Hardware Pack (if ordering without mechanism)

RT27	27" track	\$71
RT25	25" track	\$65
RT22	Standard 21.625" track	\$52
RT18	18" track	\$52
RT16	16" track	\$52
RT14	14" track	\$52
RT11	11" track	\$52

Keyboard System Accessories

Mouse Pads



HSMP12TIPS \$6

8" 12 Tips Ergo Mouse Pad

HSMP12TIPS10 \$7

9" 12 Tips Ergo Mouse Pad

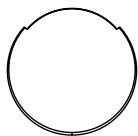

CMPGEL8 \$31

8.5" Gel Mouse Pad

For 90 or 90H Clip Mouse

CMPGEL \$31

10" Gel Mouse Pad

For 91 or 91H Clip Mouse

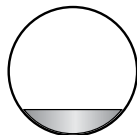

MPGEL8 \$25

8.5" Gel Mouse Pad

MPGEL10 \$31

10" Gel Mouse Pad

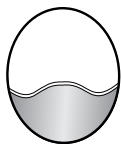

GPSMP \$44

Desktop Mouse Pad with Gel Palm

Palm Support



MM10 \$19

Mouse Mate



GPS \$52

Desktop Gel Palm Support

Corner Sleeves

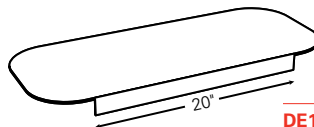

DE100 \$154

29.5" x 12.188"

Fits desks 1" to 1.5" thick

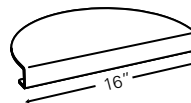

DE200/DE250 \$97

16" diameter

DE200 fits desks 1" to 1.5" thick

DE250 fits desks 1.5" to 2.5" thick

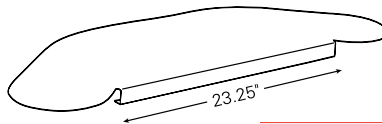

DE400/DE450 \$251

38.5" x 13.75"

DE400 fits desks 1" to 1.5" thick

DE450 fits desks 1.5" to 2.5" thick



Ergonomic Accessories

Input Device



Switch Mouse

SMUSB

\$144

Switch Mouse with USB connector, optical sensor and navigation dish

Laptop Holders

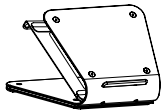

L2

\$256

Notebook Manager

Maximum Dimensions:
10" d x 10.5" w x 8.75" h
5" height adjustability

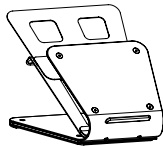

L2DS

\$288

Notebook Manager with Docking Station Support

L2DSEXT

\$38

Retrofit Docking Station Support

Foot Rests

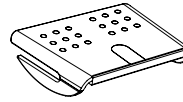

Rocking Foot Machine

FM500C (Cherry)

\$182

FM500K (Black)

\$182

12.25" d x 16.75" w x 4.5" h



Foot Machine with Massage Balls

FM300B (Natural)

\$216

FM300BDC (Dark Cherry)

\$216

11.875" d x 16" w

Height Range: 3.75" to 6.75"



Foot Machine

FM300 (Natural)

\$162

11.875" d x 16" w

Height Range: 3.75" to 6.75"



Tilting Foot Rest

FM100 (Natural)

\$150

11.75" d x 19" w x 3.375" h

Cable Management



NeatLinks — Small 17"

NL17SB (Black)

\$23

NL17SG (Gray)

\$23

Small 2.6" Diameter, 17" Length

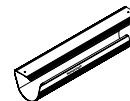

NeatLinks — Large 17"

NL17LB (Black)

\$25

NL17LG (Gray)

\$25

Large 3.6" Diameter, 17" Length



NeatLinks — Small 24"

NL24SB (Black)

\$25

NL24SG (Gray)

\$25

Small 2.6" Diameter, 24" Length

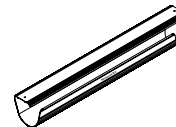

NeatLinks — Large 24"

NL24LB (Black)

\$28

NL24LG (Gray)

\$28

Large 3.6" Diameter, 24" Length

Ergonomic Accessories

CPU Holders

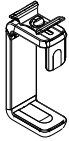

CPU600 \$202

Fits CPUs 3.5" to 9" wide by 12" to 20" high
Max CPU Weight: 50 lbs.

Installed Dimensions:
7" or CPU Width + 1.7" (whichever is greater), CPU Height + 3.6"

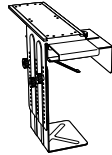

CPU300 \$170

Fits CPUs 3.25" to 9" wide by 10.5" to 18" high
Max CPU Weight: 70 lbs.

Installed Dimensions:
CPU Width + 1.5", CPU Height + 3"

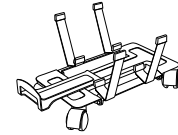

CPU Dolly

CPUDLY \$184

Fits CPUs 3.25" to 9" wide
Installed Dimensions:
CPU Height + 3.75"

CPUDLYPLT \$197

With Platform
For CPUs 1.5" to 9" wide

CPUPLATFORM \$20

CPU Dolly Retrofit Platform

CPUDLYH \$46

Telescoping Pull Handle

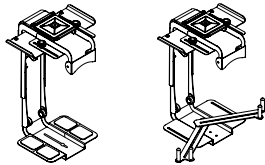

CPU555 \$197

Fits CPUs 3" to 9.5" wide
by 12" to 22" high
Max CPU Weight: 70 lbs.

Installed Dimensions:
CPU Width + 3.5", CPU Height + 4.5"

CPU555SEC \$235

With Security System

CPU555STOOL \$32

Replacement Tool Kit for CPU555SEC
(comes standard with CPU555SEC)

CPU555SECKIT \$60

Retrofit Security Kit for CPU555
(comes standard with CPU555SEC)

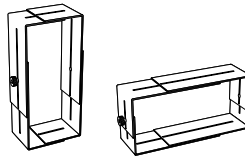

CPU450 \$157

Fits CPUs 4" to 8"
by 11.5" to 20"
Max CPU Weight: 50 lbs.

Installed Dimensions:
CPU Width + 2.5", CPU Height + 3.75"

CPU450STK \$40

Swivel Track Upgrade Kit

Quick Track

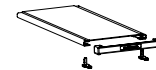

Quick Track

QT \$16

Easily removable (without tools) front bracket makes swap-outs a snap.

To order, simply add "QT" to end of product code (e.g., CPU555QT).

Comes standard with CPU600.



In-Line Document Holders

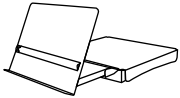

Copy Drawer

CH3000 (Putty)	\$184
CH3000B (Black)*	\$184
15" d x 15.5" w x 3" h	

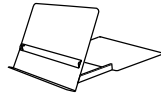

Copy Stand

CH1000 (Putty)	\$151
CH1000B (Black)*	\$151
12" d x 14" w x 3" h	
<i>For use with CRTs</i>	



Copy Stand Basic

CH900 (Putty)	\$132
CH900B (Black)*	\$132
11" d x 14" w x 3" h	
<i>For use with flat panel monitors</i>	

* Black may require up to an 8–10 week lead time. See your Humanscale sales representative for more information.

Security Lock

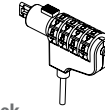

Security Lock

SECLOCK	\$50
For CPUs, laptops, flat panels, etc.	
Fits all units with standard security keyhole	

Glare Filters

NOTE:

Filter fits size of monitor indicated by number in code.
For example, FP15 fits 15" monitors.

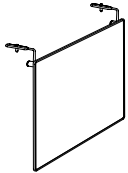

Flat Panel Filters

with Tempered Glass and
95% Transmission (5% Tint)

Standard

FP15	14.25" w x 10.875" h	\$151
FP17	14.625" w x 12.75" h	\$262
FP19	15.75" w x 12.375" h	\$295
FP20	17.125" w x 13" h	\$316
FP21	18.125" w x 13.75" h	\$328

Privacy

FP15PF	13.125" w x 10" h	\$282
FP17PF	15" w x 11.5" h	\$348
FP19PF	15.75" w x 12.375" h	\$386
FP20PF	17.125" w x 13" h	\$400
FP21PF	18.125" w x 13.75" h	\$420

Ergo Block

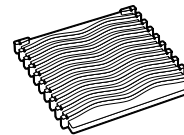

Ergo Block

EB025 (Gray)	\$13
EB025B (Black)	
1" x 11.25" x 11.25"	
Stackable Riser	
EB050 (Gray)	\$17
EB050B (Black)	
2" x 11.25" x 11.25"	
Stackable Riser	

Build Your Diffrient Light Product Code

To create the product code for your Diffrient Light, simply choose your preferred style, mount, color and bulb, and combine the respective codes for each.

Lighting Product Code:

Style	Mount	Color	Bulb
1	2	3	4
_____	_____	_____	_____

1 Style

DIFFRIENT TASK LIGHT (DT SERIES)

Compatible with 4-pin compact fluorescent bulbs.

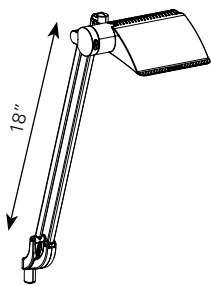

DT1E \$348
Single Arm with Task Shade

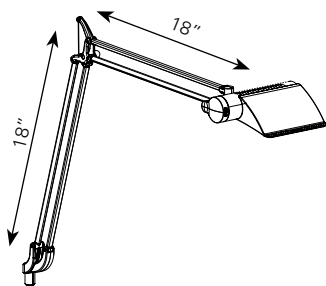

DT2E \$386
Double Arm with Task Shade

DIFFRIENT WORK LIGHT II (DX SERIES)

E26 socket compatible with screw-in bulbs up to 60W.

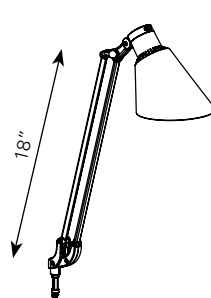

DX1E \$348
Single Arm with Work Shade

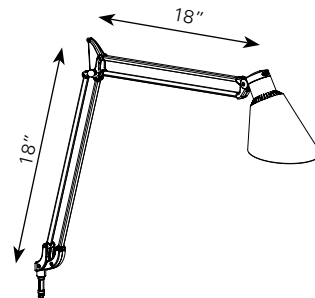

DX2E \$386
Double Arm with Work Shade

2 Mount



B Add \$108
Desktop Base
9" diameter

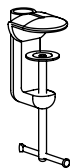

C N/C
Clamp
For grommet or edge mount. Fits surfaces up to 2" thick and grommet holes 2" or more in diameter.

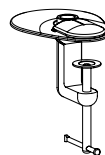

G Add \$12
Clamp with Grommet Cover
For grommet holes 2" - 3.25" in diameter.

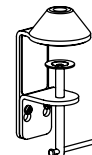

K Add \$18
2-Piece Clamp
Requires minimum 1/4" clearance between desk and wall or panel.



2 Mount, cont.



- Panel Mount** Add \$30
- PC** Allsteel Concensys
 - P2** Allsteel Terrace 2.6 & 3.4, Align
 - PH** Haworth Places, Unigroup
 - PM** Haworth Premise
 - PA** Herman Miller Action Office
 - PE** Herman Miller Ethospace
 - PR** Herman Miller Resolve
 - P9** Steelcase 9000
 - PB** Teknion Boulevard
 - PI** Teknion IE
 - PL** Teknion Leverage, Transit
- Not compatible with corner mount applications. For other panel systems, see your Humanscale representative.*

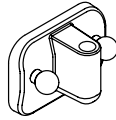

- S** N/C
Universal Slatwall
Adjusts to fit most standard slatwalls.



- W** N/C
Wall
Screws into vertical surface.

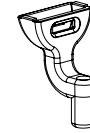

- A** N/C
Humanscale Access Rail



- D** N/C
Direct
Screws into horizontal surface.

3 Color

- S**
Silver

- B**
Black

4 Bulb

DIFFRIENT TASK LIGHT (DT SERIES)

26W, 3500K, 4-Pin Base N/C

DIFFRIENT WORK LIGHT II (DX SERIES)

- 1** 18W, 3500K (standard) N/C
- 2** 23W, 3500K N/C
- 0** No Bulb Less \$6

Diffrient Light Replacement Parts *(if purchased separately)*

MOUNTS

Desktop Base	DLBS (silver), DLBB (black)	\$150
Access Rail	DLAS (silver), DLAB (black)	\$42
Clamp <i>For grommet or edge mount</i>	DLCS (silver), DLCB (black)	\$42
2-Piece Clamp <i>For edge mount</i>	DLKS (silver), DLKB (black)	\$60
Direct	DLDS (silver), DLDB (black)	\$42
Universal Slatwall	DLSS (silver), DLSB (black)	\$42
Wall	DLWS (silver), DLWB (black)	\$42
Panel Mount	DL <u>1</u> <u>1</u> <u>2</u>	\$72
<small>(1): Panel System Code, (2): Color (B or S)</small>		
Grommet Cover <i>For use with Clamp Mount C</i>	DLGC (black)	\$12

TASK AND WORK LIGHT ACCESSORIES (DT AND DW SERIES)

Electronic Ballast	DLBALE (gray)	\$151
Magnetic Ballast	DLBALM (black)	\$120
Bulb <i>26W, 3500K, 4-Pin Base</i>	DLBULB	\$26

WORK LIGHT II ACCESSORIES (DX SERIES)

Bulb <i>18W, 3500K, screw-in base</i>	DLCFL1	<i>Consult your rep</i>
Bulb <i>23W, 3500K, screw-in base</i>	DLCFL2	<i>Consult your rep</i>

Humanscale and the Environment

At Humanscale, we believe good design achieves more with less. In other words, performance and sustainability are not mutually exclusive, but rather, complementary outcomes of good design. By striving for simpler, more elegant design solutions, Humanscale excels in developing products that—compared to others in the same class—consume less of the Earth’s limited resources. This is accomplished by creating designs that:

- Weigh less, requiring less raw material
- Use fewer parts and manufacturing processes
- Contain a high percentage of recycled content
- Contain a high percentage of recyclable content

Whenever possible, Humanscale uses aluminum as its material of choice. Our aluminum is 100% recycled and recyclable. It never degrades, so it can be reused over and over again. And because recyclers are paid a premium for aluminum scrap, we believe that the aluminum in our products will almost surely be recycled when the time comes. Using aluminum usually costs us more than plastics or other alternatives, but our products are better for it. And so is the environment.

In addition to supporting sustainability through superior design, Humanscale is a major contributor to and maintains an active partnership with World Wildlife Fund.

LEED® Credit

Virtually all Humanscale products can help a project achieve LEED-CI Certification in a number of areas, including a valuable Innovation in Design credit. With help from Humanscale, the U.S. Green Building Council set a precedent for achieving this credit in their Platinum-certified headquarters with the implementation of a comprehensive ergonomics program. Contact Humanscale for step-by-step guidance on developing a successful ergonomics initiative, and additional information on earning LEED-CI credits.

RECYCLED MATERIALS

Product	Recycled Content	LEED Recycled Content Post-Consumer + 1/2 Pre-Consumer
Freedom Chair	43% Post-Consumer 19% Pre-Consumer	53%
Freedom Saddle	41% Post-Consumer 18% Pre-Consumer	50%
Liberty Chair	32% Post-Consumer 22% Pre-Consumer	43%
Liberty Side Chair	49% Post-Consumer 36% Pre-Consumer	67%
Cinto	15% Post-Consumer 11% Pre-Consumer	21%
M4 Monitor Arm	47% Post-Consumer 20% Pre-Consumer	57%
M7 Monitor Arm	63% Post-Consumer 27% Pre-Consumer	77%
Keyboard Systems	15% Post-Consumer 10% Pre-Consumer	20%
CPU600	34% Post-Consumer 17% Pre-Consumer	43%
CPU555 CPU450 CPU300 CPU Dolly	21% Post-Consumer 9% Pre-Consumer	26%
Diffrient Light with Base	63% Post-Consumer 27% Pre-Consumer	77%
NeatLinks	50% Post-Consumer 0% Pre-Consumer	50%



Proud Sponsor of:



This brochure is printed in the USA on Lynx paper certified by SmartWood as a well-managed source of wood products whose forest management practices adhere to strict environmental and socioeconomic standards in accordance with the criteria of the Forest Stewardship Council (FSC). Smartwood is a program of the Rainforest Alliance.



Humanscale Terms and Conditions

THE FOLLOWING TERMS & CONDITIONS APPLY TO ALL HUMANSCALE PRODUCTS.

TERMS OF PAYMENT

Upon approved credit, terms of payment are net 30 from date of shipment. Deposits may be required for large or custom orders. The processing of orders and/or shipment of orders placed may be delayed if the deposit is not received with the order or if customer's account is in "Past Due" status.

CREDIT POLICY

All customers of Humanscale must complete a credit application, with current information, which must be signed by an owner or officer. A line of credit may be set by our Credit Department, however the basis for the line of credit may be changed or cancelled at our discretion and advance payment may be required. Any unpaid balance, upon which payments are not made according to the terms governing the sale, will be considered "Past Due" and will increase by a maximum of 2% per month, without forfeit of Humanscale's right to payment.

Any customer who has failed to pay for goods delivered or services rendered in a timely manner shall be liable for all fees, expenses, disbursements, and charges (including all legal costs) incurred by Humanscale in collecting monies owed, as well as interest (at 24% per annum).

PURCHASE ORDERS

Purchase orders must include the following: "Bill To" and "Ship To" information—Company Name (Ship To company may be end user or installation company), Address, Telephone, Fax, Contact Person; End User Company Name; Requested Ship Date; Purchase Order Number; Special Delivery, Shipping and Packing Instructions (if applicable); Proper Discount Off Current List Price, Product Quantities and Full Model Numbers; and Total (List/Net).

ORDER CHANGES & CANCELLATIONS

All changes to or cancellations of orders placed with Humanscale must be in writing and sent to Customer Service. Orders may be changed or cancelled without penalty if Humanscale is notified at least two (2) weeks before the scheduled ship date. All order changes or cancellations made less than two (2) weeks before the scheduled ship date will incur a minimum change/cancellation fee of 10% of net. Irrespective of when notified, changes or cancellations are not binding upon Humanscale until Humanscale issues a written acknowledgment of the change or cancellation. Order changes are defined as the deletion of line items; changes in style, color, quantity or requested ship date; or ship-to address changes. Order changes that result in a quantity reduction may be subject to an additional small order fee or adjustment in pricing. Under no circumstances will changes or cancellations be accepted on any custom fabric, special order or custom product orders.

TAXES

Humanscale list prices do not include sales tax. Customer is responsible to remit all such tax. Humanscale requires a State Resale/Exemption Certification to be on file at its main office. Sales made without said Certificate will be charged the appropriate sales tax.

PRICES

All discounts and list prices are subject to change without notice. Prices are those in effect at the time of order entry. If the requested shipment date is more than 90 days after the order date, Humanscale reserves the right to price said order based on the published list price as of the shipment date.

SMALL ORDER FEE

A 3% small order fee applies to all invoiceable orders of \$1,500 net or less, including billable replacement parts, regardless of product category.

SHIPPING AND DELIVERY

All Humanscale orders are acknowledged with a promise date (scheduled ship date) based on the product with the longest lead time. Large orders may increase standard lead times. Standard shipping charges will be billed to customer. Custom platform orders require 4 to 6 weeks.

Seating orders, unless otherwise specified, will ship 4 to 6 weeks from the date of order. Unless otherwise contractually specified, Freedom and Liberty chairs will ship with the base and frame disassembled. Chairs can be easily assembled in seconds without use of tools. Blanket-wrapped shipping is available for full truckloads of 200 or more Freedom or Liberty Task and Conference chairs. Consult your Humanscale representative for blanket-wrapped shipping requirement for Cinto and the Liberty Side chair.

Ship Sets: All products ordered on a single purchase order will be delivered together in a single ship set. To break a ship set, customers must indicate "Ship as Available" on the purchase order. Upon request, customer accounts may be defaulted to ship all orders on an as-available basis.

Shipping Instructions: Humanscale will attempt to accommodate basic shipping instructions, such as "call ahead" or "deliver before 12:00 p.m.," if clearly identified on the purchase order as "Shipping Instructions."

Packing Instructions: Humanscale will attempt to accommodate basic packing instructions for internal delivery of specific items on an order, such as "Deliver to Joe Smith" or "Deliver to cube #218," if clearly identified on the purchase order as "Packing Instructions."

DELIVERY SHORTAGES

Product shortages must be noted at the time of delivery and reported to the carrier for correction. Claims against Humanscale for shortages, errors, etc., must be made in writing and within three (3) days of the date of delivery or customer waives its right to make such a claim.

FREIGHT CLAIMS

Humanscale will file all F.O.B. destination claims. In order to receive credit, customer agrees to cooperate and assist in the procedures set out by the carrier and Humanscale.

EXTERNAL DAMAGE

If the shipping container shows any external damage, customer is instructed to refuse the product at time of delivery. If it is a multiple piece shipment, customer may refuse only the damaged items. Humanscale will not issue full credit for returned product unless customer takes the following action steps:



1. Note damage on the delivery receipt at time of delivery.
2. Refuse product at time of delivery.
3. Contact Humanscale Customer Service within 24 hours of the attempted delivery and advise them of the damage.
4. Enter a chargeable replacement order; credit will be issued after the disposition of damaged product is determined.

CONCEALED DAMAGE/LOSS

If customer determines that there is internal damage not visible at time of delivery, customer will retain all packaging materials and take the following action steps within fifteen (15) calendar days from the date of delivery:

1. Request inspection by calling local freight carrier to report damage.
2. Retain merchandise in the original box.
3. Call your Humanscale Customer Service agent to provide order and product information.
4. Get a copy of the inspection report from carrier.
5. Enter a chargeable replacement order; credit will be issued after the disposition of damaged product is determined.

STORAGE

If a customer is unable to accept a scheduled product delivery, Humanscale, if notified in writing after product assembly and prior to the scheduled ship date, will store the product at customer's expense. Humanscale shall invoice customer for the product and monthly Storage Fees.

Storage Fees will be 1% of the net order value per month or actual storage costs—which ever is greater. Storage Fees are calculated with a one-month minimum and will not be pro-rated. If customer is unable to accept a scheduled product upon delivery, customer shall be responsible for placing the product in storage and bears the risk of loss. However, payment of the balance due is per Humanscale's Terms of Payment.

RETURN AUTHORIZATIONS & REFUSALS

All returned and non-damaged refused orders are subject to a twenty percent (20%) restocking fee. Seating and special order returns will not be accepted. Customer must request a Return Authorization through the Humanscale Customer Service Department within 45 days of product receipt to return any product. If Humanscale agrees to restock the product, customer must return it freight prepaid to Humanscale, F.O.B., to the original shipping point or as otherwise instructed by Humanscale Customer Service. If product is returned without a Return Authorization, Humanscale will notify customer of the unauthorized return and customer must provide instructions for its disposition within one week thereafter. Failure of customer to respond within one week will result in Humanscale's right to dispose of the product with no credit. Return Authorizations expire sixty (60) days after the date of issue. If the returned product is not in resalable condition, customer will not receive credit for the return. Customer must promptly provide a purchase order or other acceptance of fees/credit reduction as required.

WARRANTY

THE FOLLOWING WARRANTY IS IN LIEU OF ALL OTHER WARRANTIES EXPRESS OR IMPLIED, INCLUDING, BUT NOT LIMITED TO, THE IMPLIED WARRANTY OF MERCHANTABILITY AND FITNESS FOR A PARTICULAR PURPOSE AND ALL OTHER WARRANTIES ARISING FROM COURSE OF DEALING OR USAGE OF TRADE.

Humanscale offers the following warranties on its products:

PRODUCT	WARRANTY
Light Bulbs Customer's Own Material (COM, COL)	No Warranty
Switch Mouse	1 Year
Diffrient Light Fabric/Cushions	5 Years
M4 & M7 Monitor Arms with Gas Cylinder Components	10 Years
All Other Products, Detailed in a Current Price Guide	15 Years
All Other Products, Not Detailed in a Current Price Guide	Varies; consult your Humanscale rep for details

This Warranty is applicable to the initial purchaser only and is non-transferable. If products are procured through authorized Humanscale Dealerships, the end-user customer must be registered with Humanscale for the warranty to be in effect. Humanscale warrants that, at the time of customer's receipt, the product will be in good working order and will be free from defects in material and workmanship. This Warranty does not apply to normal wear and tear or damage caused by accident, neglect, misuse or improper installation or operation. Humanscale will not be responsible for damage due to service, maintenance, modifications or tampering by anyone other than a Humanscale authorized representative. In the event a product is defective and Humanscale receives written notice of the defect within the Warranty period, Humanscale, at its option, will either repair or replace the defective product. This Warranty does not cover damage caused by a carrier or transportation of the product from one location to another, or alterations made by owner.

LIMITATION OF LIABILITY

Purchaser's remedies set forth herein are exclusive and the liability of Humanscale with respect to the breach of this agreement or any contract entered into between the parties pursuant hereto shall not exceed the price of the product or part on which such liability is based. In no event will Humanscale be liable to purchasers for any special, collateral, incidental or consequential damages however caused, whether by Humanscale's negligence or otherwise.

The remedies provided above are the purchaser's sole remedies for any failure of Humanscale to comply with its obligations regarding the workmanship of its products. Correction of any nonconformity in the manner and for the period of time provided shall constitute complete fulfillment of all liabilities of Humanscale, with respect to or arising out of the product furnished hereunder.



Ergo Tools Pricing and Specification Guide

Price Guide - Canada Prices effective January 2009



U.S. Headquarters

11 East 26th Street
8th Floor
New York, NY 10010
212 725 4749
212 725 7545 fax

Customer Service

10 Inverness Drive East
Suite 100
Englewood, CO 80112
800 400 0625
303 858 9912
303 858 9916 fax
info@humanscale.com

European Headquarters

13 Northburgh Street
London
EC1V 0JP
United Kingdom
+44 207 566 7990
+44 207 566 7991 fax
info@humanscale.co.uk

www.humanscale.com



Our Design Philosophy

At Humanscale, we believe the best designs in the world are based on purpose and function. If a design solves a functional problem as simply and elegantly as possible, the resulting form will be honest and timeless.

Recognized by I.D. Magazine as one of the 10 "Best Companies" worldwide that help push design forward.