



# *ESTIMATING EARTHWORK*

# *Estimating Earthwork*

Earthwork includes:

- 👍 1. Excavation
- 👍 2. Grading: Moving earth to change elevation
- 👍 3. Temporary shoring
- 👍 4. Back fill or fill: Adding earth to raise grade
- 👍 5. Compaction: Increasing density
- 👍 6. Disposal

# *Productivity Factors*

## A. Job conditions

✓ Material type

✓ Water level and moisture content

✓ Job size

✓ Length of haul

✓ Haul road condition (accessibility and load restrictions)

# *Productivity Factors (cont.)*

## B. Management conditions

- ✓ Equipment conditions and maintenance practices
- ✓ Skills of work force and management
- ✓ Planning, supervision and coordination of work.

# *Job Efficiency Factors for Earthmoving Operations*

| Job Conditions** | Management Conditions* |      |      |      |
|------------------|------------------------|------|------|------|
|                  | Excellent              | Good | Fair | Poor |
| Excellent        | 0.84                   | 0.81 | 0.76 | 0.70 |
| Good             | 0.78                   | 0.75 | 0.71 | 0.65 |
| Fair             | 0.72                   | 0.69 | 0.65 | 0.60 |
| Poor             | 0.63                   | 0.61 | 0.57 | 0.52 |

# Units of Measure

👍 Cubic Yard (bank, loose, or compacted)

**Bank (BCY):**

Materials in its natural state before disturbance (in-place, in-situ)

**Loose (LCY):**

Material that has been compacted or disturbed or loaded

**Compacted (CCY):** Material after compaction

1.0 CUBIC  
YARD IN  
NATURAL  
CONDITION  
(IN-PLACE  
YARD)

=

1.25 CUBIC  
YARD AFTER  
DIGGING  
(LOOSE  
YARDS)

=

0.90 CUBIC  
YARD AFTER  
COMPACTED  
(COMPACTED  
YARDS)

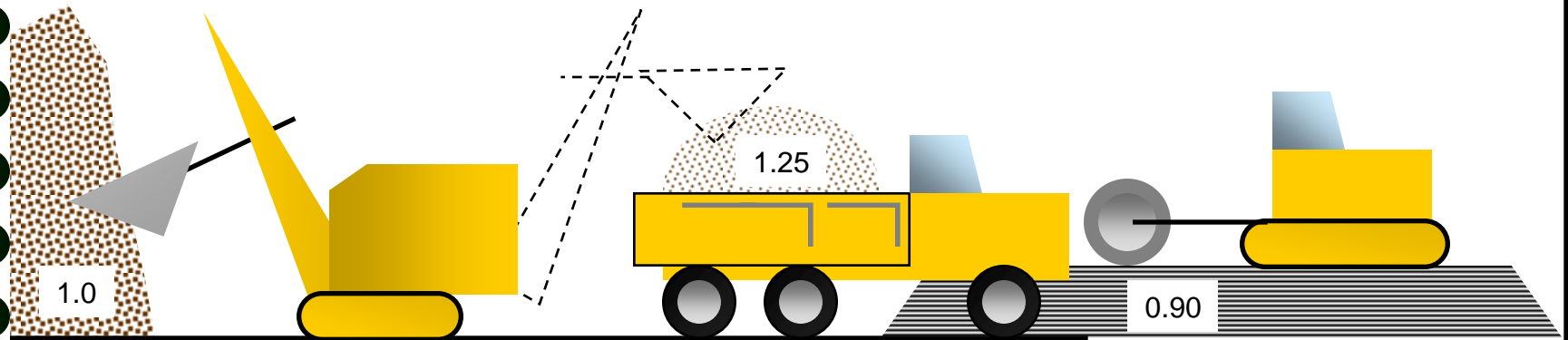

In place

Loose

Compacted

# Volume

Bank:  $V_B$

$\gamma$  Bank cubic yards (BCY)

$\gamma$  Density B Lb /BCY

Loose:  $V_L$

$\gamma$  Loose cubic yards (LCY)

$\gamma$  Density L Lb/LCY

Compacted:  $V_C$

$\gamma$  Compacted cubic yards (CCY)

$\gamma$  Density C LB/CCY



Swell:

A soil increase in volume when it is excavated.

$$\text{Swell (\%)} = \left( \frac{\text{Bank density}}{\text{Loose density}} - 1 \right) \times 100$$

$$\text{Load factor} = \frac{\text{Loose density}}{\text{Bank density}}$$

Bank Volume = Loose volume x Load factor

Shrinkage:

A soil decreases in volume when it is compacted

$$\text{Shrinkage (\%)} = \left( 1 - \frac{\text{Bank density}}{\text{Compacted density}} \right) \times 100$$

Shrinkage factor = 1 - Shrinkage

Compacted volume

= Bank volume x Shrinkage factor

# Approximate Material Characteristics

| Material             | Loose<br>(lb/cy) | Bank<br>(lb/cy) | Swell<br>(%) | Load<br>Factor |
|----------------------|------------------|-----------------|--------------|----------------|
| Clay, dry            | 2,100            | 2,650           | 26           | 0.79           |
| Clay, wet            | 2,700            | 3,575           | 32           | 0.76           |
| Clay and gravel, dry | 2,400            | 2,800           | 17           | 0.85           |
| Clay and gravel, wet | 2,600            | 3,100           | 17           | 0.85           |
| Earth, dry           | 2,215            | 2,850           | 29           | 0.78           |
| Earth, moist         | 2,410            | 3,080           | 28           | 0.78           |
| Earth, wet           | 2,750            | 3,380           | 23           | 0.81           |
| Gravel, wet          | 2,780            | 3,140           | 13           | 0.88           |
| Gravel, dry          | 3,090            | 3,620           | 17           | 0.85           |
| Sand, dry            | 2,600            | 2,920           | 12           | 0.89           |
| Sand, wet            | 3,100            | 3,520           | 13           | 0.88           |
| Sand and gravel, dry | 2,900            | 3,250           | 12           | 0.89           |
| Sand and gravel, wet | 3,400            | 3,750           | 10           | 0.91           |

Exact values will vary with grain size, moisture content, compaction, etc. Test to determine exact values for specific

# Typical Soil Volume Conversion Factors

| Soil Type      | Initial Soil Condition | Bank | Converted to: |           |
|----------------|------------------------|------|---------------|-----------|
|                |                        |      | Loose         | Compacted |
| Clay           | Bank                   | 1.00 | 1.27          | 0.90      |
|                | Loose                  | 0.79 | 1.00          | 0.71      |
|                | Compacted              | 1.11 | 1.41          | 1.00      |
| Common earth   | Bank                   | 1.00 | 1.25          | 0.90      |
|                | Loose                  | 0.80 | 1.00          | 0.72      |
|                | Compacted              | 1.11 | 1.39          | 1.00      |
| Rock (blasted) | Bank                   | 1.00 | 1.50          | 1.30      |
|                | Loose                  | 0.67 | 1.00          | 0.87      |
|                | Compacted              | 0.77 | 1.15          | 1.00      |
| Sand           | Bank                   | 1.00 | 1.12          | 0.95      |
|                | Loose                  | 0.89 | 1.00          | 0.85      |
|                | Compacted              | 1.05 | 1.18          | 1.00      |

# *Estimating Earth work for Trenches and Foundation*

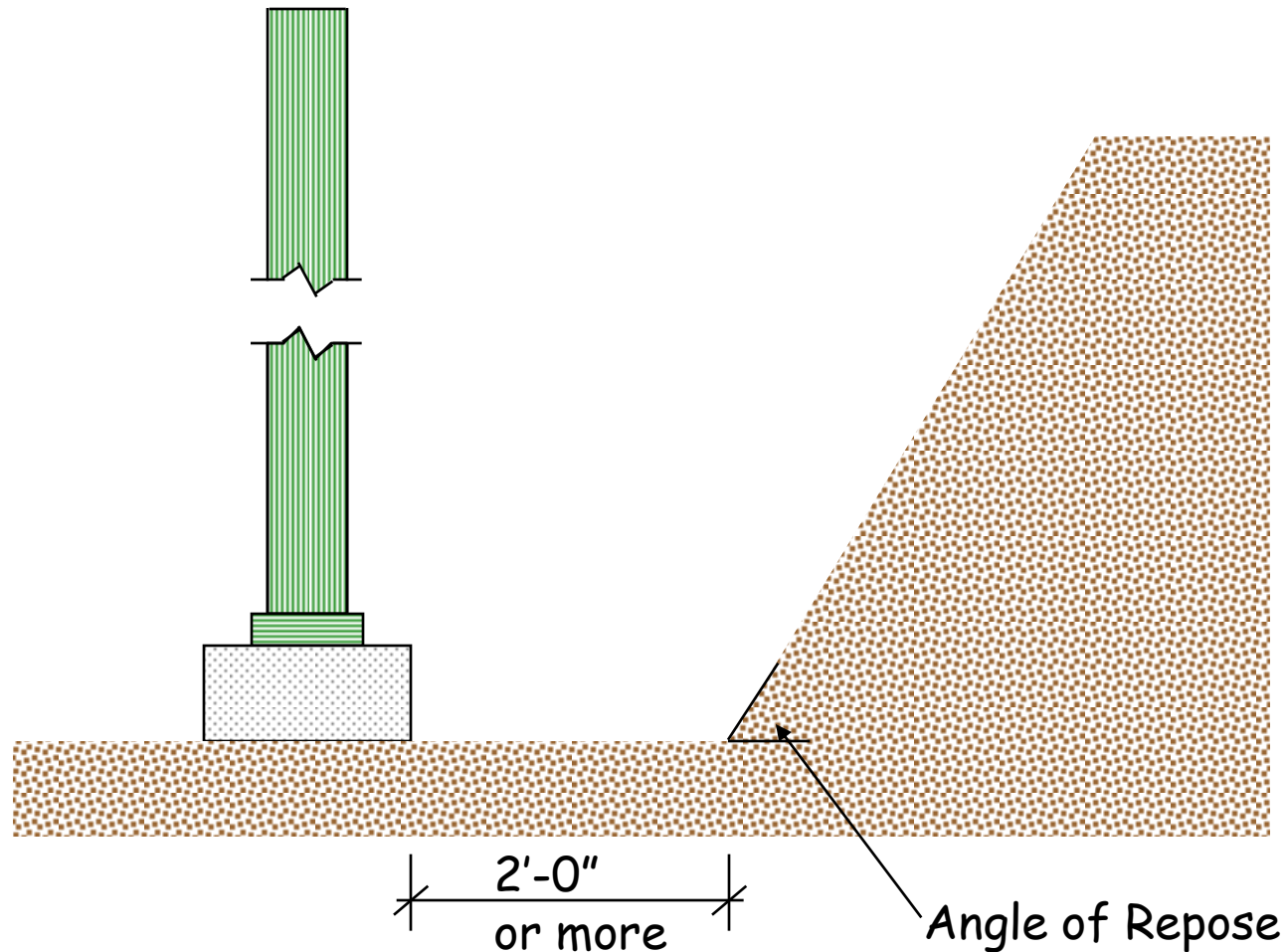

# *Approximate Angle of Repose*

For Sloping Sides of Excavation

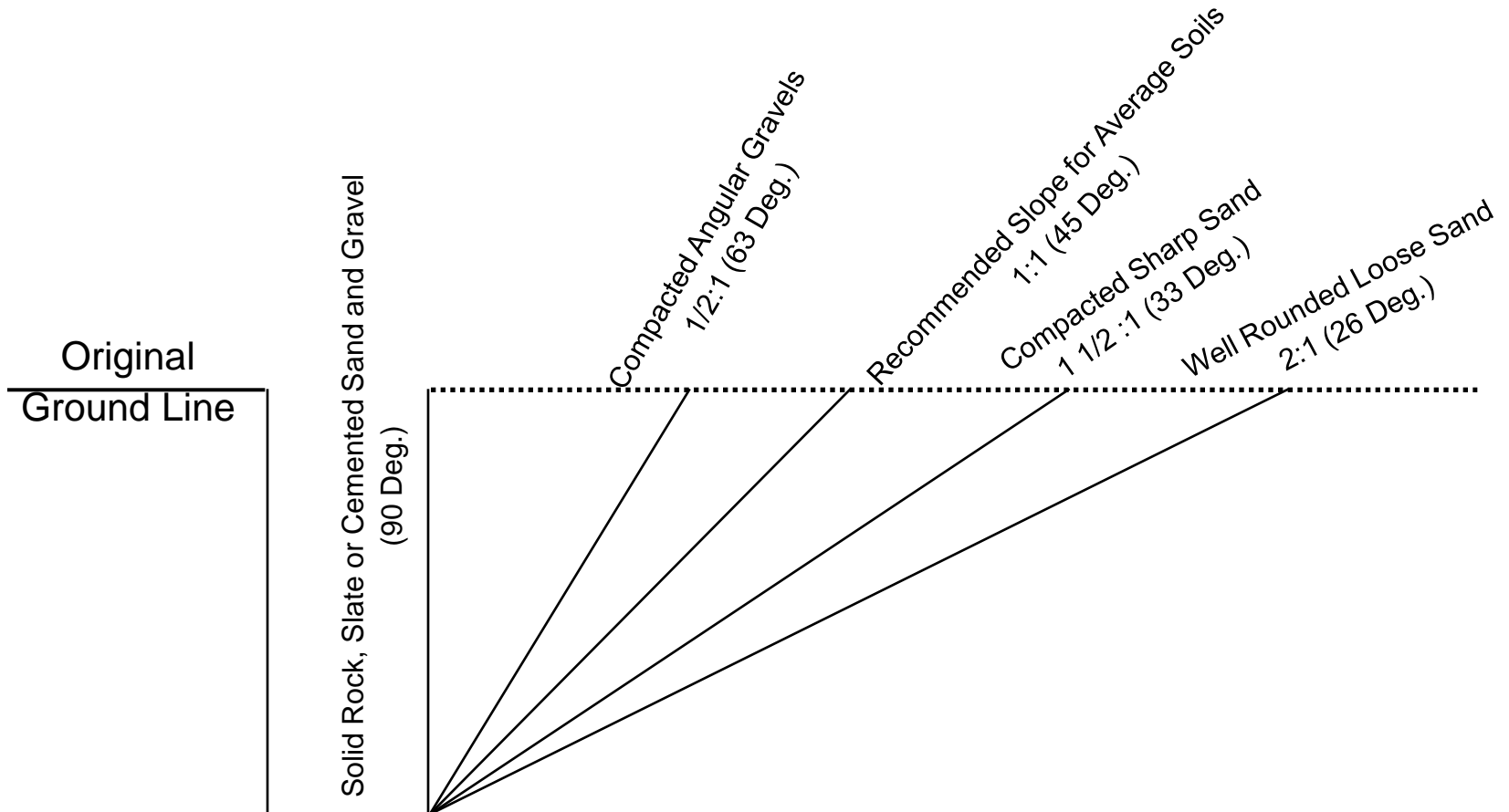

# *Calculating Earthwork Quantities*

1. End Area Method

2. Contour Line/ Grid Method

# *1. End Area Method*

👉 Used in sites where length is much greater than width



# *CALCULATING EARTHWORK QUANTITIES*

## 1. End Area Method

- a. Take cross-sections at regular intervals, typically, 100' intervals.
- b. Calculate the cross-section end areas
- c. The volume of earthwork between sections is obtained by taking the average of the end areas at each station in square feet multiplied by the distance between sections in feet and dividing by 27 to obtain the volume in cubic yards.

# Project Site Showing 100 Stations

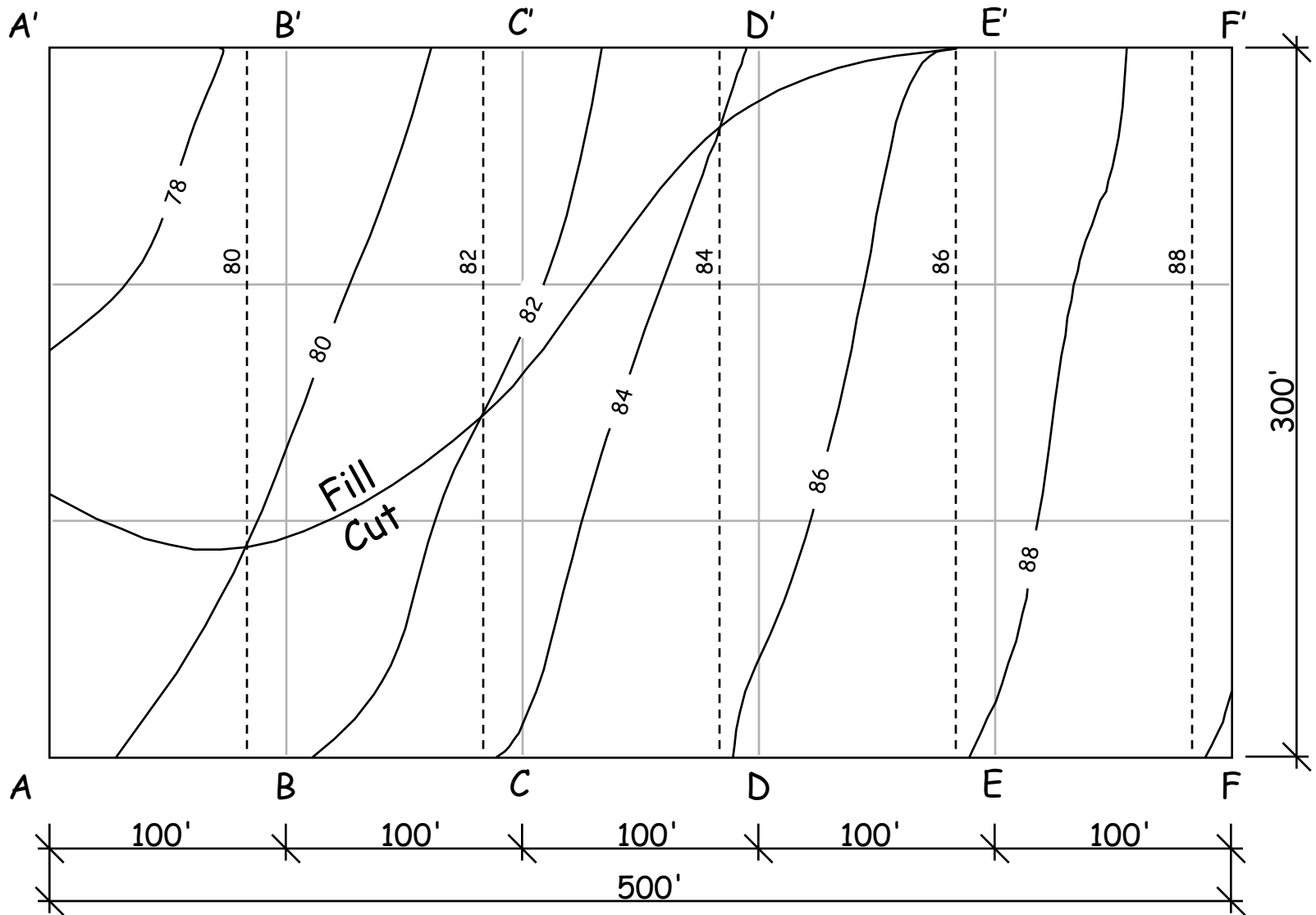

Project Cross Sections

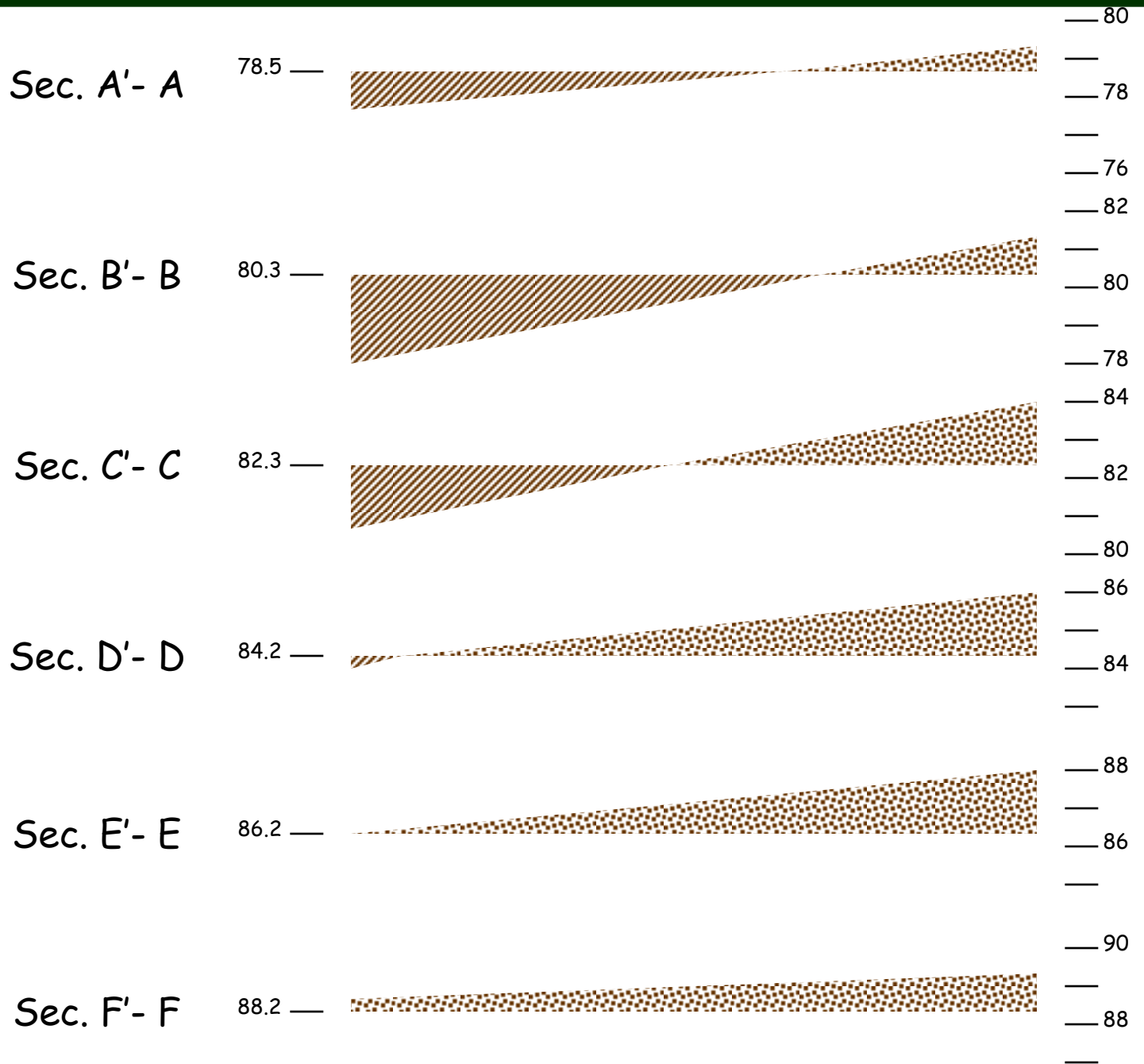

# Cross-Section @ A-A

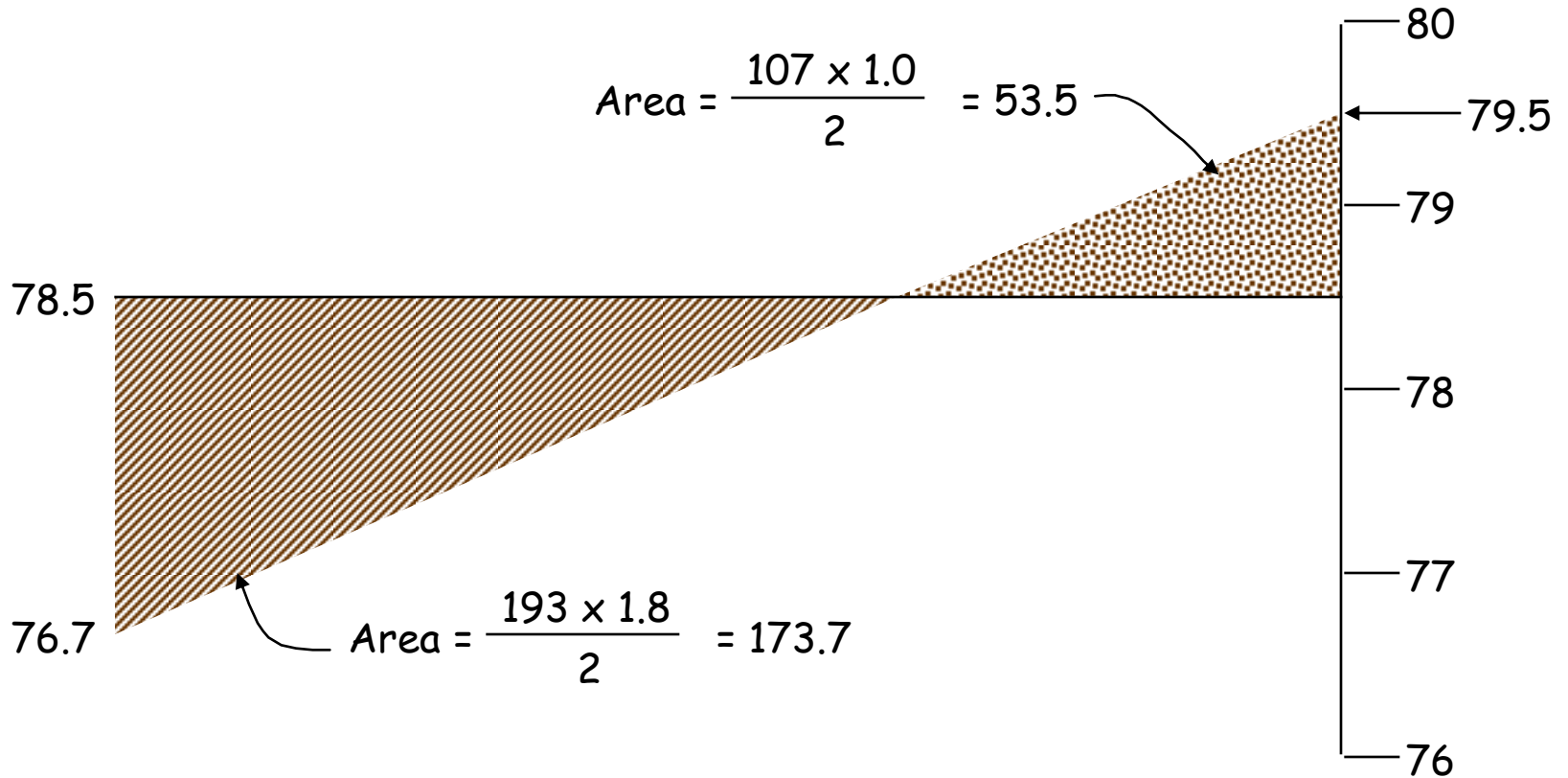

Section A'-A

# Cross-Section @ B-B

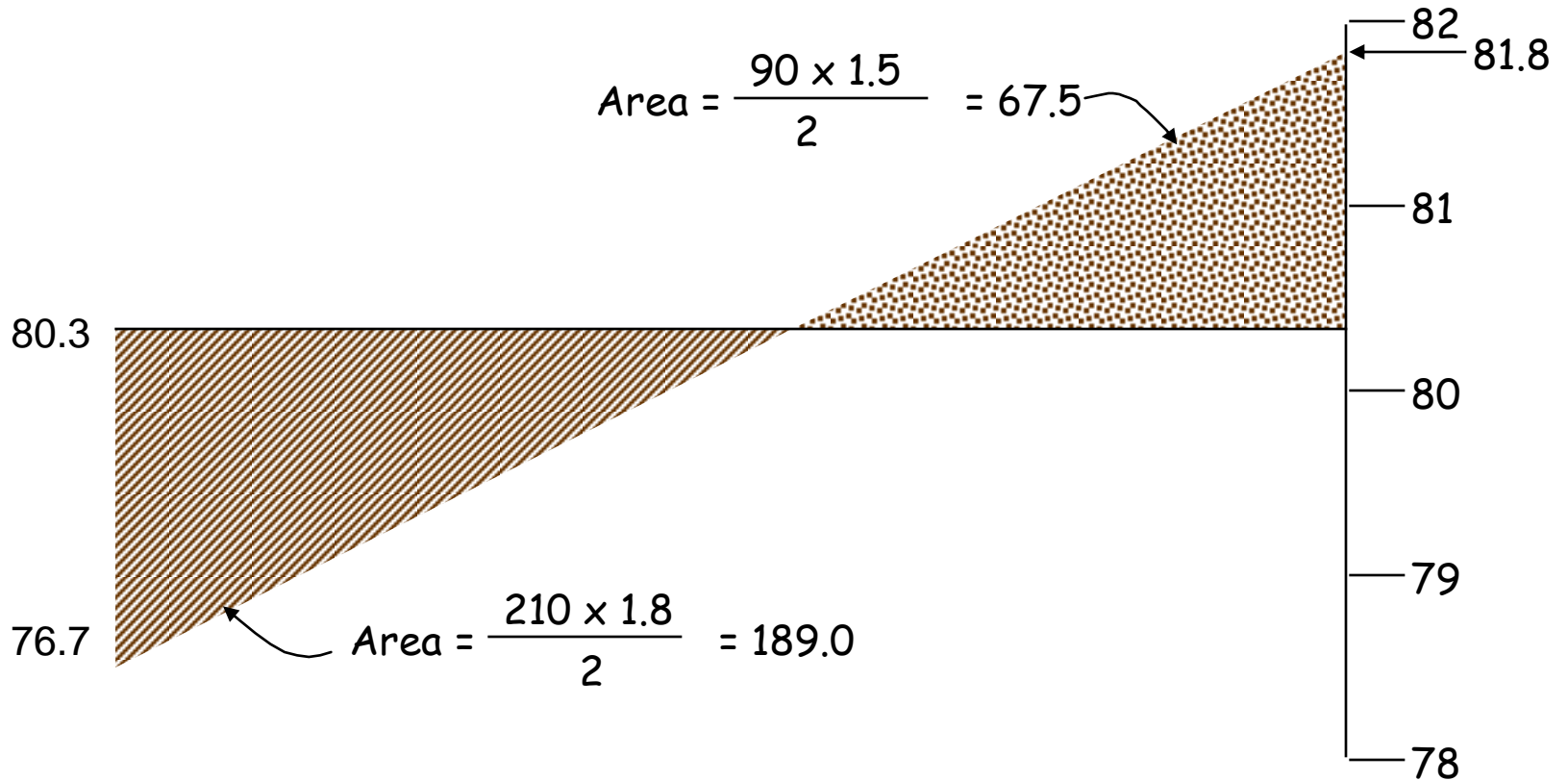

Section B'- B

# *Table 1. Cumulative Earthwork Quantities*

| Section | Emb (CCY) | Exc. (BCY) | Exc. x B/C<br>(CCY) | Net Exc.<br>(CCY) | Cum Exc<br>(CCY) |
|---------|-----------|------------|---------------------|-------------------|------------------|
| A-B     | 672       | 224        | 254                 | - 418             | - 418            |
| B-C     | 567       | 441        | 499                 | - 68              | - 486            |
| C-D     | 215       | 791        | 896                 | 681               | 195              |
| D-E     | 0         | 1031       | 1167                | 1167              | 1362             |
| E-F     | 0         | 1222       | 1384                | 1384              | 2746             |

## *2. Contour Line/ Grid Method*

- 👉 Used for parking lots and site “leveling”
- 👉 Grid size from 10'x10' to 50'x50'
- 👉 the greater the terrain variance the smaller the grid

## 2. *CONTOUR LINE/GRID CELL METHOD(cont.)*

### Step 1

Determine by visual study of the site drawing if the net total will be an import (more fill required than cut) an export (less fill required than cut) or a blend (cut and fill about equal)

### Step 2

Determine the pattern of calculation points or grid size.

### Step 3

Determine elevations at each calculation location, the corners of each grid.

### Step 4

Calculate the cubic yards of cut or fill required in each grid cell.

### Step 5

Add the individual Grid Cell quantities together to arrive at the total cut, total fill volume and the import or volume export yardage required for the job.



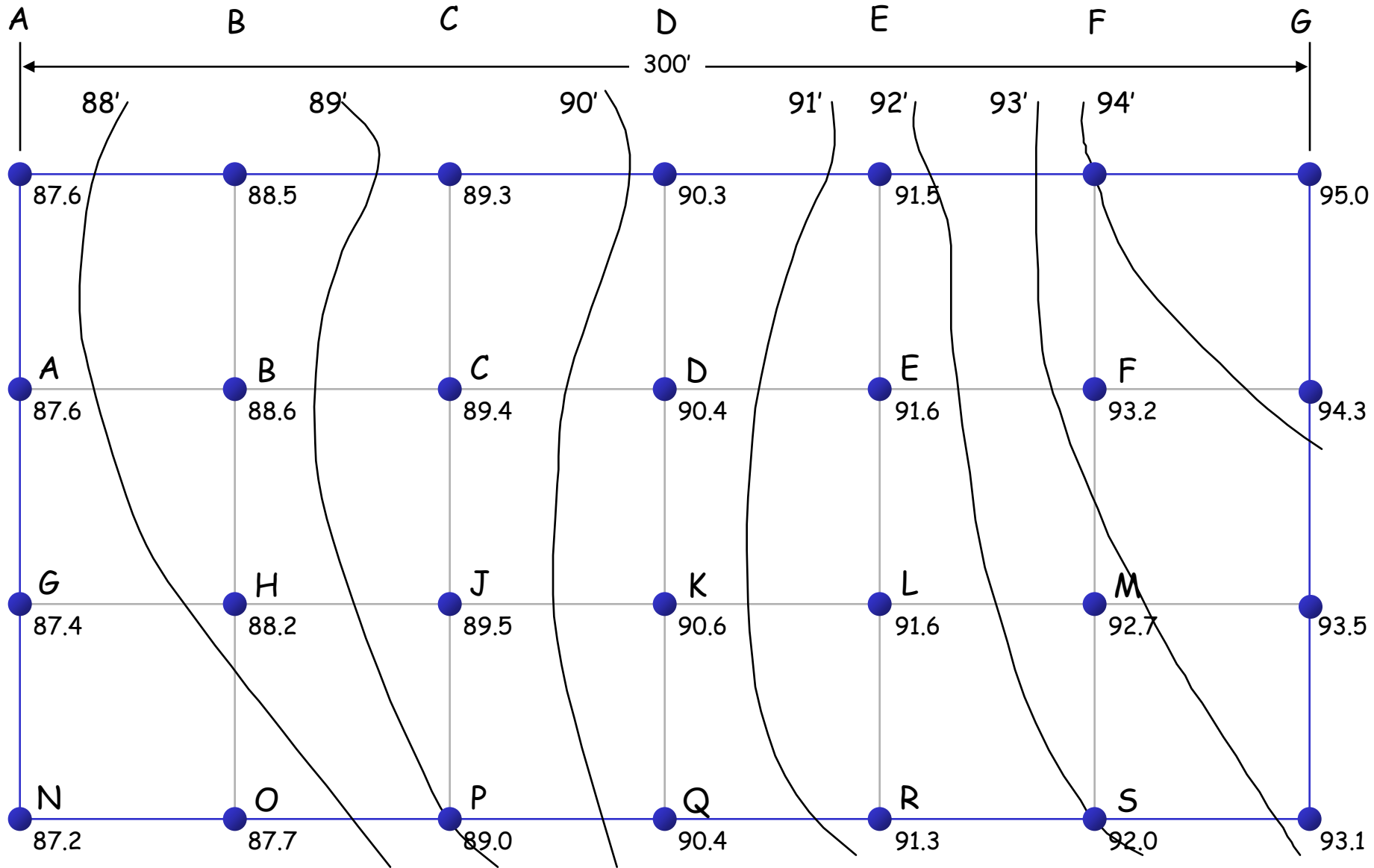

No Scale

Notes:

1. Bring the entire site to elevation 90.
2. All grids are  $50' \times 50' = 2500$  sq. ft.
3. Present contours



## Purpose

Grade the entire site to grade 90'

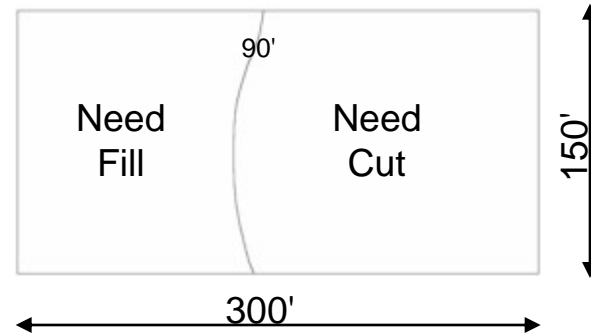

## Quick and Dirty

Assume one grid

Existing 90.50

Proposed 90.00

Cut 0.50

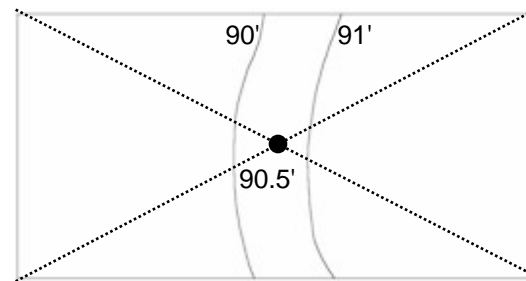

$$\text{Total Cost} = \frac{150 \times 300 \times 0.50}{27} = 833\text{CY}$$

If we choose the grid size to be 50'x50'

Average elevation

$$= \frac{87.6+88.5+87.6+88.6}{4}$$

$$= 88.08$$

change = 90-88.08

$$= 1.92$$

cut =

$$= 177.77 \text{ CY}$$

and so on.

