

ETHICON PRODUCT CATALOG

Sutures/Adhesives/Drains/Hernia Repair

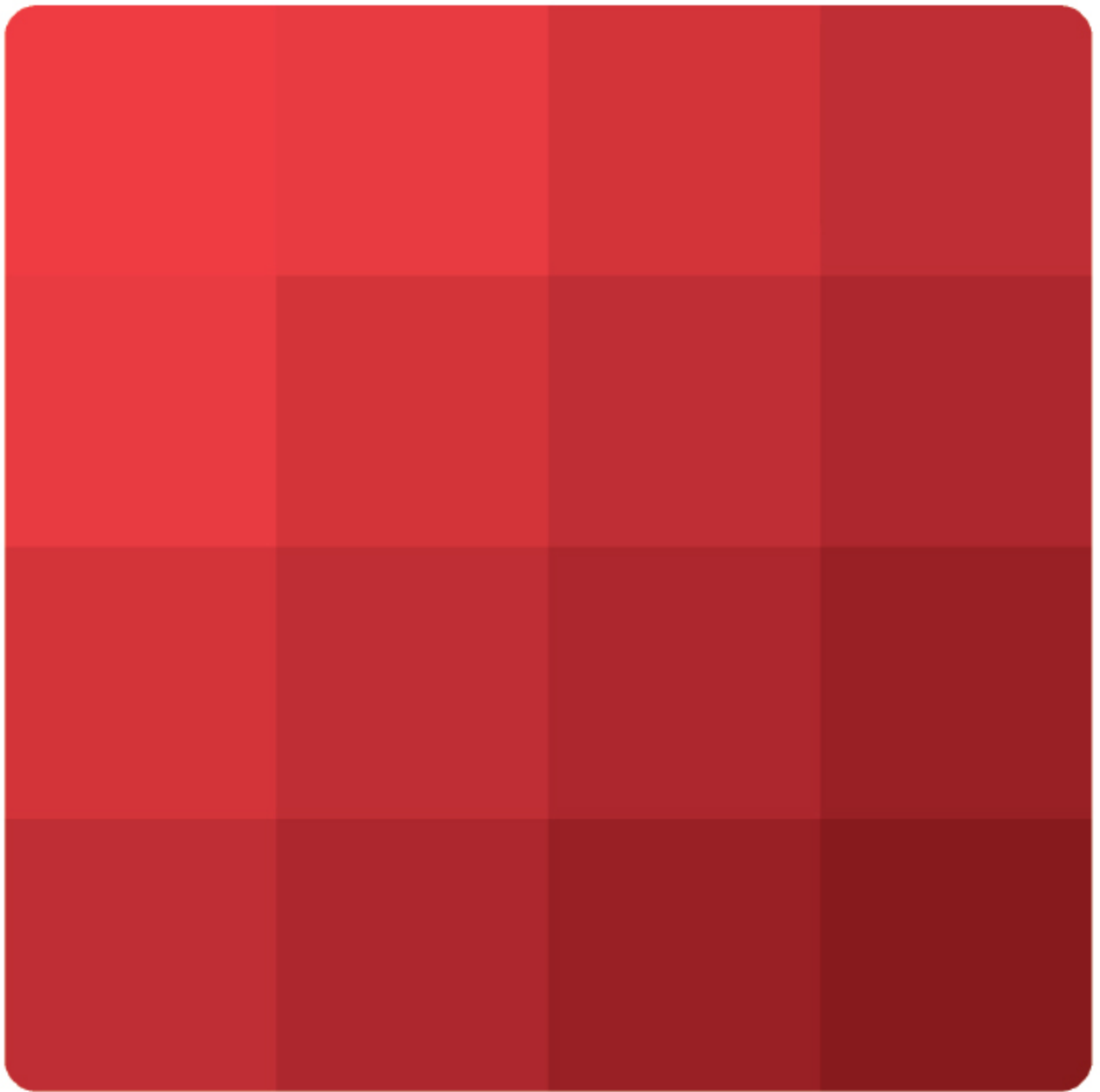

Table of Contents

General information	1
Needle Index	11
True to Scale Needle Chart	45
Sutures	47
Adhesives	238
Adhesives	239
Adhesives	240
Drains	241
Hernia Repair	244
Miscellaneous	260

Explanation of a Typical Selection And Page

ATRALOC Needle

The needle type and size/shape are shown only for needle/suture combinations. A repeated needle type (eg RB-1, RB-1) indicates a "double-armed" suture, that is, a suture with a needle attached to each end.

Needle Type/Needle Shape Symbol

Needle type and needle shape are shown in this subhead.

Material

Suture materials are designated by color and construction characteristics (eg Undyed Braided, Violet Braided, etc.)

Length

Suture length is shown in both inches and the approximate metric equivalent. Multi-strand means 3 or 8 strands per packet. These products are packaged 12, 24 or 36 packets per box.

The CR mark refers to control release needle sutures.

Product Name

Sutures and other ETHICON products are designated by trademarked and generic names.

Size

About ATRALOC Needles

ATRALOC Needles are supplied in a variety of sizes, shapes and chord lengths. Surgeons should

Suture size, denoting the diameter of the material, is in accordance with the United States Pharmacopeia (USP).

Needle Silhouette

Needle Silhouettes are shown in ACTUAL SIZE. The designated number above the needle, within the Needle Section, is the actual length measured in millimeters.

Code

Product codes ending in suffix G are packaged dozen packets to a box. Product codes ending in suffix H are packaged 3 dozen to a box. Product codes ending in suffix T are packaged 2 dozen packets to a box. In the few instances where no alphabetic suffix is in the product code, the number of packets per box is identified by a footnote. The number of strands per Multi-Strand packet appears on the left of suture length.

Needle Length

Needle length is the actual length measured in millimeters. Needle lengths can be found within the Needle Section and throughout the catalog to the right of the needle code. As a user you will find that many of these needle lengths have been rounded off. Recognize that the needles are not changing, but for consistency ETHICON has applied a rounding convention to all needle lengths. Due to timing differences, the box and label dimensions may not match the catalog exactly, but will be updated accordingly in the near future.

select the type of needle that, in their experience, is appropriate for the specific procedure and

tissue.

points or TAPERCUT* Surgical Needle tips.

Needle shapes are generally classified according to the degree of curvature of the body — 5/8, 1/2, 3/8, or 1/4

In general, the same size of needle may be made from finer gauge wire for use in soft or delicate tissues and from heavier gauge wire for use in tough or fibrosed tissues (the surgeon's choice).

circle and straight — with taper, cutting, blunt

The Major Characteristics of ATRALOC Needles are:

- They must be made from high quality stainless steel.
- They resist bending but are processed so that they will tend to bend before breaking.
- Taper points must be sharp and contoured for easy passage into tissues.
- Cutting points or edges must be sharp and free of burrs.
- On most ATRALOC Needles, a Super-Smooth finish is provided that permits the needle to penetrate and pass through with minimal resistance or drag.
- Ribbed needles — longitudinal ribs are provided on many ATRALOC Needles to increase the stability of the needle in the needleholder.
- The attachment of the needle to the suture material must be secure so that the needle will not separate from the suture material under normal use. An exception is the CONTROL RELEASE Needle suture principle, which facilitates fast separation of needle from suture when desirable.

MULTIPASS* Needles

Elements of Needle Design

Needle design involves analyzing a surgical procedure and the density of the tissue involved in great detail. ETHICON engineers work continuously to improve upon their needle line.

The anatomy of the ideal surgical needle has three key factors that make up the ideal needle. - Alloy - Geometry - tip and body - Coating

The combination of these attributes is ETHICON MULTIPASS Needle Technology.

MULTIPASS Needles are the highest performing needles that ETHICON Products offers; a combination [or a balance] of three proprietary technologies ensure excellent strength, tissue penetration and control; pass after pass.

CONTROL RELEASE Needle Sutures

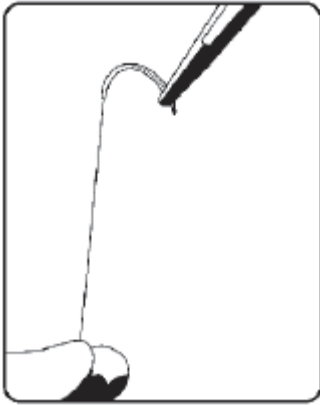

- The needle is held securely in holder. Suture is grasped securely just below needle, pulling strand taut.

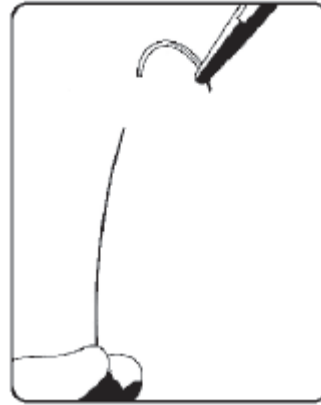

- The needle is released with a straight tug of the needleholder.

Selection and Use of Needleholders

- The needleholder must be an appropriate size instrument for the size needle selected.
- It must be made from good quality steel with a secure jaw design.



- Needles should be grasped in an area about 1/3 to 1/2 of the distance from the swaged area to the point. Avoid placement on or near the swaged area.



- The needle should be placed securely in the tip of the needleholder jaws.



- Do not damage taper points or cutting edges when using the needleholder to pull the needle out through the tissue. Grasp as far back as possible.
- When placing the needle in tissue, any force applied should be in the direction following the curve of the needle.
- Do not take excessively large bites of tissue with small needles.



- Do not force or twist the needle in an effort to bring the point out through the tissue – withdraw the needle and replace tissue.
- Do not force a dull needle through tissue – obtain a new one.
- Avoid using the needle to bridge or approximate tissues for suturing.
- If the needle is held too tightly in a sharp or hard jawed or defective needleholder, the needle may be damaged or notched in such a manner that it will have more of a tendency to bend or break on successive passes through tissue.

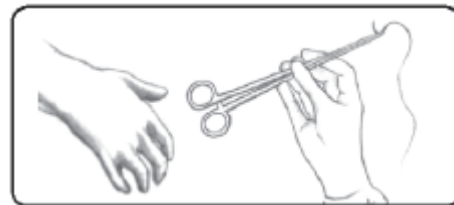

- When the needle holder with needle is passed to the surgeon, the needle should be pointing in the right direction in which it will start to be used without need for readjustments.
- In some patients, the tissues may be tougher or fibrosed more than normal and require the use of a heavier gauge needle.
- In deep confined area, ideal positioning of the needle may not be possible. The surgeon should proceed with caution or use a heavier gauge needle

An ATRALOC Needle is an instrument that complements the surgeon's skills. The variety of ETHICON needles offers the surgeon a choice of needles which are dependable for consistent quality and for practically all surgical applications.

Steps to Create Performance

Controlled Manufacturing

ETHICON makes its own needle/sutures combinations. Each step, from raw material to finished needle, is carefully controlled for uniformly superior performance.



Conventional needle

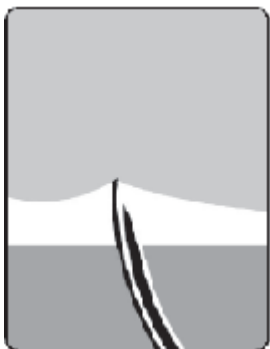

Super smooth

Strong, Sharp Micrograin Stainless Steel

ETHICON makes its needles from premium grade

stainless steel formulated specifically for surgical use.

The ETHICON process controls the orientation of the micrograins so that ductility and strength are closely controlled – for strong needles that start sharp, and stay sharp, thus assuring easy passage through tissue.

Super-Smooth

Virtually all ATRALOC Needles have a micro-thin Super-Smooth finish that permits the needle to penetrate and pass through the toughest tissue with an almost fluid-like flow, with minimal resistance and virtually no drag, giving the surgeon a feeling of control.

Needle Swaging

Needles are permanently attached to the suture materials, eliminating the need for threading and providing a new, sharp needle each time. ATRALOC Needle swaging gives the surgeon a needle with an unbroken surface from end to end; without double strands, it draws through tissue easier and with less tissue trauma.

Ribbed for Security and Control

Longitudinal ribbing on the inside and outside curvatures of most needles has a cross-locking action in the needleholder, minimizing turning, rocking or twisting and thus providing unsurpassed needle control.

Shapes

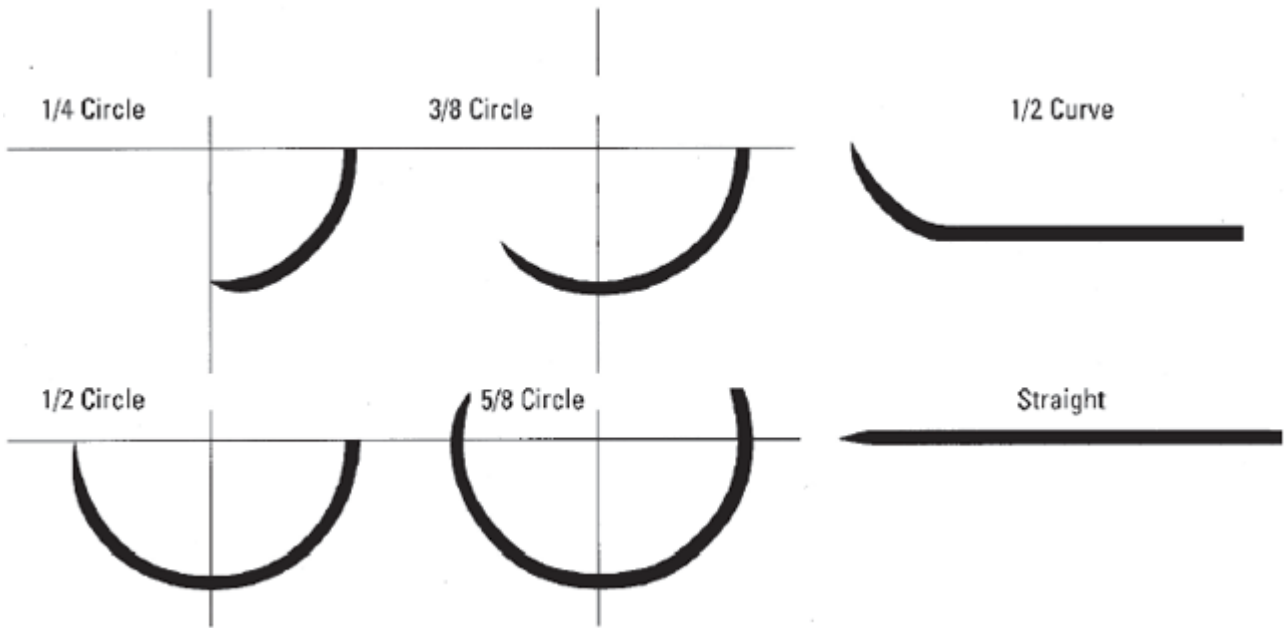

Types

Taper Point Needle

For soft, easily penetrated tissues.

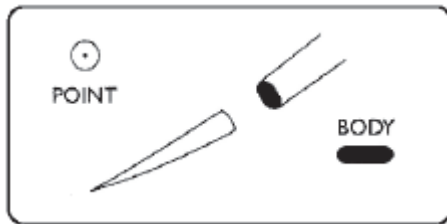

ETHIGUARD* Blunt Point Needle

Taper body. For blunt dissection and suturing friable tissue.

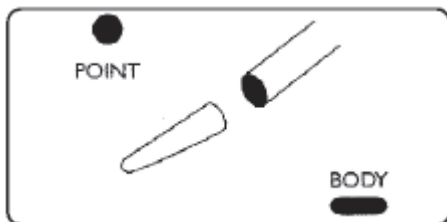

Conventional Cutting Needle

Two opposing cutting edges, with a third on inside curve. Change in cross-section from a triangle cutting tip to a flattened body.

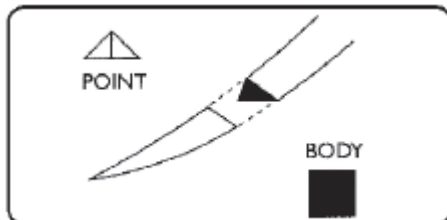

Reserve Cutting Needle

Cutting edge on outer curve. For tough, difficult-to-penetrate tissues.

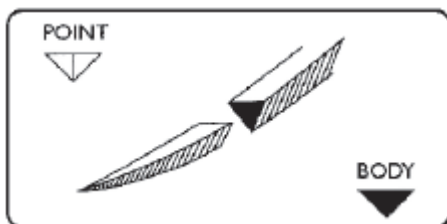

TAPERCUT* Needle

Cutting tip, taper body. For tough tissue, like two needles in one.

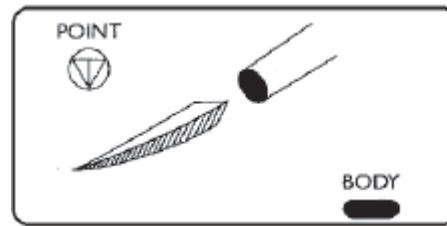

Precision Point Needle

For delicate plastic or cosmetic surgery. Cutting tip electropolished for added sharpness.

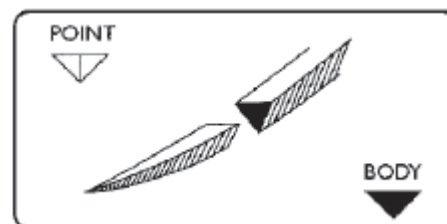

Precision Cosmetic-Conventional Cutting PRIME Needle

For delicate plastic or cosmetic surgery. Conventional cutting tip and PRIME geometry for increased sharpness.

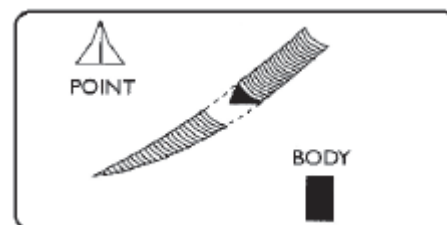

MICRO-POINT* Surgical Needle (Spatula)

Thin, flat profile. Specially designed for ophthalmic anterior segment surgery.

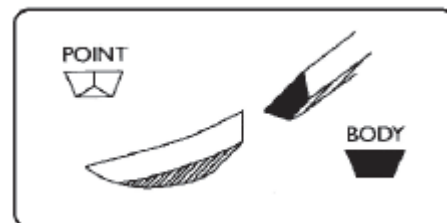

Conventional Spatula Needle

Visibility of the point at bottom provides control of depth penetration.

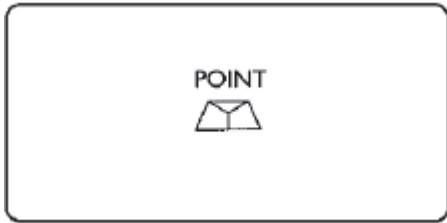

SABRELOC* Needle (Spatula)

Side-cutting spatula shaped edges. For layers of scleral or corneal tissue. Spatulated needle point is centered for maximum needle stability in thin sclera. Four equidistant and properly defined edges provide greater control.

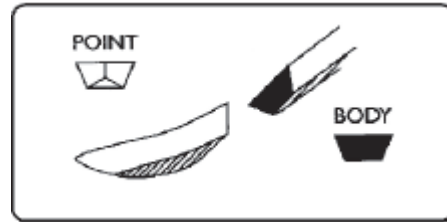

ULTIMA* Needle (Spatula)

Reduced edge-angles provide better penetration. Readily facilitates knot rotation in ophthalmic surgery.

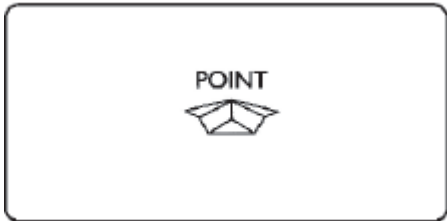

MICRO-POINT* Reverse Cutting Needle

Cutting edge on outer curve. Extremely smooth. Extremely sharp for ophthalmic surgery.

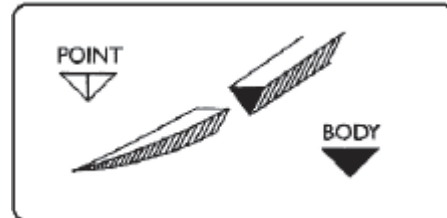

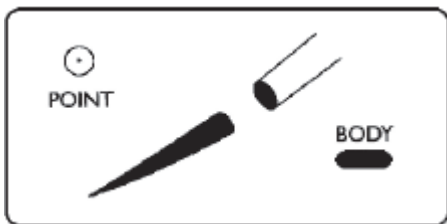

VISI-BLACK* Surgical Needle

Slim Taper point needles with a black finish for improved visibility and penetration.







Trademarks

ATRALOC Surgical Needle
 CONTROL RELEASE Needle or Needle Suture 
 CS ULTIMA Ophthalmic Needles
 DERMABOND ProPen Topical Skin Adhesive
 DERMABOND ProPen XL
 DERMABOND Topical Skin Adhesive
 ETHALLOY Needle Alloy
 ETHIBOND Extra Polyester Suture
 ETHIBOND EXCEL Polyester Suture
 ETHIGUARD Blunt Point Needle
 ETHILON Nylon Suture
 ETHI-PACK Pre-cut Sutures
 HEMO-SEAL Needle Suture 
 J-VAC Closed Wound Drainage System
 J-VAC Bulb Suction Reservoir
 J-VAC Reservoir
 J-VAC Drainage Adapter
 J-VAC Silicone Drains
 LAPRA-TY Suture Clip
 LIGAPAK Dispensing Reel
 LIGAPAK Ligature
 MERSILENE Polyester Fiber Suture
 MERSILENE Polyester Fiber Mesh
 MERSILENE Polyester Fiber Strip
 MICRO-POINT Surgical Needle
 MONOCRYL (poliglecaprone 25) Suture
 MONOCRYL Plus Antibacterial (poliglecaprone 25) Suture
 MULTIPLASS Needle
 NUROLON Nylon Suture
 PC PRIME Needle
 PDS (polydioxanone) Suture
 PDS II (polydioxanone) Suture
 PDS Plus Antibacterial (polydioxanone) Suture
 PERMA-HAND Silk Suture
 PROCEED Surgical Mesh
 PROLENE Polypropylene Hernia System
 PROLENE Polypropylene Mesh
 PROLENE Polypropylene Suture
 PROLENE 3D Patch Polypropylene Mesh
 PROLENE Soft Polypropylene Mesh
 PRONOVA Poly (Hexafluoropropylene – VDF) Suture
 PROXI-STRIP Skin Closure
 PS PRIME Needle
 PVP™ Device
 RELAY Suture Delivery System
 RELAY Suture Package
 SABRELOC Spatula Needle
 SUTUPAK Pre-cut Sterile Sutures
 TAPERCUT Surgical Needle
 ULTRAPRO Partially Absorbable Lightweight Mesh
 ULTRAPRO Hernia System
 VICRYL (polyglactin 910) Knitted Mesh
 VICRYL (polyglactin 910) Woven Mesh
 VICRYL (polyglactin 910) Mesh Bags
 VICRYL (polyglactin 910) Perirenal Mesh Bag
 VICRYL (polyglactin 910) Perisplenic Mesh Bag
 VICRYL (polyglactin 910) Perihepatic Mesh Bags
 VICRYL (polyglactin 910) Perihepatic Right Lobe Mesh Bag
 VICRYL (polyglactin 910) Perihepatic Left Lobe Mesh Bag
 Coated VICRYL (polyglactin 910) Suture
 Coated VICRYL Plus Antibacterial (polyglactin 910) Suture
 VICRYL RAPIDE (polyglactin 910) Suture
 VISI-BLACK Surgical Needle 

Blunt Point

1/2 Circle

Needles/ Avalable Products	Needle image
BP 80mm Surgical Gut Suture - Chromic	
BP 80mm BP MERSILENE Suture	
BP-1 65mm PDS Plus Suture Surgical Gut Suture - Chromic	
BP-1 65mm BP-1 MERSILENE Suture	
TPB-1 65mm Coated VICRYL Plus Suture PDS Plus Suture	

Conventional Cutting - Sternum

1/2 Circle

Needles/ Avalable Products	Needle image
CCS 48mm ETHIBOND EXCEL Suture Surgical Stainless Steel Suture	

Needles/ Avalable Products	Needle image
CCS-1 60mm Coated VICRYL Suture PDS II Suture Surgical Stainless Steel Suture	

Endoscopic Needles



Straight Taper Point

Needles/ Avalable Products	Needle image
ST-4 19mm ST-4 PDS II Suture PDS Plus Suture	
ST100-3 ETHILON Suture	

ETHIGUARD - Safety needle





1/2 Circle



Needles/ Avalable Products	Needle image
CTB 40mm Coated VICRYL Plus Suture PDS Plus Suture	
CTB-1 36mm Coated VICRYL Plus Suture Coated VICRYL Suture MONOCRYL Plus Suture MONOCRYL Suture PDS II Suture PDS Plus Suture PROLENE Suture	

Needles/ Avialable Products	Needle image
CTB-2 36mm Coated VICRYL Plus Suture Coated VICRYL Suture PDS Plus Suture	
CTX-B 48mm Coated VICRYL Plus Suture Coated VICRYL Suture MONOCRYL Suture PDS II Suture PDS Plus Suture PROLENE Suture	
SHB 26mm Coated VICRYL Plus Suture Coated VICRYL Suture MONOCRYL Plus Suture MONOCRYL Suture PDS Plus Suture	

EVERPOINT Cardiovascular Needles





3/8 Circle

Needles/ Avialable Products	Needle image
BV130-5 6.5mm BV130-5 PROLENE Suture	 EVERPOINT™ Cardiovascular Needles
BV175-6 8.0mm BV175-6 PROLENE Suture	 EVERPOINT™ Cardiovascular Needles
BV175-8 9.3mm BV175-8 PROLENE Suture	 EVERPOINT™ Cardiovascular Needles
C-1 13mm C-1 PROLENE Suture	 EVERPOINT™ Cardiovascular Needles

Needles/ Avalable Products	Needle image
C1 13mm PROLENE Suture	 EVERPOINT™ Cardiovascular Needles
CC175-8 9.3mm CC175-8 PROLENE Suture	 EVERPOINT™ Cardiovascular Needles

MICROPOINT - Spatula

1/2 Circle



Needles/ Avalable Products	Needle image
TG160-4 5.5mm TG160-4 ETHILON Suture MERSILENE Suture	
TG160-4-3M 4.3mm TG160-4-3M ETHILON Suture MERSILENE Suture	
TG160-6 5.5mm TG160-6 ETHILON Suture	
TG160-8 5.5mm TG160-8 Coated VICRYL Suture	
TG175-8 7.0mm TG175-8 ETHILON Suture	

1/4 Circle

Needles/ Avalable Products	Needle image
-------------------------------	--------------



Needles/ Avalable Products	Needle image
TG100-8 6.5mm TG100-8 Coated VICRYL Suture ETHILON Suture Surgical Gut Suture - Chromic	

3/8 Circle





Needles/ Avalable Products	Needle image
TG140-6 6.5mm TG140-6 Coated VICRYL Suture ETHILON Suture	
TG140-8 6.5mm TG140-8 Coated VICRYL Suture ETHILON Suture PERMA-HAND Suture PROLENE Suture Surgical Gut Suture - Chromic Surgical Gut Suture - Plain	
VAS100-4 5.1mm ETHILON Suture	

MICROPOINT-Reverse Cutting

1/2 Circle

Needles/ Avalable Products	Needle image
G-2 8.0mm G-2 Surgical Gut Suture - Chromic	
G-7 8.0mm G-7 PERMA-HAND Suture	

3/8 Circle



Needles/ Avalable Products	Needle image
G-1 11mm PERMA-HAND Suture Surgical Gut Suture - Chromic Surgical Gut Suture - Plain	
G-1 11mm G-1 PERMA-HAND Suture Surgical Gut Suture - Chromic Surgical Gut Suture - Plain	
G-3 13mm PERMA-HAND Suture	
G-3 13mm G-3 PERMA-HAND Suture Surgical Gut Suture - Chromic Surgical Gut Suture - Plain	
G-6 8.0mm G-6 Coated VICRYL Suture PERMA-HAND Suture Surgical Gut Suture - Chromic Surgical Gut Suture - Plain	

Precision Cosmetic - Conventional Cutting PRIME

1/2 Circle

Needles/ Avalable Products	Needle image
PC-12 16mm Coated VICRYL Suture ETHILON Suture MONOCRYL Suture	





3/8 Circle

Needles/ Avalable Products	Needle image
<p>PC-1 13mm</p> <p>Coated VICRYL Plus Suture Coated VICRYL Suture ETHILON Suture MONOCRYL Plus Suture MONOCRYL Suture NUROLON Suture PDS II Suture PDS Plus Suture PROLENE Suture Surgical Gut Suture - Plain VICRYL RAPIDE Suture</p>	
<p>PC-3 16mm</p> <p>Coated VICRYL Plus Suture Coated VICRYL Suture ETHILON Suture MONOCRYL Plus Suture MONOCRYL Suture PDS II Suture PDS Plus Suture PERMA-HAND Suture PROLENE Suture VICRYL RAPIDE Suture</p>	
<p>PC-5 19mm</p> <p>Coated VICRYL Plus Suture Coated VICRYL Suture ETHILON Suture MONOCRYL Plus Suture MONOCRYL Suture PDS II Suture PDS Plus Suture PERMA-HAND Suture PROLENE Suture</p>	

Precision Point - Reverse Cutting

1/2 Circle





Needles/ Avalable Products	Needle image
-------------------------------	--------------





Needles/ Avalable Products	Needle image
<p>P-2 8.0mm</p> <p>Coated VICRYL Plus Suture Coated VICRYL Suture PDS II Suture PDS Plus Suture Surgical Gut Suture - Chromic Surgical Gut Suture - Plain</p>	
<p>PS-4 16mm</p> <p>Coated VICRYL Plus Suture Coated VICRYL Suture ETHIBOND EXCEL Suture ETHILON Suture PDS II Suture PDS Plus Suture PERMA-HAND Suture PROLENE Suture Surgical Gut Suture - Chromic Surgical Gut Suture - Plain</p>	
<p>PS-5 13mm</p> <p>Coated VICRYL Plus Suture Coated VICRYL Suture PROLENE Suture Surgical Gut Suture - Chromic</p>	
<p>PS-6 11mm</p> <p>Coated VICRYL Plus Suture Coated VICRYL Suture MONOCRYL Suture Surgical Gut Suture - Chromic</p>	

1/2 Circle Compound Curve

Needles/ Avalable Products	Needle image
<p>PS-4C 16mm</p> <p>Coated VICRYL Plus Suture Coated VICRYL Suture Surgical Gut Suture - Chromic</p>	







3/8 Circle







Needles/ Avalable Products	Needle image
<p>P-1 11mm</p> <p>Coated VICRYL Plus Suture Coated VICRYL Suture ETHIBOND EXCEL Suture ETHILON Suture MERSILENE Suture MONOCRYL Plus Suture MONOCRYL Suture PDS II Suture PDS Plus Suture PERMA-HAND Suture PROLENE Suture Surgical Gut Suture - Plain VICRYL RAPIDE Suture</p>	
<p>P-3 13mm</p> <p>Coated VICRYL Plus Suture Coated VICRYL Suture ETHIBOND EXCEL Suture ETHILON Suture MERSILENE Suture MONOCRYL Plus Suture MONOCRYL Suture PDS II Suture PDS Plus Suture PERMA-HAND Suture PROLENE Suture Surgical Gut Suture - Chromic Surgical Gut Suture - Plain VICRYL RAPIDE Suture</p>	
<p>P-6 8.0mm</p> <p>ETHILON Suture PROLENE Suture</p>	
<p>PS 26mm</p> <p>ETHILON Suture PERMA-HAND Suture Surgical Gut Suture - Chromic</p>	

Needles/ Avialable Products	Needle image
<p>PS-1 24mm</p> <p>Coated VICRYL Plus Suture Coated VICRYL Suture ETHILON Suture MONOCRYL Plus Suture MONOCRYL Suture PDS II Suture PDS Plus Suture PERMA-HAND Suture PROLENE Suture Surgical Gut Suture - Plain VICRYL RAPIDE Suture</p>	
<p>PS-2 19mm</p> <p>Coated VICRYL Plus Suture Coated VICRYL Suture ETHIBOND EXCEL Suture ETHILON Suture MONOCRYL Plus Suture MONOCRYL Suture PDS II Suture PDS Plus Suture PERMA-HAND Suture PROLENE Suture Surgical Gut Suture - Chromic Surgical Gut Suture - Plain VICRYL RAPIDE Suture</p>	
<p>PS-3 16mm</p> <p>Coated VICRYL Plus Suture Coated VICRYL Suture ETHIBOND EXCEL Suture ETHILON Suture PERMA-HAND Suture PROLENE Suture Surgical Gut Suture - Chromic Surgical Gut Suture - Plain</p>	
<p>PSL 30mm</p> <p>Coated VICRYL Plus Suture Coated VICRYL Suture ETHILON Suture PERMA-HAND Suture Surgical Gut Suture - Chromic</p>	
<p>PSLX 40mm</p> <p>ETHILON Suture PERMA-HAND Suture</p>	

Reverse Cutting





1/2 Circle







Needles/ Avialable Products	Needle image
CP 40mm Coated VICRYL Plus Suture Coated VICRYL Suture NUROLON Suture PDS II Suture Surgical Gut Suture - Chromic	
CP-1 36mm Coated VICRYL Plus Suture Coated VICRYL Suture MONOCRYL Plus Suture MONOCRYL Suture PDS II Suture PDS Plus Suture PERMA-HAND Suture Surgical Gut Suture - Chromic Surgical Gut Suture - Plain Surgical Stainless Steel Suture	
CP-2 26mm Coated VICRYL Plus Suture Coated VICRYL Suture NUROLON Suture PDS II Suture PDS Plus Suture Surgical Gut Suture - Chromic	
CPX 48mm Coated VICRYL Plus Suture Coated VICRYL Suture PDS II Suture PDS Plus Suture	
J-1 17mm Coated VICRYL Suture PERMA-HAND Suture Surgical Gut Suture - Chromic	
M-1 13mm PERMA-HAND Suture Surgical Gut Suture - Plain	

Needles/ Avalable Products	Needle image
M-1 13mm M-1 Surgical Gut Suture - Chromic	
OS-2 17mm Coated VICRYL Suture ETHIBOND EXCEL Suture	
OS-4 22mm Coated VICRYL Plus Suture Coated VICRYL Suture ETHIBOND EXCEL Suture PDS II Suture PDS Plus Suture	
OS-6 36mm Coated VICRYL Plus Suture Coated VICRYL Suture ETHIBOND EXCEL Suture PDS II Suture PDS Plus Suture	
OS-8 40mm Coated VICRYL Plus Suture Coated VICRYL Suture ETHIBOND EXCEL Suture NUROLON Suture	
X-1 22mm Coated VICRYL Plus Suture Coated VICRYL Suture ETHILON Suture NUROLON Suture PERMA-HAND Suture Surgical Gut Suture - Plain	

3/8 Circle

Needles/ Avalable Products	Needle image
C-2 13mm ETHILON Suture	

Needles/ Avalable Products	Needle image
<p>C-2 13mm C-2 PERMA-HAND Suture</p>	
<p>C-3 13mm Coated VICRYL Suture ETHILON Suture PERMA-HAND Suture</p>	
<p>C-3 13mm C-3 PERMA-HAND Suture Surgical Gut Suture - Chromic</p>	
<p>FS 26mm Coated VICRYL Plus Suture Coated VICRYL Suture ETHIBOND EXCEL Suture ETHILON Suture MERSILENE Suture NUROLON Suture PERMA-HAND Suture PROLENE Suture</p>	
<p>FS-1 24mm Coated VICRYL Plus Suture Coated VICRYL Suture ETHIBOND EXCEL Suture ETHILON Suture MERSILENE Suture PDS II Suture PDS Plus Suture PERMA-HAND Suture PROLENE Suture Surgical Gut Suture - Chromic Surgical Gut Suture - Plain Surgical Stainless Steel Suture</p>	

Needles/ Avialable Products	Needle image
<p>FS-2 19mm</p> <p>Coated VICRYL Plus Suture Coated VICRYL Suture ETHIBOND EXCEL Suture ETHILON Suture MERSILENE Suture PDS II Suture PDS Plus Suture PERMA-HAND Suture PROLENE Suture Surgical Gut Suture - Chromic Surgical Gut Suture - Plain Surgical Stainless Steel Suture</p>	
<p>FSL 30mm</p> <p>Coated VICRYL Plus Suture Coated VICRYL Suture ETHILON Suture NUROLON Suture PERMA-HAND Suture PROLENE Suture Surgical Gut Suture - Chromic Surgical Stainless Steel Suture</p>	
<p>FSLX 40mm</p> <p>ETHILON Suture PERMA-HAND Suture PROLENE Suture Surgical Stainless Steel Suture</p>	
<p>LR 75mm</p> <p>ETHIBOND EXCEL Suture ETHILON Suture PROLENE Suture</p>	
<p>LR 75mm LR</p> <p>ETHIBOND EXCEL Suture ETHILON Suture MERSILENE Suture PERMA-HAND Suture Surgical Stainless Steel Suture</p>	
<p>LS-1 45mm</p> <p>Surgical Stainless Steel Suture</p>	
<p>M-2 13mm</p> <p>Surgical Gut Suture - Chromic</p>	

Needles/ Avialable Products	Needle image
M-2 13mm M-2 Surgical Gut Suture - Chromic	

SABRELOC - Center Point Spatula

1/4 Circle

Needles/ Avialable Products	Needle image
RD-1 8.0mm RD-1 Coated VICRYL Suture ETHILON Suture MERSILENE Suture	

SABRELOC - Conventional Spatula

1/2 Circle

Needles/ Avialable Products	Needle image
S-28 8.0mm S-28 Coated VICRYL Suture	



1/4 Circle

Needles/ Avialable Products	Needle image
S-29 8.0mm S-29 Coated VICRYL Suture	



Needles/ Avialable Products	Needle image
S-4 8.0mm S-4 MERSILENE Suture Surgical Gut Suture - Chromic	

SABRELOC - Spatula

1/2 Circle

Needles/ Avialable Products	Needle image
S-2 8.0mm S-2 MERSILENE Suture Surgical Gut Suture - Chromic	
S-22 8.0mm S-22 ETHILON Suture	

1/4 Circle

Needles/ Avialable Products	Needle image
S-14 8.0mm S-14 Coated VICRYL Suture MERSILENE Suture PERMA-HAND Suture Surgical Gut Suture - Chromic Surgical Gut Suture - Plain	
S-24 8.0mm S-24 Coated VICRYL Suture ETHILON Suture MERSILENE Suture	

1/8 Circle

Needles/ Avialable Products	Needle image
SM-1 5.5mm SM-1 PROLENE Suture	

SABRELOC - Straight Transchamber





Straight Straight

Needles/ Avialable Products	Needle image
STC-6 16mm STC-6 16mm PROLENE Suture	

Straight Cutting Needles

Straight

Needles/ Avialable Products	Needle image
KS 60mm Coated VICRYL Plus Suture Coated VICRYL Suture ETHIBOND EXCEL Suture ETHILON Suture MONOCRYL Plus Suture MONOCRYL Suture PDS II Suture PDS Plus Suture PERMA-HAND Suture PROLENE Suture Surgical Gut Suture - Chromic Surgical Gut Suture - Plain Surgical Stainless Steel Suture	

Needles/ Avalable Products	Needle image
SC-1 13mm Surgical Gut Suture - Plain	
SC-1 13mm SC-1 Surgical Gut Suture - Plain	
TS 48mm PERMA-HAND Suture	
TS 48mm TS PROLENE Suture	

Straight Taper Point

Straight

Needles/ Avalable Products	Needle image
ST-1 45mm PERMA-HAND Suture	

Straight Straight

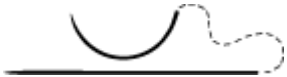
Needles/ Avalable Products	Needle image
ST-1 45mm SH 26mm Surgical Gut Suture - Chromic	



Straight TAPERCUT

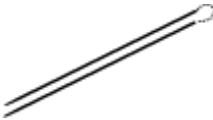

Straight







Needles/ Avalable Products	Needle image
V-47 40mm V-47 PROLENE Suture	





Taper Point





1/2 Circle







Needles/ Avalable Products	Needle image
BVH100-3 4.8mm ETHILON Suture	
CT 40mm Coated VICRYL Plus Suture Coated VICRYL Suture ETHILON Suture MONOCRYL Plus Suture MONOCRYL Suture PDS II Suture PDS Plus Suture PROLENE Suture Surgical Gut Suture - Chromic Surgical Gut Suture - Plain VICRYL RAPIDE Suture	
CT 40mm CT Surgical Gut Suture - Chromic	

<p>Needles/ Avialable Products</p>	<p>Needle image</p>
<p>CT-1 36mm</p> <p>Coated VICRYL Plus Suture Coated VICRYL Suture ETHIBOND EXCEL Suture MERSILENE Suture MONOCRYL Plus Suture MONOCRYL Suture NUROLON Suture PDS II Suture PDS Plus Suture PERMA-HAND Suture PROLENE Suture Surgical Gut Suture - Chromic Surgical Gut Suture - Plain Surgical Stainless Steel Suture VICRYL RAPIDE Suture</p>	
<p>CT-2 26mm</p> <p>Coated VICRYL Plus Suture Coated VICRYL Suture ETHIBOND EXCEL Suture MONOCRYL Plus Suture MONOCRYL Suture NUROLON Suture PDS II Suture PDS Plus Suture PERMA-HAND Suture PROLENE Suture Surgical Gut Suture - Chromic</p>	
<p>CT-3 22mm</p> <p>Coated VICRYL Plus Suture Coated VICRYL Suture PERMA-HAND Suture Surgical Gut Suture - Chromic Surgical Gut Suture - Plain</p>	









Needles/ Avaliable Products	Needle image
<p>CTX 48mm</p> <p>Coated VICRYL Plus Suture Coated VICRYL Suture ETHIBOND EXCEL Suture ETHILON Suture MONOCRYL Suture NUROLON Suture PDS II Suture PDS Plus Suture PROLENE Suture Surgical Gut Suture - Chromic Surgical Gut Suture - Plain Surgical Stainless Steel Suture VICRYL RAPIDE Suture</p>	
<p>CTX 48mm CTX</p> <p>MERSILENE Suture</p>	
<p>MH 36mm MH</p> <p>ETHIBOND EXCEL Suture PROLENE Suture PRONOVA Suture</p>	
<p>MO-2 40mm</p> <p>Surgical Gut Suture - Chromic</p>	
<p>MO-4 36mm</p> <p>Coated VICRYL Plus Suture Coated VICRYL Suture MERSILENE Suture MONOCRYL Suture Surgical Gut Suture - Chromic</p>	
<p>MO-5 31mm</p> <p>Coated VICRYL Plus Suture Coated VICRYL Suture MONOCRYL Suture Surgical Gut Suture - Chromic</p>	
<p>MO-6 26mm</p> <p>Coated VICRYL Plus Suture Coated VICRYL Suture ETHIBOND EXCEL Suture NUROLON Suture PERMA-HAND Suture PROLENE Suture</p>	











Needles/ Avialable Products	Needle image
MO-7 22mm ETHIBOND EXCEL Suture NUROLON Suture PERMA-HAND Suture PROLENE Suture	
RB-1 17mm Coated VICRYL Plus Suture Coated VICRYL Suture ETHIBOND EXCEL Suture MONOCRYL Plus Suture MONOCRYL Suture NUROLON Suture PDS II Suture PDS Plus Suture PERMA-HAND Suture PROLENE Suture Surgical Gut Suture - Chromic Surgical Gut Suture - Plain VICRYL RAPIDE Suture	
RB-1 17mm RB-1 ETHIBOND EXCEL Suture PDS II Suture PDS Plus Suture PERMA-HAND Suture PROLENE Suture PRONOVA Suture	
RB-2 13mm RB-2 PDS II Suture PDS Plus Suture PROLENE Suture PRONOVA Suture	
RB-3 11mm RB-3 PROLENE Suture	

<p>Needles/ Avalable Products</p>	<p>Needle image</p>
<p>SH 26mm</p> <p>Coated VICRYL Plus Suture Coated VICRYL Suture ETHIBOND EXCEL Suture MERSILENE Suture MONOCRYL Plus Suture MONOCRYL Suture NUROLON Suture PDS II Suture PDS Plus Suture PERMA-HAND Suture PROLENE Suture Surgical Gut Suture - Chromic Surgical Gut Suture - Plain VICRYL RAPIDE Suture</p>	
<p>SH 26mm SH</p> <p>Coated VICRYL Plus Suture Coated VICRYL Suture ETHIBOND EXCEL Suture MONOCRYL Suture PERMA-HAND Suture PROLENE Suture PRONOVA Suture Surgical Gut Suture - Chromic</p>	
<p>SH-1 22mm</p> <p>Coated VICRYL Plus Suture Coated VICRYL Suture MONOCRYL Suture NUROLON Suture PDS II Suture PDS Plus Suture PERMA-HAND Suture Surgical Gut Suture - Chromic</p>	
<p>SH-1 22mm SH-1</p> <p>ETHIBOND EXCEL Suture PROLENE Suture PRONOVA Suture</p>	
<p>SH-2 20mm SH-2</p> <p>ETHIBOND EXCEL Suture</p>	

Needles/ Avalable Products	Needle image
<p>TF 13mm</p> <p>Coated VICRYL Plus Suture Coated VICRYL Suture MONOCRYL Suture NUROLON Suture PDS II Suture PDS Plus Suture PERMA-HAND Suture</p>	
<p>TF 13mm TF</p> <p>ETHIBOND EXCEL Suture PROLENE Suture PRONOVA Suture</p>	
<p>TF-4 8.0mm</p> <p>PERMA-HAND Suture</p>	
<p>TP-1 65mm</p> <p>Coated VICRYL Plus Suture Coated VICRYL Suture ETHILON Suture PDS II Suture PDS Plus Suture PROLENE Suture Surgical Gut Suture - Chromic</p>	
<p>UCL 14mm</p> <p>ETHIBOND EXCEL Suture PDS II Suture PDS Plus Suture</p>	
<p>XLH 70mm</p> <p>Coated VICRYL Plus Suture Coated VICRYL Suture PDS II Suture PDS Plus Suture PROLENE Suture Surgical Gut Suture - Chromic Surgical Gut Suture - Plain</p>	
<p>XLH 70mm XLH</p> <p>ETHIBOND EXCEL Suture PROLENE Suture</p>	



3/8 Circle

Needles/ Avialable Products	Needle image
BB 17mm ETHIBOND EXCEL Suture PERMA-HAND Suture PROLENE Suture Surgical Gut Suture - Chromic	
BB 17mm BB ETHIBOND EXCEL Suture PERMA-HAND Suture PROLENE Suture PRONOVA Suture	
BV 11mm BV PDS II Suture PDS Plus Suture PROLENE Suture PRONOVA Suture	
BV-1 9.3mm PERMA-HAND Suture	
BV-1 9.3mm BV-1 ETHIBOND EXCEL Suture PDS II Suture PDS Plus Suture PERMA-HAND Suture PROLENE Suture PRONOVA Suture	
BV100-3 3.9mm Coated VICRYL Suture ETHILON Suture PROLENE Suture	
BV100-4 5.1mm ETHILON Suture PROLENE Suture	
BV130-3 3.8mm ETHILON Suture	

Needles/ Avalable Products	Needle image
BV130-4 5.0mm Coated VICRYL Suture ETHILON Suture	
BV130-5 6.5mm Coated VICRYL Suture ETHILON Suture PROLENE Suture	
BV130-5 6.5mm BV130-5 ETHILON Suture PROLENE Suture PRONOVA Suture	
BV175-6 8.0mm BV175-6 PROLENE Suture PRONOVA Suture	
BV175-7 8.0mm BV175-7 PROLENE Suture PRONOVA Suture	
BV175-8 9.3mm BV175-8 PROLENE Suture PRONOVA Suture	
BV50-3 4.1mm ETHILON Suture	
BV75-3 3.8mm ETHILON Suture PROLENE Suture	
BV75-4 5.1mm ETHILON Suture	
C-1 13mm ETHIBOND EXCEL Suture PERMA-HAND Suture PROLENE Suture Surgical Gut Suture - Chromic	

Needles/ Avalable Products	Needle image
<p>C-1 13mm C-1</p> <p>ETHIBOND EXCEL Suture PDS II Suture PDS Plus Suture PERMA-HAND Suture PROLENE Suture PRONOVA Suture</p>	



5/8 Circle

Needles/ Avalable Products	Needle image
<p>UR-4 40mm</p> <p>Coated VICRYL Suture Surgical Gut Suture - Chromic</p>	
<p>UR-5 36mm</p> <p>Coated VICRYL Plus Suture Coated VICRYL Suture MONOCRYL Plus Suture MONOCRYL Suture Surgical Gut Suture - Chromic</p>	
<p>UR-6 26mm</p> <p>Coated VICRYL Plus Suture Coated VICRYL Suture MONOCRYL Plus Suture MONOCRYL Suture Surgical Gut Suture - Chromic Surgical Gut Suture - Plain</p>	

Taper Point - Reverse Cutting

1/2 Circle 1/2 Circle

Needles/ Avalable Products	Needle image

Needles/ Avalable Products	Needle image
CT 40mm FSL 30mm Coated VICRYL Plus Suture Coated VICRYL Suture Surgical Gut Suture - Chromic	
CT-1 36mm CP-1 36mm Coated VICRYL Plus Suture Coated VICRYL Suture MONOCRYL Suture Surgical Gut Suture - Chromic VICRYL RAPIDE Suture	

TAPERCUT - Straight Cutting

3/8 Circle







Needles/ Avalable Products	Needle image
V-26 26mm Surgical Stainless Steel Suture	

TS Straight





Needles/ Avalable Products	Needle image
TS_TS 48mm Surgical Stainless Steel Suture	

TAPERCUT



1/2 Circle



Needles/ Avialable Products	Needle image
V-34 36mm Coated VICRYL Plus Suture Coated VICRYL Suture ETHIBOND EXCEL Suture MONOCRYL Suture PROLENE Suture Surgical Gut Suture - Chromic Surgical Gut Suture - Plain VICRYL RAPIDE Suture	
V-37 40mm ETHIBOND EXCEL Suture Surgical Stainless Steel Suture	
V-40 48mm ETHIBOND EXCEL Suture Surgical Stainless Steel Suture	
V-5 17mm ETHIBOND EXCEL Suture PERMA-HAND Suture Surgical Gut Suture - Chromic	
V-5 17mm V-5 ETHIBOND EXCEL Suture PDS II Suture PDS Plus Suture PROLENE Suture	
V-56 60mm Surgical Stainless Steel Suture	
V-7 26mm ETHIBOND EXCEL Suture PERMA-HAND Suture Surgical Gut Suture - Plain	
V-7 26mm V-7 ETHIBOND EXCEL Suture PROLENE Suture PRONOVA Suture	

1/4 Circle

Needles/ Avialable Products	Needle image
CIF-4 13mm CIF-4 PROLENE Suture	
V100-3 3.5mm ETHILON Suture	
V130-3 3.8mm ETHILON Suture	
V130-4 4.2mm Coated VICRYL Suture	
V130-5 6.5mm Coated VICRYL Suture	
V75-3 3.5mm ETHILON Suture	



3/8 Circle

Needles/ Avialable Products	Needle image
CC 9.3mm CC PROLENE Suture PRONOVA Suture	
CC-1 13mm PERMA-HAND Suture	
CC-1 13mm CC-1 ETHIBOND EXCEL Suture PROLENE Suture PRONOVA Suture	



Needles/ Avalable Products	Needle image
V-4 17mm ETHIBOND EXCEL Suture PERMA-HAND Suture	
V-4 17mm V-4 ETHIBOND EXCEL Suture PROLENE Suture	

Temporary Pacing Wire

1/2 Circle Straight Cutting

Needles/ Avalable Products	Needle image
RB-1 17mm SKS 60mm Surgical Stainless Steel Suture	
SH 26mm SKS-3 90mm Surgical Stainless Steel Suture	

3/8 Circle 3/8 Circle

Needles/ Avalable Products	Needle image
BB 17mm SKS 60mm Surgical Stainless Steel Suture	
BB-1 22mm SKS-3 90mm Surgical Stainless Steel Suture	
TE 31mm SKS-3 90mm Surgical Stainless Steel Suture	





Trocar Point

Straight

Needles/ Avialable Products	Needle image
STP-10 254mm STP-10 ETHIBOND EXCEL Suture PDS II Suture	

ULTIMA - Spatula



1/2 Circle

Needles/ Avialable Products	Needle image
CS160-6 5.5mm ETHILON Suture	
CS160-6 5.5mm CS160-6 Coated VICRYL Suture ETHILON Suture MERSILENE Suture PROLENE Suture	
CS160-8 5.5mm CS160-8 Coated VICRYL Suture ETHILON Suture PROLENE Suture	
CS175-6 7.0mm CS175-6 ETHILON Suture	
CS175-8 7.0mm CS175-8 ETHILON Suture Surgical Gut Suture - Chromic	

1/2 Circle 1/2 Circle

Needles/ Avialable Products	Needle image
CS160-6 5.5mm CTC-6 13mm PROLENE Suture	

1/4 Circle



Needles/ Avialable Products	Needle image
CS90-6 7.0mm Coated VICRYL Suture	
CTC-6L 13mm CTC-6L PROLENE Suture	

1/8 Circle



Needles/ Avialable Products	Needle image
CS44-6 5.5mm ETHILON Suture	

3/8 Circle

Needles/ Avialable Products	Needle image
CS140-6 6.5mm Coated VICRYL Suture ETHILON Suture	

Needles/ Avalable Products	Needle image
CS140-6 6.5mm CS140-6 ETHILON Suture MERSILENE Suture PROLENE Suture	
CS140-8 6.5mm CS140-8 ETHILON Suture	

Bi-Curve

Needles/ Avalable Products	Needle image
CSB-6 5.0mm Coated VICRYL Suture	
CSB-6 5.0mm CSB-6 MERSILENE Suture	

 **MultiPass**
NEEDLES MULTIPASS Needles

ETHICON NEEDLE SALES TYPES

CUTTING EDGE

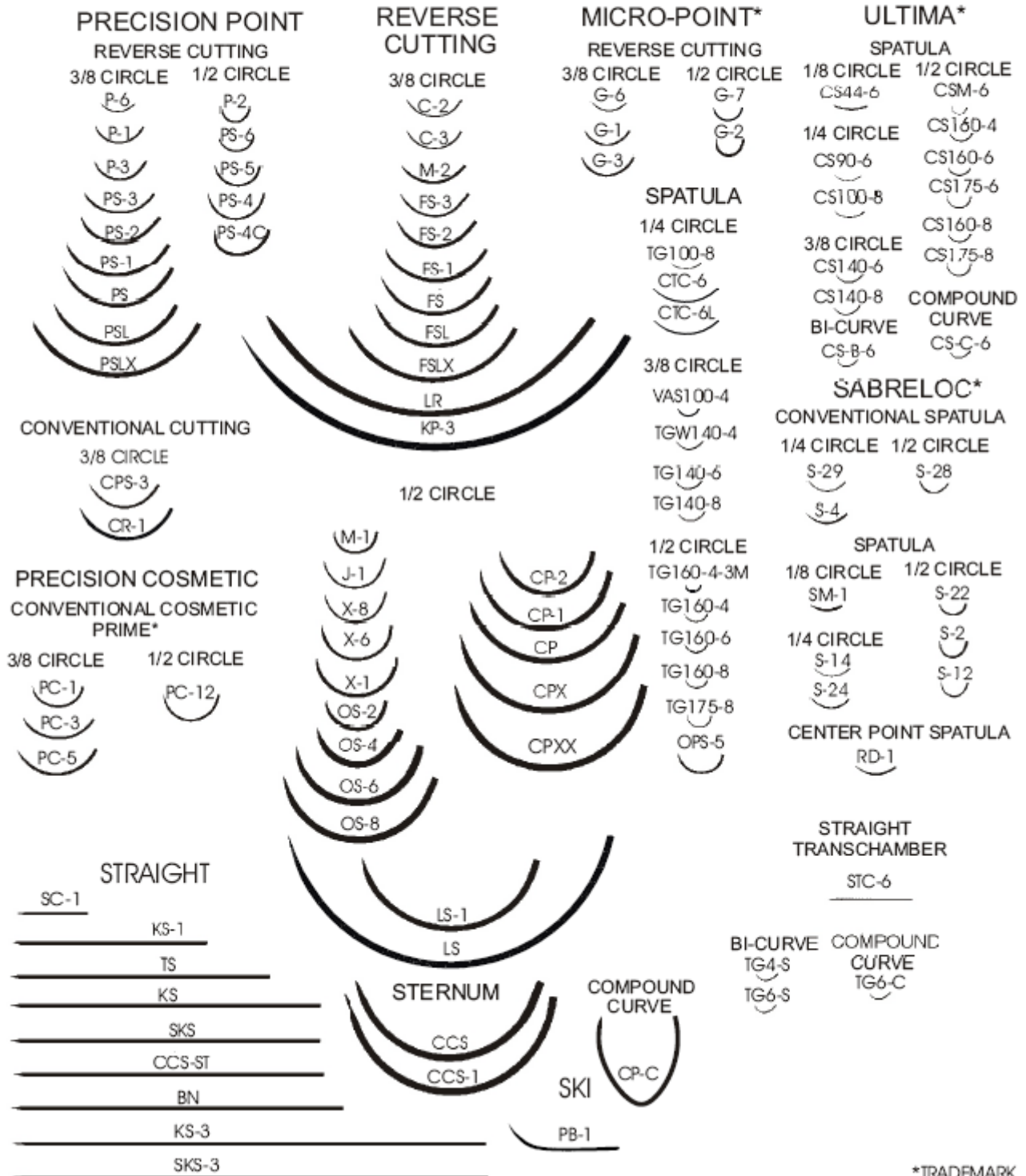

*TRADEMARK

ETHICON NEEDLE SALES TYPES

TAPER POINT

TAPERCUT*

TROCAR

STP-10

1/4 CIRCLE
BV30-2

5/8 CIRCLE
TF-5

1/2 CIRCLE
BVH100-3

3/8 CIRCLE
V130-3

1/4 CIRCLE
V75-3

1/2 CIRCLE
V-5

3/8 CIRCLE
BV50-3

MF-1

TF-6

V130-4

V100-3

V-6

BV75-3

MF

TF-4

V130-5

RV-2

V-7

BV75-4

UR-6

TF-1

CC

CIF-4

V-34

BV100-3

UR-5

RB-4

CC-1

V-37

BV100-4

UR-5

RB-3

V-18

V-30

BV130-3

UR-4

TF

V-4

V-40

BV130-4

UCL

V-3

V-56

BV130-5

RB-2

V-26

BV175-5

UCLX

STRAIGHT
V-47

BV175-6

RB-1

BV175-7

SH-2

BV175-8

RS

BV-1

SH-1

BV

SH

C-1

MH-1

BB

MH

BB-1

LH

TE-2

XLH

TE

XLH-1

TE-1

XXLH

BLUNT POINT

1/2 CIRCLE

BP-2

BP-1

BP

ETHIGUARD*

SHB

CTB-2

CTB-1

CTB

CTXB

TPB-1

SKI

SIF-2

STRAIGHT

ST100-3

ST-4

ST-3

ST-1

ST

ENDOSCOPY

TAPERPOINT

EN-S

EN-1

EN-2

TN

TQ

TAPERCUT*

EN-5

DT-6

EN-3

EN-4

V-38

*TRADEMARK









MW v.4

Coated VICRYL Plus Suture





Blunt Point



Needle	Material	Length	1
TPB-1 65mm 1/2 Circle 	Violet Braided	4-27" ~ 70cm	VCPB650G

ETHIGUARD - Safety needle



Needle	Material	Length	0	1	2-0	3-0
CTB-1 36mm 1/2 Circle 	Undyed Braided	8-18" ~ 45cm	VCPB840D  VCPB840Z	VCPB841D  VCPB841Z	VCPB839D  VCPB839Z	
	Undyed Braided	18" ~ 45cm	VCPB260H			
	Undyed Braided	27" ~ 70cm	VCPB260W VCPB946H		VCPB259H VCPB259W	
	Undyed Braided	8-27" ~ 70cm	VCPB41D 			
	Undyed Braided	36" ~ 90cm	VCPB946W	VCPB947H VCPB947W	VCPB945H	VCPB944H VCPB944W
	Violet Braided	8-18" ~ 45cm	VCPB740D  VCPB740Z	VCPB741D  VCPB741Z	VCPB739D  VCPB739Z	
	Violet Braided	27" ~ 70cm	VCPB340H VCPB340W	VCPB341H VCPB341W		
	Violet Braided	8-27" ~ 70cm	VCPB31D 			
	Violet Braided	36" ~ 90cm	VCPB346H			

Sutures : Absorbable / Coated VICRYL Plus Suture

Needle	Material	Length	0	1
CTX-B 48mm 1/2 Circle 	Undyed Braided	8-18" ~ 45cm	VCPB724D  VCPB724Z	VCPB725D  VCPB725Z
	Undyed Braided	18" ~ 45cm	VCPB978H	
	Undyed Braided	36" ~ 90cm	VCPB978W	VCPB977H ³ VCPB977W
	Violet Braided	8-18" ~ 45cm		VCPB765D 

Needle	Material	Length	2-0	3-0
SHB 26mm 1/2 Circle 	Undyed Braided	8-18" ~ 45cm		VCPB864D  VCPB864Z
	Undyed Braided	18" ~ 45cm	VCPB417H	
	Undyed Braided	27" ~ 70cm		VCPB416H
	Violet Braided	8-18" ~ 45cm		VCPB774D 
	Violet Braided	27" ~ 70cm		VCPB316H

Needle	Material	Length	0	2-0
CTB 40mm 1/2 Circle 	Violet Braided	36" ~ 90cm	VCPB330H ³	VCPB357H
	Undyed Braided	36" ~ 90cm	VCPB958H	

Needle	Material	Length	0	2-0
CTB-2 36mm 1/2 Circle 	Violet Braided	8-18" ~ 45cm	VCPB727D 	VCPB726D 
	Undyed Braided	18" ~ 45cm		VCPB269H

LIGAPAK Ligating Reel

Needle	Material	Length	0	1	2-0	3-0	4-0
LIGAPAK Ligating Reel N/A 	Undyed Braided	144" ~ 366cm				VCP885G ¹	
	Undyed Braided	54" ~ 135cm	VCP287G		VCP286G	VCP285G	VCP284G ¹
	Violet Braided	144" ~ 366cm	VCP207G				
	Violet Braided	54" ~ 135cm		VCP208G		VCP205G	

Precision Cosmetic - Conventional Cutting PRIME

Needle	Material	Length	4-0	5-0
PC-1 13mm 3/8 Circle 	Undyed Braided	18" ~ 45cm	VCP835G	VCP834G

Needle	Material	Length	4-0	5-0
PC-3 16mm 3/8 Circle 	Undyed Braided	18" ~ 45cm	VCP845G VCP845G15	VCP844G

Needle	Material	Length	3-0	4-0	5-0
--------	----------	--------	-----	-----	-----

Sutures : Absorbable / Coated VICRYL Plus Suture

Needle	Material	Length	3-0	4-0	5-0
PC-5 19mm 3/8 Circle 	Undyed Braided	18" ~ 45cm	VCP824G	VCP823G VCP823H	VCP822G

Precision Point - Reverse Cutting

Needle	Material	Length	4-0	5-0
P-2 8.0mm 1/2 Circle 	Undyed Braided	18" ~ 45cm	VCP504G	VCP503G

Needle	Material	Length	4-0	5-0
PS-4 16mm 1/2 Circle 	Undyed Braided	18" ~ 45cm	VCP507G	VCP506G

Needle	Material	Length	4-0	5-0
PS-5 13mm 1/2 Circle 	Undyed Braided	18" ~ 45cm	VCP594G ¹	VCP593G

Needle	Material	Length	5-0
PS-6 11mm 1/2 Circle 	Undyed Braided	18" ~ 45cm	VCP511G

Sutures : Absorbable / Coated VICRYL Plus Suture

Needle	Material	Length	4-0
PS-4C 16mm 1/2 Circle Compound Curve 	Undyed Braided	18" ~ 45cm	VCP656G

Needle	Material	Length	5-0
P-1 11mm 3/8 Circle 	Undyed Braided	18" ~ 45cm	VCP490G

Needle	Material	Length	4-0	5-0
P-3 13mm 3/8 Circle 	Violet Braided	18" ~ 45cm	VCP464G ¹	VCP463G
	Undyed Braided	18" ~ 45cm	VCP494G VCP494H	VCP493G VCP493H ³

Needle	Material	Length	3-0	4-0
PS-1 24mm 3/8 Circle 	Undyed Braided	18" ~ 45cm	VCP683G VCP683H VCP936H	VCP682G VCP682H
	Undyed Braided	27" ~ 70cm		VCP935H

Needle	Material	Length	2-0	3-0	4-0	5-0
PS-2 19mm 3/8 Circle 	Undyed Braided	18" ~ 45cm	VCP428H	VCP497G VCP497H ³	VCP496G ¹ VCP496H ³	VCP495G ¹ VCP495H ³
	Undyed Braided	27" ~ 70cm		VCP427H ³	VCP426H ³	

Sutures : Absorbable / Coated VICRYL Plus Suture

Needle	Material	Length	5-0
PS-3 16mm 3/8 Circle 	Undyed Braided	18" ~ 45cm	VCP500G VCP500H

Needle	Material	Length	2-0	3-0
PSL 30mm 3/8 Circle 	Undyed Braided	27" ~ 70cm	VCP596H	VCP502H



Reverse Cutting

Needle	Material	Length	0	1	2-0	2
CP 40mm 1/2 Circle 	Undyed Braided	27" ~ 70cm	VCP197H	VCP196H ¹		VCP195H
	Violet Braided	27" ~ 70cm		VCP480H VCP486H	VCP478H	







Needle	Material	Length	0	1	2-0	3-0
CP-1 36mm 1/2 Circle 	Undyed Braided	27" ~ 70cm	VCP267H	VCP268H	VCP266H	VCP265H
	Violet Braided	27" ~ 70cm	VCP467H	VCP468H VCP474H	VCP466H	
	Violet Braided	36" ~ 90cm			VCP472H	VCP531H





Needle	Material	Length	0	1	2-0	3-0
--------	----------	--------	---	---	-----	-----

Sutures : Absorbable / Coated VICRYL Plus Suture







Needle	Material	Length	0	1	2-0	3-0
CP-2 26mm 1/2 Circle 	Undyed Braided	8-18" ~ 45cm			VCP762D 	VCP761D 
	Undyed Braided	18" ~ 45cm	VCP870H			
	Undyed Braided	27" ~ 70cm		VCP871H	VCP869H ³	VCP868H



Needle	Material	Length	0	1
CPX 48mm 1/2 Circle 	Undyed Braided	27" ~ 70cm	VCP568H	VCP569H



Needle	Material	Length	0	1	2-0
OS-4 22mm 1/2 Circle 	Violet Braided	3-18" ~ 45cm	VCP707T 	VCP708T 	VCP706T 
	Undyed Braided	3-18" ~ 45cm	VCP749T 		VCP748T 
	Undyed Braided	18" ~ 45cm	VCP694H		
	Undyed Braided	27" ~ 70cm		VCP695H	

Needle	Material	Length	0	1	2-0
OS-6 36mm 1/2 Circle 	Violet Braided	3-18" ~ 45cm	VCP711T 		VCP710T 
	Undyed Braided	3-18" ~ 45cm	VCP754T 		VCP750T 
	Undyed Braided	18" ~ 45cm	VCP534H		
	Undyed Braided	27" ~ 70cm		VCP535H VCP535H05	VCP533H ³

Sutures : Absorbable / Coated VICRYL Plus Suture

Needle	Material	Length	0	1	2-0	2
OS-8 40mm 1/2 Circle 	Violet Braided	3-18" ~ 45cm	VCP717T 	VCP718T 	VCP716T 	VCP719T 
	Undyed Braided	3-18" ~ 45cm	VCP756T 	VCP757T 		
	Undyed Braided	18" ~ 45cm	VCP698H			
	Undyed Braided	27" ~ 70cm		VCP699H		

Needle	Material	Length	2-0	3-0
X-1 22mm 1/2 Circle 	Violet Braided	8-18" ~ 45cm		VCP790D  VCP790Z
	Violet Braided	27" ~ 70cm		VCP460H
	Undyed Braided	18" ~ 45cm	VCP459H	
	Undyed Braided	27" ~ 70cm		VCP458H

Needle	Material	Length	3-0
FS 26mm 3/8 Circle 	Violet Braided	8-18" ~ 45cm	VCP787D 

Needle	Material	Length	2-0	3-0	4-0
FS-1 24mm 3/8 Circle 	Undyed Braided	27" ~ 70cm	VCP443H	VCP442H ³	VCP441H
	Violet Braided	27" ~ 70cm		VCP452H	VCP451H

Sutures : Absorbable / Coated VICRYL Plus Suture

Needle	Material	Length	3-0	4-0	5-0
FS-2 19mm 3/8 Circle 	Violet Braided	18" ~ 45cm	VCP393H	VCP392H ³	VCP391H
	Undyed Braided	18" ~ 45cm	VCP423H		
	Undyed Braided	27" ~ 70cm		VCP422H ³	VCP421H

Needle	Material	Length	2-0	3-0
FSL 30mm 3/8 Circle 	Undyed Braided	27" ~ 70cm	VCP589H	VCP588H

Standard and Short Length Sutures

Needle	Material	Length	0	1	2-0	2	3-0
Standard and Short Length Sutures N/A 	Violet Braided	3-18" ~ 45cm	VCP636T		VCP635T		VCP634T
	Violet Braided	54" ~ 135cm	VCP616H	VCP617H ³	VCP615H	VCP618H ³	
	Undyed Braided	3-18" ~ 45cm	VCP646T		VCP645T		VCP644H
	Undyed Braided	12-18" ~ 45cm					VCP110G
	Undyed Braided	18" ~ 45cm	VCP608H				
	Undyed Braided	54" ~ 135cm			VCP607H		





Straight Cutting Needles

Needle	Material	Length	3-0	4-0
KS 60mm Straight 	Undyed Braided	27" ~ 70cm	VCP663H	VCP662H













SUTUPAK Pre-Cut Sutures



Needle	Material	Length	0	1	2-0	3-0	4-0
SUTUPAK Pre-Cut Sutures N/A 	Violet Braided	6-18" ~ 45cm	VCP106G	VCP107G			
	Violet Braided	12-18" ~ 45cm			VCP105G	VCP104G	VCP103G
	Undyed Braided	6-18" ~ 45cm	VCP112G				
	Undyed Braided	12-18" ~ 45cm			VCP111G		VCP109G

Taper Point

Needle	Material	Length	0	1	2-0	3-0
CT 40mm 1/2 Circle 	Violet Braided	8-18" ~ 45cm	VCP752D 	VCP753D 	VCP751D 	
	Violet Braided	27" ~ 70cm	VCP352H VCP358H	VCP353H	VCP351H	
	Violet Braided	36" ~ 90cm		VCP359H	VCP357H	VCP356H
	Undyed Braided	18" ~ 45cm	VCP280H			
	Undyed Braided	27" ~ 70cm		VCP281H	VCP275H	
	Undyed Braided	36" ~ 90cm	VCP958H	VCP959H	VCP957H	VCP956H

Sutures : Absorbable / Coated VICRYL Plus Suture





Needle	Material	Length	0	1	2-0	3-0
CT-1 36mm 1/2 Circle 	Violet Braided	8-18" ~ 45cm	VCP740D  VCP740Z	VCP741D ¹³  VCP741Z	VCP739D 	VCP738D 
	Violet Braided	27" ~ 70cm	VCP340H VCP340W VCP346H	VCP341H VCP341W	VCP339H VCP339W	VCP338H VCP338W
	Violet Braided	8-27" ~ 70cm	VCPP31D 			
	Violet Braided	36" ~ 90cm		VCP347H ³	VCP345H	VCP344H
	Undyed Braided	8-18" ~ 45cm	VCP840D 	VCP841D 	VCP839D 	VCP838D 
	Undyed Braided	18" ~ 45cm	VCP260H			
	Undyed Braided	27" ~ 70cm	VCP946H	VCP261H	VCP259H	VCP258H
	Undyed Braided	8-27" ~ 70cm	VCPP41D 	VCPP40D 	VCPP42D 	
	Undyed Braided	36" ~ 90cm		VCP947H	VCP945H	VCP944H





Needle	Material	Length	0	1	2-0	3-0
CT-2 26mm 1/2 Circle 	Violet Braided	8-18" ~ 45cm	VCP727D 		VCP726D  VCP726Z	
	Violet Braided	27" ~ 70cm	VCP334H	VCP335H ³	VCP333H VCP333W	VCP332H
	Undyed Braided	18" ~ 45cm	VCP270H			
	Undyed Braided	27" ~ 70cm			VCP269H	VCP232H

Needle	Material	Length	0	2-0	3-0
--------	----------	--------	---	-----	-----

Sutures : Absorbable / Coated VICRYL Plus Suture





Needle	Material	Length	0	2-0	3-0
CT-3 22mm 1/2 Circle 	Violet Braided	27" ~ 70cm	VCP329H	VCP328H	VCP327H



Needle	Material	Length	0	1	2-0	3-0
CTX 48mm 1/2 Circle 	Undyed Braided	8-18" ~ 45cm	VCP724D 		VCP723D 	
	Undyed Braided	36" ~ 90cm	VCP978H	VCP977H	VCP979H	VCP980H ³
	Violet Braided	8-18" ~ 45cm	VCP764D 	VCP765D 		
	Violet Braided	18" ~ 45cm	VCP364H			
	Violet Braided	27" ~ 70cm	VCP370H	VCP365H	VCP363H	
	Violet Braided	36" ~ 90cm	VCP370H05	VCP371H VCP371H05	VCP369H	



Needle	Material	Length	0	1	2-0
MO-4 36mm 1/2 Circle 	Violet Braided	8-18" ~ 45cm	VCP701D 	VCP702D 	VCP700D 
	Violet Braided	18" ~ 45cm	VCP436H		
	Violet Braided	8-27" ~ 70cm	VCP71D 		
	Violet Braided	27" ~ 70cm		VCP437H	

Needle	Material	Length	0	1
--------	----------	--------	---	---

Sutures : Absorbable / Coated VICRYL Plus Suture







Needle	Material	Length	0	1
MO-5 31mm 1/2 Circle 	Violet Braided	8-18" ~ 45cm	VCP801D  VCPP81D 	
	Violet Braided	8-27" ~ 70cm		VCPP80D 

Needle	Material	Length	2-0
MO-6 26mm 1/2 Circle 	Violet Braided	8-18" ~ 45cm	VCP789D 



Needle	Material	Length	2-0	3-0	4-0	5-0
RB-1 17mm 1/2 Circle 	Violet Braided	8-18" ~ 45cm		VCP713D  VCP713Z		
	Violet Braided	18" ~ 45cm	VCP306H			
	Violet Braided	27" ~ 70cm		VCP305H VCP305W	VCP304H VCP304W	VCP303H
	Undyed Braided	8-18" ~ 45cm			VCP714D  VCP714Z	
	Undyed Braided	27" ~ 70cm		VCP215H	VCP214H	VCP213H

Needle	Material	Length	0	2-0	3-0	4-0
--------	----------	--------	---	-----	-----	-----

Sutures : Absorbable / Coated VICRYL Plus Suture



Needle	Material	Length	0	2-0	3-0	4-0
SH 26mm 1/2 Circle 	Violet Braided	8-18" ~ 45cm		VCP775D  VCP775Z	VCP774D  VCP774Z	VCP773D  VCP773Z
	Violet Braided	27" ~ 70cm		VCP317H VCP317W	VCP316H ³ VCP316W	VCP315H
	Violet Braided	8-27" ~ 70cm		VCP785D 	VCP784D 	
	Undyed Braided	8-18" ~ 45cm			VCP864D 	
	Undyed Braided	18" ~ 45cm	VCP418H			
	Undyed Braided	27" ~ 70cm		VCP417H	VCP416H	VCP415H

Needle	Material	Length	3-0
SH 26mm SH 1/2 Circle 	Violet Braided	36" ~ 90cm	VCP527H

Needle	Material	Length	3-0	4-0
SH-1 22mm 1/2 Circle 	Violet Braided	8-18" ~ 45cm	VCP772D  VCP772Z	VCP771D  VCP771Z
	Violet Braided	27" ~ 70cm	VCP311H VCP311W	VCP310H VCP310W
	Undyed Braided	18" ~ 45cm	VCP219H	
	Undyed Braided	27" ~ 70cm		VCP218H

Needle	Material	Length	4-0	5-0
--------	----------	--------	-----	-----

Sutures : Absorbable / Coated VICRYL Plus Suture

Needle	Material	Length	4-0	5-0
TF 13mm 1/2 Circle 	Violet Braided	8-18" ~ 45cm	VCP743D  VCP743Z	
	Undyed Braided	18" ~ 45cm	VCP434H	
	Undyed Braided	27" ~ 70cm		VCP433H

Needle	Material	Length	1	2
TP-1 65mm 1/2 Circle 	Violet Braided	4-27" ~ 70cm	VCP650G	VCP649G
	Undyed Braided	2-27" ~ 70cm		VCP849G
	Undyed Braided	27" ~ 70cm		VCP880T

Needle	Material	Length	1	2-0
XLH 70mm 1/2 Circle 	Violet Braided	27" ~ 70cm	VCP583G	VCP581G

Needle	Material	Length	0	2-0
UR-5 36mm 5/8 Circle 	Violet Braided	27" ~ 70cm	VCP376H	VCP375H

Needle	Material	Length	0	2-0

Sutures : Absorbable / Coated VICRYL Plus Suture

Needle	Material	Length	0	2-0
UR-6 26mm 5/8 Circle 	Violet Braided	27" ~ 70cm	VCP603H ³	VCP602H ³ VCP602W

Taper Point - Reverse Cutting

Needle	Material	Length	3-0
CT 40mm FSL 30mm 1/2 Circle 	Undyed Braided	54" ~ 135cm	VCP940H ³

Needle	Material	Length	3-0
CT-1 36mm CP-1 36mm 1/2 Circle 	Undyed Braided	54" ~ 135cm	VCP931H ³

TAPERCUT

Needle	Material	Length	0	1	2-0	3-0
V-34 36mm 1/2 Circle 	Violet Braided	36" ~ 90cm	VCP518H	VCP519H ³	VCP517H	VCP516H
	Undyed Braided	36" ~ 90cm			VCP917H	VCP916H

¹ One dozen packets per box

³ Three dozen packets per box

¹³ Safety organizer tray

 **MultiPass**
NEEDLES MULTIPASS Needles

 **CONTROL RELEASE**



MONOCRYL Plus Suture



ETHIGUARD - Safety needle

Needle	Material	Length	0	2-0	3-0
CTB-1 36mm 1/2 Circle 	Violet Monofilament	36" ~ 90cm	MCPB346H ³	MCPB345H	
	Undyed Monofilament	36" ~ 90cm	MCPB946H	MCPB945H	MCPB944H ³

Needle	Material	Length	3-0
SHB 26mm 1/2 Circle 	Violet Monofilament	27" ~ 70cm	MCPB316H ³
	Undyed Monofilament	27" ~ 70cm	MCPB416H

Precision Cosmetic - Conventional Cutting PRIME

Needle	Material	Length	4-0	5-0
PC-1 13mm 3/8 Circle  	Undyed Monofilament	18" ~ 45cm	MCP835G	MCP834G

Needle	Material	Length	4-0	5-0
PC-3 16mm 3/8 Circle  	Undyed Monofilament	18" ~ 45cm	MCP845G	MCP844G

Sutures : Absorbable / MONOCRYL Plus Suture

Needle	Material	Length	4-0	5-0
PC-5 19mm 3/8 Circle 	Undyed Monofilament	18" ~ 45cm	MCP823G	MCP822G

Precision Point - Reverse Cutting

Needle	Material	Length	5-0	6-0
P-1 11mm 3/8 Circle 	Undyed Monofilament	18" ~ 45cm	MCP490G	MCP489G

Needle	Material	Length	4-0	5-0	6-0
P-3 13mm 3/8 Circle 	Undyed Monofilament	18" ~ 45cm	MCP494G	MCP493G	MCP492G
	Violet Monofilament	18" ~ 45cm		MCP463G	

Needle	Material	Length	3-0	4-0
PS-1 24mm 3/8 Circle 	Undyed Monofilament	18" ~ 45cm	MCP936H	MCP682H
	Undyed Monofilament	27" ~ 70cm		MCP935H

Needle	Material	Length	3-0	4-0	5-0
--------	----------	--------	-----	-----	-----

Sutures : Absorbable / MONOCRYL Plus Suture

Needle	Material	Length	3-0	4-0	5-0
PS-2 19mm 3/8 Circle 	Undyed Monofilament	18" ~ 45cm	MCP497G MCP427H	MCP496G	MCP495G
	Undyed Monofilament	27" ~ 70cm		MCP426H	
	Violet Monofilament	18" ~ 45cm		MCP513G	

Reverse Cutting

Needle	Material	Length	2-0
CP-1 36mm 1/2 Circle 	Undyed Monofilament	27" ~ 70cm	MCP266H

Straight Cutting Needles

Needle	Material	Length	3-0
KS 60mm Straight 	Undyed Monofilament	27" ~ 70cm	MCP523H

Taper Point

Needle	Material	Length	0
CT 40mm 1/2 Circle 	Violet Monofilament	36" ~ 90cm	MCP358H

Sutures : Absorbable / MONOCRYL Plus Suture

Needle	Material	Length	0	1	2-0	3-0
CT-1 36mm 1/2 Circle 	Violet Monofilament	27" ~ 70cm	MCP340H MCP346H		MCP339H	
	Violet Monofilament	36" ~ 90cm		MCP347H	MCP345H	MCP344H
	Undyed Monofilament	36" ~ 90cm	MCP946H	MCP947H	MCP945H	MCP944H

Needle	Material	Length	2-0
CT-2 26mm 1/2 Circle 	Violet Monofilament	27" ~ 70cm	MCP333H

Needle	Material	Length	4-0	5-0
RB-1 17mm 1/2 Circle 	Undyed Monofilament	27" ~ 70cm	MCP214H	MCP213H
	Violet Monofilament	27" ~ 70cm	MCP304H	

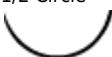
Needle	Material	Length	2-0	3-0	4-0
SH 26mm 1/2 Circle 	Violet Monofilament	27" ~ 70cm	MCP317H	MCP316H	MCP315H
	Undyed Monofilament	27" ~ 70cm	MCP417H	MCP416H	MCP415H

Needle	Material	Length	2-0

Sutures : Absorbable / MONOCRYL Plus Suture

Needle	Material	Length	2-0
UR-5 36mm 5/8 Circle 	Violet Monofilament	27" ~ 70cm	MCP377H

Needle	Material	Length	2-0	3-0
UR-6 26mm 5/8 Circle 	Violet Monofilament	27" ~ 70cm	MCP605H	MCP604H

³ Three dozen packets per box



PDS Plus Suture

Blunt Point

Needle	Material	Length	0	1
BP-1 65mm 1/2 Circle 	Violet Monofilament Loop	48" ~ 122cm	PDPB991G	PDPB880G ^{1 15}

Needle	Material	Length	1
TPB-1 65mm 1/2 Circle 	Violet Monofilament	54" ~ 135cm	PDPB879G ¹

Endoscopic Needles

Needle	Material	Length	4-0
ST-4 19mm ST-4 Straight Taper Point 	Violet Monofilament	14" ~ 35cm	PDP420G ¹

ETHIGUARD - Safety needle

Needle	Material	Length	0	1	2-0
--------	----------	--------	---	---	-----

Sutures : Absorbable / PDS Plus Suture

Needle	Material	Length	0	1	2-0
CTB-1 36mm 1/2 Circle 	Violet Monofilament	27" ~ 70cm	PDPB340 ³ PDPB346	PDPB341H ³	PDPB339H ³
	Violet Monofilament	36" ~ 90cm		PDPB347 ³	PDPB345 ³

Needle	Material	Length	0	1
CTX-B 48mm 1/2 Circle 	Violet Monofilament	36" ~ 90cm	PDPB370 ⁶ PDPB990G	PDPB371 ⁶

Needle	Material	Length	2-0	3-0
SHB 26mm 1/2 Circle 	Violet Monofilament	27" ~ 70cm	PDPB317H ³	PDPB316H ³

Needle	Material	Length	0	1
CTB 40mm 1/2 Circle 	Violet Monofilament	36" ~ 90cm	PDPB358T ⁶	PDPB359T ⁶

Needle	Material	Length	0	2-0	3-0
CTB-2 36mm 1/2 Circle 	Violet Monofilament	27" ~ 70cm	PDPB334H ³	PDPB333H ³	PDPB332H ³

Precision Cosmetic - Conventional Cutting PRIME

Needle	Material	Length	6-0
PC-1 13mm 3/8 Circle 	Undyed Monofilament	18" ~ 45cm	PDP833G ¹

Needle	Material	Length	4-0	5-0
PC-3 16mm 3/8 Circle 	Undyed Monofilament	18" ~ 45cm	PDP845G ¹	PDP844G ¹

Needle	Material	Length	3-0	4-0
PC-5 19mm 3/8 Circle 	Undyed Monofilament	18" ~ 45cm	PDP824G ¹	PDP823G ¹

Precision Point - Reverse Cutting

Needle	Material	Length	4-0	5-0
P-2 8.0mm 1/2 Circle 	Undyed Monofilament	18" ~ 45cm	PDP504G ¹	PDP503G ¹

Needle	Material	Length	4-0
--------	----------	--------	-----

Sutures : Absorbable / PDS Plus Suture

Needle	Material	Length	4-0
PS-4 16mm 1/2 Circle 	Undyed Monofilament	18" ~ 45cm	PDP507G ¹

Needle	Material	Length	6-0
P-1 11mm 3/8 Circle 	Violet Monofilament	18" ~ 45cm	PDP487G ¹
	Undyed Monofilament	18" ~ 45cm	PDP489G

Needle	Material	Length	4-0	5-0
P-3 13mm 3/8 Circle 	Undyed Monofilament	18" ~ 45cm	PDP494G ¹	PDP493G
	Violet Monofilament	18" ~ 45cm		PDP463G

Needle	Material	Length	3-0	4-0
PS-1 24mm 3/8 Circle 	Undyed Monofilament	18" ~ 45cm	PDP683G ¹	PDP682G ¹

Needle	Material	Length	3-0	4-0	5-0
PS-2 19mm 3/8 Circle 	Undyed Monofilament	18" ~ 45cm	PDP497G ¹	PDP496G ¹	PDP495G
	Violet Monofilament	18" ~ 45cm		PDP513G	

Reverse Cutting

Needle	Material	Length	0	1	2-0
CP-1 36mm 1/2 Circle 	Violet Monofilament	27" ~ 70cm	PDP467H ³	PDP468H ³	PDP466H ³

Needle	Material	Length	0	2-0	3-0
CP-2 26mm 1/2 Circle 	Violet Monofilament	27" ~ 70cm	PDP970H ³	PDP969H ³	PDP968H ³

Needle	Material	Length	1
CPX 48mm 1/2 Circle 	Violet Monofilament	27" ~ 70cm	PDP569T ⁶

Needle	Material	Length	1
OS-4 22mm 1/2 Circle 	Violet Monofilament	27" ~ 70cm	PDP695H ³

Needle	Material	Length	0	1

Sutures : Absorbable / PDS Plus Suture

Needle	Material	Length	0	1
OS-6 36mm 1/2 Circle 	Violet Monofilament	27" ~ 70cm	PDP534T [®]	PDP535H ³

Needle	Material	Length	2-0	3-0	4-0
FS-1 24mm 3/8 Circle 	Undyed Monofilament	27" ~ 70cm	PDP443H ³	PDP442H ³	PDP441H ³

Needle	Material	Length	3-0	4-0	5-0
FS-2 19mm 3/8 Circle 	Undyed Monofilament	27" ~ 70cm	PDP423H ³	PDP422H ³	PDP421H ³

Straight Cutting Needles

Needle	Material	Length	3-0	4-0
KS 60mm Straight 	Undyed Monofilament	27" ~ 70cm	PDP663H ³	PDP662H ³

Taper Point

Needle	Material	Length	0	1	2-0
--------	----------	--------	---	---	-----

Sutures : Absorbable / PDS Plus Suture

Needle	Material	Length	0	1	2-0
CT 40mm 1/2 Circle 	Violet Monofilament	27" ~ 70cm	PDP352H ³ PDP358T	PDP353H ³	
	Violet Monofilament	36" ~ 90cm		PDP359T ⁶	PDP357H ³

Needle	Material	Length	0	1	2-0	3-0
CT-1 36mm 1/2 Circle 	Violet Monofilament	27" ~ 70cm	PDP340H ³ PDP346H	PDP341H ³	PDP339H	PDP338H
	Violet Monofilament	36" ~ 90cm		PDP347H ³		
	Undyed Monofilament	27" ~ 70cm				PDP259H

Needle	Material	Length	0	2-0	3-0
CT-2 26mm 1/2 Circle 	Violet Monofilament	27" ~ 70cm	PDP334H ³	PDP333H ³	PDP332H ³

Needle	Material	Length	0	1
CTX 48mm 1/2 Circle 	Violet Monofilament	36" ~ 90cm	PDP370T ⁶ PDP990G	PDP371T ⁶

Needle	Material	Length	3-0	4-0	5-0
RB-1 17mm 1/2 Circle 	Violet Monofilament	27" ~ 70cm	PDP305H ³	PDP304H ³	PDP303H ³

Needle	Material	Length	5-0
RB-1 17mm RB-1 1/2 Circle 	Violet Monofilament	30" ~ 75cm	PDP320H ³

Needle	Material	Length	5-0	6-0
RB-2 13mm RB-2 1/2 Circle 	Violet Monofilament	30" ~ 75cm	PDP148H ³	PDP149H ³

Needle	Material	Length	2-0	3-0	4-0
SH 26mm 1/2 Circle 	Violet Monofilament	27" ~ 70cm	PDP317H ³	PDP316H ³	PDP315H
	Undyed Monofilament	27" ~ 70cm		PDP416H	

Needle	Material	Length	3-0	4-0
SH-1 22mm 1/2 Circle 	Violet Monofilament	27" ~ 70cm	PDP311H ³	PDP310H ³

Needle	Material	Length	6-0
TF 13mm 1/2 Circle 	Violet Monofilament	27" ~ 70cm	PDP432H ³

Needle	Material	Length	0	1
TP-1 65mm 1/2 Circle 	Violet Monofilament	2-27" ~ 70cm		PDP690G
	Violet Monofilament	27" ~ 70cm		PDP879G
	Violet Monofilament Loop	54" ~ 135cm	PDP991G	
	Violet Monofilament Loop	60" ~ 150cm		PDP880G

Needle	Material	Length	2-0
UCL 14mm 1/2 Circle 	Violet Monofilament	27" ~ 70cm	PDP114H ³

Needle	Material	Length	0	1
XLH 70mm 1/2 Circle 	Violet Monofilament	27" ~ 70cm	PDP582G ¹	PDP583G ¹ PDP877G
	Violet Monofilament	54" ~ 135cm		PDP881G

Needle	Material	Length	6-0
BV 11mm BV 3/8 Circle 	Violet Monofilament	30" ~ 75cm	PDP123H ³

Sutures : Absorbable / PDS Plus Suture

Needle	Material	Length	6-0
BV-1 9.3mm BV-1 3/8 Circle 	Violet Monofilament	30" ~ 75cm	PDP117H ³

Needle	Material	Length	5-0	6-0
C-1 13mm C-1 3/8 Circle 	Violet Monofilament	30" ~ 75cm	PDP126H ³	PDP127H ³

TAPERCUT

Needle	Material	Length	4-0
V-5 17mm V-5 1/2 Circle 	Violet Monofilament	36" ~ 90cm	PDP137H ³

¹ One dozen packets per box

³ Three dozen packets per box

⁶ Two dozen packets per box

¹⁵ This product has a loop length that is half of the length specified here.



VICRYL RAPIDE Suture

Precision Cosmetic - Conventional Cutting PRIME

Needle	Material	Length	4-0	5-0
PC-1 13mm 3/8 Circle 	Undyed Braid/coat	18" ~ 45cm	VR835 ¹	VR834 ⁰¹

Needle	Material	Length	4-0	5-0
PC-3 16mm 3/8 Circle 	Undyed Braid/coat	18" ~ 45cm	VR845 ¹	VR844 ¹

Precision Point - Reverse Cutting

Needle	Material	Length	5-0
P-1 11mm 3/8 Circle 	Undyed Braid/coat	18" ~ 45cm	VR490 ¹

Needle	Material	Length	4-0	5-0
P-3 13mm 3/8 Circle 	Undyed Braid/coat	18" ~ 45cm	VR494 ¹	VR493 ¹

Sutures : Absorbable / VICRYL RAPIDE Suture

Needle	Material	Length	3-0
PS-1 24mm 3/8 Circle 	Undyed Braid/coat	27" ~ 70cm	VR935 ¹

Needle	Material	Length	3-0	4-0
PS-2 19mm 3/8 Circle 	Undyed Braid/coat	18" ~ 45cm	VR497 ¹	VR496 ¹ VR426

Taper Point

Needle	Material	Length	0
CT 40mm 1/2 Circle 	Undyed Braid/coat	36" ~ 90cm	VR9580 ¹

Needle	Material	Length	2-0	3-0
CT-1 36mm 1/2 Circle 	Undyed Braid/coat	36" ~ 90cm	VR945 ¹	VR944 ¹

Needle	Material	Length	0

Sutures : Absorbable / VICRYL RAPIDE Suture

Needle	Material	Length	0
CTX 48mm 1/2 Circle 	Undyed Braid/coat	36" ~ 90cm	VR1695 ¹

Needle	Material	Length	4-0
RB-1 17mm 1/2 Circle 	Undyed Braid/coat	27" ~ 70cm	VR214 ¹

Needle	Material	Length	2-0	3-0
SH 26mm 1/2 Circle 	Undyed Braid/coat	27" ~ 70cm	VR417 ¹	VR416 ¹

Taper Point - Reverse Cutting

Needle	Material	Length	2-0	3-0
CT-1 36mm CP-1 36mm 1/2 Circle 	Undyed Braid/coat	54" ~ 135cm	VR932 ¹	VR931 ¹

TAPERCUT

Sutures : Absorbable / VICRYL RAPIDE Suture

Needle	Material	Length	0	2-0	3-0
V-34 36mm 1/2 Circle 	Undyed Braid/coat	36" ~ 90cm	VR2218 ¹	VR917 ¹	VR916 ¹

Nonsterile

¹ One dozen packets per box





 **MULTIPASS** Needles



Coated VICRYL Suture



Conventional Cutting - Sternum

Needle	Material	Length	3
CCS-1 60mm 1/2 Circle 	Undyed Braided	27" ~ 70cm	J808T

ETHIGUARD - Safety needle

Needle	Material	Length	0	1	2-0	3-0
CTB-1 36mm 1/2 Circle 	Undyed Braided	8-18" ~ 45cm	JB840 	JB841 ^{1,13} 	JB839 	
	Undyed Braided	18" ~ 45cm	JB260			
	Undyed Braided	27" ~ 70cm	JB946		JB259	
	Undyed Braided	36" ~ 90cm		JB947 ³	JB945 ³	JB944 ³
	Violet Braided	27" ~ 70cm	JB340	JB341 ³		

Needle	Material	Length	0	1
CTX-B 48mm 1/2 Circle 	Undyed Braided	8-18" ~ 45cm	JB724 ^{1,13}  JB72433	JB725 ^{1,13}  JB72533
	Undyed Braided	18" ~ 45cm	JB978	
	Undyed Braided	36" ~ 90cm	JB97833	JB977 ³ JB97730

Needle	Material	Length	2-0	3-0
SHB 26mm 1/2 Circle 	Undyed Braided	8-18" ~ 45cm		JB864 
	Undyed Braided	18" ~ 45cm	JB417	
	Undyed Braided	27" ~ 70cm		JB416 ³

Needle	Material	Length	2-0	3-0
CTB-2 36mm 1/2 Circle 	Undyed Braided	27" ~ 70cm	JB269 ³	JB232 ³

LIGAPAK Ligating Reel

Needle	Material	Length	0	1	2-0	3-0	4-0	5-0
LIGAPAK Ligating Reel N/A 	Undyed Braided	144" ~ 366cm				J885G		
	Undyed Braided	54" ~ 135cm	J287G		J286G	J285G	J284G	J283G
	Violet Braided	144" ~ 366cm	J207G					
	Violet Braided	54" ~ 135cm		J208G	J206G	J205G	J204G	

MICROPOINT - Spatula

Needle	Material	Length	8-0
--------	----------	--------	-----

Sutures : Absorbable / Coated VICRYL Suture

Needle	Material	Length	8-0
TG160-6 5.5mm TG160-6 1/2 Circle 	Violet Braided	12" ~ 30cm	J975G33

Needle	Material	Length	7-0	8-0
TG160-8 5.5mm TG160-8 1/2 Circle 	Violet Braided	12" ~ 30cm	J575G J576G	
	Violet Braided	18" ~ 45cm		J574G

Needle	Material	Length	6-0
TG100-8 6.5mm TG100-8 1/4 Circle 	Violet Braided	18" ~ 45cm	J544G

Needle	Material	Length	8-0
TG140-6 6.5mm TG140-6 3/8 Circle 	Violet Braided	12" ~ 30cm	J974G

Needle	Material	Length	7-0	8-0	9-0
TG140-8 6.5mm TG140-8 3/8 Circle 	Violet Braided	12" ~ 30cm	J566G J546G	J548G J599G ⁷	V549G
	Violet Braided	18" ~ 45cm		J547G	

MICROPOINT-Reverse Cutting

Needle	Material	Length	6-0	
G-6 8.0mm G-6 3/8 Circle 	Violet Braided	18" ~ 45cm	J551G	

Precision Cosmetic - Conventional Cutting PRIME

Needle	Material	Length	4-0	5-0
PC-12 16mm 1/2 Circle 	Undyed Braided	18" ~ 45cm	J814G ⁶⁵	J813G ⁶⁵

Needle	Material	Length	4-0	5-0	6-0
PC-1 13mm 3/8 Circle 	Undyed Braided	18" ~ 45cm	J835G ⁶⁵	J834G ⁶⁵	J833G ⁶⁵

Needle	Material	Length	4-0	5-0	6-0
PC-3 16mm 3/8 Circle 	Undyed Braided	18" ~ 45cm	J845G	J844G	J843G

Needle	Material	Length	3-0	4-0	5-0
--------	----------	--------	-----	-----	-----

Sutures : Absorbable / Coated VICRYL Suture

Needle	Material	Length	3-0	4-0	5-0
PC-5 19mm 3/8 Circle 	Undyed Braided	18" ~ 45cm	J824G	J823G J823H	J822G

Precision Point - Reverse Cutting

Needle	Material	Length	4-0	5-0
P-2 8.0mm 1/2 Circle 	Undyed Braided	18" ~ 45cm	J504G	J503G

Needle	Material	Length	4-0	5-0
PS-4 16mm 1/2 Circle 	Undyed Braided	18" ~ 45cm	J507G	J506G

Needle	Material	Length	4-0	5-0
PS-5 13mm 1/2 Circle 	Undyed Braided	18" ~ 45cm	J594G	J593G

Needle	Material	Length	5-0	6-0
PS-6 11mm 1/2 Circle 	Undyed Braided	18" ~ 45cm	J511G	J510G

Sutures : Absorbable / Coated VICRYL Suture

Needle	Material	Length	3-0	4-0
PS-4C 16mm 1/2 Circle Compound Curve 	Undyed Braided	18" ~ 45cm	J657G	J656G

Needle	Material	Length	5-0	6-0	7-0
P-1 11mm 3/8 Circle 	Undyed Braided	18" ~ 45cm	J490G	J489G	J488G

Needle	Material	Length	4-0	5-0	6-0
P-3 13mm 3/8 Circle 	Violet Braided	18" ~ 45cm	J464G	J463G	
	Undyed Braided	18" ~ 45cm	J494G J494H	J493G J493H	J492G J492H

Needle	Material	Length	3-0	4-0
PS-1 24mm 3/8 Circle 	Undyed Braided	18" ~ 45cm	J683G J683H J936H	J682G J682H
	Undyed Braided	27" ~ 70cm	J936H05	J935H

Needle	Material	Length	2-0	3-0	4-0	5-0
PS-2 19mm 3/8 Circle 	Undyed Braided	18" ~ 45cm	J428H	J497G J497H	J496G J496H	J495G J495H
	Undyed Braided	27" ~ 70cm		J427H	J426H	

Sutures : Absorbable / Coated VICRYL Suture

Needle	Material	Length	5-0	6-0
PS-3 16mm 3/8 Circle 	Undyed Braided	18" ~ 45cm	J500G J500H	J499G

Needle	Material	Length	0	2-0	3-0
PSL 30mm 3/8 Circle 	Violet Braided	27" ~ 70cm	J610H		
	Undyed Braided	27" ~ 70cm		J596H	J502H



Reverse Cutting

Needle	Material	Length	0	1	2-0	2
CP 40mm 1/2 Circle 	Violet Braided	27" ~ 70cm	J479H ³ J485H	J480H	J478H	
	Violet Braided	36" ~ 90cm		J486H		
	Undyed Braided	27" ~ 70cm		J196H		J195H

Needle	Material	Length	0	1	2-0	3-0
CP-1 36mm 1/2 Circle 	Undyed Braided	27" ~ 70cm	J267H	J268H	J266H	
	Violet Braided	27" ~ 70cm	J467H J473H	J468H	J466H	
	Violet Braided	36" ~ 90cm		J474H ³	J472H	J471H



Needle	Material	Length	0	1	2-0	3-0
--------	----------	--------	---	---	-----	-----

Sutures : Absorbable / Coated VICRYL Suture

Needle	Material	Length	0	1	2-0	3-0
CP-2 26mm 1/2 Circle 	Undyed Braided	8-18" ~ 45cm			J762D ¹³ 	J761D ¹³ 
	Undyed Braided	18" ~ 45cm	J870H			
	Undyed Braided	27" ~ 70cm		J871H	J869H	J868H







Needle	Material	Length	0	1
CPX 48mm 1/2 Circle 	Undyed Braided	27" ~ 70cm	J568H	J569H





Needle	Material	Length	4-0
J-1 17mm 1/2 Circle 	Undyed Braided	27" ~ 70cm	J455H







Needle	Material	Length	0
OS-2 17mm 1/2 Circle 	Violet Braided	3-18" ~ 45cm	J704T ⁴ 

Needle	Material	Length	0	1	2-0
--------	----------	--------	---	---	-----

Sutures : Absorbable / Coated VICRYL Suture



Needle	Material	Length	0	1	2-0
OS-4 22mm 1/2 Circle 	Violet Braided	3-18" ~ 45cm	J707T ⁴ 	J708T 	J706T ⁴ 
	Undyed Braided	3-18" ~ 45cm	J749T 		J748T 
	Undyed Braided	18" ~ 45cm	J694H		
	Undyed Braided	27" ~ 70cm		J695H	J693H ⁴

Needle	Material	Length	0	1	2-0
OS-6 36mm 1/2 Circle 	Violet Braided	3-18" ~ 45cm	J711T ⁴ 		J710T 
	Undyed Braided	3-18" ~ 45cm	J754T 		J750T 
	Undyed Braided	18" ~ 45cm	J534H		
	Undyed Braided	27" ~ 70cm		J535H	J533H



Needle	Material	Length	0	1	2-0	2
OS-8 40mm 1/2 Circle 	Violet Braided	3-18" ~ 45cm	J717T ⁴ 	J718T 	J716T ⁴ 	J719T 
	Undyed Braided	3-18" ~ 45cm	J756T 	J757T 		
	Undyed Braided	18" ~ 45cm	J698H			
	Undyed Braided	27" ~ 70cm		J699H		

Needle	Material	Length	2-0	3-0
--------	----------	--------	-----	-----

Sutures : Absorbable / Coated VICRYL Suture

Needle	Material	Length	2-0	3-0
X-1 22mm 1/2 Circle 	Violet Braided	8-18" ~ 45cm		J790D ¹³ 
	Violet Braided	27" ~ 70cm	J461H	J460H
	Undyed Braided	18" ~ 45cm	J459H	
	Undyed Braided	27" ~ 70cm		J458H

Needle	Material	Length	4-0	5-0
C-3 13mm 3/8 Circle 	Violet Braided	18" ~ 45cm	J386H	J385H

Needle	Material	Length	3-0
FS 26mm 3/8 Circle 	Violet Braided	8-18" ~ 45cm	J787D ¹³ 

Needle	Material	Length	2-0	3-0	4-0
FS-1 24mm 3/8 Circle 	Undyed Braided	27" ~ 70cm	J443H	J442H	J441H
	Violet Braided	27" ~ 70cm			J451H

Needle	Material	Length	3-0	4-0	5-0
--------	----------	--------	-----	-----	-----

Sutures : Absorbable / Coated VICRYL Suture

Needle	Material	Length	3-0	4-0	5-0
FS-2 19mm 3/8 Circle 	Violet Braided	18" ~ 45cm	J393H	J392H	J391H
	Undyed Braided	18" ~ 45cm	J423H		
	Undyed Braided	27" ~ 70cm		J422H	J421H

Needle	Material	Length	2-0	3-0
FSL 30mm 3/8 Circle 	Undyed Braided	27" ~ 70cm	J589H	J588H

SABRELOC - Center Point Spatula

Needle	Material	Length	6-0
RD-1 8.0mm RD-1 1/4 Circle 	Violet Braided	12" ~ 30cm	J446G

SABRELOC - Conventional Spatula

Needle	Material	Length	6-0
S-28 8.0mm S-28 1/2 Circle 	Violet Braided	18" ~ 45cm	J562G

Sutures : Absorbable / Coated VICRYL Suture

Needle	Material	Length	6-0
S-29 8.0mm S-29 1/4 Circle 	Violet Braided	12" ~ 30cm	J556G J555G

SABRELOC - Spatula

Needle	Material	Length	5-0	6-0
S-14 8.0mm S-14 1/4 Circle 	Violet Braided	18" ~ 45cm	J571G J591G	J570G
	Violet Braided	8" ~ 20cm	J591G05	J590G
	Undyed Braided	18" ~ 45cm	J671G	J670G

Needle	Material	Length	5-0	6-0
S-24 8.0mm S-24 1/4 Circle 	Violet Braided	12" ~ 30cm	J553G J579G	J552G
	Violet Braided	8" ~ 20cm		J578G

Standard and Short Length Sutures

Needle	Material	Length	0	1	2	2-0	3-0	4-0

Sutures : Absorbable / Coated VICRYL Suture

Needle	Material	Length	0	1	2	2-0	3-0	4-0
Standard and Short Length Sutures N/A 	Violet Braided	3-18" ~ 45cm	J636H			J635H	J634H	J633H
	Violet Braided	54" ~ 135cm	J616H	J617H ³	J618H ³	J615H	J614H	
	Undyed Braided	3-18" ~ 45cm	J646H			J645H	J644H	J643H
	Undyed Braided	18" ~ 45cm	J608H					
	Undyed Braided	54" ~ 135cm				J607H	J606H	





Straight Cutting Needles













Needle	Material	Length	3-0	4-0
KS 60mm Straight 	Violet Braided	27" ~ 70cm	J523H	J522H
	Undyed Braided	27" ~ 70cm	J663H	J662H

SUTUPAK Pre-Cut Sutures



Needle	Material	Length	0	1	2-0	3-0	4-0
SUTUPAK Pre-Cut Sutures N/A 	Violet Braided	6-18" ~ 45cm	J106G J106T ³				
	Violet Braided	12-18" ~ 45cm	J906G	J907G	J105G J105T ³ J905T	J104G J104T ³ J904T	J103G J103T ³
	Undyed Braided	6-18" ~ 45cm	J112G J112T ³	J113G J113T ³			
	Undyed Braided	12-18" ~ 45cm	J912G	J913G	J111G J111T ³ J911T	J110G J110T ³ J910T	J109G J109T ³

Taper Point





Needle	Material	Length	0	1	2-0	3-0
CT 40mm 1/2 Circle 	Violet Braided	8-18" ~ 45cm	J752D ¹³ 	J753D ¹³ 	J751D ¹³ 	
	Violet Braided	27" ~ 70cm	J352H J358H	J353H	J351H	
	Violet Braided	36" ~ 90cm		J359H	J357H	J356H
	Undyed Braided	18" ~ 45cm	J280H			
	Undyed Braided	27" ~ 70cm		J281H	J275H J275H33	
	Undyed Braided	36" ~ 90cm	J958H J958H33	J959H J959H33	J957H	J956H

Needle	Material	Length	0	1	2-0	3-0	4-0
CT-1 36mm 1/2 Circle 	Violet Braided	8-18" ~ 45cm	J740D ¹³ 	J741D 	J739D 	J738D 	
	Violet Braided	27" ~ 70cm	J340H J346H	J341H	J339H	J338H	J337H
	Violet Braided	3-27" ~ 70cm	J430T				
	Violet Braided	8-27" ~ 70cm	JJ31G ⁴ 				
	Violet Braided	36" ~ 90cm		J347H	J345H	J344H	
	Undyed Braided	8-18" ~ 45cm	J840D 	J841D 	J839D 	J838D 	
	Undyed Braided	18" ~ 45cm	J260H				
	Undyed Braided	8-27" ~ 70cm	JJ41G 	JJ40G 	JJ42G 		
	Undyed Braided	27" ~ 70cm		J261H	J259H	J258H	
	Undyed Braided	36" ~ 90cm	J946H J946H33	J947H	J945H	J944H	

Sutures : Absorbable / Coated VICRYL Suture





Needle	Material	Length	0	1	2-0	3-0
CT-2 26mm 1/2 Circle 	Violet Braided	8-18" ~ 45cm	J727D ¹³ 		J726D ¹³ 	
	Violet Braided	27" ~ 70cm	J334H	J335H	J333H	J332H
	Undyed Braided	18" ~ 45cm	J270H			
	Undyed Braided	27" ~ 70cm			J269H	J232H J232H33





Needle	Material	Length	0	2-0	3-0
CT-3 22mm 1/2 Circle 	Violet Braided	27" ~ 70cm	J329H	J328H	J327H



Needle	Material	Length	0	1	2-0	3-0
CTX 48mm 1/2 Circle 	Undyed Braided	8-18" ~ 45cm	J724D ¹³ 		J723D 	
	Undyed Braided	36" ~ 90cm	J978H	J977H	J979H	J980H
	Violet Braided	8-18" ~ 45cm	J764D 	J765D ¹³ 		
	Violet Braided	18" ~ 45cm	J364H			
	Violet Braided	27" ~ 70cm	J370H	J365H	J363H	
	Violet Braided	36" ~ 90cm		J371H	J369H	



Needle	Material	Length	0	1	2-0
--------	----------	--------	---	---	-----

Sutures : Absorbable / Coated VICRYL Suture









Needle	Material	Length	0	1	2-0
MO-4 36mm 1/2 Circle 	Violet Braided	8-18" ~ 45cm	J701D ¹³ 	J702D ¹³ 	J700D ¹³ 
	Violet Braided	18" ~ 45cm	J436H		
	Violet Braided	27" ~ 70cm		J437H	J435H ⁴

Needle	Material	Length	0	1	2-0
MO-5 31mm 1/2 Circle 	Violet Braided	8-18" ~ 45cm	J801D ¹³  JJ81G 		
	Violet Braided	8-27" ~ 70cm		JJ80G ⁴ 	JJ82G ⁴ 



Needle	Material	Length	2-0
MO-6 26mm 1/2 Circle 	Violet Braided	8-18" ~ 45cm	J789D ¹³ 

Needle	Material	Length	2-0	3-0	4-0	5-0	6-0
RB-1 17mm 1/2 Circle 	Violet Braided	8-18" ~ 45cm		J713D ¹³ 			
	Violet Braided	18" ~ 45cm	J306H				
	Violet Braided	27" ~ 70cm		J305H	J304H	J303H	
	Undyed Braided	8-18" ~ 45cm			J714D 		
	Undyed Braided	27" ~ 70cm		J215H	J214H	J213H	J212H

Sutures : Absorbable / Coated VICRYL Suture



Needle	Material	Length	0	2-0	3-0	4-0
SH 26mm 1/2 Circle 	Violet Braided	8-18" ~ 45cm		J775D ¹³ 	J774D ¹³ 	J773D 
	Violet Braided	27" ~ 70cm		J317H	J316H	J315H
	Violet Braided	8-27" ~ 70cm		J785G 	J784G 	J783G 
	Undyed Braided	8-18" ~ 45cm			J864D  J864D33	
	Undyed Braided	18" ~ 45cm	J418H			
	Undyed Braided	27" ~ 70cm		J417H	J416H	J415H

Needle	Material	Length	3-0
SH 26mm SH 1/2 Circle 	Violet Braided	36" ~ 90cm	J527H

Needle	Material	Length	3-0	4-0
SH-1 22mm 1/2 Circle 	Violet Braided	8-18" ~ 45cm	J772D ¹³ 	J771D ¹³ 
	Violet Braided	27" ~ 70cm	J311H	J310H
	Undyed Braided	18" ~ 45cm	J219H	
	Undyed Braided	27" ~ 70cm		J218H

Needle	Material	Length	4-0	5-0
--------	----------	--------	-----	-----

Sutures : Absorbable / Coated VICRYL Suture

Needle	Material	Length	4-0	5-0
TF 13mm 1/2 Circle 	Violet Braided	8-18" ~ 45cm	J743D ¹³ 	
	Undyed Braided	18" ~ 45cm	J434H	
	Undyed Braided	27" ~ 70cm		J433H

Needle	Material	Length	1	2
TP-1 65mm 1/2 Circle 	Violet Braided	4-27" ~ 70cm	J650G	J649G
	Undyed Braided	2-27" ~ 70cm		J849G J849G05
	Undyed Braided	27" ~ 70cm		J880T

Needle	Material	Length	0	1	2-0
XLH 70mm 1/2 Circle 	Violet Braided	27" ~ 70cm	J582G	J583G	J581G

Needle	Material	Length	8-0
BV130-4 5.0mm 3/8 Circle 	Violet Braided	5" ~ 13cm	J405G

Needle	Material	Length	8-0

Sutures : Absorbable / Coated VICRYL Suture

Needle	Material	Length	8-0
BV130-5 6.5mm 3/8 Circle 	Violet Braided	5" ~ 13cm	J401G

Needle	Material	Length	0
UR-4 40mm 5/8 Circle 	Violet Braided	27" ~ 70cm	J381H

Needle	Material	Length	0	2-0
UR-5 36mm 5/8 Circle 	Violet Braided	27" ~ 70cm	J376H	J375H

Needle	Material	Length	0	2-0
UR-6 26mm 5/8 Circle 	Violet Braided	27" ~ 70cm	J603H	J602H

Needle	Material	Length	9-0
BV100-3 3.9mm 3/8 Circle 	Violet Monofilament	5" ~ 13cm	V402G

Taper Point - Reverse Cutting

Needle	Material	Length	3-0
CT 40mm FSL 30mm 1/2 Circle 	Undyed Braided	54" ~ 135cm	J940H

Needle	Material	Length	2-0	3-0
CT-1 36mm CP-1 36mm 1/2 Circle 	Violet Braided	54" ~ 135cm	J532H	J531H
	Undyed Braided	54" ~ 135cm		J931H

TAPERCUT

Needle	Material	Length	0	1	2-0	3-0
V-34 36mm 1/2 Circle 	Violet Braided	36" ~ 90cm	J518H	J519H	J517H	J516H
	Undyed Braided	36" ~ 90cm			J917H	J916H

Needle	Material	Length	8-0
V130-4 4.2mm 1/4 Circle 	Violet Braided	9" ~ 23cm	J408G

Sutures : Absorbable / Coated VICRYL Suture

Needle	Material	Length	8-0
V130-5 6.5mm 1/4 Circle 	Violet Braided	9" ~ 23cm	J409G

ULTIMA - Spatula

Needle	Material	Length	10-0
CS160-6 5.5mm CS160-6 1/2 Circle 	Violet Monofilament	12" ~ 30cm	V448G V448G33

Needle	Material	Length	10-0	9-0
CS160-8 5.5mm CS160-8 1/2 Circle 	Violet Monofilament	12" ~ 30cm	V450G	V449G

Needle	Material	Length	10-0
CS90-6 7.0mm 1/4 Circle 	Violet Monofilament	4" ~ 10cm	V980G V980G33

Needle	Material	Length	10-0	9-0
CS140-6 6.5mm 3/8 Circle 	Violet Monofilament	4" ~ 10cm	V960G V960G05	
	Violet Braided	4" ~ 10cm		V950G V950G33

Needle	Material	Length	10-0
CSB-6 5.0mm Bi-Curve 	Violet Monofilament	4" ~ 10cm	V966G

¹ One dozen packets per box

³ Three dozen packets per box

⁴ Single strand delivery organizer

⁵ Single strand delivery

⁷ Beaded retraction sutures

¹³ Safety organizer tray

⁶⁵ Pliabilized

 **MultiPass**
NEEDLES MULTIPASS Needles

 **CONTROL RELEASE**

MONOCRYL Suture

ETHIGUARD - Safety needle

Needle	Material	Length	0	1	2-0	3-0
CTB-1 36mm 1/2 Circle 	Violet Monofilament	27" ~ 70cm	YB258		YB257	
	Undyed Monofilament	27" ~ 70cm	YB946			
	Undyed Monofilament	36" ~ 90cm		YB947		YB944

Needle	Material	Length	0
CTX-B 48mm 1/2 Circle 	Undyed Monofilament	36" ~ 90cm	YB978 YB97833

Needle	Material	Length	3-0
SHB 26mm 1/2 Circle 	Undyed Monofilament	27" ~ 70cm	YB416 ³

Precision Cosmetic - Conventional Cutting PRIME

Needle	Material	Length	4-0
PC-12 16mm 1/2 Circle 	Undyed Monofilament	18" ~ 45cm	Y814G

Needle	Material	Length	4-0	5-0	6-0
PC-1 13mm 3/8 Circle 	Undyed Monofilament	18" ~ 45cm	Y835G	Y834G	Y833G Y833G33

Needle	Material	Length	4-0	5-0
PC-3 16mm 3/8 Circle 	Undyed Monofilament	18" ~ 45cm	Y845G Y845G05	Y844G

Needle	Material	Length	4-0	5-0
PC-5 19mm 3/8 Circle 	Undyed Monofilament	18" ~ 45cm	Y823G	Y822G

Precision Point - Reverse Cutting

Needle	Material	Length	6-0
PS-6 11mm 1/2 Circle 	Undyed Monofilament	18" ~ 45cm	Y510G Y510G33

Needle	Material	Length	5-0	6-0
--------	----------	--------	-----	-----

Sutures : Absorbable / MONOCRYL Suture

Needle	Material	Length	5-0	6-0
P-1 11mm 3/8 Circle 	Undyed Monofilament	18" ~ 45cm	Y490G Y490G05	Y489G Y489G33

Needle	Material	Length	4-0	5-0	6-0
P-3 13mm 3/8 Circle 	Violet Monofilament	18" ~ 45cm	Y464G	Y463G	
	Undyed Monofilament	18" ~ 45cm	Y494G	Y493G Y493G33	Y492G Y492G33

Needle	Material	Length	3-0	4-0
PS-1 24mm 3/8 Circle 	Undyed Monofilament	18" ~ 45cm	Y936H	Y682H
	Undyed Monofilament	27" ~ 70cm		Y935H

Needle	Material	Length	3-0	4-0	5-0
PS-2 19mm 3/8 Circle 	Undyed Monofilament	18" ~ 45cm	Y497G Y427H	Y496G	Y495G
	Undyed Monofilament	27" ~ 70cm		Y426H Y426H33	
	Violet Monofilament	18" ~ 45cm		Y513G	

Reverse Cutting

Needle	Material	Length	0	2-0
--------	----------	--------	---	-----

Sutures : Absorbable / MONOCRYL Suture

Needle	Material	Length	0	2-0
CP-1 36mm 1/2 Circle 	Undyed Monofilament	27" ~ 70cm	Y267H	Y266H



Straight Cutting Needles

Needle	Material	Length	3-0
KS 60mm Straight 	Undyed Monofilament	27" ~ 70cm	Y523H







SUTUPAK Pre-Cut Sutures

Needle	Material	Length	0	1	2-0	3-0	4-0
SUTUPAK Pre-Cut Sutures N/A 	Violet Monofilament	6-18" ~ 45cm	Y910G ^s	Y911G ^s	Y909G ^s	Y908G ^s	Y907G ^s

Taper Point

Needle	Material	Length	0	1	2-0	3-0
CT 40mm 1/2 Circle 	Violet Monofilament	8-18" ~ 45cm	Y752D 			
	Violet Monofilament	18" ~ 45cm	Y352H			
	Violet Monofilament	27" ~ 70cm	Y358H	Y353H	Y351H	Y350H
	Violet Monofilament	36" ~ 90cm		Y359H	Y357H	Y356H

Sutures : Absorbable / MONOCRYL Suture





Needle	Material	Length	0	1	2-0	3-0
CT-1 36mm 1/2 Circle 	Violet Monofilament	8-18" ~ 45cm	Y740D 		Y739D 	Y738D 
	Violet Monofilament	18" ~ 45cm	Y340H			
	Violet Monofilament	4-27" ~ 70cm	YY31G 	YY30G 	YY32G 	
	Violet Monofilament	27" ~ 70cm	Y346H	Y341H	Y339H	Y338H
	Violet Monofilament	36" ~ 90cm		Y347H	Y345H	Y344H
	Undyed Monofilament	36" ~ 90cm	Y946H	Y947H	Y945H	Y944H



Needle	Material	Length	0	1	2-0
CT-2 26mm 1/2 Circle 	Violet Monofilament	27" ~ 70cm	Y334H	Y335H Y335H33	Y333H Y762H

Needle	Material	Length	0	1	2-0
CTX 48mm 1/2 Circle 	Violet Monofilament	36" ~ 90cm	Y398H	Y399H Y399H33	Y397H Y397H33

Needle	Material	Length	0	1

Sutures : Absorbable / MONOCRYL Suture

Needle	Material	Length	0	1
MO-4 36mm 1/2 Circle 	Violet Monofilament	8-18" ~ 45cm	Y701D 	
	Violet Monofilament	18" ~ 45cm	Y436H	
	Violet Monofilament	4-27" ~ 70cm	YY71G 	YY70G 
	Violet Monofilament	27" ~ 70cm		Y437H

Needle	Material	Length	0
MO-5 31mm 1/2 Circle 	Violet Monofilament	8-18" ~ 45cm	Y801D 



Needle	Material	Length	3-0	4-0	5-0
RB-1 17mm 1/2 Circle 	Undyed Monofilament	27" ~ 70cm	Y215H	Y214H	Y213H
	Violet Monofilament	27" ~ 70cm	Y305H	Y304H	Y303H

Needle	Material	Length	0	2-0	3-0	4-0
SH 26mm 1/2 Circle 	Violet Monofilament	27" ~ 70cm	Y318H	Y317H Y732H	Y316H	Y315H
	Undyed Monofilament	27" ~ 70cm		Y417H	Y416H	Y415H

Needle	Material	Length	3-0

Sutures : Absorbable / MONOCRYL Suture

Needle	Material	Length	3-0
SH 26mm SH 1/2 Circle 	Violet Monofilament	36" ~ 90cm	Y527H

Needle	Material	Length	3-0	4-0
SH-1 22mm 1/2 Circle 	Undyed Monofilament	8-18" ~ 45cm	Y872D 	
	Undyed Monofilament	18" ~ 45cm	Y219H	
	Undyed Monofilament	27" ~ 70cm		Y218H

Needle	Material	Length	4-0	5-0	6-0
TF 13mm 1/2 Circle 	Undyed Monofilament	27" ~ 70cm	Y434H	Y433H	Y432H

Needle	Material	Length	0	2-0
UR-5 36mm 5/8 Circle 	Violet Monofilament	27" ~ 70cm	Y378H	Y377H

Needle	Material	Length	0	2-0	3-0
UR-6 26mm 5/8 Circle 	Violet Monofilament	27" ~ 70cm	Y606H	Y605H	Y604H

Taper Point - Reverse Cutting

Needle	Material	Length	2-0	3-0
CT-1 36mm CP-1 36mm 1/2 Circle 	Undyed Monofilament	54" ~ 135cm	Y932H	Y931H

TAPERCUT

Needle	Material	Length	2-0
V-34 36mm 1/2 Circle 	Undyed Monofilament	27" ~ 70cm	Y817H Y917H

³ Three dozen packets per box

⁵ Single strand delivery

 **MultiPass**[®] MULTIPASS Needles

 **CONTROL RELEASE**

PDS II Suture



Conventional Cutting - Sternum

Needle	Material	Length	2
CCS-1 60mm 1/2 Circle 	Violet Monofilament	27" ~ 70cm	Z807T

Endoscopic Needles

Needle	Material	Length	4-0
ST-4 19mm ST-4 Straight Taper Point 	Violet Monofilament	14" ~ 35cm	Z420G Z420G33

ETHIGUARD - Safety needle

Needle	Material	Length	0	1	2-0
CTB-1 36mm 1/2 Circle 	Violet Monofilament	8-18" ~ 45cm	ZB740 ^{1,13} 		
	Violet Monofilament	18" ~ 45cm	ZB340		
	Violet Monofilament	27" ~ 70cm	ZB346		
	Violet Monofilament	36" ~ 90cm		ZB347	ZB345 ³

Sutures : Absorbable / PDS II Suture

Needle	Material	Length	0	1
CTX-B 48mm 1/2 Circle 	Violet Monofilament	36" ~ 90cm	ZB370 ZB37033	ZB371 ZB37133

Precision Cosmetic - Conventional Cutting PRIME

Needle	Material	Length	6-0
PC-1 13mm 3/8 Circle 	Undyed Monofilament	18" ~ 45cm	Z833G

Needle	Material	Length	4-0	5-0
PC-3 16mm 3/8 Circle 	Undyed Monofilament	18" ~ 45cm	Z845G Z845G31	Z844G Z844G31

Needle	Material	Length	3-0	4-0
PC-5 19mm 3/8 Circle 	Undyed Monofilament	18" ~ 45cm	Z824G	Z823G

Precision Point - Reverse Cutting

Needle	Material	Length	4-0	5-0
--------	----------	--------	-----	-----

Sutures : Absorbable / PDS II Suture

Needle	Material	Length	4-0	5-0
P-2 8.0mm 1/2 Circle 	Undyed Monofilament	18" ~ 45cm	Z504G Z504G33	Z503G Z503G33

Needle	Material	Length	4-0
PS-4 16mm 1/2 Circle 	Undyed Monofilament	18" ~ 45cm	Z507G

Needle	Material	Length	6-0
P-1 11mm 3/8 Circle 	Violet Monofilament	18" ~ 45cm	Z487G
	Undyed Monofilament	18" ~ 45cm	Z489G Z489G31

Needle	Material	Length	4-0	5-0
P-3 13mm 3/8 Circle 	Undyed Monofilament	18" ~ 45cm	Z494G	Z493G Z493G31
	Violet Monofilament	18" ~ 45cm		Z463G

Needle	Material	Length	3-0	4-0
PS-1 24mm 3/8 Circle 	Undyed Monofilament	18" ~ 45cm	Z683G Z683G31	Z682G



Sutures : Absorbable / PDS II Suture

Needle	Material	Length	3-0	4-0	5-0
PS-2 19mm 3/8 Circle 	Undyed Monofilament	18" ~ 45cm	Z497G Z497G31	Z496G Z496G31	Z495G
	Violet Monofilament	18" ~ 45cm		Z513G	

Reverse Cutting

Needle	Material	Length	2
CP 40mm 1/2 Circle 	Violet Monofilament	27" ~ 70cm	Z195T Z195T31

Needle	Material	Length	0	1	2-0
CP-1 36mm 1/2 Circle 	Violet Monofilament	27" ~ 70cm	Z467H	Z468H	Z466H Z466H31

Needle	Material	Length	0	2-0	3-0
CP-2 26mm 1/2 Circle 	Violet Monofilament	8-18" ~ 45cm		Z762D ¹³ 	Z761D ¹³ 
	Violet Monofilament	18" ~ 45cm	Z970H		
	Violet Monofilament	27" ~ 70cm		Z969H	Z968H Z968H33

Needle	Material	Length	1

Sutures : Absorbable / PDS II Suture

Needle	Material	Length	1
CPX 48mm 1/2 Circle 	Violet Monofilament	27" ~ 70cm	Z569T Z569T31

Needle	Material	Length	1
OS-4 22mm 1/2 Circle 	Violet Monofilament	27" ~ 70cm	Z695H Z695H31

Needle	Material	Length	0	1
OS-6 36mm 1/2 Circle 	Violet Monofilament	27" ~ 70cm	Z534T Z534T31	Z535H

Needle	Material	Length	2-0	3-0	4-0
FS-1 24mm 3/8 Circle 	Undyed Monofilament	27" ~ 70cm	Z443H	Z442H	Z441H





Needle	Material	Length	3-0	4-0	5-0
FS-2 19mm 3/8 Circle 	Undyed Monofilament	27" ~ 70cm	Z423H	Z422H	Z421H

Straight Cutting Needles



Needle	Material	Length	3-0	4-0
KS 60mm Straight 	Undyed Monofilament	27" ~ 70cm	Z663H	Z662H

Taper Point

Needle	Material	Length	0	none	1	2-0
CT 40mm 1/2 Circle 	Violet Monofilament	27" ~ 70cm	Z352H Z352H31		Z353H Z353H31	
	Violet Monofilament	36" ~ 90cm	Z358T		Z359T Z359T31	Z357H Z357H33
		27" ~ 70cm		Z358T05		

Needle	Material	Length	0	1	2-0	3-0
CT-1 36mm 1/2 Circle 	Violet Monofilament	8-18" ~ 45cm	Z740D ¹³ 	Z741D ¹³ 	Z739D ¹³ 	
	Violet Monofilament	18" ~ 45cm	Z340H			
	Violet Monofilament	27" ~ 70cm	Z340H31 Z346H	Z341H Z341H31	Z339H Z339H31	Z338H Z338H31
	Violet Monofilament	36" ~ 90cm	Z346H31	Z347H Z347H31		
	Undyed Monofilament	27" ~ 70cm			Z259H	Z258H





Needle	Material	Length	0	2-0	3-0
CT-2 26mm 1/2 Circle 	Violet Monofilament	27" ~ 70cm	Z334H Z334H31	Z333H Z333H31	Z332H

Needle	Material	Length	0	1
CTX 48mm 1/2 Circle 	Violet Monofilament	8-18" ~ 45cm	Z776D ¹³ 	Z765D ¹³ 
	Violet Monofilament	18" ~ 45cm	Z370T	
	Violet Monofilament	36" ~ 90cm		Z371T Z371T31
	Violet Monofilament	60" ~ 150cm	Z990G05 Z990G31	
	Violet Monofilament Loop	36" ~ 90cm	Z990G	

Needle	Material	Length	3-0	4-0	5-0
RB-1 17mm 1/2 Circle 	Violet Monofilament	27" ~ 70cm	Z305H	Z304H	Z303H

Needle	Material	Length	5-0
RB-1 17mm RB-1 1/2 Circle 	Violet Monofilament	30" ~ 75cm	Z320H

Needle	Material	Length	5-0	6-0
RB-2 13mm RB-2 1/2 Circle 	Violet Monofilament	30" ~ 75cm	Z148H	Z149H Z149H33

Needle	Material	Length	2-0	3-0	4-0
SH 26mm 1/2 Circle 	Violet Monofilament	8-18" ~ 45cm	Z775D ¹³ 	Z774D ¹³ 	Z773D ¹³ 
	Violet Monofilament	18" ~ 45cm	Z317H		
	Violet Monofilament	27" ~ 70cm		Z316H	Z315H
	Undyed Monofilament	27" ~ 70cm		Z416H	

Needle	Material	Length	3-0	4-0
SH-1 22mm 1/2 Circle 	Violet Monofilament	27" ~ 70cm	Z311H	Z310H

Needle	Material	Length	6-0
TF 13mm 1/2 Circle 	Violet Monofilament	27" ~ 70cm	Z432H

Needle	Material	Length	none	0	1

Sutures : Absorbable / PDS II Suture

Needle	Material	Length	none	0	1
TP-1 65mm 1/2 Circle 		2-27" ~ 70cm	Z690G31		
	Violet Monofilament	2-27" ~ 70cm			Z690G
	Violet Monofilament	27" ~ 70cm			Z880G31
	Violet Monofilament	48" ~ 122cm			Z879G
	Violet Monofilament	60" ~ 150cm		Z991G33	
	Violet Monofilament Loop	54" ~ 135cm		Z991G	
	Violet Monofilament Loop	60" ~ 150cm			Z880G

Needle	Material	Length	2-0
UCL 14mm 1/2 Circle 	Violet Monofilament	27" ~ 70cm	Z114H Z114H33

Needle	Material	Length	0	1
XLH 70mm 1/2 Circle 	Violet Monofilament	27" ~ 70cm	Z582G	Z583G Z877G
	Violet Monofilament Loop	54" ~ 135cm		Z881G

Needle	Material	Length	6-0
---------------	-----------------	---------------	------------

Sutures : Absorbable / PDS II Suture

Needle	Material	Length	6-0
BV 11mm BV 3/8 Circle 	Violet Monofilament	30" ~ 75cm	Z123H

Needle	Material	Length	6-0	7-0
BV-1 9.3mm BV-1 3/8 Circle 	Violet Monofilament	24" ~ 60cm	Z117H	Z155H
	Violet Monofilament	30" ~ 75cm		Z135H

Needle	Material	Length	5-0	6-0
C-1 13mm C-1 3/8 Circle 	Violet Monofilament	30" ~ 75cm	Z126H	Z127H

TAPERCUT

Needle	Material	Length	4-0
V-5 17mm V-5 1/2 Circle 	Violet Monofilament	36" ~ 90cm	Z137H

Trocar Point

Sutures : Absorbable / PDS II Suture

Needle	Material	Length	2-0
STP-10 254mm STP-10 Straight 	Violet Monofilament	27" ~ 70cm	Z997G ¹

¹ One dozen packets per box

³ Three dozen packets per box

¹³ Safety organizer tray

 **MultiPass**[®] MULTIPASS Needles
NEEDLES

 **CONTROL RELEASE**

Surgical Gut Suture - Chromic

Blunt Point

Needle	Material	Length	1
BP 80mm 1/2 Circle 	Chromic Monofilament	27" ~ 70cm	48G ¹

Needle	Material	Length	0
BP-1 65mm 1/2 Circle 	Chromic Monofilament	27" ~ 70cm	47T

LIGAPAK Dispensing Reel

Needle	Material	Length	0	1	2-0	3-0	4-0
LIGAPAK Dispensing Reel N/A 	Chromic Monofilament	54" ~ 135cm	L114G	L115G	L113G	L112G	L111G

MICROPOINT - Spatula

Sutures : Absorbable / Surgical Gut Suture - Chromic

Needle	Material	Length	7-0
TG100-8 6.5mm TG100-8 1/4 Circle 	Chromic Monofilament	18" ~ 45cm	1744G

Needle	Material	Length	6-0	7-0
TG140-8 6.5mm TG140-8 3/8 Circle 	Blue Chromic Monofilament	18" ~ 45cm	1731G	1797G

MICROPOINT-Reverse Cutting

Needle	Material	Length	none	4-0
G-2 8.0mm G-2 1/2 Circle 		18" ~ 45cm	798G34	
	Chromic Monofilament	18" ~ 45cm		798G

Needle	Material	Length	6-0
G-1 11mm 3/8 Circle 	Chromic Monofilament	18" ~ 45cm	796G 796G33

Needle	Material	Length	6-0

Sutures : Absorbable / Surgical Gut Suture - Chromic

Needle	Material	Length	6-0
G-1 11mm G-1 3/8 Circle 	Chromic Monofilament	18" ~ 45cm	790G 790G33

Needle	Material	Length	4-0	5-0
G-3 13mm G-3 3/8 Circle 	Chromic Monofilament	18" ~ 45cm	793G	792G

Needle	Material	Length	6-0
G-6 8.0mm G-6 3/8 Circle 	Chromic Monofilament	18" ~ 45cm	794G
	Blue Chromic Monofilament	18" ~ 45cm	795G

Precision Point - Reverse Cutting

Needle	Material	Length	4-0	5-0
P-2 8.0mm 1/2 Circle 	Chromic Monofilament	18" ~ 45cm	1659G	1658G

Needle	Material	Length	4-0	5-0	6-0
--------	----------	--------	-----	-----	-----

Sutures : Absorbable / Surgical Gut Suture - Chromic

Needle	Material	Length	4-0	5-0	6-0
PS-4 16mm 1/2 Circle 	Chromic Monofilament	18" ~ 45cm	1643G	1642G	1641G

Needle	Material	Length	4-0	5-0
PS-5 13mm 1/2 Circle 	Chromic Monofilament	18" ~ 45cm	1653G 1653G33	1652G

Needle	Material	Length	6-0
PS-6 11mm 1/2 Circle 	Chromic Monofilament	18" ~ 45cm	1816G

Needle	Material	Length	3-0	4-0
PS-4C 16mm 1/2 Circle Compound Curve 	Chromic Monofilament	18" ~ 45cm	2643G	2644G

Needle	Material	Length	4-0	5-0
P-3 13mm 3/8 Circle 	Chromic Monofilament	18" ~ 45cm	1654G	687G 687G33

Needle	Material	Length	0
--------	----------	--------	---

Sutures : Absorbable / Surgical Gut Suture - Chromic

Needle	Material	Length	0
PS 26mm 3/8 Circle 	Chromic Monofilament	27" ~ 70cm	598H

Needle	Material	Length	2-0	3-0	4-0
PS-2 19mm 3/8 Circle 	Chromic Monofilament	18" ~ 45cm	1621H		1637G
	Chromic Monofilament	27" ~ 70cm		1638H	

Needle	Material	Length	5-0	6-0
PS-3 16mm 3/8 Circle 	Chromic Monofilament	18" ~ 45cm	1636G	1635G

Needle	Material	Length	2-0
PSL 30mm 3/8 Circle 	Chromic Monofilament	36" ~ 90cm	929H

Reverse Cutting

Needle	Material	Length	1	2-0	3-0
CP 40mm 1/2 Circle 	Chromic Monofilament	27" ~ 70cm	805H ³ 805H33	833H ³	832H

Sutures : Absorbable / Surgical Gut Suture - Chromic

Needle	Material	Length	0	1	2-0
CP-1 36mm 1/2 Circle 	Chromic Monofilament	27" ~ 70cm	817H	975H	816H

Needle	Material	Length	0	2-0	3-0
CP-2 26mm 1/2 Circle 	Chromic Monofilament	27" ~ 70cm	888H	887H 887H33	886H

Needle	Material	Length	4-0
J-1 17mm 1/2 Circle 	Chromic Monofilament	18" ~ 45cm	724G U213H
	Chromic Monofilament	27" ~ 70cm	U213H33

Needle	Material	Length	4-0
M-1 13mm M-1 1/2 Circle 	Chromic Monofilament	12" ~ 30cm	744G

Needle	Material	Length	5-0
--------	----------	--------	-----

Sutures : Absorbable / Surgical Gut Suture - Chromic

Needle	Material	Length	5-0
C-3 13mm C-3 3/8 Circle 	Chromic Monofilament	12" ~ 30cm	723G

Needle	Material	Length	2-0
FS-1 24mm 3/8 Circle 	Chromic Monofilament	27" ~ 70cm	637H 637H33

Needle	Material	Length	3-0	4-0	5-0
FS-2 19mm 3/8 Circle 	Chromic Monofilament	27" ~ 70cm	636H 636H33	635H 635H33	634G

Needle	Material	Length	3-0
FSL 30mm 3/8 Circle 	Chromic Monofilament	36" ~ 90cm	932H

Needle	Material	Length	4-0
M-2 13mm 3/8 Circle 	Chromic Monofilament	12" ~ 30cm	752G 752G33

Sutures : Absorbable / Surgical Gut Suture - Chromic

Needle	Material	Length	4-0
M-2 13mm M-2 3/8 Circle 	Chromic Monofilament	12" ~ 30cm	751G

SABRELOC - Conventional Spatula

Needle	Material	Length	4-0
S-4 8.0mm S-4 1/4 Circle 	Chromic Monofilament	18" ~ 45cm	1793G 1793G33

SABRELOC - Spatula

Needle	Material	Length	4-0
S-2 8.0mm S-2 1/2 Circle 	Chromic Monofilament	18" ~ 45cm	1798G

Needle	Material	Length	5-0	6-0
S-14 8.0mm S-14 1/4 Circle 	Chromic Monofilament	12" ~ 30cm	1766G 1792G	
	Chromic Monofilament	18" ~ 45cm	1792G33	1791G33
	Blue Chromic Monofilament	18" ~ 45cm		1791G

Standard and Short Length Sutures

Needle	Material	Length	0	1	2-0	2	3-0	3	4-0
Standard and Short Length Sutures N/A 	Chromic Monofilament	54" ~ 135cm	S114H	S115H	S113H	S116H	S112H	S117H	S111H

Straight Cutting Needles

Needle	Material	Length	3-0
KS 60mm Straight 	Chromic Monofilament	27" ~ 70cm	654H 654H33

Straight Taper Point

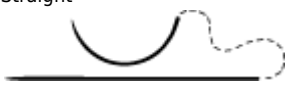
Needle	Material	Length	3-0
ST-1 45mm SH 26mm Straight 	Chromic Monofilament	36" ~ 90cm	G152H

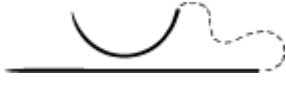

SUTUPAK Pre-Cut Sutures

Needle	Material	Length	0	1	2-0
SUTUPAK Pre-Cut Sutures N/A 	Chromic Monofilament	12-18" ~ 45cm	SG14T	SG15T	SG13T

Taper Point

Needle	Material	Length	0	1	2-0	3-0
CT 40mm 1/2 Circle 	Chromic Monofilament	3-27" ~ 70cm	3802T	3803T		
	Chromic Monofilament	27" ~ 70cm	802H 802H33 914H	803H 803H33	801H 801H33	800H
	Chromic Monofilament	36" ~ 90cm	914H33	915H 915H33	913H 913H33	912H

Needle	Material	Length	2-0	3-0
CT 40mm CT 1/2 Circle 	Chromic Monofilament	54" ~ 135cm	991H	990H

Needle	Material	Length	0	1	2-0	2	3-0	4-0
CT-1 36mm 1/2 Circle 	Chromic Monofilament	8-18" ~ 45cm	CC41G ¹³ 	CC40G ¹³ 				
	Chromic Monofilament	3-18" ~ 45cm	3812T					
	Chromic Monofilament	27" ~ 70cm	812H 812H33 924H	813H 813H33	811H 811H33	814H 814H33	810H 810H33	
	Chromic Monofilament	3-27" ~ 70cm		3813G	3811T			
	Chromic Monofilament	36" ~ 90cm		925H 925H33	923H		922H	921H

Sutures : Absorbable / Surgical Gut Suture - Chromic

Needle	Material	Length	0	1	2-0	3-0
CT-2 26mm 1/2 Circle 	Chromic Monofilament	27" ~ 70cm	884H 884H33	885H 885H33	883H 883H33	882H





Needle	Material	Length	0	2-0	3-0
CT-3 22mm 1/2 Circle 	Chromic Monofilament	27" ~ 70cm	894H	893H 893H33	892H 892H33



Needle	Material	Length	0	1	2-0	3-0
CTX 48mm 1/2 Circle 	Chromic Monofilament	27" ~ 70cm	864H 904H	865H 865H33	863H 863H33	862H
	Chromic Monofilament	36" ~ 90cm	904H33	905H 905H33	903H	

Needle	Material	Length	1
MO-2 40mm 1/2 Circle 	Chromic Monofilament	27" ~ 70cm	4915H 4915H33

Needle	Material	Length	0	1	2-0
--------	----------	--------	---	---	-----

Sutures : Absorbable / Surgical Gut Suture - Chromic

Needle	Material	Length	0	1	2-0
MO-4 36mm 1/2 Circle 	Chromic Monofilament	8-18" ~ 45cm	CC02G ¹³ 	CC01G ¹³ 	
	Chromic Monofilament	18" ~ 45cm	4924H		
	Chromic Monofilament	27" ~ 70cm	4924H33	4925H 4925H33	4923H
	Chromic Monofilament	3-27" ~ 70cm		5589T	
	Chromic Monofilament	8-27" ~ 70cm			CC38G ¹³ 

Needle	Material	Length	0	1
MO-5 31mm 1/2 Circle 	Chromic Monofilament	8-18" ~ 45cm	CC04G ¹³ 	CC03G ¹³ 
	Chromic Monofilament	18" ~ 45cm	4994H	
	Chromic Monofilament	27" ~ 70cm		4995H 4995H33

Needle	Material	Length	3-0	4-0	5-0
RB-1 17mm 1/2 Circle 	Chromic Monofilament	27" ~ 70cm	U204H	U203H	U202H

Needle	Material	Length	0	2-0	3-0	4-0
SH 26mm 1/2 Circle 	Chromic Monofilament	27" ~ 70cm	G124H	G123H ³	G122H	G121H

Needle	Material	Length	2-0	3-0

Sutures : Absorbable / Surgical Gut Suture - Chromic

Needle	Material	Length	2-0	3-0
SH 26mm SH 1/2 Circle 	Chromic Monofilament	36" ~ 90cm	G173H ³	G172H

Needle	Material	Length	3-0	4-0	5-0
SH-1 22mm 1/2 Circle 	Chromic Monofilament	27" ~ 70cm	G182H	G181H	G180H ³

Needle	Material	Length	1	2
TP-1 65mm 1/2 Circle 	Chromic Monofilament	4-27" ~ 70cm	M760G	
	Chromic Monofilament	27" ~ 70cm	GL30G	
	Chromic Monofilament	60" ~ 150cm		GL31G

Needle	Material	Length	0
XLH 70mm 1/2 Circle 	Chromic Monofilament	27" ~ 70cm	44T

Needle	Material	Length	4-0

Sutures : Absorbable / Surgical Gut Suture - Chromic

Needle	Material	Length	4-0
BB 17mm 3/8 Circle 	Chromic Monofilament	27" ~ 70cm	4887G ¹

Needle	Material	Length	5-0
C-1 13mm 3/8 Circle 	Chromic Monofilament	27" ~ 70cm	K895H

Needle	Material	Length	0	2-0
UR-4 40mm 5/8 Circle 	Chromic Monofilament	27" ~ 70cm	U256H	U255H

Needle	Material	Length	0	1	2-0
UR-5 36mm 5/8 Circle 	Chromic Monofilament	27" ~ 70cm	U246H	U247H	U245H

Needle	Material	Length	0	2-0	3-0
UR-6 26mm 5/8 Circle 	Chromic Monofilament	27" ~ 70cm	N879H	N878H	N877H

Taper Point - Reverse Cutting

Needle	Material	Length	2-0
CT 40mm FSL 30mm 1/2 Circle 	Chromic Monofilament	54" ~ 135cm	977H ³

Needle	Material	Length	2-0	3-0
CT-1 36mm CP-1 36mm 1/2 Circle 	Chromic Monofilament	54" ~ 135cm	983H	982H

TAPERCUT

Needle	Material	Length	0	1	2-0	3-0
V-34 36mm 1/2 Circle 	Chromic Monofilament	27" ~ 70cm	838H 944H	839H	837H	
	Chromic Monofilament	36" ~ 90cm		945H	943H	942H

Needle	Material	Length	4-0
V-5 17mm 1/2 Circle 	Chromic Monofilament	27" ~ 70cm	U233H

ULTIMA - Spatula

Needle	Material	Length	7-0
<p>CS175-8 7.0mm CS175-8</p> <p>1/2 Circle</p> 	<p>Chromic Monofilament</p>	<p>18" ~ 45cm</p>	<p>1745G 1745G34</p>

¹ One dozen packets per box

³ Three dozen packets per box

¹³ Safety organizer tray

 **MultiPass**[®] MULTIPASS Needles
NEEDLES

 **CONTROL RELEASE**

Surgical Gut Suture - Plain

LIGAPAK Dispensing Reel

Needle	Material	Length	0	2-0	3-0	4-0
LIGAPAK Dispensing Reel N/A 	Plain Monofilament	54" ~ 135cm	L104G	L103G	L102G	L101G

MICROPOINT - Spatula

Needle	Material	Length	6-0
TG140-8 6.5mm TG140-8 3/8 Circle 	Plain Monofilament	18" ~ 45cm	1735G

MICROPOINT-Reverse Cutting

Needle	Material	Length	6-0
G-1 11mm 3/8 Circle 	Plain Monofilament	18" ~ 45cm	774G 774G33

Needle	Material	Length	6-0
G-1 11mm G-1 3/8 Circle 	Plain Monofilament	18" ~ 45cm	770G 770G33

Needle	Material	Length	4-0	5-0
G-3 13mm G-3 3/8 Circle 	Plain Monofilament	18" ~ 45cm	773G	772G

Needle	Material	Length	6-0
G-6 8.0mm G-6 3/8 Circle 	Plain Monofilament	18" ~ 45cm	775G

Precision Cosmetic - Conventional Cutting PRIME

Needle	Material	Length	5-0	6-0
PC-1 13mm 3/8 Circle 	Plain Fast Absorbing	18" ~ 45cm	1915G	1916G
	Plain Monofilament	18" ~ 45cm		1916G33

Precision Point - Reverse Cutting

Needle	Material	Length	5-0
P-2 8.0mm 1/2 Circle 	Plain Monofilament	18" ~ 45cm	658G

Sutures : Absorbable / Surgical Gut Suture - Plain

Needle	Material	Length	4-0	5-0
PS-4 16mm 1/2 Circle 	Plain Monofilament	18" ~ 45cm	1633G	1632G

Needle	Material	Length	6-0
P-1 11mm 3/8 Circle 	Plain Monofilament	18" ~ 45cm	1657G

Needle	Material	Length	4-0	5-0
P-3 13mm 3/8 Circle 	Plain Monofilament	18" ~ 45cm	1644G 1644G33	686G 686G33

Needle	Material	Length	3-0
PS-1 24mm 3/8 Circle 	Plain Monofilament	27" ~ 70cm	1640H

Needle	Material	Length	3-0	4-0
PS-2 19mm 3/8 Circle 	Plain Monofilament	18" ~ 45cm	1630H	1627H 1627H33

Sutures : Absorbable / Surgical Gut Suture - Plain

Needle	Material	Length	5-0
PS-3 16mm 3/8 Circle 	Plain Monofilament	18" ~ 45cm	1626G 1626G33

Reverse Cutting

Needle	Material	Length	2-0
CP-1 36mm 1/2 Circle 	Plain Monofilament	27" ~ 70cm	898H 898H33

Needle	Material	Length	4-0
M-1 13mm 1/2 Circle 	Plain Monofilament	12" ~ 30cm	742G 742G33

Needle	Material	Length	3-0
X-1 22mm 1/2 Circle 	Plain Monofilament	18" ~ 45cm	612G

Needle	Material	Length	2-0	3-0
FS-1 24mm 3/8 Circle 	Plain Monofilament	27" ~ 70cm	H823H H823H33	H810H H810H33

Needle	Material	Length	3-0	4-0	5-0
FS-2 19mm 3/8 Circle 	Plain Monofilament	27" ~ 70cm	H822H H822H33	H821H H821H33	H820G H820G33

SABRELOC - Spatula

Needle	Material	Length	5-0
S-14 8.0mm S-14 1/4 Circle 	Plain Monofilament	12" ~ 30cm	1775G 1772G
	Plain Monofilament	18" ~ 45cm	1772G33

Standard and Short Length Sutures

Needle	Material	Length	0	1	2-0	3-0
Standard and Short Length Sutures N/A 	Plain Monofilament	54" ~ 135cm	S104H	S105H	S103H	S102H

Straight Cutting Needles

Needle	Material	Length	3-0
KS 60mm Straight 	Plain Monofilament	27" ~ 70cm	665H

Sutures : Absorbable / Surgical Gut Suture - Plain



Needle	Material	Length	4-0
SC-1 13mm Straight 	Plain Monofilament	18" ~ 45cm	1824H 1824H33

Needle	Material	Length	4-0
SC-1 13mm SC-1 Straight 	Plain Monofilament	18" ~ 45cm	1828H

SUTUPAK Pre-Cut Sutures

Needle	Material	Length	3-0
SUTUPAK Pre-Cut Sutures N/A 	Plain Monofilament	12-18" ~ 45cm	SG2T

Taper Point

Needle	Material	Length	2-0	3-0
CT 40mm 1/2 Circle 	Plain Monofilament	8-18" ~ 45cm		CP53G ¹³ 
	Plain Monofilament	18" ~ 45cm	853H	
	Plain Monofilament	27" ~ 70cm	853H33	852H

Needle	Material	Length	0	2-0	3-0
--------	----------	--------	---	-----	-----

Sutures : Absorbable / Surgical Gut Suture - Plain

Needle	Material	Length	0	2-0	3-0
CT-1 36mm 1/2 Circle 	Plain Monofilament	3-18" ~ 45cm			5503T
	Plain Monofilament	18" ~ 45cm	844H		
	Plain Monofilament	27" ~ 70cm	844H33	843H 843H33	842H 842H33

Needle	Material	Length	0	2-0	3-0
CT-3 22mm 1/2 Circle 	Plain Monofilament	27" ~ 70cm	N864H	N863H N863H33	N862H N862H33

Needle	Material	Length	2-0	3-0
CTX 48mm 1/2 Circle 	Plain Monofilament	27" ~ 70cm	872H 872H33	873H

Needle	Material	Length	4-0
RB-1 17mm 1/2 Circle 	Plain Monofilament	27" ~ 70cm	U207H

Needle	Material	Length	3-0	4-0
SH 26mm 1/2 Circle 	Plain Monofilament	27" ~ 70cm	G322H	G321H

Needle	Material	Length	2-0	3-0
XLH 70mm 1/2 Circle 	Plain Monofilament	27" ~ 70cm	53T	52T

Needle	Material	Length	2-0
UR-6 26mm 5/8 Circle 	Plain Monofilament	27" ~ 70cm	N873H

TAPERCUT

Needle	Material	Length	3-0
V-34 36mm 1/2 Circle 	Plain Monofilament	27" ~ 70cm	846H

Needle	Material	Length	3-0
V-7 26mm 1/2 Circle 	Plain Monofilament	18" ~ 45cm	849G

¹³ Safety organizer tray

 **MultiPass**
NEEDLES MULTIPASS Needles

 **CONTROL RELEASE**

PRONOVA Suture

Taper Point

Needle	Material	Length	3-0
MH 36mm MH 1/2 Circle 	Blue Monofilament	36" ~ 90cm	3842H



Needle	Material	Length	3-0	4-0	5-0
RB-1 17mm RB-1 1/2 Circle 	Blue Monofilament	24" ~ 60cm	3558H		3555H
	Blue Monofilament	36" ~ 90cm		3557H	3556H

Needle	Material	Length	5-0	6-0
RB-2 13mm RB-2 1/2 Circle 	Blue Monofilament	30" ~ 75cm	3710H	3711H

Needle	Material	Length	2-0	3-0	4-0
SH 26mm SH 1/2 Circle 	Blue Monofilament	36" ~ 90cm	3523H	3522H	3521H

Sutures : Non Absorbable / PRONOVA Suture

Needle	Material	Length	3-0	4-0
SH-1 22mm SH-1 1/2 Circle 	Blue Monofilament	30" ~ 75cm	3762H	3526H





Needle	Material	Length	5-0
TF 13mm TF 1/2 Circle 	Blue Monofilament	24" ~ 60cm	3205H 



Needle	Material	Length	3-0	4-0	5-0
BB 17mm BB 3/8 Circle 	Blue Monofilament	24" ~ 60cm	3862H	3861H 3581H	
	Blue Monofilament	36" ~ 90cm			3580H



Needle	Material	Length	6-0	7-0
BV 11mm BV 3/8 Circle 	Blue Monofilament	4-24" ~ 60cm		M3600
	Blue Monofilament	24" ~ 60cm	3776H	

Needle	Material	Length	6-0	7-0

Sutures : Non Absorbable / PRONOVA Suture

Needle	Material	Length	6-0	7-0
BV-1 9.3mm BV-1 3/8 Circle 	Blue Monofilament	18" ~ 45cm	3806H 3305H 	3701H
	Blue Monofilament	4-18" ~ 45cm		M3701
	Blue Monofilament	24" ~ 60cm	3805H 3709H	3304H  3702H
	Blue Monofilament	4-24" ~ 60cm	M3805	M3304  M3702
	Blue Monofilament	4-30" ~ 75cm	M3709	M3703
	Blue Monofilament	30" ~ 75cm		3703H

Needle	Material	Length	8-0
BV130-5 6.5mm BV130-5 3/8 Circle  	Blue Monofilament	18" ~ 45cm	3730H 3730H33 3732H
	Blue Monofilament	2-24" ~ 60cm	M3739
	Blue Monofilament	24" ~ 60cm	3732H33

Needle	Material	Length	7-0	8-0
BV175-6 8.0mm BV175-6 3/8 Circle  	Blue Monofilament	24" ~ 60cm	3735H	3741H
	Blue Monofilament	4-24" ~ 60cm	M3735	
	Blue Monofilament	2-24" ~ 60cm	M3737	M3743

Needle	Material	Length	7-0	8-0
--------	----------	--------	-----	-----

Sutures : Non Absorbable / PRONOVA Suture

Needle	Material	Length	7-0	8-0
BV175-8 9.3mm BV175-8 3/8 Circle 	Blue Monofilament	2-24" ~ 60cm	M3747	M3753

Needle	Material	Length	5-0	6-0
C-1 13mm C-1 3/8 Circle 	Blue Monofilament	18" ~ 45cm	3717H 3725H	
	Blue Monofilament	4-24" ~ 60cm	M3725	M3726
	Blue Monofilament	24" ~ 60cm		3726H 3307H VB
	Blue Monofilament	30" ~ 75cm	3321H VB	3706H
	Blue Monofilament	4-30" ~ 75cm		M3307 VB M3706
	Blue Monofilament	36" ~ 90cm	3720H	
	Blue Monofilament	4-36" ~ 90cm	M3720	

Needle	Material	Length	7-0	8-0
BV175-7 8.0mm BV175-7 3/8 Circle 	Blue Monofilament	2-18" ~ 45cm	M3768 M3766	M3769
	Blue Monofilament	2-24" ~ 60cm		M3767
	Blue Monofilament	4-24" ~ 60cm	M3770	

TAPERCUT

Sutures : Non Absorbable / PRONOVA Suture

Needle	Material	Length	3-0	4-0
V-7 26mm V-7 1/2 Circle 	Blue Monofilament	36" ~ 90cm	3976H	3975H

Needle	Material	Length	6-0	7-0
CC 9.3mm CC 3/8 Circle 	Blue Monofilament	4-24" ~ 60cm	M3807	
	Blue Monofilament	24" ~ 60cm		3704H

Needle	Material	Length	6-0
CC-1 13mm CC-1 3/8 Circle 	Blue Monofilament	30" ~ 75cm	3707H

 **MultiPass** NEEDLES MULTIPASS Needles

 **VISI-BLACK**

ETHIBOND EXCEL Suture

Conventional Cutting - Sternum

Needle	Material	Length	5
CCS 48mm 1/2 Circle 	Green Braided	4-30" ~ 75cm	MB47G

Precision Point - Reverse Cutting

Needle	Material	Length	4-0
PS-4 16mm 1/2 Circle 	White Braided	18" ~ 45cm	X695G

Needle	Material	Length	6-0
P-1 11mm 3/8 Circle 	Green Braided	18" ~ 45cm	X697G



Needle	Material	Length	5-0
P-3 13mm 3/8 Circle 	Green Braided	18" ~ 45cm	X698G

Sutures : Non Absorbable / ETHIBOND EXCEL Suture

Needle	Material	Length	4-0
PS-2 19mm 3/8 Circle 	White Braided	18" ~ 45cm	X692G

Needle	Material	Length	5-0
PS-3 16mm 3/8 Circle 	Green Braided	18" ~ 45cm	X681G

Reverse Cutting

Needle	Material	Length	0	1
OS-2 17mm 1/2 Circle 	Green Braided	3-18" ~ 45cm	CX74T [®] 	CX75T [®] 

Needle	Material	Length	0	1	2
OS-4 22mm 1/2 Circle 	Green Braided	30" ~ 75cm	X517H	X518H	X519H

Needle	Material	Length	1
OS-6 36mm 1/2 Circle 	Green Braided	30" ~ 75cm	X538H

Sutures : Non Absorbable / ETHIBOND EXCEL Suture

Needle	Material	Length	1
OS-8 40mm 1/2 Circle 	Green Braided	30" ~ 75cm	X548H

Needle	Material	Length	2-0
FS 26mm 3/8 Circle 	Green Braided	18" ~ 45cm	X664H

Needle	Material	Length	3-0
FS-1 24mm 3/8 Circle 	Green Braided	18" ~ 45cm	X663H

Needle	Material	Length	4-0
FS-2 19mm 3/8 Circle 	Green Braided	18" ~ 45cm	X683G

Needle	Material	Length	2	5

Sutures : Non Absorbable / ETHIBOND EXCEL Suture

Needle	Material	Length	2	5
LR 75mm 3/8 Circle 	Green Braided	20" ~ 50cm	X406T	B409T

Needle	Material	Length	2	5
LR 75mm LR 3/8 Circle 	Green Braided	30" ~ 75cm	X496T	B499T



Straight Cutting Needles



Needle	Material	Length	3-0
KS 60mm Straight 	Green Braided	30" ~ 75cm	X622H



SUTUPAK Pre-Cut Sutures

Needle	Material	Length	0	2-0	3-0	4-0	5-0
SUTUPAK Pre-Cut Sutures N/A 	Green Braided	6-18" ~ 45cm	X186H X306H				
	Green Braided	12-18" ~ 45cm		X185H	X184H	X183H	X182H
	Green Braided	12-30" ~ 75cm		X305H	X304H	X303H	

Taper Point

Needle	Material	Length	0	1	2-0
CT-1 36mm 1/2 Circle 	Green Braided	8-18" ~ 45cm	CX21D ¹³ 		CX22D ¹³ 
	Green Braided	18" ~ 45cm	X424H		
	Green Braided	30" ~ 75cm		X425H	X423H



Needle	Material	Length	0	2-0
CT-2 26mm 1/2 Circle 	Green Braided	8-18" ~ 45cm	CX27D ¹³ 	CX26D ¹³ 
	Green Braided	18" ~ 45cm	X412H	
	Green Braided	30" ~ 75cm		X411H



Needle	Material	Length	0	1
CTX 48mm 1/2 Circle 	Green Braided	8-18" ~ 45cm	CX31D ¹³ 	CX30D ¹³ 
	Green Braided	18" ~ 45cm	X864H	
	Green Braided	30" ~ 75cm		X865H

Needle	Material	Length	0	2-0
--------	----------	--------	---	-----

Sutures : Non Absorbable / ETHIBOND EXCEL Suture

Needle	Material	Length	0	2-0
MH 36mm MH 1/2 Circle 	Green Braided	36" ~ 90cm	X844H	X843H X843H

Needle	Material	Length	0	2-0
MO-6 26mm 1/2 Circle 	Green Braided	8-18" ~ 45cm	CX45D ¹³ 	CX46D ¹³ 





Needle	Material	Length	0	2-0
MO-7 22mm 1/2 Circle 	Green Braided	8-18" ~ 45cm	CX41D ¹³ 	CX42D ¹³ 

Needle	Material	Length	2-0	3-0	4-0	5-0
RB-1 17mm 1/2 Circle 	Green Braided	30" ~ 75cm	X873H	X872H	X871H	X870H

Needle	Material	Length	2-0	3-0	4-0	5-0

Sutures : Non Absorbable / ETHIBOND EXCEL Suture

Needle	Material	Length	2-0	3-0	4-0	5-0
RB-1 17mm RB-1 1/2 Circle 	Green & White Braided	10-30" ~ 75cm	10X42 SXX43 ^{1,22}			
	Green & White Braided	8-30" ~ 75cm	PXX41 PXX43 ²⁰			
	White Braided	4-30" ~ 75cm	MX523			
	Green Braided	4-30" ~ 75cm	MX553	MX552	MX551 ¹	
	Green Braided	30" ~ 75cm		X558H	X551H	X550H
	Green Braided	36" ~ 90cm			X557H	X556H

Needle	Material	Length	0	2-0	3-0	4-0
SH 26mm 1/2 Circle 	Green Braided	8-18" ~ 45cm		CX12D ¹³ 	CX13D ¹³ 	CX14D ¹³ 
	Green Braided	18" ~ 45cm	X834H			
	Green Braided	4-30" ~ 75cm		MX833		
	Green Braided	30" ~ 75cm		X833H	X832H	X831H
	White Braided	4-30" ~ 75cm		MX823		

Needle	Material	Length	0	2-0	3-0	4-0
--------	----------	--------	---	-----	-----	-----

Sutures : Non Absorbable / ETHIBOND EXCEL Suture

Needle	Material	Length	0	2-0	3-0	4-0
SH 26mm SH 1/2 Circle 	Green & White Braided	10-30" ~ 75cm	PXX87 ^{1, 21}	PXX76 SXP76 ^{1, 23} SXX86 ^{1, 20} 10X82		
	Green & White Braided	10-36" ~ 90cm		10X86 PXX86 ^{1, 21} SXP86		
	Green & White Braided	6-36" ~ 90cm		PXX85		
	Green Braided	4-30" ~ 75cm		MX563		
	Green Braided	30" ~ 75cm	X524H	X563H	X562H	
	Green Braided	36" ~ 90cm		SX14H ²⁰ PX514 SXP02 X523H	X522H	
	White Braided	36" ~ 90cm		X513H		
	Green	36" ~ 90cm				X521H

Needle	Material	Length	2-0	3-0	4-0
SH-1 22mm SH-1 1/2 Circle 	Green Braided	4-30" ~ 75cm	MX763 ¹		
	Green Braided	30" ~ 75cm	X763H		
	Green Braided	36" ~ 90cm		X762H	
	Green & White Braided	10-30" ~ 75cm	PXX92		
	Green	36" ~ 90cm			X761H

Needle	Material	Length	2-0
--------	----------	--------	-----

Sutures : Non Absorbable / ETHIBOND EXCEL Suture

Needle	Material	Length	2-0
SH-2 20mm SH-2 1/2 Circle 	Green Braided	30" ~ 75cm	PX82H ²¹ X582H PX82H ²¹ X582H X559H
	Green Braided	36" ~ 90cm	X559H
	White Braided	30" ~ 75cm	PX83H PX83H
	Green & White Braided	10-30" ~ 75cm	PXX80
	White & Green Braided	10-30" ~ 75cm	PXX82 SXP82 ^{1,23}

Needle	Material	Length	4-0	5-0
TF 13mm TF 1/2 Circle 	Green Braided	24" ~ 60cm	X204H	X205H

Needle	Material	Length	2-0
UCL 14mm 1/2 Circle 	Green Braided	27" ~ 70cm	X114H

Needle	Material	Length	1
---------------	-----------------	---------------	----------

Sutures : Non Absorbable / ETHIBOND EXCEL Suture

Needle	Material	Length	1
XLH 70mm XLH 1/2 Circle 	Green Braided	30" ~ 75cm	X190G

Needle	Material	Length	4-0
BB 17mm 3/8 Circle 	Green Braided	30" ~ 75cm	X881H

Needle	Material	Length	3-0	4-0	5-0
BB 17mm BB 3/8 Circle 	Green Braided	30" ~ 75cm	X588H	X581H	X580H

Needle	Material	Length	6-0	7-0
BV-1 9.3mm BV-1 3/8 Circle 	Green Braided	10-18" ~ 45cm		10X07 ¹
	Green Braided	18" ~ 45cm	X805H	X701H

Needle	Material	Length	5-0	6-0

Sutures : Non Absorbable / ETHIBOND EXCEL Suture

Needle	Material	Length	5-0	6-0
C-1 13mm 3/8 Circle 	Green Braided	30" ~ 75cm	X890H	X889H

Needle	Material	Length	4-0	5-0	6-0
C-1 13mm C-1 3/8 Circle 	Green Braided	18" ~ 45cm	X726H	X717H	X706H
	Green Braided	30" ~ 75cm		X727H	X719H

TAPERCUT

Needle	Material	Length	0
V-34 36mm 1/2 Circle 	Green Braided	30" ~ 75cm	X444H

Needle	Material	Length	2	5
V-37 40mm 1/2 Circle 	Green Braided	4-30" ~ 75cm	MX69G	MB66G

Needle	Material	Length	5

Sutures : Non Absorbable / ETHIBOND EXCEL Suture

Needle	Material	Length	5
V-40 48mm 1/2 Circle 	Green Braided	4-30" ~ 75cm	MB46G ¹

Needle	Material	Length	5-0
V-5 17mm 1/2 Circle 	Green Braided	30" ~ 75cm	X951H

Needle	Material	Length	2-0	3-0
V-7 26mm 1/2 Circle 	Green Braided	30" ~ 75cm	X964H	X963H

Needle	Material	Length	2-0	3-0	4-0	5-0

Sutures : Non Absorbable / ETHIBOND EXCEL Suture

Needle	Material	Length	2-0	3-0	4-0	5-0
V-5 17mm V-5 1/2 Circle 	White & Green Braided	10-30" ~ 75cm	10X52 ¹ PXX52 ^{1,21} SXP52 ^{1,23} SXP54 ^{1,22} SXX54 ^{1,20}	10X53		
	White & Green Braided	8-30" ~ 75cm	PXX50 SXX50 ²⁰	SXX53 ²⁰		
	White Braided	4-30" ~ 75cm	MPX17			
	White Braided	30" ~ 75cm	X917H PX17H	X916H		
	White Braided	36" ~ 90cm	SX17H			
	Green Braided	4-30" ~ 75cm	MPX37			
	Green Braided	30" ~ 75cm	PX937 ^{21,3} X937H	X936H	X935H	X934H
	Green Braided	36" ~ 90cm	PX54H SX54H X807H	X806H		

Needle	Material	Length	0	2-0	3-0	4-0
---------------	-----------------	---------------	----------	------------	------------	------------

Sutures : Non Absorbable / ETHIBOND EXCEL Suture

Needle	Material	Length	0	2-0	3-0	4-0
V-7 26mm V-7 1/2 Circle 	White & Green Braided	10-30" ~ 75cm		10X72 ¹ PXX77 ^{1,21} SXP77		
	White & Green Braided	8-30" ~ 75cm		PXX72		
	White & Green Braided	10-36" ~ 90cm		10X66		
	White & Green Braided	8-36" ~ 90cm		PXX79		
	Green Braided	4-30" ~ 75cm		MPX77 MX977 ¹		
	Green Braided	30" ~ 75cm		PX977 ^{21,3} SXP07 X977H	X976H	X975H
	Green Braided	36" ~ 90cm	X905H	PX62H X966H		
	White Braided	30" ~ 75cm	PX65H	X987H		
	White Braided	36" ~ 90cm		PX64H		

Needle	Material	Length	5-0	6-0
CC-1 13mm CC-1 3/8 Circle 	Green Braided	30" ~ 75cm	X728H	
	Green Braided	30" ~ 75cm		X720H

Needle	Material	Length	4-0
V-4 17mm 3/8 Circle 	Green Braided	30" ~ 75cm	X942H

Sutures : Non Absorbable / ETHIBOND EXCEL Suture

Needle	Material	Length	2-0	3-0	4-0
V-4 17mm V-4 3/8 Circle 	Green Braided	4-30" ~ 75cm	MPX27 ^{1,21} MX927 ¹		
	Green Braided	30" ~ 75cm	X927H	X926H	X925H
	White Braided	4-30" ~ 75cm	MX944		
	White & Green Braided	10-30" ~ 75cm	PXX22 SXP22 ^{1,23}		

Trocar Point

Needle	Material	Length	2-0
STP-10 254mm STP-10 Straight 	Green Braided	27" ~ 70cm	X997G

¹ One dozen packets per box

³ Three dozen packets per box

⁵ Single strand delivery

¹³ Safety organizer tray

²⁰ 1/8 x 1/8 x 1/16 (3.0mm x 3.0mm x 1.5 mm) Firm TFE Polymer Pledgets

²¹ 1/4 x 1/8 x 1/16 (7.0mm x 3.0mm x 1.5 mm) Firm TFE Polymer Pledgets

²² 1/8 x 1/8 x 1/16 (3.0mm x 3.0mm x 1.5 mm) Soft TFE Polymer Pledgets

²³ 1/4 x 1/8 x 1/16 (7.0mm x 3.0mm x 1.5 mm) Soft TFE Polymer Pledgets





ETHILON Suture

Endoscopic Needles

Needle	Material	Length	10-0
ST100-3 Straight Taper Point 	Black Monofilament	5" ~ 13cm	2849G

MICROPOINT - Spatula

Needle	Material	Length	10-0
TG160-4 5.5mm TG160-4 1/2 Circle 	Black Monofilament	12" ~ 30cm	7707G

Needle	Material	Length	10-0
TG160-4-3M 4.3mm TG160-4-3M 1/2 Circle 	Black Monofilament	8" ~ 20cm	7711G

Needle	Material	Length	10-0	9-0
TG160-6 5.5mm TG160-6 1/2 Circle 	Black Monofilament	12" ~ 30cm	7756G 7757G	7760G
	Black Monofilament	6" ~ 15cm	7757G33	

Sutures : Non Absorbable / ETHILON Suture

Needle	Material	Length	8-0
TG175-8 7.0mm TG175-8 1/2 Circle 	Black Monofilament	12" ~ 30cm	1716G 1716G05 1716G33

Needle	Material	Length	8-0
TG100-8 6.5mm TG100-8 1/4 Circle 	Black Monofilament	12" ~ 30cm	1714G 1714G33



Needle	Material	Length	10-0
TG140-6 6.5mm TG140-6 3/8 Circle 	Black Monofilament	12" ~ 30cm	7770G



Needle	Material	Length	10-0	9-0
TG140-8 6.5mm TG140-8 3/8 Circle 	Black Monofilament	12" ~ 30cm	7718G	7717G



Needle	Material	Length	9-0
VAS100-4 5.1mm 3/8 Circle 	Black Monofilament	6" ~ 15cm	2890G 2890G33

Precision Cosmetic - Conventional Cutting PRIME

Needle	Material	Length	5-0
PC-12 16mm 1/2 Circle 	Black Monofilament	18" ~ 45cm	1845G ¹ 1945G ⁶⁵

Needle	Material	Length	4-0	5-0	6-0
PC-1 13mm 3/8 Circle  	Black Monofilament	18" ~ 45cm	1854G ⁶⁵ 1954G ⁶⁵	1855G ⁶⁵ 1955G ⁶⁵	1856G ⁶⁵ 1956G ⁶⁵

Needle	Material	Length	4-0	5-0	6-0
PC-3 16mm 3/8 Circle  	Black Monofilament	18" ~ 45cm	1864G ⁶⁵ 1964G	1865G ⁶⁵ 1965G ⁶⁵	1866G ⁶⁵ 1966G 1966G33

Needle	Material	Length	3-0	4-0	5-0
PC-5 19mm 3/8 Circle  	Black Monofilament	18" ~ 45cm	1893G ¹ 1993G ^{1,65} 1893G33 1993G33	1894G ¹ 1994G ^{1,65} 1994G33	1895G ¹ 1995G ⁶⁵

Precision Point - Reverse Cutting

Needle	Material	Length	4-0	5-0	6-0
--------	----------	--------	-----	-----	-----

Sutures : Non Absorbable / ETHILON Suture

Needle	Material	Length	4-0	5-0	6-0
PS-4 16mm 1/2 Circle 	Undyed Monofilament	18" ~ 45cm	1603G 1603G33		
	Black Monofilament	18" ~ 45cm	1662G	1661G	1660G ⁶⁵

Needle	Material	Length	none	5-0	6-0	7-0
P-1 11mm 3/8 Circle 		18" ~ 45cm	1696G34			
	Green Monofilament	18" ~ 45cm		G695G		
	Undyed	18" ~ 45cm			689G	
	Black Monofilament	18" ~ 45cm			697G 697H ⁶⁵	1696G
	Green	18" ~ 45cm			G697G	

Needle	Material	Length	none	4-0	5-0	6-0
P-3 13mm 3/8 Circle 		18" ~ 45cm	698G34			
	Undyed Monofilament	18" ~ 45cm		691G	690G	
	Black Monofilament	18" ~ 45cm		699G 699H ⁶⁵	698G 698H ⁶⁵	1698G
	Green	18" ~ 45cm			G698G	G696G

Needle	Material	Length	7-0
P-6 8.0mm 3/8 Circle 	Black Monofilament	18" ~ 45cm	1647G

Needle	Material	Length	2-0
--------	----------	--------	-----

Sutures : Non Absorbable / ETHILON Suture

Needle	Material	Length	2-0
PS 26mm 3/8 Circle 	Black Monofilament	18" ~ 45cm	585H

Needle	Material	Length	3-0
PS-1 24mm 3/8 Circle 	Black Monofilament	18" ~ 45cm	1663G ⁶⁵ 1663H ⁶⁵ 1663H33

Needle	Material	Length	2-0	3-0	4-0	5-0
PS-2 19mm 3/8 Circle 	Black Monofilament	18" ~ 45cm	593H	1669H ⁶⁵	1667G 1667H ⁶⁵	1666G 1666H ⁶⁵
	Undyed Monofilament	18" ~ 45cm			1611G 1611G33	
	Green	18" ~ 45cm			G667G	G666G

Needle	Material	Length	5-0	6-0
PS-3 16mm 3/8 Circle 	Black Monofilament	18" ~ 45cm	1668G ⁶⁵ 1668H ⁶⁵	1665G ⁶⁵

Needle	Material	Length	3-0	4-0
PSL 30mm 3/8 Circle 	Black Monofilament	30" ~ 75cm	1691H	562H

Sutures : Non Absorbable / ETHILON Suture

Needle	Material	Length	2-0	3-0
PSLX 40mm 3/8 Circle 	Black Monofilament	30" ~ 75cm	1697H	1683H

Reverse Cutting

Needle	Material	Length	3-0
X-1 22mm 1/2 Circle 	Black Monofilament	18" ~ 45cm	642G ⁶⁵

Needle	Material	Length	6-0
C-2 13mm 3/8 Circle 	Black Monofilament	18" ~ 45cm	667G

Needle	Material	Length	5-0
C-3 13mm 3/8 Circle 	Black Monofilament	18" ~ 45cm	668G

Needle	Material	Length	2-0
FS 26mm 3/8 Circle 	Black Monofilament	18" ~ 45cm	664G 664H

Sutures : Non Absorbable / ETHILON Suture

Needle	Material	Length	3-0	4-0
FS-1 24mm 3/8 Circle 	Black Monofilament	18" ~ 45cm	663G 663H 669H	1629H

Needle	Material	Length	4-0	5-0
FS-2 19mm 3/8 Circle 	Black Monofilament	18" ~ 45cm	662G 662H	661G ⁶⁵ 661H ⁶⁵

Needle	Material	Length	3-0	4-0
FSL 30mm 3/8 Circle 	Black Monofilament	30" ~ 75cm	1671H	1670H 1670H33

Needle	Material	Length	2-0	3-0
FSLX 40mm 3/8 Circle 	Black Monofilament	30" ~ 75cm	1674H	1673H 1673H33

Needle	Material	Length	2
LR 75mm 3/8 Circle 	Black Monofilament	20" ~ 50cm	460T 470G ⁴⁰ 460T33

Sutures : Non Absorbable / ETHILON Suture

Needle	Material	Length	1	2
LR 75mm LR 3/8 Circle 	Black Monofilament	30" ~ 75cm	489T 489T05	490T 490T05

SABRELOC - Center Point Spatula

Needle	Material	Length	none	5-0
RD-1 8.0mm RD-1 1/4 Circle 		18" ~ 45cm	749G34	
	Black Monofilament	18" ~ 45cm		749G 749G33

SABRELOC - Spatula

Needle	Material	Length	5-0
S-22 8.0mm S-22 1/2 Circle 	Black Monofilament	18" ~ 45cm	1740G ⁶⁵

Needle	Material	Length	5-0
S-24 8.0mm S-24 1/4 Circle 	Black Monofilament	18" ~ 45cm	7731G

Straight Cutting Needles

Needle	Material	Length	2-0	3-0	4-0
KS 60mm Straight 	Black Monofilament	30" ~ 75cm	628H	627H	626H

Taper Point

Needle	Material	Length	0
CT 40mm 1/2 Circle 	Black Monofilament	96" ~ 244cm	L886T ¹⁵

Needle	Material	Length	1
CTX 48mm 1/2 Circle 	Black Monofilament	30" ~ 75cm	830H

Needle	Material	Length	0	1	2
TP-1 65mm 1/2 Circle 	Black Monofilament	48" ~ 122cm	L880G33	824G	
	Black Monofilament	60" ~ 150cm			825G 825G33
	Black Monofilament Loop	60" ~ 150cm	L880G		

Sutures : Non Absorbable / ETHILON Suture

Needle	Material	Length	10-0	8-0	9-0
BV130-3 3.8mm 3/8 Circle 	Black Monofilament	5" ~ 13cm	2820G	2822G	2819G

Needle	Material	Length	8-0	9-0
BV130-4 5.0mm 3/8 Circle 	Black Monofilament	5" ~ 13cm	2815G	2813G

Needle	Material	Length	10-0	8-0	9-0
BV130-5 6.5mm 3/8 Circle 	Black Monofilament	5" ~ 13cm	2810G	2808G	2809G

Needle	Material	Length	9-0
BV130-5 6.5mm BV130-5 3/8 Circle 	Black Monofilament	10" ~ 25cm	2800G

Needle	Material	Length	11-0
BV50-3 4.1mm 3/8 Circle 	Black Monofilament	5" ~ 13cm	2881G

Sutures : Non Absorbable / ETHILON Suture

Needle	Material	Length	10-0
BVH100-3 4.8mm 1/2 Circle 	Black Monofilament	5" ~ 13cm	2860G

Needle	Material	Length	10-0
BV100-3 3.9mm 3/8 Circle 	Black Monofilament	9-5" ~ 13cm	2889 ^{0 14}

Needle	Material	Length	10-0	9-0
BV100-4 5.1mm 3/8 Circle 	Black Monofilament	5" ~ 13cm	2830G	2829G

Needle	Material	Length	10-0
BV75-3 3.8mm 3/8 Circle 	Black Monofilament	5" ~ 13cm	2870G
	Black Monofilament	9-5" ~ 13cm	2888 ^{0 14}

Needle	Material	Length	10-0
BV75-4 5.1mm 3/8 Circle 	Black Monofilament	5" ~ 13cm	2850G



TAPERCUT

Needle	Material	Length	9-0
V100-3 3.5mm 1/4 Circle 	Black Monofilament	5" ~ 13cm	2894G

Needle	Material	Length	8-0	9-0
V130-3 3.8mm 1/4 Circle 	Black Monofilament	5" ~ 13cm	2897G	2898G

Needle	Material	Length	10-0
V75-3 3.5mm 1/4 Circle 	Black Monofilament	5" ~ 13cm	2892G

ULTIMA - Spatula

Needle	Material	Length	10-0
CS160-6 5.5mm 1/2 Circle 	Black Monofilament	4" ~ 10cm	9061G  9061G33

Needle	Material	Length	10-0	11-0	9-0
--------	----------	--------	------	------	-----



Sutures : Non Absorbable / ETHILON Suture

Needle	Material	Length	10-0	11-0	9-0
CS160-6 5.5mm CS160-6 1/2 Circle 	Black Monofilament	12" ~ 30cm	9000G 9001G		9011G
	Black Monofilament	6" ~ 15cm	9001G05	9016G	
	Black Monofilament	8" ~ 20cm		9016G05 9016G33	



Needle	Material	Length	10-0
CS160-8 5.5mm CS160-8 1/2 Circle 	Black Monofilament	12" ~ 30cm	9030G 9031G

Needle	Material	Length	10-0
CS175-6 7.0mm CS175-6 1/2 Circle 	Black Monofilament	12" ~ 30cm	9002G 9002G33

Needle	Material	Length	10-0	8-0	9-0
CS175-8 7.0mm CS175-8 1/2 Circle 	Black Monofilament	12" ~ 30cm	9032G	9038G	9036G 9036G33

Needle	Material	Length	10-0
CS44-6 5.5mm 1/8 Circle 	Black Monofilament	4" ~ 10cm	9065G 

Sutures : Non Absorbable / ETHILON Suture

Needle	Material	Length	10-0
CS140-6 6.5mm 3/8 Circle 	Black Monofilament	4" ~ 10cm	9060G  9060G05 9060G33

Needle	Material	Length	10-0	9-0
CS140-6 6.5mm CS140-6 3/8 Circle 	Black Monofilament	12" ~ 30cm	9003G 9003G05	9013G 9013G05

Needle	Material	Length	10-0
CS140-8 6.5mm CS140-8 3/8 Circle 	Black Monofilament	12" ~ 30cm	9033G

Nonsterile

¹ One dozen packets per box

¹⁴ 8 packets (72 strands) per box

¹⁵ This product has a loop length that is half of the length specified here.

⁴⁰ Lead shot and bolster

⁶⁵ Pliabilized

 **MULTIPASS** Needles

 **HEMO-SEAL**

MERSILENE Suture

Blunt Point

Needle	Material	Length	5MM
BP 80mm BP 1/2 Circle 	White Woven	12" ~ 30cm	RS20 ¹⁰

Needle	Material	Length	none	5MM
BP-1 65mm BP-1 1/2 Circle 		12" ~ 30cm	RS2134	
	White Woven	12" ~ 30cm		RS21

MICROPOINT - Spatula



Needle	Material	Length	11-0
TG160-4 5.5mm TG160-4 1/2 Circle 	Green Monofilament	12" ~ 30cm	R750G R750G33

Sutures : Non Absorbable / MERSILENE Suture

Needle	Material	Length	11-0
TG160-4-3M 4.3mm TG160-4-3M 1/2 Circle 	Green Monofilament	8" ~ 20cm	R749G

Precision Point - Reverse Cutting

Needle	Material	Length	6-0
P-1 11mm 3/8 Circle 	White Braided	18" ~ 45cm	R689G

Needle	Material	Length	4-0	5-0
P-3 13mm 3/8 Circle  	White Braided	18" ~ 45cm	R691G	R690G

Reverse Cutting

Needle	Material	Length	none	2-0
FS 26mm 3/8 Circle 		18" ~ 45cm	R665H25	
	White Braided	18" ~ 45cm		R665H

Needle	Material	Length	3-0
--------	----------	--------	-----

Sutures : Non Absorbable / MERSILENE Suture

Needle	Material	Length	3-0
FS-1 24mm 3/8 Circle 	White Braided	18" ~ 45cm	R647H

Needle	Material	Length	4-0
FS-2 19mm 3/8 Circle 	White Braided	18" ~ 45cm	R633H

Needle	Material	Length	1
LR 75mm LR 3/8 Circle 	Green Braided	30" ~ 75cm	R495T

SABRELOC - Center Point Spatula

Needle	Material	Length	5-0
RD-1 8.0mm RD-1 1/4 Circle 	Green Braided	18" ~ 45cm	740G
	White Braided	18" ~ 45cm	746G 746G33

SABRELOC - Conventional Spatula

Needle	Material	Length	4-0
--------	----------	--------	-----

Sutures : Non Absorbable / MERSILENE Suture

Needle	Material	Length	4-0
S-4 8.0mm S-4 1/4 Circle 	White Braided	18" ~ 45cm	1778G 1778G05

SABRELOC - Spatula

Needle	Material	Length	4-0
S-2 8.0mm S-2 1/2 Circle 	White Braided	18" ~ 45cm	1779G 1779G05 1779G33

Needle	Material	Length	5-0	6-0
S-14 8.0mm S-14 1/4 Circle 	White Braided	18" ~ 45cm	1760G	1722G

Needle	Material	Length	4-0	5-0
S-24 8.0mm S-24 1/4 Circle 	Green Braided	18" ~ 45cm	1762G	1761G 1761G05
	White Braided	18" ~ 45cm		1764G

Taper Point

Needle	Material	Length	0

Sutures : Non Absorbable / MERSILENE Suture

Needle	Material	Length	0	
CT-1 36mm 1/2 Circle 	Green Braided	8-18" ~ 45cm	MR21T	
	Green Braided	18" ~ 45cm	R424H	

Needle	Material	Length	5MM	
CTX 48mm CTX 1/2 Circle 	White Woven	12" ~ 30cm	RS22 ¹⁰ RS2233	

Needle	Material	Length	5MM	
MO-4 36mm 1/2 Circle 	White Woven	12" ~ 30cm	RS23 ¹⁰	

Needle	Material	Length	2-0	3-0
SH 26mm 1/2 Circle 	Green Braided	30" ~ 75cm	R833H	R832H

ULTIMA - Spatula

Needle	Material	Length	10-0

Sutures : Non Absorbable / MERSILENE Suture

Needle	Material	Length	10-0
CS160-6 5.5mm CS160-6 1/2 Circle 	Green Monofilament	12" ~ 30cm	R756G

Needle	Material	Length	10-0
CS140-6 6.5mm CS140-6 3/8 Circle 	Green Monofilament	12" ~ 30cm	R770G

Needle	Material	Length	10-0
CSB-6 5.0mm CSB-6 Bi-Curve 	Green Monofilament	8" ~ 20cm	R721G

¹⁰ 6 strips per box



 **MULTIPASS** Needles



NUROLON Suture



Precision Cosmetic - Conventional Cutting PRIME



Needle	Material	Length	5-0	6-0
PC-1 13mm 3/8 Circle 	Black Braided	18" ~ 45cm	5665G	5666G



Reverse Cutting



Needle	Material	Length	2-0
CP 40mm 1/2 Circle 	Black Braided	8-18" ~ 45cm	C572D ¹³ 

Needle	Material	Length	2-0	3-0
CP-2 26mm 1/2 Circle 	Black Braided	8-18" ~ 45cm	C575D ¹³ 	C576D ¹³ 





Needle	Material	Length	1
OS-8 40mm 1/2 Circle 	Black Braided	3-18" ~ 45cm	C595T ⁵ 

Needle	Material	Length	3-0
X-1 22mm 1/2 Circle 	Black Braided	8-18" ~ 45cm	C563D ¹³ 

Needle	Material	Length	4-0
FS 26mm 3/8 Circle 	Black Braided	8-18" ~ 45cm	C570D ¹³ 



Needle	Material	Length	3-0
FSL 30mm 3/8 Circle 	Black Braided	8-18" ~ 45cm	C566D ¹³ 



Taper Point



Needle	Material	Length	0	1	2-0
CT-1 36mm 1/2 Circle 	Black Braided	8-18" ~ 45cm	C521D ¹³ 	C520D ¹³ 	C522D ¹³ 
	Black Braided	18" ~ 45cm	5424H		
	Black Braided	30" ~ 75cm		5425H	



Needle	Material	Length	0	2-0
--------	----------	--------	---	-----



Sutures : Non Absorbable / NUROLON Suture

Needle	Material	Length	0	2-0
CT-2 26mm 1/2 Circle 	Black Braided	8-18" ~ 45cm	C527D ¹³ 	C526D ¹³ 





Needle	Material	Length	0	1
CTX 48mm 1/2 Circle 	Black Braided	8-18" ~ 45cm	C551D ¹³ 	C550D ¹³ 



Needle	Material	Length	0	2-0
MO-6 26mm 1/2 Circle 	Black Braided	8-18" ~ 45cm	C545D ¹³ 	C546D ¹³ 



Needle	Material	Length	0	2-0
MO-7 22mm 1/2 Circle 	Black Braided	8-18" ~ 45cm	C541D ¹³ 	C542D ¹³ 

Needle	Material	Length	3-0	4-0
RB-1 17mm 1/2 Circle 	Black Braided	8-18" ~ 45cm	C553D ¹³ 	C554D ¹³  N124T

Sutures : Non Absorbable / NUROLON Suture

Needle	Material	Length	2-0	3-0	4-0
SH 26mm 1/2 Circle 	Black Braided	8-18" ~ 45cm	C512D ¹³ 	C513D ¹³ 	C514D ¹³ 

Needle	Material	Length	2-0	3-0
SH-1 22mm 1/2 Circle 	Black Braided	8-18" ~ 45cm	C502D ¹³ 	C503D ¹³ 

Needle	Material	Length	4-0
TF 13mm 1/2 Circle 	Black Braided	8-18" ~ 45cm	C584D ¹³  N104T

⁵ Single strand delivery

¹³ Safety organizer tray

 **MULTIPASS** Needles

 **CONTROL RELEASE**

PERMA-HAND Suture

LIGAPAK Dispensing Reel

Needle	Material	Length	2-0	3-0	4-0
LIGAPAK Dispensing Reel N/A 	Black Braided	144" ~ 366cm	LA55G	LA54G	LA53G

MICROPOINT - Spatula

Needle	Material	Length	6-0	7-0
TG140-8 6.5mm TG140-8 3/8 Circle 	Black Braided	18" ~ 45cm	1732G	7733G

MICROPOINT-Reverse Cutting

Needle	Material	Length	6-0	7-0
G-7 8.0mm G-7 1/2 Circle 	Black Braided	18" ~ 45cm	765G	766G

Needle	Material	Length	6-0
G-1 11mm 3/8 Circle 	Black Braided	18" ~ 45cm	786G 786G05

Sutures : Non Absorbable / PERMA-HAND Suture

Needle	Material	Length	6-0	
G-1 11mm G-1 3/8 Circle 	Black Braided	18" ~ 45cm	780G	

Needle	Material	Length	4-0	
G-3 13mm 3/8 Circle 	Black Braided	18" ~ 45cm	789G	

Needle	Material	Length	4-0	
G-3 13mm G-3 3/8 Circle 	Black Braided	18" ~ 45cm	783G	

Needle	Material	Length	6-0	7-0
G-6 8.0mm G-6 3/8 Circle 	Black Braided	18" ~ 45cm	769G 769G33	768G 768G05

Precision Cosmetic - Conventional Cutting PRIME

Needle	Material	Length	5-0	
--------	----------	--------	-----	--

Sutures : Non Absorbable / PERMA-HAND Suture

Needle	Material	Length	5-0
PC-3 16mm 3/8 Circle 	Black Braided	18" ~ 45cm	1925G

Needle	Material	Length	4-0
PC-5 19mm 3/8 Circle 	Black Braided	18" ~ 45cm	1984G

Precision Point - Reverse Cutting

Needle	Material	Length	4-0
PS-4 16mm 1/2 Circle 	Black Braided	18" ~ 45cm	1687G

Needle	Material	Length	6-0
P-1 11mm 3/8 Circle 	Black Braided	18" ~ 45cm	639G

Needle	Material	Length	4-0	5-0	6-0
P-3 13mm 3/8 Circle 	Black Braided	18" ~ 45cm	641G	640G	1639G

Sutures : Non Absorbable / PERMA-HAND Suture

Needle	Material	Length	2-0
PS 26mm 3/8 Circle 	Black Braided	18" ~ 45cm	1588H

Needle	Material	Length	3-0
PS-1 24mm 3/8 Circle 	Black Braided	18" ~ 45cm	1684G

Needle	Material	Length	2-0	3-0	4-0	5-0
PS-2 19mm 3/8 Circle 	Black Braided	18" ~ 45cm	583H	1679H	1677G	1676G

Needle	Material	Length	5-0	6-0
PS-3 16mm 3/8 Circle 	Black Braided	18" ~ 45cm	1678H	1675H 1675H33

Needle	Material	Length	0	2-0	3-0
PSL 30mm 3/8 Circle 	Black Braided	18" ~ 45cm	580H 590H	673H	
	Black Braided	30" ~ 75cm		486H 486H33	1690H

Needle	Material	Length	2-0
PSLX 40mm 3/8 Circle 	Black Braided	30" ~ 75cm	591H

Reverse Cutting



Needle	Material	Length	2-0
CP-1 36mm 1/2 Circle 	Black Braided	30" ~ 75cm	443H

Needle	Material	Length	4-0
J-1 17mm 1/2 Circle 	Black Braided	18" ~ 45cm	734G

Needle	Material	Length	4-0
M-1 13mm 1/2 Circle 	Black Braided	8-18" ~ 45cm	M154T

Needle	Material	Length	2-0	3-0
--------	----------	--------	-----	-----

Sutures : Non Absorbable / PERMA-HAND Suture

Needle	Material	Length	2-0	3-0
X-1 22mm 1/2 Circle 	Black Braided	18" ~ 45cm	737G	632G
	Black Braided	8-18" ~ 45cm		C063D ¹³  C063D33

Needle	Material	Length	6-0
C-2 13mm C-2 3/8 Circle 	Black Braided	18" ~ 45cm	714G 714G33

Needle	Material	Length	4-0
C-3 13mm 3/8 Circle 	Black Braided	18" ~ 45cm	736G

Needle	Material	Length	4-0
C-3 13mm C-3 3/8 Circle 	Black Braided	12" ~ 30cm	735G

Needle	Material	Length	2-0
FS 26mm 3/8 Circle 	Black Braided	18" ~ 45cm	685G 685H

Sutures : Non Absorbable / PERMA-HAND Suture

Needle	Material	Length	3-0	4-0
FS-1 24mm 3/8 Circle 	Black Braided	18" ~ 45cm	684G 684H	629G

Needle	Material	Length	4-0	5-0
FS-2 19mm 3/8 Circle 	Black Braided	18" ~ 45cm	683G	682G

Needle	Material	Length	0	2-0	3-0
FSL 30mm 3/8 Circle 	Black Braided	18" ~ 45cm	678G 678H 680H	677G	
	Black Braided	30" ~ 75cm		679H	675H

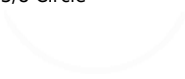
Needle	Material	Length	2-0
FSLX 40mm 3/8 Circle 	Black Braided	30" ~ 75cm	1689H

Needle	Material	Length	2	5
LR 75mm LR 3/8 Circle 	Black Braided	30" ~ 75cm	482T	485T

SABRELOC - Spatula

Needle	Material	Length	6-0
S-14 8.0mm S-14 1/4 Circle 	Black Braided	18" ~ 45cm	1780G 1780G05

Straight Cutting Needles

Needle	Material	Length	0	2-0	3-0	4-0
KS 60mm Straight 	Black Braided	30" ~ 75cm	624H	623H	622H	621H
	Black Braided	3-30" ~ 75cm			3622 ³	

Needle	Material	Length	4-0
TS 48mm Straight 	Black Braided	30" ~ 75cm	619H

Straight Taper Point

Needle	Material	Length	none	3-0
ST-1 45mm Straight 		30" ~ 75cm	K852H34	
	Black Braided	30" ~ 75cm		K852H

SUTUPAK Pre-Cut Sutures

Needle	Material	Length	0	1	2-0	2	3-0	3	4-0	4	5
SUTUPAK Pre-Cut Sutures N/A	Black Braided	17-18" ~ 45cm	SA66G		SA65H		SA64H		SA63H		
	Black Braided	13-18" ~ 45cm	SA76G								
	Black Braided	13-24" ~ 60cm		SA77G	SA75H		SA74H		SA73H		
	Black Braided	10-24" ~ 60cm	SA86G								
	Black Braided	10-30" ~ 75cm		SA87G	SA85H		SA84H		SA83H		
	Black Braided	2-30" ~ 75cm	SA6H								
	Black Braided	2-60" ~ 150cm		SA7H	SA5H	SA8H		SA9G		SA10G	SA11G



SUTUPAK Pre-Cut Sutures in Labyrinth Package



Needle	Material	Length	0	1	2-0	3-0	4-0	5-0
SUTUPAK Pre-Cut Sutures in Labyrinth Package N/A	Black Braided	6-18" ~ 45cm	A186H A306H	A187H				
	Black Braided	12-18" ~ 45cm			A185H	A184H	A183H	A182H
	Black Braided	6-30" ~ 75cm		A307H				
	Black Braided	12-30" ~ 75cm			A305H	A304H	A303H	A302H

Taper Point



Needle	Material	Length	0	2-0
--------	----------	--------	---	-----



Sutures : Non Absorbable / PERMA-HAND Suture

Needle	Material	Length	0	2-0
CT-1 36mm 1/2 Circle 	Black Braided	8-18" ~ 45cm	C021D ¹³  C021D33	C022D ¹³ 
	Black Braided	18" ~ 45cm	424H	
	Black Braided	30" ~ 75cm		423H



Needle	Material	Length	0	2-0
CT-2 26mm 1/2 Circle 	Black Braided	8-18" ~ 45cm	C027D ¹³ 	C026D ¹³ 

Needle	Material	Length	2-0
CT-3 22mm 1/2 Circle 	Black Braided	20" ~ 50cm	413H 413H33









Needle	Material	Length	0	2-0
MO-6 26mm 1/2 Circle 	Black Braided	8-18" ~ 45cm	C045D ¹³ 	C046D ¹³ 

Needle	Material	Length	0	2-0
MO-7 22mm 1/2 Circle 	Black Braided	8-18" ~ 45cm	C041D ¹³ 	C042D ¹³ 

Sutures : Non Absorbable / PERMA-HAND Suture

Needle	Material	Length	2-0	3-0	4-0	5-0
RB-1 17mm 1/2 Circle 	Black Braided	8-18" ~ 45cm		C053D ¹³ 	C054D ¹³ 	
	Black Braided	18" ~ 45cm	K873H			
	Black Braided	30" ~ 75cm		K872H	K871H	K870H



Needle	Material	Length	3-0	4-0	5-0
RB-1 17mm RB-1 1/2 Circle 	Black Braided	24" ~ 60cm	K572H	K571H	K570H



Needle	Material	Length	0	1	2-0	3-0	4-0
SH 26mm 1/2 Circle 	Black Braided	5-18" ~ 45cm			C0125 ⁵⁶ 	C0135 ⁵⁶ 	C0145 ⁵⁶ 
	Black Braided	8-18" ~ 45cm			C012D ¹³  M12T	C013D ¹³  M13T	C014D ¹³  M14T
	Black Braided	18" ~ 45cm	K834H				
	Black Braided	4-30" ~ 75cm	M834G				
	Black Braided	30" ~ 75cm		K835H	K833H	K832H	K831H
	Black Braided	8-30" ~ 75cm				C016D 	C017D 

Needle	Material	Length	0	2-0
--------	----------	--------	---	-----

Sutures : Non Absorbable / PERMA-HAND Suture

Needle	Material	Length	0	2-0
SH 26mm SH 1/2 Circle 	Black Braided	24" ~ 60cm	K534H	K533H

Needle	Material	Length	3-0	4-0
SH-1 22mm 1/2 Circle 	Black Braided	8-18" ~ 45cm	C003D ¹³  M3T	C004D ¹³ 

Needle	Material	Length	4-0	5-0
TF 13mm 1/2 Circle 	Black Braided	8-18" ~ 45cm	C084D ¹³  M104T	
	Black Braided	18" ~ 45cm	N267H	N266H

Needle	Material	Length	4-0	5-0
TF-4 8.0mm 1/2 Circle 	Black Braided	18" ~ 45cm	N272H	N271H

Needle	Material	Length	2-0	3-0	4-0	5-0
BB 17mm 3/8 Circle 	Black Braided	30" ~ 75cm	K883H	K882H	K881H	K880H

Sutures : Non Absorbable / PERMA-HAND Suture

Needle	Material	Length	4-0	5-0
BB 17mm BB 3/8 Circle 	Black Braided	24" ~ 60cm	K581H	K580H

Needle	Material	Length	6-0
BV-1 9.3mm 3/8 Circle 	Black Braided	18" ~ 45cm	K802H

Needle	Material	Length	6-0	7-0
BV-1 9.3mm BV-1 3/8 Circle 	Black Braided	18" ~ 45cm	K801H	K809H Q809H [®]
	Black Braided	10-18" ~ 45cm		10Q07 ^{1®} 10S07 ^{1®}

Needle	Material	Length	4-0	5-0	6-0
C-1 13mm 3/8 Circle 	Black Braided	12" ~ 30cm	7734G		707G
	Black Braided	18" ~ 45cm	K891H		
	Black Braided	30" ~ 75cm		K890H	K889H

Needle	Material	Length	4-0	6-0
C-1 13mm C-1 3/8 Circle 	Black Braided	18" ~ 45cm	709H	706G Q706H [®]
	Black Braided	10-18" ~ 45cm		10Q06 ^{1®}

TAPERCUT

Needle	Material	Length	4-0
V-5 17mm 1/2 Circle 	Black Braided	30" ~ 75cm	K952H

Needle	Material	Length	2-0
V-7 26mm 1/2 Circle 	Black Braided	30" ~ 75cm	K964H

Needle	Material	Length	6-0
CC-1 13mm 3/8 Circle 	Black Braided	12" ~ 30cm	7729G

Needle	Material	Length	4-0
V-4 17mm 3/8 Circle 	Black Braided	18" ~ 45cm	K945G

- ¹ One dozen packets per box
- ³ Three dozen packets per box
- ⁵ Single strand delivery
- ⁶ Two dozen packets per box
- ⁸ Siliconized silk
- ¹³ Safety organizer tray

 **MultiPass**[®] MULTIPASS Needles
NEEDLES

 **CONTROL RELEASE**

PROLENE Suture

ETHIGUARD - Safety needle

Needle	Material	Length	none	0	1
CTB-1 36mm 1/2 Circle 		30" ~ 75cm	PB20H34		
	Blue Monofilament	30" ~ 75cm		PB21H	PB20H

Needle	Material	Length	0	1
CTX-B 48mm 1/2 Circle 	Blue Monofilament	30" ~ 75cm	PB31H PB31H33	PB30H PB30H30

EVERPOINT Cardiovascular Needles

Needle	Material	Length	7-0	8-0
BV175-6 8.0mm BV175-6 3/8 Circle  EVERPOINT™ Cardiovascular Needles	Blue Monofilament	4-18" ~ 45cm	EPM8734 ¹ EPM8735	
	Blue Monofilament	2-18" ~ 45cm	EPM8736 ¹	EPM8742 ¹
	Blue Monofilament	18" ~ 45cm	EP8734H ³	EP8740H ³
	Blue Monofilament	2-24" ~ 60cm	EPM8737 ¹ EPM8733	EPM8743 ¹
	Blue Monofilament	24" ~ 60cm	EP8735H ³	EP8741H ³
	Blue Monofilament	4-24" ~ 60cm		EPM8741 ¹
	Blue Monofilament	4-30" ~ 75cm		EPM8731 ¹

Sutures : Non Absorbable / PROLENE Suture

Needle	Material	Length	7-0
CC175-8 9.3mm CC175-8 3/8 Circle  EVERPOINT™ Cardiovascular Needles	Blue Monofilament	4-24" ~ 60cm	EPM8704SL ¹ EPM8812SL
	Blue Monofilament	4-24" ~ 60cm	EPM8704SL
	Blue Monofilament	4-30" ~ 75cm	EPM8812SL

Needle	Material	Length	7-0	8-0
BV175-8 9.3mm BV175-8 3/8 Circle  EVERPOINT™ Cardiovascular Needles	Blue Monofilament	2-18" ~ 45cm	EPM8746 ¹ EPM8746 ¹	EPM8752 ¹
	Blue Monofilament	18" ~ 45cm	EP8746H ³	EP8752H ³
	Blue Monofilament	4-18" ~ 45cm	EPM8745	
	Blue Monofilament	2-24" ~ 60cm	EPM8747 ¹ EPM8755	EPM8753 ¹
	Blue Monofilament	24" ~ 60cm	EP8747H ³	EP8753H ³
	Blue Monofilament	30" ~ 75cm	EPM8751 EP8755H ³	EP8754H ³
	Blue Monofilament	4-30" ~ 75cm	EPM8751 ¹	
	Blue Monofilament	2-30" ~ 75cm		EPM8754 ¹

Needle	Material	Length	8-0
--------	----------	--------	-----

Sutures : Non Absorbable / PROLENE Suture

Needle	Material	Length	8-0
BV130-5 6.5mm BV130-5 3/8 Circle  EVERPOINT™ Cardiovascular Needles	Blue Monofilament	4-18" ~ 45cm	EPM8730 ¹ EPM8732
	Blue Monofilament	2-18" ~ 45cm	EPM8738 ¹
	Blue Monofilament	18" ~ 45cm	EP8730H ¹
	Blue Monofilament	2-24" ~ 60cm	EPM8739 ¹
	Blue Monofilament	24" ~ 60cm	EP8732H ¹

Needle	Material	Length	6-0	7-0
C-1 13mm C-1 3/8 Circle  EVERPOINT™ Cardiovascular Needles	Blue Monofilament	18" ~ 45cm	EP8718H ¹	EP8800H ¹
	Blue Monofilament	4-18" ~ 45cm	EPM8718 ¹ EPM8726	EPM8800 ¹
	Blue Monofilament	24" ~ 60cm	EP8726H ¹	
	Blue Monofilament	4-24" ~ 60cm	EPM8706	EPM8727 ¹
	Blue Monofilament	30" ~ 75cm	EP8706H ¹	EP8708H ¹
	Blue Monofilament	2-30" ~ 75cm	EPM8206 ¹	

Needle	Material	Length	6-0
C1 13mm 3/8 Circle  EVERPOINT™ Cardiovascular Needles	Blue Monofilament	30" ~ 75cm	EP8889H ¹

MICROPOINT - Spatula

Needle	Material	Length	10-0	9-0
TG140-8 6.5mm TG140-8 3/8 Circle 	Blue Monofilament	12" ~ 30cm	1771G 1757G	
	Blue Monofilament	6" ~ 15cm		1754G

Precision Cosmetic - Conventional Cutting PRIME

Needle	Material	Length	4-0	5-0	6-0
PC-1 13mm 3/8 Circle 	Blue Monofilament	18" ~ 45cm	8619G	8618G	8617G

Needle	Material	Length	none	4-0	5-0	6-0
PC-3 16mm 3/8 Circle 		18" ~ 45cm	8634G34			
	Blue Monofilament	18" ~ 45cm		8634G	8635G	8636G 8636G33

Needle	Material	Length	3-0	4-0	5-0
PC-5 19mm 3/8 Circle 	Blue Monofilament	18" ~ 45cm	8632G	8631G 8631G33	8630G 8630G33

Precision Point - Reverse Cutting

Sutures : Non Absorbable / PROLENE Suture

Needle	Material	Length	4-0
PS-4 16mm 1/2 Circle 	Undyed Monofilament	18" ~ 45cm	8603G

Needle	Material	Length	4-0	5-0
PS-5 13mm 1/2 Circle 	Blue Monofilament	18" ~ 45cm	8656G	8655G

Needle	Material	Length	none	6-0	7-0
P-1 11mm 3/8 Circle 	Blue Monofilament	18" ~ 45cm	8697G33	8697G	8696G
	Clear Monofilament	18" ~ 45cm		8606G	
	Undyed Monofilament	18" ~ 45cm		8606G33	

Needle	Material	Length	none	4-0	5-0	6-0
P-3 13mm 3/8 Circle 	Blue	18" ~ 45cm	8698G33			
	Undyed Monofilament	18" ~ 45cm		8604G	8605G	
	Blue Monofilament	18" ~ 45cm		8699G	8698G	8695G

Needle	Material	Length	7-0
P-6 8.0mm 3/8 Circle 	Blue Monofilament	18" ~ 45cm	8648G

Sutures : Non Absorbable / PROLENE Suture

Needle	Material	Length	none	3-0
PS-1 24mm 3/8 Circle 		18" ~ 45cm	8663G33	
	Blue Monofilament	18" ~ 45cm		8663G

Needle	Material	Length	none	3-0	4-0	5-0
PS-2 19mm 3/8 Circle 		18" ~ 45cm	8682H33			
	Blue Monofilament	18" ~ 45cm		8687H	8682G 8682H	8686G

Needle	Material	Length	5-0	6-0
PS-3 16mm 3/8 Circle 	Blue Monofilament	18" ~ 45cm	8681G	8680G

Reverse Cutting

Needle	Material	Length	2-0
FS 26mm 3/8 Circle 	Blue Monofilament	18" ~ 45cm	8685H

Needle	Material	Length	3-0	4-0
--------	----------	--------	-----	-----

Sutures : Non Absorbable / PROLENE Suture

Needle	Material	Length	3-0	4-0
FS-1 24mm 3/8 Circle 	Blue Monofilament	18" ~ 45cm	8684G 8684G33	8629H

Needle	Material	Length	none	3-0	4-0	5-0
FS-2 19mm 3/8 Circle 		18" ~ 45cm	8683G34			
	Blue Monofilament	18" ~ 45cm		8665G	8683G	8661G

Needle	Material	Length	3-0
FSL 30mm 3/8 Circle 	Blue Monofilament	30" ~ 75cm	8675H

Needle	Material	Length	0	2-0	3-0
FSLX 40mm 3/8 Circle 	Blue Monofilament	30" ~ 75cm	8690H	8689H	8649H

Needle	Material	Length	2
LR 75mm 3/8 Circle 	Blue Monofilament	3-20" ~ 50cm	3846T

SABRELOC - Spatula

Needle	Material	Length	none	5-0
SM-1 5.5mm SM-1 1/8 Circle 		12" ~ 30cm	7740G34	
	Blue Monofilament	12" ~ 30cm		7740G

SABRELOC - Straight Transchamber

Needle	Material	Length	none	10-0
STC-6 16mm STC-6 16mm Straight 		8" ~ 20cm	1713G34	
	Blue Monofilament	8" ~ 20cm		1713G

Straight Cutting Needles

Needle	Material	Length	2-0	3-0	4-0
KS 60mm Straight 	Blue Monofilament	30" ~ 75cm	8623H	8622H	8621H



Needle	Material	Length	2-0
TS 48mm TS Straight 	Blue Monofilament	14" ~ 35cm	8571G



Straight TAPERCUT

Needle	Material	Length	none	4-0
V-47 40mm V-47 Straight 		14" ~ 35cm	8592G34	
	Blue Monofilament	14" ~ 35cm		8592G



Taper Point

Needle	Material	Length	0	1	2-0
CT 40mm 1/2 Circle 	Blue Monofilament	30" ~ 75cm	8434H	8435H	8433H



Needle	Material	Length	0	1	2-0	3-0
CT-1 36mm 1/2 Circle 	Blue Monofilament	8-18" ~ 45cm	C821G 		C822G 	
	Blue Monofilament	18" ~ 45cm	8424H			
	Blue Monofilament	30" ~ 75cm			8425H	8423H



Needle	Material	Length	0	2-0	3-0
CT-2 26mm 1/2 Circle 	Blue Monofilament	8-18" ~ 45cm	C827G 	C826G 	
	Blue Monofilament	18" ~ 45cm	8412H		
	Blue Monofilament	30" ~ 75cm			8411H

Sutures : Non Absorbable / PROLENE Suture

Needle	Material	Length	0	1
CTX 48mm 1/2 Circle 	Blue Monofilament	8-18" ~ 45cm	C811G 	
	Blue Monofilament	18" ~ 45cm	8454H	
	Blue Monofilament	30" ~ 75cm		8455H

Needle	Material	Length	2-0	3-0
MH 36mm MH 1/2 Circle 	Blue Monofilament	36" ~ 90cm	8843H 8853H	8842H

Needle	Material	Length	0	2-0
MO-6 26mm 1/2 Circle 	Blue Monofilament	8-18" ~ 45cm	C845G 	
	Blue Monofilament	18" ~ 45cm	8418H	
	Blue Monofilament	30" ~ 75cm		8417H

Needle	Material	Length	0
MO-7 22mm 1/2 Circle 	Blue Monofilament	8-18" ~ 45cm	C841G 

Sutures : Non Absorbable / PROLENE Suture

Needle	Material	Length	3-0	4-0	5-0
RB-1 17mm RB-1 1/2 Circle 	Blue Monofilament	30" ~ 75cm	8872H	8871H	8870H

Needle	Material	Length	2-0	3-0	4-0	5-0	none
RB-1 17mm RB-1 1/2 Circle 	Blue Monofilament	18" ~ 45cm			8757H	8756H	
	Blue Monofilament	24" ~ 60cm	8559H			8555H	
	Blue Monofilament	36" ~ 90cm		8558H 9556H HS	8357H V3 8557H	8356H V3 8556H	
	Blue Monofilament	4-36" ~ 90cm			M8557 ¹	M8356 ¹ V3 M8556 ¹	
	Blue	18" ~ 45cm					8555H33

Needle	Material	Length	5-0	6-0
RB-2 13mm RB-2 1/2 Circle 	Blue Monofilament	18" ~ 45cm	8713H 8554H	8714H
	Blue Monofilament	24" ~ 60cm	8710H	
	Blue Monofilament	4-30" ~ 75cm	M8710 ¹ M871033	M8711 ¹
	Blue Monofilament	30" ~ 75cm		8711H

Needle	Material	Length	7-0
RB-3 11mm RB-3 1/2 Circle 	Blue Monofilament	24" ~ 60cm	8206H

Sutures : Non Absorbable / PROLENE Suture

Needle	Material	Length	0	2-0	3-0	4-0
SH 26mm 1/2 Circle 	Blue Monofilament	30" ~ 75cm	8834H	8833H	8832H	8831H

Needle	Material	Length	2-0	3-0	4-0
SH 26mm SH 1/2 Circle 	Blue Monofilament	36" ~ 90cm	8523H 8533H	8522H P8522 ^{21,3}	8521H
	Blue Monofilament	48" ~ 122cm		8534H	

Needle	Material	Length	3-0	4-0
SH-1 22mm SH-1 1/2 Circle 	Blue Monofilament	30" ~ 75cm	8762H	8526H

Needle	Material	Length	4-0	5-0
TF 13mm TF 1/2 Circle 	Blue Monofilament	24" ~ 60cm	8204H	8205H

Needle	Material	Length	1	2

Sutures : Non Absorbable / PROLENE Suture

Needle	Material	Length	1	2
TP-1 65mm 1/2 Circle 	Blue Monofilament	60" ~ 150cm	8824G	8825G

Needle	Material	Length	0	1
XLH 70mm 1/2 Circle 	Blue Monofilament	3-24" ~ 60cm	3844G	
	Blue Monofilament	24" ~ 60cm		8845G

Needle	Material	Length	1
XLH 70mm XLH 1/2 Circle 	Blue Monofilament	30" ~ 75cm	8190G

Needle	Material	Length	4-0
BB 17mm 3/8 Circle 	Blue Monofilament	30" ~ 75cm	8881H

Needle	Material	Length	3-0	4-0	5-0









Sutures : Non Absorbable / PROLENE Suture

Needle	Material	Length	3-0	4-0	5-0
BB 17mm BB 3/8 Circle 	Blue Monofilament	24" ~ 60cm	8862H	8861H 8381H VB	8860H
	Blue Monofilament	36" ~ 90cm		8581H	8580H

Needle	Material	Length	6-0	7-0
BV 11mm BV 3/8 Circle 	Blue Monofilament	24" ~ 60cm	8610H 8776H	
	Blue Monofilament	4-24" ~ 60cm	M8610 ¹	M8600 ¹
	Blue Monofilament	4-30" ~ 75cm	M8776 ¹	

Needle	Material	Length	5-0	6-0	7-0
--------	----------	--------	-----	-----	-----

Sutures : Non Absorbable / PROLENE Suture

Needle	Material	Length	5-0	6-0	7-0
BV-1 9.3mm BV-1 3/8 Circle 	Blue Monofilament	18" ~ 45cm	9702H 	8806H	8301H  8701H
	Blue Monofilament	4-18" ~ 45cm		M8806 ¹	M8301 ¹  M8701 ¹
	Blue Monofilament	24" ~ 60cm		8305H ⁹  8805H 8709H	8304H  8702H
	Blue Monofilament	2-24" ~ 60cm		M8205	
	Blue Monofilament	4-24" ~ 60cm		M8305 ¹  M8805 ¹ M8805 ¹	M8304 ¹  M8702 ¹
	Blue Monofilament	4-30" ~ 75cm		M8709 ¹	M8303 ¹  M8703 ¹ M8703
	Blue Monofilament	30" ~ 75cm			8703H
	Blue Monofilament	2-30" ~ 75cm			M8203

Needle	Material	Length	8-0
BV130-5 6.5mm 3/8 Circle 	Blue Monofilament	5" ~ 13cm	2775G

Needle	Material	Length	8-0

Sutures : Non Absorbable / PROLENE Suture

Needle	Material	Length	8-0
BV130-5 6.5mm BV130-5 3/8 Circle 	Blue Monofilament	18" ~ 45cm	8730H 8730H 8732H
	Blue Monofilament	4-18" ~ 45cm	M8730 ¹ M8730 ¹
	Blue Monofilament	2-18" ~ 45cm	M8738 ¹ M8738 ¹
	Blue Monofilament	4-24" ~ 60cm	M8732 ¹ M8732 ¹
	Blue Monofilament	2-24" ~ 60cm	M8739 ¹ M8739 ¹
	Blue Monofilament	24" ~ 60cm	8732H

Needle	Material	Length	7-0	8-0
BV175-6 8.0mm BV175-6 3/8 Circle 	Blue Monofilament	18" ~ 45cm	8734H 8734H01 8735H	8740H
	Blue Monofilament	4-18" ~ 45cm	M8734 ¹ M873401	
	Blue Monofilament	2-18" ~ 45cm	M8736 ¹ M873601	M8742 ¹ M874201
	Blue Monofilament	4-24" ~ 60cm	M8735 ¹ M873533 M8731	M8741 ¹
	Blue Monofilament	2-24" ~ 60cm	M8737 ¹ M873701	M8743 M874301
	Blue Monofilament	24" ~ 60cm		8741H ¹
	Blue Monofilament	2-30" ~ 75cm	M8733 ¹ M873301	
	Blue Monofilament	4-30" ~ 75cm	M873101	

Needle	Material	Length	7-0	8-0
--------	----------	--------	-----	-----

Sutures : Non Absorbable / PROLENE Suture

Needle	Material	Length	7-0	8-0
BV175-8 9.3mm BV175-8 3/8 Circle 	Blue Monofilament	18" ~ 45cm	8746H 8746H 8747H	8752H 8752H
	Blue Monofilament	2-18" ~ 45cm	M8746 ¹ M8746	M8752 ¹ M8752
	Blue Monofilament	4-24" ~ 60cm	M8745 ¹ M8745	
	Blue Monofilament	2-24" ~ 60cm	M8747 ¹ M8747	M8753 ¹ M8753
	Blue Monofilament	24" ~ 60cm	8747H 8755H	8753H 8753H
	Blue Monofilament	2-30" ~ 75cm	M8755 ¹ M8755	M8754 ¹ M8754
	Blue Monofilament	30" ~ 75cm	8755H	8754H 8754H

Needle	Material	Length	5-0	6-0
C-1 13mm 3/8 Circle 	Blue Monofilament	30" ~ 75cm	8890H	8889H

Needle	Material	Length	4-0	5-0	6-0	7-0
--------	----------	--------	-----	-----	-----	-----

Sutures : Non Absorbable / PROLENE Suture

Needle	Material	Length	4-0	5-0	6-0	7-0
C-1 13mm C-1 3/8 Circle 	Blue Monofilament	18" ~ 45cm		8717H 8325H VB	8318H VB 8718H	8800H
	Blue Monofilament	4-18" ~ 45cm		M8717	M8318 VB M8718	M8800
	Blue Monofilament	24" ~ 60cm	9706H HS	8725H	8726H	
	Blue Monofilament	4-24" ~ 60cm		M8325 VB M8725	M8726	M8727
	Blue Monofilament	30" ~ 75cm	8519H		8307H VB 8706H	8708H
	Blue Monofilament	2-30" ~ 75cm			M8206	
	Blue Monofilament	4-30" ~ 75cm			M8307 VB M8706 M8706 [†]	
	Blue Monofilament	36" ~ 90cm			8321H VB 8720H	
	Blue Monofilament	2-36" ~ 90cm			M8220	
	Blue Monofilament	4-36" ~ 90cm			M8321 VB M8720	

Needle	Material	Length	10-0	9-0
BV100-3 3.9mm 3/8 Circle 	Blue Monofilament	5" ~ 13cm	2794G	2793G

Needle	Material	Length	10-0
---------------	-----------------	---------------	-------------

Sutures : Non Absorbable / PROLENE Suture

Needle	Material	Length	10-0
BV100-4 5.1mm 3/8 Circle 	Blue Monofilament	2" ~ 5cm	2795G

Needle	Material	Length	10-0
BV75-3 3.8mm 3/8 Circle 	Blue Monofilament	5" ~ 13cm	2790G

Needle	Material	Length	7-0	8-0
BV175-7 8.0mm BV175-7 3/8 Circle 	Blue Monofilament	4-18" ~ 45cm	M8764 M876433	
	Blue Monofilament	2-18" ~ 45cm	M8765 M876533	
	Blue Monofilament	18" ~ 45cm	8766H	
	Blue Monofilament	2-24" ~ 60cm	M8766 M876633 M8768	M8767 M876733
	Blue Monofilament	4-24" ~ 60cm	M8775	
	Blue Monofilament	24" ~ 60cm	8766H33	8767 ¹
	Blue Monofilament	4-30" ~ 75cm	M8785	

TAPERCUT

Needle	Material	Length	0
--------	----------	--------	---

Sutures : Non Absorbable / PROLENE Suture

Needle	Material	Length	0
V-34 36mm 1/2 Circle 	Blue Monofilament	30" ~ 75cm	8444H

Needle	Material	Length	2-0	3-0	4-0	5-0
V-5 17mm V-5 1/2 Circle 	Blue Monofilament	36" ~ 90cm	8937H	8936H	8935H P8935 ^{21,3}	8934H

Needle	Material	Length	0	2-0	3-0	4-0
V-7 26mm V-7 1/2 Circle 	Blue Monofilament	36" ~ 90cm	8978H	8977H	8976H	8975H

Needle	Material	Length	6-0	7-0
CC 9.3mm CC 3/8 Circle 	Blue Monofilament	18" ~ 45cm	8807H	8705H 8705H
	Blue Monofilament	4-18" ~ 45cm		M8705 ¹ M8705 ¹
	Blue Monofilament	4-24" ~ 60cm	M8807 ¹ M8807 ¹	M8704 ¹ M8704 ¹
	Blue Monofilament	24" ~ 60cm	8807H	8704H 8704H01

Needle	Material	Length	5-0	6-0
--------	----------	--------	-----	-----

Sutures : Non Absorbable / PROLENE Suture

Needle	Material	Length	5-0	6-0
CC-1 13mm CC-1 3/8 Circle 	Blue Monofilament	18" ~ 45cm		8719H 8719H 8707H
	Blue Monofilament	4-18" ~ 45cm		M8719 ¹ M8719 ¹
	Blue Monofilament	4-30" ~ 75cm		M8707 ¹ M8707 ¹
	Blue Monofilament	30" ~ 75cm	8721H	8707H01
	Blue Monofilament	4-36" ~ 90cm	M8721 ¹ M8721 ¹	

Needle	Material	Length	3-0	4-0
V-4 17mm V-4 3/8 Circle 	Blue Monofilament	36" ~ 90cm	8926H	8925H

Needle	Material	Length	10-0
CIF-4 13mm CIF-4 1/4 Circle 	Blue Monofilament	8" ~ 20cm	788G



ULTIMA - Spatula

Needle	Material	Length	10-0
CS160-6 5.5mm CS160-6 1/2 Circle 	Blue Monofilament	12" ~ 30cm	7761G

Sutures : Non Absorbable / PROLENE Suture

Needle	Material	Length	10-0
CS160-6 5.5mm CTC-6 13mm 1/2 Circle 	Blue Monofilament	4" ~ 10cm	9090G

Needle	Material	Length	10-0
CS160-8 5.5mm CS160-8 1/2 Circle 	Blue Monofilament	6" ~ 15cm	1755G

Needle	Material	Length	10-0
CTC-6L 13mm CTC-6L 1/4 Circle 	Blue Monofilament	4" ~ 10cm	9091G 

Needle	Material	Length	10-0
CS140-6 6.5mm CS140-6 3/8 Circle 	Blue Monofilament	12" ~ 30cm	1710G

¹ One dozen packets per box

³ Three dozen packets per box

⁵ Single strand delivery

⁹ 1 strip per box

²¹ 1/4 x 1/8 x 1/16 (7.0mm x 3.0mm x 1.5 mm) Firm TFE Polymer Pledgets

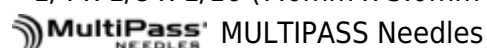

 CONTROL RELEASE

 HEMO-SEAL

 VISI-BLACK

Surgical Stainless Steel Suture

Conventional Cutting - Sternum

Needle	Material	Length	none	none	4	5	6	7
CCS 48mm 1/2 Circle 		4-18" ~ 45cm	M652G33	M653G33 M654G33 M655G33				
		2-18" ~ 45cm		M657G33				
	Monofilament B & S 22	4-18" ~ 45cm			M652G			
	Monofilament B & S 20	4-18" ~ 45cm				M653G		
	Monofilament B & S 20	2-18" ~ 45cm				M657G		
	Monofilament B & S 19	4-18" ~ 45cm					M654G	
	Monofilament B & S 18	4-18" ~ 45cm						M655G

Needle	Material	Length	none	5
CCS-1 60mm 1/2 Circle 		2-30" ~ 75cm	M436G33	
	Monofilament B & S 20	2-30" ~ 75cm		M436G

Reverse Cutting

Needle	Material	Length	none	3-0
CP-1 36mm 1/2 Circle 		20" ~ 50cm	497G33	
	Monofilament B & S 30	20" ~ 50cm		497G

Sutures : Non Absorbable / Surgical Stainless Steel Suture

Needle	Material	Length	3-0
FS-1 24mm 3/8 Circle 	Monofilament B & S 30	18" ~ 45cm	631G ²⁴

Needle	Material	Length	none	3-0	4-0
FS-2 19mm 3/8 Circle 		18" ~ 45cm	603G33		
	Monofilament B & S 30	18" ~ 45cm		607G	
	Monofilament B & S 32	18" ~ 45cm			603G

Needle	Material	Length	none	3-0
FSL 30mm 3/8 Circle 		18" ~ 45cm	606G33	
	Monofilament B & S 30	18" ~ 45cm		606G

Needle	Material	Length	none	2-0
FSLX 40mm 3/8 Circle 		18" ~ 45cm	618G33	
	Monofilament B & S 28	18" ~ 45cm		618G

Needle	Material	Length	2

Sutures : Non Absorbable / Surgical Stainless Steel Suture

Needle	Material	Length	2	
LR 75mm LR 3/8 Circle 	Monofilament B & S 24	30" ~ 75cm	467G	

Needle	Material	Length	none	2
LS-1 45mm 3/8 Circle 		4-20" ~ 50cm	M400G33	
	Monofilament B & S 24	4-20" ~ 50cm		M400G

Straight Cutting Needles

Needle	Material	Length	5-0	
KS 60mm Straight 	Monofilament B & S 35	8-16" ~ 40cm	M645G	

SUTUPAK Pre-Cut Sutures

Needle	Material	Length	0	2-0	3-0
SUTUPAK Pre-Cut Sutures N/A 	Monofilament B & S 26	17-18" ~ 45cm	SS26G		
	Monofilament B & S 28	17-18" ~ 45cm		SS28G	
	Monofilament B & S 30	17-18" ~ 45cm			SS30G

Taper Point

Needle	Material	Length	2-0
CT-1 36mm 1/2 Circle 	Monofilament B & S 28	8-18" ~ 45cm	M682G

Needle	Material	Length	2-0
CTX 48mm 1/2 Circle 	Monofilament B & S 28	8-24" ~ 60cm	M414G

TAPERCUT - Straight Cutting

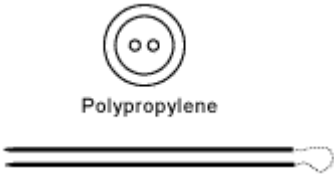
Needle	Material	Length	4-0
TS_TS 48mm TS Straight 	Monofilament B & S 32	2-14" ~ 35cm	540G ⁴¹

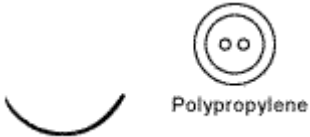
Needle	Material	Length	4-0
V-26 26mm 3/8 Circle 	Monofilament B & S 32	2-14" ~ 35cm	539G ⁴¹

TAPERCUT

Needle	Material	Length	1
V-37 40mm 1/2 Circle 	Monofilament B & S 25	4-18" ~ 45cm	M660G

Needle	Material	Length	4	5	6
V-40 48mm 1/2 Circle 	Monofilament B & S 22	4-18" ~ 45cm	M651G		
	Monofilament B & S 20	4-18" ~ 45cm		M650G	
	Monofilament B & S 20	2-18" ~ 45cm		M656G	
	Monofilament B & S 19	4-18" ~ 45cm			M649G

Needle	Material	Length	5
V-56 60mm 1/2 Circle 	Monofilament B & S 20	4-30" ~ 75cm	M435G

Temporary Pacing Wire

Needle	Material	Length	2-0
--------	----------	--------	-----

Sutures : Non Absorbable / Surgical Stainless Steel Suture

Needle	Material	Length	2-0
BB 17mm SKS 60mm 3/8 Circle 	Dk. Blue Braided Stainless Steel	24" ~ 60cm	TPW20 ¹

Needle	Material	Length	2-0
RB-1 17mm SKS 60mm 1/2 Circle Straight Cutting 	Dk. Blue Braided Stainless Steel	24" ~ 60cm	TPW10 ¹

Needle	Material	Length	0	2-0
SH 26mm SKS-3 90mm 1/2 Circle Straight Cutting 	Dk. Blue Braided Stainless Steel	24" ~ 60cm	TPW50 ¹	TPW90
	Lt. Blue & Dk. Blue Braided Stainless Steel	2-24" ~ 60cm	TPW52	TPW92
	Dk. Blue Braided Stainless Steel	24" ~ 60cm		TPW30 TPW70
	Lt. Blue & Dk. Blue Braided Stainless Steel	2-24" ~ 60cm		TPW32 TPW72

Needle	Material	Length	2-0
--------	----------	--------	-----

Sutures : Non Absorbable / Surgical Stainless Steel Suture

Needle	Material	Length	2-0
BB-1 22mm SKS-3 90mm 3/8 Circle 	Dk. Blue Braided Stainless Steel	24" ~ 60cm	TPW40 ^{1 68}
	Lt. Blue & Dk. Blue Braided Stainless Steel	2-24" ~ 60cm	TPW42

Needle	Material	Length	0	2-0
TE 31mm SKS-3 90mm 3/8 Circle 	Lt. Blue & Dk. Blue Braided Stainless Steel	2-24" ~ 60cm	TPW62 ^{1 11}	
	Dk. Blue Braided Stainless Steel	24" ~ 60cm		TPW80

¹ One dozen packets per box

¹¹ Multistrand 2" ~ 60 cm

²⁴ 5/16 x 5/16 x 1/16 (7.5mm x 7.5mm x 1.5 mm) Firm TFE Polymer Pledgets

⁴¹ Pull out wire set (includes one polypropylene button)

⁶⁸ 1.5" long scoremarks; others .875"

Product Code	Material	Size	Packaging
CLR602US	DERMABOND PRINEO Skin Closure System 2-Octyl Cyanoacrylate with mesh applicator	1~60cm Mesh Dispenser / 1~3.8ml Adhesive Applicator	2 applicators per box

DERMABOND® Adhesive

Product Code	Material	Size	Packaging
DHV12	DERMABOND Topical Skin Adhesive 2-Octyl Cyanoacrylate - High Viscosity	0.5ml	12 Applicators Per Box
DPP6	DERMABOND Propen Topical Skin Adhesive 2-Octyl Cyanoacrylate - High Viscosity with Optional Precision Tip	0.5ml	6 Applicators Per Box
DPPXL6	DERMABOND Propen XL Topical Skin Adhesive 2-Octyl Cyanoacrylate - High Viscosity	0.75ml	6 Applicators Per Box

Product Code	Material	Size	Packaging
DNX12*	DERMABOND ADVANCED Topical Skin Adhesive 2-Octyl Cyanoacrylate - Unique formulation with an easy-to-use applicator for precise control on wide and fine line applications	0.7ml	12 Applicators Per Box
DNX6*	DERMABOND ADVANCED Topical Skin Adhesive 2-Octyl Cyanoacrylate - Unique formulation with an easy-to-use applicator for precise control on wide and fine line applications	0.7ml	6 Applicators Per Box

BLAKE® Drains

BLAKE Cardio Connectors

Description	Product Code	Material
	BCC1	BLAKE Cardio Connector 1:1
	BCC2	BLAKE Cardio Connector 2:1
	BCC3	BLAKE Cardio Connector 3:1

BLAKE Silicone Drains - Flat

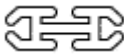
Description	Product Code	Material
	2210	7mm Flat, 3/4 Fluted
	2211	7mm Flat, Full Fluted
	2212	7mm Flat, Full Fluted, 3/16" Trocar
	2213	10mm Flat, 3/4 Fluted
	2214	10mm Flat, Full Fluted
	2215	10mm Flat, Full Fluted, 3/16" Trocar
	2216	7mm Flat, 3/4 Fluted, 3/16" Trocar
	2217	10mm Flat, 3/4 Fluted, 3/16" Trocar

BLAKE Silicone Drains - Hubless

Description	Product Code	Material
-------------	--------------	----------

Drains: BLAKE® Drains

Description	Product Code	Material
	2226	Hubless, 10 FR Round
	2227	Hubless, 10 FR Round, 1/8" Trocar
	2228	Hubless, 15 FR Round
	2229	Hubless, 15 FR Round, 3/16" Trocar
	2230	Hubless, 19 FR Round
	2231	Hubless, 19 FR Round, 1/4" Trocar
	2232	Hubless, 19 FR Round, 1/4" Bendable Trocar
	2233	Hubless, 15 FR Round, 3/16" Bendable Trocar
	2234	Hubless, 24 FR Round

J-VAC Drains

J-VAC Reservoirs - Sterile

Description	Product Code	Material
	2161	150 ml Closed Wound Drainage Reservoir
	2162	450 ml Closed Wound Drainage Reservoir
	2163	300 ml Closed Wound Drainage Reservoir
	2177	150 ml Closed Wound Drainage Reservoir
	2178	450 ml Closed Wound Drainage Reservoir
	2179	300 ml Closed Wound Drainage Reservoir

J-VAC Reservoirs - Sterile Bulbs

Description	Product Code	Material
	2160	100 cc Bulb Suction Reservoir

J-VAC Silicone Drains - Sterile



Description	Product Code	Material
	2193	J-VAC, Silicone Drain, 19 FR T Tube
	2209	J-VAC Drain Adapters
	2298	J-VAC Drain Adapters

ETHICON SECURESTRAP 5mm Absorbable Strap Fixation Device

Product Code	Material	Size	Packaging
STRAP12	5mm absorbable Fixation Device		6 devices per box
STRAP25	5mm single-use mesh fixation device w/ 25 absorbable straps		6 devices per box

MERSILENE Mesh

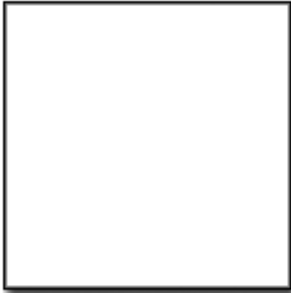
Flat Mesh

Product Code	Material	Size	Packaging
RML 	MERSILENE Mesh	12" x12" (30cm x 30cm)	3 Pieces Per Box
RMS 	MERSILENE Mesh	2.5" x 4.5" (6cm x 11cm)	3 Pieces Per Box

Tissue Separating Mesh

Product Code	Material	Size	Packaging
PHY0715R	Flexible Composite Mesh	7 X 15 cm Rectangle	1 Piece Per Box
PHY1015V	Flexible Composite Mesh	10 X 15 cm Oval	1 Piece Per Box
PHY1515Q	Flexible Composite Mesh	15 X 15 cm Square	1 Piece Per Box
PHY1520R	Flexible Composite Mesh	15 X 20 cm Rectangle	1 Piece Per Box
PHY1520V	Flexible Composite Mesh	15 X 20 cm Oval	1 Piece Per Box
PHY2025V	Flexible Composite Mesh	20 X 25 cm Oval	1 Piece Per Box
PHY2030R	Flexible Composite Mesh	20 X 30 cm Rectangle	1 Piece Per Box
PHY2535V	Flexible Composite Mesh	25 X 35 cm Oval	1 Piece Per Box
PHY3035R	Flexible Composite Mesh	30 X 35 cm Rectangle	1 Piece Per Box
PHY3050R	Flexible Composite Mesh	30 X 50 cm Rectangle	1 Piece Per Box

PROCEED Mesh

Tissue Separating Mesh





Product Code	Material	Size	Packaging
PCDB1	PROCEED Surgical Mesh (Tissue Separating Mesh)	2" x 4" (5cm x 10cm)	1 Piece Per Box
PCDD1	PROCEED Surgical Mesh (Tissue Separating Mesh)	4" x 8" (10cm x 20cm)	1 Piece Per Box
PCDG1	PROCEED Surgical Mesh (Tissue Separating Mesh)	6" x 8" (15cm x 20cm)	1 Piece Per Box
PCDH1	PROCEED Surgical Mesh (Tissue Separating Mesh)	8" x 10" (20cm x 25cm)	1 Piece Per Box
PCDJ1	PROCEED Surgical Mesh (Tissue Separating Mesh)	8" x 12" (20cm x 30cm)	1 Piece Per Box
PCDL1	PROCEED Surgical Mesh (Tissue-Separating Mesh)	12" x 12" (30.5cm x 30.5cm)	1 Piece Per Box
PCDM1	PROCEED Surgical Mesh (Tissue Separating Mesh)	6" x 6" (15cm x 15cm)	1 Piece Per Box
PCDN1	PROCEED Surgical Mesh (Tissue Separating Mesh)	4" x 6" (10cm x 15cm)	1 Piece Per Box

Hernia Repair: PROCEED Mesh

Product Code	Material	Size	Packaging
PCDR1	PROCEED Surgical Mesh (Tissue Separating Mesh)	3" x 6" (7.5cm x 15cm)	1 Piece Per Box
PCDT1	PROCEED Surgical Mesh (Tissue Separating Mesh)	10" x 13" (26cm x 34cm)	1 Piece Per Box
PCDW1	PROCEED Surgical Mesh (Tissue Separating Mesh)	10" x 14" (25cm x 35.5cm)	1 Piece Per Box

PROLENE 3D Patch Mesh

Mesh Devices

Product Code	Material	Size	Packaging
3DPL 	PROLENE 3D Patch Large with Extended Overlay	1 31/32"(5cm)	3 Pieces Per Box
3DPM 	PROLENE 3D Patch Medium with Extended Overlay	1 3/8"(3.5cm)	3 Pieces Per Box
P3DPL 	PROLENE 3D Patch Large with Preshaped Overlay	1 31/32"(5cm)	3 Pieces Per Box
P3DPM 	PROLENE 3D Patch Medium with Preshaped Overlay	1 3/8"(3.5cm)	3 Pieces Per Box

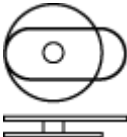
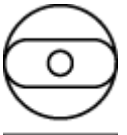
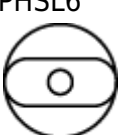
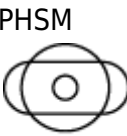
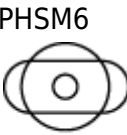

PROLENE Hernia System

Mesh Devices



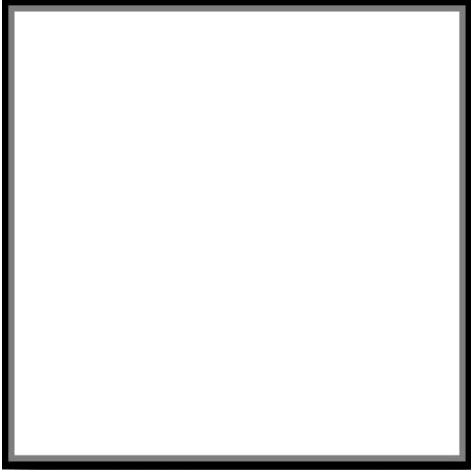

Product Code	Material	Size	Packaging
PHSE 	PROLENE Hernia System Extended	4" (10cm)	3 Devices Per Box
PHSE6 	PROLENE Hernia System Extended	4" (10cm)	6 Devices Per Box
PHSL 	PROLENE Hernia System Large	4" (10cm)	3 Devices Per Box
PHSL6 	PROLENE Hernia System Large	4" (10cm)	6 Devices Per Box
PHSM 	PROLENE Hernia System Medium	3" (7cm)	3 Devices Per Box
PHSM6 	PROLENE Hernia System Medium	3" (7cm)	6 Devices Per Box

PROLENE Mesh & PROLENE Soft Mesh

Flat Mesh

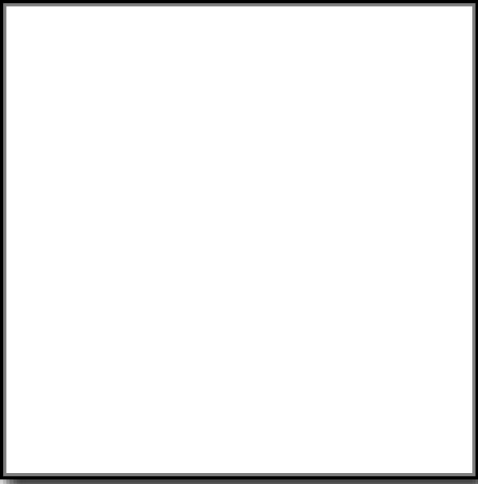
Product Code	Material	Size	Packaging
PMH 	PROLENE Mesh	6" x 6" (15cm x 15cm)	6 Sheets Per Box
PMII 	PROLENE Mesh	3" x 6" (8cm x 15cm)	6 Sheets Per Box

Hernia Repair: PROLENE Mesh & PROLENE Soft Mesh

Product Code	Material	Size	Packaging
PML 	PROLENE Mesh	12" x 12" (30cm x 30cm)	3 Sheets Per Box
PMLK 	PROLENE Mesh Pre-Shaped Keyhole (Large)	2.4" x 5.4" (6cm x 13.7cm)	6 Sheets Per Box
PMSK 	PROLENE Mesh Pre-Shaped Keyhole (Small)	1.8" x 4.0" (4.6cm x 10cm)	6 Sheets Per Box
PMXL	PROLENE Mesh	2" x 12" (5cm x 30cm)	6 Sheets Per Box
PMXS 	PROLENE Mesh	1" x 4" (2.54cm x 10cm)	6 Sheets Per Box

Hernia Repair: PROLENE Mesh & PROLENE Soft Mesh

Product Code	Material	Size	Packaging
SPMH	PROLENE Soft Polypropylene Mesh	6" x 6" (15cm x 15cm)	6 Sheets Per Box
SPMII	PROLENE Soft Polypropylene Mesh	3" x 6" (7.6cm x 15cm)	6 Sheets Per Box
SPMLI	PROLENE Soft Polypropylene Mesh	10" x 10" (25cm x 25cm)	3 Sheets Per Box
SPMS	PROLENE Soft Polypropylene Mesh	2" x 4" (5cm x 10cm)	6 Sheets Per Box
SPMXS 	PROLENE Soft Polypropylene Mesh	1" x 4" (2.54cm x 10cm)	6 Sheets Per Box
SPMXXL	PROLENE Soft Polypropylene Mesh	14" x 12" (35.6cm x 30cm)	3 Sheets Per Box

PVP

Tissue Separating Mesh

Product Code	Material	Size	Packaging
PVPM	PROCEED Ventral Patch Medium	6.4cm x 6.4cm	2 Pieces Per Box
PVPS	PROCEED Ventral Patch Small	4.3cm x 4.3cm	2 Pieces Per Box

ULTRAPRO Hernia System

Mesh Devices

Product Code	Material	Size	Packaging
UHSL	ULTRAPRO Hernia System Large	4" (10cm)	3 Pieces Per Box
UHSL6	ULTRAPRO Hernia System Large	4" (10cm)	6 Pieces Per Box
UHSM	ULTRAPRO Hernia System Medium	3" (7.5cm)	3 Pieces Per Box
UHSM6	ULTRAPRO Hernia System Medium	3" (7.5cm)	6 Pieces Per Box
UHSOV	ULTRAPRO Hernia System Oval	4" x 4.7" (10cm x 12cm)	3 Pieces Per Box

ULTRAPRO Mesh

Flat Mesh

Product Code	Material	Size	Packaging
UML1	ULTRAPRO Partially Absorbable Mesh	12" x 12" (30cm x 30cm)	1 Piece Per Box
UMM3	ULTRAPRO Partially Absorbable Mesh	6" x 6" (15cm x 15cm)	3 Pieces Per Box
UMR3	ULTRAPRO Partially Absorbable Mesh	3" x 6" (7.6cm x 15cm)	3 Pieces Per Box
UMS3	ULTRAPRO Partially Absorbable Mesh	2.4" x 4.3" (6cm x 11cm)	3 Pieces Per Box



ULTRAPRO Plug

Mesh Devices

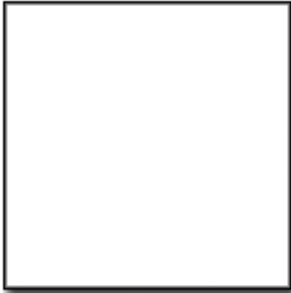

Product Code	Material	Size	Packaging
UPPL2	ULTRAPRO Plug Large	Anchor 5cm Rim 5cm	2 Devices Per Box
UPPL6	ULTRAPRO Plug Large	Anchor 5cm Rim 5cm	6 Devices Per Box
UPPM2	ULTRAPRO Plug Medium	Anchor 4cm Rim 5cm	2 Devices Per Box
UPPM6	ULTRAPRO Plug Medium	Anchor 4cm Rim 5cm	6 Devices Per Box
UPPS2	ULTRAPRO Plug Small	Anchor 3cm Rim 5cm	2 Devices Per Box
UPPS6	ULTRAPRO Plug Small	Anchor 3cm Rim 5cm	6 Devices Per Box

VICRYL Woven Mesh

Flat Mesh

Product Code	Material	Size	Packaging
VKML 	VICRYL Mesh Knitted	12" x 12" (30cm x 30cm)	3 Pieces Per Box
VKMM 	VICRYL Mesh Knitted	6" x 6" (15cm x 15cm)	3 Pieces Per Box
VM101K	VICRYL Mesh Bag Renal	6" x 3" (15cm x 8cm)	1 Piece Per Box
VM102K	VICRYL Mesh Bag Renal	7" x 4" (18cm x 10cm)	1 Piece Per Box
VM106K	VICRYL Mesh Bag Spleen	10" x 12" (26cm x 30cm)	1 Piece Per Box
VM210K	VICRYL Mesh Bag Liver	17" x 12" (44cm x 30cm)	1 Piece Per Box
VM220K	VICRYL Mesh Bag Liver	20" x 8" (50cm x 20.5cm)	1 Piece Per Box

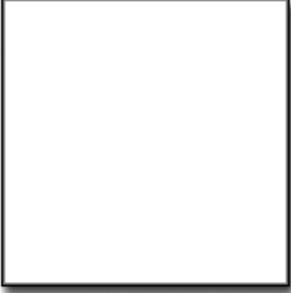
Hernia Repair: VICRYL Woven Mesh

Product Code	Material	Size	Packaging
VWML 	VICRYL Mesh Woven	12" x 12" (30cm x 30cm)	3 Pieces Per Box
VWMM 	VICRYL Mesh Woven	6" x 6" (15cm x 15cm)	3 Pieces Per Box

Nonsterile Products

ETHI-PACK Pre-cut Sutures - Surgical 316L

Product Code	Material	Size	Packaging
DS18 ⁷¹	B&S 18 Steel Monofilament	18" ~45cm Long x7 (.0403") Diameter	Box (12 Tubes - 144 Strands)
DS20 ⁷¹	B&S 20 Steel Monofilament	18"~45cm Long x5 (.0320") Diameter	Box (12 Tubes - 144 Strands)
DS22 ⁷¹	B&S 22 Steel Monofilament	18"~45cm Long x4 (.0254") Diameter	Box (12 Tubes - 144 Strands)
DS23 ⁷¹	B&S 23 Steel Monofilament	18"~45cm Long x3 (.0226") Diameter	Box (12 Tubes - 144 Strands)
DS24 ⁷¹	B&S 24 Steel Monofilament	18"~45cm Long x2 (.0201") Diameter	Box (12 Tubes - 144 Strands)
DS25 ⁷¹	B&S 25 Steel Monofilament	18"~45cm Long x1 (.0179") Diameter	Box (12 Tubes - 144 Strands)
DS26 ⁷⁰	B&S 26 Steel Monofilament	18"~45cm Long x0 (.0159") Diameter	Box (12 Tubes - 600 Strands)
DS28 ⁷⁰	B&S 28 Steel Monofilament	18"~45cm Long x2-0 (.0126") Diameter	Box (12 Tubes - 600 Strands)
DS30 ⁷⁰	B&S 30 Steel Monofilament	18"~45cm Long x3-0 (.0100") Diameter	Box (12 Tubes - 600 Strands)
DS32 ⁷⁰	B&S 32 Steel Monofilament	18"~45cm Long x4-0 (.0080") Diameter	Box (12 Tubes - 600 Strands)
DS35 ⁷⁰	B&S 35 Steel Monofilament	18"~45cm Long x5-0 (.0056") Diameter	Box (12 Tubes - 600 Strands)



⁷⁰ Each tube contains fifty 18" longstrands. Each box contains 12 tubes.

⁷¹ Each tube contains twelve 18" longstrands. Each box contains 12 tubes.

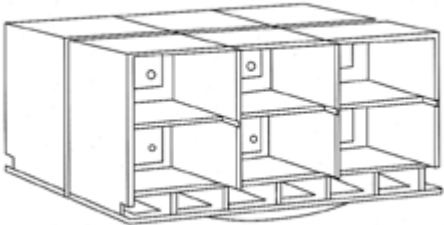
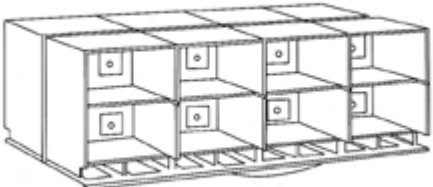
Storage Supplies

Product Code	Description
<p>CART</p> 	<p>CART, dimensions: 38"L x 18"W x 38"H. No Suture racks included. Brackets to attach racks included. Some assembly required.</p>
<p>LS3</p> 	<p>3-wide LAZY SUSAN, LS3, dimensions: 15 3/8"L x 11 1/2"W x 20 3/4"H. Includes 6 modular racks. Can be expanded with additional modular racks.</p>
<p>LS4</p> 	<p>4-wide LAZY SUSAN, LS4, dimensions: 20 1/2"L x 11 1/2"W x 20 3/4"H. Includes 8 modular racks. Can be expanded with additional modular racks.</p>
<p>MR20</p>	<p>DISPENSER RACK, MR20, dimensions: 25 3/4L x 5 3/4W x 27H. Includes 20 modules, 10 back plates. (each with 4 fasteners), 20 module clips, 30 divider panels. Assembly instruction sheet enclosed.</p>
<p>MR4</p>	<p>DISPENSER RACK, MR4, dimensions: 10 1/4L x 5 3/4W x 13 1/2H. Includes 4 modules, 3 back plates. (each with 4 fasteners), 4 module clips, 8 divider panels. Assembly inst. sheet encl. Shipped as comp. 4-module unit.</p>

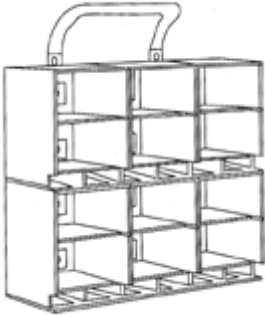
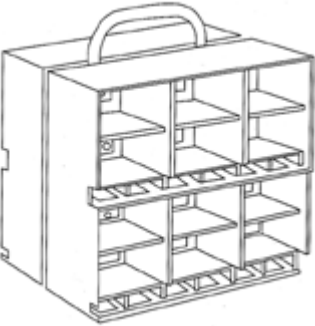
Miscellaneous: Storage Supplies

Product Code	Description
<p>PCR1</p> 	<p>PORTABLE CARRYING RACK, PCR1, dimensions: 15 3/8"L x 6 1/8"W x 17 5/8"H. Includes 6 modular racks.</p>
<p>PCR2</p> 	<p>2-SIDED PORTABLE CARRYING RACK, PCR2, dimensions: 15 3/8"L x 12 1/4"W x 16 3/4"H. Includes 12 modules racks.</p>
<p>SPR1</p> 	<p>I.V. POLE WITH RACK, SPR1, dimensions: 18 1/4"L x 16 1/2"W x 56 1/2"H. Includes 18 modules racks, 15 module clips, 30 divider panels. Some assembly required.</p>

Surgical Accessories

Adjustable Retention Suture Bridge

Product Code	Material	Size	Packaging
RSB5	Disposable Retention Suture Bridge for patients requiring retention sutures. Permits postoperative wound management.	1/2"W x 4.375"L (1.3cm x 11cm)	3 Per Packet 6 Packets Per Box

Polypropylene Buttons

Product Code	Material	Size	Packaging
520G 	For tendon repair in orthopedic surgery.	N/A	3 Per Packet 12 Packets Per Box

Retention Suture Bolster

Product Code	Material	Size	Packaging
450G	Surgical latex tubing, sterile.	2.5" x 3/16" x 1/32" (6cm x .48cm x .08cm)	6 Per Packet 12 Packets Per Box

Umbilical Tape

Product Code	Material	Size	Packaging
U10T	Cotton Umbilical Tape	1/8" x 18" (.32cm x 45cm)	2 Strands 2 Dozen Packets
U11T	Cotton Umbilical Tape	1/8" x 30" (.32cm x 75cm)	2 Strands 2 Dozen Packets
U12T	Cotton Umbilical Tape	1/8" x 36" (.32cm x 90cm)	3 Strands 2 Dozen Packets

Miscellaneous: Surgical Accessories

Product Code	Material	Size	Packaging
U15G	Radiopaque Umbilical Tape	1/8" x 18" (.32cm x 45cm)	2 Strands 1 Dozen Packets
U16G	Radiopaque Umbilical Tape	1/8" x 24" (.32cm x 60cm)	2 Strands 1 Dozen Packets

TFE Polymer Pledgets

Product Code	Material	Size	Packaging
PCP20	TFE Polymer Pledgets (Firm)	1/4" x 1/8" x 1/16" (7mm x 3mm x 1.5mm)	Box (36 Envelopes - 216 Pledgets)
PCP30	TFE Polymer Pledgets (Firm)	3/8" x 3/16" x 1/16" (9.5mm x 4.8mm x 1.5mm)	Box (36 Envelopes - 216 Pledgets)
PCP40	TFE Polymer Pledgets (Soft)	3/8" x 3/16" x 1/16" (9.5mm x 4.8mm x 1.5mm)	Box (36 Envelopes - 216 Pledgets)
PCP50	TFE Polymer Pledgets (Soft)	1/4" x 1/8" x 1/16" (7mm x 3mm x 1.5mm)	Box (36 Envelopes - 216 Pledgets)