

Evolution Engines 26GT2 / 35GT2

USER GUIDE



Before using this engine, please read these instructions carefully.

Introduction

Congratulations on your purchase of the newest and one of the most technically advanced 2-stroke gas model airplane engines in the world. Whether you are new to the sport of model aviation or an experienced flyer, you will enjoy the features of the new Evolution GT engine.

Evolution engines are designed to be the most powerful in their class, extremely easy to start and operate, and provide years of enjoyable service. These engines incorporate many unique design features. Each feature is designed to ensure success with your new engine.

This user's guide is intended to provide the basic information required to operate and maintain your Evolution GT engine.

Important: *While the Evolution engine is extremely easy to operate, if this is your first experience flying a model airplane, it is highly recommended that you have the help of an experienced modeler during the first few flights. Your local hobby shop or flying club can put you in touch with an experienced pilot in your area.*

Evolution Engines® 2-Year Warranty

This Evolution Engines product is guaranteed to be free from defects in materials and workmanship for a period of 2 years from the date of purchase. During this time, Evolution's authorized service center will repair or replace, at their option, any defective parts without charge.

This warranty does not apply to damage or defects resulting from misuse, neglect or abuse; damage caused by customer disassembly, use of substandard fuel, use of incorrect accessories (spark plug, propeller, etc.); or damage resulting from a crash or any use of this engine other than for which it is specifically intended. Any of the above will automatically void the warranty of the engine.

Should your engine require warranty or non-warranty repair service, please package it carefully and return it to the address at the right, along with a copy of the original

invoice or receipt and a detailed letter explaining the problems. Write your name, address and daytime phone number clearly on the letter and return it via FedEx, UPS or insured Parcel Post (Evolution Engines will not be responsible for product lost en route).

For repairs not covered under warranty, please specify in your letter whether you want an estimate of the repair charges prior to performing the service (which may cause a slight delay). Payment for non-warranty repairs should be made by credit card or money order. Unless otherwise specified, all repaired engines will be returned. We will do everything we can to expedite the service required to your Evolution product.

Evolution/Horizon Service Center

4105 Fieldstone Road, Champaign, IL 61822
1-217-355-9511
www.horizonhobby.com

Mounting the Engine

Most model airplane designs make provision for an engine mount. It is extremely important that the engine mount be securely mounted to the airplane's firewall and that the engine is securely mounted to the engine mount. Follow the instructions included with the airplane for mounting the engine.

The engine should be fastened in place with 4 screws through a conventional beam mount. Use 8x32 screws (26GT2) or 10x32 (35GT2). If you decided to fasten the engine using a flexible motor mount, always choose parts with enough integrity and strength. Make sure all screws are tightened and regularly check that they are tight and in good condition.

Important: *Air is necessary to cool the engine during operation. Make sure that sufficient air circulation through the cowling is provided. As a basic reference the outlet area should be 3–5 times the area of the inlet area to provide adequate cooling.*

Throttle Linkage

Carefully attach the throttle linkage to the engine using a ball link on the carburetor. Make sure that the linkage is free to operate from low throttle to high throttle and confirm that the low throttle setting on the transmitter closes the carburetor butterfly to the low idle position. Adjust the length of the pushrod until full throttle opens the carburetor butterfly fully, while low throttle, low trim completely closes the butterfly.

Attaching the Fuel Lines

Use medium gasoline-compatible fuel line in the fuel tank as well as the supply line to the engine.

Selecting a Suitable Propeller

The Evolution 26GT and 35GT have been designed to generate maximum power at 8500 rpm, according to the type of exhaust used. If you wish to utilize the maximum power output, choose a propeller, which will allow the engine to reach these revolutions, or slightly lower revolutions. (The engine will unload in the air depending on the aircraft speed and propeller selected.) We do not recommend using propellers that allow the engine to reach more than 9000 rpm on the ground.

Fuel for the Evolution Gas Engine

The Evolution gas engine has been designed to run on a mixture of high quality unleaded gasoline and synthetic oil intended for racing 2-stroke gasoline engines. For the break-in period of the new engine, mix the fuel in a ratio of 30 parts gasoline to 1 part lubricant. After break-in use a ratio of 40 parts gasoline to 1 part lubricant.

Suggested Propeller Dimensions

26GT2	16x8	16x10	16x11	16x12
	17x8	17x10		17x12
	18x6	18x8		

35GT2	18x8	18x10		
	19x8	19x10		
	20x8	20x10	20x12	

Starting the Engine

Evolution Engines® new carburetor comes adjusted to a basic setting. This setting should be maintained during the initial break-in runs.

Before you first start the engine, make sure that the spark plug is screwed in and tightened and that the plug socket is fitted in place and fastened down properly. Fix the ignition sensor in the proper position above the magnet with the screws enclosed. *Follow the directions in the ignition system addendum to mount the ignition module in your model.

Important: *Never turn the engine over with the ignition turned on unless the spark plug is inserted in the plug socket. This could lead to ignition damage.*

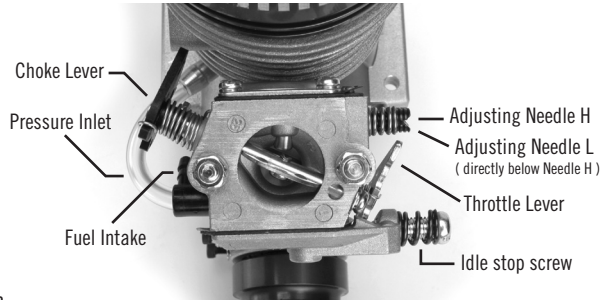

Basic setting: (minutes refer to the hands of a clock)

Carburetor Adjustments 266T2

Adjust needle (L) for low rpm range 1 turn and 50 minutes

Adjust needle (H) for high rpm 1 turn and 35 minutes

Carburetor Adjustments 356T2

Adjust needle (L) for low rpm range 1 turn and 45 minutes

Adjust needle (H) for high rpm 1 turn and 45 minutes

1) Before attempting to start your engine make sure that the ignition is switched off, the choke valve is closed and the throttle valve is about half opened. Then turn the engine 3–4 revolutions, assuming the engine has not been flooded.

2) When you are ready to start the engine switch the ignition on, open the choke valve and set the throttle at a slightly high idle speed. Be sure to have a helper hold the model securely. Using an electric starter begin cranking the engine. It should fire within seconds of applying the starter. Allow the engine to idle for 30–45 seconds.

3) If the engine does not start even after using the starter to crank the engine a second time, open the throttle to maximum, turn off the ignition and turn the engine about 4 revolutions. Switch the ignition on again, then restart the engine with throttle at a fast idle position and the choke valve set open.

4) At this point if the engine still will not start, unscrew the spark plug and check its contacts. Clean any possible excess fuel (i.e. an indication of engine flooding) and screw it in again. Further starting should only be done with the throttle at idle position. If the plug is dry then probably not enough fuel has been drawn into the carburetor. If that is the case, check the fuel feed and then return to the instructions given in paragraph 1.

After starting and warming the engine for 30–45 seconds adjust as follows:

Step I- Move the throttle to 2/3 high throttle position quickly (fast acceleration). Then repeat three times— if the engine accelerates smoothly go to Step III. If acceleration is not smooth go on to Step II.

Step II- Faulty acceleration and a tendency to quit is usually attributable to a poor fuel mixture in the medium rpm range. Stop the engine and recheck the fuel feed (the fuel line must not be pinched or broken). Restart the engine and test acceleration again. If the problem persists adjust the carburetor. Open the low speed needle by 5 minutes and retest. If acceleration is smooth, open the needle by another 3–5 minutes— this should be done because the needle was previously set too lean; if atmospheric conditions changed recently you may have to re-adjust the needle.

If the engine continues to not accelerate properly open the low speed needle by 10 minutes. If the engine's operation does not improve, shut it off and check the basic setting, restart the engine and test the acceleration. If the engine runs correctly go to

Step III- If it continues to not accelerate properly, open the low speed needle by another 10 minutes. If acceleration is faulty, the defect is likely to lie somewhere other than an adjustment.

Step IV- If the engine accelerates correctly, according to the above test, set it at idle speed and accelerate to full speed. Repeat twice more. If the engine functions correctly, go to Step IV. If it cuts out, open the low speed needle by 5–10 minutes more. If the engine does not respond to acceleration fast enough, keep closing the low speed needle until the engine starts to cut out in response to throttle opening. At that point reopen the low speed needle by 5–10 minutes.

Step V- If the engine reacts correctly set it at full speed. If revolutions do not drop, the engine has been adjusted successfully. If revolutions seem to drop, open the high speed needle by about 5–10 minutes.

Caution! *The engine must be stopped while you adjust the carburetor in order to prevent injury by the propeller.*

Starting and running a new engine:

Having started the engine, leave it running for about 5 minutes at a higher idle speed. Then run it for about 20 minutes, while changing revolutions from idle to 1/2–3/4 of the range and shortly holding each position—gradually prolong the holding periods. After 10 minutes of operation open the throttle to maximum for a period of about one minute. At this point stop the engine and let it cool down. Then restart it and check the adjustment. If everything is all right, you can make your first flight. During first few flights do not overload the engine and do not let it run at high revolutions for long periods of time (very important during hot weather). Use up all the fuel that was mixed with the oil that is included with your engine. From then on, fuel and oil should be mixed in the proportion 40:1

Trouble-Shooting Guide

If the engine does not start

- check and use a new spark plug if needed. (Check the spark: put the plug into the cable end and by turning the engine you'll see the necessary spark. Note: The plug must touch a metal part of the engine.)
- check fuel lines.
- check for proper mechanical function by turning the engine over.
- check that the carburetor is correctly installed.
- remove the carburetor cover from the feed side; check the filter and blow off carburetor with compressed air (**Caution:** *When using compressed air, use eye protection.*); when re-assembling be careful to maintain the proper order of the components.
- check the vacuum feed line.

Mechanical Faults

If the engine can not be turned over easily

- a likely cause is the piston in the cylinder is seized: loosen and unscrew the cylinder bolts.
- carefully remove the cylinder.
- visually examine the piston and crankcase to find the likely cause of the engine's mechanical problem.

Note: Mechanical repairs must always be completed by a professional service department.

GT2 Evolution Engine Dimensions

		A	B	C	D	E
		mm	mm	mm	mm	mm
	26 GT2	146	99	50	70	60
	35 GT2	182	118	60	84	70
		F	G	H	I	J
		mm	mm	mm	mm	mm
26 GT2	31	4.3	M10x1	10	33	
35 GT2	41	5.3	M10x1	10	45	

26GT2 / 35GT2 Evolution Engine Specifications

Evolution 26GT2

Bore	33mm	Maximum power output**	3.8 HP/9000 rpm
Stroke	30.1mm	Maximum torque**	2.18ft-lb/8000 rpm
Displacement	25.7cc/1.6 ci	Fuel	Unleaded gasoline
Weight of complete engine without ignition*	936 g/2.06 lb	Lubrication	Oil w/gasoline in mixture 1:40
Weight of ignition unit	165 g/5.8 oz		
RPM range	1400–9500 rpm		

Evolution 35GT2

Bore	35.5mm	Maximum power output**	4.1 HP/8500 rpm
Stroke	35.2mm	Maximum torque**	2.49ft-lb/7500 rpm
Displacement	34.80cc/2.15 ci	Fuel	Unleaded gasoline
Weight of complete engine without ignition*	1493 g/3.3 lb	Lubrication	Oil w/gasoline in mixture 1:40
Weight of ignition unit	165 g/5.8 oz		
RPM range	1400–9000 rpm		

* The value in the table above stands for the weight of a completely assembled engine, including the spark plug, carburetor, drive washer and prop screws.

** Power output varies with the exhaust used. The value given in the table stands for the maximum available power output.



Evolution GT2 Engine Easy Start Ignition System

The spark ignition included with your Evolution® gas engine is a modern generation electronic ignition. There are many useful functions built into the microprocessor of this unit.

In addition to the basic ignition functions, the unit has a FAIL-SAFE feature: After 90 seconds of inactivity, it automatically switches to an inactive state. In order to restart normal operation, it is necessary to turn the battery switch off and then back on. This function will preserve battery life should the switch be left in the on position during inactivity.

Installation of the GT2 Easy Start Ignition Unit

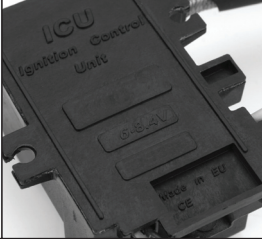
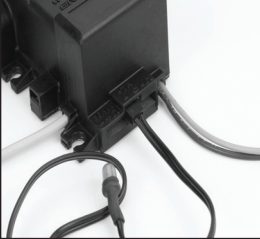
While installing the ignition unit in your model, be careful to have all parts that are connected to the unit and the engine situated as far as practical from the radio receiver and radio antenna. The throttle servo should be mounted a distance of 8–12 inches from the engine. The spark plug cable must not touch any part of the model structure as vibration may damage the cable. If this is not practical, it will be necessary to provide an insulation material for the cable. The ignition unit itself should be wrapped in foam rubber to prevent engine vibration from damaging the electronics. All components must be protected from contact with engine fuel.

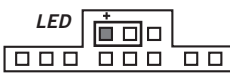
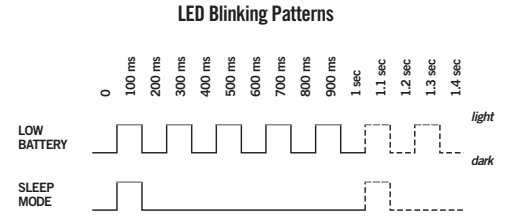
 <p>1 Ignition 2 LED</p>	 <p>ICU-L 6–8.4V</p>	 <p>Connect LED indicator to the ignition box (red/black wire to "+").</p>	 <p>Using the included connector, plug your battery pack into the ignition box. Five seconds after connecting the battery, the LED indicator should go out. If the LED is blinking after you connect the battery, the battery's voltage is too low.</p>
 <p>LED</p>		 <p>LED Blinking Patterns</p> <p>LOW BATTERY: 0, 100 ms, 200 ms, 300 ms, 400 ms, 500 ms, 600 ms, 700 ms, 800 ms, 900 ms, 1 sec, 1.1 sec, 1.2 sec, 1.3 sec, 1.4 sec</p> <p>SLEEP MODE: 0, 100 ms, 200 ms, 300 ms, 400 ms, 500 ms, 600 ms, 700 ms, 800 ms, 900 ms, 1 sec, 1.1 sec, 1.2 sec, 1.3 sec, 1.4 sec</p> <p>light (solid line), dark (dashed line)</p>	

Technical data

Weight	155 g
Power supply	2x Li-Io/Li-Po
Pre-ignition point	6x Ni-Cd/Ni-MH
Location of the magnet	5°
Minimum battery capacity	600mAh

Other features

Preset ignition curve
Sleep mode after 90 seconds of engine inactivity
Battery level signalization
Ignition goes off if engine runs counterclockwise

Installation of the Ignition Unit Continued

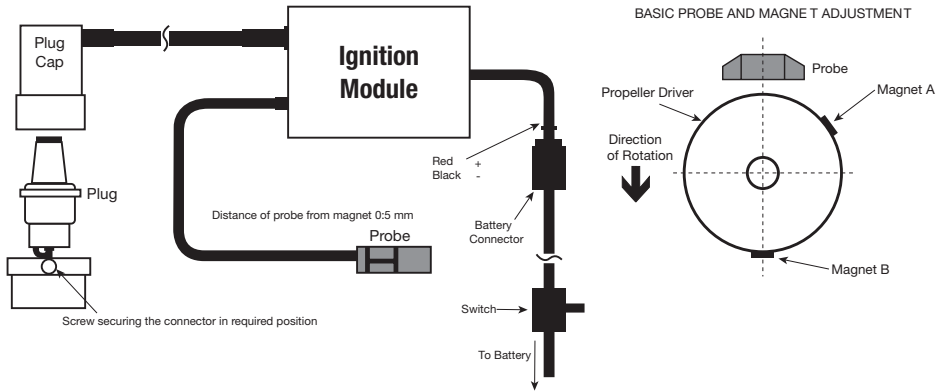

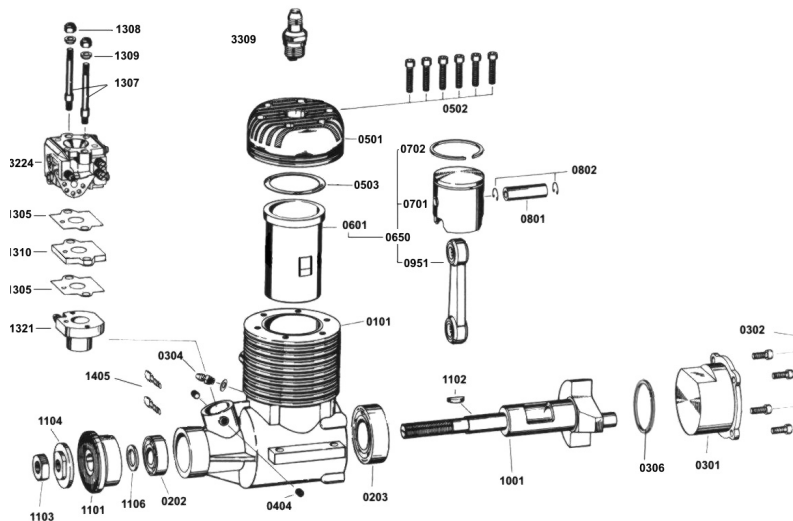

26GT2

Part Number	Description	Part Number	Description
EVO30013309	Spark Plug NGK 5812 (sm cap)	EVO30940802	Piston Pin Retainer
EVO30940101	Crankcase	EVO30940951	Connecting Rod
EVO30940202	Front Bearing	EVO30941001	Crankshaft
EVO30940203	Rear Bearing	EVO3094i1101	Drive Washer
EVO30940301	Rear Cover	EVO30941102	Drive Washer's Taper Key
EVO30940302	Rear Cover Screws - Set	EVO30941103	Propeller Nut
EVO30940303	Rear Cover "O"- Ring	EVO30941104	Propeller Washer
EVO30940304	Pressure Nozzle	EVO30941106	Washer
EVO30940305	Pressure Nozzle Gasket (2pcs)	EVO30941305	Carburetor Gasket (2pcs)
EVO30940404	Carburetor Screw (2pcs)	EVO30941307	Carburetor Bolt
EVO3094i0501	Cylinder Head	EVO30941308	Carburetor Nut (2pcs)
EVO30940502	Cylinder Head Screws (6pcs)	EVO30941309	Washer (2pcs)
EVO30940503	Cylinder Head Gasket (3pcs)	EVO30941310	Thermo-Isolation Washer
EVO30940601	Cylinder Liner	EVO30941321	Carburetor Flange
EVO30940650	Cylinder Piston Assembly	EVO30941405	Ignition Sensor Fixing Screws
EVO30940701	Piston	EVO30943224	Carburetor
EVO30940702	Piston Ring	EVO3314L	GT2 Type Ignition ICU-L
EVO30940801	Piston Pin		



© 2006 Manufactured exclusively for Horizon Hobby, Inc.
www.horizonhobby.com 877-504-0233

7795.3