

# ENFIELD ARCHAEOLOGICAL SOCIETY ARCHIVE REPORT

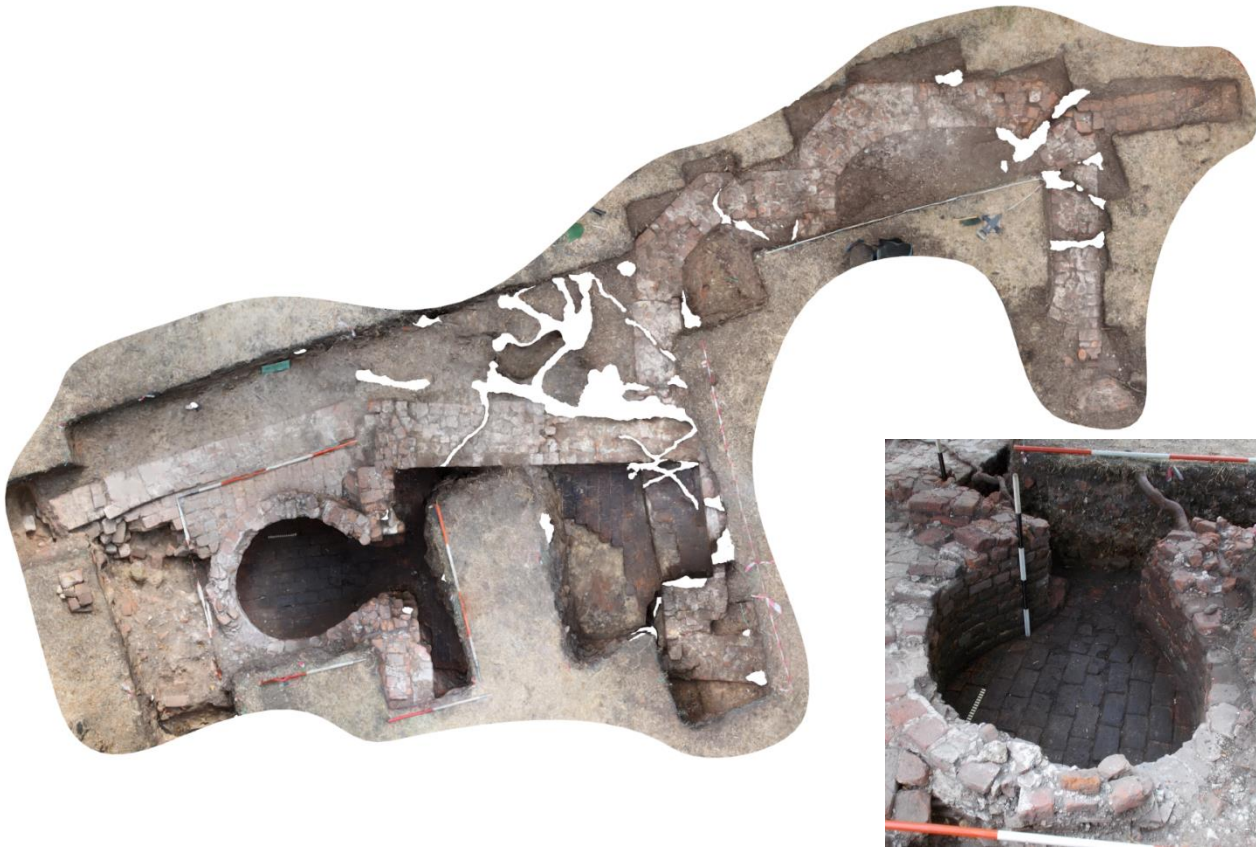

**EXCAVATIONS AT ELSYNG PALACE, FORTY  
HALL, ENFIELD, MAY - JULY 2018**

**(SITE CODE FXQ18)**

**(SCHEDULED ANCIENT MONUMENT LO 59)**

**(EXCAVATION CENTRED TQ 3380 9887)**

by  
**MARTIN J. DEARNE**

with contributions by

**IAN K. JONES**

**NEIL PINCHBECK**

**Illustrators/Photographers**

**Martin J. Dearne, Neil Pinchbeck, John Pinchbeck and Ian K. Jones**

**Cover: Trench 6 and Deturfed Area with Tree Roots Removed (Vertical Photo Mosaic by John Pinchbeck) and The Fully Excavated Furnace in Room 5 Looking West (Photo MJD)**

**© Enfield Archaeological Society and the Authors 2018**

**FXQ18: site director and project manager Martin J. Dearne; co project managers Neil Pinchbeck and Mike Dewbrey.**

**Client commissioning the EAS: London Borough of Enfield.**

**Contracting organisations' contact details:**

**www.enfarchsoc.org.uk**

**Secretary:  
Val Munday  
88 Gordon Hill,  
Enfield EN2 0QS  
Tel. 0795 735 2570**

**Chairman:  
Ian Jones  
18 Corby Crescent  
Enfield EN2 7JT,  
Tel. 0208 363 4094  
i.jones094@btinternet.com**

**Research/Excavations Director:  
Martin J. Dearne  
9 Junction Rd.  
Edmonton N9 7JS  
Tel. 0208 807 7079  
martin.dearne@talktalk.net**

## **CONTENTS**

<b>Abstract</b>	<b>2</b>	<b>Plates:</b>	
<b>Introduction</b>	<b>2</b>	<b>1 Wall [8]</b>	<b>65</b>
<b>Objectives and Methods</b>	<b>2</b>	<b>2 Wall [8]/Floor [18]</b>	<b>65</b>
<b>Historical Background</b>	<b>3</b>	<b>3 Drain [15]</b>	<b>66</b>
<b>Archaeological Background</b>	<b>4</b>	<b>4 Trench 2 Overview</b>	<b>66</b>
<b>The Stratigraphic Sequences</b>	<b>6</b>	<b>5 Wall [46]</b>	<b>67</b>
<b>Discussion</b>	<b>25</b>	<b>6 Floors [32] and [40]</b>	<b>67</b>
<b>Conservation and Research Implications</b>	<b>29</b>	<b>7 Floors [60] and [70]</b>	<b>68</b>
<b>Acknowledgements</b>	<b>30</b>	<b>8 Floor [56]</b>	<b>68</b>
<b>Bibliography</b>	<b>31</b>	<b>9 – 10 Furnace [52]</b>	<b>69</b>
<b>Appendices:</b>		<b>11 The ‘Cupboard’</b>	<b>70</b>
<b>1 Archive Note</b>	<b>33</b>	<b>12 Floor [32]</b>	<b>70</b>
<b>2 Context Index and Matrices</b>	<b>33</b>	<b>13 Walls [53], [54] and [76]</b>	<b>71</b>
<b>3 Finds Summary</b>	<b>38</b>	<b>14 The Multiangular Tower</b>	<b>71</b>
<b>4 OASIS Form</b>	<b>47</b>	<b>15 – 24 Finds</b>	<b>72</b>
<b>Figures:</b>		<b>25 – 28 Finds</b>	<b>73</b>
<b>1 2018 and Previous Work/Features</b>	<b>49</b>		
<b>2 – 5 Rooms 5 and 6 Phased Floor Plans</b>	<b>50 - 52</b>		
<b>6 – 7 Trench 2</b>	<b>53 - 54</b>		
<b>8 – 10 Trench 7</b>	<b>55 - 57</b>		
<b>11 – 12 Trench 6</b>	<b>58 - 59</b>		
<b>13 Trench 6 Sections/Elevations</b>	<b>60</b>		
<b>14 The Deturfed Area</b>	<b>61</b>		
<b>15 Overall Site Plan</b>	<b>62</b>		
<b>16 - 17 Finds</b>	<b>63 - 64</b>		

## ABSTRACT

- The excavation of eight trenches, though one was too disturbed to be informative, and an area of deturfing considerably clarified and advanced the understanding of the western part of what is now more clearly a south western range of the courtier's and later royal palace of Elsyng, whose chronological phasing has also now been revised following documentary research. Only one further wall fragment of the house now believed to have been built by the Earl of Worcester in the mid fifteenth century was located. But multiple walls and a sequence of well preserved patterned brick and rammed pebble floor surfaces belonging to the courtier's and royal palace of c. 1486 – c. 1656 were excavated and allowed the relative phasing of five periods of construction and modification of two of the eight rooms so far identified in the range.
- Major findings included that a previously excavated L-shaped complex of buildings did not, as previously thought, represent a threshing barn complex built after palace demolition but represented a storage barn and other structures that were an integral part of the palace range under excavation from the start; that the facade wall fronting the range had a multiangular tower projecting from it; and that a previously partly excavated oven was a major sunken furnace associated with other features and which likely identifies at least one excavated room as a boiling/scalding house (or conceivably brewhouse) likely within a kitchen complex.

## INTRODUCTION

- On-going research into the site of Elsyng Palace by the Enfield Archaeological Society (EAS) since 2004 (Dearne 2004; 2005a; 2005b; 2006a; 2006b; 2007; 2008; 2009; 2011a; 2011b; 2012a; 2013; 2014; 2015; 2016; 2017c) has advanced our understanding of some aspects of the plan and developmental sequence of the palace (see further below) and the 2018 excavations reported here represented part of a programme of work focused on buildings fronted by the southern facade wall of the palace.
- The outstanding research questions about this area following work in 2017 and earlier were whether a large brick built drain served as the northern limit of the building being investigated; whether a large previously excavated barn structure at the west end of an L-shaped building complex was part of the same building complex and if so an original feature of it or a later construction re-using some of its walls; where the eastern limit of the previously excavated elements of the complex lay; and what the plan, date and function(s) of rooms in the south eastern area of the complex as so far defined were. Consequently in 2018 the EAS cut eight trenches (see Fig. 1) in the area to address these questions.
- Scheduled Monument Consent for the work was given by the Dept. of Culture, Media and Sport (Ref. S00186539) following the submission by the author, acting as agent for the London Borough of Enfield (the owners), of an application, supported by a project design, for such consent.
- The work was undertaken in the periods 28<sup>th</sup> May – 3<sup>rd</sup> June and 11<sup>th</sup> – 22<sup>nd</sup> July 2018, was allocated site code FXQ18 by the Museum of London and was carried out in accordance with the project design produced by, and under the direction of, the author. The work was project managed by Martin J. Dearne with the assistance of Neil Pinchbeck and Mike Dewbrey of the EAS and the site archive and retained finds generated by the work will be deposited in the LBE Museums Service/EAS archive (see Appendix 1).

## OBJECTIVES AND METHODS

The objectives of the excavation were:

- to establish the full extent of the building complex as currently understood and recover evidence for its plan, date(s) of construction and function(s);
- and to establish its relationship to the previously excavated L-shaped complex noted above.

The methodology of the work was:

- Trench 1, initially 1.50 x 7.00 m, and subsequently expanded by 2.25 m<sup>2</sup> at its south west corner (to include and more fully excavate a previous trench), examined the south wall of the barn forming part of the L-shaped complex;
- Trench 2, initially 2.50 x 3.50 m, was expanded in stages to a total area of 17.75 m<sup>2</sup> to examine the northern margin of the building under study and elements of the barn;

- Trench 3, 2.00 x 1.50 m (contiguous with a 1.00 x 1.50 m re-exposure of features excavated in 2017), was partially excavated to answer a specific small research question left unresolved by the 2017 work;
- Trench 4, 4.30 x 0.70 m and contiguous with Trenches 3 and 2 (including a re-exposure of a feature excavated in 2017), was only partially excavated (to the base of topsoil) to confirm a wall alignment;
- Trench 5, initially 1.50 x 2.00 m then expanded by 1.00 m<sup>2</sup>, was excavated to confirm a projected wall line of the barn;
- Trench 6, initially 22 m<sup>2</sup>, represented the expansion southwards of FXO17 Trench 2 to fully examine and contextualise features revealed in that trench and was itself expanded by a total of 4.00 m<sup>2</sup> to complete the excavation of features disclosed at the original north west, south west and south east corners of the trench (though, as in 2017, some trench sections had to be left with a batter due to the unsafe nature of the rubble present);
- Trench 7, initially 9.00 x 1.50 m, was expanded in stages to the south and north to cover an area of 28.60 m<sup>2</sup> (including unexcavated ground around a standing tree) to examine an area of the building complex not previously sampled and slightly overlapping two 2017 trenches;
- and Trench 8, 2.00 x 1.50 m, was cut contiguous with 2017 Trench 2's north east corner to further investigate a major demolition cut, but was found to be so tree throw/planting disturbed that it was archaeologically worthless and was only partly excavated.
- In addition an area of approximately 8.10 m<sup>2</sup> was (only) deturfed running west from the south west corner of Trench 6 in order to reveal the plan and assess the conservational condition of a tower structure which lay immediately below turf level.
- All excavation was by hand and none removed any *in situ* structures or brick floor surfaces.
- The excavations were single context recorded using EAS context sheets and other pro formas, digital photographs, plans and sections drawn at an appropriate scale and spot heights, all recording being with respect to existing fixed OS grid point markers;
- all deposits likely to yield environmental and micro-faunal/archaeobotanical evidence were bulk sampled and later processed (full reports available in archive);
- all non twentieth/twenty first century finds except cbm were collected from all contexts and all spoil sieved and or metal detected (under a Section 42 licence (Ref. AA/52472));
- the trenches were seeded with modern coins and structural features protected with topsoil before backfilling and immediately returfed.

### HISTORICAL BACKGROUND

- The historical evidence for Elsyng Palace has been outlined in several published and unpublished sources (e.g. Jones and Drayton 1984, 8ff; Phillipotts 2002, 11ff; Dearne 2004, 3), but is now the subject of a major new research initiative by the author and others in preparation for a new publication on the site (Dearne *et al* in prep.) which has established that many details in these, and other, accounts are highly challengeable.
- Relevant to the current work is that the estate is believed to have Medieval origins, that the first substantial brick house on the site is now believed to have probably been built by John Tiptoft, Earl of Worcester in the early to mid fifteenth century and that under Sir Thomas Lovell this was adapted and substantially extended from c. 1486, by the early sixteenth century becoming his 'courtier's palace' with an outer and inner courts. Multiple visits to Lovell at Elsyng by Henry VII and VIII are known and on Lovell's death in 1524 it passed to his heir the Earl of Rutland who used it as a home and continued to entertain the king.
- It was acquired from him by Henry VIII in 1539 as a royal palace, primarily used as a residence for the royal children, and repaired but not rebuilt. Subsequently it may have been little used under Edward VI (except by Princess Elizabeth) and Mary, but was periodically used by Queen Elizabeth as a stop on royal progresses for the first decade of her reign. Despite several recorded phases of repair under these successive monarchs the palace may have been dilapidated by 1597 and, though there are recorded visits by James I early in his reign, Elsyng was probably out of favour by the late sixteenth century and in 1608 a warrant to demolish it and use the materials at Theobalds Palace was issued but not fully carried out. Repairs followed in 1609 – 10 and also continued under Philip Herbert (Earl of Montgomery, later Earl of Pembroke), whose family probably lived in the palace from 1612 to c.

1630, who was Keeper of the palace from 1622 and who subsequently purchased it from Charles I in 1641, but is unlikely to have lived there after 1630.

- The palace was still standing in 1656. Already though by 1629 the Manor of Worcesters, formerly including parts of the palace estate but not the palace and its immediate environs, had passed to Nicholas Rainton who built the standing Forty Hall at the top of the hill above the palace (Gillam 1997, 54) and by 1656 the palace estate had been acquired by a second Nicholas Rainton, who had inherited Worcesters and Forty Hall, and the palace is presumed to have been demolished shortly afterwards. The only contemporary reference to its site at the presumed time of demolition (in 1656) describes the palace as ‘One very ancient Greate House called Endfield House with ye Courtyards Gardens Orchards and Courtyarde with ye field adjoining called ye Walks’ (London Metropolitan Archives ACC/0016/008) and little more is known from documentary sources about the palace site until the existing double avenue of Lime trees which cross the site were planted sometime before Rocque’s map of Middlesex was produced in 1754.

### **ARCHAEOLOGICAL BACKGROUND**

- The only archaeological excavation on the site prior to 2004 was in 1963 - 7 by the EAS. Elements of the work were summarised in Jones and Drayton (1984) and its main focus was an area of c. 25 x 10 m (probably in the inner court) where very substantial remains of the palace structure were encountered, often just below turf level; and the recording of a gas main trench across the northern edge of the palace complex. Trenches were also cut further east and what is known of them has been summarised by the author (Dearne 2004, 3f). However, a re-evaluation of the archive for all this work is currently being undertaken by the author for Dearne *et al* in prep.
- A conservation management plan for the Forty Hall estate was prepared by Broadway Malyan Cultural Heritage in 1999 and a desk top study of the site of Elsyng Palace (Phillpotts 2002) was produced by Compass Archaeology Ltd in 2002 and drew on some of the geophysical and topographical surveys of all or parts of the site which have taken place.
- A resistivity survey in 1968 near the main 1960s excavations is known only from a slide of its results, but magnetometry and resistivity surveys were carried out in 1997 and 1998 and ground penetrating radar and topographical survey in 2000 (Horsley 1997; Bartlett 1989; and see Phillpotts 2002, *passim* and especially Fig. 28). However, the problems subsequently identified with the magnetometry and resistivity surveys (below) should be emphasised.
- Subsequent to the desk top survey smaller magnetometry and resistivity surveys were undertaken for the EAS in 2003, 2004 and 2005 (Dearne 2005a; Black and Black 2004).
- Excavation by the EAS in 2004 consisted of the cutting of two test pits, both of which disclosed parts of a widespread rammed pebble surface (Dearne 2004). Further excavation in 2005 identified the heavily robbed remains of structures along the east side of the outer court, later assigned to the courtier’s palace phase (Phase 2 herein) of the site (Dearne 2004; 2005a; 2006b, 13); and, crossing below them, a large intact brick drain, the redeposited natural above which was interpreted as forming the outer courtyard surface (Dearne 2005a). Excavation at TQ 3398 9874 also in 2005 identified a brick firing clamp likely connected to the palace (Dearne 2005b).
- Between December 2005 and September 2007, the EAS excavated or re-excavated 34 sample pits and eight full trenches in connection with tree planting work on the site (Dearne 2006a; 2006b; 2007) and these excavations recovered pottery evidence for a site origin in the eleventh century, produced floor tile evidence suggesting the presence of high status activity by the late fourteenth century, confirmed the position of the gatehouse, sampled a small area within it, and located and sampled or fully excavated two midden areas, two pebbled and one brick courtyard (later re-interpreted as internal) surfaces, a short length of wall and a late fifteenth century drain and ?tank base. A variety of evidence from the work strongly suggested that the structures of the outer court in fact represented reuse/repair/adaptation of the late fifteenth century courtier’s palace, but it now appears more likely that they belonged in their inception to the early/mid fifteenth century house of the Earl of Worcester. That the topography north of the palace had been heavily modified by the dumping of palace demolition material was also apparent.
- Excavations in 2008 (Dearne 2008) demonstrated the geological origin of an area of geophysical anomalies and newly available aerial photographic coverage subsequently allowed the location of the north range of the outer court while rediscovered archive plans of the location of work on the site in the 1960s (Jones and Drayton 1984) also showed that this had been misplotted against geophysical

results and the OS grid. Work in 2009 (Dearne 2009) then examined imprecisely dated pebble surfaces east of the palace without disclosing an archaeological cause for a large curved geophysical anomaly. Excavation in 2010 well beyond the northern edge of the palace in the vicinity of Maidens Brook and connected to the preparation of an HLF bid for the Forty Hall estate encountered a brick built drain relating to the palace (Pinchbeck with Dearne 2010), but by 2010 it was clear that the existing geophysical surveys (Bartlett 1998), on which many assumptions about the location, extent and plan of the palace had once been based, were of limited value in many areas as they were principally reflecting drift geology and post-palace dumping as well as having been inconsistently plotted against the OS grid (Dearne 2011a, 1).

- A general site priority therefore became to excavationally examine further points where resistivity/magnetometry anomalies had previously been assumed to be indicating structural elements of its plan but could no longer be relied upon. Excavation in one such area in 2010, where such anomalies, reinforced by parch mark evidence, apparently represented a circular structure on the presumed line of the southern curtain wall of the palace, established again that they in fact represented dumping to create paths/surfaces, but did locate a possible robber trench representing the curtain wall of the palace and what was provisionally interpreted as a lean-to structure fronting it (Dearne 2011a).
- Further excavation here in 2011 - 2013 (Dearne 2011b; 2012a; 2013) confirmed the presence and likely interpretation of the robber trench which was further traced (and is now believed to relate only to the early/mid fifteenth century house), but showed that the structure thought to front it was what has previously been interpreted as a freestanding post palace demolition L-shaped threshing barn complex including a barn, part open courtyard and a building with possible storage functions.
- Also in 2013 a thorough review of conventional and infrared aerial photographic and LiDAR coverage of the site was produced by the EAS (Pinchbeck 2013), some of the findings of which have informed subsequent work which initially focused again on establishing the course and nature of the perimeter of the palace by excavationally checking geophysical features appearing to relate to its plan.
- Although the immediate continuation of any curtain wall to the west of the exposures obtained in 2010 – 13 was not examined at this time due to the presence of an avenue of major trees, geophysical, LiDAR and surface topography evidence suggested that it likely ran north west in the vicinity of the avenue and continued for a considerable distance on this alignment. However, given the problems with geophysical evidence on the site, excavational confirmation of the causes of these features was clearly required and was provided in July 2014 by a section across a double moat fronting the well preserved facade wall of the palace at a point where a garderobe chute discharged into the inner moat (Dearne 2014; and Fig. 1).
- In order to trace the facade wall further to the north west and ascertain whether it fronted a range of buildings (as seemed likely in 2014) in 2015 the EAS excavated several trenches in two groups west of the 2014 work locating a second garderobe chute, but also establishing that the robbed facade wall was of slighter build west of these (Dearne 2015; and Fig. 1).
- The nature and extent of any range of buildings which the facade wall fronted still being unknown, in 2016 (Dearne 2016) a larger open area excavation was undertaken immediately north of the 2014/15 work to investigate this area. This work confirmed the presence of a large building, recovering evidence for at least three glazed tile or rammed pebble and chalk floored rooms divided by dwarf walls for timber partitions and for the presence of a stairwell. However, the full extent and plan of this building remained uncertain, only the facade wall of the palace being confirmed as one of its external walls and it being apparent that further rooms within it may have existed.
- A further season of excavation in 2017 (Dearne 2017c) then established the position of the west wall of the building, identified a possible northern limit to it marked by a large brick built drain, suggested that the building comprised at least seven rooms and sampled some of those on the east including one with a sequence of patterned brick floors and what then appeared to be a brick built oven (see further above in the Introduction).
- Very extensive archaeological excavations and monitoring on the nearby site of Forty Hall were also undertaken by the EAS (and others) in 2009 – 11 (for details see Dearne 2012b) and further extensive excavations and watching briefs at Forty Hall and on the wider estate surrounding it were undertaken in 2013 – 18 (Dearne and Pinchbeck 2015; 2018; Dearne 2017a; 2017b). The latter included

examination of areas peripheral to the brick clamp excavated in 2005 and examination of a midden area relating to the palace near to Maidens Brook.

## THE STRATIGRAPHIC SEQUENCES

### The Natural

- The earliest deposit contacted in most areas and seen in Trenches 1 - 7 was [4]/[22], the compacted, sterile natural brickearth (a strong brown (7.5 YR 5/6) very clayey silt), which survived to between +32.016 and 32.573 m OD.
- However, a small sondage in Trench 5 found a natural compacted, iron panned and stained deposit of rounded 0.02 – 0.04 m pebbles, [29], below the probable outer court surface which likely represented a high point (at +31.979 m OD) in the Taplow gravel which generally underlays the brickearth on the site but is exposed in some areas where the brickearth is absent/truncated.

### Site Phasing

- As in 2017 (see Dearne 2017c, 5), it was clear that elements of the building complex being excavated belonged to more than one phase of activity and in some areas up to six phases of construction/modification were represented, though often only certainly by the re-laying of floors. However, one of the aims of the present work was to establish whether a building phase later than the demolition of the majority of the palace was also represented as suspected in previous work. This previously advanced hypothesis had been put in doubt by findings in 2017 and documentary evidence research since the preparation of Dearne (2017c) has even more seriously questioned it. The results of the excavation reported here now in fact underline that such a post palace demolition building phase is likely to be illusory. Although some activity is still allocated to Phase 5 (following the demolition of the palace c. 1656), it therefore now seems that a significant barn structure, the phasing of which was discussed in Dearne (2107c, 19ff), and so other structures to its east belong to Phase 2 not Phase 5.
- The same documentary evidence research also strongly suggests that the dating of the phasing scheme presented in Dearne (2017c, 5) should be modified as it is now evident that the palace was not redeveloped by Henry VIII but only repaired and modified in relatively minor ways (Dearne *et al* in prep.). Thus, Phase 1 of the 2017 scheme can no longer be seen as belonging to the late fifteenth century redevelopment by Sir Thomas Lovell and must belong to the earlier fifteenth century house now believed to have been created by John Tiptoft, Earl of Worcester (op cit). Consequently too Phase 2 is now believed to represent the work of Lovell with Phase 3 representing repair and modification after initial construction of the Phase 2 building which could have occurred at a variety of dates through the late fifteenth and probably especially in the sixteenth and earlier seventeenth centuries.
- Both Phases 2 and 3 appear to be characterised by the use of harder and often, but not always, whiter mortars than the softer, sandy, yellow mortars of Phase 1, but specific dating evidence is very scarce. In 2017 there were three deposits that might be regarded as belonging to the opening of Phase 2 (FXO17 [11], [12] and [13]). They principally contained PMR/PMRE material, but also a few sherds of FREC and [11] a chip of BORDG (FREC is usually believed to have begun to be imported c. 1550 and BORD to have begun production c. 1550). However, FXO17 contexts [12] and [13] represented the floor and floor make up of Room 4 (FXQ18 contexts [57] and [58] below) and it was clear in 2017 and the present work that that floor surface at least had been very badly damaged, even if not replaced at some stage(s) in Phase 3, which is anyway highly likely (see further below). Even sherds from FXO17 [13] cannot therefore be taken as securely stratified (and one sherd from FXO17 [12] may on re-examination be of Raeren Stoneware (RAER; 1480 – 1610)). This leaves a single sherd of FREC and a single chip of BORDG from the fill of a tree removal pit and makeup of the floor in Room 3, of which the chip on re-examination may in fact be of Coarse Border Ware (CBW; 1270 – 1500) and the small body sherd of FREC is not typical of this fabric. There is a possibility that it is again of Raeren Stoneware and even if of FREC it would be very unwise to rely on one small sherd to date the inception of Phase 2, especially as again the Room 3 floor now seems highly likely to have been replaced (see fn. 11 below).
- The work reported here, however, underlines that changes in Phase 3 were not all contemporary with each other, so it should not be seen as marking any concerted replanning, but rather reflects ongoing adaptation and repair of the building complex over at least a century or more. Indeed, based on a sequence of floor surfaces, it is now possible to sub-divide Phase 3 into four sub-phases in some

parts of the east of the area being excavated, though none of the sub-phases are absolutely dateable and to which sub-phase structures rather than floor surfaces in 'Room 5' and 'Room 6' belong remains problematic if not speculative.

### Brick Morphology

- Unless otherwise stated bricks were hand made, hard fired, unfrogged and red (around 2.5 YR 5/8) without marginal creases. Precise dimensions varied considerably in the range 0.22 – 0.24 m long, 0.10 – 0.12 m wide and 0.05 – 0.07 m thick. More precise ranges are given for some of the more important structural features and full details are available in archive.

### Phase 1 (?mid fifteenth century) Figs 1 and 10

- Only one feature in the present work, wall [45], appeared to be of Phase 1. It was an approximately north south wall, 0.41 m wide which had been truncated by Phase 4 cut [41] and only one (presumably foundation) course of it was seen. It was built with part brick stretcher lain faces to a brick rubble and mortar core, the bricks being c. 0.055 m thick where assessable and the mortar fairly hard, very pale brown (10 YR 8/3) and sandy (using fine grained sand). Although the mortar did not exactly match the (yellow) mortar used in the slightly more substantial Phase 1 wall found in 2017 (FXO17 [37]) 2.90 m to the south, [45] precisely shared its orientation and its west face aligned with the east face of FXO17 [37] so that, even if it was not part of the same structure, it was almost certainly part of the same Phase 1 building complex.
- In addition the slumping of several floor surfaces excavated in 2017 and 2018 may well indicate the general positions of filled cut features belonging to Phase 1 or earlier. In particular the slumping of Phase 3a floor [56] in the northern part of Trench 7 may strongly suggest the presence of a north south feature below it, but only the removal of the floor would be able to confirm this.

### Phase 2 (c. 1486 and later) Figs 1, 2, 6 – 8, 10 and 12 - 14

- The majority of structural features and some of the associated floor deposits excavated in 2018 appear in inception to belong to this period and the present excavation was aimed at revealing additional parts of a large building complex, whose basic plan had probably largely stayed the same throughout its life. However, the work underlined that it had had been adapted a number of times in Phase 3 and, as noted, correlation of evidence from FXO17 and the present work for the first time allows some relative phasing of Phase 3 changes in some areas of the building to be proposed. It should be underlined though that phasing other than of floor surfaces remains terribly difficult to demonstrate and some phasing relies on correlations of the absolute level of floor surfaces rather than stratigraphic relationships. Thus, what seem most likely to be structural modifications in Phase 3a in Room 5 cannot actually be ruled out as parts of the original Phase 2 scheme (while the evidence for identifying other features in the south of this room as belonging to Phase 3b not 3a (and so again even potentially part of the original build) is inferential at best). The following account should also be read in tandem with Dearne (2017c) and the scheme of designation for rooms within the building complex is that adopted in this 2017 report; note also that most tree roots have been omitted from plans as to include them would make plans unintelligible in many cases.
- On the north side of the building complex the most significant point to be clarified by the work was the integrality of the barn excavated in 2010 - 2013 (Dearne 2011a; 2011b; 2012a; 2013) with the structures recorded in 2017. Trenches 1 – 5 all provided exposures of the dwarf brick walls forming the west end of this structure and the overlapping of 2018 and earlier trenches (and contiguous cutting of 2018 trenches) provided definite confirmation that the barn (i.e. Room 7) was built integrally with the walls delimiting Rooms 3 and 6 in the building complex under study.<sup>1</sup> Trench 1, like 2017 Trench 6, additionally showed that the successive floor surfaces of Room 6 respected the south wall of the barn. An apparent gap in the south wall of the barn identified in 2012 was also shown to have in fact been an area where the wall had been demolished to a much lower level than elsewhere; and possible evidence for an entrance into the barn at the west end (suggested by a trench cut in 2012 at a position dictated by magnetometry survey which is now known to be misplotted) was shown to have related instead to damage to the Room 3 floor. However, there may be some

---

<sup>1</sup> The overlapping trenches (as well as the re-exposure of a key point in the plan of the building originally excavated in 2016) also provided a check on the exact relationships between trenches, and so features, excavated during the current and previous work, allowing some slight revisions to the overall site plan, the accuracy of which had been compromised by the lack of permanent fixed points other than a few trees. Fig. 1 herein should therefore be taken to supersede all previous overall site plans.



inferential evidence for an entrance from the barn into Room 6 coincident with the point where the barn's south wall had been demolished to a lower level (see Phase 3c).

- The barn/Room 7 can now therefore be confirmed as an internally 6.50 - 6.70 m wide, c. 16.90 m long structure which was integral with, but continued south east beyond the easternmost point of the rest of the building complex as so far excavated. This has significant implications for the overall plan of this part of the palace which are examined below in the Discussion.
- The barn itself though was represented by dwarf brick walls on the south ([8] = FXO17 [52]), north ([23]) and west ([5] = FXO17 [45]), which were 0.36 - 0.40 m wide; and a sondage cut against the inner face of the southern (Pl. 1) showed that it at least was of ten courses of brickwork incorporating two small offsets with five courses above the floor level of the barn so that the base beam of the timber frame of the barn will have lain c. 0.28 m above the interior floor of the barn. Though no construction trench was isolatable here it had presumably been built in one, cut into and backfilled with the natural brickearth, and suggests that the barn was a significant timber structure with a tiled roof (as maybe confirmed by documentary research; Dearne *et al* in prep.). However, Trenches 2 and 3 showed that the west wall of the barn, here [5], built in a construction trench (part of [3]), the sloping lip of which was seen, was of only four courses so that the barn's end walls were probably not load bearing.
- The walls were generally constructed of whole bricks (though the west wall included some part bricks) and had been essentially English bonded, though with some irregularities especially again in the west wall. They were built with a fairly hard, fine textured yellowish brown (10 YR 5/6) mortar, though the mortar in the west wall was slightly paler in colour at 10 YR 7/4. The variations in the west wall may well indicate that it was a slightly earlier or later construction than the side walls of the barn (or was built by a different construction crew), but there was nothing to suggest that it had not been built as part of the same construction process. However, it was evident that the wall lines of the barn had been less than accurately surveyed or had run out of true during construction as the south wall showed a slight curve at the west end of Trench 1 (Pl. 2) and at the north western corner of the building the western wall had been broadened and the northern either broadened by up to 0.17 m (or at least by one stretcher lain skin of brickwork) to reinforce it or more likely misaligned (any correction to such a misalignment laying outside the excavated area) to match the curvature of the south wall (Pl. 4). The foundations at least of the structure therefore narrowed slightly at its west end.
- Internally, there was evidence at the west end of the barn (Room 7), in a small exposure, for a rammed chalk floor [10] which incorporated a small (0.20 m wide; c. 0.02 m deep) drainage channel running along the inside face of the wall (Trench 4 was not excavated either side of the wall itself and there was no such equivalent floor in Trench 3/FXO17 Trench 6, but possible evidence for a similar floor was found at the east end of the barn; Dearne 2013, 9 and 13). However, the majority of the interior floor of the barn seen was probably of natural brickearth ([4]/[22]) even if pieces of demolition rubble up to 0.10 m or more had in places been impressed into it (or in some cases may have been in the backfill to undetected wall construction trenches) to a depth of 0.07 – 0.15 m (this rubble was also seen as FXE12 [8] in 2012 Trench C1 immediately to the north (Dearne 2012a, 6)). Given the evidence elsewhere (e.g. Dearne 2013, 9 and 13) for a rammed pebble and tile fragment floor further east within the barn it may have had discrete areas whose floors were treated differently reflecting different activities occurring within it or the requirements of different forms of storage; the strips of rammed chalk floor at its margins may have been intended to absorb any spillage of liquids or condensation that collected at the base of walls.
- The north wall of the barn was almost certainly an external wall as Trench 5 showed a 1.10 m wide strip of rammed pebble and tile and chalk fragment surfacing [27] north of it, but beyond just a brickearth silt [28] incorporating tile fragments and pieces of chalk kicked out of this strip of surfacing. This is likely to represent the surface of the outer court of the palace and lay over natural gravel.
- To the west of the barn/Room 7, Room 3 was further investigated by Trenches 2 and 3 (and seen in Trench 7). Trench 3 was mainly only excavated to the surface of [6] (= FXO17 [5]), its rammed pebble and chalk fragment floor (also recorded in plan, as [35], at the west end of Trench 7), on which lay a scatter of brick demolition rubble [7] (= FXO17 [15]), but [6] had an only pebble core and was a total of 0.15 m thick above the natural. However, the floor in Trench 2 was more fully evaluated. Although not as badly damaged as in FXO17 Trench 1, which Trench 2 slightly overlapped, it was again tree root disrupted and here demolition damaged, only the area where it ran

up to the west wall of the barn/Room 7 being fully preserved. The demolition damage to it was linear and had exposed a crushed brick (and here tile fragment) bedding [14] (= FXO17 [11B]) or further west a mortar bedding [12] (as also seen in 2017; Dearne 2017c, 10f), and the area of linear damage had been infilled during demolition with brick rubble [7]. This linear infill and the damage exposing the two different make up layers was clearly what was represented in FXE12 Trench B (as [4] and [5] respectively) a little further south.<sup>2</sup> A small sondage through floor [6] (though where its upper surface was almost certainly lost) showed that it was 0.25 m thick (so that the full floor deposit here was at least 0.32 m thick and probably rapidly thickening as it approached a drain to its north). Lain on natural brickearth, its core consisted of a pebble dump interrupted by the crushed brick and tile fragment bedding layer [14] and comparison with other areas of Room 3 indicates that the floor had been thickened here to maintain its level, presumably because the site had a slope down towards the north and east. It is also though possible that the sequence in part represented a re-flooring of Room 3 (see further below).

- As in previous exposures there was no evidence for any wall at the northern edge of the floor in Room 3 and the floor stopped at the southern edge of a major drain [15] (= FXO17 [27]) (Pls 3 and 4). Here even the surviving floor surface was 0.34 – 0.37 m above the level of this drain and had probably originally lain at least 0.40 m above it, so it seems highly unlikely that the part of the building complex under study included the drain and continued north of it. Indeed, north of the drain a linear cut [31] had been made into the brickearth parallel to the drain and only 0.22 m north of it (Pl. 4). The cut was over 0.60 m wide, over 2.50 m long, straight sided and flat based, though sloping down to the east. It was 0.12 m deep and of uncertain purpose, but a strong possibility is that it was an aborted construction cut for the drain which had been begun on a slightly wrong alignment. It was nearly completely filled with [30], a compacted, brown/dark brown (7.5 YR 4/4) very clayey silt with occasional rounded pebbles (to 0.04 m), some brick fragments (to 0.06 m) and moderately frequent tile fragments to 0.10 m, some of which lay horizontally on its base. The fill was very strongly mottled with ironstaining and produced several sherds of a PMRE/PMR flagon.
- Over [30] and the strip of natural between it and the major drain a probable flat surface had been created by the deposition of [26], an up to 0.28 m thick dump also filling the remaining top of cut [31]. It comprised compacted rounded pebbles with occasional cbm fragments (mainly to 0.05 m, but in a middle horizon forming a concentration of brick and tile fragments to 0.10 m) in a matrix of very dark grey very clayey silt. Laying nearly 0.10 m lower than it, the simple pebble dump nature of this deposit in comparison to floor [6] tends to suggest that it could have been an external surface.
- The suggestion in Dearne (2017c, 21) that the south side of the drain might have supported a north wall to the building complex is now rather less likely as a Phase 3 modification to it (see below) indicates that by then its line would have been partly overlain by a ?timber ?chute at least just beyond the very north east corner of Room 3 and, more significantly, it lay c. 0.40 m below the level of the floor of Room 3. Never the less, there was presumably some form of timber revetment retaining the sides of floor [6] and surface [26] either side of drain [15] here and, as again there was no sign of any brick built roof to the drain, it may well be likely that its sides were carried up in timber for at least another c. 0.40 m by a linear box construction, even if the drain just had a removable timber/flagstone covering further west where it was examined in 2017 and its top was at the same level as floor [6]. It is still possible that this construction also served as the base of a timber wall, but rather it now seems more likely that the north side of Room 3 was formed by posts founded on the brick column bases recovered in 2017 from demolition material within Room 3 (Dearne 2017c, 37f) and may have been part open or of slight stud work construction which had left no trace, especially since the surface of floor [6] was damaged.
- Drain [15] itself (Pls 3 and 4) only differed to the exposure obtained to the west in 2017 (FXO17 [27]) in details, but it was perhaps narrowing a little to the east, internally being 0.44 – 0.46 m wide in the west of Trench 2 and 0.43 m wide in the east; and was 0.01 m shallower than in the 2017 exposure (at 0.78 m). Here there was no slumping to the south side wall as seen previously, but the bond of both side walls was more irregular than in 2017, still being recognisably intended to be English bond, but with additional courses of headers disrupting the regularity of the bond especially

---

<sup>2</sup> Thus the former interpretation of the barn having a decayed brick threshold with a mortar strip to the west (see Dearne 2012, 5). Note that a slight plan transcription error led to the mispositioning of FXE12 Trenches B and C on Dearne (2017c) Fig. 1, which has been corrected in the present report.

on the south. Comparison with the previous exposure established that its floor had a fall of about 1 in 65 to the east and one presumes that not far east of the 2018 work it probably dropped further in level to run under the outer court of the palace.

- The possibility that [8], the south wall of the barn/Room 7, had projected into Room 3 subdividing it (because at the point where it met the west wall of the barn ([5] = FXO17 [45]) the latter had a void below its top course when examined in 2017) was discounted by the excavation of Trench 3 (which included limited re-exposure of features in 2017 Trench 6). Although a crude up to 0.13 m deep, over 0.34 m wide ?construction cut (part of [3]) into the natural did continue the line of wall [8], it was probably not regular enough to have been utilised for wall construction and the void did not continue through the thickness of wall [5] so may just have represented poor workmanship. Though only exposed for a distance of 0.27 m, this part of [3] was filled by the pebble dump forming the core of Room 3's floor ([6]) with the addition of some tile fragments.
- Further south within the building under study Trenches 1 and 7 clarified the previously little understood plan of Room 6 and its relationship to Rooms 4 and 5. It appears that, presumably in Phase 2 (though without removing structural features and brick floors the phasing cannot be demonstrated), Room 6 and the northern part of Room 4 were defined on the west by a dwarf wall, [46], for a timber partition. Exposure of a 4.80 m stretch of this wall in Trench 7 (Pls 5 and 8) showed it to be a brick wall topped with complete peg tiles (0.28 x 0.175 x 0.017 m, but probably a little shorter but wider in the northern part of the exposure) to level it for a base beam. The wall itself was not characterised as only one tile was lifted (and replaced), but the tiles had been secured with a fairly hard, very pale brown (10 YR 7/4 - 8/4) fairly sandy mortar and their upper surfaces showed white mortar or whitewash bands at their western and eastern edges suggesting the outline of a base beam probably 0.14 – 0.20 m wide (Pl. 5). Wall [46] did not quite align with [5], the west wall of Room 7 so probably met it at a slight angle – or even formed a dog leg with it – in the unexcavated area between Trenches 3 and 7.<sup>3</sup> It also did not align with the (slighter) wall FXL16 [13] (whose junction with wall FXL16 [6] was re-exposed as a check on planning accuracy) which formed the west wall of Room 4 in the south, though Room 4 may in fact itself have been sub-divided either from the start or in Phase 3 (see further below); but again the projected meeting of [46] and FXL16 [13] was not within the areas excavated.
- At least by Phase 3b, Room 6 was a trapezoidal space declining in north south extent from 5.80 m on the west to probably 4.90 m or less on the east and was over c. 5.00 m in east west extent. However, uncertainty about the position of it and Room 5's east wall(s) means that its full east west extent is unknown and that it was perhaps (?up to) c. 11.00 m in this dimension is a tentative guess (see further below). It also seems that originally in Phase 2 Room 6 extended further south to the east of Room 4; indeed it and Room 5 may originally and until Phase 3b (and then again perhaps later) have formed one continuous L-shaped space. However, the non-removal of lain brick floors means that this cannot be certain and nor can sub-division of the east of Room 6 prior to Phase 3b be ruled out.
- The initial floor of Room 6 is also known only from areas where later demolition revealed it below unremoved Phase 3 floors. The largest exposures were of two areas of floor in Trench 7, [40] and [70], which had been revealed respectively by a Phase 4 demolition cut, [41], and probably by the removal of a Phase 3b wall ?during demolition (or earlier) (Pls 6 and 7). Both were exposures of likely the same well lain floor of edge set bricks and part bricks orientated north east to south west with two brick wide strips of bricks lain north west to south east within them. [40] showed that this floor had been lain onto the natural over [48], a probable levelling and bedding layer of up to 0.04 m rounded pebbles in a dark grey clayey silt matrix overlain by 0.04 m of yellow (10 YR 7/6) sand which survived for another up to 0.64 m east of the point where the floor itself was truncated. Whilst it, [40], typically lay 0.06 m below the level of [70], this was in an area where clearly there had been some slumping of deposits approaching the Phase 1 wall [45] (though it is alternatively possible that the mismatch indicates a step in the floor and that this area was not re-floored in Phase 3a probably raises the possibility that Room 6 was in fact divided into an eastern and a western spaces prior to Phase 3b). A third exposure seen only in section where the south wall of Room 7 ([8]) had been demolished was [19]. It was probably of whole bricks, uniformly lain flat at an angle to the wall on a

---

<sup>3</sup> Wall FXO17 [45] (= FXQ18 [5]) where previously believed to be present at the extreme south west corner of FXO17 Trench 6 can now be seen to more likely be a (?slightly disrupted) fragment of wall [46], which ought to have run almost exactly along the west section of this trench and may even mark the point where the two walls met.

c. 0.02 m thick bed of fairly hard, fine textured yellowish brown (10 YR 5/6) mortar over the natural, but no further details were ascertainable here as an (unremoved) later floor lay above it.

- Together with FXO17 [63], comprising a small 2017 exposure of north south running part bricks which were lain integrally with wall [8] (= FXO17 [52]), and which also seems to represent a primary floor surface at the same level further west, these exposures appear to indicate the existence of a patterned floor comprising areas of edge lain and flat lain bricks in different orientations (just as in the same area in Phase 3a; see below). In addition FXO17 [46], the large area of patterned edge lain brick floor overlaying the natural in Room 5 seen in 2017, lay at approximately the same level as [70] and, whilst its patterning differed in orientation, may well have been continuous with the floor of Room 6 and provides the best evidence for Rooms 5 and 6 not being divided in Phase 2.
- Unremoved later floors prevent certainty, but Room 4 seems to have been divided from Room 6 by only a brick threshold (part of [32]) in Phase 3b (Pl. 7) and so may always have been open on the north. Excavation within this room in 2018 was limited and only served to confirm earlier findings that its very worn rammed pebble and chalk lump floor [57] (= FXO17 [12]) – only a remnant of which survived beside the threshold – lay on a rubble and brick dust bedding [58] (= FXO17 [13]) which was not fully removed in this instance (Pl. 7). This room in fact now seems to have been (or at some point to have been partitioned into) two irregularly shaped rooms, the northern, Room 4, from 3.20 to around 3.90 m east west and either 4.00 – 4.60 m or 4.60 – 5.35 m north south depending on which of two walls ([81] and [82]) formed the presumed division between it and Room 8 to its south. Neither wall can be certainly phased and the presence of a large and partly collapsed tree made excavation in the south of Room 4 and in Room 8 impossible. However, that the east wall of Room 4 ([59] = FXO17 [2]) is known from work in 2017 to have been a Phase 3 (indeed, it is now evident Phase 3b) rebuild makes it most likely that the room was divided sometime later in the building's history so walls [81] and [82] are discussed under Phase 3.
- The most significant problems in discussing the plan of the Phase 2 building complex as currently understood, however, are the position and nature of the east wall of Rooms 5 and 6 south of the barn (Room 7), the nature of its south wall and the original form of Room 5 (whether continuous at this date with Room 6 or not). The south wall was confirmed as constituting the facade wall of the palace in Trench 6. It, [53], was 0.38 m wide and a 3.60 m length of it was seen running east west and forming the south side of Room 5 (Pls 9 and 13). It was built of whole and a few part, typically 0.055 m thick bricks with a hard white mortar in English bond and, whilst, as so often, no construction trench could be isolated, it had obviously been built into one cut into the natural, the three surviving courses seen probably resting on three courses of brick rubble foundations where demolition had exposed part of its north face. It is presumed to belong to Phase 2, but there is no solid evidence to confirm this.
- In the western part of Trench 6, however, the facade wall, here [76], appeared more likely, though far from certain, to be a broader Phase 3 replacement for [53]. It met [53] at an angle, but [53] had almost certainly turned (though not necessarily at the same angle) at this point, a sondage into the natural on the projected line of [53]'s south face demonstrating that it had never continued beyond this point to the west on the same line. That [53] had run along roughly the same course as the rebuild [76] was hinted at by the presence of [85], a terribly badly preserved section of ?wall probably running at right angles to [76], but probably belonging to an earlier phase and maybe a fragment of a tower projecting from the Phase 2 facade wall. Only a 1.10 m length of its west side was seen as a later wall overlay it, it was so decayed that no individual bricks could be discerned within it and it is not impossible that it in some way related instead to the later wall ([62]) which overlay it. It survived to only c. 0.04 m above the surface of the natural, but it was over 0.20 m wide so that it could have been a significant wall and part of a predecessor to the projecting tower complex described under Phase 3b and would align with the presumed line of the east wall of Phase 2 Room 4.
- Also uncertain was the phase of a second wall ([54]) that had been added to the south face of [53], almost certainly at the same time as, and to buttress, a large furnace that had been constructed within the southern part of Room 5 (Pls 9 and 13). The balance of probabilities seems to be on the side of [54] and the furnace belonging to Phase 3 because as part of the changes associated with the furnace the south end of the room had been deepened necessitating the construction of a retaining wall obviously of reused not new materials, but it should be emphasised that strictly speaking [54] need only be stratigraphically not chronologically later than [53].

- The east wall(s) of Rooms 5 and 6 constitute a greater problem. Wall [53] had been thoroughly demolished in Phase 4 at the easternmost point where it was seen and there was no trace of a return wall to the north, but the demolition cut ([41] = FXO17 [34]) which truncated it appears to have been extraordinarily wide and to have taken in a swathe of Rooms 5 and 6. Its variable fills are discussed under Phase 4, but, conflating exposures in 2017 and 2018, it would appear to have run broadly but rather sinuously north west from wall [53] for at least 12.00 m, probably almost up to the south wall of the barn (Room 7). It was over 3.80 m wide where its western side was seen in Trench 7 (Pl. 6), but where its western side was examined in FXO17 Trench 2 the attempt to trace its full width in the adjoining FXQ18 Trench 8 proved impossible as the area of Trench 8 was rendered archaeologically useless by multiple tree throws/planting disturbances, even if the mixed deposits (contexted [1]/[50]/[63]) suggested that the cut continued beyond the eastern edge of Trench 8 and so was probably over 4.00 m wide. That the west side of cut [41] had shallowed from 0.39 m in FXO17 Trench 2 to 0.33 m (and then to 0.23 m as it ran east) in FXQ18 Trench 7 may suggest that it had removed less substantial constructions (? internal features which lay further west) in the vicinity of Room 6, but it should not be assumed that the east side of Room 6 was necessarily coincident with the eastern side of Room 5. The asymmetry of the whole building complex though means that the position of these rooms' eastern wall(s) can only remain speculation and that cut [41] in fact represents the removal of walls not other features is only an assumption.
- Room 5's original form, given this uncertainty about the position of its eastern wall and potentially about the phasing of the furnace and associated features, is also not certain. It may have been c. 7.00 m east west by c. 7.50 m north south (if Room 6 was always separate from it) and its northern part at least was occupied by the patterned edge set brick floor FXO17 [46] seen in 2017. This northern part may have contained a large circular (or perhaps D-shaped) structure (?the predecessor of the ?Phase 3a furnace described below) which, perhaps as part of changes in Phase 3a, was removed and its site covered by a new area of floor (FXO17 [47]) intended to disguise its former position (see Dearn 2017c, 12), but the presence of a 'gutter' at the original floor's edge as preserved (op cit) suggests that this Phase 2 floor ended on the south around 2.70m north of wall [53]. However, the southern part of the interior of the room would appear to have been entirely truncated when the furnace was inserted (if this was in Phase 3) so it is impossible to say what this part of it contained in Phase 2.

### Phase 3 (later fifteenth to earlier seventeenth centuries)

#### *Room 3 Figs. 1 and 6 – 7*

- Presumably beginning at least well after the construction of the Phase 2 structure, though there is no evidence on which to assign even approximate dates to individual events and Phase 3a at least could well belong before 1539 when Henry VIII acquired the palace, clearly modifications were made, probably piecemeal, to some areas at least of the eastern part of the building complex as it is currently known and were evidenced in Trenches 1, 2, 6 and 7. Correlation with earlier findings allows the sequence of the changes to be reconstructed to a degree in Rooms 4, 5 and 6 which are discussed further below, but in Room 3 they cannot be assigned to sub-phase.
- Here the significant modification was to the major drain [15] which probably marked the northern edge of the room. At the east end of Trench 2, where it lay only 0.60 m from the north west corner of the barn/Room 7, the top course of bricks on both sides of it had been removed for over 0.90 m, the natural flanking it on the south and probably north had been cut back and the adjacent ?surface on the north ([26]) had probably been truncated, all indicating that a likely timber construction had been inserted over and feeding into the drain (Pl. 4). Its outline was probably preserved by [13], a dump which had been used to backfill around it, including up to the north wall of the barn and along the latter's line where it filled a ?pick cut gully in the natural brickearth. This backfill was extremely compacted and comprised 0.02 – 0.05 m rounded pebbles and some cobbles in a matrix of yellowish red (5 YR 5/6) gritty brickearth with from rare to moderately frequent cbm fragments (to 0.03 m) but rare tile fragments to 0.12 m and sometimes moderately frequent charcoal (it may well have been reworked material derived from the interface between the Taplow gravel and the overlaying brickearth which comprise the natural on the site). It formed an extremely stable deposit which was very hard to remove, will have preserved the outline of anything that had retained it and suggested that the wooden construction may have been essentially rectangular, but narrowed a little or had had sides which curved slightly as it ran east.
- The construction was presumably a chute into the drain, perhaps from the roof of the barn, but, if so, may have projected from the barn above ground level since between drain [15] and the north wall of

the barn a crude brick surface [24] had been lain over the backfill (Pl. 4). The surface broadened as it ran east, suggesting that it was intended to cover the whole area between the drain and the north wall of the barn, and comprised part bricks and brick fragments to 0.20 m, lain randomly, probably without mortar and perhaps with a slight slope down to the north. It would be difficult to believe that it was intended as an internal floor and was probably an external surface to 'tidy up' the area between the new chute and the barn.

#### *Rooms 4, 5 and 6*

#### **Phase 3a** Figs 1, 3, 8 and 11 – 13

- Parts at least of the floor of Room 6 had clearly been replaced in Phase 3a, though with a new brick floor which probably replicated the mixture of patterned edge and flat lain brick surfaces of Phase 2. However, there was no evidence for this re-flooring extending into Room 5 where the Phase 2 floor FXO17 [46] may still have been in use, nor in the eastern part of Room 6 and, as noted above, the possibility exists that at this time Room 6 in fact comprised two, eastern and western, rooms any division between which would have lain under an unremoved Phase 3b floor.
- There were few exposures from which to judge, but in 2017 the Phase 2 floor FXO17 [63] at the north west corner of Room 6 had evidently been left intact and Phase 3a floor FXO17 [64]/[65]/FXQ18 [56] lain over it (the 2018 work making clear that these contexts all comprised one floor with multiple differently patterned areas, not different floors as seemed possible in 2017). This Phase 3a floor (Pls 8 and 12) included adjacent areas of north south and of east west flat lain bricks/part bricks, areas of mainly north south edge lain bricks/part bricks and at least one area of south west to north east edge lain bricks/part bricks bounded by a double line of north west to south east edge lain bricks. The floor utilised at least some bricks with marginal creases, though no mortar was at least preserved and abutted [46], the west wall of Room 6 and its north wall ([8] = FXO17 [52]), though an area in Trench 1 adjacent to the latter wall showed a much rougher surface, [18], at this level which is suggested below to be a Phase 3b or later patching. The Phase 3a floor was seen, including in the base of a modern pit ([72]), for a distance of c. 1.70 m east of wall [46].
- Meanwhile in Room 5, though its Phase 2 brick floor presumably continued in use in the north of the room, it is most likely (though very far from certain) that it was in Phase 3a that major changes were made connected to the insertion of a large furnace and other features in its southern part. However, whether a new section of facade walling, [76], belonged to later modifications or were part of this Phase 3a scheme it is very hard to be sure and their discussion under Phase 3b not 3a reflects only very tentative conclusions based on quite inferential evidence. As noted above (and see Dearne 2017c, 12) though a large circular or D-shaped feature at the south end of original floor FXO17 [46] may have been removed and its site covered by an area of edge lain brick flooring (FXO17 [47]) intended to disguise its former position, though the only part demolished foundations of this structure (FXO17 [60]) may have been utilised as the base for a new structure associated with the new furnace.
- Unless it had originally been on two levels, the southern c. 2.70 m of at least the west side, and probably all of, the room was now deepened by c. 0.31 m and a rough retaining 'wall' about 2.50 m long built of reused materials along the northern side of the presumed cut (which dog legged c. 0.40 m further north at its western end). It comprised on the west a c. 1.50 m long, 0.40 m wide rough probably dwarf wall of reused bricks (FXO17 [50]; see Dearne 2017c, 14), then to the east of the dog leg [78]/FXO17 [55], a c. 0.70 m long, up to 0.34 m wide block of mortared peg tiles (?perhaps salvaged from, or even an *in situ* remnant of, the demolished furnace immediately to the north) and finally to its east [80], a rough c. 0.30 x 0.30 m block of rubble mortared with hardish, very pale brown (10 YR 7/4 – 8/4) mortar, which abutted the cheek of the new furnace so had been added after its building. However, further east, on the north side of the new furnace, floor FXO17 [46] may have been partially removed and the area deepened by only c. 0.10 m, though what changes if any occurred east of the furnace is unknown due to deep Phase 4 demolition cuts.
- A brick floor was then lain in much of the sunken space created by the deeper cut, leaving space for/respecting an ash pit; the furnace and associated structures were built on to the brick floor; a new brick floor was lain around its northern margin in the more shallowly sunken area; and a buttressing wall was built to the south of it. The floor in the more deeply sunken area had three elements. On the north flanking the ash pit was [79]/FXO17 [61] an at least 1.30 m east west, up to 0.78 m north south area of edge lain whole and part bricks which probably formed a platform from which to access the pit, the bricks mortared in place north of the pit, but with no mortar at least surviving east of it. West

of the ash pit was a floor of whole and part north south orientated flat lain 0.05 – 0.06 m thick bricks [73], damage to which (prior to Phase 4 demolition) revealed an underlying rubble and hardish, fine sand yellow (10 YR 8/6) mortar deposit [75] (not removed) which could have underlain all the floor areas and likely indicates that the area was anticipated to require significant foundations (Pl. 11). East of the ash pit and, once it was built, forming the floor of the furnace (which had a slope down to the north) was a similar floor [73A] of flat but east west lain bricks (though with later repairs).

- The furnace [52]/FXO17 [71] was partly excavated in 2017 (see Dearne 2117c, 14f) and that area of it was re-exposed in the present work so that it could be studied as a whole structure (Pls 9, 10 and report cover). It had seemed possible in 2017 that it may have been a (bread) oven, but quite clearly this interpretation is now untenable and its size and form clearly indicates that it was a furnace, almost certainly intended to heat a large, probably circular metal receptacle (tank, cauldron etc) filled with water which would have sat on/been built into its top. The furnace was oval, internally 1.42 m x 1.26 m with 0.24 m thick walls and a 0.44 m wide, 0.30 – 0.34 m long flue on the west flanked by projecting cheeks. The main chamber survived to a maximum height of 0.70 m on the south where it was built of ten courses of header bonded brickwork using part and whole bricks, the lower six courses bonded with hard, pink (5 YR 7/4) fine sand/brick dust mortar and the higher courses with a slightly different (coarser, hard, pinkish white (5 YR 8/2)) mortar. However, its east end was built of a basal header lain brick course supporting multiple courses of peg tiles, bonded with the hard, pink (5 YR 7/4) fine sand/brick dust mortar, and then (though not preserved in the 2017 exposure) one course of part brick stretchers below two surviving courses of header lain complete bricks (see also Dearne 2017c, 14f, Fig. 3 and Pls 9 and 10). As in 2017 the tile built section had been burnt to dark grey while the brick built section did not show any discolouration, suggesting that the most intense fire had regularly been at the back of the furnace where oxygen depletion had caused reduction of the exposed fabric of the tiles.
- The two cheeks of the furnace had been treated slightly differently and in both cases there was a possibility that they had been modified/repared/rebuilt (presumably in Phase 3b or c), but the inner faces of both where they formed the flue were lost down to the basal courses as were parts of their western faces (and there was significant tree root disruption/obscuring here) so that they were difficult to evaluate (Pl. 10). The southern, [51]/[84], was originally c. 0.375 m wide and up to 0.70 m long, but much of it had probably been built integrally with wall [54] (for which see below), differential survival just giving the impression that it was a separate feature<sup>4</sup> (though wall [54] could perhaps have been built around it). It survived to a maximum of 0.65 m (nine courses of whole and part brickwork bonded with very hard white mortar) on the south. But a line of vertically set peg tile fragments may have marked the beginning of a repair/remodelling of its (poorly preserved) northern part ([84]) which was bonded with a different (hard, pinker (7.5 YR 7/4)) mortar with much small rounded quartz. Whether a rebuild or not [84] incorporated a 0.14 m wide, 0.23 m high void in its west face which penetrated to a depth of 0.24 m into the furnace structure and, given the damage to the west face of the cheek, was probably originally c. 0.365 m long. Clearly this void was original and indicated either that the cheek had been built around a substantial beam, or with the insertion of one into it in mind; and it was matched 0.90 m to the north by a second void in the southern cheek (see below).
- Whether built integrally or not the southern cheek clearly formed part of what seems more likely to have been a new strengthening of the southern wall of the room to buttress the furnace than an original part of its structure. This new wall [54] had been demolished to the same level as the facade wall [53] and initially appeared to be a floor surrounding the south side of the furnace (Pls 9 and 13). However, its top surface retained extensive areas of very hard white mortar and east of the furnace demolition cuts and disruption showed that it was the base of a wall which had been butted on to the north face of [53] and constructed around the perimeter of the southern side of the furnace. Built of whole and part, at least in some cases 0.06 m thick, bricks, where it abutted the furnace cut to fit it, its bond had been changed east of the furnace (where it was probably header bonded) in the single surviving course of walling proper. This overlay a 0.03 m thick layer of mortar above three rough courses of rubble foundations using bricks, peg tiles and medium hard very pale brown (10 YR 7/3) mortar. Whilst [54] need not have been a full height wall, it will have effectively provided both a buttress and a fire proof surround to the furnace.

---

<sup>4</sup> So that initially parts of both the wall, the cheek and later wall [76] were contexted [44].

- The northern cheek of the furnace, [43]/[83], was more substantial than the southern (probably partly because it was not engaged in a wall such as [54]) and may have been integral with foundations intended to carry other structures associated with the functioning of the furnace. The southern end of the structure ([83]), forming the actual furnace cheek which in this case didn't quite align with the inner face of the main chamber, was badly disrupted, but was 0.34 m wide and survived to c. 0.62 m high, built of eight courses of whole and probably part bricks. It was bonded with relatively soft brownish yellow (10 YR 6/6) mortar, distinct from the very hard white mortar which the rest of this cheek (and [51]) used and the void in its west face was in this instance 0.14 x 0.22 x over 0.12 m long (tree root activity prevented its full clearance). Further north the cheek was continued for 0.44 m by the beginning of [43] (a curved joint in the upper part of the cheek between the two again perhaps hinting that [83] was a repair/modification). This first section of [43] comprised two skins of brickwork (c. 0.50 m wide), but it then expanded to the east to a width of 0.72 m (three skins) as it ran a further 0.50 m north, incorporating the most easterly part which was recorded in 2017 (as FXO17 [54]),<sup>5</sup> itself probably resting on the undemolished foundations of the earlier furnace to the north (FXO17 [60]).
- It seems highly likely that the flue of the furnace had also had a vaulted roof sprung on the ends of the cheeks. Thus, demolition material quite distinct from and stratigraphically earlier than that generally spread across the site in Phase 4, and which included unsalvaged whole bricks, items of (hard, very pale brown to yellow 10 YR 8/4 – 8/6) mortared tile construction, wedge shaped blocks of similar mortar and possible crudely cut wedge shaped pieces of brick, came from just within the furnace, its flue and above the final filling of the associated ash pit in both 2017 (see Dearne 2017c, 17, [51] for details) and 2018 ([64]). This suggests a brick built vault using peg tiles as spacers ran the length of the flue towards the ash pit serving it and which was excavated in 2017 (see Dearne 2017c, 15, [66]) with a small further element of it ([77]) seen in plan in the present work c. 0.44 m west of the end of the flue. (It may also be that FXO17 [51]/FXQ18 [64] included material from the demolition of parts of the furnace itself above the level to which it was preserved.)
- Whilst the greater width of the northern cheek of the furnace doubtlessly had much to do with the fact that it also acted as the retaining wall for the eastern end of the cut which had created the sunken area into which the furnace had been built (the mortared rubble [80] abutting its western side) it seems likely that in part it also supported some form of superstructure associated with the furnace. Indeed, a large, deep circular demolition cut recorded in 2017 (FXO17 [49]) immediately north of this cheek's northern end might well be evidence for the removal of another element of a superstructure associated with the furnace, such as a very large ground fast post.<sup>6</sup> Similarly, it is evident that the voids left in the cheeks of the furnace indicate the former presence of substantial beams which projected to the west of the furnace and one might well speculate that they were part of a superstructure such as a frame which oversailed the furnace (perhaps braced into any east (? and new south) wall(s) of the room) and which e.g. carried a hoist for raising and lowering items into the tank or cauldron which it heated. Presumably the southern part of Room 5 was also ventilated in some way, but no evidence seemed to bear on how this might have been achieved.
- It is likely though that a brick floor (be it one floor or a floor which had been repaired/partly replaced) to the north of the furnace where the level of Room 5 had only been lowered by c. 0.10 m and which was excavated in 2017 (FXO17 [73]/[74]) acted as an observation/access platform for those using the tank or cauldron. The exact nature of that use to which the furnace – which appears to have been charcoal fired and very heavily used (see below under Phase 3d) – was put must be speculative to some degree. But it was clearly far too big to suggest that it was for relatively domestic purposes such as boiling water for washing up or even probably laundry and one strongly suspects that it was used for one or both of scalding to remove the hair from e.g. boars or for the boiling of large joints of meat, or that it was connected to a process such as brewing (see further in the Discussion section).
- Tentatively assigned to the same phase of construction (though there is nothing specifically to preclude it being later in date) were a raised east facing 'cupboard' (Pl. 11), 1.30 m west of the furnace ash pit and which one strongly suspects acted as a fuel store for the furnace and or perhaps as

<sup>5</sup> Note that this was slightly misplaced on Dearne (2017c) Fig. 5.

<sup>6</sup> Speculatively, one might suggest some form of pivoting structure intended to load something into the tank or cauldron over the furnace.



a tool store connected to it; and a group of walls which all converged at its north end, though at least one may have been a later addition. The east face at least of the ‘cupboard’ had been built over the brick floor [73] and as preserved the ‘cupboard’ was 1.36 m long, 0.50 m deep and at least 0.36 m high, though it may originally have been longer since the Phase 3?b ?new facade wall [76] appears to have cut angularly across it. It comprised [61], a 0.28 m (four course) high English bonded brick plinth whose top formed its floor; [66], a 0.36 m high, 0.12 m wide single skin back wall which also presumably formed the wall between Room 5 and Room 8; and a north wall which was preserved to the same height, but was part of a larger construction, [42], probably built directly into the natural, as [66] probably also was ([42], [61] and [66] being integral in construction). The back and north walls had been rendered with a 0.007 m thick layer of probably the same very hard white mortar used to construct [61] and probably [66]<sup>7</sup> (the render notably not present on the south wall which was formed by the tentatively presumed later [76]) and the floor of the ‘cupboard’ had (at least by the end of its life) become blackened by charcoal dust (rather than burnt) while a pocket of roundwood charcoal lay on it at its south west corner.

- At the north end of the ‘cupboard’ was a c. 0.90 x 0.58 m block of brickwork, [42], which survived to 0.43 m high, but the base of the 0.09 m thick mortared rubble foundations for it lay 0.16 m above the level of floor [73] (at least in the small east face exposure available ). Above the foundations it survived to five courses of probably rather irregular English bond brickwork bonded with a hard, very pale brown (10 YR 8/4) mortar, though the top surviving surface showed the use of the very hard white mortar used for the ‘cupboard’. As well as forming the north side of this ‘cupboard’, the construction had an integral 0.47 m wide north west running arm forming wall [81] which was built on/into the natural, perhaps in a construction trench backfilled with [87], a redeposited brickearth with rare brick fragments seen only in the north section of the trench. [81] survived to four courses of whole and part bricks, perhaps laid as stretcher bonded faces to a rubble core and probably using the 10 YR 8/4 mortar.
- The tops of [42] and [81] were quite disrupted and whether [42] served any function in of itself (such as being the base for something such as a pillar) was unclear, but it in fact represented the meeting of four walls, the back wall of the ‘cupboard’, wall [81], wall [59] (=FXO17 [2]) and a small west running wall, [82]. Wall [59], the dividing wall between Rooms 4 and 5, as preserved further north was rebuilt in Phase 3b (see below) and had anyway been removed at this southern end, presumably during Phase 4 demolition. Its meeting with [42]’s north east corner was thus only preserved in the present work by the vertical west side of a demolition cut, [67], over 0.48 m wide, over 0.50 m long and at least 0.32 m deep and which may have been linked to another deep demolition cut, FXO17 [48], seen in 2017 immediately to its south east.<sup>8</sup> Wall [82] meanwhile may have abutted [42] rather than been integral with it and was much slighter than other walls forming this block of brickwork as well as showing the use of a different mortar and is suggested below to belong to Phase 3b or later.
- The function of wall [81] might be presumed to have been to subdivide Room 4 (if it had not always been so sub-divided) creating a southern room (now designated Room 8), even though it seems to have been a rather more substantial wall than most within the building and too little of it was seen to rule out its being some other form of construction. Unfortunately though a large fallen tree prevented excavation to the west here so that nothing is known of the southern part of Room 4/Room 8 in any phase.

### **Phase 3b** Figs 1, 4, 8, 9, 11 and 13 - 14

- Phase 3b was marked by a major re-flooring of the northern part of Room 5 and of Room 6 (which seems in this phase to have been one single room as far as one can tell). Rooms 5 and 6 were though now at least probably separated by a substantial wall, built integrally with a rebuilt wall between Rooms 4 and 5. Whether major ?changes to the facade wall of the building at the southern end of Room 5, and or perhaps further changes to Room 8, belong to this phase though is more speculative. Not only does the sub-division of Phase 3 only really rely on the floor surface sequence (which need have no relationship to any changes in structural features), but the evidence on which even to assign different parts of the facade wall to different phases is very far from conclusive.

<sup>7</sup> The top of [66] was formed by a layer of such mortar and it could not be certainly ascertained if this was render or, which is more likely, a mortar joint in the brickwork.

<sup>8</sup> The suggestion in Dearne (2017c, 11) that this represented the position of a doorway is invalidated by the findings of the 2018 work, but it remains likely that it removed something deeply set such as a post or pillar between [81] and FXO17 [50].

- In Room 6 though a large area (3.40 x 2.20 m) of good quality patterned brick flooring, [32], including a southern edge marked by flat lain bricks/part bricks, survived from this phase (Pls 6, 7 and 12). It comprised a large area of north south running edge lain bricks on the east, a 1.26 m wide strip of north west to south east orientated edge lain bricks and at the west end the beginning of a poorly preserved area of flat lain north south orientated whole bricks. At its later truncated eastern end it had been lain over Phase 2 floor [40], but the floor level had been raised by several centimetres. Here [39], a rough packing of (horizontally laying) part bricks (to 0.17 m), brick fragments, chalk lumps, small fragments of worked stone and rounded pebbles around 0.05 m or more thick, had been deposited over [40]. Then a thin (c. 0.015 m) layer, [38], of rammed brown/dark brown (7.5 YR 4/2) gritty clayey silt mottled with mortar and brick chips and including small brick fragments and pebbles, topped with a very thin layer of yellow sand, had been spread over it as a bedding for the new floor. [38] here produced two burnt and not certainly identified sherds and a clay pipe stem fragment which might suggest a date in the seventeenth century for at least the floor replacement in Phase 3b, but the context was poorly sealed and this evidence cannot be relied upon. On the west the new floor had similarly been lain over Phase 3a floor [56], though [38] was absent here and [39] was more of a redeposited brickearth deposit with brick fragments and chalk lumps and c. 0.15 m thick.
- The original extent of the new floor is unclear as it was evidently badly damaged at the north and west margins of the surviving area and had later been removed beyond these margins (see Phases 3c and 3d), but it must be presumed to have occupied all of Room 6 and parts of it probably survived in use to the end of the life of this part of the building complex. It is also not difficult to see why the new floor was probably lain across the whole area as Phase 3a floor [56] had evidently slumped very badly at the west end of the room and some slumping may also have occurred towards the east side of Room 6.
- There was no indication of any significant change to the north end of Room 4 in this phase, the southern edging of floor [32] just abutting its pebble and chalk lump floor,<sup>9</sup> but it seems likely that a new ?wall was built to separate Room 6 from Room 5, the northern end of which was also refloored. Much of this new patterned floor of edge set bricks in Room 5 was excavated in 2017 as FXO17 [14] and its continuation, FXQ18 [60], without any significant differences and which ran nearly as far as the north end of the room, was examined in the present work, where it had been lain over Phase 2 floor [70], bedded on a 0.06 m thick deposit, [71], of dark brown very clayey silt with frequent chalk fragments (to 0.05 m) (Pl. 7).
- However, it stopped (rather than appeared to have been removed) 0.70 m south of the southern edge of Room 6 floor [32] and coincident with evidence for a return to the north end of [59] (= FXO17 [2]), the wall separating Room 4 from Room 5. This wall had also been examined in 2017 when it was apparent that it had been re-built at the same time as the Phase 3b floor FXO17 [14] had been lain and slightly better preservation in the 2018 exposure (when it was 0.24 m wide and three courses of it were seen) made clear that, like many other walls in the building, most of its top had been levelled with part and whole peg tiles on which a timber base beam would have sat. But the northern 0.82 m of it had been brick built to a higher level, though only 0.01 – 0.02 m of the next brick course had survived demolition (Pl. 7). That the area where floor [60] was absent adjacent to this was underlain by Phase 2 brick floor [70], 0.14 m below the surface of [60], would have meant that no foundations for an east west ?wall<sup>10</sup> forming a return to [59] would have been necessary so it is perhaps not surprising that no other traces of any ?wall itself were found. However, one suspects that either the ?wall comprised materials such as stone worth entirely salvaging in Phase 4 demolition, or that the wall was removed in Phase 3c or 3d since most other such walls did not show such complete Phase 4 demolition. Indeed, the void was filled by [69]/[74], a moderately compacted redeposited brickearth deposit with reasonably dense brick fragments (to 0.07 m) in some horizons, occasional tile fragments to 0.09 m, and chalk lumps to 0.05 m which would not be entirely typical of Phase 4 demolition deposits here and might have been a rough infill belonging to e.g. Phase 3d.

<sup>9</sup> Given the raising of floor levels in this phase one might well speculate that the floor of Room 4 had also been replaced to maintain its relative level, but there was no specific evidence to show this as what survived of it was very fragmentary.

<sup>10</sup> An alternative possibility is though that the void left in floor [70] did not indicate a removed wall but some other feature. Only a 0.50 m length of the void was seen and it is not impossible that it marked something such as one side of a substantial doorway.

- Meanwhile it may be that some alteration to Room 8 happened in this (or a later) phase. Thus, a small wall, [82], 0.25 m wide and built of at least three courses of two skins of stretcher laid part bricks ran west from the east side of [42] (the large presumed Phase 3a block of brickwork at the north side of the ‘cupboard’ in Room 5) and may have been butted against it rather than been integral with it. Though this was not certain, that it was a later addition was also suggested by the mortar bonding it which was hard but yellow (10 YR 7/6 – 8/6) and so did not seem to match that of [42]. Only 0.24 m of the wall was seen and again a fallen tree prevented excavation further west in Room 8 so what function the wall served is unknown.
- As emphasised, the phasing of possible additional changes to the southern end of Room 5 also cannot be at all certain since no structural features or floors were removed. However, at some point the floor of the furnace had probably become damaged and an area of repairs was evident in plan at the west side of its main chamber. But more significantly the facade wall of the building in the western part of Room 5 and probably along the south side of Room 8 appears most likely to have been re-built and an elaborate projecting tower added to it (conceivably to replace an earlier one indicated by ?wall [85]; see Phase 2). The ?new wall, [76], was 0.84 m wide and in one area survived to 10 courses of brickwork, though more usually eight courses (0.56 m) above what was probably a 0.07+ m wide offset to its northern face at the level of floor [73]/[73A]. The lower five courses above the offset appeared to use whole bricks in English bond, though higher courses appeared to be more often of part bricks and in an irregular bond. It was built with a hard, very pale brown (10 YR 8/3) mortar, slightly different to that used in the Phase 2 facade wall [53], but there was no opportunity to examine the meeting of the two walls in detail.
- Thus, that [76] belonged to Phase 3b not Phase 2 (or at least Phase 3a) rests only on the slight mortar difference, the different wall widths, [76]’s relationship to the ‘cupboard’ (see above) which it ran at an angle across and perhaps on a possible ?realignment of a strip of floor [73A] adjacent to it (though the floor was quite damaged here and it would be unwise to rely on what was a general impression of brick orientation). Moreover, even accepting that any changes to this area described under Phase 3a were not parts of the original Phase 2 scheme, that wall [76] was later still rests really only on its relationship to the ‘cupboard’ (whose own sub-phasing is far from solidly established) and means that its placing in this phase is very tentative. Nevertheless the evidence of changes in the flooring of the building, on which most sub-phasing relies, tends to be for patching of Phase 3b floors in later sub-phases (see below) so that the balance of probabilities is at least on the side of any such major reconstruction work belonging to the earlier parts of Phase 3 not later.
- In any event, probably contemporary with [76], whichever phase it belonged to, was the construction of an elaborate tower, [62]/[86], projecting south from it (Pl. 14). It should be emphasised that, except for a small area on its eastern side, the tower was not excavated (and the surfaces of its walls seen in many cases were badly mortar obscured), but rather its plan was traced simply by deturfing (see also under Conservation and Research Implications) so that no stratigraphic information is available beyond the facts that in the small area which was formally excavated it had been built into the natural except where it overlay wall [85]. Moreover, that it was built integrally with [76] rests on a highly tree root disrupted exposure of its surface where it seemed to meet it in the solely deturfed area, an apparent agreement between the mortar in use in both and the fact that [62]’s eastern wall appeared to form part of [76] in Trench 6, but at a point where a massive tree root largely obscured the junction (and indeed where part of the whole wall had been cracked and displaced by tree root action).
- The tower though was multi-angular, comprised at least two and probably three elements, was overall in excess of 6.50 m wide and projected up to 3.00 m south from the south side of the facade wall. Its walls all appeared to be of one build and survived – where formally excavated – to at least five courses of part and whole bricks, probably laid in basically English bond with variations to account for changes in wall angle and were bonded with probably the same mortar as wall [76]. Its central and largest element was a 6.50 m projecting, 2.95 m wide tower with 0.42 – 0.45 m thick walls, angled corners to its southern end and rounded corners to its interior space which will have measured 2.16 x 2.02 m. A smaller tower, projecting 2.20 m from the facade wall, was attached to its east by a narrower (0.36 m wide) wall but had an up to 0.50 m wide eastern wall, again had an angled external corner and had a more rounded internal corner, probably to a 1.84 x 1.14 m internal space. The third element of the tower (separately contexted [86]) was much more poorly preserved (see also under Conservation and Research Implications) and was not fully traced, but what was seen

of it comprised a 0.35 m wide wall leaving the south west angled corner of the central tower to run west for at least 1.56 m, possibly to form a more rectilinear third element of the tower complex.

### **Phase 3c** Figs 1, 4 and 8

- Phase 3c seems to be represented by the rather rough brick patching of areas of the Phase 3b floors and may well indicate that the building complex was in decline and, while still in use, rather makeshift repairs were being undertaken with reused materials, at least in Room 6. Thus, areas of the Phase 3b floor [32] (which may already have slumped a little on the east as it was found to have a distinct slope down from west to east as preserved) had evidently been removed down to Phase 2 floor levels ([19] and [56]) in some places and roughly lain brick surfaces [18] and [55] had been inserted. These were only seen in two discrete areas, one at a point along the north edge of the room and one adjacent to wall [46] on its west, so that it may be that more of floor [32] remained in tact than it did by the time that a further phase of floor replacement happened in Phase 3d. One might also speculate that these two areas may have seen greater wear than other parts of the room so may well indicate the positions of entrances into Room 6 from Room 7 (the barn) and Room 3 respectively. The more northerly of them showed the laying of the new surface, [18] (Pl. 2), directly over Phase 2 floor [19]. In a relatively small exposure here, and though partly removed by the cut for a nineteenth century land drain, the replacement floor was of 0.08 – 0.20 m long part bricks lain close together to form a flat surface, but with no intention to lay them in a regular pattern.
- The western area of new flooring ([55]) may have been much more ragged through wear than it had originally been and it had clearly badly slumped by the time it was itself replaced in Phase 3d, but as it survived was a 1.00 x 1.60 m, and perhaps originally a larger rectangular area of flat lain part and nearly complete bricks lain at right angles to [46] (the west wall of Room 6) and replicating the southern edging of floor [32] where it would have met Room 4 (Pls 5 and 12). Further from these edges though the part bricks were lain much more randomly even if the apparent unevenness of the surface was due to wear damage and slumping. Adjacent to wall [46] the floor level now lay around 0.06 m higher than the top of the peg tile levelled wall so that there was probably a step up between Room 3 and Room 6 if an entrance existed at this point.

### **Phase 3d** Figs 1, 5, 8, 9 and 11 – 12

- What seems to have been the final phase of the use of and alterations to this part of the building complex saw the removal of at least one and possibly two walls so that there was now no formal division between Rooms 3 and 6 and perhaps 5 and 6 and a more widespread re-flooring of parts of the north west of Room 6. Phase 3c floor [55] had by now probably slumped to the east of wall [46] while further areas of the Phase 3b floor [32], though a fairly large area of it was probably still in use if with increasingly ragged and irregular margins to the surviving part, were now likely too damaged to use and so were removed down to the Phase 2 floor [56] across an area at the north west corner of the room. At the same time the timber wall which stood on [46] was clearly removed and it may have been that the wall between Rooms 5 and 6 was as well (see above).
- To fill the linear void left by the removal of the timber wall from [46] (which now lay well below floor level), and to re-level the area occupied by the slumped floor [55] and deeper voids where [32]'s removal had revealed [56], a dump of rubble, pebbles and chalk fragments was introduced to form a new floor surface [47]. The intention seems to have been, where no brick floor now existed in Room 6, to create a similar and continuous floor surface to that in Rooms 3 and 4 ([35] and [57]) and adjacent to these rooms [47] was indistinguishable from, and in the case of [35] at the same absolute level as, their pebble and chalk lump floors.<sup>11</sup> But the dump was quite variable elsewhere. Above the southern part of the former wall [46] it was typically 0.175 m thick, over the western edge of [55] 0.10 m thick and probably thickened further over the slumped part of [55] (where [47] was probably damaged and demolition rubble [33] filled voids in it), probably to become nearly 0.20 m thick just to the east where floor [56] had been re-exposed. Similarly north of [55] it was typically 0.10 m thick over wall [46] and over the adjacent earlier floor [56], which here was especially badly slumped, it thickened from around 0.05 m in the west to over 0.16 m in the east. Where [47] filled deeper voids over the western part of [55] and over [56] its lower horizons contained significant amounts of brick

---

<sup>11</sup> It must be strongly suspected that parts if not all of Rooms 3 and 4 had been resurfaced as well during the lifetime of the building, especially since by Phase 3d the floor of Room 3 was at the same level as that of Room 6 despite the raising of the level of the latter's floor. Very little of Room 4's floor surface survived while the floor of Room 3 was not removed adjacent to Room 6, but multiple exposures of the latter in previous years have shown its preservation to be quite variable and it is likely that any resurfacings just replicated its pebble and chalk fragment surface so would have been indistinguishable.

rubble, often in fragments up to 0.10 m, occasionally to 0.20 and at one point comprising a group of drip glazed half bricks that had been placed horizontally on to [56]; and as it ran north it often contained much larger pebbles/cobbles than further south. Its upper horizons also included some cbm, in one area adjacent to the disrupted edge of [32] probably incorporating bricks dislodged from it, but its chalk fragment content was very variable, declining as it ran north except for discrete patches which were almost entirely of chalk fragments (Pl. 8) towards the west side of the room. Indeed, as it approached the northern side of Room 6, where it lay over [56] = FXO17 [64]/[65] and was excavated in 2017 as FXO17 [59], its chalk content disappeared and it became solely a 0.09 m thick rammed pebble surface (which either did not continue quite as far as the north wall ([8] = FXO17 [52]) or had been truncated here).<sup>12</sup> Although a significant sample of [47] was excavated it produced only a single sherd of PMRE/PMR.

- Other areas of Room 6 could have been treated similarly. Thus, in Trench 1 what appeared to be an often only c. 0.03 m thick deposit of ?rammed 0.02 – 0.05 m rounded pebbles with fairly rare brick fragments to 0.12 m, [16], seemed to form a surface over the rough Phase 3c brick floor [18]. However, this surface (which was also found in FXE12 Trench C (context [3])) - although tree root activity, later land drain installation and other factors prevented delineation of its extent on the east and in some cases north - seemed to continue north in 2018 over Phase 4 demolition deposits [9]/[20] where [8], the south wall of the barn (Room 7), had been demolished. It may therefore be that [16] belonged to Phase 5 unless two separate surfaces of Phases 3d and 5 existed but were indistinguishable (see also Phase 5 below).
- South of Room 6 there seems to have been little change since at least Phase 3b. Room 4's floor had clearly seen a great deal of wear and was lost except at its northern margin while in the northern part of Room 5 the Phase 3b brick floor [60]/FXO17 [14] was probably still in use but may have been damaged. Its ragged southern edge (Dearne 2017c, 16) may have been due to Phase 4 demolition damage, but equally it could have sustained damage earlier and, as the damage just exposed the serviceable Phase 2 floor [46] below it, it would only have meant that there was now a rather ragged step down within the room.
- The south of Room 5 had clearly seen some unrepaired damage by the end of the life of the building and the furnace area had been allowed to accumulate fuel residues to some depth. Thus, part of floor [73] was now missing as was part of the top course of the floor of the 'cupboard', [61], (Pl. 11) and that the former at least was not demolition damage was confirmed by its covering by [65]/[68], up to 0.07 m of black, charcoal fuel ash deriving from the furnace. Indeed, as in 2017, the same fuel ash deposit, a fairly loose, black (10 YR 2/7), clayey silt textured, charcoal rich fuel residue in some cases with small clumps of brickearth (= FXO17 [72]) lay to a thickness, of up to 0.02 m on the floor of the furnace and its flue, and across the whole sunken floor surface [73]/[73A]/[79] to a depth of at least 0.02 m even where it approached the 'cupboard'.<sup>13</sup> It included a few in tact pieces of 0.023 m diameter roundwood charcoal and evidently represented debris from firing the furnace after the associated ash pit, excavated in 2017 (Dearne 2017c, 15), had become completely filled. Both the ash pit fill and [65]/[68] produced single body sherds of PMBL, showing that this build up of fuel residues occurred post c. 1580 and giving the only certain close dating evidence for the whole Phase 3 sequence.

#### Phase 4 (principally c. 1657) Figs 1, 7, 10 and 12

- All areas of the Phase 2/3 complex examined showed evidence of widespread demolition in the form of demolition cuts and especially the deposition of demolition rubble (and pebble rich dumps which might belong to Phase 5). There is no reason not to assign all the cuts and at least rubble dumps to a single episode c. 1657 except in one case.
- The exception is cut FXO17 [56] in the area of the Room 5 furnace ash pit (though the cut could not be traced further in 2018 and may have been localised to the environs of the ash pit) which was filled by rubble FXO17 [51]. The same rubble was found, as [64], in 2018 to extend east of the ash pit across the fuel ash covered floor [73A] and into the west side of the furnace and almost certainly

<sup>12</sup> It was this surface, then allocated to Phase 5, which had seemed in 2017 to provide some of the evidence for the barn (Room 7) being either a later construction than the main building or having been retained after the demolition of the rest of the building (see Dearne 2017c, 20), but clearly it in fact formed part of [47] and belonged to this earlier phase.

<sup>13</sup> Processing of a bulk sample of the ash from over floor [73] found that it was a fine, dark greyish (2.5 Y 4/2) silt, comprising clayey silt and charcoal dust with up to 0.019 m sized charcoal granules, some cbm fragments (typically 0.003 – 0.005 m), a little fine gravel and only two small (c. 0.01 m) fragments of ?mammalian bone.

derived from the demolition of a vaulted roof to the furnace flue (see Phase 3a above). Whether its demolition had significantly preceded that of the rest of the building remained uncertain, but the failure to recover re-usable bricks from its debris is suggestive at least of the demolition happening before what otherwise seems to have been a more systematic process of building materials salvage began.

- Although one other demolition cut, [67] (see Phase 3a), was evident south of the barn/Room 7 in 2018, by far the largest and most significant cut was [41] (= FXO17 [34]). As noted above, this seems to have been an extremely long and wide cut which removed a significant part of the east side of the building and seems highly likely to have at least in part targeted the east wall(s) of Rooms 5 and 6. Why such a large cut – probably around 12.00 m long and over 4.00 m wide – was required is though a problem if its main purpose was to remove the walls of Rooms 5 and 6 as other at least brick built features were just truncated. One possibility is that the east walls of Rooms 5 and 6 were much more massive than other walls and or perhaps contained materials (such as dressed stone) which it was more of a priority to salvage. But this does not seem to be a sufficiently convincing explanation, even if the east walls of Rooms 5 and 6 represented an external wall which may anyway be unlikely (see further in the Discussion section). It might though be speculated that there were other ground fast features on the east side of Rooms 5 and 6 which were worth the effort of removal or which it was easiest or necessary to remove in their entirety. For instance no water supply or drainage features are known serving these rooms and had e.g. lead cisterns existed here they would undoubtedly have been targeted for salvaging.<sup>14</sup> Alternatively one might wonder if structures such as ovens, stone built kitchen fireplaces or brewing vats might have lain here ?built into/against the east wall(s).
- In any event [41] was clearly a substantial flat based and (on the west) fairly steep sided cut, its (stepped) west side clearly traceable in Trench 7 (Pl. 6) and in FXO17 Trench 2 it had already been shown to have been cut late in the sequence of the demolition process (Dearne 2017c, 18). However, no western edge to it could be specifically isolated in 2018 Trench 6 except where it truncated the palace facade wall [53]. The likelihood is that it had swung west immediately north of this wall where it or some other cut also disrupted part of wall [54]<sup>15</sup> and then skirted the furnace in Room 5 before running north and then perhaps west again (as the previously excavated FXO17 [49] perhaps to remove a large circular feature associated with the Phase 3a furnace) before it returned to running north in the northern part of FXO17 Trench 2. But concern for the integrity of the furnace structure led to the only partial excavation of a section of Trench 6 against the furnace's east end so there was no opportunity to try to confirm any part of this presumption.
- In 2018 Trench 7 the western part of cut [41] as far east as Phase 1 wall [45] had two recognisable if not well differentiated fills, the basal, [36], comprised 0.11 – 0.14 m of brick fragments (to 0.13 and exceptionally 0.20 m), peg tile fragments (to 0.16 m) and pebbles/cobbles (to 0.095 m) in a brown (7.5 YR 5/4) brickearth matrix. Above it the 0.17 – 0.21 m thick [34] was a more compacted and rubble rich deposit with a dark brown (7.5 YR 4/2) matrix, but itself dividable into two horizons. The lower incorporated moderately frequent part bricks (to 0.15 m), peg tile fragments (to 0.14 m), chalk lumps (to 0.10 m), occasional walling flints, larger pebbles/cobbles, moderately frequent pieces of roofing slate and roundwood charcoal, occasional oyster shells and pieces (to 0.05 m) of hard white mortar, some patches of lighter coloured brickearth and much animal bone (often including very large bones). However, the upper typically 0.10 m incorporated rather fewer brick fragments (to 0.12 m) and peg tile fragments (to 0.09 m), but more smaller (to 0.03 and sometimes 0.07 m) rounded pebbles. Chalk and mortar fragments as well as other finds were also rarer in this horizon. This though still broadly parallels the sequence in the same cut seen in 2017 (FXO17 [25] over FXO17 [32]). East of wall [45], however, where the cut stepped up in level, these two phases of filling could not be traced and the typically 0.22 m thick fill of [41] was contexted [34]/[36] as it seemed to change to incorporate far more lumps of hard white mortar and pulverised yellowish sandy mortar

---

<sup>14</sup> Documentary evidence makes clear that the palace had a lead piped water supply, which probably ran downhill from the vicinity of the current lake fronting Forty Hall, and that a fairly elaborate water distribution system probably existed and featured cisterns (Dearne *et al* in prep.). The point of ingress of the piped water supply has not yet been located, but must surely have been somewhere along the southern perimeter of the palace so that the area on the east of Rooms 5 and 6 is at least as likely an entry point for it as any other and if so it might not be surprising if significant water distribution features existed in the vicinity.

<sup>15</sup> Generating the one group of unsalvaged complete loose bricks found other than from [64].

while still including some other demolition rubble, animal bone, pebbles etc like the deposits to the west. Above all though the impression was that it was becoming far more dominated by compacted brickearth than demolition rubble.

- Whilst Trench 8 was not fully excavated because the deposits here were entirely mixed by tree throws/planting cuts, it too gave the impression of those deposits comprising much more compacted brickearth (probably as context [63] below) than demolition rubble in contrast to the area of the same cut seen immediately to the west in FXO17 Trench 2. Similarly at the south east corner of Trench 6 where [41] truncated the facade wall [53] there was little demolition rubble present within the cut beyond the point of truncation and rather the cut seemed to be filled by [63], a highly compacted brickearth with very frequent rounded pebbles to 0.03 m and only a scatter of cbm (to 0.04 m and rarely up to quarter bricks).
- Elsewhere on the east side of Trench 6 any fill to cut [41] was not certainly distinguishable from the more widespread rubble [37], but [36] may have been present at the base of what was a deep demolition cut (be it [41] or not) whether it was overlain by [34] or [37]. Fairly disturbed conditions here probably related to former tree root activity also likely explain somewhat elevated levels of animal bone and to a degree pottery etc recovery rates from topsoil ([1]) in Trench 6, the material probably deriving from the fill of cut [41] and or the Phase 5 deposit [50]. It therefore seems that the cut was filled with a variety of deposits which broadly comprised demolition material – and quite possibly from the amounts of animal bone, pottery etc included redeposited midden material - on the west but giving way to increasingly less rubble rich compacted brickearths as the cut ran east. This may also have been the case with a small and very disturbed evaluation pit (ENC05 Pit 23) which had also sampled the cut's fill east of Trench 6, though then the interface between the fills had appeared to represent the eastern edge of the cut (cf. Dearne 2017c, 18).
- By contrast in the northern part of the building relatively little brick rubble ([7]) lay on floor surfaces in Room 3 except where they had probably been damaged during demolition. However, [21], the fill of the major drain [15] at the northern edge of the building may have been of Phase 4. Although the exposure of this drain fill in 2017 (FXO17 [28]) had suggested that it was a silt, only in its upper horizons with demolition material in it (Dearne 2017c, 19), the present work fully cleared a larger section of it (and partly excavated an area of it where there had been Phase 3 modification) which allowed the full study of complete sections through the fill. Only moderately compacted, the fill was, as in 2017, a dark brown (10 YR 3/3) clayey silt, here with moderately frequent brick fragments (to 0.10 m, some retaining mortar) and peg tile fragments (to 0.10 m), some oyster shells and roundwood charcoal as well as rather more frequent and larger rounded pebbles (to 0.04 m) than in 2017. The presence of the brick fragments throughout the deposit to the base of the drain suggested that it was more likely a deposit connected to site demolition, or at least a mixture of drain silt and backfill, than just a silt relating to use of the drain. This fill also had an upper surface level with the top of the drain which might not be expected if it had simply been a silt and processing of bulk samples of it found that it contained 67% by weight of pebbles and 2.9% by weight of cbm fragments. The bulk sample processing also recovered a small amount of animal bone including from pig, rabbit, rat and mouse as well as egg shell fragments and four *teleostid* fish bones including one from the Common Carp (*Cyprinus carpio*), but it now seems most likely that the fill was at least largely deposited as part of the demolition process as probably emphasised by the presence of a fragment of a ragstone fireplace in it (see Appendix 3).
- Directly over the drain fill and the north side of the drain where it had been modified in Phase 3 was a linear group of multiangularly laying brick and peg tile rubble [17], including a 0.18 x 0.16 x 0.06 m section from a mortared multiple peg tile construction, which clearly related to demolition dumping and may have followed the line of the now removed timber ?chute probably inserted in Phase 3.
- Above [21], [17], the walls of the drain and the Phase 3 modification backfill [13], a dump ([2]) of well compacted very dark grey (5 YR 3/1) clayey silt with very to extremely frequent mainly small (to 0.03 m) rounded pebbles and occasional cbm fragments (to 0.10 m) had then been deposited. It was up to 0.36 m thick and had served to bring the area holding the (sunken and now filled) drain up to the level of floor [6] and surface [26]. It was hard to differentiate from [26] especially, and was highly tree root disturbed (even if not disturbed by tree throw/planting) on the west, but at the east side of Trench 2 at least had also been spread to the south to cover a little of floor [6] and demolition rubble [7], Phase 3 brick surface [24] and the north wall of the barn/Room 7. It produced a semi-

complete TGW small drug jar (see Appendix 3) indicating a deposition date in the seventeenth century, but it was unclear whether it was of Phase 4 or 5 and whether it was purely a landscaping deposit or whether it had also been intended to create a pebbled surface across the area of the sunken drain (though that [26] and most of [6] were not covered strengthens the case for this being so as it would have served to link these earlier surfaces together).

- Parts of the west wall of the barn/Room 7 had had the top course removed, but the west end of the southern wall ([8]) appears to have been the only area where structural features within the east side of the northern part of the area under study had been significantly demolished (and the only point where the dwarf walls of the barn had not been left standing to, or almost to, their full height). Thus the wall fully survived, its top course poorly preserved probably due to the recent impact of motorised lawnmowers, for a distance of around 2.00 m west of the east end of Trench 1, but beyond this had been demolished (where tree roots or later land drain installation had not damaged it/did not obscure it) in a series of steps down to the level of the barn's internal floor (which was also the level it was found at in 2017 Trench 6 immediately to the west). It is presumably conceivable that this reflects the presence of a feature, such as an entrance into the barn from Room 6, being more fully demolished. There was no specific evidence to suggest this, but the demolition did coincide with the slight curve that had been introduced into the line of the wall, it was coincident with the floor repairs of Phase 3c (see above) and this general area produced numbers of dressed walling flints otherwise very rare on the site.
- In Trench 1, as in 2017 Trench 6 (FXO17 [44]), though this was less clear in the latter case, the brickearth floor of the barn and its south wall where demolished had been overlain by a typically 0.20 – 0.23 m thick (compared to 0.16 m thick in 2017) compacted deposit [9]/[20] of densely packed 0.02 – 0.05 m rounded pebbles, very frequent fragments of peg tile (to 0.15 m) and moderately frequent brick fragments (to 0.15 m), though less pebbles and more rubble was evident at the west end of the trench where the deposit (here [20]) was separately excavated. The concentration of peg tile fragments – a small group of which lay horizontally at the base of the deposit at one point – tends to suggest the demolition of a tiled roof, but the deposit also included a number of pieces of roofing slate.
- In Trench 5 a broadly similar deposit [25] overlay both the brickearth floor and the area external to the north wall of the barn to a thickness of up to 0.16 m, but contained less and smaller brick and tile fragments (perhaps partly because much of the demolition rubble in the vicinity of the building complex under excavation as a whole derived from brick structures on its south side).
- Indeed, demolition rubble was strongly concentrated in the southern part of Room 5 in both 2017 and 2018. In Room 6 there was a scatter of multi-angularly laying brick fragments, [33], from 0.05 – 0.10 m in size across [47] (continuing scatter [7] over Room 3 floor [6]/[35]) and they probably occupied some depressions in this Phase 3d floor surface. Similarly there may have been a scatter of demolition rubble over but indistinguishable from [58] in Room 4, but the Phase 3b Room 6 brick floor [32] was generally covered only by topsoil.
- In fact part of this surface probably had more general rubbish (?and fire debris) dumped on to it in Phase 4. Thus, a lower horizon of the topsoil here (though there was no detectable deposit boundary probably because of root and worm reworking) produced a fairly dense concentration of roundwood charcoal, oyster shells, large animal bones and often large matching/joining sherds of several PMR and a TGW vessels (collected as [1](?Reworked Deposit on [32])). The pottery included much of a PMR cauldron/pipkin (see Appendix 3 including 7.29) and lay directly on the floor surface so may well have been smashed *in situ*, with one more sherd of the TGW vessel in demolition deposit [34] probably confirming that this was in Phase 4. Moreover, this deposit was probably one of the main sources of elevated levels of animal bone and pottery recovered more generally from the topsoil, [1], in Trench 7.
- The scatter of demolition rubble [33] continued to the south into the northern part of Room 5 (over floor [60]) getting denser and thicker as it ran south to become the thick spread characterised in 2017 as FXO17 [10] and then to become FXQ18 [37] where it filled the sunken area that held the furnace and associated features. Here it was as much as 0.72 m thick and like FXO17 [10] often comprised both brick and tile as well as hard white and sometimes buff mortar fragments, but it was both denser and more compacted, now with larger brick fragments (to three quarter bricks) and much peg tile including areas at the south end of Trench 6 over the natural where groups of semi-complete and even exceptionally one or two complete tiles lay in 'stacks'. This material additionally included a



few complete bricks clearly derived from the demolition of walls [53], [54] and [76] as well probably as tower [62], which had clearly not been demolished to the same level as other structures and over which no demolition material lay (though there was a little inside the structure in the one area that was fully excavated). [37] also had a basal horizon above [73] of crushed mortar matching that used in [76].

#### Phase 5 (c. 1657 and later)

- Almost certainly immediately following/as part of the demolition process in Phase 4, so that differentiation into phases is just a convenience to mark a possible change of activity set, parts of the Phase 2/3 building's site may have been landscaped, but more specifically in places covered by pebble surfaces. These rammed pebble surfaces, or at least pebble rich dumps, in some cases obviously incorporating remaining demolition material and quite possibly redeposited palace phase midden material, were present in several areas in 2017 and the present work.
- The possibility that [2] formed such a surface at the northern edge of Room 3, perhaps linking pre-existing surfaces [6] and [26], has already been noted, but a second possible area of surfacing was over and south of the demolished parts of the south wall of the barn (Room 7). Here it was uncertain whether the pebble and demolition material dump, [16], was a single deposit over the main demolition rubble [9]/[20] or two indistinguishable deposits of Phases 3d and 5 (see Phase 3d), but at least over and north of the demolished wall the deposit must have been introduced in Phase 5 so it either represented landscaping or surface creation to some degree.
- However, the largest areas of late pebble dumps or surfaces not now shown above to relate to Phase 3d re-flooring [47] appear to have been coincident with cut [41]. This was most clearly the case at the south east corner of Trench 6 where [63], the compacted brickearth fill of the cut, was overlain by a consistent and dense surface of probably rammed rounded pebbles, [50], which graded into [63] but had a definite western edge 0.26 – 0.42 m east of the western edge of the cut and appeared to be an intentionally created surface. Far less definite traces of the same deposit probably lay above the Phase 4 rubble [37] (or [34]) at some points in the north west of the same trench where cut [41] is presumed to have lain while the very mixed deposits in Trench 8 also included what may have been patches of displaced pebble surface material and the easternmost part of Trench 7 showed the same, here only 0.04 or 0.05 m thick, pebble surface above the cut [41] fill [34]/[36]. Together with the (much clearer) evidence of FXO17 Trench 2 [18], this seems to show that at least parts of the filled cut had subsequently been surfaced with rammed pebbles with an admixture of rubble and possible midden material including much animal bone.
- That the surface seems to have followed the line of the cut must immediately raise the suspicion that it was in fact a landscaping deposit to complete the filling of the cut or counteract the real or at least anticipated possibility that the cut fill would slump. However, there is little evidence that the cut was not fully filled in most areas prior to the deposition of [50] and none that the fill had slumped. It must therefore be at least possible that it was intentional path creation and that the line of the path had been chosen in the knowledge that the nature of the fill of the cut would provide it with well drained and solid foundations.

#### **Post Phase 5 Deposits and Features**

- Evidence for much later (nineteenth century) activity was mainly restricted to that for land drainage, a 0.06 m external diameter land drain [11]/[49], formed of 0.28 m long pipe sections, having been lain in a cut across Trenches 1 and 7, truncating a number of deposits and e.g. Phase 3 surfaces including [18] and [47], though it was often inobvious because the cut had been immediately backfilled with the removed material.
- However, in Trench 7 a deep pit, [72], had been cut from topsoil through [47] and presumably abandoned when it hit brick floor [56]. It was circular, c. 0.50 m in diameter, backfilled with topsoil and one presumes that it had been cut with the intention of using it to plant a sapling, its proximity to mature standing tree 0836 suggesting that this may have been before (or quite likely at the time) that tree was planted and so in or before the earlier twentieth century.
- Otherwise all preceding deposits were overlain by [1], a typically dark brown (7.5 YR 3/2) very clayey silt loam topsoil with a higher organic content where below tree cover which gave modern, mainly grassed, surfaces often sloping up slightly from the north to south and east to west at c. +32.440 to 33.100 m OD.
-

## DISCUSSION

- The present work has significantly improved the understanding of the Phase 2/3 building complex which is now believed to belong to the re-development of the site by Sir Thomas Lovell c. 1486 and later. Clearly some form of structure(s) had already existed this far south and west, but the 2017 evidence had shown that the late fifteenth century development had also taken in previously unutilised ground to the west of them. As in 2017, not enough of the Phase 1 structure(s) were seen to advance a functional interpretation of them, but they appear likely to have been reasonably substantial and, if the worked stone and cbm present in FXO17 [11] and now augmented by material from FXQ18 [58] (see Appendix 3) belonged to them rather than Phase 1 structures elsewhere, as must be likely, then they probably included tiled floor surfaces and greensand stone elements.
- The fact that the barn (Room 7) now clearly belongs to Phase 2/3, and that period in the history of the palace being redated to the re-development of the site by Sir Thomas Lovell, also indicates that the southern perimeter of the Phase 1 building complex also lay further north than in Phase 2/3. Thus, a large demolished wall which the L-shaped complex including the barn was found to overlay in 2010 – 13 (Dearne 2011a; 2011b; 2012a; 2013), and which lay well north of the now partly known line of the Phase 2/3 facade wall, clearly belongs to the house believed to have been created by the Earl of Worcester earlier in the fifteenth century and was very likely the facade wall of that Phase 1 house.
- Whatever lay on the site of the main building complex under investigation in Phase 1 was though entirely replaced in Phase 2 by what seems to have been a large at least two storeyed construction with up to eight (or even nine) ground floor rooms in the area excavated to date (even if at some points during its history their number changed as walls were added or removed). It must be presumed, even if it cannot be certainly demonstrated, that the building was all basically of a single original build, later alterations especially to the south of Room 5 notwithstanding. But its plan was very irregular overall and in detail (Fig. 1) and one suspects that some elements may have been ‘fitted in’ to the wider plan of the ‘courtier’s palace’ constructed by Lovell. Indeed, it must be possible that some elements such as the barn (Room 7) and probably facade wall were constructed before others which then had to be fitted round them.
- One of the important implications of the finding that the barn was an integral part of the ‘building’ under investigation since 2014 is indeed that this may well not have been one discrete building but just the north western end of an entire range of structures between the facade wall and the inner court of the palace (Fig. 15). Whilst it seems that the L-shaped range comprising the barn, a possibly colonnaded courtyard and another storage building excavated from 2010 – 2013 formed the north eastern side of this range, this now leaves an up to 11.50 m wide space between the south western side of this L-shaped complex and what can now be projected as the line of the facade wall (assuming that it did not change direction again). Though that space will probably have declined a little in north south extent as the facade wall does not appear to have run quite parallel to the L-shaped range, a significant area between them seems very likely to have held further buildings/rooms comprising a larger south western range of the palace, the area excavated between 2014 and 2018 only representing the westernmost element of it (?with walled gardens to its west).
- Excavation in this area south east of the work reported here has been very restricted so that the line of the facade wall is not established, but what excavation has taken place just south of the southern wall of the barn etc has suggested the presence of rammed pebble and tile fragment surfaces. These have previously been tentatively suggested to be external surfaces, but are identical to such surfaces within the barn and it now seems highly likely that they are in fact the floors of further rooms of the south western range which remain unexcavated. Indeed, the southern wall of the probable courtyard within the L-shaped complex (FXD11 [3]; see Dearne 2011) would make a great deal more sense as the northern wall of an unexcavated room.
- How far this now proposed south western range continued it is currently difficult to say. Available geophysical survey data (Bartlett 1998, Plans 2 and 4) provides a slight suggestion that it might have continued beyond the currently known end of the L-shaped complex, while LiDAR (Pinchbeck 2013, 13 and Fig. 23 Feature A) shows the presence of a linear depression which could represent a moat (which must be presumed to have fronted the facade of the palace right round its south side) running for c. 120 m on the right approximate alignment (though slightly deviating from the line of the facade wall as established in the present work). This LiDAR feature would appear to continue the line of the inner moat excavated in 2014 and a sequence of demolition deposits found in an EAS test pit (Dearne 2006a, Pit 24) c. 8.00 m south of the south east corner of 2018 Trench 6 may well represent the filling

of that moat. If this feature does represent the line of the moat beyond this point though it would run a further c. 100 m before, less clearly, perhaps turning sharply to run north north east as a much narrower feature (Pinchbeck 2013, 13 and Fig. 23 Feature B), possibly to meet the moat believed to front the palace gatehouse approximately where the approach road to the palace met it (Fig. 15). One might then postulate that in Phase 2 the palace had been expanded considerably to the south along this line, creating an angled salient that then ran back to the gatehouse which is currently believed to belong in its inception to Phase 1. If so the south west range, of which the area excavated in 2014 – 2018 and the L-shaped complex appear to have been parts, could have overall run for as much as 105 m.

- Against this maybe the negative findings of scattered EAS test pits (Dearne 2006a, Pits 1, 2 and 10 – 12) in the area of the south eastern part of this putative moat which found only what appeared to be a fan of demolition material over the natural; but all the pits were small, some disturbed and subsequent experience has shown that the fill of moats on the site is very hard to differentiate from natural in small exposures. Larger scale excavation has also not occurred south east of the 2018 work more than c. 4.00 m south of the L-shaped complex (where a ?sump cut by a later ?channel could not be fully characterised and the latter could have been a post-palace feature; Dearne 2011a, [18] and [19]). However, excavation has failed to identify structural features for 3.00 m south east of the L-shaped complex (Dearne 2013) and an alternative hypothesis would be to postulate that the facade wall of the palace turned east to run parallel with the south east end of the L-shaped complex towards the gatehouse. Confirmation of which hypothesis is correct and so the course and extent of the south west range would therefore require new targeted excavation.
- In either case though it would now seem that in Phase 2/3, taking into account earlier excavations and remote sensing evidence (see Pinchbeck 2013), the inner court was trapezoidal in shape, presumably with an inner court leading off of it, probably via a monumental gateway, somewhere north of the building complex excavated from 2014 to 2018.
- As completed the part of the south west range excavated to date since 2014 seems most likely to have been basically trapezoidal but perhaps with the barn continuing further east on its north side than other elements of the complex did (Fig. 1). It was 17.00 m north south on the west, and about 22.00 m on the east and perhaps overall c. 22.00 m east west, but its eastern extent remains the real uncertainty in its plan and rooms 5 and 6 could have continued further east, or could have adjoined other rooms/structures making up more south eastern parts of the range.
- Clearly much of the internal structure of this part of the range was of timber on dwarf brick walls and its northern wall may have been quite insubstantial. It would be difficult (though not entirely impossible) to see (evidently open and on the east deeply sunken) drain [15] running through this part of the complex as opposed to along its outer edge and LiDAR evidence of a break of slope aligned with the drain (Fig. 15) strengthens the case for the drain marking a significant boundary within the wider site plan. The drain was probably carried up above its brick structure in timber and one cannot discount the possibility that what might have been a linear boxing in structure above its brick built elements formed the north wall of this part of the range. However, the likelihood seems to be that the north wall was perhaps formed of posts/brick columns on brick bases with timber screening between them.
- The west wall of the range (identified in 2017) also seems to have been at least far from monumental, though its southern wall was provided by the facade wall of the palace complex which was clearly a reasonably substantial brick construction even in Phase 2 and ultimately a significant weight bearing wall at least in places. It had an original and a later added projecting garderobe chutes and quite possibly an original projecting tower further east later replaced by a more elaborate multiangular tower and between these features it now seems apparent that the facade wall incorporated a dog leg (?to accommodate the tower). Finds evidence over several seasons (see Dearne 2014; 2015; 2016; 2017c and Appendix 3 herein) suggests that the facade wall incorporated greensand framed arched windows, glazed fenestration and cut/moulded brick plinths etc at least at some points and it was fronted by a double moat. However, the range behind it was probably of no great architectural pretension and probably largely timber framed even if there seems to be evidence for stone fireplaces somewhere within the building complex (see Appendix 3). Again though it is the nature of any eastern wall(s) to Rooms 5 and 6 that is/are unknown and one can only speculate from the nature of the demolition cut presumed to (?partly) represent it/them that it/they may have been more substantial

than e.g. the west wall of the building and conceivably had associated features such as fireplaces/ovens.

- One suspects that different areas of the range had discrete roofs, one covering the barn, one covering the western part of the building and perhaps even a third covering Rooms 4, 5, 6 and 8. Internally indeed it is now apparent that there was a rough north south division within this western end of the range, if formed only by three dwarf brick and timber walls which were on slightly different alignments and one of which would eventually be dispensed with (so it can hardly have been load bearing). On the west much of the area was occupied by Room 3, the most irregular space so far excavated, its dimensions varying from a little over 12.00 m to as much as 16.50 m north south and from a little under 12.00 m to 14.50 m east west. Its pebble and chalk floor does not suggest that it was a high status space nor probably that it was as heavily used as other brick floored areas, but there is nothing to specifically identify its function. The much smaller Room 2 to its south was though probably of higher status with its glazed brick/tile floor and it might be tempting to see this as used by more senior palace staff than the rest of the rooms in this area (?especially as a stair well opened on to it), even if little can be said of Room 1 next to it.
- On the east the area was more sub-divided. On the north the barn was almost certainly a large storage space and perhaps a main palace store for bulk commodities such as malt, grain, flour, salt, preserved meat etc. Further south though the (repeatedly replaced) brick floors of Rooms 5 and 6 suggest areas that saw considerable foot traffic and were sufficiently important to warrant not just (more easily cleaned) brick floors but ones that the trouble was taken to give reasonably elaborate patterning to. Room 4 seems to have also seen heavy wear to its floor, but it does not seem to have warranted such elaboration (so may perhaps have been another storeroom or perhaps just provided access to the projecting tower, but too little is known of its southern continuation (Room 8) – or indeed the tower that fronted it – to speculate on their function(s)).
- However, the southern part of Room 5 at least would appear to have (at least from Phase 3a onwards and not inconceivably from the range’s inception) been a boiling or brewing house or similar. The large furnace here is by far the strongest evidence that the ground floor of this part of the range as a whole formed part of the service areas of the palace and in part at least was probably connected to a large scale process that required a significant heat source. It is highly unlikely that the furnace formed an ‘open’ fire rather than having a metal receptacle built into the top of it so that the process for which it was used almost certainly involved the heating of significant amounts of water to at least a reasonably high temperature. Smaller scale activities necessitating hot water (washing up or laundry) can though probably be ruled out which would seem to leave two possible roles for the furnace.
- One would be brewing and specifically the heating of a copper or a mash tun. Documentary evidence confirms the presence of brewing vats at Elyng towards the end of Lovell’s life and regular large purchases of malt and hops (Dearne *et al* in prep.). The inventory of Elyng on his death in 1524 (National Archives PROB 2/199; see Dearne *et al* in prep.) for instance lists the brewhouse contents as including:

‘a gret bruing leede w[ith] the pan of coper...[and one]  
gret messhyng ton and [two] other tonnes and [two] litill kelters’

Whilst it lists the brewhouse with the bakehouse after servants quarters outside the moat so that it is possible that these buildings lay outside the main palace complex this is far from certain and that Room 5 (?and Room 6) constituted the brewhouse must be a possibility. However, one might expect more than one copper/mash tun setting to be present as in the monastic brewery at Castle Acre, Norfolk (Wilcox 2002, 28ff).

- The other possible role the furnace might have played though would have been in food preparation. The accounts for the Office of the King’s Works in 1541 (Bodleian MS Rawlins D781, ff 188 – 195v; see Dearne *et al* in prep.) include references to the making of a cover for the boiling house lead and hanging a new door in the scalding house at Elyng. Thus there was both a scalding house where e.g. boar would have been scalded in a vat of boiling water to help remove their bristles before cooking and a boiling house where large joints of meat or even whole carcasses would have been boiled (probably often before roasting) and stocks made (e.g. Thurley 1993, 154 and Fig. 197).
- Unfortunately there is little to indicate the function of the more northerly part of Room 5 and of Room 6 which might help in deciding between these possible interpretations of the furnace. It is though tempting to suggest that the whole of the south eastern section of the ground floor of the area

excavated at least comprised either kitchens or the brewhouse (perhaps with ovens etc or brewing vats against any lost east wall). If kitchens, it would be unlikely that these were privy kitchens given their location, but they might well have been kitchens serving the wider palace staff/royal entourage and the existence of a major drain at the northern boundary of the building would be entirely consistent with the area being connected to either food preparation or brewing.

- Taking into account finds evidence though the balance of probabilities may be on the side of this part of the range having a kitchen function. Finds from 2014 to 2018 indicate a contrast between the more westerly rooms excavated, where ceramic vessels (principally flagons/drinking vessels) and animal bone were far less common, and the greater amounts of pottery and animal bone from the excavation of the more easterly rooms. This may suggest that there was a functional differentiation within the range between Rooms 5 and 6 and Rooms 1 – 3, with the latter having less specifically definable roles. But the implication of much of the finds evidence recovered in 2017 and 2018 from Rooms 5 and 6 is most probably for their involvement in food preparation.
- Much of the finds evidence from the eastern part of the building complex has come from demolition dumps, and specifically from the fills of cut [41] which are suspected to have included redeposited midden material, but it seems unlikely that the ultimate source of this material lay at a great distance from the cut being filled and so was most probably generated by activities in the eastern part of the area excavated in 2014 – 18 (or unexcavated areas further east). If so the character of the finds from these deposits would be consistent with the preparation of food. Whilst they included numbers of e.g. FREC and PMRE/PMR flagons, drinking mugs and glass wine goblets etc and also moderate numbers of e.g. chamber pots, they were dominated by PMRE/PMR and PMR (and a reasonable number of BORD) vessels such as pipkins/cauldrons, large bowls and pancheons which suggest (bulk) food preparation activities. Moreover, high levels of butchered animal bone were present in all the rubble fills of cut [41] and suggest both primary butchery and secondary processing to extract marrow bone in the vicinity. The similar profile of finds from [1](?Reworked Deposit on [32]) in 2018 moreover helps to suggest that the same types of material were being dumped not just in cut [41] but more generally in Room 6 during demolition.
- No evidence of course though bears on the use to which the second storey of this west end of the south west range of the palace was put. One suspects that it may have been residential in nature (not least because the presence of the furnace and any other ovens etc would make it one of the warmer parts of the palace complex at least if they were in operation) and the doubling of the garderobe provision at some date might hint in the same direction.
- Beyond the presumption that Phase 2 represents the original construction of the range by Sir Thomas Lovell though there is little to indicate the absolute date of the various modifications to the excavated sections of it, even if the tentative sub-division of Phase 3 is accepted. It is very tempting to assign Phase 3a to sometime after 1539 when Henry VIII acquired the palace and to see the insertion of the furnace in Room 5 as indicating a step change in the scale of food preparation that might be occurring or was anticipated to be required. But there is no documentary evidence to support such an equation<sup>16</sup> and Lovell (and maybe his heir the Earl of Rutland) probably developed the palace over some decades so that one of them could easily have been responsible for this change, perhaps at the point when royal visits to Elsyng began to be expected or became more frequent (if indeed the furnace etc was inserted in Phase 3a and was not part of the original Phase 2 scheme) and this will be discussed further in Dearne *et al* in prep.
- However, it does seem likely that the structural changes allocated to Phase 3b will have happened no later than the 1570s/1580s when Queen Elizabeth can be shown to have ceased to use Elsyng to any great degree (Dearne *et al* in prep.) and maybe considerably before that (again not inconceivably before Elsyng became a royal palace as it remains far from certain at least that these were changes introduced in Phase 3b not 3a and possible even that the structural ‘changes’ were in fact parts of the original Phase 2 build). Certainly though the impression of the activity in Phases 3c and 3d seems inconsistent with a well maintained royal residence and one suspects that they belong to the late sixteenth and or seventeenth centuries when the palace ceased to be used by Elizabeth, was used by James I only for a few years, became for a time one of the homes of the Earl of Montgomery and eventually was sold to him by the crown (see further Dearne *et al* in prep.). Indeed the two items of

---

<sup>16</sup> Documentary research for Dearne *et al* in prep. is, however, ongoing at this date so it remains possible that it may eventually shed further light on the archaeological findings.

dating evidence for any part of Phase 3 indicates that the accumulation of fuel residues from the furnace (arbitrarily placed in Phase 3d) post dated c. 1580.

- The demolition of the palace is presumed to have occurred c. 1657. Certainly the dating evidence accumulated over many years from the demolition rubble would be consistent with this and includes nothing that need date significantly later than this (in 2018 it included clay pipes of 1640 - 60 and TGW vessels of, or which would be at home in, the second half of the seventeenth century (see Appendix 3)). It was clearly systematic and nothing in the present work questions the previously gained impression that salvageable materials were removed wherever possible, even if in Room 5 the scale of demolition probably meant that just a few complete bricks and tiles were in this instance missed or ignored. Never the less, demolition clearly only targeted structures which needed to be reduced to ground level and floors and dwarf walls were left in tact. It remains possible that certain areas of the site were demolished later than others in what might well have been a protracted process and in this connection the barn (Room 7) might well be a candidate. However, whether the palace site was simply then landscaped often using dumps of pebbles or whether paths and other surfaces were deliberately created across the site in Phase 5 remains ambiguous.
- If the intention was to use the site for recreational purposes after palace demolition any such surfaces and paths would have presented a barrier to the regrowth of grass and so one might presume that the intention had been to create a network of paths and hard standings for promenading through what were now the grounds of Forty Hall. However, to date they do not appear to form any regular pattern even if some palace phase pebble surfaces – like floor [6] – had been retained as well. It may well be that the dumping of pebbly deposits facilitated the landscaping process as they could easily be rammed to a flat surface, and perhaps that the material deposited was dictated as much by what was available in the way of infill locally (?from gravel workings) as by the intended use which Nicholas Rainton had for the former palace site. But as yet the interpretation of these ?surfaces must remain uncertain.

### CONSERVATION AND RESEARCH IMPLICATIONS

- As was already apparent in 2016 and 2017, this area of the palace clearly survives largely in tact (excepting on the east of Rooms 5 and 6) to the top of its dwarf internal partition walls with very large areas of flooring *in situ* and so represents a significant archaeological resource (augmented by the information about the building to be derived from demolition deposits overlaying it). The virtually complete survival of the sunken furnace in Room 5, together with associated features and floor surfaces, in particular emphasises the unusual degree of preservation of at least this section of a building complex that has the potential to illuminate not just the royal palace culture of the Tudor period but also the phenomenon of early Tudor ‘courtiers’ palaces’.
- In general surfaces and walls survive below a layer of demolition rubble which provides some protection for them, however, in some instances floor surfaces such as [32] lay simply below as little as 0.22 m of topsoil, the topsoil itself in places probably representing worm and root reworked archaeological deposits. The potential for damage to the archaeological resource is though greatest in regard to [62]/[86], the multiangular tower projecting from the facade wall of the palace, and probably some of the walls of the barn. In the former case extensive deturfing was undertaken in large part because of significant concerns about the stability of the remains given that the demolished walls of the tower lay directly below the turf immediately next to major tree 0834. Whilst some parts of these walls were probably relatively stable, in the case of wall [86] it has very likely been severely impacted by the repeated passing of motorised mowers where the wall was coincident with a mown footpath (Pl. 14). Similarly, the south wall of the barn, [8], showed considerable deterioration only where it lay within a regularly mown area of the site.
- It is therefore vital that no ground disturbance is allowed without full archaeological monitoring/prior excavation across the entire area excavated between 2014 and 2018. Additionally though management practices should continue to seek to minimise the weight and frequency of motorised mower use to prevent further damage to what are now clearly such shallowly buried remains that the passage of any mechanised vehicles will cause further deterioration of the archaeological resource.
- Conservationally though the principal issue with regard to preserving this resource in most of the area examined in 2017 and 2018 is that of tree root/throw/planting disturbances. Whereas such issues currently pose a quite limited or no threat to the integrity of some structures and stratigraphic sequences in the areas examined, tree root ingress in 2018 was found to be even more significant than

in 2017. Thus, parts of the damage to the cheeks of the furnace was clearly being worsened by the ingress of major tree roots (Pls 10 and 13), much of the western part of Room 5 was if not disrupted then in danger of being disrupted by major tree roots (Pl. 11) and at one point wall [62] had been cracked apart and moved by tree root heave. Again, even just deturfing showed that the westernmost exposure of wall [76] has probably already been irretrievably disrupted. As emphasised by the findings in Trench 8 (and FXO17 Trench 1) especially, repeated tree throw/planting has already rendered some areas archaeologically useless and no new tree planting or sapling seeding should be allowed in this area under any circumstances. Indeed, it is to be greatly regretted that tree planting was allowed in ENC05 Pit 23 (tree 0833) some years ago and the immature tree now occupying this position may well in due course pose a threat to the survival of features such as the Room 5 furnace.

- Much of the current damage and potential for damage to Room 5 and the projecting tower though relates to tree 0834 which is in large part now dead but with a remnant of its trunk still alive and some parts of its massive root system still active and it is strongly recommended that this tree is entirely removed under archaeological supervision and not replaced. It might well indeed be appropriate for this removal to be undertaken in tandem with an archaeological excavation to preserve by record the probably significant structural archaeology which this tree has almost certainly impacted in Room 8 and which might be further destabilised by the removal process and or subsequent decay of the tree root system.
- In terms of research priorities it is likely that, except in Room 8, further archaeological excavation within the area under study between 2014 and 2018 would not significantly advance our understanding of it. Whilst a few details such as the nature of the junction of walls [46] and FXL16 [13] remain unknown they are unlikely to alter the overall picture of the development and function of this part of the south western range and the research priorities for the site should now be framed in terms of establishing how the excavated areas fitted into the wider range. This would suggest that research should proceed by investigations focused on areas south east of the present work and south of the previously excavated L- shaped complex, including locating the continuation of the facade wall of the palace and recovering the plan of the rooms which likely lay immediately behind it.

#### **ACKNOWLEDGEMENTS**

- The author and the EAS are grateful to the London Borough of Enfield Leisure Services and Parks Departments, and especially Hatice Abdullah and Danny Byrne, for commissioning and facilitating the work; to the Dept. of Culture Media and Sport for granting Ancient Monument Consent; and to their advisors, Historic England, and especially Dr. Jane Sidell and Iain Bright for their support. Thanks are also due to the Forty Hall staff who ran a programme of schools events, which was delivered for the EAS by Neil and John Pinchbeck and Judith Stones, to coincide with the work and co-organised a public outreach event coincident with it.
- The author is grateful to all the members of the EAS who constituted the excavation team, especially Mike Dewbrey and Neil and John Pinchbeck; to Neil Pinchbeck for his specialist reports on the animal bone and struck lithics; and to Ian K. Jones for reporting on the worked stone and aspects of the pottery assemblage.

## BIBLIOGRAPHY (including for appendices)

- Atkinson, C. and Oswald, A. (1969) 'London Clay Tobacco Pipes', *JBA* 32, 171 – 227.
- Bartlett, A. D. H. (1998) *Site of Elsyng Palace, London Borough of Enfield Report on Archaeogeophysical Survey 1998* Unpublished Report, Bartlett-Clark Consultancy.
- Black, D. and Black, A. (2004) *Geophysical Survey Site of Elsyng Palace Forty Hall Park, London Borough of Enfield* Unpublished Colchester Archaeological Group Report.
- Butler, J. (2006) *Reclaiming the Marsh. Archaeological Excavations at Moor House, City of London* (Pre-Construct Archaeology Monograph 6).
- Courtney, P. (2004) 'Small finds' in K. Rodwell and R. Bell *Acton Court. The Evolution of an Early Tudor Courtier's House*, pp 365 – 396.
- Dearne, M. J. (2004) *Archaeological Test Pits on the Site of Elsyng Palace, Forty Hall, Enfield, July 2004* Unpublished Enfield Archaeological Society Archive Report.
- Dearne, M. J. (2005a) *Archaeological Test Pit, Resistivity and Magnetometry Survey on the Site of Elsyng Palace, Forty Hall, Enfield, June/July 2005* Unpublished Enfield Archaeological Society Archive Report.
- Dearne, M. J. (2005b) *Archaeological Test Pit and Resistivity Survey on the Site of a Suspected Structure Ancillary to Elsyng Palace, Forty Hall, Enfield, April 2005* Unpublished Enfield Archaeological Society Archive Report.
- Dearne, M. J. (2006a) *Mitigation of Unauthorised Tree Planting on the Site of Elsyng Palace, Forty Hall, Enfield, December 2005 - June 2006* Unpublished Enfield Archaeological Society Archive Report.
- Dearne, M. J. (2006b) *Excavation of Evaluation Pits to Inform an Application to Plant Trees on the Site of Elsyng Palace, Forty Hall, Enfield, September – November 2006* Unpublished Enfield Archaeological Society Archive Report.
- Dearne, M. J. (2007) *Excavations to Further Inform an Application to Plant Trees on the Site of Elsyng Palace, Forty Hall, Enfield, July - September 2007* Unpublished Enfield Archaeological Society Archive Report.
- Dearne, M. J. (2008) *Excavations on the Site of Elsyng Palace, Forty Hall, Enfield, July 2008* Unpublished Enfield Archaeological Society Archive Report.
- Dearne, M. J. (2009) *Excavation and Parch Mark Recording on the Site of Elsyng Palace, Forty Hall, Enfield, July 2009* Unpublished Enfield Archaeological Society Archive Report.
- Dearne, M. J. (2011a) *Excavation and Parch Mark Recording on the Site of Elsyng Palace, Forty Hall, Enfield, July 2010* Unpublished Enfield Archaeological Society Archive Report.
- Dearne, M. J. (2011b) *Excavation on the Site of Elsyng Palace, Forty Hall, Enfield, July 2011* Unpublished Enfield Archaeological Society Archive Report.
- Dearne, M. J. (2012a) *Excavation of a Seventeenth Century L-Shaped ?Threshing Barn on the Site of Elsyng Palace, Forty Hall, Enfield, July 2012* Unpublished Enfield Archaeological Society Archive Report.
- Dearne, M. J. (2012b) *Excavations and Watching Briefs at Forty Hall, Forty Hill, Enfield, May 2009 to August 2011*, Unpublished Enfield Archaeological Society Archive Report.
- Dearne, M. J. (2013) *Further Excavation of a Seventeenth Century L-Shaped Threshing Barn on the Site of Elsyng Palace, Forty Hall, Enfield, July 2013*, Unpublished Enfield Archaeological Society Archive Report.
- Dearne, M. J. (2014) *A Section Across the Southern Perimeter of Elsyng Palace, Forty Hall, Enfield, July 2014*, Unpublished Enfield Archaeological Society Archive Report.
- Dearne, M. J. (2015) *Excavations at Elsyng Palace, Forty Hall, Enfield, July 2015*, Unpublished Enfield Archaeological Society Archive Report.
- Dearne, M. J. (2016) *Excavations at Elsyng Palace, Forty Hall, Enfield, July 2016*, Unpublished Enfield Archaeological Society Archive Report.
- Dearne, M. J. (2017a) *Monitoring of Hedge Planting at the Boundary of the Elsyng Palace SAM, Forty Hall, Enfield, January - February 2017*, Unpublished Enfield Archaeological Society Archive Report.
- Dearne, M. J. (2017b) *Monitoring of Heritage/Ecology Trail Information Board Installation on the Elsyng Palace SAM, Forty Hall, Enfield, July 2017*, Unpublished Enfield Archaeological Society Archive Report.



- Dearne, M. J. (2017c) *Excavations at Elsyng Palace, Forty Hall, Enfield, July 2017*, Unpublished Enfield Archaeological Society Archive Report.
- Dearne, M. J. *et al* (in prep.) *Monarchs, Courtiers and Technocrats; Elsyng Palace, Enfield: Place and People. The Documentary and Archaeological Evidence for a Fifteenth to Seventeenth Century Courtier's House and Tudor and Stewart Royal Palace; and for the Lives of its Owners and Households*.
- Dearne, M. J. and Pinchbeck, N. (2013) *Watching Brief on a Greenway Cycle Track Close to the Site of Elsyng Palace, Forty Hall, Enfield, September 2012 – January 2013* Unpublished Enfield Archaeological Society Archive Report.
- Dearne, M. J. and Pinchbeck, N. (2015) *Excavations and Watching Briefs at Forty Hall, Forty Hill, Enfield, July 2013 to April 2015* Unpublished Enfield Archaeological Society Archive Report.
- Dearne, M. J. and Pinchbeck, N. (2018) *Monitoring of Pond Desilting; and Test Pits and Monitoring on the Site of a New Rain Garden (Elsyng Palace SAM, Forty Hall, Enfield) February - May 2018* Unpublished Enfield Archaeological Society Archive Report.
- Egan, G. (2005) *Material Culture in London in an Age of Transition* (MoLAS Monograph 19).
- Gillam, G. (1997) *Forty Hall, Enfield* Enfield Archaeological Society.
- Green, J. (1989) *The Retourschip Batavia Wrecked Western Australia, 1629* (BAR Int. Series No. 489).
- Hildyard, R. J. C. (2005) 'Stoneware' in M. Biddle *Nonsuch Palace. The Material Culture of a Noble Restoration Household*, pp 99 – 119.
- Horsley, T. J. (1997) *Elsyng Palace, London Report on Geophysical Survey, July 1997* Unpublished Report, Ancient Monuments Laboratory.
- Jones, I. K. and Drayton, I. (1984) *The Royal Palaces of Enfield* Enfield Archaeological Society Research Report No. 4.
- Pearce, J. (1992) *Post-Medieval Pottery in London, 1500 – 1700 Vol. 1 Border Wares*.
- Phillipotts, C. (2002) *Elsyng Palace, Forty Hill, Enfield. The Scheduled Ancient Monument and its Setting. Archaeological Desk-Based Study*. Unpublished Compass Archaeology Report for the London Borough of Enfield.
- Pinchbeck, J. (2013) *Elsyng Palace: Remote Sensing and Geographic Information Study* Unpublished Enfield Archaeological Society Archive Report.
- Pinchbeck, N. with Dearne, M. J. (2010) *Survey and Limited Excavation of an Eighteenth Century Ornamental Cascade System Forming Part of Maidens (Turkey) Brook, Forty Hall Estate, Enfield, 2008 – 2010; and Sample Excavation of an Associated Reservoir (and Drain Relating to Elsyng Palace), June 2010* Unpublished Enfield Archaeological Society Archive Report.
- Thurley, S. (1993) *The Royal Palaces of Tudor England. Architecture and Court Life 1460 – 1547*.
- Wilcox, R. (2002) Excavation of a Monastic Grain-Processing Complex at Castle Acre Priory, Norfolk, 1977 – 82, *Norfolk Arch.* 44i, 15 – 58.
- Willmott, H. (2001) *Early Post-Medieval Vessel Glass in England c. 1500 – 1670*.

## APPENDIX 1: ARCHIVE NOTE

- The archive for FXQ18 is held at the London Borough of Enfield Museums Service/EAS archive and includes:
- project design; ancient monument consent letter of grant; inked copies of all plans and sections; context register and original context sheets; section and plan registers; photographic image register; samples register; digital image archive; site diary; levels register; finds report; this report; and the retained finds and samples.

## APPENDIX 2: CONTEXT INDEX AND SITE MATRICES

Context	Type	Description	Context	Type	Description
1	Layer	Topsoil	50	Layer	?Path
2	Layer	Landscaping	51	Feature	Flue Cheek
3	Cut	?Construction	52	Feature	Furnace
4	Layer	Natural	53	Feature	Wall
5	Feature	Wall	54	Feature	Wall
6	Feature	Floor	55	Feature	Floor
7	Layer	Demolition	56	Feature	Floor
8	Feature	Wall	57	Feature	Floor
9	Layer	Demolition	58	Layer	Floor Bedding
10	Feature	Floor	59	Feature	Wall
11	Feature	Land Drain	60	Feature	Floor
12	Feature	Floor Bedding	61	Feature	'Cupboard'
13	Layer	Backfill	62	Feature	Tower
14	Feature	Floor Bedding	63	Fill	Of 41
15	Feature	Drain	64	Layer	Demolition
16	?Feature	?Surface	65	Layer	Fuel Ash
17	Layer	Demolition	66	Feature	Wall
18	Feature	Floor	67	Cut	Demolition
19	Feature	Floor	68	Layer	Fuel Ash
20	Layer	Demolition	69	Fill	To ?Wall Void
21	Fill	Of 15	70	Feature	Floor
22	Layer	Natural	71	Layer	Floor Bedding
23	Feature	Wall	72	Cut	Planting Pit
24	Feature	Surface	73 and 73A	Feature	Floor
25	Layer	Demolition	74	Fill	To ?Wall Void
26	Layer	?Surface	75	Layer	Floor Bedding
27	Layer	Surface	76	Feature	Wall
28	Layer	?Surface	77	Cut	Ash Pit
29	Layer	Natural	78	Feature	Part of Wall
30	Fill	Of 31	79	Feature	Floor
31	Cut	?Construction	80	Feature	Part of Wall
32	Feature	Floor	81	Feature	Wall
33	Layer	Demolition	82	Feature	Wall
34	Fill	Of 41	83	Feature	Flue Cheek
35	Feature	Floor	84	Feature	Flue Cheek
36	Fill	Of 41	85	Feature	?Wall
37	Layer	Demolition	86	Feature	(Part of) Tower 62
38	Layer	Floor Bedding	87	Layer/Fill	?Of Construction Cut
39	Layer	Floor Bedding			
40	Feature	Floor			
41	Cut	Demolition			
42	Feature	Wall			
43	Feature	Flue Cheek			
44		Subsumed in Other Numbers			
45	Feature	Wall			
46	Feature	Wall			
47	Feature	Floor			
48	Layer	Floor Bedding			
49	Feature	Land Drain			

TRENCHES 1, 3, 4, 5 MATRIX

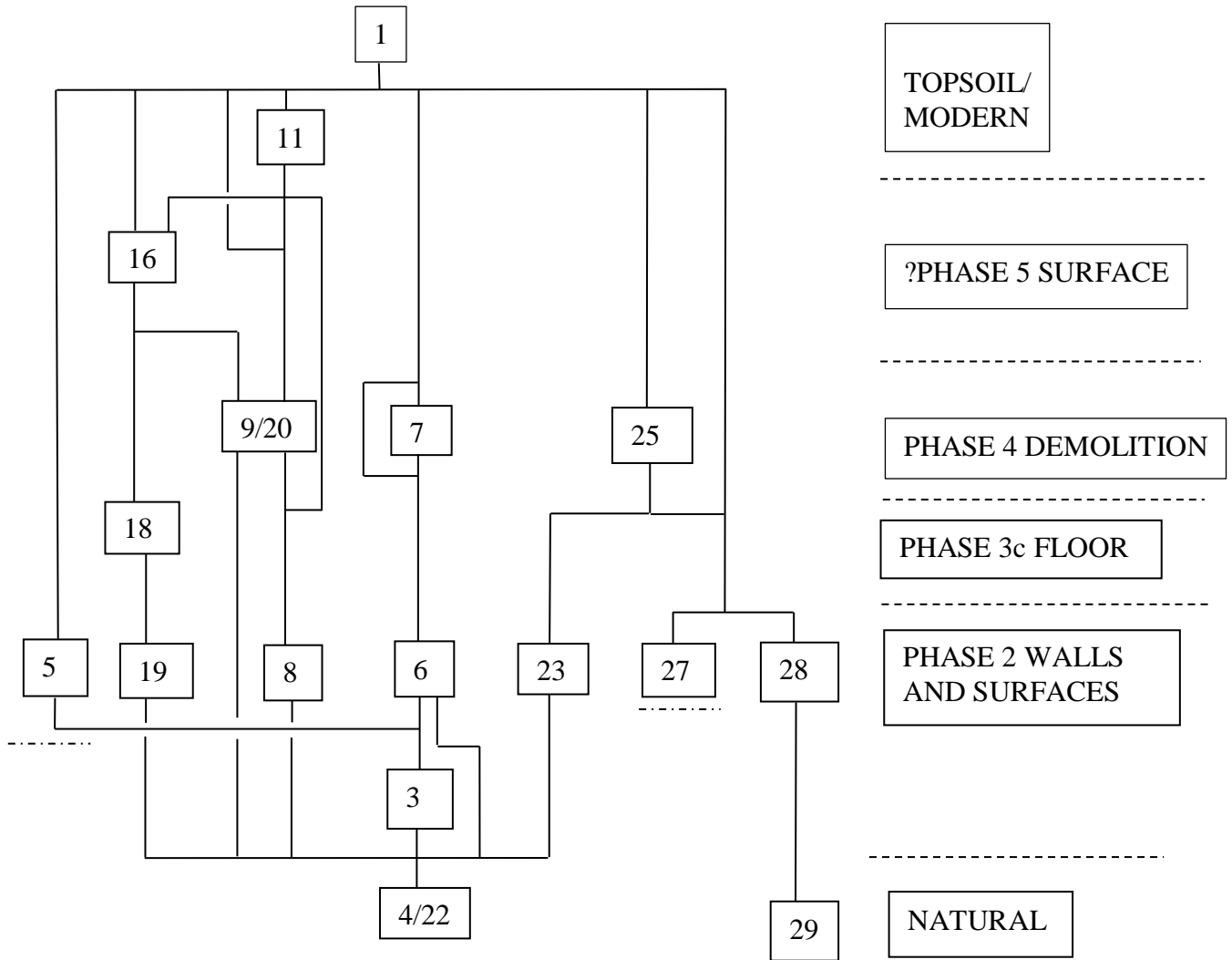

TRENCH 2 MATRIX

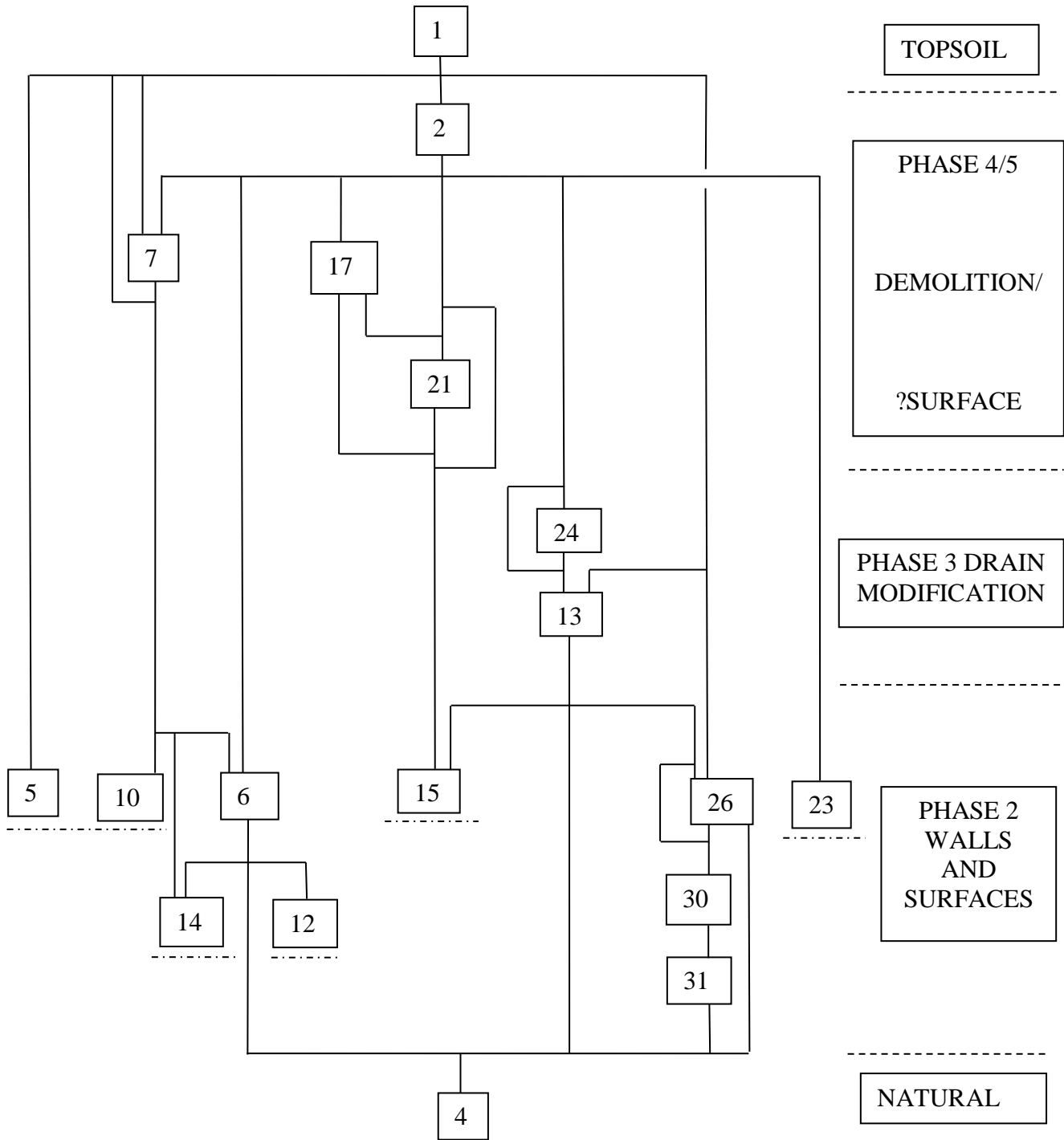

SLIGHTLY SIMPLIFIED TRENCH 6 MATRIX

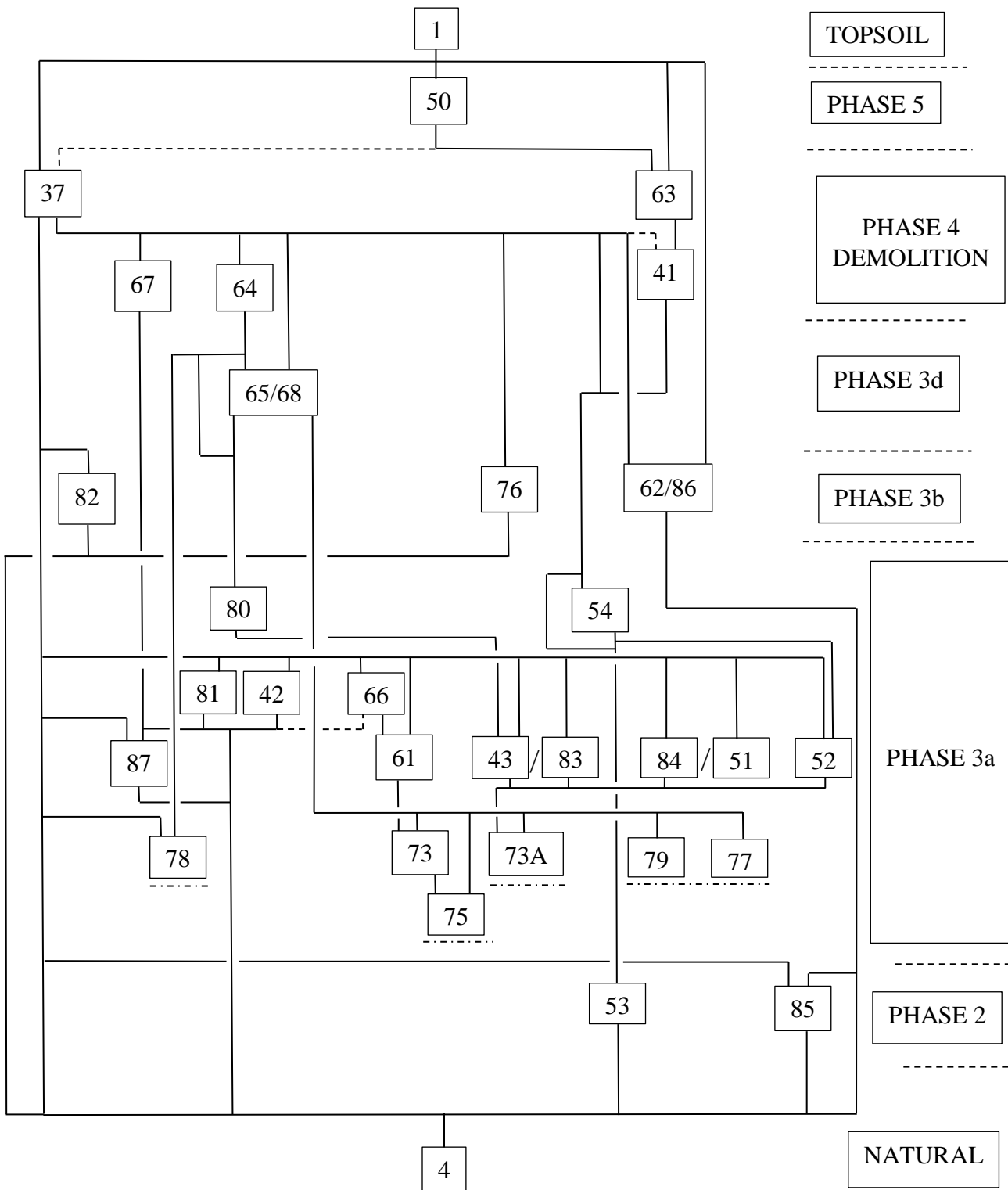

TRENCH 7 MATRIX

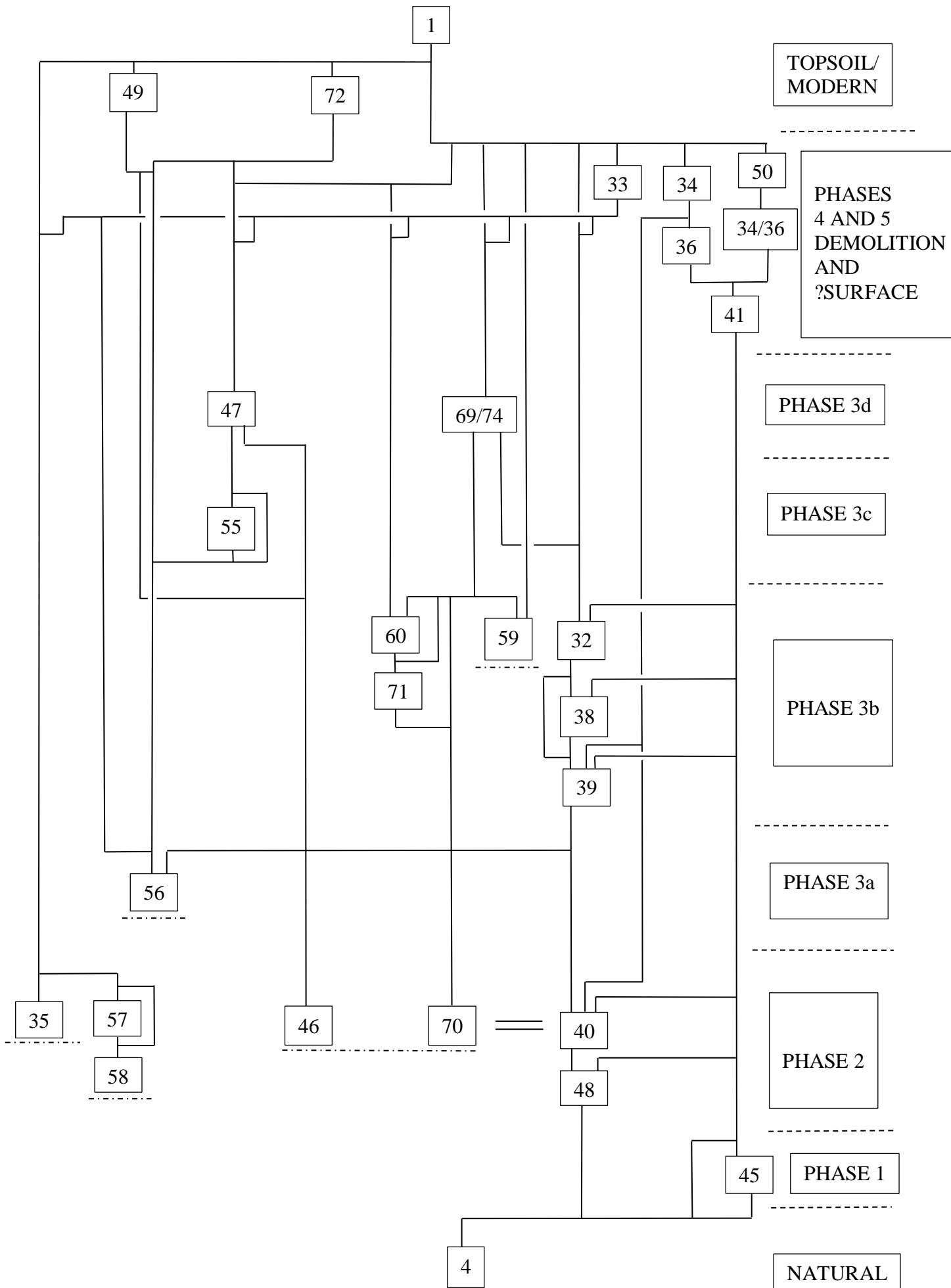

## APPENDIX 3: FINDS SUMMARY

### (MJD with contributions by Ian K. Jones and Neil Pinchbeck)

- The following summarises the main points of a fuller report available in the site archive. \* denotes an item illustrated on Figs 16 - 17 or on specified plates. Contexts appear at the end of catalogue entries thus: [35] with any small find number.

#### 1 Coins and Tokens

##### 1.1 Elizabeth I AR Halfgroat (Hammered Coinage) 1584 – 1586

Obv. Bust l. with two pellets behind and beaded divider EL[IZABETH] E.D.G. ROSA

Rev. Arms of England bisected by long cross CIVIT[AS LON]DON *mm* escallope

Moderately worn

[U/S]

##### 1.2 Charles I AE Rose Farthing

Obv. Double arched crown D.G.[MAG.BRIT.CAROLVS]

Rev. ?Double Rose REX.FRA.ET.HIB

[U/S]

- Other [U/S] or [1] coins were nineteenth or twentieth century in date.

#### 2 Silver Objects

2.1 Scale (L. 5.80; W. 4.10; Th. 0.10 mm). Teardrop shaped. 1.50 mm diameter circular hole punched through the smaller end. Probably for sewing to clothing. [1](?Reworked Deposit on [32])

2.2 Back of heart shaped ?locket (1.68 x 1.70 cm). Reserved exterior surface and four ivy leaves on connecting cross strips applied to interior face. Hallmarked Chester 1912. [1]

#### 3 Copper Alloy Objects

- A number of C18<sup>th</sup>/C19<sup>th</sup> and in some cases C19<sup>th</sup>/C20<sup>th</sup> objects such as buttons and costume jewellery fragments were from [1]/[U/S] as was the undateable possible fragment of a punch and a mount or sheathing. Lace tags, one retaining a lace, came from [2], [21] (2) and [34]/[36] (2) and there was a possible nail shank from [21]. Other items comprised:

\*3.1 Vessel fragment (L. 8.93; W. 1.68; Ht. 1.33; Th. 0.15 cm). From base/lower wall of a probable skillet with slightly flaring wall. Probably with upper wall cut away. [21] SF6

\*3.2 Vessel fragments (3). Thick (0.60 cm) walled, flat based vessel (probably a mortar) with a pointed thickened rim and a slight foot ring. Interior scarred and polished. Date uncertain. [1]

3.3 Knife/dagger pommel (or stud) (Di. c. 2.00; Ht. 0.70 cm). Hollow domed form decorated with cast ?rose, ?pierced by central raised tinned/silvered ?stud, and stylised foliage on punch textured ground. Weight suggesting a high lead alloy. ?C18<sup>th</sup>. [1]

3.4 Stud cap (Ht. 0.75; Di. 1.63 cm). Distorted, ragged and now in two pieces. Flat topped, cylindrical cap of sheet (Th. 0.05 cm) with slight edge bead. [68] SF25

3.5 Dress pin (L. 2.65 cm). Wound wire head clenched into a hemisphere with a pair of punches (Caple's Type C (see e.g. Courtney 2004, 396)). [21]

#### 4 Lead Objects

- Small Solidified masses came from [9] and [25], but most were [U/S], as were two pistol/musket balls, three ?modern weights and one or two other minor items. Other material comprised:

\*4.1 (Pl. 15) Window came fragment. 10.00 cm long came (W. 0.735 cm) with two further comes (longest surviving 4.90 cm) crossing it at an angle 8.50 cm apart, all now distorted and crushed. Web (W. 0.26; overall Th. 0.50) rouletted. [65] SF24

4.2 Ditto (L. 3.10 cm). Right angled junction at one end, bent into semi-circle. Unrouletted web (W. 0.324 cm). [2]

4.3 Ditto (straightened L. 10.30 cm). Folded. Unrouletted web (W. 0.324; Depth 0.256 cm). [2]

4.4 Ditto (straightened L. c. 7.90 cm). Unrouletted web. Bent and crushed. [36]

4.5 Ditto (L. 2.46 cm). Twisted. [36]

4.6 Ditto (L. 3.50 cm). Crushed. [65]/[68]

4.7 Offcut (L. 2.40 cm). [9]

4.25 Token/cloth seal (Di. c. 2.00; Th. 0.20 cm). Flat back. Poorly preserved ?wheel design on face. [1]

\*4.26 Cloth seal (Di. 2.63; Th. 0.13 cm). One of two attachment lugs surviving on back. Front with ?partial impression of design with beaded border including basal ?tree bough with leaves and gothic M. Impression of fairly coarsely woven cloth to back. [2]

4.27 Ditto (Di. 2.17; Th. 0.14 cm). Button ended lug to back. Front with milled margin, quartered with incised cross; quadrants each with a raised letter and rosette giving EBRS. [U/S]

## 5 Iron Objects

- There were relatively small stratified groups of often fairly heavily corroded and concreted, in some cases bent/fragmentary nails; where assessable they had square/rectangular sectioned shanks with square and sub-square heads and were up to 10.00 cm long. Other than a larger number [U/S] or from [1] there was a small concentration in [2] and groups from demolition deposits [34], [34]/[36] and [37]. Smaller numbers came from [9], [30], [65]/[68], [7], ?[17], [20] and [21]. Bar/large nail shank fragments came from [2] and [21].
- Several relatively modern items such as the head of a tap came from [1] or were [U/S]. Other material comprised:
  - \*5.1 ?Terminal looped strap end (L. 5.60; Max. W. 1.28; Th. c. 0.38 cm). Probably parallel sided with terminal narrowing to a back curving loop. Very heavily corroded and concreted in two pieces (the illustration is a reconstruction with concretion removed). Cf. Egan (2005, 41). [21]
  - 5.2 Belt buckle (4.50 x 4.60 cm). D-shaped. Probably c. 0.50 x 0.50 cm section. Concreted. [2]
  - 5.3 ?Buckle loop (L. 5.45; W. 3.00; bar Di. 0.85 cm). Probably a distorted and broken narrow D-shaped buckle loop of circular sectioned bar. Undatable. [1]
  - 5.4 Blakey (L. 2.00; W. 1.00; Th. 0.10 cm). Oval. Stubs of two attachment spikes on underside. [34]
  - \*5.5 Key handle (L. 7.75; Max. W. 3.32 cm). ?Square sectioned shank and oval bow, probably with kidney-shaped aperture. [37] SF21
  - 5.4 Ring (Int. Di. 1.42 cm). Circular (Di. 0.36 cm) section. Concretion at one point on circumference. [2]
  - 5.5 Ditto (Ext. Di. 1.50 cm). Circular section. Fairly corroded. [34]
  - 5.6 Knife (L. 7.68; tang W. 1.30; tang Th. 0.24; surviving blade W. 2.10 cm). Straight back on line of scale tang, much of blade lost. [1]
  - 5.7 Knife/cleaver scale tang (L. 7.10; W. c. 3.10 cm). Pierced by at least one Fe rivet. [9]
  - 5.8 Ditto fragment (L. 6.10 cm). [U/S]
  - 5.9 Knife blade fragment (L. 3.80; W. 2.80 cm). [9]
  - 5.10 ?Ditto (3.20 x 2.70 cm). [2]
  - \*5.11 Drop hinge staple (L. 4.27; Max. W. 3.17; Ht. 1.43; Th. 0.58 cm). Tips of legs lost. [1] SF12
  - \*5.12 Staple (L. 9.85; W. 6.57; Th. c. 1.00 cm). Complete. Rectangular sectioned tapering legs and rectangular sectioned cross piece. [25] SF8
  - 5.13 Joiner's dog (L. 7.30 cm). Distorted, badly concreted, ? c. 0.50 x 0.50 cm bar section. [9]
  - 5.14 – 5.15 Ditto (longest L. 4.20 cm). Incomplete. Bent. [1]
  - 5.16 Ditto (L. 3.20; bar 0.37 x 0.37 cm). Incomplete horizontal bar with complete short (1.77 cm) leg, steeply tapered on the inner face to a point, at right angles. [34]
  - 5.17 Ditto (L. 4.40; bar c. 0.60 x 0.60 cm). Very similar but leg L. 2.60 cm. [37]
  - 5.18 Ditto (L. 4.20; bar c. 0.50 x 0.50 cm). Identical. [U/S]
  - 5.19 T-shaped holdfast (L. 5.40). Rectangular (1.50 x 8.40 cm) sectioned shank, probably with 4.50 cm + long, 1.30 cm wide curved head. Date uncertain. [1]/[50]/[63]
  - 5.20 Fitting fragment (L. 5.40 cm). ?Horizontal bar with now at least curved arm projecting part way along it. [34]
  - 5.21 ??Hook tip (or bent nail) (L. 2.89 cm). [65]/[68]

## 6 Worked Organic Materials

- \*6.1 Pendant (L. 5.22; Max. W. 1.14; Max. Th. 0.56 cm). Knife cut and filed tapering bone pendant with one curved edge, probably imitating a boar's tusk. Broken point, but retaining short length of 0.085 cm Di. Ae wire through a small drilled hole near centre. Wear polished. [2] SF5
- \*6.2 Bone bead (max. Di. 1.75; L. 1.64 cm). Crudely carved from the head of an ovicaprid sized ?femur into a roughly oval bead with an irregular piercing. Undatable. [1]
- 6.3 Unidentified object (L. 9.05; Max. W. 3.13; Max. Th. 0.70 cm). Thin (0.11 cm) (now) triangular sheet curving out from one side of a ?hollow triangular sectioned 'tube'. ?Horn. ?Lantern element. [37](crushed mortar at base of deposit)

## 7 Pottery (by fabric)

- Approximately 520 sherds over 1 x 1 cm were recovered (including seven unidentified). Significant groups came particularly from Phase 4 deposits filling cut [41], but much material was in topsoil, [1] including [1](?Reworked Deposit on [32]), and, as post-seventeenth century material was almost absent, likely emphasises the degree to which Phase 4 deposits had been root and worm reworked to form topsoil.



- A single small body sherd of South Hertfordshire Greyware (SHER; c. 1170 – 1350) was [U/S] and there was a body sherd from [37] with a reduced core and oxidised surfaces in a coarse sandy fabric with much large white, brown and grey quartz and ?int. brown glaze which might also have derived from the S. Herts. tradition.
- As in 2017 there were a possibly surprising number of sherds from **Frechen Bartmann Ware** (FREC; imported c. 1550 – 1700) jugs/flagons with face masks and medallions. Whilst many FREC vessels carried such decoration the almost complete absence of decorated sherds in areas to the west excavated in 2014 – 2017 is notable. The distribution may have no significance, but the possibility that more decorative tablewares were preferentially used/stored in the east of the Phase 2/3 building complex under excavation might be considered even if some of the items likely came from redeposited midden material.

**a) Decorated Material** (Ian K. Jones and MJD)

7.1 Body, showing part of medallion with a crown identical to Dearne (2017c, 32) No. 8.3. [1] SF1

\*7.2 (Pl. 16) Body, showing part of a medallion with a crown consisting of a fleur-de-lis with supporters set on a five squared horizontal bar above a line with curved ends. Spaces between the ends of the crown and edges of the medallion filled with ladder/leaf design and the tiny part of the upper left hand corner of the shield below the crown that survives is blank (this may be the start of a transverse bend). Comparatively well executed and sharpness suggests from a comparatively new mould. [1] SF9

\*7.3 (Pl. 17) Body, showing a semi-complete medallion with much of the arms of/imitating Julich-Cleve-Berg including the triple chevron of Ravensberg bottom right and the chequer-board of the district of Mark (part of the Duchy of Cleve), above an unidentified triple quarter rectangle, bottom left (cf. Green 1989, 138, Nos BAT539 and BAT 20089; elements also on Hildyard 2005, 104, No. 14 dated by him early seventeenth century and with a parallel of 1625 – 50; and on e.g. Blackmore 2006, Fig. 65, No.12); and the central motif on Green (op cit) Nos BAT20251/2168 and BAT602/20337. Elaborate scroll design between shield and edge of medallion. Parts of the design smudged/missing suggesting a damaged mould or careless production. Unusually pale colour suggesting little brown slip was applied. [1] SF10

\*7.4 (Pl. 18) Body (broken during recovery), showing the lower part of the same arms (as above). [34] SF20

\*7.5 (Pl. 19) Body (2, join), showing the top left of a large (probably around 8.00 cm wide, 10.00 cm high) medallion with a ?debased elongated crown above the corner of a shield; and large ladder/leaf motifs infilled with devices including horizontal bands of dots. Dark brown glaze dotted with black fired cobalt blue glaze (randomly applied dots of cobalt colouring were a technique that originated in Cologne around 1550). [1]/[50]/[63] SF19 and [37] SF22

\*7.6 (Pl. 20) Body, showing the top right hand corner of a medallion with ladder/leaf motif and scroll infill flanking part of a shield with a fragment of a design which might be the winged double-headed eagle of the Holy Roman Empire (cf. Green 1989, 140, Nos BAT20359, BAT2029 and BAT2023-2456-2224), though in the cited examples the eagle fills the whole medallion rather than appears on a shield. Very sharp impression, probably suggesting an unworn mould. [1]

\*7.7 (Pl. 21) Body, showing the bottom left of a medallion with the arms of Amsterdam flanked by a scroll and possible plant motif. Very sharp impression, probably suggesting an unworn mould. It is conceivable that this is from the same medallion as the last as they were found in close proximity. [1]

\*7.8 (Pl. 22) Body, showing a fragment of a medallion with infilling motifs including spirals. Part of medallion lost prior to firing. [64]

\*7.9 (Pl. 23) Body, showing part of a beardman mask with a well formed beard almost like a bundle of leaves with two dots between each element, a neat moustache and a horizontal ladder mouth. Similar but cruder designs are present amongst the material from the 1629 Batavia wreck (Green 1989, 132f, Nos BAT2214, BAT21523 and BAT2568). [37] SF23

\*7.10 (Pl. 24) Body, showing part of a beardman mask with a well formed beard with single dots between the elements and part of a slightly curved ladder mouth. General parallels as the last. [34]/[36]

7.11 Body, showing part of the beard from a beardman mask. [1]

Body sherds with traces of medallion edges also came from: [1], [37] and [65]/[68].

**b) Other FREC** (MJD)

- One hundred and twenty two other sherds (plus numbers of chips) of FREC (or conceivably other German stonewares) were recovered. They included the crimped bases of flagons/drinking jugs from [2] and [9], the rims of drinking jugs from [2] and ?[17], a flagon rim and probable base from [1], the crimped base of a large jug/flagon with a corrugated wall from [37] and the following:

- 7.12 Rim/handle, flagon. Complete rim (Di. 2.70 cm) and neck with oval sectioned handle at base of multiple cordoned neck. Int. and ext. mottled brown glaze. [1]
- 7.13 Similar [1]
- 7.14 Rim and body (join), ?drinking jug. Slight grooving on and just below plain rim and cordon at base of neck. Unusually smooth and only very finely mottled dark brown glaze. [37]
- Seventy six sherds over 1 x 1 cm (and a number of chips) of **Surrey/Hampshire Border Ware** (BORD; c. 1550 – 1700) were recovered often comprising body sherds of BORDG, BORDY and BORDO with some material on which all glaze was lost. Contexts included [2], [9] and [21], but distribution was weighted towards contexts in Rooms 5 and 6, especially in Phase 4 demolition dumps filling cut [41] and topsoil [1]. Broadly identifiable forms were often bowls, but there were also the following rather larger range of forms than previously noted from the site:
- 7.15 Rim, flared dish. BORDG [1]
- 7.16 Rim, deep dish. BORDG. As Pearce (1992) Fig. 22 No. 52. [63]
- 7.17 Rim/body, bowl. Simple horizontal rim, thickened on outer edge. Burnt and glaze lost. [34]
- 7.18 Rim (2, join). BORDY. Large vessel with cavetto rim. Possibly Pearce (1992) Type 3 deep bowl (or an unusual chamber pot). Int. mustard yellow glaze tending towards olive. [36]
- 7.19 Rim, porringer. BORDG. [1]
- 7.20 Rim, pipkin. ?BORDG. [1]
- 7.21 Handle/body, pipkin. BORDO. Hollow handle [1]
- 7.22 Base/leg, tripod pipkin. BORDG. Ext. burnt. [1]
- \*7.23 Edge, ?lid. Short thickened (folded) straight edge meeting thin angled body. Ext. clear and int. olive to almost brown glaze. [36]
- 7.24 Body, chafing dish or fuming pot. BORDY. Roped decoration at the edge of a cut out. [1]
- 7.25 Lug, costrel. BORDG. [1]/[50]/[63]
- 7.25 Body, ?costrel. Eroded. [1]
- 7.26 Rim/handle, chamber pot. BORDG. Strap handle with central groove. As Pearce (1992) Fig. 39 No. 319. [34]
- 7.27 Rim, chamber pot. BORDO. As Pearce (1992) Fig. 39 No. 316. [1]
- 7.28 Edge (2, join), upright candlestick drip tray. BORDG. Large bead edge with groove on top and slight groove beside. Only glazed to middle of top of bead. [36]
- Twenty two sherds and several chips (including sherds from [2] and [9], but again often from Room 5 and 6 demolition deposits with one sherd from [65]/[68]) represented at least four or five mugs (the only form recognised) in **Post Medieval Black Gazed ('Metropolitan') Ware** (PMBL; post c. 1580), one from [1] with a flared rim. There was also a single body sherd of **Midlands Purple Ware** (MPUR; 1580 – 1700) from [1].
  - Two hundred and fifteen sherds over 1 x 1 cm and numbers of chips of **London Area Early Post Medieval Red Earthenware** (PMRE; conventionally 1480 – 1600) and **London Area Post Medieval Red Earthenware** (PMR; conventionally c. 1580 - 1900) were recovered, making these the most common fabrics on the site (as in previous excavations). PMRE/PMR comprised 83 sherds, PMR 135 sherds. Most deposits as well as topsoil and U/S material produced sherds.
  - As outlined in Dearn (2016, 15f) in terms of fabric late sixteenth/seventeenth century PMRE and PMR cannot usually be differentiated (pers. comm. Jacqui Pearce) and at this date at least the separation between PMR and PMRE is therefore at best only a reflection of the evolving kiln technology and to a degree consistency of glazing in use at a given production centre at a given time. It therefore seems potentially misleading to try and differentiate PMRE (usually given a terminal date of c. 1600) from PMR (usually dated c. 1580 – 1900) at least on the Elsyng Palace site as much of the 'PMRE' may represent redwares produced well into the seventeenth century, but just at centres not yet at this date producing the more consistently oxidised and glazed products one might term 'PMR'. All London Area Redwares characterisable as 'PMRE' from the site may then be better listed as PMRE/PMR and be dated very broadly to the later sixteenth and seventeenth centuries, not to before c. 1600.
  - As in 2017 flagons were far less common than in the 2016 assemblage and where identifiable to form vessels more often comprised food preparation/serving forms. In 2017 all the PMRE/PMR vessels identifiable were flagons as they were in 2016 and it then seemed increasingly likely that, on this site at least, the division between PMRE/PMR and PMR is one related to form with flagons appearing in PMR, but other forms not appearing in PMRE/PMR. It was hypothesised then that either the producer(s) supplying Elsyng with flagons were often slow to adopt the glazing tradition of PMR

producers or that there was a more general conservatism in respect to flagons as opposed to other vessel forms. In 2018 there were few identifications to form of PMRE/PMR vessels, but those possible (including of numbers of sherds from one vessel from [30]) were of flagons with the exception of a large bead rimmed jar from topsoil which need not challenge this hypothesis.

- No PMRE/PMR vessels require further comment, but PMR vessels included numbers of large bowls or cauldrons/pipkins, some probably as 7.29 below, as well as a smaller number of flagons/jugs. The following PMR vessels are worth separate listing:

\*7.29 Rim/base/body (22 and chips, mostly join to give complete profile), cauldron/pipkin. Thickened squared rim with deep lid seating and five deep horizontal grooves corrugating upper body above a gentle carination. Int. and ext. even, glossy dark brown glaze except ext. at base of wall and under base. Probably with two vertical loop handles and tripod feet as the (earlier, PMRE) late sixteenth/early seventeenth century wasters from Moor House, London (Butler 2006, 91, Fig. 73, Nos 1 – 3) with which this shares many features. [1](?Reworked Deposit on [32])

\*7.30 Rim (3), lid seated pipkin. One sherd broken across circular hole through the lid seating suggesting a suspended form. Clear glaze under rim only. [9] and [1]

7.31 Rim (1) and body (1), lid seated pipkin. Body burnt. [21]

7.32 Rim, lid seated ?pipkin. Broad, everted rim with angled upstanding edge. Int. and ext. overfired black glaze. [1]

7.33 Rim, small pipkin. [25]

7.34 Spout, tettine. [1]

7.35 Rim, very large flanged ?bowl. Int. patchy brown glaze with green spots. Ext. retaining hard white mortar. [21]

7.36 Handle, ?two handled bowl. [9]

7.37 Rim (2, join), large handled bowl. Everted rim with handle scar. [1]

7.38 Handle/body (5, 2 join), ?two handled bowl. Heavy horizontal rod handle. Int. and ext. dark brown glaze. [1] (?Reworked Deposit on [32])

7.39 Rim, bowl or panchion. Wide, horizontal everted rim slightly thickened on outer edge. Int. brown glaze mottled dark green. [34]/[36]

7.40 Rim (2, join), (?shallow) bowl. Squared rim with ext. cordon at a change of wall angle. Int. dark brown glaze. [36]

7.41 Base/body (8, several joins), ?bowl. Int. dark olive brown glaze. [1] (?Reworked Deposit on [32])

- Twelve sherds of **Post-Medieval Slipped Redware** (PMSR; c. 1480 – 1650) were recovered from [1], [2], [9], [21], [34], [34]/[36], [37] and [U/S]. Generally they had a green – often apple green – glaze over a white/cream slip. Most were body sherds, but one came from a vessel with a large rod handle, another probably from a large carinated bowl and there was:

\*7.42 Rim, panchion. Everted, undercut rim grooved on top and outer face. Green glaze over white slip int. and just over rim only. [1]

- Body sherds of **Post-Medieval Redware with Clear Yellow Glaze** (PMSRY; 1480 – 1650) came from [34] (2) and U/S.

- A small group of **Tin Glazed Earthenware** (TGW (Delft); mainly post c. 1613), which is often poorly represented on the wider site, came from the northern trenches in 2018 and included a body sherd, and a base with external decoration including in dark manganese, from [9], a few body sherds including one from a charger from [1] and two more from [20]. There was also:

\*7.43 Largely complete (in five sherds) small drug jar. Buff f. Grey white int. glaze. White ext. glaze with a zone of yellow chevron infilled yellow zig zag between triple blue bands. [2] SF7

7.44 Base, small drug jar. Buff f. Thick white glaze int. and ext. Perhaps post c. 1640 (Orton 1988, 321ff Group C). [9] SF3

- The southern trenches (6 and 7) though produced a more significant amount of Delft comprising over 30 sherds and many chips (though multiple sherds came from the same few vessels). Sherds came from [1], [1]/[50]/[36], [34] (a chip with int. and ext. turquoise glaze, with another from [1]) and [37] and there were the following:

\*7.45 (Pl. 25) Body (2, join), charger. Buff to white f. Ext. lead glaze; int. white glaze with central dark blue spiral and radiating dark blue and orange brown foliate stems separated by dark blue (rather devolved) barred ox-heads and enclosed by three blue lines. Trivet marks to foot ring. Orton (1988) decoration group D (second half of the seventeenth century). [34] SF13

- \*7.46 Rim and body (17, almost all joining in three groups plus several chips), charger. Pinkish f. Ext. lead glaze; int. white glaze with three dark blue triple or quadruple bands of lines, the outer two enclosing an arcade of overlapping arches. Slightly downturned rim. [34] with a few sherds from overlying [1]
- 7.47 Rim (2, join), ?salt. Yellowish f., int. and ext. white flushed pink glaze. Flaring, scalloped rim. [1]
- 7.48 Rim, base and body (18 small sherds and chips with some joins), ?bowl. White f. Good light blue glaze int. and ext. decorated int. and ext. in dark blue. Small bead rim and squared foot ring. [1] (?Reworked Deposit on [32]) with one sherd from [34]
- Much the same comments on the assemblage to those made in 2017 (Dearne 2017c, 35) apply in that the material from this more eastern part of the building complex under investigation provides a slight corrective to the impression gained in 2014 - 16 of an assemblage dominated by flagons and drinking vessels, or rather – as the vast majority of the material comes from demolition dumps on the east of the site – tends to suggest that that preponderance applies to the western part of the Phase 2/3 building complex. If spacial patterning is at all significant (which it may broadly be even though much of the 2017 and 2018 material is suspected to represent the redeposition of palace phase midden material in demolition deposits) this may suggest that the east side of the building complex was more involved with the preparation and serving of food at least in the later stages of the life of the palace (to which the material probably principally belongs).
  - The presence of rather more and semi complete TGW vessels in Phase 4 deposits may be noted and helps to suggest the continuing use of this part of the site into the seventeenth century as well as reinforcing the presumption that this part of the complex was demolished c. 1656. Unfortunately though only a single PMBL sherd from [65]/[68] is of any value in dating any of the Phase 3 activity.

## 8 The Glass

### **a) Vessel Glass**

- Amongst a small group of vessel glass, much too small to identify closely and which included some likely modern material from [1], the following may be noted:
- \*8.1 Knop/bowl, goblet. Clear ?very slightly greenish glass now with iridescent surfaces and appearing brown tinted. Willmott (2001, 57ff) bowl type b and knop type 10.2 (inverted baluster stem) or similar. ?First half of the C17<sup>th</sup>. [1]
- \*8.2 Ditto. ?Clear glass now iridescent. Similar to last but bowl type a. [U/S]
- \*8.3 Knop, goblet. ?Clear glass now iridescent. Similar. [1]
- 8.4 Base, goblet. Greenish glass now with iridescent surfaces. Small thickened bead edge. [1]
- 8.5 Body, e.g. beaker. ?Clear glass now with iridescent surfaces. Thickened sherd from near base. [34]/[36]
- \*8.6 Complete rim and part of neck, flask. Everted rim. Now black/iridescent gold. [34]/[36]
- 8.7 Body, e.g. flask. Greenish glass now with iridescent surfaces. From the shoulder of a vessel. [U/S]
- 8.8 Body, case bottle. Greenish, now iridescent glass. Rounded corner. [1]/[50]/[63]

### **b) Window Glass** (degraded black/iridescent gold coloured surfaces)

- The two largest quarry fragments (4.60 x 3.50, Th. 0.18; and L. 5.70, Th. 0.08 cm) had one grozged edge and one original ungrozged edge respectively and were [U/S]. [34] produced a 4.10 x 2.20 cm fragment from the apex of a diamond shaped quarry (Th. 0.18 cm) and part of a small ?triangular quarry with two original edges, one grozged, came from [47]. There were also less remarkable sherds from [2] (6); [9] (2); [21] (5); [34] (16); [34]/[36] (4); [36] (5); [37] (4); [65]/[68] (2); [1]/[50]/[63] (4); [1] (?Reworked Deposit on [32]) (4); [1] (3); and [U/S] (1).

## 9 Clay Tobacco Pipes

- \*9.1 Stem and circular heel of bowl retaining an impressed rosette/star as Atkinson and Oswald (1969) Fig. 3 No. 1. ?c. 1600 – 30. [1]
- \*9.2 Bowl. Atkinson and Oswald (1969) Type 6. c. 1610 – 40. [36] SF17
- \*9.3 Ditto. [1]/[50]/[36] SF18
- \*9.4 Bowl. Atkinson and Oswald (1969) Type 10. c. 1640 – 60. [1] SF16
- \*9.5 Ditto but tending towards the heart shaped heel of Types 11 and 12. [34] SF14
- 9.6 Part bowl. Earlier C17<sup>th</sup> form. [37]
- Stem fragments came from the following: [1] (16 and 3 bowl fragment); [1] (?Reworked Deposit on [32]) (1 and bowl fragment); [1]/[50]/[63] (2); [9] (5); [21] (2); [25] (1); [34] (17); [34]/[36] (4); [36] (3 and milled bowl fragment); [37] (2); and [38] (1).

## 10 Worked Stone by Ian K. Jones (summarised and discussed by MJD)

- Twenty eight fragments of stone retaining some form of worked surface were recovered. Most were very small and not closely identifiable. Ten items from [58] were all in greensand and included parts of

two ashlar blocks. Four fragments of fine grained white limestone came from [1] and [34] and included two possible decorative moulding fragments and a possible fragment of window mullion. Otherwise all other material was in either greensand or ragstone. In greensand there was part of a large ashlar block from [1] or [33] and other fragments from [1], [34]/[36] and [37]. Ragstone was represented in contexts [1], [21] and [37] and included four sooted pieces likely from fireplaces (including 10.6 below). The following are worth specific listing:

- \*10.6 (Pl. 26) Two joining pieces of ragstone (overall L. 8.50; W. 8.80; Th. 3.80 cm). The front, a chamfered angle and the underside are heavily burned and soot stained and have a reasonable surface finish with some visible tool marks. All three faces also have marks left by the pick used to break up the block. On the upper surface only two small areas of working survive, measuring 3.50 by 2.60 cm and 2.60 by 1.70 cm. The surfaces are slightly soot stained along their outer edges and the larger one has some tool damage. The better preserved larger surface is very well finished and along its inner edge is a very slight line that could mark where the original block stepped up. The burning suggests this is part of a fireplace surround, possibly the horizontal lintel. [1] (Trench 6)
- \*10.12 (Pl. 27) Part of the top of a greensand window mullion (Ht. 13.80; W. at top 10.30; W. at base 6.90; Th. at top 5.50; Th. at base 4.00 cm). The surface finish of the worked spine and right hand side of the mullion is very fine. Towards the top on the right it begins to curve out into the springing of an arch and, although the worked surface has gone, it appears that the left mirrored it. This type of mullion comes from a window with probably just a single mullion separating two arched openings (in a domestic context most likely simple pointed arches, a typical late Medieval form). [37]
- Fragments of grey roofing slate, some with nail holes, came from [9], [34] and [1].

#### *Discussion*

- The worked stone recovered in 2018 adds to that from the same general area in 2016 and 2017 to form the largest group of material from the site to date, though as ever it is clear that the vast majority of worked stone must have been salvaged during demolition where it was not incorporated in pre-demolition deposits. Indeed, a significant proportion of the 2018 (and 2017) material never the less came from [58], the bedding for Room 4 floor [57], with further smaller chips not having worked faces not having been retained from this context (which was only partially excavated). This deposit is strongly suspected to be composed of demolition debris from Phase 1 structures and so this likely adds to the evidence for the use of (exclusively) greensand in these structures at least on this part of the site. The presence of rather larger pieces of ashlar blocks in [58] compared to the predominantly small fragments of worked stone in other contexts may also hint that less salvaging of stone happened at the end of Phase 1 (though of course some material could have just been re-used in Phase 2 structures).
- Material from Phase 4 demolition deposits [34], [34]/[36] and [37] though likely belonged to the Phase 2/3 building complex, as presumably did material recovered from topsoil [1]. It shows a wider range of stones, again unsurprisingly including the easily carved and sourced greensand, but also ragstone and white limestones, probably suggesting that the Phase 2/3 structures in the area included stone elements sourced from a wider area. Items such as the greensand window mullion 10.12 from [37] (the demolition material in the south of Room 5) almost certainly belonged to the southern facade wall of the complex under excavation. The presence of probable fragments which had formed parts of fireplaces, including the possible lintel (10.6, again from the south of Room 5), also suggest that the building complex under excavation included stone fireplaces which could have been domestic or kitchen features. By its demolition elements at least of its roofs were also clearly utilising slate.

#### 11 Struck Lithics by Neil Pinchbeck

- Other than walling flints, numbers of which came from [9] with further examples from some Trench 7 contexts, and debris from their dressing, there was a struck flake from [2] and:
  - \*11.1 A microlith (L. 1.50; W. 1.00; Th. 0.35 cm) formed on a narrow snapped bladelet of dark grey (10 YR 4/1) flint and retouched to give two opposite serrated edges. Broadly, Clark (1934) Type D. Mesolithic. [1]
  - \*11.2 A struck flake (L. 3.00; W. 1.90; Th. 0.40 cm), superficially resembling a Neolithic transverse arrowhead, but not retouched. Very dark grey (10 YR 3/1) flint. MJD and NP are grateful to Jon Cotton for examining and commenting on this item. [9] SF1
  - \*11.3 A scraper (L. 3.30; W. 2.60; Th. 0.60 cm) formed on a flake of dark greyish brown (2.5 Y 4/2 - 3/2) semi-opaque mottled flint. Retouched at proximal end and distal edges. Bronze Age. [1]

11.4 A thick core rejuvenation flake (L. 5.80; W. 3.50; Th. 1.30 cm ) from a two platform core, with wear at the distal end and utilised as a scraper. Variegated very dark grey (10 YR 3/1) to light grey (10 YR 7/1) opaque flint. [1]

## 12 CBM and Other Building Materials

- Details of brick and peg tile morphology, which complete and semi-complete finds mainly in Trench 6 allowed the further study of, are available in archive. Four cut/moulded brick fragments were recovered as follows:
  - \*12.1 Much of a cut plinth brick (L. 13.8+; W. 11.50; Th. 5.70 – 6.30 cm) with a groove bounded over half round moulding cut into the top of one end. Back with much hard white mortar adhering. [37]
  - \*12.2 Cut brick fragment (11.88 x 5.38; Th. 6.12 cm) with three adjoining cut faces retaining brick axe marks. From an angled corner (perhaps of tower [62]). [37]
  - \*12.3 Moulded brick fragment (13.40 x 6.97; Th. 6.26 cm). Moulded with a convex edge turning at 45°. Probably from the corner of a plinth. [34]/[36]
- 12.4 End fragment (L. 9.00 cm) of brick (W. 11.70; Th. 6.60 cm) cut at 60 - 65°. Visible brick axe marks. From a plinth. [37] (NK)
- A small number of fragments of glazed flooring tile/brick came from [2], [9], [34], [34]/[36], [1] and [U/S]. Material was as previously reported from the site except for the chamfered edge of a 1.47 cm thick tile from [34] with patches of grey white glaze in a sandy buff coloured fabric with large brick inclusions.
- Four or five Delft (TGW) tiles were represented by often very abraded fragments from [34], [9] and [1] including:
  - \*12.5 (Pl. 28) Edge (5.60 x 7.20; Th. 1.95 cm). Hard grey f. White glaze with geometric design including double blue line demarked panels with i) turquoise squares and ii) blue outline tulips and fleur-de-lis on a yellow ground. [1] SF15
- 12.6 Three small fragments (inc. a 5.15 x 3.43; Th. 1.72 cm ‘corner’) of a perhaps triangular or segmental tile showing a very pale blue glaze to the side and patches to the back. The poorly preserved front with a small part of a probably blurred mainly at least blue design including narrow blue and yellow border lines. [9] SF4

## 13 Fuels

- In addition to charcoal [2], [21], [34], [1]/[50]/[63] and [37] produced fragments of coal.

## 14 The Animal Bones by Neil Pinchbeck (summary and comment by MJD)

- A total of 19 kg of animal bones, bone fragments, dentition and mollusc shells were recovered, comprising 1,352 items from 29 contexts. The most prolific context was [34] (424 items) with a further 10 items from [36] and 62 from [34]/[36], so that a significant part of the assemblage was from the fills of the Phase 4 demolition cut [41]. Given the far larger exposure of demolition rubble [37] excavated, its total of 115 items clearly shows preferential deposition of faunal material in filling cut [41] and suggests the redeposition of midden material here. Indeed, in Trench 6 much material collected as [37] may in fact have come from undifferentiable [34].
- The other deposit which produced a significant amount of material was the suspected rubbish deposit in Trench 7, [1] (?Reworked Deposit on [32]), which produced 155 items. Indeed, analysis of the provenance of faunal material from [1] (Topsoil) also highlights two special areas. The amount of material from Trench 7 (44 items) probably reflects the presence of less identifiable/more reworked parts of this rubbish deposit ([1] (?Reworked Deposit on [32])) as well as disturbance to the top of [34] filling cut [41]. Similarly 91 items from Trench 6 probably in part at least represent material deriving from fills of cut [41] in an area on the east side of that trench where the cut is suspected to have been present but its fills could not be isolated and may have been disturbed.
- The dominant species present were ovicaprids (482 items) (and for the first time on the present site goats (*Capra hircus*) were specifically distinguishable from sheep (*Ovis aeries*) in at least one instance, a horn core from [37] being confirmed as from a juvenile (kid)). The next most numerous group were bovines (domestic cattle: *Bos taurus*; 268 items, with a horn core confirming the presence of short-horn cattle at least in topsoil material), followed by porcines (pigs: *Sus scrofa*; 108 items) and equines (horse: *Equus caballus*; 40 items). Other mammalian and avian species present were deer (Roe Deer: *Capreolus capreolus*; one item); rabbits (*Oryctolagus cuniculus*; 17 items), chicken (*Gallus gallus*; 26 items), domestic dog (*Canis familiaris*; three items) brown rat (*Rattus norvegicus*; 14 items), goose (*Anser* sp.; two items) and house mouse (*Mus musculus*; one item). Whether three bones of passerine birds

(perching songbirds) present in [36] represent food items or wild bird remains entering a ?midden context it is impossible to say.

- The bulk of the bone collection indicated two aspects of processing. Firstly, the separating of non-meat bearing parts of the carcass from joints of meat, mainly by removal of the bones of the lower limbs, pectoral and pelvic girdle and, secondly, marrow extraction. The very fragmented nature of the assemblage is largely due to the latter process in which most of the long bones and ribs recovered had been broken up by cleaver. The quantity of bone broken in this way emphasises the importance of bone marrow in the early post-medieval diet.
- Other than extremely numerous oyster (*Ostrea edulis*) shells in many contexts, the other marine bivalve present was common cockle (*Cerastoderma edule*), though of three items present two were from topsoil. A single example of the marine gastropod, common winkle (*Littorina littorea*) came from [34].
- Terrestrial gastropods were represented by four garden snails (*Helix asperata*) from [2] and [34] and a single example of the white-lipped snail (*Cepaea hortensis*) from [34]. Notable finds were though one complete and one crushed shell of the Roman or edible snail (*Helix pomatia*) also from context [34]. In Britain, this species is limited to a few areas of chalk downland in south east England, so it would not have been found in the locality of Elsyng and must be highly likely to have been imported as a food item.

# OASIS DATA COLLECTION FORM: England

[List of Projects](#) | [Manage Projects](#) | [Search Projects](#) | [New project](#) | [Change your details](#) | [HER coverage](#) | [Change country](#) | [Log out](#)

**Printable version**

**OASIS ID: enfielda1-328209**

## Project details

Project name	Elsyng Palace
Short description of the project	Excavation of 8 trenches and an area of deturfing significantly revised the interpretation of earlier work. One wall belonged to a predecessor structure now redated to the mid C15th, but a barn previously dated to after palace demolition was confirmed as part of the palace's south west range which now appears to belong in its inception to the late C15th work of Sir Thomas Lovell with some modifications probably in the C16th and C17th. Exposures of the palace facade wall and a multiangular projecting tower fronted at least 8 so far excavated rooms including the probable kitchen boiling house where a well preserved furnace and associated features was fully excavated. Patterned brick and other floor exposures in two rooms allowed the construction of a developmental sequence for modifications to these rooms. There were further finds of decorated FREC vessels.
Project dates	Start: 28-05-2018 End: 22-07-2018
Previous/future work	Yes / Yes
Any associated project reference codes	FXQ18 - Sitecode
Type of project	Research project
Site status	Scheduled Monument (SM)
Current Land use	Other 14 - Recreational usage
Monument type	PALACE Medieval
Monument type	PALACE Post Medieval
Significant Finds	POTTERY Post Medieval
Investigation type	"Part Excavation"
Prompt	Research

## Project location

Country	England
Site location	GREATER LONDON ENFIELD ENFIELD Elsyng Palace
Postcode	EN2 9HA
Study area	101.11 Square metres
Site coordinates	TQ 3380 9887 51.672165830349 -0.064829145011 51 40 19 N 000 03 53 W Point
Height OD / Depth	Min: 31.98m Max: 32.57m

## Project creators

Name of	Enfield archaeological Society
---------	--------------------------------



Organisation	
Project brief originator	Enfield Archaeological Society
Project design originator	Enfield Archaeological Society
Project director/manager	Dr. Martin J. Dearne
Project supervisor	Dr. Martin J. Dearne
Type of sponsor/funding body	London Borough of Enfield

### Project archives

Physical Archive recipient	EAS / Enfield Museums Service Archive
Physical Archive ID	FXQ18
Physical Contents	"Animal Bones","Ceramics","Glass","Metal","Worked bone","Worked stone/lithics"
Digital Archive recipient	EAS / Enfield Museums Service Archive
Digital Archive ID	FXQ18
Digital Contents	"Animal Bones","Ceramics","Environmental","Glass","Metal","Stratigraphic","Worked bone","Worked stone/lithics"
Digital Media available	"Images raster / digital photography","Text"
Paper Archive recipient	EAS / Enfield Museums service Archive
Paper Archive ID	FXQ18
Paper Contents	"Animal Bones","Ceramics","Environmental","Glass","Metal","Stratigraphic","Worked bone","Worked stone/lithics"
Paper Media available	"Context sheet","Diary","Matrices","Plan","Report","Section","Unpublished Text"

### Project bibliography 1

Publication type	Grey literature (unpublished document/manuscript)
Title	Excavations at Elsyng Palace, Forty Hall, Enfield, May - July 2018
Author(s)/Editor(s)	Dearne, M. J.
Date	2018
Issuer or publisher	Enfield Archaeological Society
Place of issue or publication	Enfield
Description	Loose bound and digital A4
Entered by	Dr. Martin J. Dearne (martin.dearne@talktalk.net)
Entered on	12 September 2018

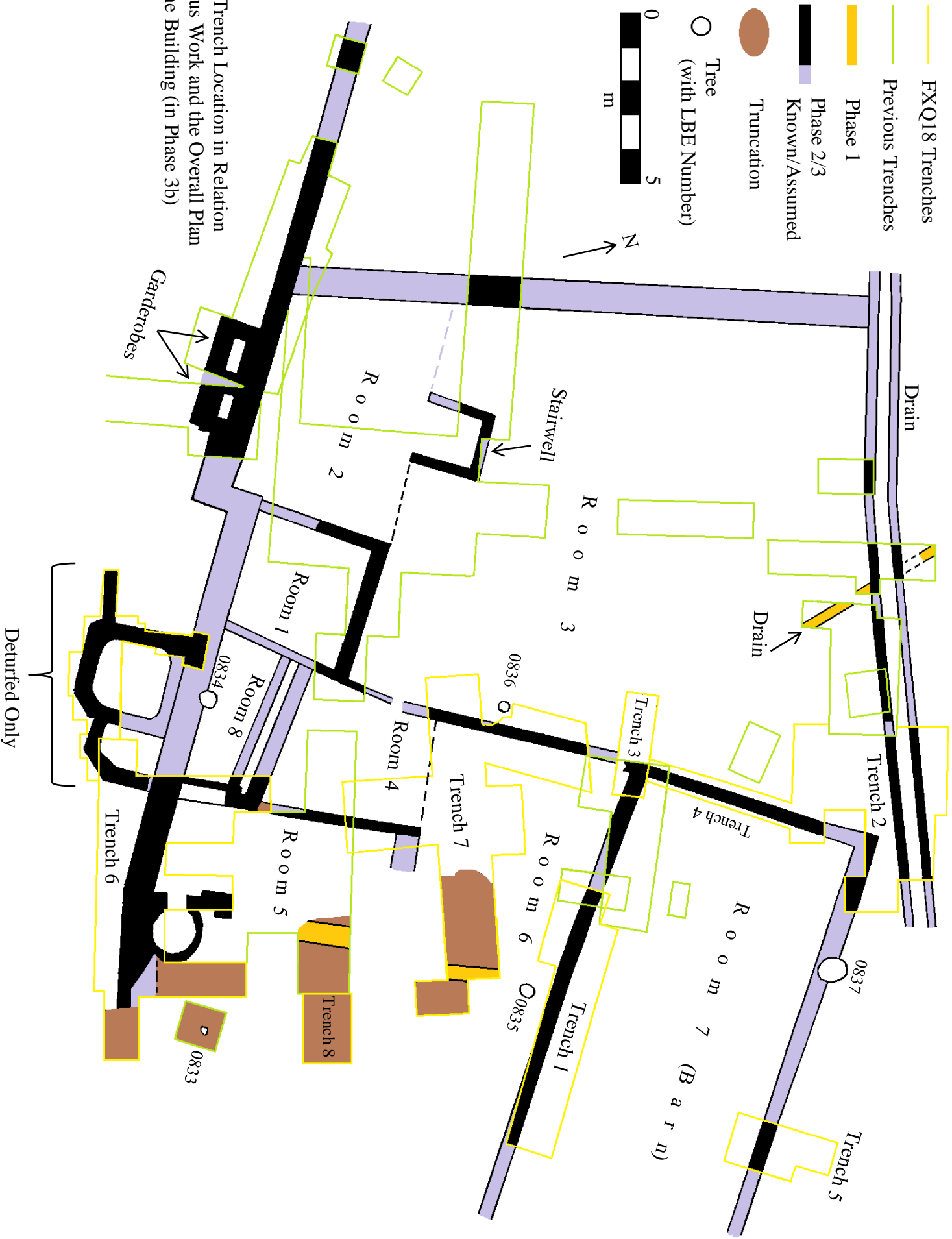

Fig. 1: Trench Location in Relation to Previous Work and the Overall Plan of the Building (in Phase 3b)

Key for Figs 2 - 5

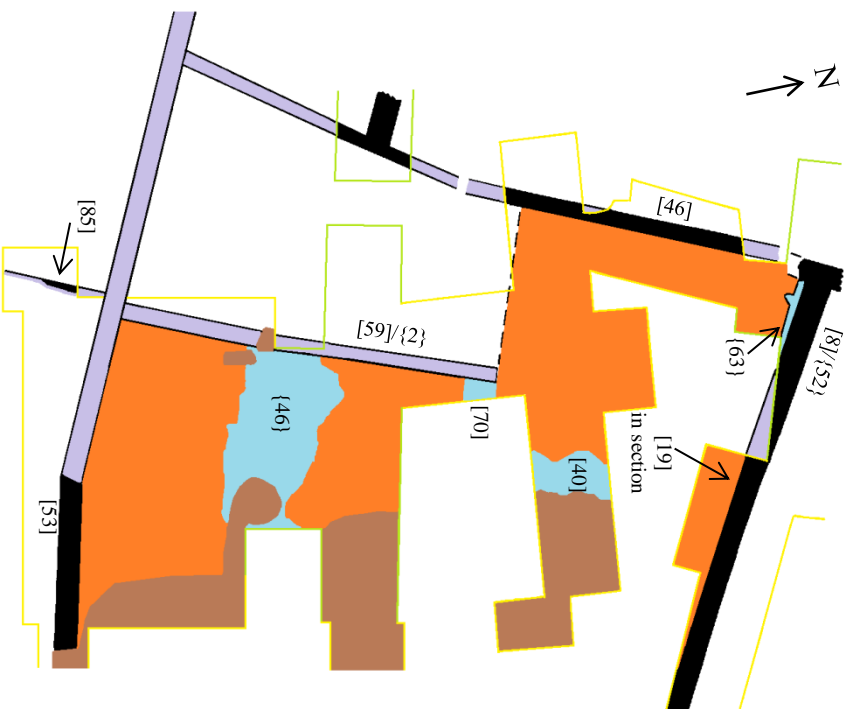
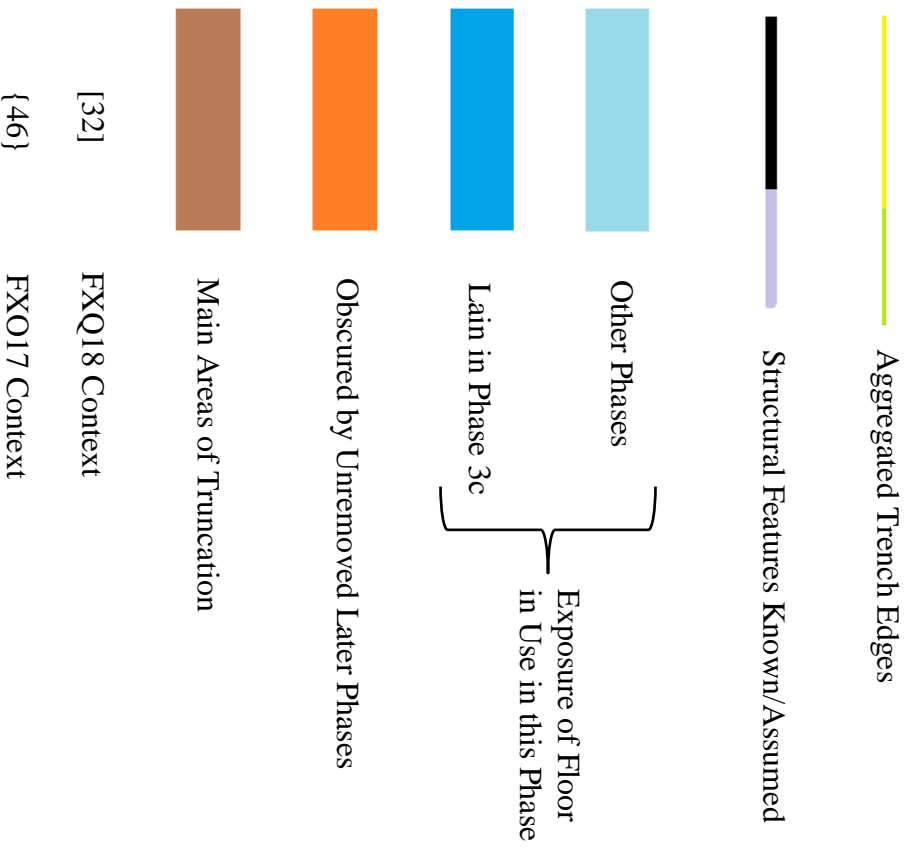

Fig. 2: Floor Surface and Tentative Structural Feature Phasing in Rooms 5 and 6; Phase 2 (1:100)

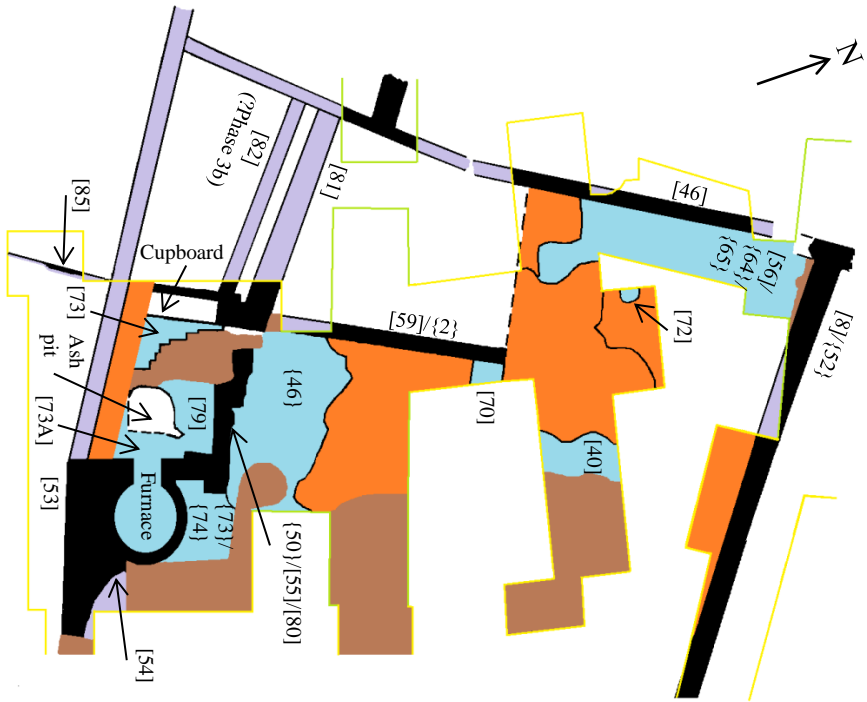

Fig. 3: Floor Surface and Tentative Structural Feature Phasing in Rooms 5 and 6; Phase 3a (1:100)

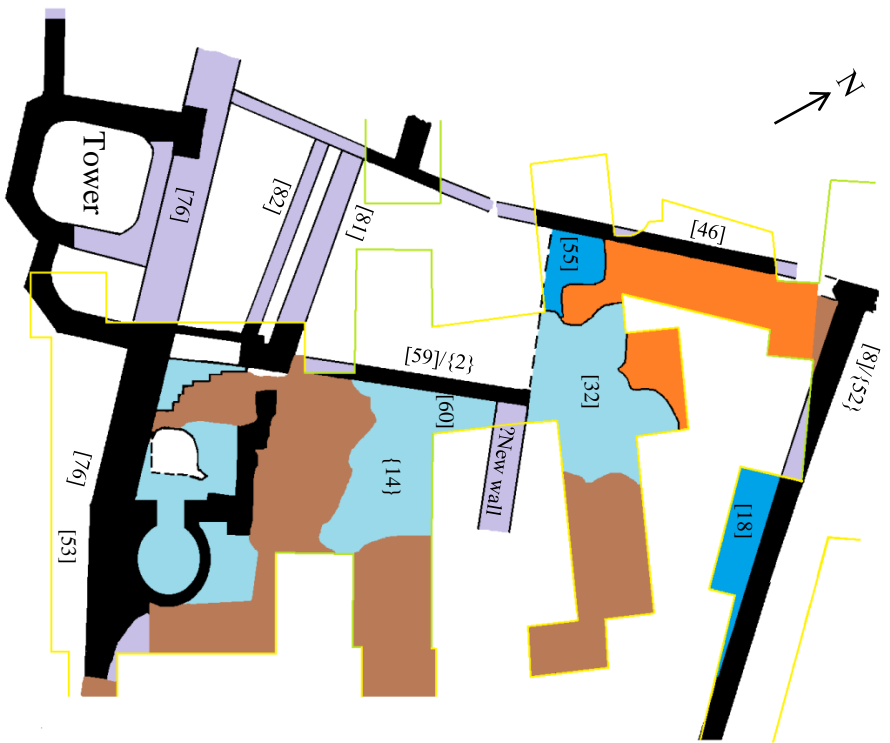

Fig. 4: Floor Surface and Tentative Structural Feature Phasing in Rooms 5 and 6; Phases 3b and 3c (1:100)

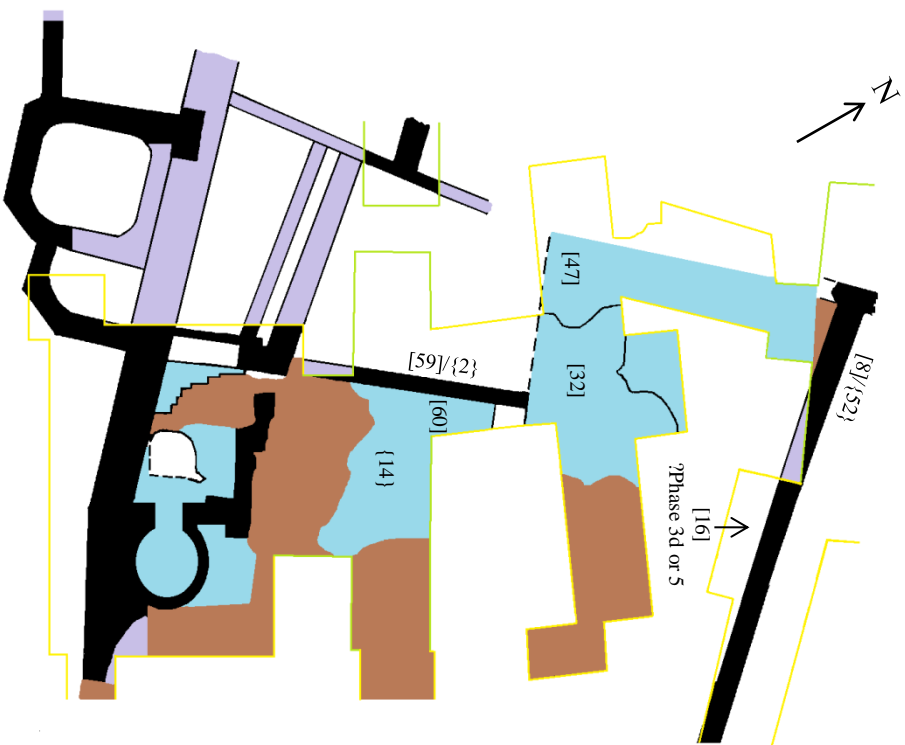

Fig. 5: Floor Surface and Tentative Structural Feature Phasing in Rooms 5 and 6; Phase 3d (1:100)

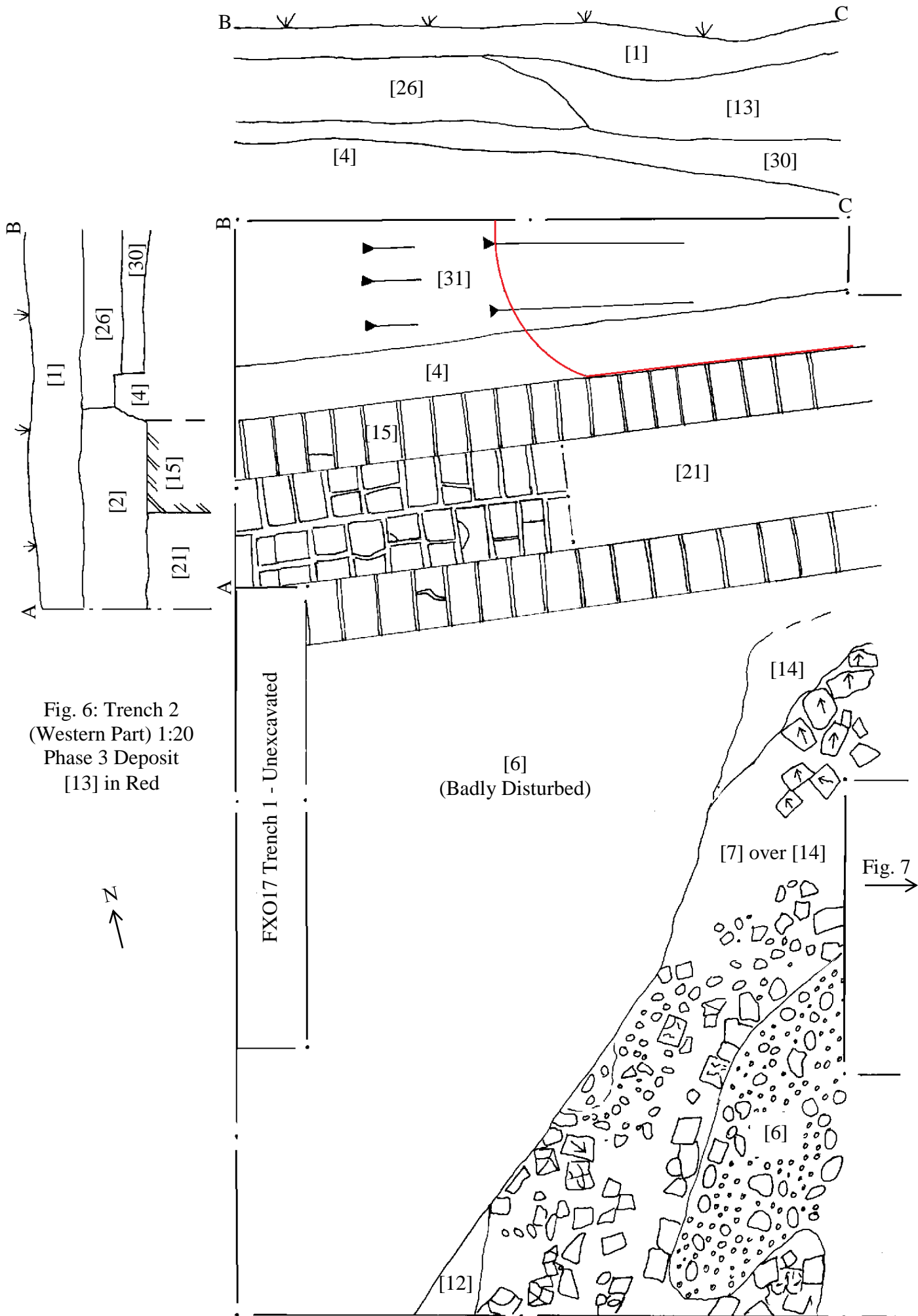

Fig. 6: Trench 2  
(Western Part) 1:20  
Phase 3 Deposit  
[13] in Red

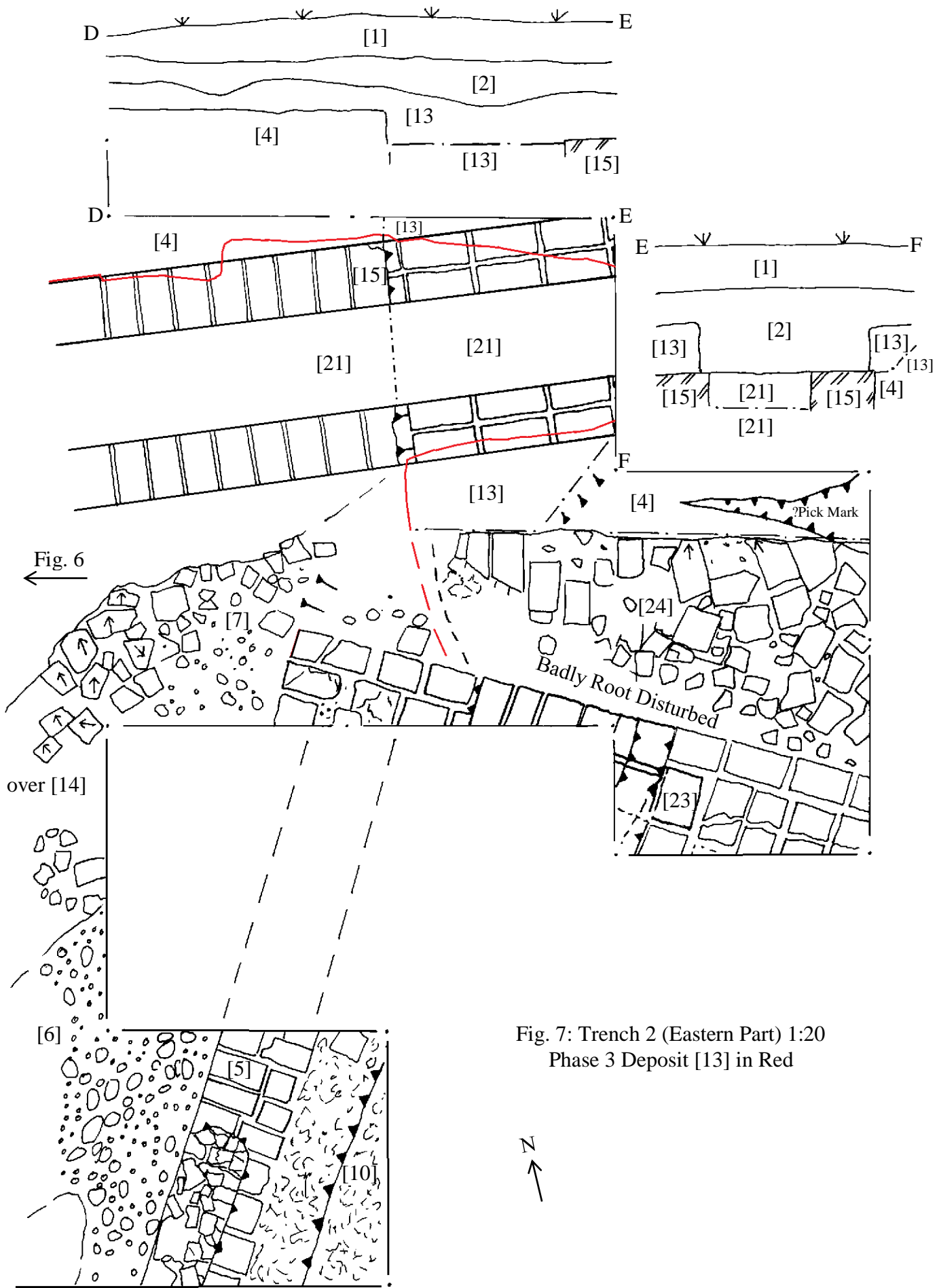

Fig. 6

Fig. 7: Trench 2 (Eastern Part) 1:20  
Phase 3 Deposit [13] in Red

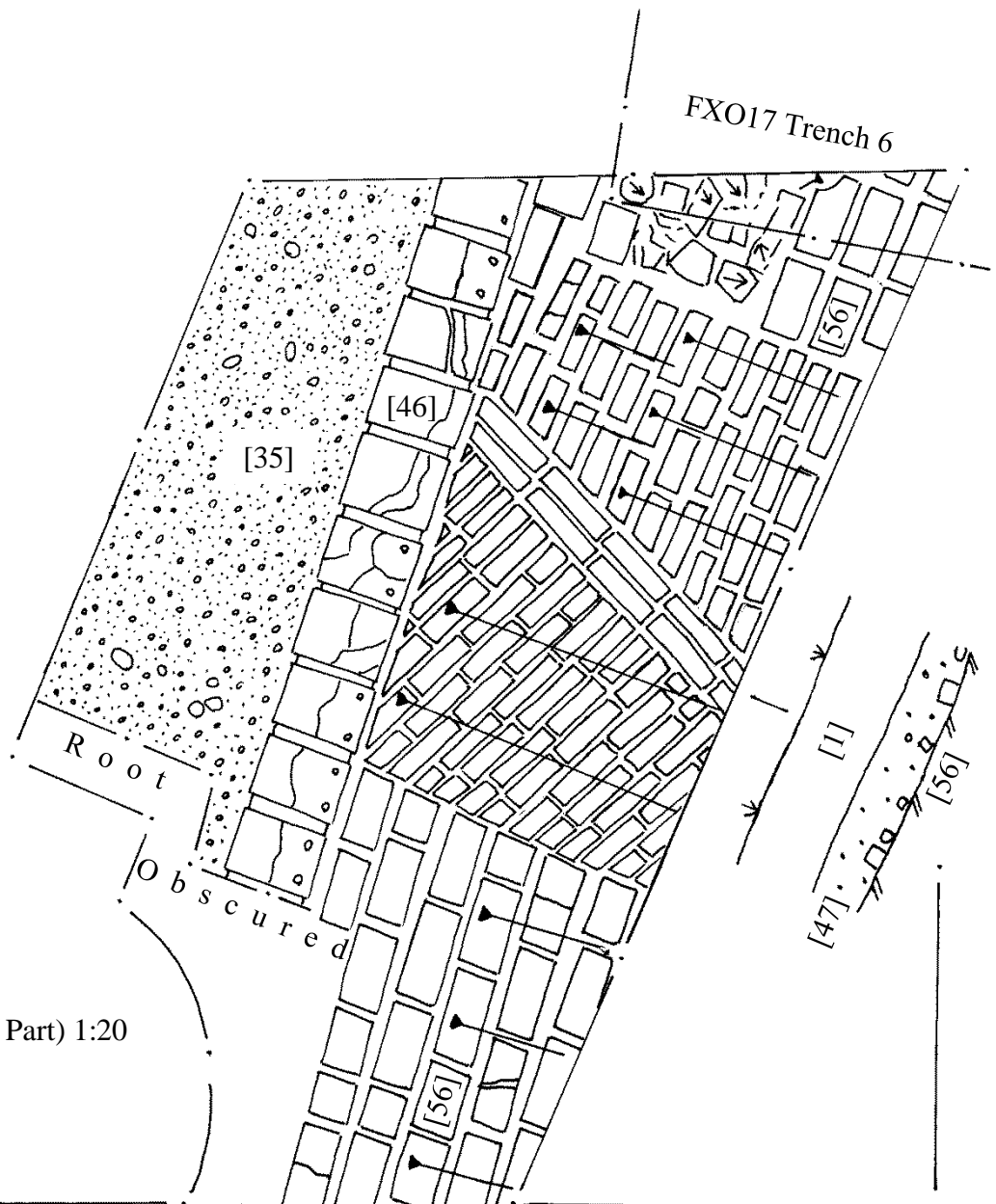

Fig. 8: Trench 7 (Western Part) 1:20

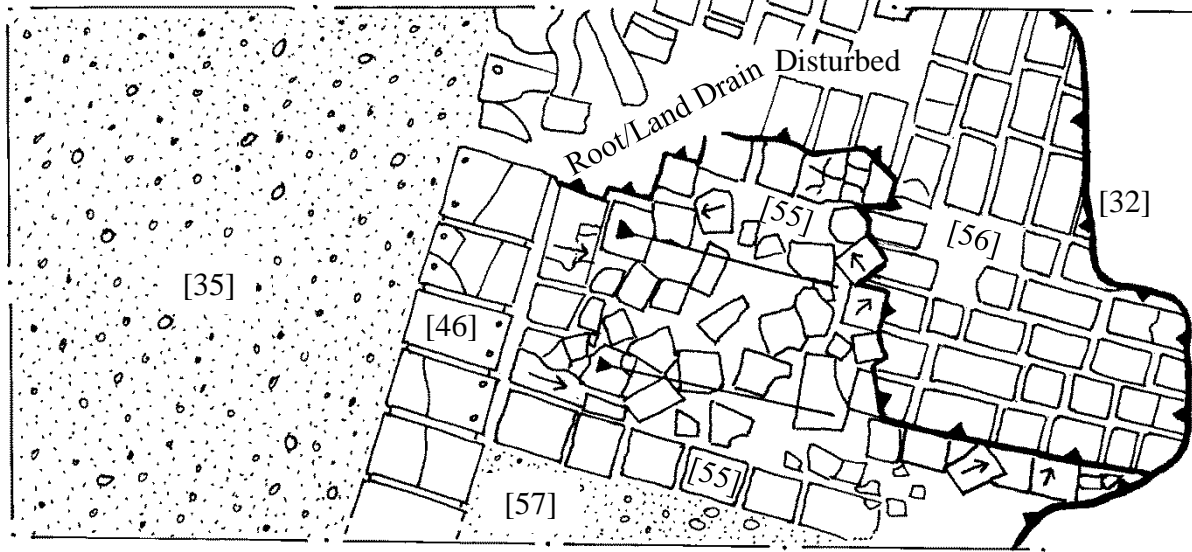
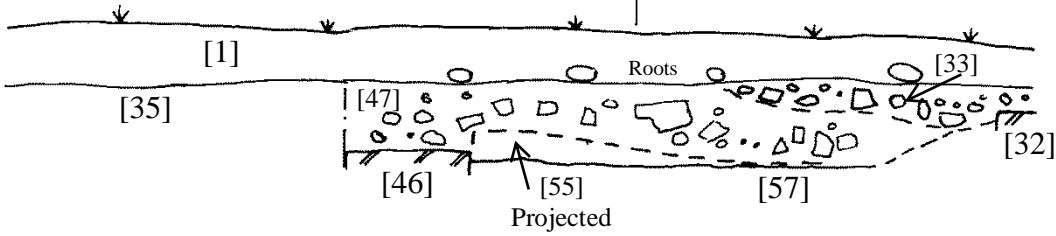

Fig. 9 →





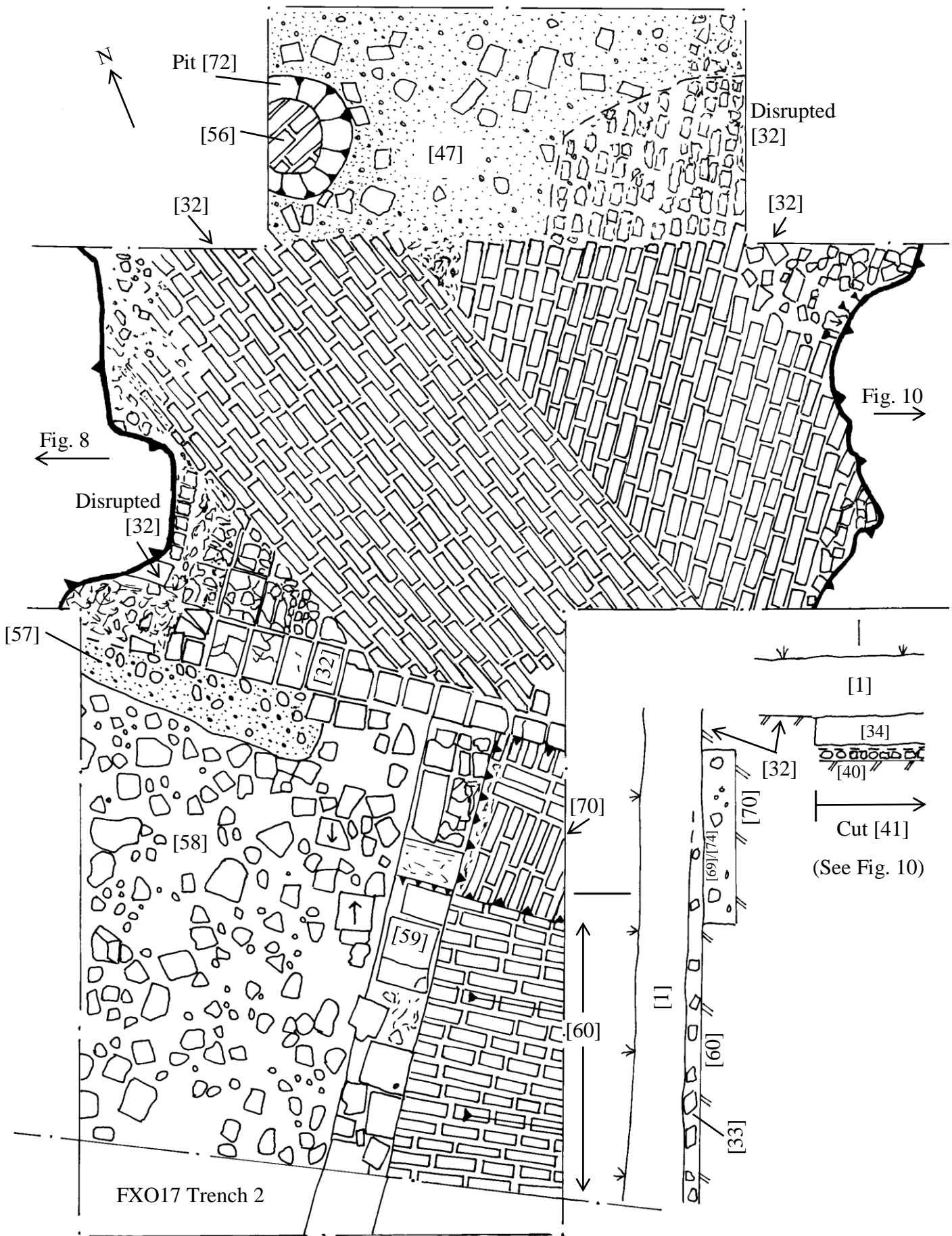

Fig. 9: Trench 7 (Central Part) 1:20

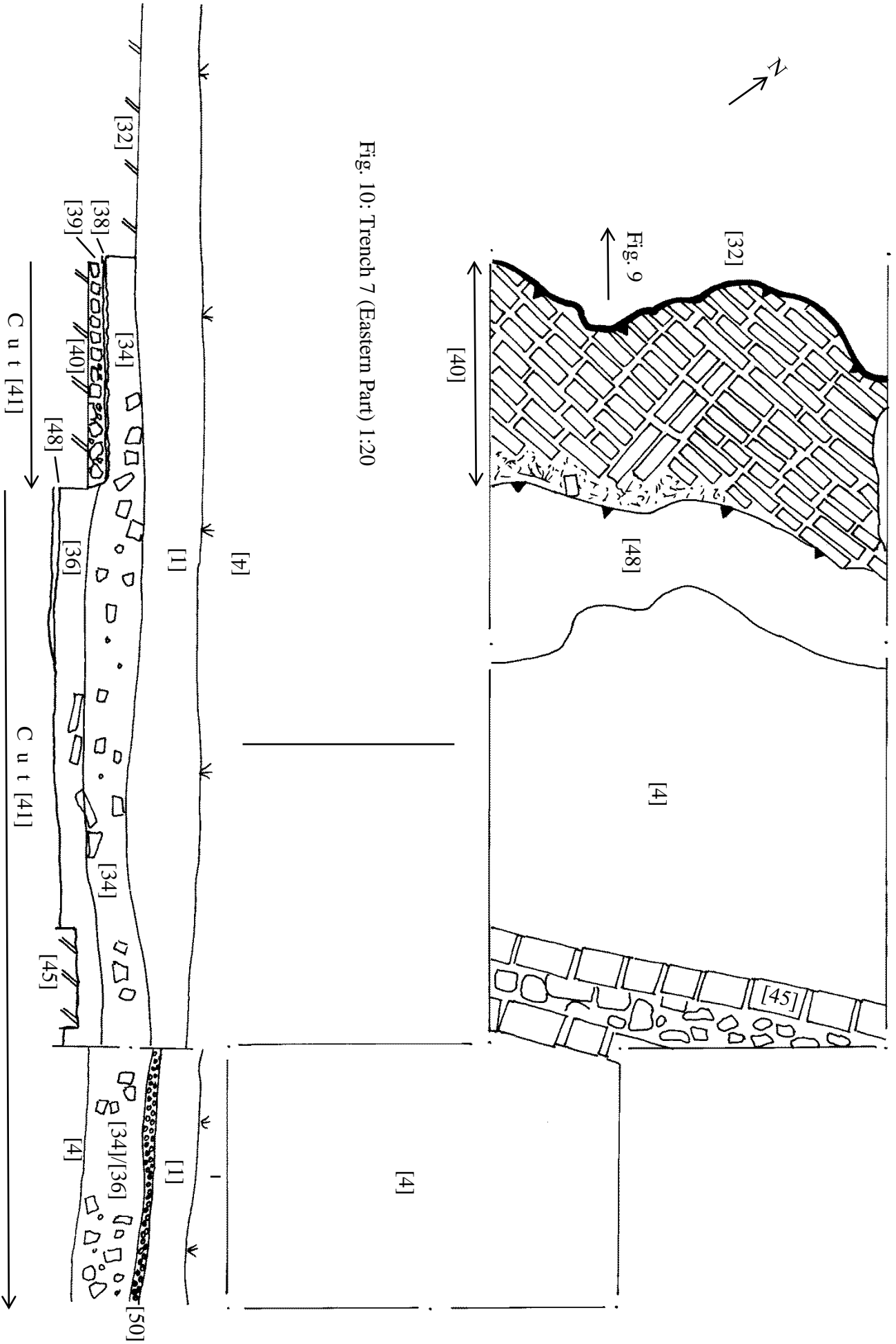

Fig. 10: Trench 7 (Eastern Part) 1:20



Fig. 11: Trench 6 (Western Part) and Southern Parts of FXO17 Trench 2 (1:20)

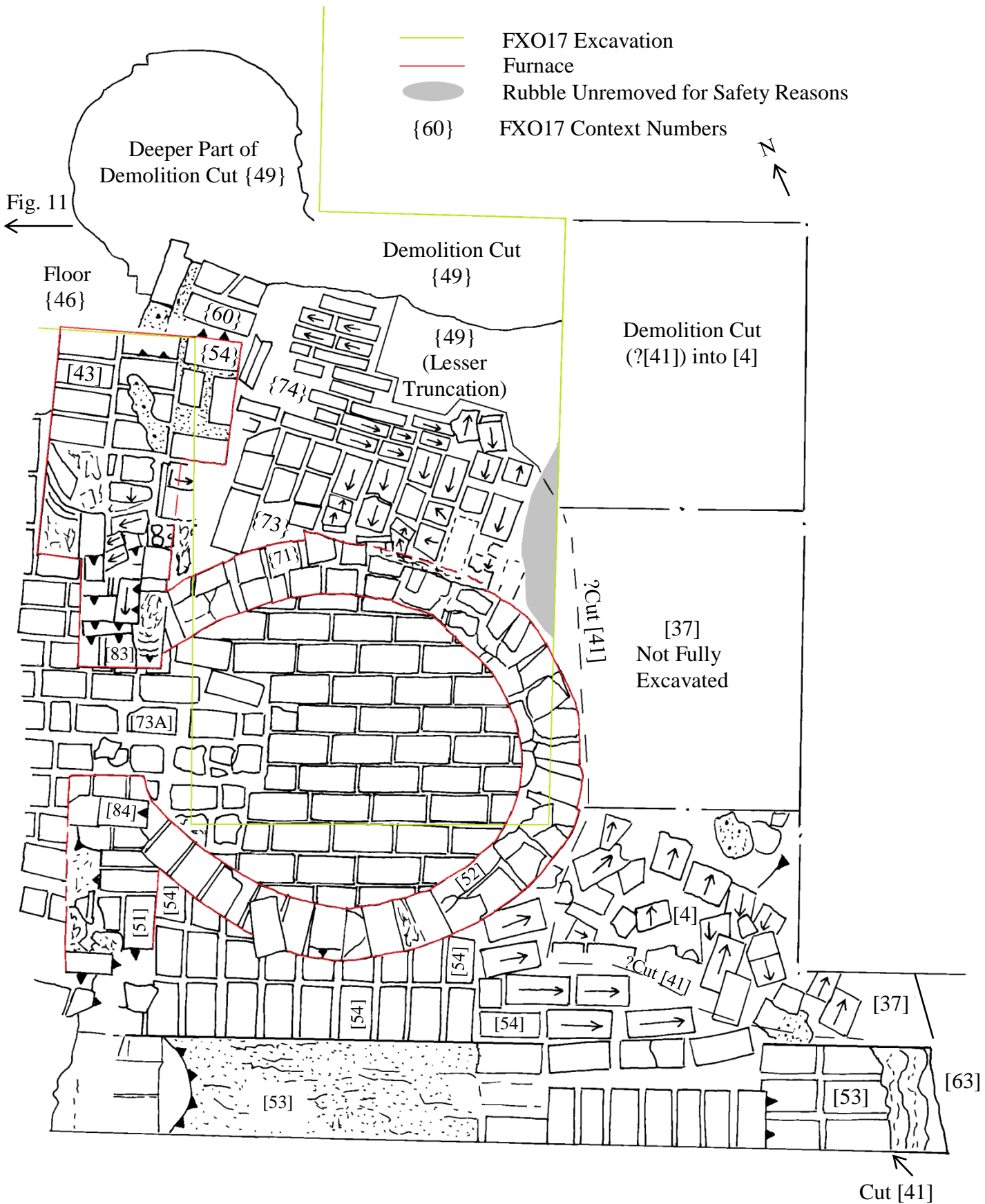
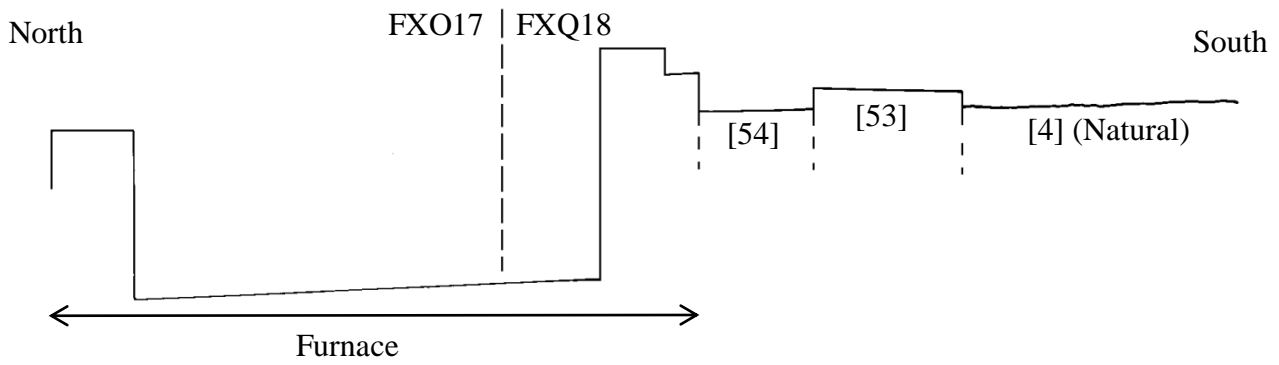
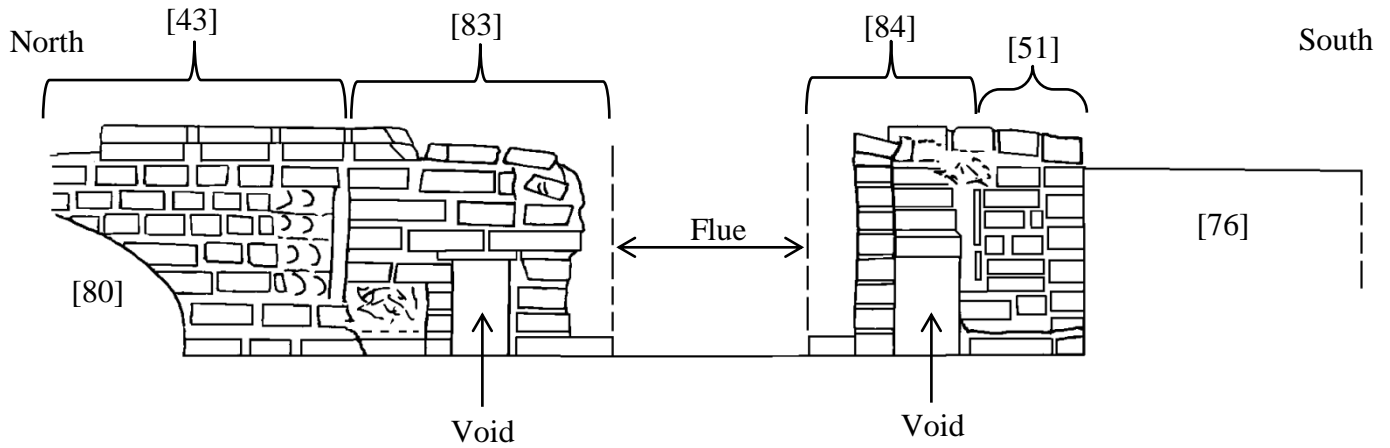

Fig. 12: Trench 6 (Eastern Part) and Southern Parts of FXO17 Trench 2 (1:20)

[4]



Section Across the Widest Point of the Furnace



Elevation of the Western Side of the Furnace

(NB Many Details of this Elevation are Uncertain Due to Damage and it is a Partial Reconstruction)

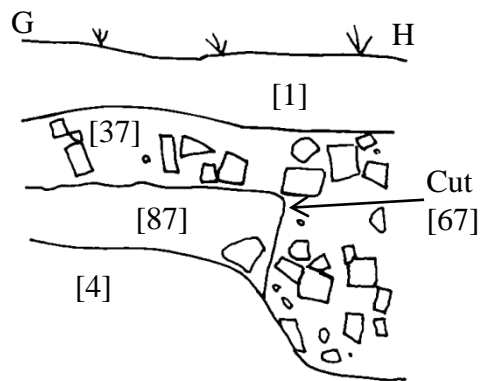

Fig. 13: Trench 6 Sections and Elevations (1:20)

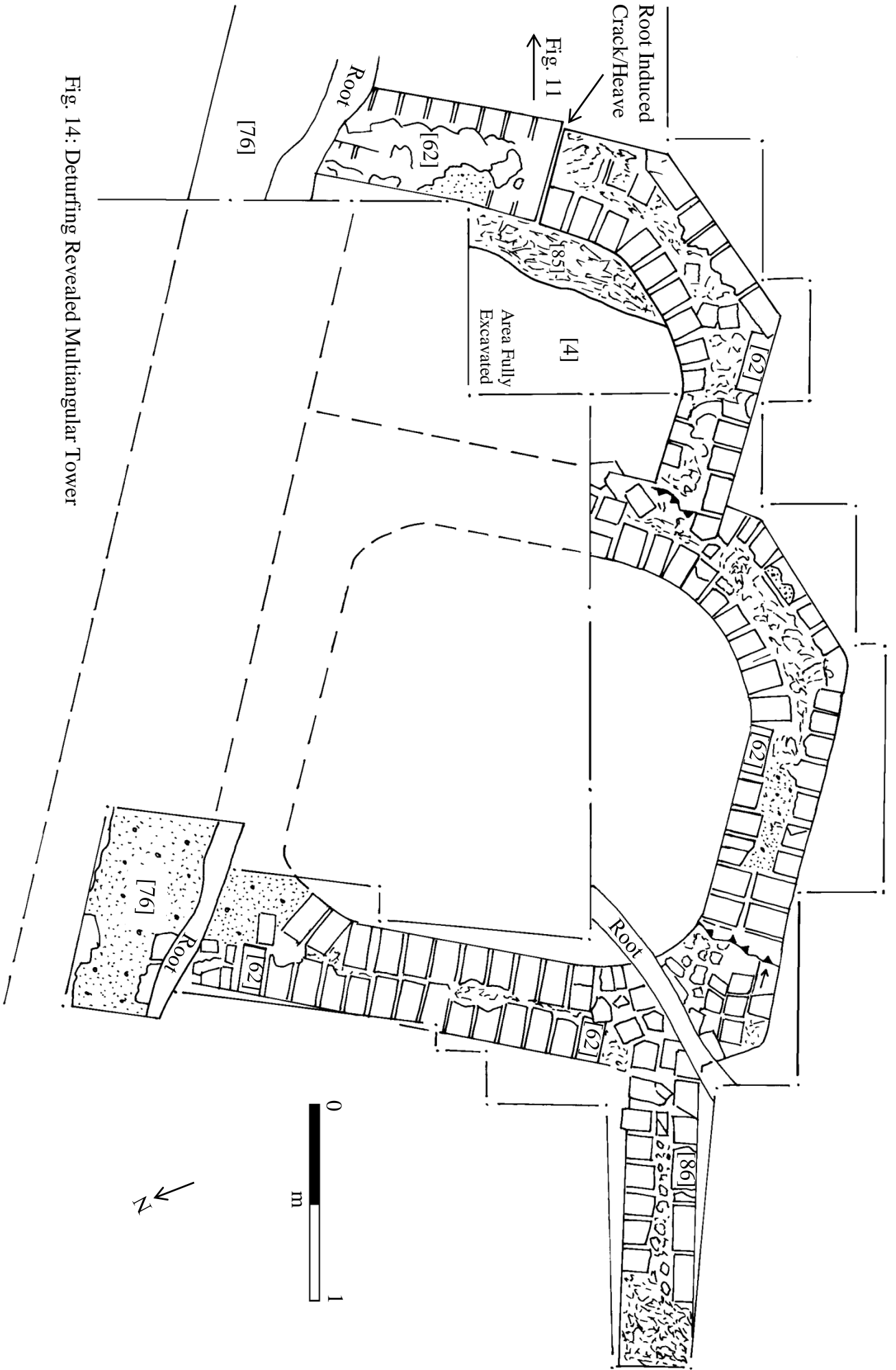

Fig. 14: Deturfing Revealed Multangular Tower

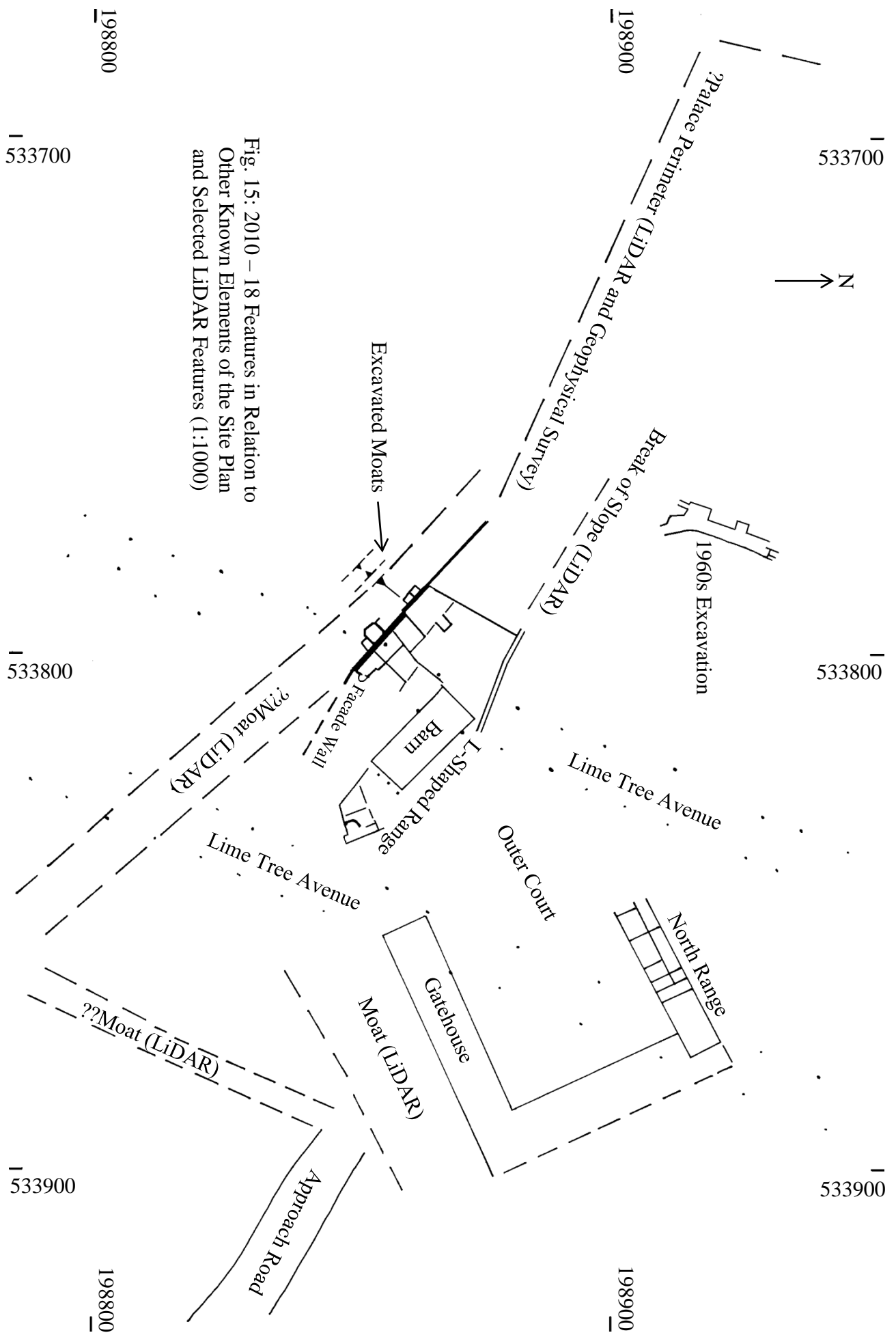

Fig. 15: 2010 – 18 Features in Relation to Other Known Elements of the Site Plan and Selected LiDAR Features (1:1000)

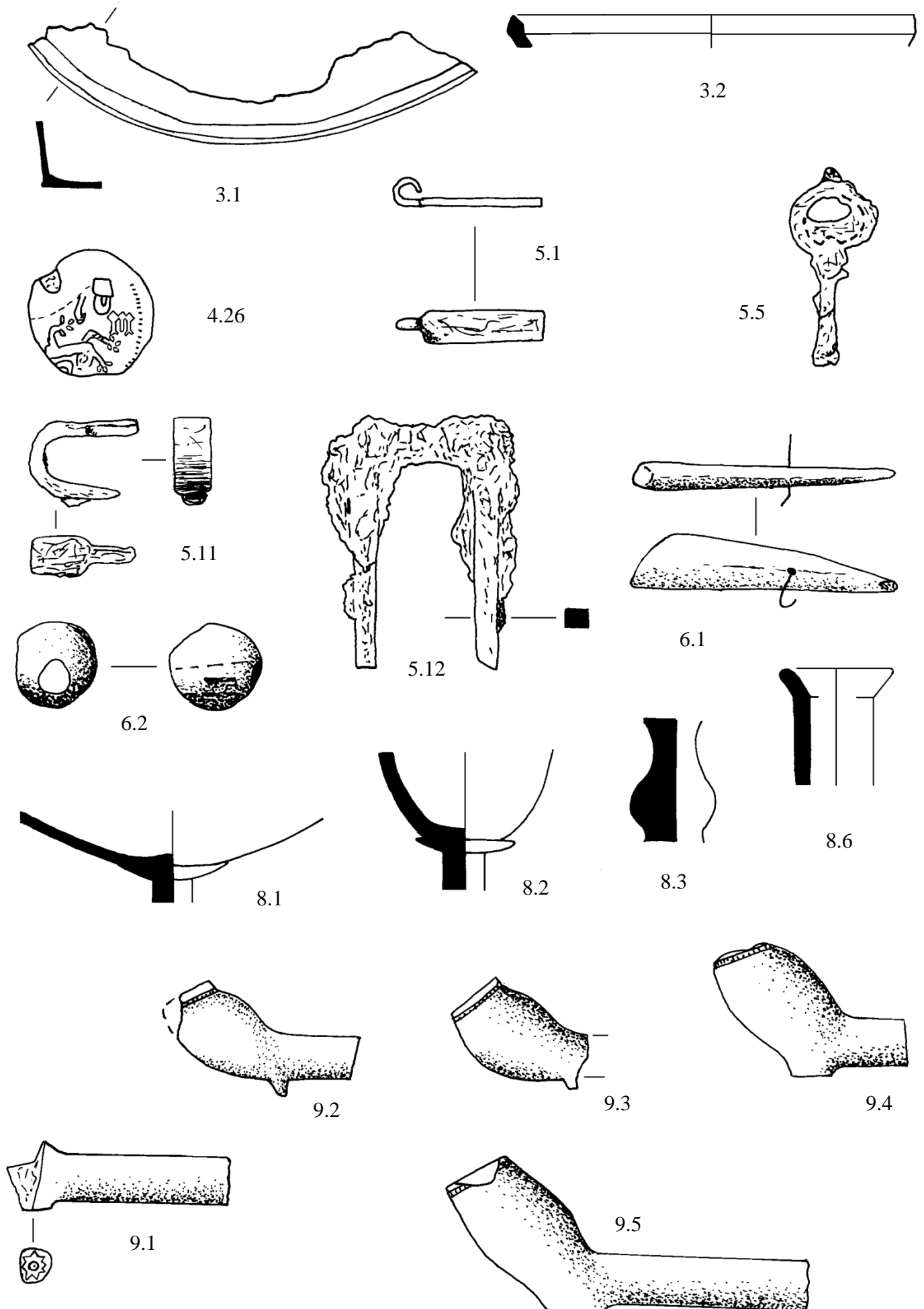
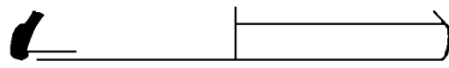
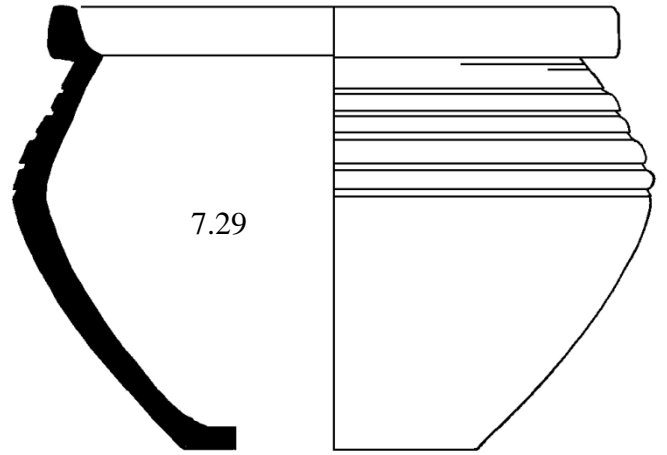

Fig. 16: Finds of Copper Alloy, Lead, Iron, Bone, Glass and Clay Pipes  
 (1:1 Except 3.2 at 1:4 and 5.1 – 5.12 at 1:2)





7.23



7.29

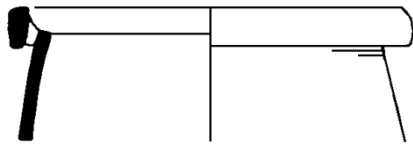

7.30

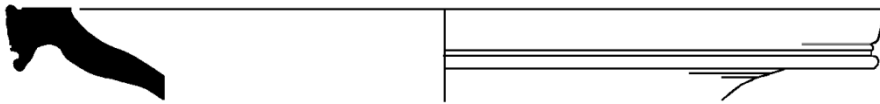

7.42



7.43

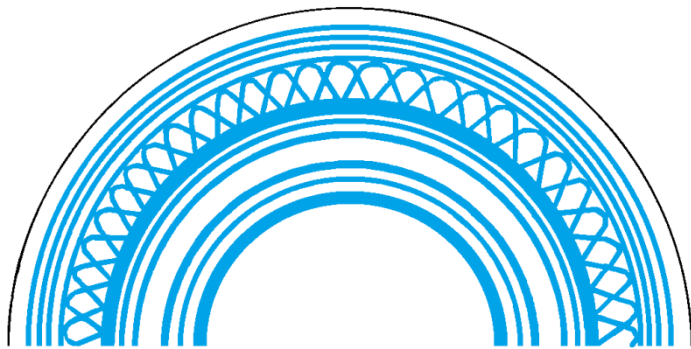

7.46



11.1

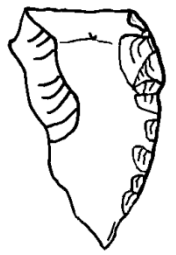

11.2



11.3

Fig. 17: Pottery, Struck Lithics and CBM (1:4 Except 7.43 at 1:2 and Lithics at 1:1)

12.1

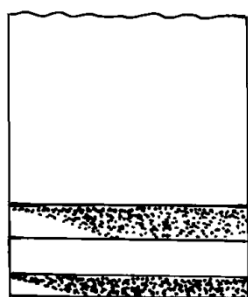

12.2



12.3

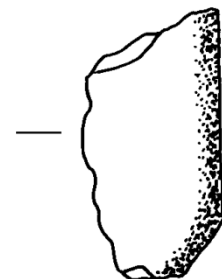



Pl. 1: South Face of Wall [8] (Photo MJD)



Pl. 2: Part Demolished Wall [8] and Phase 3c Floor [18], Looking East (Photo MJD)



Pl. 3: Drain [15] (Photo MJD)



Pl. 4: Cut [31] (Top Right), Drain [15] with its Phase 3 Modification in the Foreground, to Left Floor [6] and (Foreground) Corner of Wall [5]/[23] Flanked by Surface [24], Looking West (Photo MJD)



Pl. 5: Detail of Wall [46] Showing Whitewash/Mortar Outlining the Base Beam with Phase 3c Floor [55] to the East (Top) (Photo MJD)



Pl. 6: Phase 2 Floor [40] Exposed Below Phase 3b Floor [32] by Cut [41], Looking West (Photo MJD)



Pl. 7: Phase 2 Floor [70] Exposed by the ?Removal of a Later ?Wall at the North End of Phase 3b Floor [60] Beside Wall [59], Looking East (Photo MJD)



Pl. 8: Phase 3a Floor [56] Beside Wall [46] with a Block of Phase 3d Floor [47] Left *in situ*, Looking South (Photo MJD)



Pl. 9: Furnace [52] with Butressing Wall [54] Between it and the Facade Wall [53], Looking South (Photo MJD)



Pl. 10: Furnace [52] Looking East, Showing Damaged and Root Disrupted Cheeks [43]/[83] (to Left) and [51]/[84] (Photo John Pinchbeck)

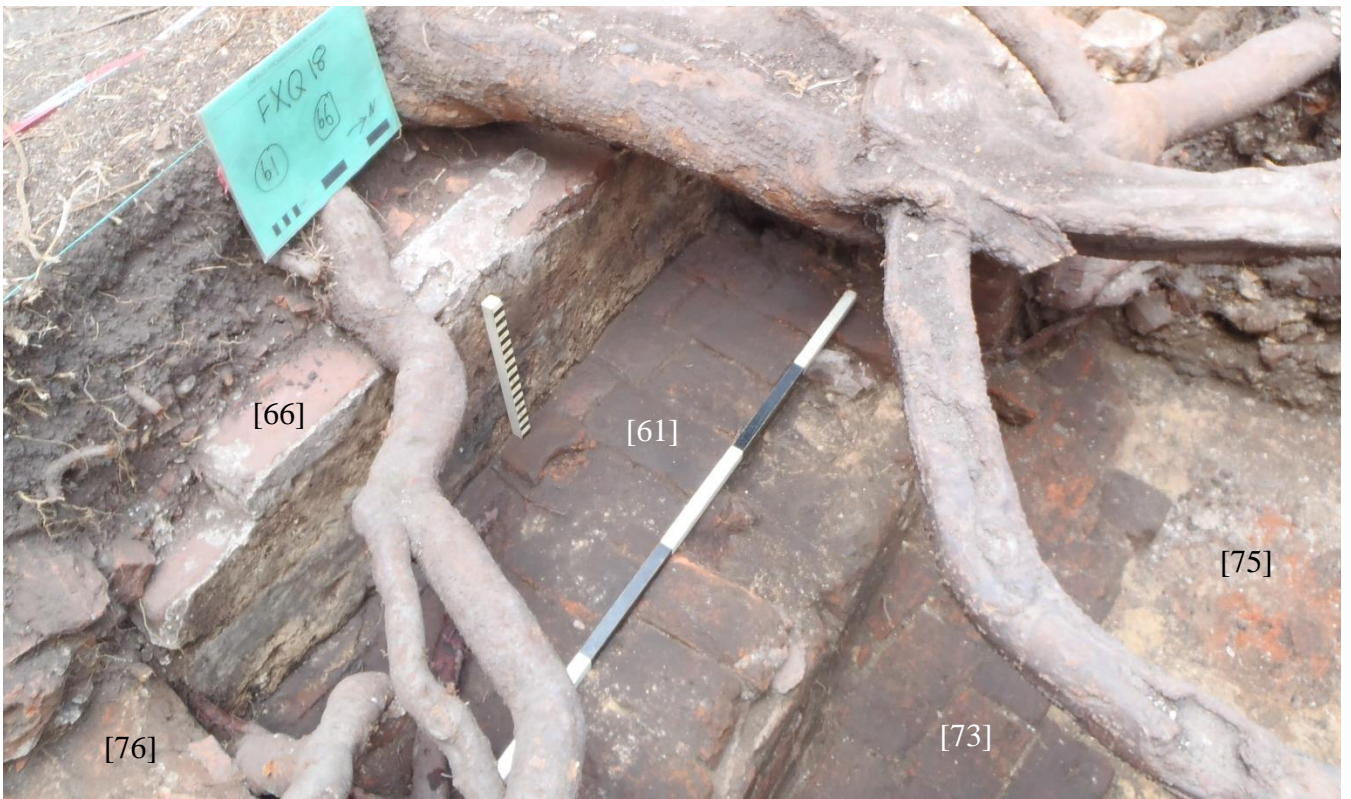

Pl. 11: The Room 5 'Cupboard', Looking North (Photo John Pinchbeck)



Pl. 12: Phase 3b Floor [32] Looking West with Phase 3a Floor [56] and Phase 3c Floor [55] at Top (Photo MJD)

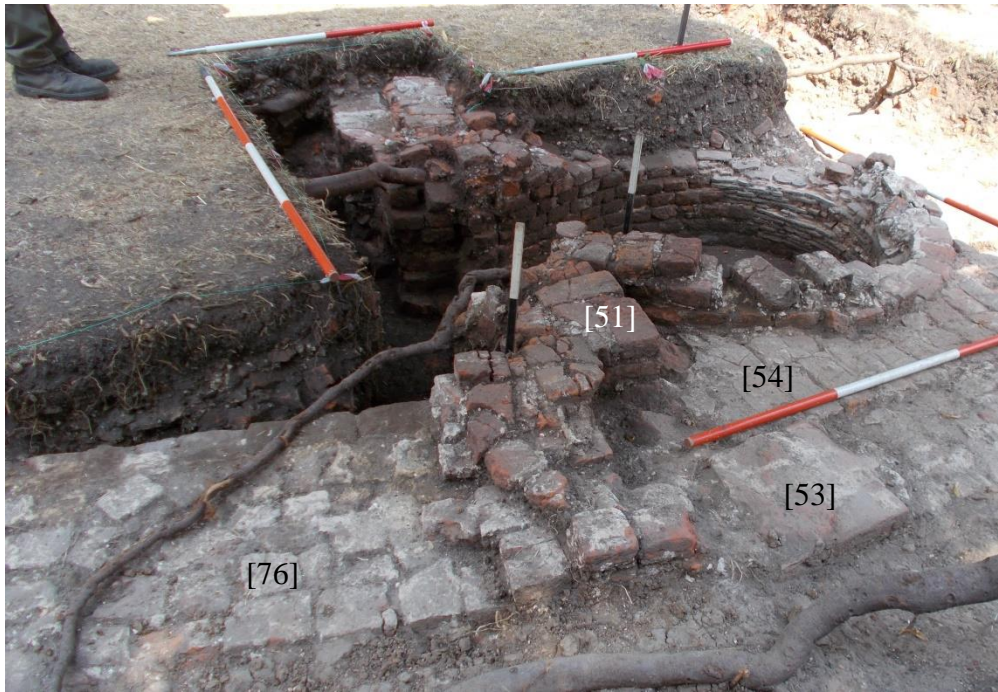

Pl. 13: The Junction of Walls [76] and [53]/[54] and Furnace Cheek [51], Looking North (Photo MJD)

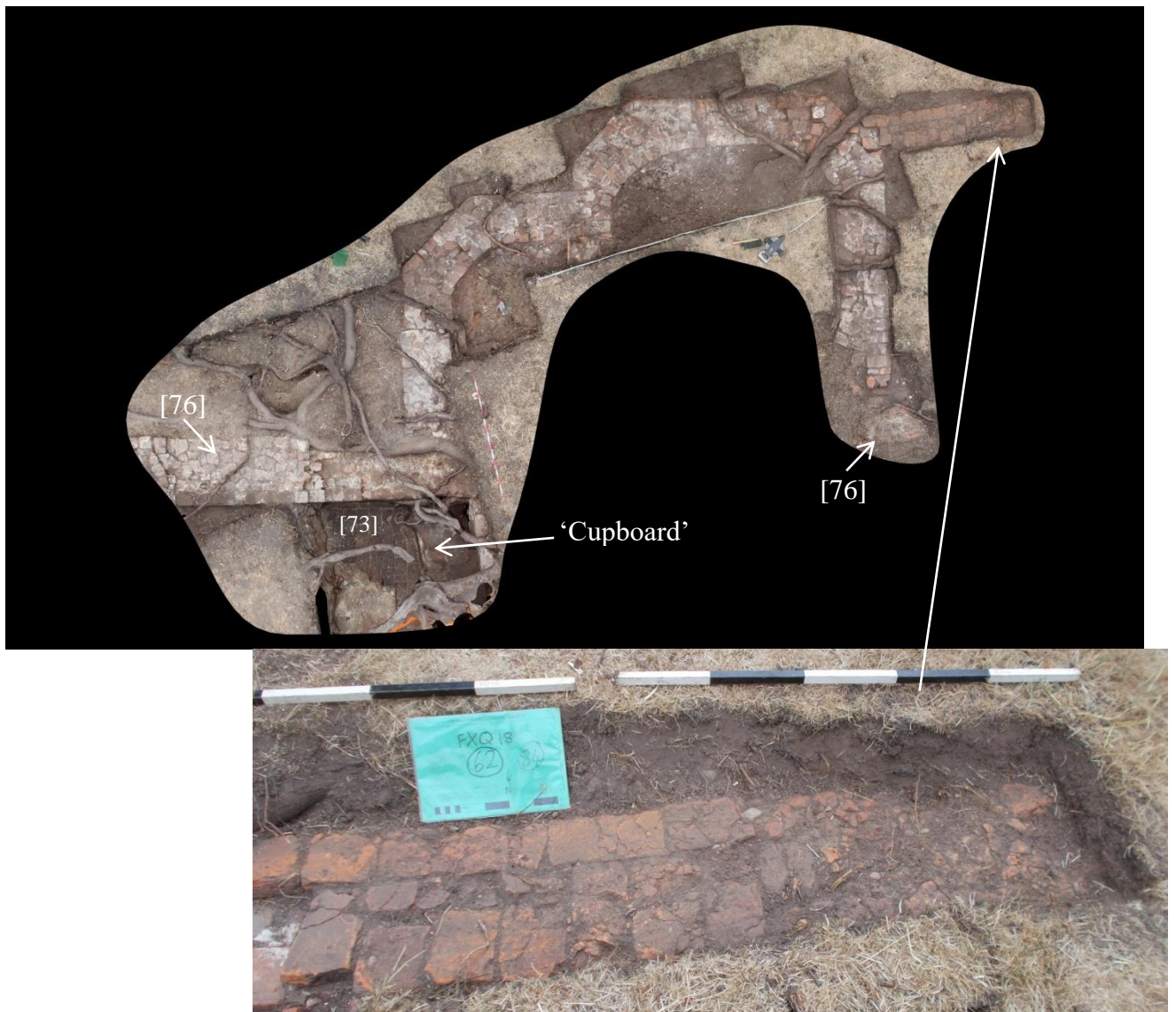

Pl. 14: Multiangular Tower [62]/[84] (Vertical Photo Mosaic by John Pinchbeck) with Detail of Damage to Wall [84] Looking South (Photo MJD)





Pl. 15: Lead Came 4.1 (Photo Neil Pinchbeck)

Pls 16 – 24:  
Photos Ian K. Jones



Pl. 16: FREC Sherd 7.2



Pl. 17: FREC Sherd 7.3



Pl. 18: FREC Sherd 7.4



Pl. 19: FREC Sherd 7.5



Pl. 20: FREC Sherd 7.6



Pl. 21: FREC Sherd 7.7



Pl. 22: FREC Sherd 7.8



Pl. 23: FREC Sherd 7.9

Pl. 24: FREC Sherd 7.10





Pl. 25: TGW Vessel 7.45 (Photo Neil Pinchbeck)



Pl. 26: Worked Stone 10.6 (Photo Ian K. Jones)



Pl. 27: Worked Stone 10.12 (Photo Ian K. Jones)



Pl. 28: TGW Tile 12.5 (Photo Neil Pinchbeck)