

# Expertise in explosion protection

10.2020

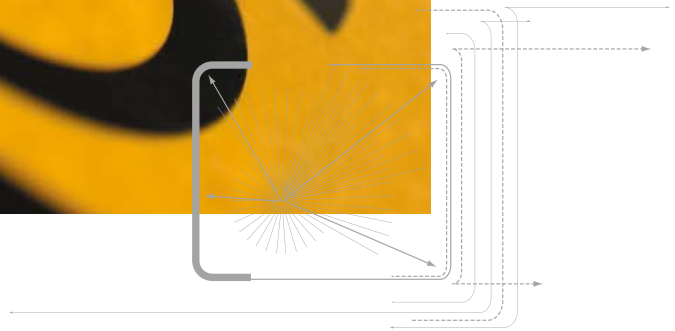

*Partner of Experts*







**STAHL**  
CraneSystems



# STAHL CraneSystems – The Experts

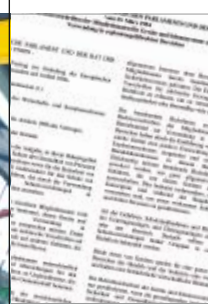

Over 140 years of tradition, over 140 years of practical approach, competence and experience: STAHL CraneSystems can look back on a history characterised by the constant drive for innovation and significant modernisations. At the end of the nineteen-twenties, STAHL CraneSystems was one of the first, and for some time the only manufacturer to influence and advance the development of explosion-protected lifting technology. Revolutionary and programmatic in many fields, always receptive to new aspects, we have amassed a wealth of experience that gives us distinct advantages today. Profit from these advantages, from the expertise of one of the world's leading manufacturers of explosion-protected components and systems for overhead transportation. Technically and economically, our products not only belong to the top flight internationally but lead the way in the field of explosion protection.

<p>1876</p> <p>1898</p> <p>1922</p> <p>1926</p>	<p>1935</p> <p>1953</p>	<p>1978</p> <p>1983</p> <p>1997</p> <p>1998</p>	<p>2003</p>	<p>2009</p>	<p>2010</p>
					
<p>Company founded by Rafael Stahl</p>	<p>First large electric portal crane</p> <p>First electric hoist with wire rope and drum</p> <p>Construction of explosion-protected crane systems up to a lifting capacity of 100,000 kg for the chemical industry</p> <p>Development of explosion-protected hoists, crane components and control technology begins</p>	<p>AS range of wire rope hoists</p> <p>T range of chain hoists</p> <p>World innovation: first explosion-protected flameproof enclosed electric wire rope hoist</p>	<p>SH range of wire rope hoists</p> <p>ST range of chain hoists</p>	<p>One of the largest and most comprehensive portfolios of explosion-proof hoist and crane technology in the world</p> <p>ATEX product directive 2014/34/EU implemented in the whole product programme without exception</p>	<p>As explosion protection expert, STAHL CraneSystems offers explosion-protected customised solutions and crane technology for the gas liquefaction industry (LNG).</p>



**Information and standards**

04

Explosion protection

06

Legal principles

08

Physical and technical principles

10

Duties and obligations of users in Europe

12

Expertise in explosion protection

**Products and services**

14

The danger points

16

Explosion-protected wire rope hoists

18

Explosion-protected chain hoists

20

Components and electrics

22

The engineering

24

The support

26

On the spot and in action all around the world

Full IECEx-certification of the portfolio for Zone 1, Zone 2, Zone 21 and Zone 22



2011

STAHL CraneSystems is in the process of being granted the Brazilian INMETRO certification for Zone 1 and Zone 21.

2014

2018

Extension of CSA approvals held since 2003 to include country approval for North America according to US NEC

# Explosion protection

The beginnings of explosion protection are to be found in the mining industry where miners are exposed to the dangers of fire damp. This term refers to methane gas which escapes in coal mines in particular and which reacts explosively when combined with fine coal dust and air (fire damp explosion). Explosive atmospheres may however occur in other branches of industry too, for example in the chemical or petrochemical industries. Electrical apparatus used in potentially explosive atmospheres must be constructed in such a way that it does not become a source of ignition.

In order to avoid serious injuries and damage to material and the environment, safety regulations, laws, decrees and standards have been established in most states. In this way a high degree of safety has

developed in explosion protection across the world. As the physical laws regarding the occurrence of explosions and the measures taken to prevent them are based on similar principles everywhere, currently the aim is to harmonise approval conditions and regulations regarding conformity at an international level. This brochure merely outlines the European explosion protection directives which however correspond largely to the international IECEx regulations. It cannot take the place of an intensive analysis of national legal principles and standards.

STAHL CraneSystems is pioneering, dynamic and uncompromising when the safety of persons and machines in areas subject to explosion hazards is at stake. STAHL CraneSystems occupies an exceptional position in this field with our many decades of experience and expertise, our own fundamental research

and development, approvals from the Federal Physico-Technical Institute (PTB) and other national and international test institutes and worldwide certification. All hoists and components stem from our own production. The distinguishing hallmarks of our products are the high level of in-house production and integrated quality management. STAHL CraneSystems is the world specialist for explosion protection and as one of the world market leaders offers the most comprehensive and complete range of explosion-proof lifting, drive and control technology.

Chemical industry



Petrochemical industry



Food processing industry



Shipbuilding and offshore industry



Pharmaceutical industry



Energy supply

# Legal principles

## ATEX

With the ATEX product directive 2014/34/EU (ATEX 95) and the ATEX user directive 1999/92/EC (ATEX 137) the European Community has established the basis for uniform European explosion protection. This safety concept is applicable both for manufacturing electrical and non-electrical apparatus and for operating this apparatus in the respective industrial plants. The legislators of the individual member countries implement these directives in equivalent statutory regulations.

In Germany for example these are the Explosion Protection Ordinance ExVO (implementation of directive

2014/34/EU), the Industrial Safety Ordinance (implementation of directive 1999/92/EC) and the Technical Regulations for Industrial Safety (TRBS), the regulations issued by the Employers' Liability Insurance Associations (e.g. BGR 104, BGR 109 and BGR 132), the Employers' Liability Insurance Association information sheets (e.g. BGI 740) and the regulations issued by the VDI (Association of German Engineers) (e.g. 2263 and 3673).

ATEX directive 2014/34/EU defines the properties required by apparatus for safe use in explosive areas. This includes classification into equipment groups and categories, the respective conformity assess-

ment procedures to be followed, manufacturers' responsibility including EU conformity marking, basic safety requirements for the development and manufacture of explosion-protected equipment and recognised quality management measures to be implemented during production. ATEX directive 99/92/EC defines the obligations of users and employers for employees' protection in explosive areas. Inter alia, the user must assess risk and classify the potentially explosive areas into corresponding zones so that the apparatus required by directive 2014/34/EU can be used in safety.



ATEX

IECEx

Excerpt from ATEX directives

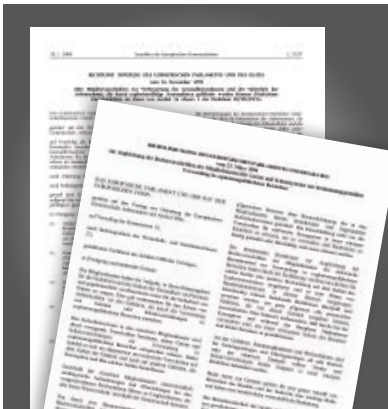

### Assessment of conformity in compliance with ATEX 95

<b>Category 1 and M1</b>	EU-type examination (III)	Conformity to type based on quality assurance of the production process (IV)		<b>CE</b>
		Conformity to type based on product verification (V)		
Individual verification (IX)				
<b>Category 2 and M2</b>	Electrical equipment or Internal combustion engine	EU-type examination (III)	Conformity to type based on product quality assurance	
			Conformity to type based on internal production control plus supervised product testing (VI)	
	Other apparatus	In-house production testing (VIII) and documentation at notified body		
Individual verification (IX)				
<b>Category 3</b>	In-house production testing (VIII)			
	Individual verification (IX)			

The figures in brackets refer to the modules of directive 2014/34/EU which define the procedures to be followed for meeting conformity.

## IECEX

The international IECEX scheme also aims to assess conformity and certify apparatus, systems and services for use in explosive areas. The IECEX system, introduced in 1996, supports the standardisation of norms and the issuing of certificates of conformity (CoC) unrelated to specific countries or regions, in order to thus simplify the free global movement of goods. There is already extensive agreement as to classes and requirements between the European ATEX directives and the IECEX regulations. This means that ATEX could one day be superseded.

IECEX is of great importance outside Europe. A total of 26 countries have acceded to IECEX and there are 34 recognised IECEX certification

bodies (ExCB) and 36 recognised test laboratories (ExTLs) around the world. In countries which recognise IECEX, apparatus with the corresponding certification can be commissioned without further testing.

All products of STAHL CraneSystems are available also with IECEX certification. You will find further information on the IECEX system and its provisions including regulations, handbooks and procedures at: [www.iecex.com](http://www.iecex.com)

## Useful links

### ATEX

→ [ec.europa.eu/growth/single-market/european-standards/harmonised-standards](http://ec.europa.eu/growth/single-market/european-standards/harmonised-standards)

### Explosion Protection Ordinance 11th GPSGV

→ [www.gesetze-im-internet.de/bundesrecht/gsgv\\_11\\_2016](http://www.gesetze-im-internet.de/bundesrecht/gsgv_11_2016) (German)

### Technical Regulations for Industrial Safety (TRBS)

→ [www.baua.de/en](http://www.baua.de/en)

### Industrial Safety Ordinance (BetrSichV)

→ [www.gesetze-im-internet.de/betr\\_sichv\\_2015](http://www.gesetze-im-internet.de/betr_sichv_2015) (German)

### Regulations and information sheets of Employers' Liability Insurance Associations

→ [www.bghm.de](http://www.bghm.de) (German)

### VDI regulations

→ [www.vdi.eu/engineering/vdi-standards](http://www.vdi.eu/engineering/vdi-standards)

### International Electrotechnical Commission System for Certification to Standards Relating to Equipment for use in Explosive Atmospheres (IECEX)

→ [www.iecex.com](http://www.iecex.com)

Explosion protection



International testing authorities



# Physical and technical principles

An explosion is a precipitate chemical reaction of combustible matter with oxygen setting free high energy. In this connection, combustible matter may be gases, mists, vapours or dusts. An explosion can only take place if three factors come together: combustible matter (in suitable dispersion and concentration), oxygen (in the air) and a source of ignition (e.g. an electric spark).





It is thus necessary to prevent ignition or reduce the effect of an explosion to an innocuous level. To ensure this, apparatus which is used in potentially explosive atmospheres must be designed, manufactured and of course marked in compliance with the relevant regulations (ATEX product directive 2014/34/EU, IECEx regulations, etc.). Classification of

devices into groups and categories according to ATEX product directives or in EPL according to IECEx standards results from their area of use or the safety level of protective measures and the frequency of occurrence of an explosive atmosphere. The highest possible risk potential must be taken into account when carrying out this classification. Only explosion-protected apparatus may be used in areas in which explosive atmospheres may occur in spite of all preventive measures. This apparatus is produced in various types of protection in accordance with the corresponding construction regulations (series of standards IEC/EN 60079 and ISO 80079-36/EN ISO 80079-36).

The type of protection applied by the manufacturer depends on the type and function of the apparatus. All standardised types of protection within a category are equivalent. In the EU declaration of conformity included in the technical documentation the manufacturer confirms that the product meets the ATEX directives.

IEC 60079/EN 60079 for the use of electrical equipment in areas exposed to gas/dust explosion hazards

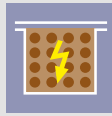
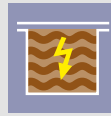
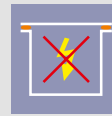
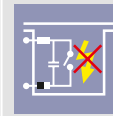
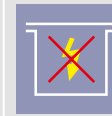
IEC 60079-0/EN 60079-0 General requirements on design, testing and marking electrical equipment and Ex components

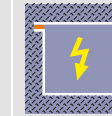
									
<b>Ex d</b> flameproof enclosure	<b>Ex p</b> pressurised apparatus	<b>Ex q</b> powder filling	<b>Ex o</b> oil immersion	<b>Ex e</b> increased safety	<b>Ex i</b> intrinsic safety	<b>Ex n</b> Zone 2 equipment	<b>Ex m</b> encapsulation	<b>Ex op</b> optical radiation	<b>Ex t</b> protection by housing
IEC 60079-1 EN 60079-1	IEC 60079-2 EN 60079-2	IEC 60079-5 EN 60079-5	IEC 60079-6 EN 60079-6	IEC 60079-7 EN 60079-7	IEC 60079-11 EN 60079-11	IEC 60079-15 EN 60079-15	IEC 60079-18 EN 60079-18	IEC 60079-28 EN 60079-28	IEC 60079-31 EN 60079-31



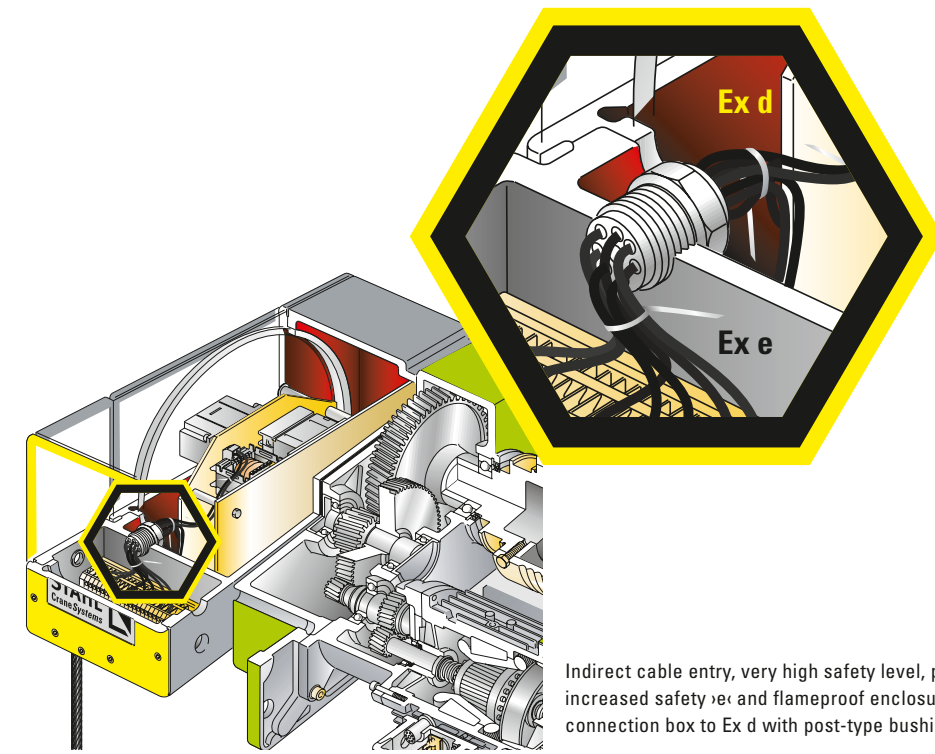
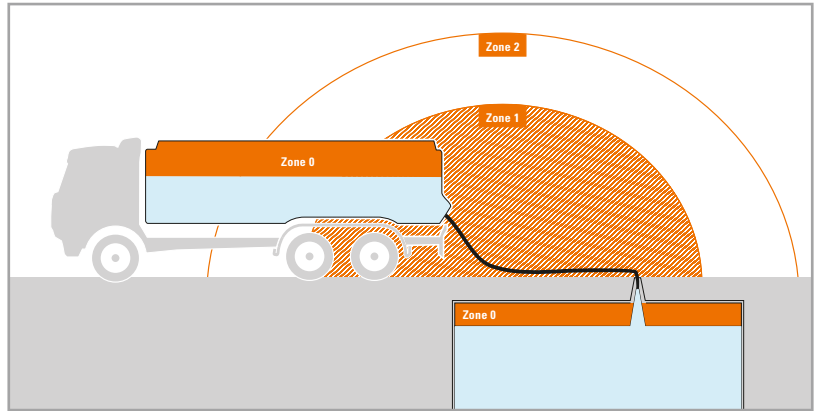
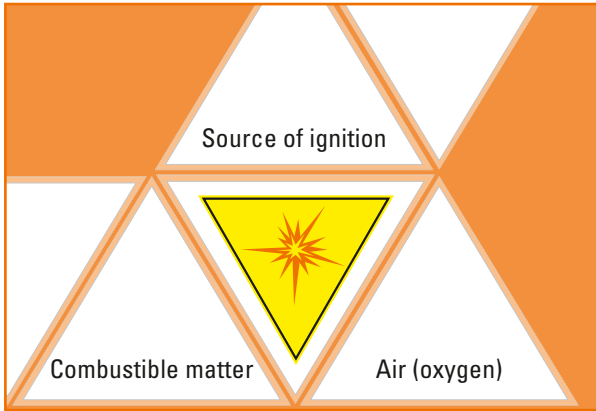

Indirect cable entry, very high safety level, provided by type of protection increased safety »e« and flameproof enclosure »d«. Connection of Ex e connection box to Ex d with post-type bushing.

ISO 80079-36/EN ISO 80079-36 for non-electrical equipment in areas subject to gas/dust explosions



**Ex d**  
flameproof enclosure

IEC 60079-1  
EN 60079-1



**Ex c**  
constructional safety

ISO 80079-37  
EN ISO 80079-37

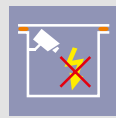

**Ex b**  
monitoring sources of ignition

ISO 80079-37  
EN ISO 80079-37



**Ex p**  
pressurised apparatus

IEC 60079-2  
EN 60079-2



**Ex k**  
liquid immersion

ISO 80079-37  
EN ISO 80079-37

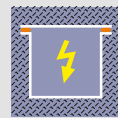

**Ex t**  
protection by enclosure

IEC 60079-31  
EN 60079-31

# Duties and obligations of users in Europe

ATEX directive 1999/92/EC defines users' obligations for the protection of employees working in potentially explosive atmospheres. The user is obliged to establish technical and organisational measures to prevent explosions occurring. In this respect he must for example assess the potential danger and explosion risk, ensure that the working environment has been designed for safety and classify the hazardous areas into zones in accordance with the directives for safe operation of the apparatus which has been classified into categories. In addition he is

obliged to issue and maintain an explosion protection document. Naturally further issues are defined in directive 1999/92/EC in order to implement explosion protection effectively. After a system has been commissioned in due form it must be monitored and maintained so that the safe condition of the system is ensured and all dangers can be excluded. The plant's expert has product-specific documents (rating plate, operating instructions, EC prototype test certificate, declaration of conformity, etc.) and universally valid documents (legal ordinances, industrial safety ordinance, technical regulations TRBS, norms and standards, etc.)

at his disposal. The full product-specific documentation must be managed and retained throughout the period of use of the apparatus and placed at the disposal of the experts entrusted with maintenance work.

Zone plan of a paint shop

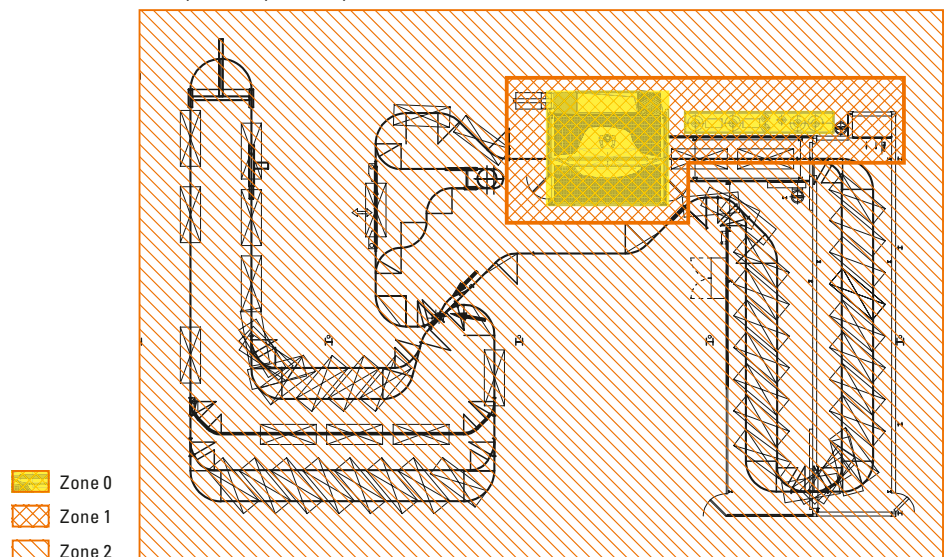

Integrated explosion protection

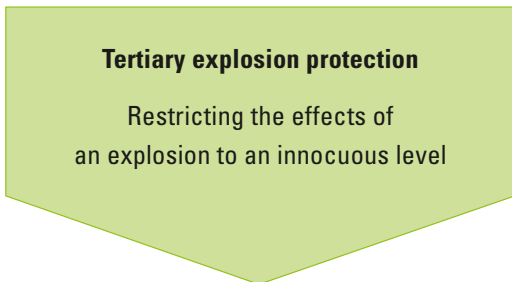
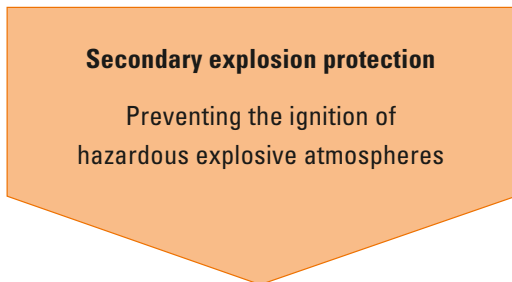
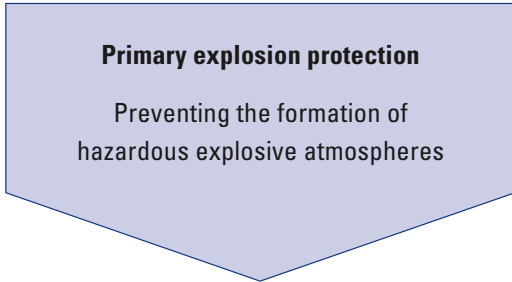

Risk diagram

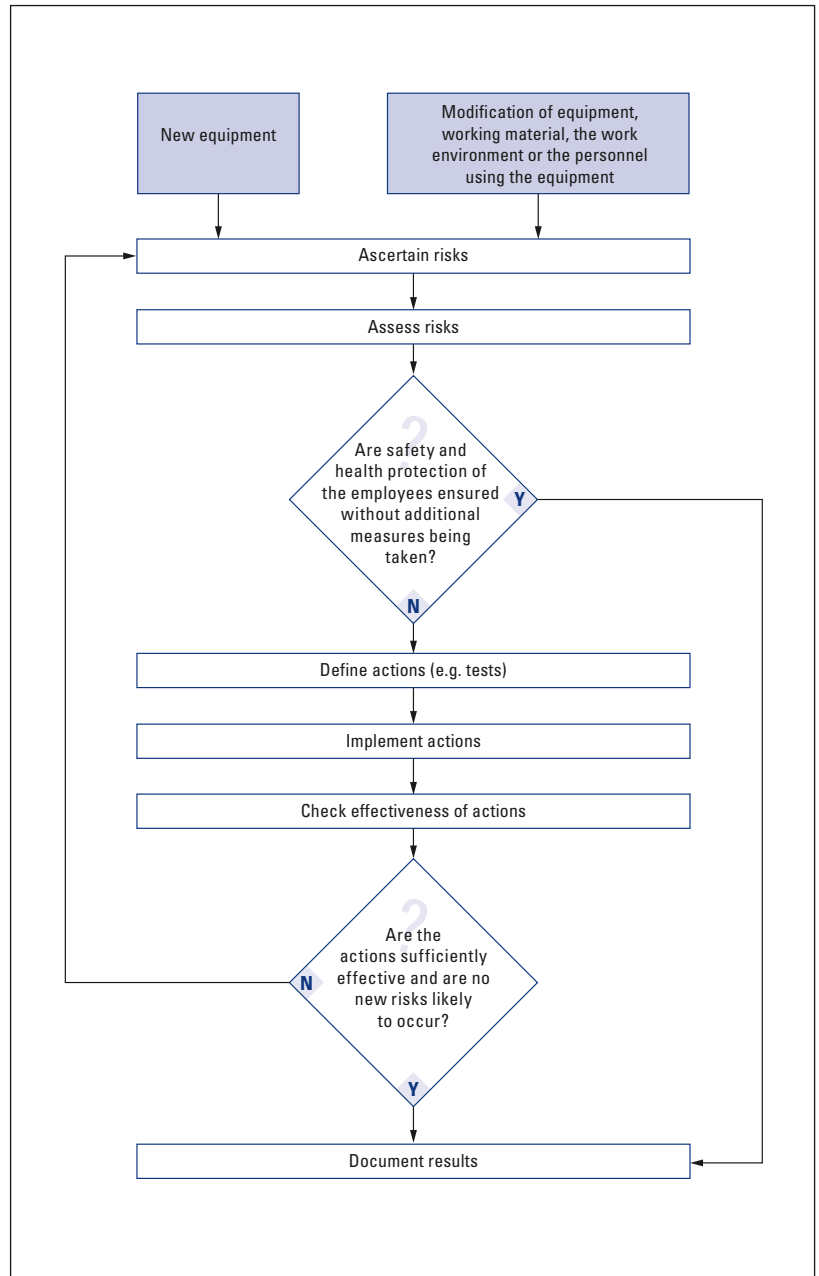

# Expertise in explosion protection

As one of the leading manufacturers of explosion-proof lifting and crane technology, STAHL CraneSystems offers a broad and complete portfolio of products as well as comprehensive services in this field. Explosion-protected products from STAHL CraneSystems meet not only German national laws and European ATEX directives but also international standards and laws for the American and Asian market. For example, all products are certified both to ATEX and IECEx.

Our product types are certified after passing an EC prototype test and undergo the conformity assessment procedure specified in the directives. Development and manufacture of the series products are subject to our strict quality management monitored by independent European inspection authorities. The test certificates from the notified European inspection authorities are recognised throughout the EU. The rating plates indicate in addition to the usual data (manufacturer,

type, serial number, electrical data) the data relevant to explosion protection. CE marking of the products, declaration of conformity in writing and detailed operating instructions and documentation confirm that all valid EU directives applicable to the apparatus are observed.

Decades of experience in the field of explosion protection, responsible, expert staff and production in accordance with the latest directives and standards guarantee quality down to the last detail for every piece of explosion-protected equipment from STAHL CraneSystems.



**Specific marking of explosion-protected devices (current marking, examples)**

CEN/CENELEC/IEC	Ex	mb	IIB	T4	Gb			
	Symbol for explosion protection				(as required) EPL (equipment protection level): <b>G</b> – gas <b>D</b> – dust <b>a</b> – very high safety level <b>b</b> – high safety level <b>c</b> – extended safety level			
	Types of protection: Ignition source monitoring – <b>b</b> Constructional safety – <b>c</b>   Flameproof enclosure – <b>d, db</b> Increased safety – <b>eb, ec</b>   Intrinsic safety – <b>ia, ib, ic</b> Liquid immersion – <b>k</b>   Encapsulation – <b>ma, mb</b> Type of protection: <b>nC</b> – <b>nCc, nRc</b>   Oil immersion – <b>ob</b> Pressurised enclosure – <b>p, pxb, pyb, pzc</b> Powder filling – <b>qb</b>   Protection by housing – <b>ta, tb, tc</b>							Gas: temperature classes – max. surface temperature <b>T1</b> – 450 °C <b>T3</b> – 200 °C <b>T5</b> – 100 °C <b>T2</b> – 300 °C <b>T4</b> – 135 °C <b>T6</b> – 85 °C  Dust: specification of max. surface temperature in °C (as required)
	Gas group: e.g. propane – <b>IIA</b> e.g. ethylene – <b>IIB</b> e.g. hydrogen – <b>IIC</b>		Dust group: combustible flakes – <b>IIIA</b> non-conductive dust – <b>IIIB</b> conductive dust – <b>IIIC</b>					

ATEX (EU directive 2014/34/EU)	CE	⊕	II	2	G
	CE marking				Type of explosive atmosphere for Group II
	Explosion protection symbol				<b>G</b> Gases, vapours, mists <b>Zone 0, 1, 2</b>
	Equipment group: mining – <b>I</b> Other potentially explosive atmospheres – <b>II</b>				<b>D</b> Dust <b>Zone 20, 21, 22</b>
	Equipment category for Equipment Group II:*		very high safety level – <b>1</b> high safety level – <b>2</b> normal safety level – <b>3</b>		

\* for Equipment Group I: **M1, M2**

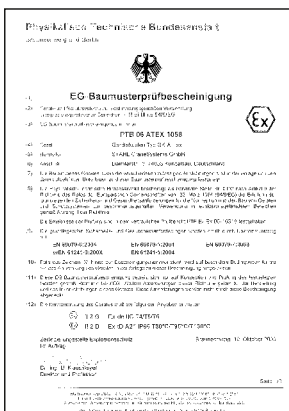

**Operating instructions – contents  
in accordance with IEC/EN 60079-0**

Commissioning
Use
Installation and dismantling
Maintenance
Electrical installation
Electrical parameters
Particular conditions

# The danger points

In lifting, drive and control technology both electrical and non-electrical components and parts can trigger an explosion. STAHL CraneSystems therefore offers apparatus specially designed for use in areas subject to gas or dust explosion hazard. All hoists and crane components without exception are from our own production, from motor and brake to controls and switchgear, and meet the latest European (ATEX) and international (IECEX) construction and safety regulations for potentially explosive atmospheres.

## 1 Wheels



The type of protection of all wheels is constructional safety »c«. If travel speeds are high, this also includes brass wheels.

## 2 Rope guide/chain guide

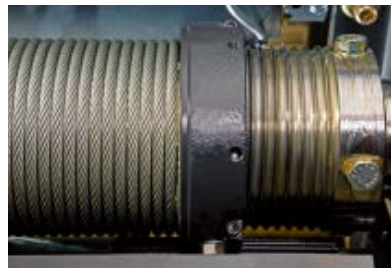

The wear-resistant rope guide in nodular graphite casting GJS (previously designated GGG) is extremely durable and not subject to temperature limitations. The same applies to the chain guide, type of protection used: constructional safety »c«.

## 3 Gear



The types of protection of the gear are constructional safety »c« and liquid immersion »k«. The protective liquid (oil) prevents sparks.

## 4 Equipotential bonding



Equipotential bonding is essential for avoiding incendive sparks when installing crane technology in potentially explosive atmospheres.

## 5 Overload cut-off



The overload cut-off operates with a dual channel load sensor supplying analog signals. Various sensors are used depending on reeving (LCD, LSD).

## 6 Panel box



The type of protection for panel boxes for Zone 1, 2 and 21 on cranes and hoists combines types of protection flameproof enclosure »d«, increased safety »e« and protection by housing »tD«.

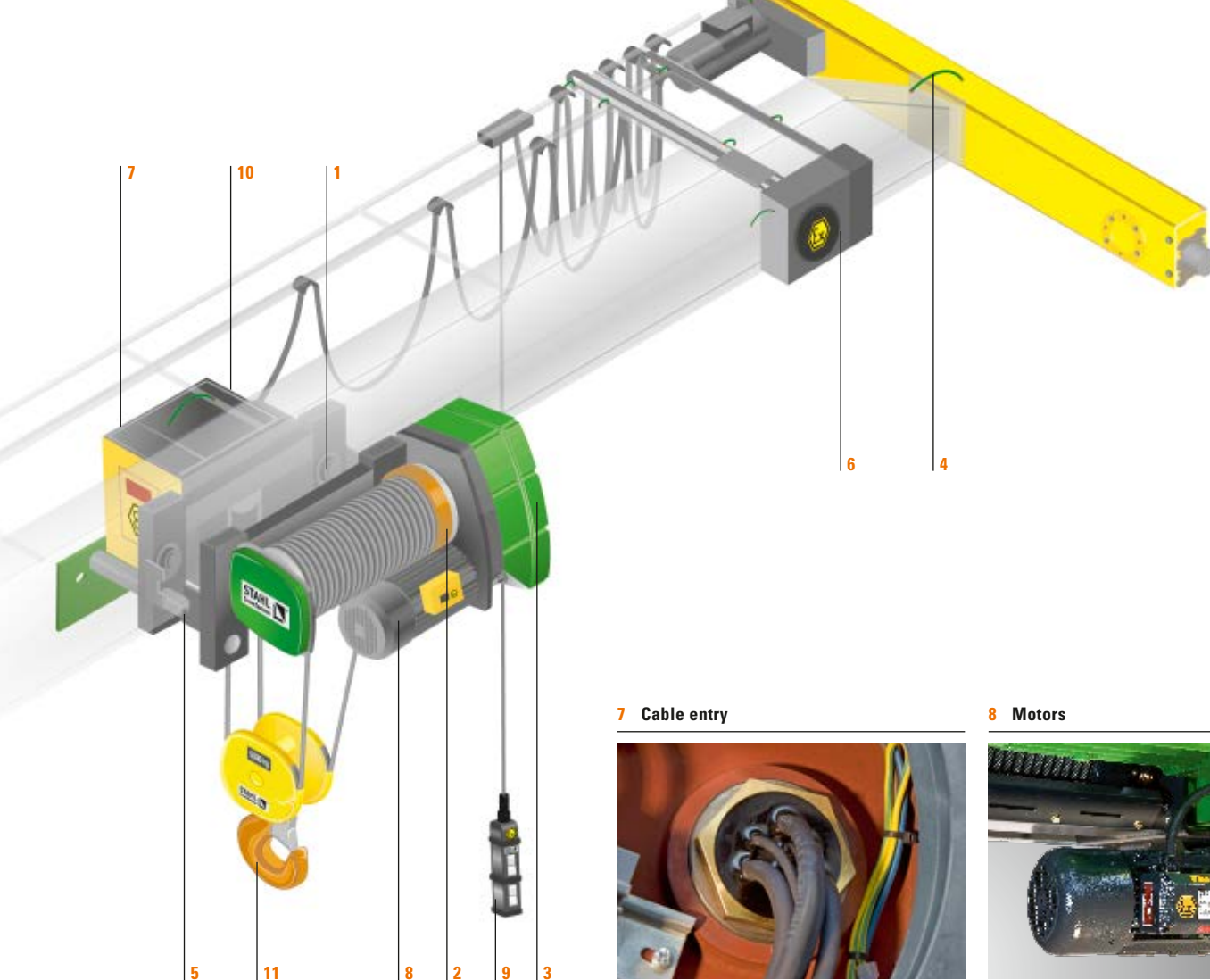

**7 Cable entry**



Indirect cable entry, very high safety level from type of protection increased safety »e« and flameproof enclosure »d«. Connection of the Ex e connection box to Ex d by post-type bushing.

**8 Motors**



Motors for Zone 1 and 21 are made of grey cast iron, the type of protection combines flameproof enclosure »d«, increased safety »e« and protection by housing »tD«. For Zone 2 the motors are made of aluminium and in type of protection non-sparking equipment »nA«. For Zone 22 the motors are manufactured in IP 66 and protection by housing »tD«.

**9 Control pendant**



The two-step SWH Ex control pendants in IP 66 protection are used on explosion-protected wire rope hoists for Zone 1.

**10 Gear limit switch**



The protection class of the gear limit switch is IP 66. The elements installed are protected by flameproof enclosure »d«, the housing by increased safety »e«.

**11 Bottom hook block**



The type of protection employed is constructional safety »c«, no aluminium is used. If travel speeds are high, individual parts, such as the load hook, are bronze-coated.

# Explosion-protected wire rope hoists

The SH Ex and AS 7 Ex explosion-protected wire rope hoists from STAHL Crane-Systems meet the European product directive 2014/34/EU (ATEX 95) and the international IECEx regulations. They are constructed for use in Zone 1 or Zone 21, however they can also be used in Zone 2 or Zone 22.

These adaptable wire rope hoists are of systematically modular construction and designed for a load capacity range of 1,000 kg to 160,000 kg. For the load capacity range of 1,000 kg to 25,000 kg the versatile SH Ex series is available in five frame sizes with 15 load capacity brackets. The upper load capacity range up to 100,000 kg is covered by the field-proven AS 7 Ex and AS 7 Ex ZW series.

The attractive design of STAHL CraneSystems' wire rope hoists conceals a compact, robust construction which is largely low-maintenance. They are extremely reliable and have a longer-than-average service life. Common to all of them is the particularly smooth precise starting and braking characteristic.

The SHW Ex winch programme is available on request for the high-load bracket up to 160,000 kg.

## The facts

- Condition monitoring apparatus in explosion-protected design ensures safe operation
- Electronic motor and brake management guarantees a long service life
- Most comprehensive explosion-protected wire rope hoist programme for the load capacity range from 500 kg to 160,000 kg
- Equipped as standard with two hoisting and two travelling speeds
- High ISO classification according to FEM/ISO standards

## ISO classifications according to FEM/ISO standards

Type	Reeving	Load capacity [kg]																	
		1,000	1,250	1,600	2,000	2,500	3,200	4,000	5,000	6,300	8,000	10,000	12,500	16,000	20,000	25,000	32,000	40,000	50,000
SH 3	2/1, 4/2	3m	2m	2m															
	4/1				3m	2m	2m												
SH 4	2/1, 4/2			3m	2m	2m	1Am												
	4/1						3m	2m	2m	1Am									
SH 5	2/1, 4/2						3m**	2m	2m	1Am									
	4/1									3m	2m	2m	1Am						
SHR 6	2/1							2m	2m	1Am									
	4/1										2m	2m	1Am						
SH 6	2/1									3m	2m	1Am							
	4/1												3m	2m	1Am				
	4/2									2m	2m	1Am							
AS 7	2/1											3m	2m	1Am	1Bm*				
	4/1														3m	2m	1Am	1Bm*	

\* for Zone 2, 22 only \*\* with 2/1 reeving, for Zone 1, 21 only



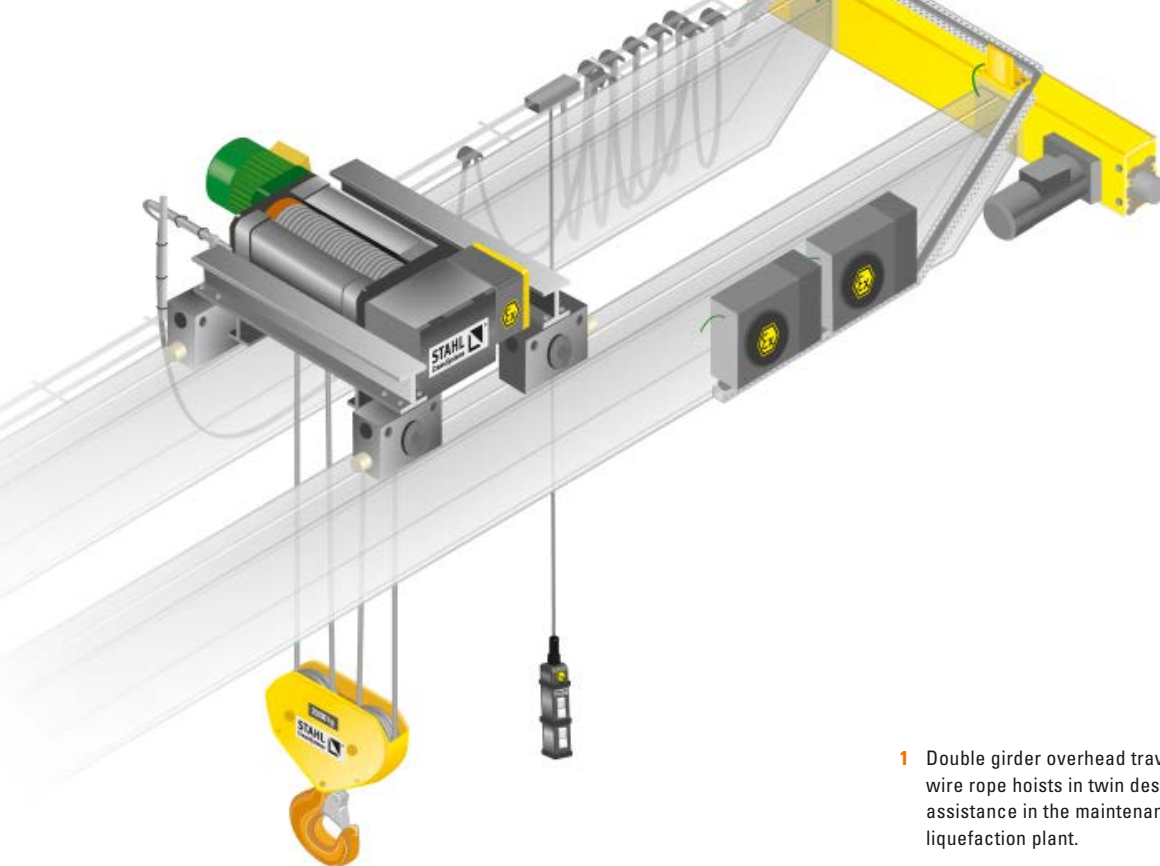

- 1 Double girder overhead travelling cranes with explosion-protected wire rope hoists in twin design and auxiliary hoist provide assistance in the maintenance of compressors in a hydrogen liquefaction plant.
- 2 SH Ex wire rope hoists are available for Zone 1 and Zone 2, and for Zone 21 and Zone 22. They reliably meet the technical, normative and practical requirements specified by ATEX and IECEx.



1

2

Use	Category	Protection against	Explosion protection class
<b>Zone 1</b>	Ex II 2 G	Gas	Ex de eb IIB T4 Gb or Ex de eb IIC T4 Gb
<b>Zone 2</b>	Ex II 3 G	Gas	Ex de eb nA IIB T3 (T4) Gc or Ex de eb nA IIC T3 (T4) Gc
<b>Zone 21</b>	Ex II 2 D	Dust	Ex tb IIIC T 120°C Db
<b>Zone 22</b>	Ex II 3 D	Dust	Ex tc IIIC T 120°C Dc



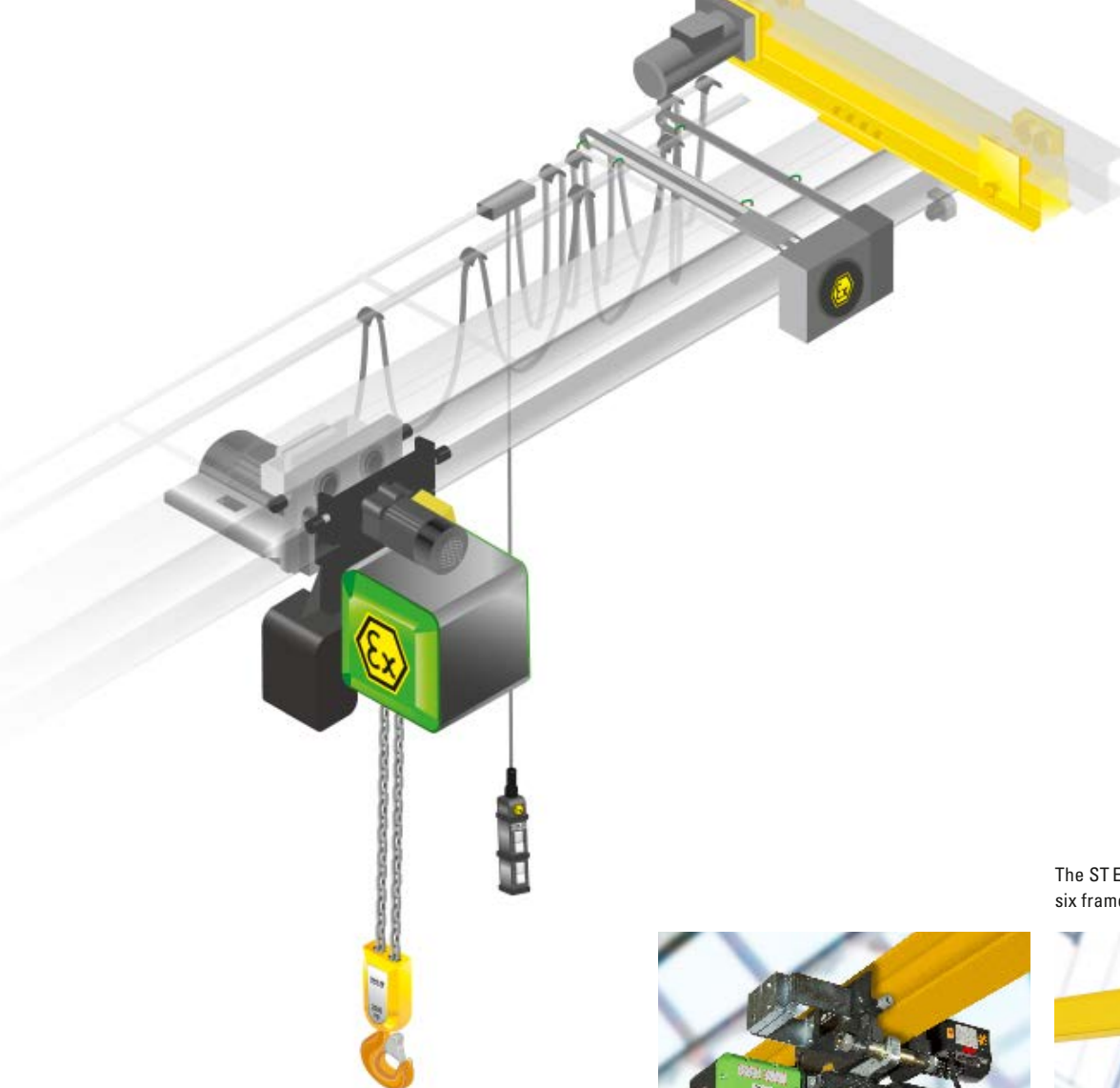

The ST Ex chain hoist for Zone 22 is available in six frame sizes up to a load capacity of 6,300 kg.



The ST Ex chain hoist for Zone 1 and Zone 21 is available in two frame sizes up to a load capacity of 5,000 kg.



Use	Category	Protection against	Explosion protection class
<b>Zone 1</b>	Ex II 2 G	Gas	Ex de eb IIB T4 Gb or Ex de eb IIC T4 Gb
<b>Zone 21</b>	Ex II 2 D	Dust	Ex tb IIIC T 120°C Db
<b>Zone 22</b>	Ex II 3 D	Dust	Ex tc IIIC T 120°C Dc

# Components and electrics

The components and electrics, which also meet the European product directive 2014/34/EU (ATEX 95) and the international IECEx regulations, are the perfect complement to explosion-protected lifting technology from STAHL CraneSystems.

The correct functioning and high performance of a crane system depend on the quality of all its components. These are developed down to the last detail by STAHL CraneSystems and supplied from our own production. Forward-looking, high-quality modules complement one another in the system and ensure both safety and cost-effectiveness. Using the modular components, our crane manufacturing partners in your region are able to adapt the crane system individually to customer-specific requirements and wishes. Mature, cost-effective electronics, drive technology to meet the highest demands, innovative modules and field-proven, robust standard components are available for these adaptations. The expert crane manufacturing partners and experienced system manufacturers are trained by STAHL CraneSystems' explosion protection experts so that they are always up to date as regards the status of national and international regulations and state-of-the-art technology.

## Bottom hook block



For high and very high travelling speeds the load hook and the solid parts of potential impact surfaces are bronze-coated. In addition, all other exterior surfaces of the bottom hook block can be bronze-coated to prevent sparking.

<b>Explosion-protected endcarriages</b>	for single girder overhead travelling cranes, 7 wheel diameters and 5 wheelbases
	for double girder overhead travelling cranes, 7 wheel diameters and 6 wheelbases
	for single girder underhung cranes, 4 wheel diameters and 3 wheelbases
<b>Explosion-protected drive technology</b>	Supplied as standard with 2-step speeds 20/5 m/min or 40/10 m/min, other speeds on request
	As an option, stepless speed control
<b>Explosion-protected control technology</b>	SWH 5 Ex wired control pendant
	Panel box in explosion-protected design
<b>Explosion-protected electrics</b>	Festoon cables in conjunction with control pendants or radio remote controls

### Panel box



Flameproof enclosure for Zone 1 and Zone 2: the sheet steel or aluminium housings can be used as individual housings or in combination. All components required such as transformers, contactors, fuses, measuring instruments and tripping devices can be installed in the modular-design housing. Post-type bushings provide the connection to the terminal box (in increased safety Ex e).

### Travel drive



The explosion-protected travel drives Zone 1 and Zone 21 are designed for intermittent operation. They have a sliding rotor motor with conical brake and centrifugal mass for smooth starting and braking characteristics. All motors are pole-changing providing two travel speeds. The particularly quiet gear requires little maintenance thanks to its long-term oil bath lubrication.

### Crane endcarriages



Crane systems up to a safe working load of 50,000 kg and a span of 30 m can be built with explosion-protected endcarriages for underhung and overhead travelling cranes. For particular applications, at customers' request and for increased safety all wheels can be supplied in brass.

### Control pendants



The SWH 5 Ex control pendants are designed specifically for controlling hoists and cranes in hazardous areas. Activation is generally 2-step and permits a quick changeover from 'fast' to 'slow' and vice versa. All control pendants are equipped with an EMERGENCY STOP slam button meeting the requirements of IEC/EN 60947-5-5.

# The engineering

Engineering means innovation and individuality. Constantly redefining the lifting and transporting of loads for complex requirements even in explosive areas is a job for our experts. From one of the widest product ranges of standard components they regularly develop modern, individual explosion-protected customised solutions which meet all national and international directives and laws. The whole portfolio and all customised solutions are available in explosion-protected designs for Zone 1, Zone 2, Zone 21 and Zone 22.

Hardly any other manufacturer of lifting and crane technology can offer you this diversity of precisely designed explosion protection solutions in the highest quality and cost-effectiveness. Our products rank among the safest technology, in particular in the chemical, petrochemical and pharmaceutical industries, the food processing industry, power supply, shipbuilding, offshore and natural gas liquefaction industries (LNG).

## The facts

- Perfectly matched to your product
- Every hoist is the result of over 140 years of experience and expertise
- Short development time
- Cost-effective thanks to modular system
- Technically mature thanks to the use of field-proven standard components
- High quality and reliability ensured by in-house production in Germany



## LNG

The LNG hoists from STAHL CraneSystems are designed especially for maintenance work on liquefied natural gas (LNG) tanks. Thanks to the high-quality components, robust construction, corrosion-resistant paint and extensive additional equipment they are optimally suited for use in coastal areas with challenging climate conditions. The pumps in the tanks, which pump the liquefied natural gas into a pipe system at temperatures of  $-164^{\circ}\text{C}$  to  $-161^{\circ}\text{C}$ , have to be lifted out of the 70 m high tanks and transported to the exterior up to five times a year for maintenance. The extreme conditions prevailing in the tank necessitate off-standard ropes permanently connected to the liquefied natural gas pump and remaining constantly in the tank. These ropes are attached to the rope drum and the hoist for maintenance work.

STAHL CraneSystems' LNG hoists are available in four safety levels, from Level 1 with increased safety to Level 2 with two rope drums running in parallel, Level 3A with redundantly built hoist and Level 3B with additional floating, spring-loaded suspension. STAHL CraneSystems' LNG hoists in Level 3B are regarded as the safest explosion-protected hoists currently on the market.

The experts in our engineering department develop these customised hoists for crane manufacturers and EPC contractors to meet their individual requirements, specifications, quality standards and national regulations.

## The facts

- Sophisticated engineering ideally adapted to your project
  - Technically mature, using fieldproven standard components
  - International specialist for explosion-protected hoist and crane technology
  - Our own production with certified quality assurance
  - All customised solutions certified to ATEX directives or IECEx regulations
  - Partner for official international procedures
  - Full documentation
- ➔ For more information, visit [www.stahlcranes.com](http://www.stahlcranes.com) or ask for our brochure "The LNG engineering solution", which we will gladly send to you by post.

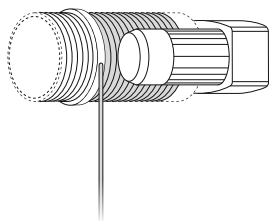

Safety Level 1

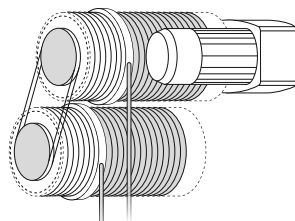

Safety Level 2

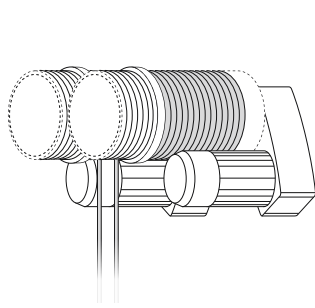

Safety Level 3A

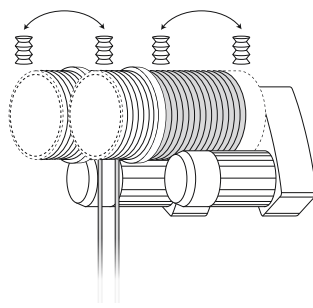

Safety Level 3B



## The support

Quality right down to the most minor detail is the standard STAHL CraneSystems is committed to. Not only in the field of crane technology, but also on the subject of support. You will find lifting and crane technology from STAHL CraneSystems all around the world. Developed by engineers and experts, manufactured with maximum care following our well-known standard of quality. All around the world, many companies from various fields have decided on maximum safety and quality, on products from STAHL CraneSystems.

When it comes to sales, we are committed exclusively to capable, professional crane manufacturing partners. You can expect optimum support from them when your individual crane system with components from STAHL CraneSystems is at stake. Consulting and erection of a new system, system-oriented testing and maintenance, modernisation, spare parts supply and training courses. Together with our subsidiaries and crane manufacturing partners we offer you perfectly coordinated support all over the world.







### **Spare parts – available around the clock**

Our own subsidiaries and numerous partners around the world ensure a reliable supply of spare parts and expert assistance in your area. Even decades after a series has been discontinued, spare parts are available all over the world around the clock.



### **Training courses**

We constantly keep our regional crane manufacturing partners up to date with training courses, seminars and information material. And you too as end customer can profit directly from our expertise. We impart practical and theoretical knowledge in our own training centre or on your premises. The seminars on offer in the form of individual, basic and advanced courses cover all main product groups. However, we would also be pleased to develop a special programme for your individual specifications and requirements.

You can find our current seminar programme at [www.stahlcranes.com/en/support](http://www.stahlcranes.com/en/support)



### **Factory service centre – on duty around the world**

Our factory service centre is a service for our customers: wherever you are, we assist your crane or systems manufacturer and your technicians with our experience and expertise whenever needed. Modern diagnostic apparatus and condition monitoring systems stand by to support professional service and maintenance work. Not only you, but also your system are in safe hands. You can rely on us.

You can reach our factory service centre at [customer.service@stahlcranes.com](mailto:customer.service@stahlcranes.com)



### **MarketingPortal plus – our online support**

At [mplus.stahlcranes.com](http://mplus.stahlcranes.com) you can view or download the most important information quickly and conveniently: brochures, product information, technical documents, illustrations and much more.



# On the spot and in action all around the world



1 The explosion-protected tandem crane with two SH wire rope hoists and radio remote control is used in the construction of a compressor station for a natural gas pipeline. Both SH 40 Ex wire rope hoists are designed for safe working loads of 3,200 kg and meet the ATEX directives as regards design and safety.

2 An explosion-protected ST 20 chain hoist with a safe working load up to 1,600 kg is used for maintenance work outdoors in a chemical plant. The narrow design of the explosion-protected chain hoist enables the whole width of the crane bridge to be utilised. The underhung crane endcarriages are naturally also explosion-protected.

3 The portal crane with two explosion-protected SH wire rope hoists and a total safe working load of 5 t is used in the large-scale refinery of a petrochemical company. It transports residual materials containing sulphur, oxygen and nitrogen which are generated when processing crude oil.



4 Special LNG hoists are used for maintenance work on the pumps of liquid gas tanks. The wire rope hoists have two separately driven rope drums with safe working loads of 2,400 kg. An additional small slewing crane is equipped with an SH 30 Ex wire rope hoist and is used as an auxiliary crane for transporting tools and components onto the tank's platform.



### In action all around the world

You will find explosion-protected lifting and crane technology from STAHL CraneSystems all around the world. Our universally connected network of subsidiaries and partners enables us to be directly in your vicinity and yet to act globally. We would like to list here just a few of the companies which have decided on maximum safety and quality, on products from STAHL CraneSystems.

#### Europe

ABB Lummus Global GmbH, Germany
ABB Lummus Global GmbH, Spain
AkerKvaerner (Houston, USA), Italy
Borealis, Germany
BP CHEMBEL N.V., Belgium
Cobra Plantas Industriales, Spain
Eastern Petrochemical Co (Linde), Germany
Fluor, Germany
Fluor Daniel B.V., Norway
Fluxys Refinery, Belgium
Intecsa Industrial, Spain
Jacobs Engineering, Germany
Motor Oil (Hellas) Refineries Corinth, Greece
OMV Burghausen, Germany
Repsol Petroleo S.A. Petronor, Spain
Repsol YPF/Petronor, Spain
Sagas, Spain
Saipem S.A. (Technigas), Belgium
Scanraff Refinery (PREEM), Sweden
Sparrows Offshore Services Ltd, Great Britain
Statoil, Norway
Technip, Belgium
Ticona, Germany
Total Refinery (Antwerp), Belgium
Turkiye Petrol Rafinerileri A.S., Turkey
voestalpine AG (Linz), Austria

#### Asia

Alla Co., Thailand
Daelim Engineering Co., Iran
Ethylene Malaysia Sdn Bhd, Malaysia
Formosa Plastics Corporation, Taiwan
Foster Wheeler, Malaysia
GS Engineering and Construction Corp., Thailand
Hercules Chemical (Nanjing) Co., Ltd, China
Jacobs Engineering, Singapore
JGC Corporation (Japan), Oman
Kuwait National Petroleum Co., Kuwait
MAN Ferrostaal Essen, Oman
MaisonWorleyParsons (Shanghai), China
Mitsubishi Heavy Industries, Brunei
PT Wirya Krenindo Perkasa, Indonesia
Qatar Petroleum Dolphin Energy Co., U.A.E.
Ras Laffan Olefins Company Limited (RLOC), Qatar
Samsung, Saudi Arabia
Saudi Petrochemical Company, Saudi Arabia
SembCorp Simon Carves (UK), China
Singapore Refining Co., Ltd (SRC), Singapore
Sparrows Offshore Services Ltd., Azerbaijan
Technip France (Paris), Qatar
The Kuwait Olefins Company (TKOC), Kuwait
ToyoThai (Bayer BPA, Thailand), Thailand

#### Africa

BP Exploration, Algeria
Cullum Detuners Limited, Nigeria
El Djazairia El Omania Lil Asmdia SpA, Algeria
Mitsubishi Heavy Industries, Algeria
Mobil, Nigeria
Tecnicas Reunidas (Spain), Algeria
TFT Argelia, Algeria
<b>North America</b>
AKER Kvaerner Contracting, USA
Noble Drilling, USA
<b>South America</b>
Atlas Methanol Company, Trinidad and Tobago
Ferrostaal (Germany), Trinidad and Tobago
HDT-HCK UTE, Chile
KÜTTNER, S.A. (Germany), Mexico
UTE Coker Aconcagua I, Chile
<b>Australia</b>
Kellogg Joint Venture, Australia
Woodside Energy Ltd., Australia



Argentina Australia Austria Belgium Brazil Canada Chile **China** Columbia Croatia Czech Republic  
Denmark Ecuador Egypt Estonia Finland **France** Germany **Great Britain** Greece Hongkong Hungary **India** Indonesia

Ireland Israel Italy Jordan Latvia Lebanon Lithuania Malaysia Mexico  
Netherlands Nigeria Norway Pakistan Peru Philippines Poland **Portugal** Rumania Russia

**Singapore** Slovakia Slovenia South Africa South Korea **Spain** Sweden Syria  
Taiwan Thailand Turkey **UAE** Uruguay **USA** Venezuela Vietnam

Sales partners **Subsidiaries**

You can find this and other brochures at [www.stahlcranes.com/download](http://www.stahlcranes.com/download). We will gladly also send them to you by post.

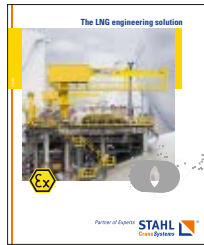
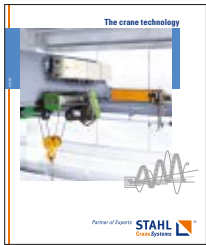
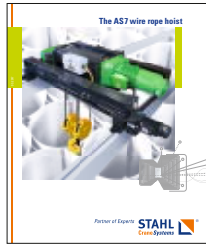

Presented by

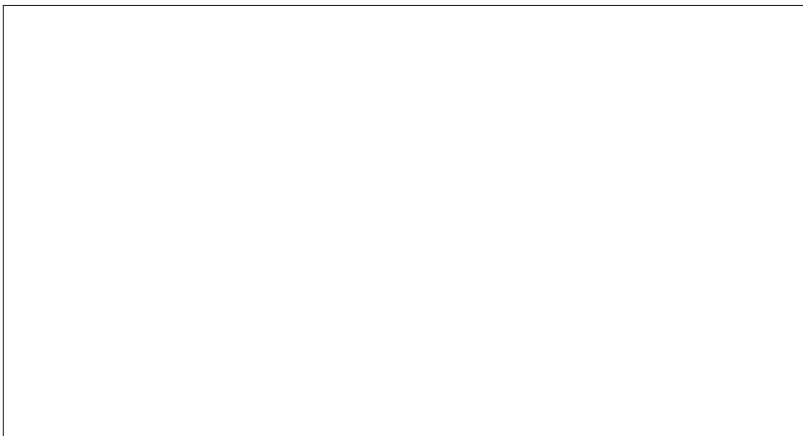

STAHL CraneSystems GmbH  
Daimlerstr. 6, 74653 Künzelsau, Germany  
Tel +49 7940 128-0, Fax +49 7940 55665  
[marketing.scs@stahlcranes.com](mailto:marketing.scs@stahlcranes.com)  
[www.stahlcranes.com](http://www.stahlcranes.com)

a member of COLUMBUS MCKINNON CORPORATION

Partner of Experts



All specifications and illustrations are non-binding. Subject to modification, errors and printing errors excepted. Printed in Germany 990 0640 EN-10.20 visuell.de