

Exploring Solar Energy

Student Guide

(Seven Activities)

Grades: 5-8

Topic: Solar

Owner: NEED

EXPLORING SOLAR ENERGY Student Guide

Name: _____

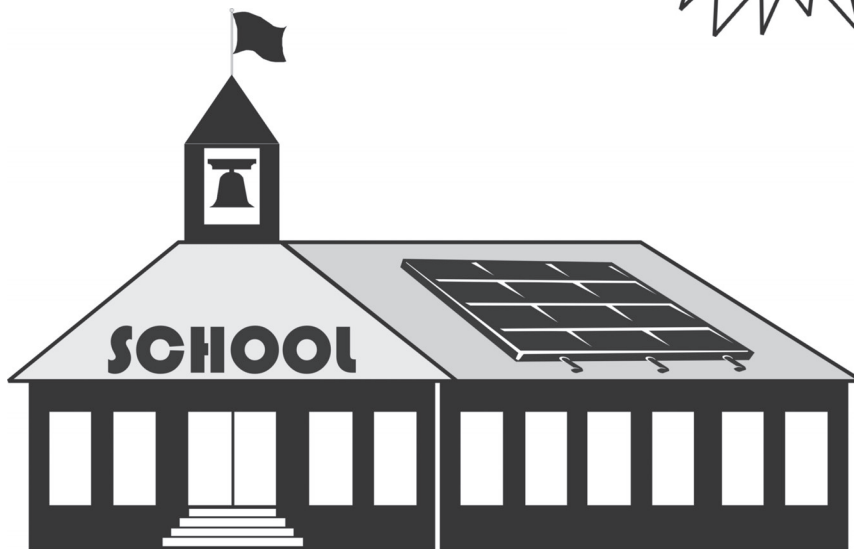
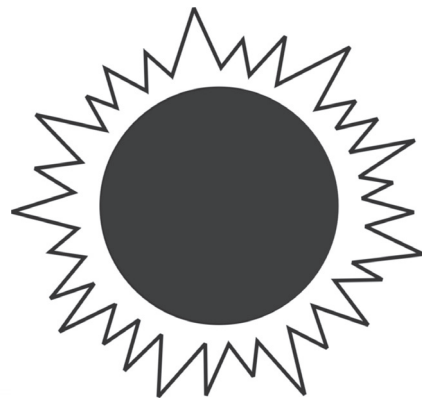

Putting Energy into Education

NEED Project PO Box 10101 Manassas, VA 20108 1-800-875-5029 www.NEED.org

WHAT IS SOLAR ENERGY?

Every day, the sun radiates (sends out) an enormous amount of energy. It radiates more energy in one second than the world has used since time began. This energy comes from within the sun itself. Like most stars, the sun is a big gas ball made up mostly of hydrogen and helium atoms. The sun makes energy in its inner core in a process called **nuclear fusion**.

During nuclear fusion, the high pressure and temperature in the sun's core cause hydrogen (H) atoms to come apart. Four hydrogen nuclei (the centers of the atoms) combine, or **fuse**, to form one helium atom. During the fusion process, radiant energy is produced.

It takes millions of years for the radiant energy in the sun's core to make its way to the solar surface, and then just a little over eight minutes to travel the 93 million miles to earth. The radiant energy travels to the earth at a speed of 186,000 miles per second, the speed of light.

Only a small portion of the energy radiated by the sun into space strikes the earth, one part in two billion. Yet this amount of energy is enormous. Every day enough energy strikes the United States to supply the nation's energy needs for one and a half years. About 15 percent of the radiant energy that reaches the earth is reflected back into space. Another 30 percent is used to evaporate water, which is lifted into the atmosphere and produces rainfall. Radiant energy is also absorbed by plants, the land, and the oceans.

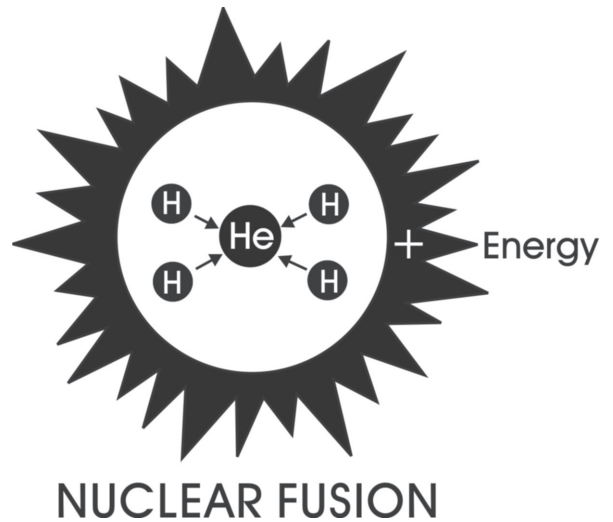

GREENHOUSE EFFECT

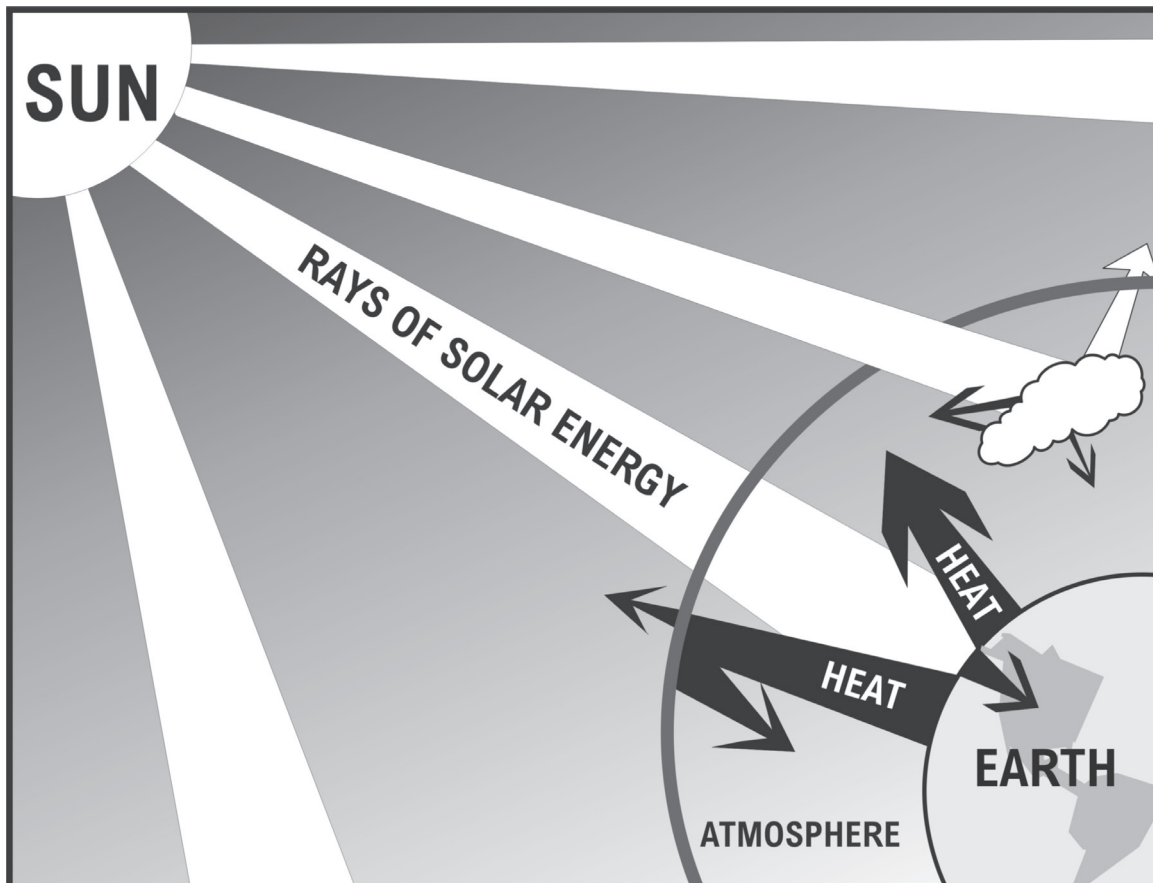

SOLAR COLLECTORS

Heating with solar energy is not as easy as you might think. Capturing sunlight and putting it to work is difficult because the solar energy that reaches the earth is spread out over a large area. The amount of solar energy an area receives depends on the time of day, the season of the year, the cloudiness of the sky, and how close you are to the earth's equator.

A **solar collector** is one way to capture sunlight and change it into usable heat energy. A closed car on a sunny day is like a solar collector. As sunlight passes through the car's windows, it is absorbed by the seat covers, walls, and floor of the car. The absorbed energy changes into heat. The car's windows let radiant energy in, but they don't let all the heat out.

SOLAR COLLECTOR

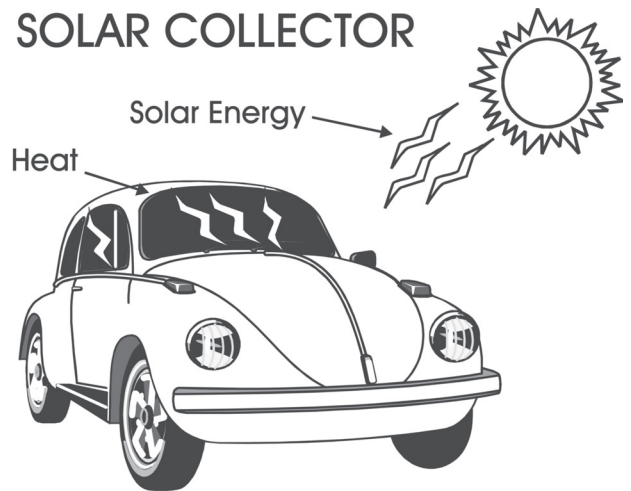

On a sunny day, a closed car is a solar collector. Solar energy passes through the glass, hits the inside of the car and changes into heat. The heat gets trapped inside.

SOLAR SPACE HEATING

Space heating means heating the space inside a building. Today, many homes use solar energy for space heating. A **passive solar home** is designed to let in as much sunlight as possible. It is like a big solar collector. Sunlight passes through the windows and heats the walls and floor inside the house. The light can get in, but the heat is trapped inside. A passive solar home does not depend on mechanical equipment, such as pumps and blowers, to heat the house.

An **active solar home**, on the other hand, uses special equipment to collect sunlight. An active solar house may use special collectors that look like boxes covered with glass. These collectors are mounted on the rooftop facing south to take advantage of the winter sun. Dark-colored metal plates inside the boxes absorb sunlight and change it into heat. (Black absorbs sunlight better than any other color.) Air or water flows through the collector and is warmed by the heat. The warm air or water is distributed to the rest of the house, just as it would be with an ordinary furnace system.

SOLAR WATER HEATING

Solar energy can be used to heat water. Heating water for bathing, dishwashing, and clothes washing is the second biggest home energy cost.

A solar water heater works a lot like solar space heating. In our hemisphere, a solar collector is mounted on the south side of a roof where it can capture sunlight. The sunlight heats water and stores it in a tank. The hot water is piped to faucets throughout a house, just as it would be with an ordinary water heater. Today, more than 1.5 million homes in the United States use solar water heaters.

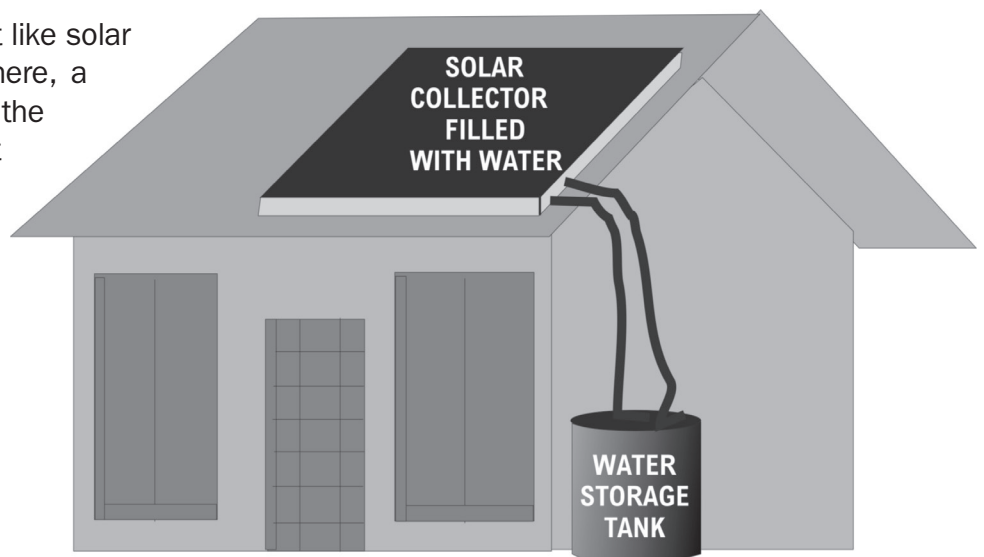

SOUTH-FACING SOLAR HOUSE

SOLAR ELECTRICITY

Solar energy can also be used to produce electricity. Two ways to make electricity from solar energy are photovoltaics and solar thermal systems.

Photovoltaic comes from the words *photo* meaning *light* and *volt*, a measurement of electricity. Photovoltaic cells are also called PV cells or solar cells for short. You are probably familiar with photovoltaic cells. Solar-powered toys, calculators, and roadside telephone call boxes all use solar cells to convert sunlight into electricity.

Solar cells are made of two thin pieces of **silicon**, the substance that makes up sand and the second most common substance on earth. One piece of silicon has a small amount of boron added to it, which gives it a tendency to attract electrons. It is called the **p-layer** because of its positive tendency. The other piece of silicon has a small amount of phosphorous added to it, giving it an excess of free electrons. This is called the **n-layer** because it has a tendency to give up electrons, a negative tendency. When the two pieces of silicon are placed together, some electrons from the n-layer flow to the p-layer and an electric field forms between the layers. The p-layer now has a negative charge and the n-layer has a positive charge.

When the PV cell is placed in the sun, the radiant energy energizes the free electrons. If a circuit is made connecting the layers, electrons flow from the n-layer through the wire to the p-layer. The PV cell is producing electricity—the flow of electrons. If a load such as a lightbulb is placed along the wire, the electricity will do work as it flows. The conversion of sunlight into electricity takes place silently and instantly. There are no mechanical parts to wear out.

Compared to other ways of producing electricity, PV systems are expensive. It costs 10-20 cents a kilowatt-hour to produce electricity from solar cells. On average, people pay about eight cents a kilowatt-hour for electricity from a power company using fuels like coal, uranium or hydropower. Today, PV systems are mainly used to generate electricity in areas that are a long way from electric power lines.

PHOTOVOLTAIC CELL

- ⊕ proton
- ⊖ tightly-held electron
- free electron
- can accept an electron

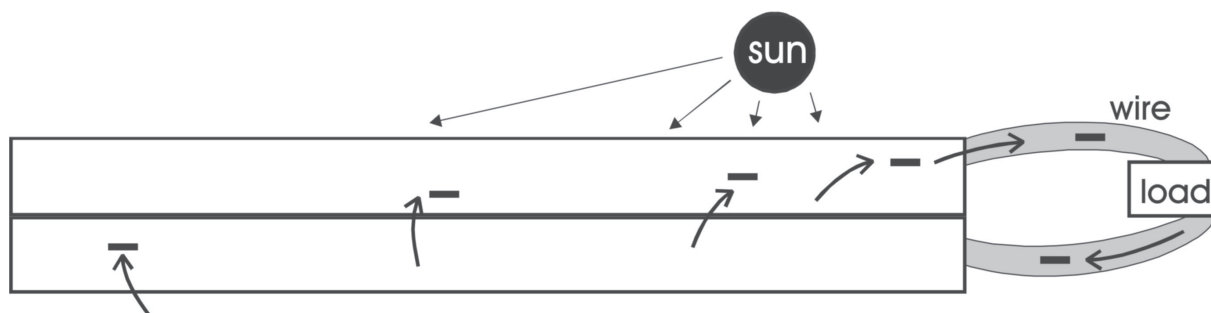
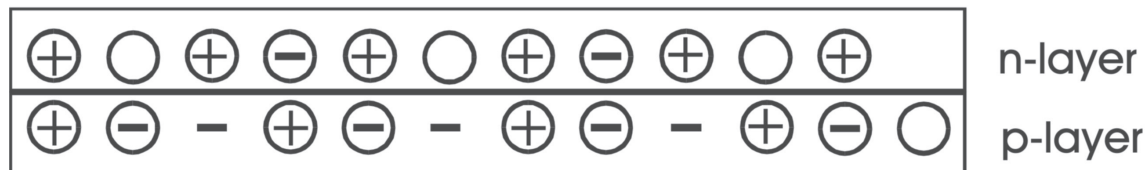

CONCENTRATED SOLAR POWER

Like solar cells, concentrated solar power systems use solar energy to make electricity. Since the solar radiation that reaches the earth is so spread out and diluted, it must be concentrated to produce the high temperatures required to generate electricity. There are three types of technologies that use mirrors or other reflecting surfaces to concentrate the sun's energy up to 5,000 times its normal intensity.

Parabolic Troughs use long reflecting troughs that focus the sunlight onto a pipe located at the focal line. A fluid circulating inside the pipe collects the energy and transfers it to a heat exchanger, which produces steam to drive a conventional turbine. The world's largest parabolic trough is located in the Mojave Desert in California. This plant has a total generating capacity of 354 megawatts, one-third the size of a large nuclear power plant.

Solar Power Towers use a large field of rotating mirrors to track the sun and focus the sunlight onto a heat-receiving panel on top of a tall tower. The fluid in the panel collects the heat and either uses it to generate electricity or stores it for later use.

Dish/Engine Systems are like satellite dishes that concentrate sunlight rather than signals, with a heat engine located at the focal point to generate electricity. These generators are small mobile units that can be operated individually or in clusters, in urban and remote locations.

Concentrated Solar Power (CSP) technologies require a continuous supply of strong sunlight, like that found in hot dry regions such as deserts. Developing countries with increasing electricity demand will probably be the first to use CSP technologies on a large scale.

Solar energy has great potential for the future. Solar energy is free and its supplies are unlimited. It does not pollute or otherwise damage the environment. It cannot be controlled by any one nation or industry. If we can improve the technology to harness the sun's enormous power, we may never face energy shortages again.

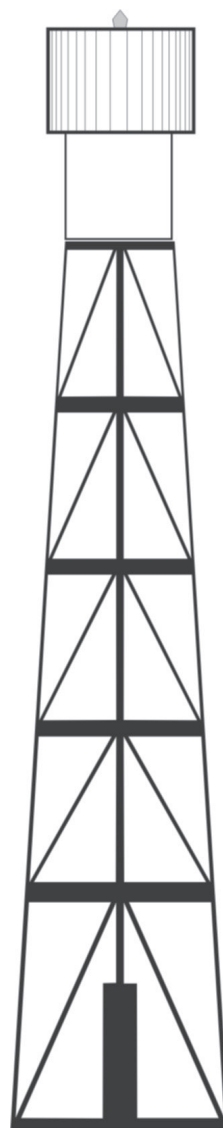

RECEIVER PANEL
has fluid inside
that collects heat.

ROTATING MIRRORS
focus sunlight
onto receiver panel.

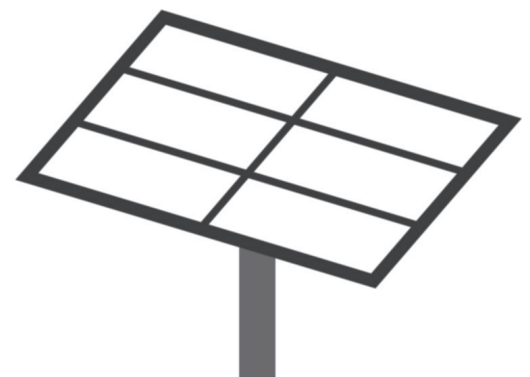

SOLAR POWER TOWER

THERMOMETER

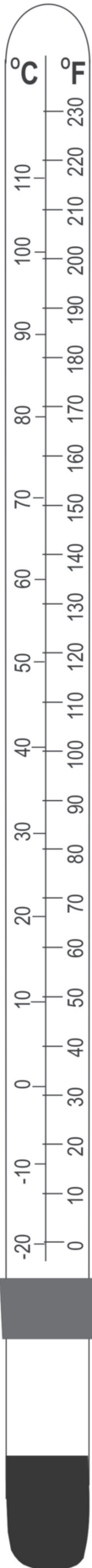

A thermometer measures temperature. The temperature of an object or a substance shows how hot or cold it is. This thermometer is a long glass tube filled with a colored liquid. Liquids expand (take up more space) as they get hotter.

Temperature can be measured using many different scales. The scales we use most are:

CELSIUS

The Celsius (C) scale uses the freezing point of water as 0°C and the boiling point of water as 100°C .

FAHRENHEIT

The Fahrenheit (F) scale uses the freezing point of water as 32°F and the boiling point of water as 212°F . Zero (0°F) on the Fahrenheit scale is the temperature of a mixture of equal weights of snow and salt.

In the United States, we usually use the Fahrenheit scale in our daily lives, and the Celsius scale for scientific work.

ANSWER THESE QUESTIONS

The temperature of the human body is $98\text{-}99^{\circ}\text{F}$. Look at the drawing of the thermometer and estimate what the reading would be on the Celsius scale:

A comfortable spring day is about 75°F . What would that reading be on the Celsius scale?

The temperature of a hot shower is about 105°F . What would that reading be on the Celsius scale?

FAHRENHEIT/CELSIUS CONVERSION

On the Fahrenheit scale, the freezing point of water is 32° and the boiling point of water is 212° - a range of 180° .

On the Celsius scale, the freezing point of water is 0° and the boiling point of water is 100° - a range of 100° .

To convert from Celsius to Fahrenheit, multiply the C number by $\frac{180}{100}$ or $\frac{9}{5}$, then add 32, as shown in the formula below.

$$F = \left(\frac{9}{5} \times C \right) + 32$$

$$\text{If } C = 5 \quad F = \left(\frac{9}{5} \times 5 \right) + 32 \quad F = 9 + 32 = 41$$

To convert from Fahrenheit to Celsius, subtract 32 from the F number, then multiply by $\frac{100}{180}$ or $\frac{5}{9}$ as shown in the formula below.

$$C = \frac{5}{9} \times (F - 32)$$

$$\text{If } F = 50 \quad C = \frac{5}{9} \times (50 - 32) \quad C = \frac{5}{9} \times 18 = 10$$

PROBLEMS TO ANSWER:

If C is 50° , what is the temperature in Fahrenheit?

If F is 100° , what is the temperature in Celsius?

RADIATION CANS

When radiant energy hits objects, some of the energy is reflected and some is absorbed and converted into heat. Some objects absorb more radiant energy than others.

PURPOSE: To explore the conversion of radiant energy into heat.

- Step 1: Put thermometers into the black and silver cans and position the stoppers so they are not touching the bottom of the cans. Record the temperatures of both cans.
- Step 2: Place the cans in a sunny place. Predict what will happen. Record the temperatures after five minutes.
- Step 3: Open the cans and allow the air inside to return to the original temperature.
- Step 4: Place the cans in a bright artificial light, such as an overhead projector. Predict what will happen. Record the temperature of both cans after five minutes.
- Step 5: Fill both cans with 200 ml of cold water and record the temperatures.
- Step 6: Place the cans in a sunny place. Predict what will happen. Record the temperatures after five minutes.
- Step 7: Fill both cans with 200 ml of hot water and record the temperatures.
- Step 8: Place the cans in a sunny place. Predict what will happen. Record the temperatures after five minutes.

RECORD THE DATA

	AIR						COLD WATER				HOT WATER			
	Original		In the Sun		In the Light		Original		In the Sun		Original		In the Sun	
	C	F	C	F	C	F	C	F	C	F	C	F	C	F
BLACK CAN														
SILVER CAN														

CONCLUSIONS: Look at your data. What have you learned about converting radiant energy into heat? About reflection and absorption of radiant energy?

- 1. Silver and black cans:
- 2. Solar and artificial light:
- 3. Air and water:
- 4. Cold and hot water:

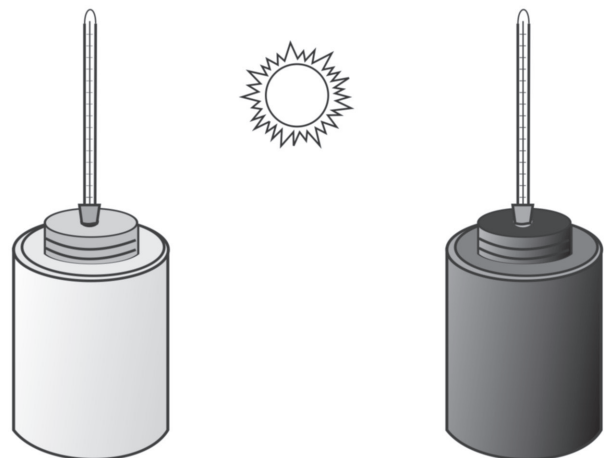

SOLAR CONCENTRATION

Concave mirrors can be used to collect solar radiation and concentrate it on an object.

PURPOSE: To explore the concentration of solar radiation.

Step 1: Fill the silver and black radiation cans with 200 ml of cold water.

Step 2: Put thermometers into the cans and position the stoppers so that the thermometers are not touching the bottoms of the cans. Place the cans in a sunny place.

Step 3: Position the mirrors:

Group A: The control without mirrors.

Groups B & C: Position one concave mirror behind each can so that the mirrors focus sunlight onto the cans. The mirrors should be about seven centimeters (7 cm) from the cans. Use pieces of clay to hold the mirrors in the correct position.

Groups D & E: Position two concave mirrors behind each can as described above.

Step 4: Record the temperature of the water in all the cans. Predict what will happen.

Step 5: Record the temperatures of the water in the cans after five minutes.

RECORD THE DATA

	WITHOUT MIRRORS				WITH 1 MIRROR				WITH 2 MIRRORS				
	Original		5 min		Original		5 min		Original		5min		
	C	F	C	F	C	F	C	F	C	F	C	F	
BLACK CAN													
SILVER CAN													

CONCLUSIONS: Look at your data. What have you learned about concentrating solar radiation?

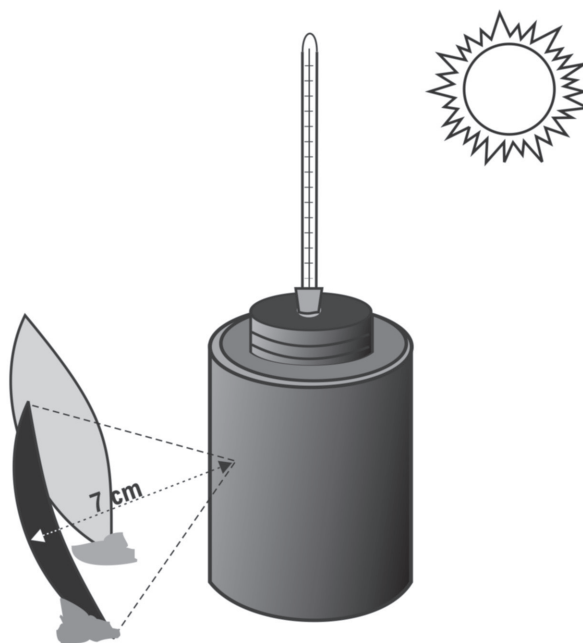

SOLAR COLLECTION

Solar collectors absorb radiant energy, convert it into heat and hold the heat.

PURPOSE: To explore solar collection.

Step 1: Cut two circles each of white and black construction paper 5 cm in diameter. Place the circles in the bottoms of four plastic containers and cover with 40 ml of cold water. Record the temperature of the water.

Step 2: Cover one black and one white container with clear plastic wrap held in place with rubber bands.

Step 3: Place the containers in a sunny place so that the sun is directly over the containers. Predict what will happen. Record the temperature of the water after five and ten minutes.

Step 4: Calculate and record the changes in temperature.

RECORD THE DATA

	WHITE NO COVER	BLACK NO COVER	WHITE WITH COVER	BLACK WITH COVER
Original Temperature-C				
Temperature-C After 5 min				
Temperature-C After 10 min				
Change in Temp - 5 min				
Change in Temp - 10 min				

CONCLUSIONS: Look at your data. What have you learned about collecting and storing solar radiation?

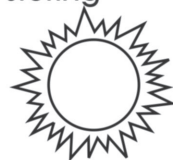

SOLAR BALLOON

Radiant energy often turns into heat when it hits objects. Black objects absorb more radiant energy than white objects. When air gets hotter, it rises. A solar balloon works because the black plastic absorbs radiant energy and turns it into heat. The air inside gets hotter.

Step 1: On a very sunny day, take the solar balloon outside and tie one end closed with a piece of plastic string. Open the other end and walk into the wind until it fills with air. When the balloon is filled with air, tie off the other end with string.

Step 2: Tie long pieces of string to both ends. Have two people hold the ends of the string and place the balloon in the sun.

Step 3: Observe the balloon as the air inside becomes hotter.

Step 4: Explain your observations.

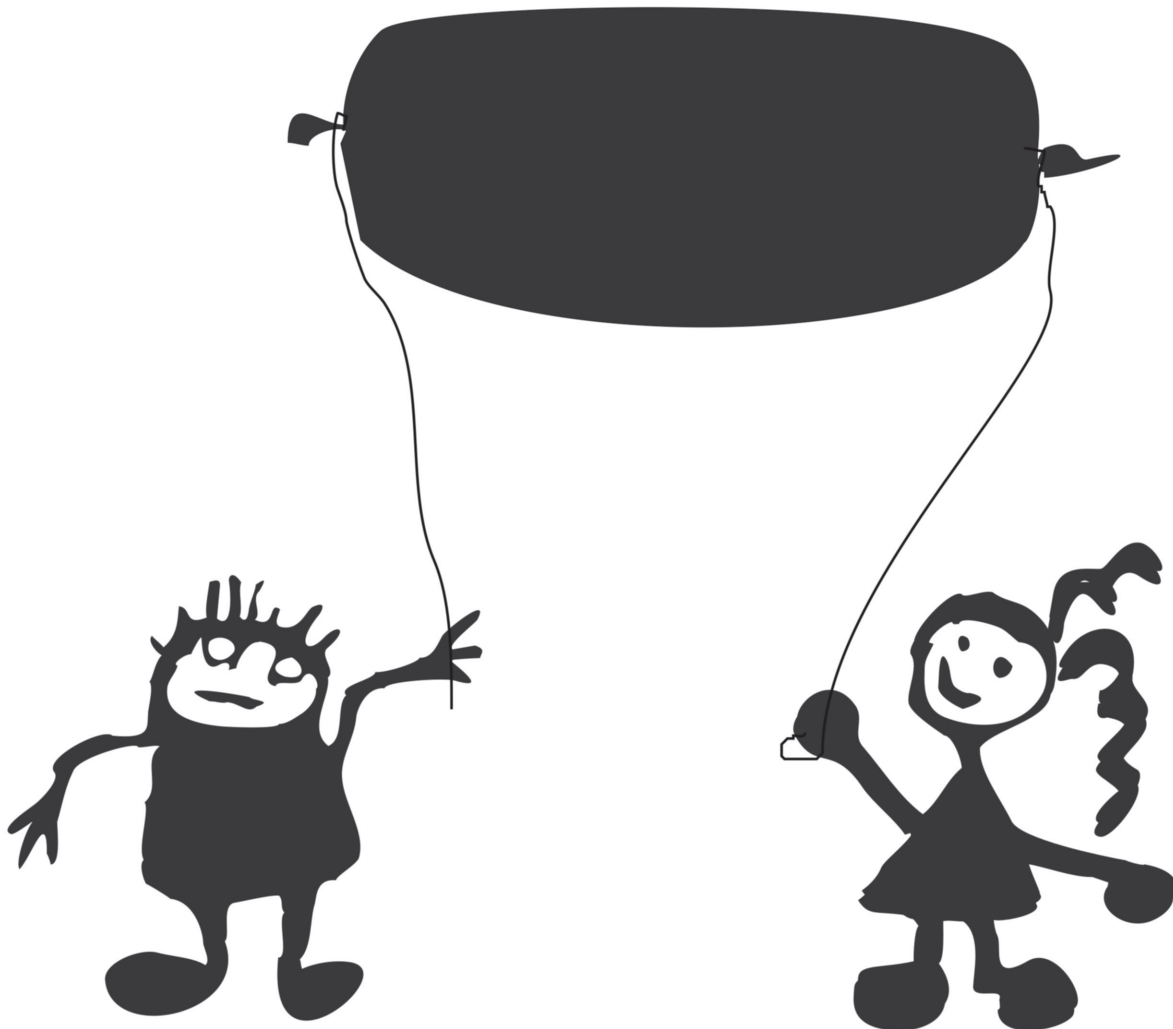

SOLAR HOUSE

A photovoltaic (PV) cell changes radiant energy into electricity. Electricity can run a motor to make motion and make light. A solar collector absorbs radiant energy and turns it into heat. A solar collector can heat water. A water storage tank painted black can store hot water and keep it hot by absorbing radiant energy.

Step 1: Use a cardboard box to make a house with big windows and a door in the front.

Step 2: Use clear transparency film to cover the windows.

Step 3: Use black construction paper to make a round water storage tank. Attach it to the side of the house with tape.

Step 4: Make two holes in the top of the box like in the drawing. Each hole should be about one centimeter (1 cm) in diameter.

Step 5: Place the solar collector on top of the house as shown in the drawing. Put the tubing from the solar collector into the water storage tank.

Step 6: Place the PV cell on top of the house. Insert the light through the hole as shown in the diagram.

Put the stem of the motor through the hole for the motor stem.

Step 7: Put a tiny bit of clay into the hole of the fan and push it onto the stem of the motor that is sticking through the ceiling.

Step 8: On a sunny day, place the house in the sun with the front facing south.

Step 9: Observe the light shine and the fan turn as the PV cell turns radiant energy from the sun into electricity. The solar collector shows how a real solar house could heat and store water. It doesn't really work.

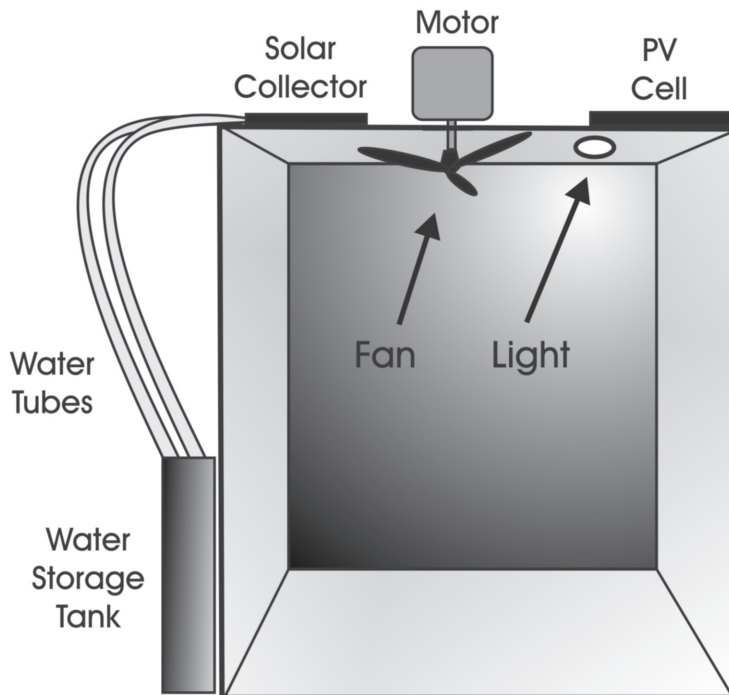

Front View of House

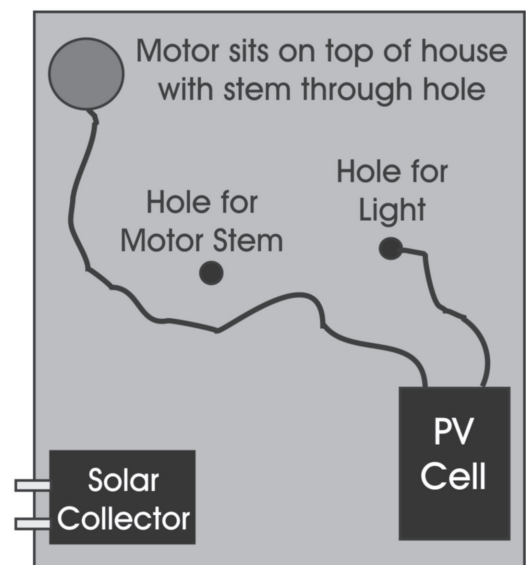

Top View of House

PHOTOVOLTAICS

Photovoltaic (PV) cells absorb solar radiant energy and convert it to electricity. A motor converts electricity into motion.

PURPOSE: To explore PV cells.

Step 1: Attach the motor to the PV cell by removing the screws on the posts of the PV cell, sliding one connector from the motor onto each post, then reconnecting the screws.

Step 2: Attach the fan to the stem of the motor so that you can see the motion of the motor.

Step 3: Place the PV cell in bright sunlight. Observe the rate of spin of the fan.

Step 4: Cover part of the PV cell with your hand. Observe the rate of spin of the fan.

Step 5: Hold the PV cell at different angles to the sun and observe the rate of spin of the fan.

Step 6: Use a bright artificial light source, such as an overhead projector, and observe.

Step 7: Cover part of the PV cell and change its angle to observe changes in the rate of spin.

Step 8: Hold the PV cell at different distances from the light source and observe changes in the rate of spin of the fan.

Step 9: Observe the direction of the spin of the disc. Remove the wires from the PV cell posts and connect them to the opposite posts. Observe the direction of the spin.

OBSERVATIONS AND CONCLUSIONS: What have you learned about PV cells and their ability to convert radiant energy into electricity? How does changing the area of the PV cell exposed to light affect the amount of electricity produced? How does changing the angle of the PV cell to the light affect the amount of electricity produced? How does changing the distance from the light source affect the amount of electricity produced? Can you tell from your experiment whether artificial light produces as much electricity as sunlight? Why or why not? How does reversing the wires affect the direction of spin of the disc? Why?

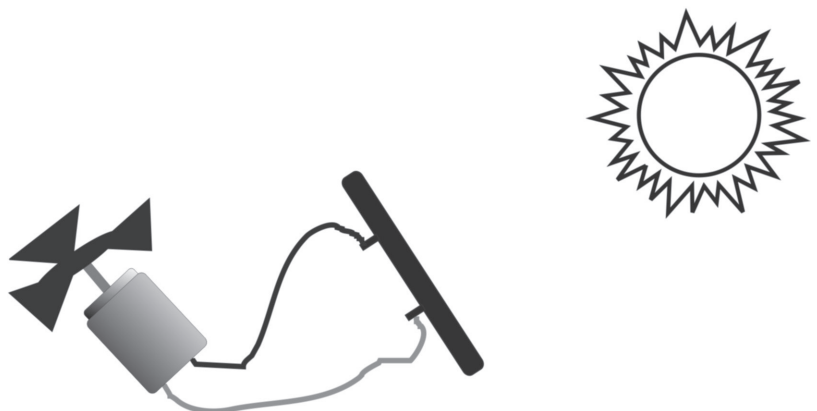

MAKE A SOLAR OVEN

PURPOSE: To explore cooking with solar energy.

MATERIALS (for two ovens):

Tri-fold presentation board

Wide, heavy-weight aluminum foil

Clear plastic bags

Food to cook

Sharp knife or scissors to cut board

Glue stick and clear packing tape

Cooking pot with lid

**Optional: Use pizza boxes covered with foil or Pringles cans to make mini-ovens*

Step 1. Cut board according to the diagram on the next page.

Step 2. Lightly score new fold lines before folding.

Step 3. Use tape to reinforce folds and to straighten pre-fold on wings.

Step 4. Cover entire board front with aluminum foil, taping or gluing securely.

Step 5. Slide points of wings into slits as shown in the diagram below.

Step 6. Put food in cooking pot and cover.

Step 7. Enclose cooking pot in plastic bag and place in middle of oven.

Step 8. Place oven with the sun shining on the pot.

SOLAR COOKING HINTS: Use black metal pans and dark brown glass dishes. Never use light colored cookware. A canning jar painted flat black works fine to boil water. Use black cast iron if you're cooking something that must be stirred. It won't lose heat when you open it. Don't add water when roasting vegetables. They'll cook in their own juices. When baking potatoes, rub with oil and put in a pot with a lid. Don't wrap with aluminum. Bake bread in dark glass dishes with lids. When baking cookies, chocolate cooks fastest, then peanut butter, then sugar cookies. Use a dark cookie sheet. Marinate meats in advance. Place on a rack in a cast iron pot. One pot meals are great! Cut everything up, throw into the pot, and put on the lid. Food won't burn in a solar oven. It might lose too much water, though, if you cook it too long.

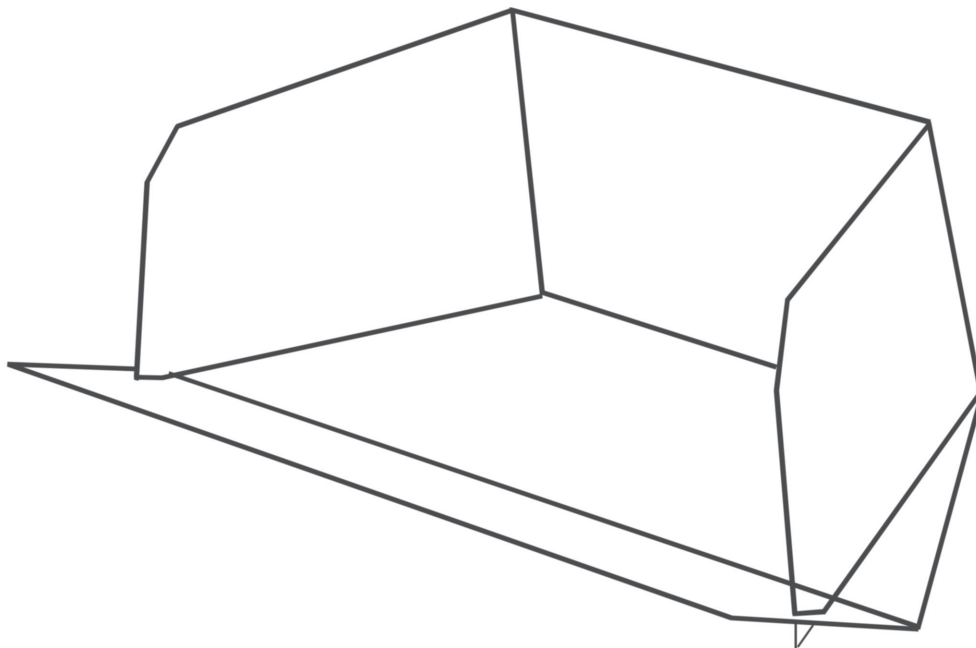

BI-FOLD DISPLAY BOARD MAKES TWO SOLAR OVENS

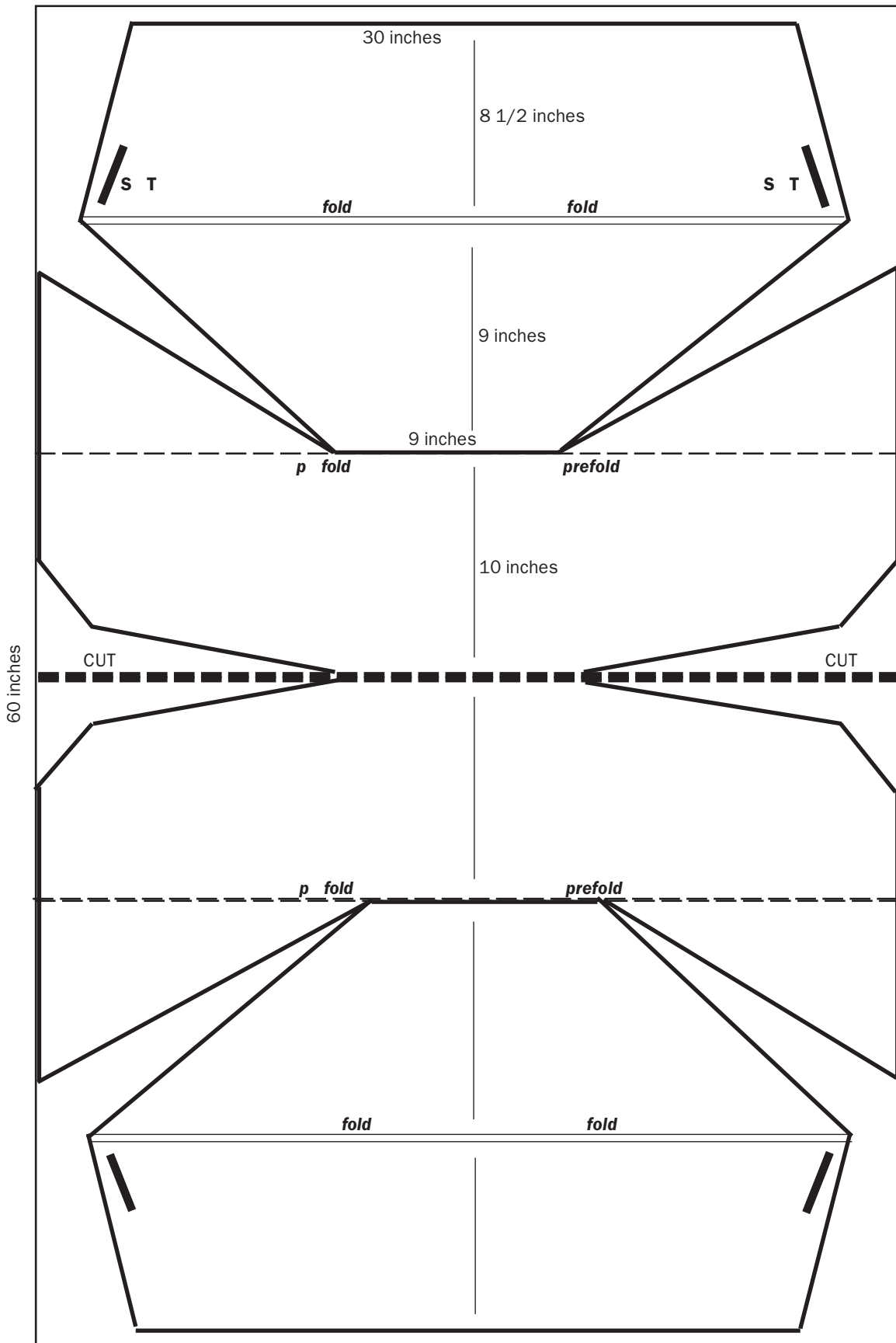

THE NEED PROJECT

**PO BOX 10101
MANASSAS, VA 20108
TEL: 1-800-875-5029
FAX: 1-800-847-1820
www.need.org**