



Extended User Guide



KODAK VERITÉ 50 Eco WIRELESS ALL-IN-ONE INKJET PRINTER



We're glad you chose this KODAK VERITÉ Wireless All-In-One Inkjet Printer.

Need help fast?

Read your **Quick Start Guide** and/or **Extended User Guide** first for quick tips that make using your KODAK VERITÉ Wireless All-In-One Inkjet Printer more enjoyable. If you have read your instructions and still need assistance, you may access our online help at

www.kodakverite.com/support

or call 1-844-995-6325 (1-844-99KODAK)

Details, explanations, and expressions displayed on your smartphone/tablet/PC display may differ from those shown in this **Extended User Guide**. The displayed items and specifications are subject to change without notice.

Contents

Introduction	3
Notice and Safety	3
Dear Customer	3
About this Extended User Guide	3

General safety information	4
---	----------

Overview	7
Control panel	8
Meaning of LED behavior and lights	9

Initial operation	11
Packing contents	11
Unpack	11
Install ink cartridges	12
Load paper	13
Turn On the unit	13

Initial setup	14
Before you download the printer driver to your PC	14
Install the printer driver to your PC	15
Wi-Fi Setup	18
Changing connection from USB to Wi-Fi	19
Changing connection from Wi-Fi to USB	20
ECO mode	21

Print using your smartphone/tablet	22
Use the mobile App	22
Mobile connection by  (Wireless)	23

Print from a Mobile Device	24
Google Cloud Print™	24
Information about Google Cloud Print™	24
AirPrint	25
Information about AirPrint	25

Check print status from your PC	26
Status Messenger for Windows®	26

Print media	27
Specifications for print media	27
Insert paper into the paper support	27

Print settings	29
Confirming Printing Preferences for Windows®	29
Confirming Print Settings for Mac	31

Making Copies	34
Copy Setting	34

Scanner	37
Scan in [Scanning] application by Windows®	37
Scan in Mac	38

Settings	40
Wi-Fi Setup	40
Google Cloud Print™	42
AirPrint	43
Software update	43
Printer Utility	43

Web interface	46
Confirming the IP Address	46
Calling the Web interface	46
Device Status	47
Device Configuration	47
Network	47
Mobile	48
Order Supplies	49
Software Update	49
Login Password	49

Service	50
Checking ink levels	50
Changing the ink cartridge	50
Ordering supplies	52
Fixing a paper jam	52
Restoring the factory settings	52
Hard Reset	52
Cleaning the ink cartridge nozzles and contacts	53
Preserving the ink cartridges	53
Cleaning the scanner glass	53
Cleaning the exterior of the unit	54
Periodic maintenance is required	54
Important Notice Regarding Printheads	54

Troubleshooting	55
Setup troubleshooting	55
Status messages and LED behaviors	59
Improving the print quality	64

Appendix	65
Specifications	65
Note about recycling	66
Safety Data Sheet (SDS)	66

Limited Warranty	67
-------------------------------	-----------

Introduction

Notice and Safety

Please read the following instructions carefully before operating the device and refer to them as needed to ensure the continued safe operation of your device.

Your Kodak Product and supplies have been designed and tested to meet strict safety requirements, including safety agency evaluation and certification, compliance with electromagnetic regulations and established environmental standards.

The safety, environmental testing and performance of this device have been verified using approved materials only.

WARNING : Unauthorized alterations, which may include the addition of new functions or connection of external devices, may impact the product certification. Please contact your Customer Support representative for more information at www.kodakverite.com/support

Dear Customer

You've purchased a very different kind of printer and we are glad you did. Now we want to help you get started saving on ink and using all of it's features. This KODAK VERITÉ printer provides quality printing for personal and office / small business use and it always helps you save on the cost of printing. For printing, copying and scanning, this all-in-one printer utilizes the most up-to-date technology. Easy to install ink cartridges are always provided with our printers; however, you must remove all packaging used for transportation first.

You can find the latest Software drivers and manuals for the printer on the website: www.kodakverite.com/support

We hope you enjoy your KODAK VERITÉ Wireless All-In-One Inkjet Printer and its many functions!

Features

ECO mode

- You can easily save ink consumption.
 - » Refer to "ECO mode" on page 21.

Paper requirement

- You can load up to 60 sheets (20lb. or 75g/m²) onto the Paper support.
 - » Refer to "Specifications for print media" on page 27.

ID Card Copy function

- Using the ID Card Copy function, you can copy both sides of a small document (e.g. business card) onto one page.
 - » Refer to "ID Card Copy" on page 36.

Web interface

- The web interface is available to you on all operating systems. You can access the web interface with an Internet browser on your PC and conduct many different settings to your device.
 - » Refer to "Web interface" on page 46.

Status Messenger (for Windows® only)

- The Status Messenger is available on the operating system. It is installed together with the printer driver and informs you of the newest driver, Software or application to download and install. Also, it shows the present status of the device. You receive detailed error messages among other things.
 - » Refer to "Check print status from your PC" on page 26.





Copying and scanning

- The device also supports copying and scanning of Color or Black & White documents. You can scan the document and save it to your Network PC.
 - » Refer to "Making Copies" on page 34.
 - » Refer to "Scanner" on page 37.

About this Extended User Guide

Read the entire Extended User Guide carefully. Follow all safety instructions in order to ensure proper operation of your device. The manufacturer accepts no liability if these instructions are not followed.

Symbols used in this Extended User Guide

Symbols	Description
	DANGER Danger to Persons This symbol gives warning of danger to persons. Physical injury or damage can result from improper handling.
	DO NOT TOUCH This symbol gives warning of danger to persons. Physical injury or damage can result from improper handling.
	CAUTION Damage to the Device or Loss of Data This symbol gives warning of damage to the device and possible loss of data. These damages can result from improper handling.
	Note(s) This symbol designates tips that will help you to use your device more effectively and easily

General safety information

Funai reserves the right to change products at any time without being obliged to adjust earlier supplies accordingly.

The material in this Extended User Guide is believed adequate for the intended use of the system. If the product or its individual modules or procedures are used for purposes other than those specified herein, confirmation of their validity and suitability must be obtained. Funai warrants that the material itself does not infringe any United States patents. No further warranty is expressed or implied.

Funai cannot be held responsible neither for any errors in the content of this document nor for any problems as a result of the content in this document. Errors reported to Funai will be adapted and published on the Funai support website as soon as possible.

■ Warranty (Limited Warranty on page 67.)

- DO NOT attempt to take the device apart. There is danger of an electrical shock. No components are user serviceable. Opening the device voids the warranty. DO NOT disassemble or remove covers on the device. Repairs may only be done by an Authorized Service Center. Failure to do so shall void any warranty, stated or implied.
- Any operation expressly prohibited in this Extended User Guide, any adjustments or assembly procedures not recommended or authorized in this Extended User Guide shall void the warranty.
- DO NOT make any changes or settings that are not described in this Extended User Guide. Physical injury or damage to the device or loss of data can result from improper handling. Take note of all warning and safety notes indicated.
- DO NOT remove the product label located on the bottom side on your device; this would void the warranty.

■ Setting up the device

Please read the following instructions when you set up the device.

- Select a stable location.
Select a level, stable place with adequate space for air circulation. Make sure to allow extra space to open covers and trays.
The setup area should be well-ventilated and away from direct sunlight or sources of heat, cold, and humidity. DO NOT set the device near the edge of your desk or table.
- Place the device on a flat and stable surface.
- The device should be placed securely. If the device should fall, it can be damaged or can cause injury to people, especially small children. If the device is dropped it should be inspected by an Authorized Service Center.
- Position all cables in such a way that no one will stumble on them, thus avoiding possible injuries to persons or damage to the device itself.
- Protect the device against direct sunlight, heat, large temperature fluctuations and moisture. DO NOT place the device in the vicinity of heaters or air conditioners. Observe the information on temperature and humidity in the technical data.
- The device must have sufficient ventilation and may not be covered. DO NOT put your device in closed cabinets or boxes. DO NOT place the device on soft surfaces such as tablecloths or carpets and do not cover the ventilation slits. Otherwise the device could overheat or degrade.
- The area in which you operate the device must be adequately ventilated, especially if the device is used frequently. Set up your device in such a way that the Heat or A/C vent's air flow must be directed away from the work station.

- Never use a gas duster on this device. This gas trapped inside of this device may cause ignition and explosion.
- In the event that the device becomes too hot, or if you see smoke coming from the device, you must immediately disconnect the AC plug from the AC outlet. Have your device examined by trained professionals at an Authorized Service Center. To prevent the spread of fire, open flames should be kept away from the device.
- DO NOT allow liquids to enter into the device. Disconnect the device from the AC plug if liquids or foreign objects have entered the device and have your device examined by trained professionals at an Authorized Service Center.
- DO NOT allow children to handle the device without supervision. The packing materials should be kept out of the hands of children.
- DO NOT press forcefully on the scanner lid when you scan thicker documents or three-dimensional items, this could damage the scanner lid and/or the scanner glass.
- Make sure to place the device on a desk or table with adequate strength. DO NOT shake the device as this may cause printing failure or trouble. DO NOT place the device in a location or environment of high temperature or high humidity.

■ Power supply

- Check whether the voltage rating of your device (indicated on the product label located on the bottom side) is adequate for the power source available at the setup location.
- DO NOT plug in the device in moist rooms. Never touch the AC Power cord or the AC plug connection with wet hands.
- Set up your device so that the AC Power cord is easily accessible. In an emergency, disconnect your device from the power supply by pulling the AC plug.
- Never touch the AC Power cord if the insulation is damaged. Turn Off the circuit breaker for that AC outlet.
- Damaged wire could cause fire or electrical shock. Keep the AC Power cord straight without being twisted, bent or scraped. Please contact an Authorized Service Center.
- Before cleaning the surface of your device, disconnect it from the power supply only by pulling the AC plug. Use a soft, lint-free cloth. Never use liquid, gaseous or easily flammable cleansers (sprays, abrasives, polishes or alcohol). DO NOT allow any moisture to reach the interior of the device.
- In rare cases, the saved settings can be partly or completely reset to the Factory Default(s) when the AC plug is disconnected or in the event of a Power outage. DO NOT disconnect the AC plug right after a print job or after entering **Settings**.
- Press  (Power/Standby) to turn the device On or Off (Standby). To completely turn Off the device, you must disconnect the AC plug. Disconnect the AC plug to shut the device Off when trouble is found or not in use. The AC Power cord shall remain readily available.

⚠ CAUTION

- **Turn the device Off (Standby) using  (Power/Standby) buttons located on the Control panel of the device or the Remote Control before you disconnect the AC plug from the AC outlet to turn the Unit completely Off.**

Federal communications commission notice

This device complies with part 15 of the FCC Rules. Operation is subject to the following two conditions:

(1) This device may not cause harmful interference, and (2) this device must accept any interference received, including interference that may cause undesired operation.

This equipment may generate or use radio frequency energy. Changes or modifications not expressly approved by the party responsible for compliance could void the user's authority to operate the equipment.

This transmitter must not be co-located or operated in conjunction with any other antenna or transmitter.

Note: This equipment has been tested and found to comply with the limits for a Class B digital device, pursuant to part 15 of the FCC Rules. These limits are designed to provide reasonable protection against harmful interference in a residential installation. This equipment generates, uses and can radiate radio frequency energy and, if not installed and used in accordance with the instructions, may cause harmful interference to radio communications. However, there is no guarantee that interference will not occur in a particular installation. If this equipment does cause harmful interference to radio or television reception, which can be determined by turning the equipment off and on, the user is encouraged to try to correct the interference by one or more of the following measures:

- Reorient or relocate the receiving antenna.
- Increase the separation between the equipment and receiver.
- Connect the equipment into an AC outlet on a circuit different from that to which the receiver is connected.
- Consult the dealer or an experienced radio/TV technician for help.

Declaration of conformity

Trade Name : KODAK
Responsible party : FUNAI CORPORATION, Inc.
Product Name : VERITE 50/37 (US / Canada)
Regulatory Model* : JM502-4OUC (VERITE 50/37)
Address : 19900 Van Ness Avenue, Torrance, CA 90501 U.S.A.
Telephone Number : 1-844-995-6325 (1-844-99KODAK)*

* Phone rings once, then no sound until agent answers.

* For regulatory purpose, this product is assigned a regulatory model name. The regulatory model name should not be confused with the product name or product model.

Canadian notice

This device complies with Industry Canada license-exempt RSS standard(s). Operation is subject to the following two conditions: (1) This device may not cause interference, and (2) this device must accept any interference, including interference that may cause undesired operation of the device.

CAN ICES-3(B)/NMB-3(B)

PC connection

Use only a custom high speed certified USB cable to connect the device to your PC. The recommendable cable length is no longer than 5 feet (1.5 m).

Trademark information

All other registered and unregistered trademarks are the property of their respective owners.



ENERGY STAR® is a joint program of the U.S. Environmental Protection Agency and the U.S. Department of Energy helping us all save money and protect the environment through energy efficient products and practices.



The Wi-Fi CERTIFIED Logo is a certification mark of the Wi-Fi Alliance.



The Wi-Fi Protected Setup Identifier Mark is a mark of Wi-Fi Alliance.



Google Cloud Print™ is a trademark of Google Inc.



AirPrint™ and the AirPrint logo™ are trademarks of Apple Inc.

- Windows®, Windows® Server, Windows® Vista, Microsoft Edge, Internet Explorer® and the Windows logo are trademarks of the Microsoft group of companies in the United States and/or other countries.
- Google™, Google Chrome™, Chrome OS™, Google Drive™, Gmail™ and Android™ are trademarks of Google Inc.
- Mac OS®, OS X®, iPhone®, iPod touch®, iPad®, Safari®, macOS™ and Mac logo® are trademarks of Apple Inc., registered in the U.S. and other countries.
- iOS is a trademark or registered trademark of Cisco® in the U.S. and other countries and is used under license by Apple Inc.
- Intel® Core™ and Celeron™ are trademarks of Intel Corporation in the U.S. and/or other countries.

Copyright

All other trademarks referenced herein are the property of their respective owners.

Cables

Connections to this device must be made with shielded cables with metallic RFI / EMI connector hoods to maintain compliance with FCC Rules and Regulations.

Wireless Network

The functioning of security systems, medical equipment or sensitive devices can be disrupted by the transmission power of the device. Observe any usage regulations (or restrictions) in the vicinity of such equipment.

The use of this device can affect the operation of insufficiently shielded medical devices, hearing aids and pacemakers through the release of high frequency radiation. Also consult a doctor or the manufacturer of a medical device to establish whether these are sufficiently shielded from external high frequency radiation.

■ Caution when handling ink cartridges

Never open an ink cartridge. Store both new and used cartridges in a place where they will not come into the hands of children.

■ Ink cartridge safety

If ink gets on your skin, wash with soap and water. If ink gets into your eyes, flush immediately with water. If any discomfort or change in vision persists after washing, seek immediate medical attention.

■ About the Software

When carrying out a Software update only use the Printer Software Upgrade file for your device from the website:
www.kodakverite.com/support

Using other Software files can lead to your device not functioning properly. Funai accepts no liability for device malfunctions which can be traced back to the use of third party Software.

■ When paper jam has occurred

In case of a paper jam, use two hands to carefully remove the paper from the unit. Throw the paper away carefully.

DO NOT make any repairs to the unit yourself. Improper maintenance can result in injuries or damage to the unit.

■ Copying and Scanning precautions

Be aware that scanning, photocopying or editing any of the following may be punishable by law.

Copyrighted work

Unauthorized reproduction of copyrighted work is prohibited except for personal/domestic use or use in a limited extent based on that purpose.

Reproducing a photographic portrait may also be subject to punishment.

Currency, securities, etc.

Forging any of the following to use as genuine articles or producing misleading articles is subject to punishment by law.

- **Banknotes, paper currency, coins (including foreign currency)**
- **Government bonds, territorial bonds**
- **Postal money order certificates**
- **Postal stamps, documentary stamps**
- **Capital stock certificates, debenture stock certificates**
- **Bills, checks**
- **Commuter passes, coupon tickets**
- **Other valuable paper**

Official documents

Forging any of the following to use as genuine articles is subject to punishment by law.

- Licenses, copies of corporate registration, and other certifications/documents issued by public officials or government offices.
- **Agreements/contracts, documents of “rights and obligations”, etc. for proof of facts created by private individuals.**
- **Seals, signatures, or symbol marks put on by public officials.**
- **Private seals and signatures**

Relative laws

Criminal code, Copyright law, Act on Control of Imitation of Currency and Securities, Alteration and Imitation of Coins, Money Bills, Banknotes and Securities Circulating in Foreign States, Postal Act, Act on Control of Imitation of Postal stamps, Act on Punishment of Crimes Related to Stamps, Act on Control of Imitation of Stamps.

© 2017 Funai Electric Co., Ltd. All rights reserved.

The Kodak trademark, logo and trade dress are used under license from Kodak.

Funai is a registered trademark of Funai Electric Co., Ltd. and may not be used in any way without the express written consent of Funai.

No part of this manual may be reproduced, transmitted, disseminated or transcribed, in any form or for any purpose without the express prior written consent of Funai. Furthermore, any unauthorized commercial distribution of this manual or any revision hereto is strictly prohibited.

Information in this document is subject to change without notice. Funai reserves the right to change the content herein without the obligation to notify any person or organization of such changes.

Overview

Front view

- 1 Paper support
- 2 Paper guide
- 3 Scanner lid
- 4 Paper exit tray
- 5 Exit tray extender
- 6 Control panel and LED indicators

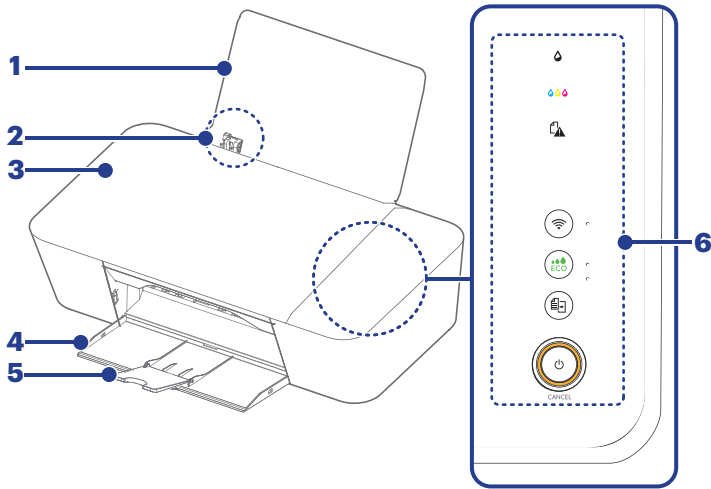

After opening the lid or door

- 7 Scanner glass
- 8 Ink door
- 9 Ink cartridge holder

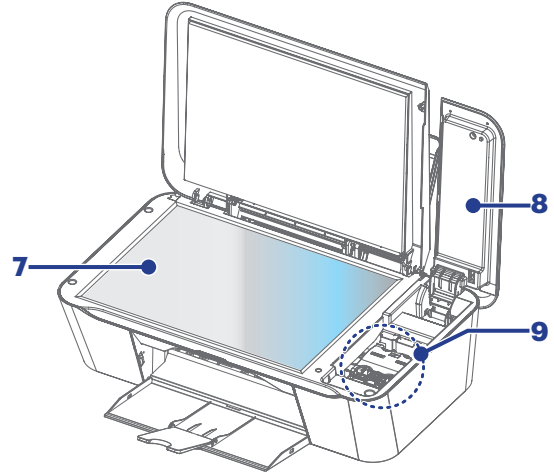





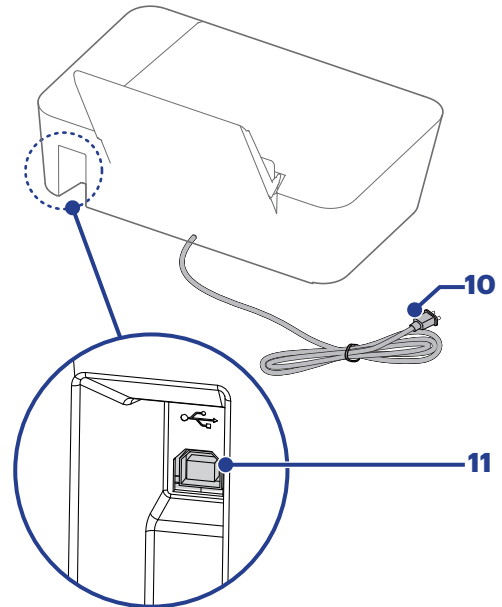

Rear view

- 10 AC Power cord and AC plug
- 11 Printer USB port — USB connection for your PC







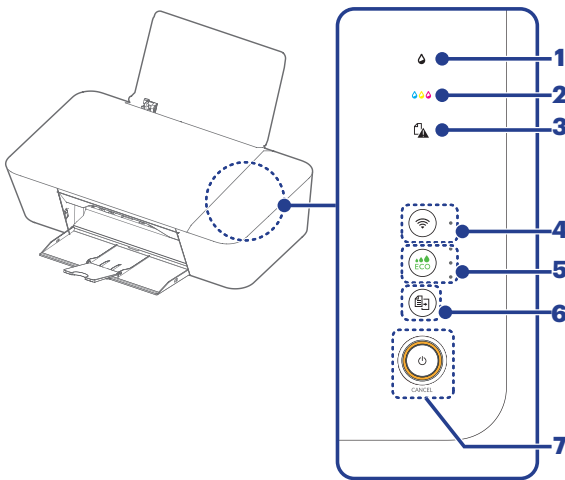

Control panel

- 1  (Black ink) LED
- 2  (Color ink) LED
- 3  (Paper Jam) LED
- 4  (Wireless) LED and button
- 5  (ECO) LED and button
- 6  (Copy) button
- 7  (Power) LED and Power/Standby button



LEDs





 (Black ink)	<p>– Indicates the black ink level or if empty.</p> <ul style="list-style-type: none"> Lights up: when ink cartridge is not inserted or empty. Blinking4: If not enough ink remains. Blinking6: Notifies if an error occurs.(Ink cartridge is not inserted or empty when the unit starts the initial setup.) <ul style="list-style-type: none"> » Refer to “Meaning of LED behavior and lights - LED lighting patterns” on page 9 for lighting patterns.
 (Color ink)	<p>– Indicates the color ink level or if empty.</p> <ul style="list-style-type: none"> Lights up: when ink cartridge is not inserted or empty. Blinking4: If not enough ink remains. Blinking6: Notifies if an error occurs.(Ink cartridge is not inserted or empty when the unit starts to initial setup.) <ul style="list-style-type: none"> » Refer to “Meaning of LED behavior and lights - LED lighting patterns” on page 9 for lighting patterns.

	(Paper Jam)	– Indicates a paper jam has occurred.
	(Wireless)	– Indicates the connection status of the Wireless Network and Easy Simple Print.
	(ECO)	– Indicates ECO mode
	(Power Yellow)	– Indicates the present unit's status. e.g.) power is supplied, working
	(Power Red)	– Indicates an error status



Note(s)

- You can find the meaning of status and error lights in “Meaning of LED behavior and error lights” on the next page. Please note the messages displayed in the Web Interface, or in the Status Messenger (for Windows® only) on your PC.

Buttons

	(Wireless)	<p>– Use to connect to the Wireless Network.</p> <p>Wireless feature: On</p> <ul style="list-style-type: none"> By using ‘Easy Simple Print’ with the mobile device, press it less than 3 seconds to establish the Wireless Connection. By using Wireless router if your router has a ‘WPS’ button, press and hold it until the LED beside the button changes to blinking to establish the Wireless Connection. Follow “WPS Search” in “Wi-Fi Setup” “WPS Search” on page 18.
	(ECO)	– Use to shift to ECO mode.
	(Copy)	<p>– Use to</p> <ul style="list-style-type: none"> Start a copy job with the current settings. <p>Unit status: ready</p> <ul style="list-style-type: none"> Press and hold less than 3 seconds: starts copying. Press and hold longer than 3 seconds: starts printing the configuration report.
	(Power/Standby)	<p>– Press to change the power state.</p> <p>Press and hold less than 3 seconds: enters Sleep mode or wake up On.</p> <p>Press and hold longer than 3 seconds:</p> <p>(Make sure to wake the unit in advance if the unit is in Sleep mode.)</p> <ul style="list-style-type: none"> The unit goes into Standby mode. The unit cancels the current printing jobs (including test print and print reports), scanning or copying.

Note(s)

- The function carried out will vary, depending on the unit's status when you press a button.
- Factory Default Restore can be performed by pressing and holding  (Power/Standby) and  (Wireless) together for more than 15 seconds.

Meaning of LED behavior and lights

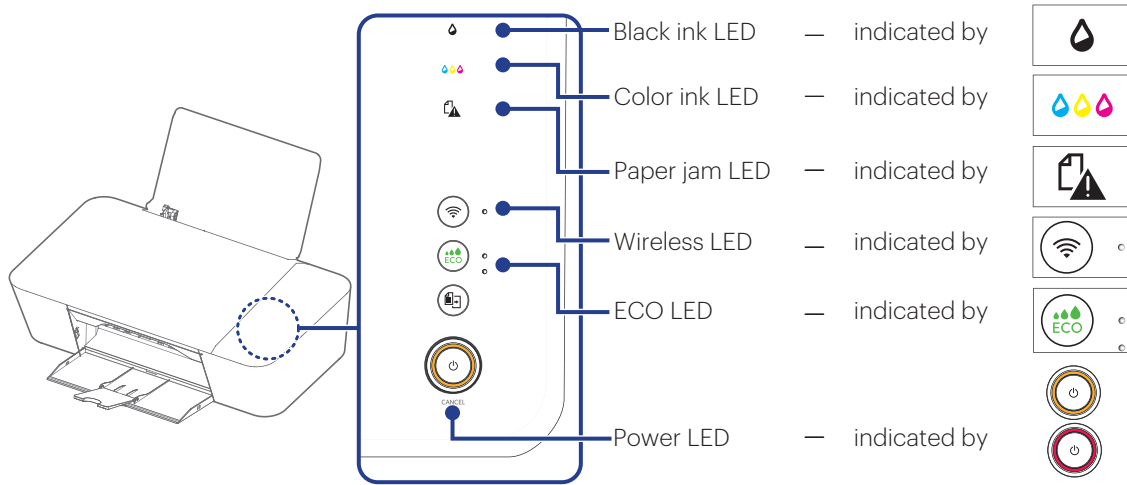



LED lighting patterns



Blinking 1	Lights up for 1 sec. ↻ No light for 1 sec.
Blinking 2	Lights up very rapidly ↻ No light for more than 1 sec.
Blinking 3	Blinking very rapidly 2 times ↻ No light for 1 sec.
Blinking 4	Blinking very slowly

Blinking 5	Blinking slowly
Blinking 6	Blinking rapidly
Blinking 7	Blinking very rapidly
Blinking 8	Blinking very rapidly 4 times ↻ No light for 2 sec.
Blinking 9	Blinking slowly (in Power-On mode)











Unit status

LED(s)	Behavior	Meaning / Possible cause(s)
All LEDs	No light	Unit is turned Off (Standby), or in Sleep mode, a mode which is effective in saving power. Even in Sleep mode, the unit is able to receive a print job from USB/ Network equipment.
All LEDs	Lights up and Blinking 9	Unit is Starting.
	Lights up	Indicates that the unit is Ready. The unit is able to receive a print job. This Yellow LED behavior is also used when copying, scanning or cancelling copy or scan.
	Blinking 5	Indicates that the unit is Running. This Yellow LED behavior is used when printing, cancelling a print job and after the print jobs are received, running the alignment process (While running the alignment process, any new print job received will start printing after the alignment process is done. (The print job is not effected while the unit is scanning the alignment pattern.)).
	Blinking 1	This Yellow LED behavior is used when updating Software, restoring factory default and performing weekly maintenance.
All LEDs	Blinking 1	System error occurred. Refer to "Status messages and LED behaviors" on page 59.

ECO mode status

LED(s)	Behavior	Meaning / Possible cause(s)
	No light	Indicates that ECO mode0 (ECO Off).
	Lights up	Indicates that ECO mode1 is ON (Save 20% ink).
	Lights up	Indicates that ECO mode2 is ON (Save 20% ink, page reduced 12%).

Network status

LED(s)	Behavior	Meaning / Possible cause(s)
	Lights up	The unit is connected to the Network using a Wireless connection.
	Blinking 2	Indicates that the unit started to connect to the Network using a Wireless connection or WPS (Wi-Fi Protected Setup) connection. The unit is not connected to the Network yet.
	Blinking 3	Indicates that the unit is in Easy Simple Print and there is no connection point. Connection with Network equipment is not established yet.
	No light	Indicates that Wireless connection is Off. The unit is not connected to the Network.
	Blinking 1	Indicates that the unit is directly connected to your smartphone/tablet using Easy Simple Print connection. The unit is connected to the Network using Easy Simple Print.
	Blinking 7	Indicates that the Network connection has become unavailable and the unit is not currently connected to the Network.
	Blinking 5	Indicates that the unit is in the process of the Google Cloud Print™ registration. Proceed to Google account registration and register this unit to your Google account by following the instructions for the Google Cloud Print™ service. Refer to "Google Cloud Print™" on page 42.
	Blinking 1	Indicates that the unit needs confirmation to start the Google Cloud Print™ registration.
	Blinking 7	Indicates that the WPS connection failed. The unit detected the Router, but failed to establish a connection.
	Blinking 8	Indicates a session overlap error. The session overlap error occurred because two Routers started the Wi-Fi Protection Setup simultaneously.
	Blinking 1 (alternate Yellow and Red)	Indicates that the unit received an identification request from AirPrint.

Initial operation

Packing contents

- 1 Unit
- 2 Quick Start Guide (Including Safety Sheet and Limited Warranty)
- 3 Black/Color ink cartridges

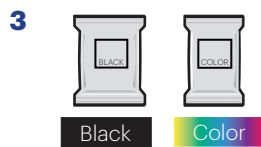
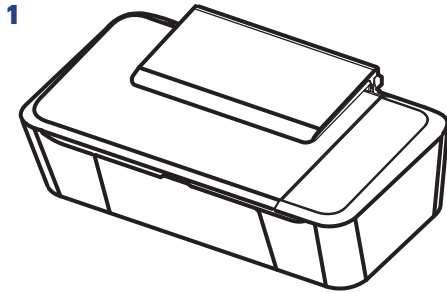

Note(s)

Missing package contents

- If any of the parts are missing or damaged, please contact an Authorized Service Center or Kodak Support.

Unpack

- 1 Remove the unit and ink cartridges from the box, then remove the Quick Start Guide.

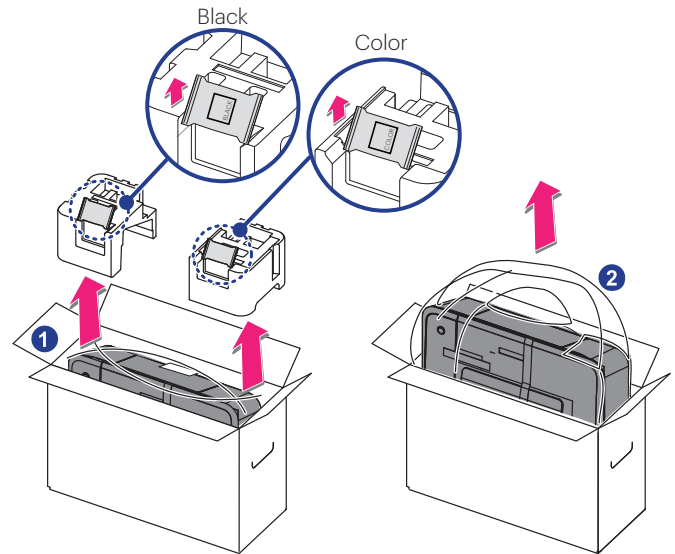

- 1 Removing packaging material from the unit

- 1 Remove tape and the plastic bag from the unit and then remove the twisted wire from the AC Power cord.
- 2 Lift the paper support up, then Remove the tape including the white paper.

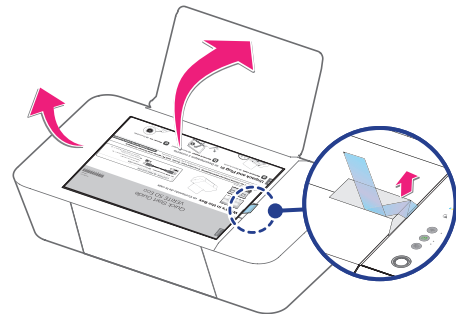

- 3 Open the Scanner lid, then remove the protective paper.

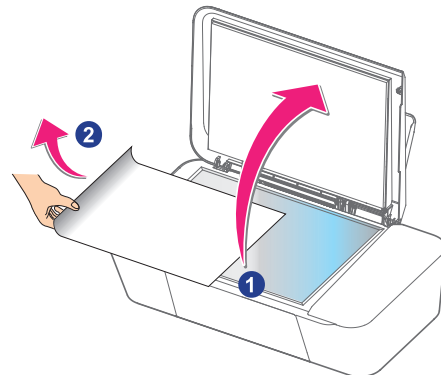

Install ink cartridges

Install ink cartridges to ink cartridge holder

- 1 Remove the black and color ink cartridges from packaging.

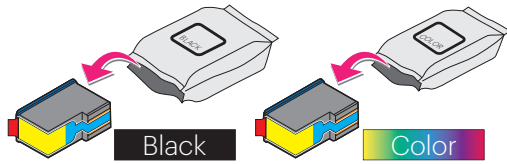

- 2 Remove the plastic tape on the black and color ink cartridges using the red pull tab.

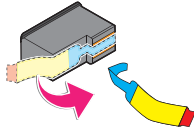

DO NOT TOUCH

- DO NOT TOUCH the gold contact area on the back or the metal nozzles on the bottom of the cartridge.

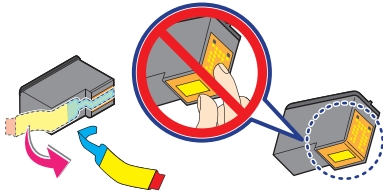

- 3 Lift the Ink door to access the cartridge slot.

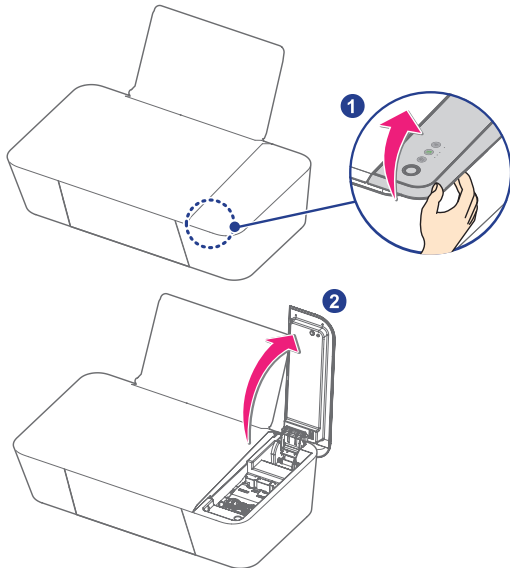

- 4 Press front side blue Cartridge tab with 2 fingers to open the cartridge slot.

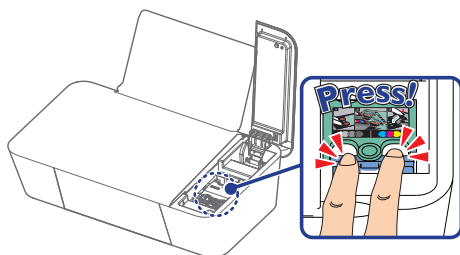

- 5 Slide the color ink cartridge all the way into the right slot using the green rail.

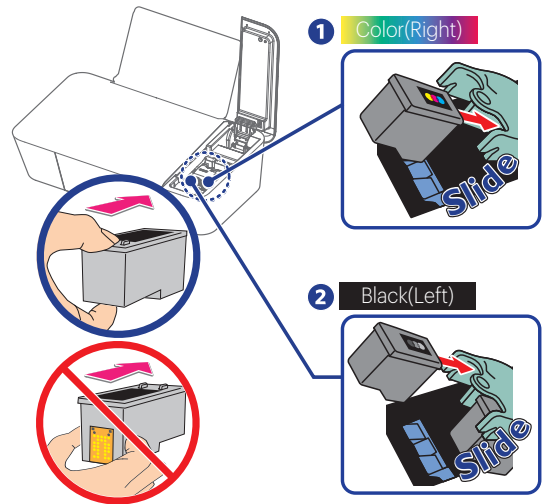

- 6 Slide the black ink cartridge all the way into the left slot using the green rail.

- 7 Push and click the center green Cartridge tab to close the cartridge slot until the cover snaps securely into position.

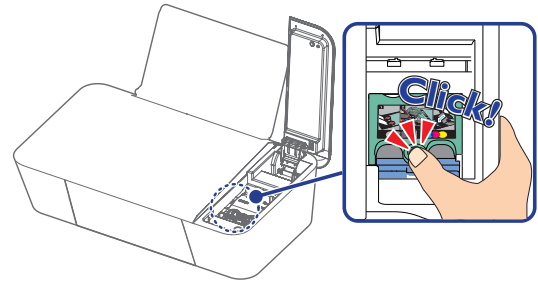

- 8 Close the Ink door.

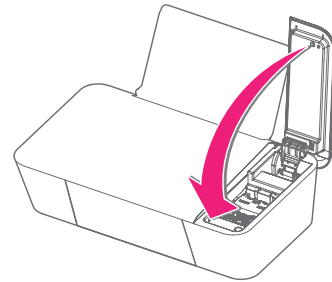

CAUTION

Ink Cartridge Not Inserted Correctly!

- If the Ink door does not close properly, the ink cartridges are not inserted correctly. Remove the ink cartridges and then correctly insert them again.

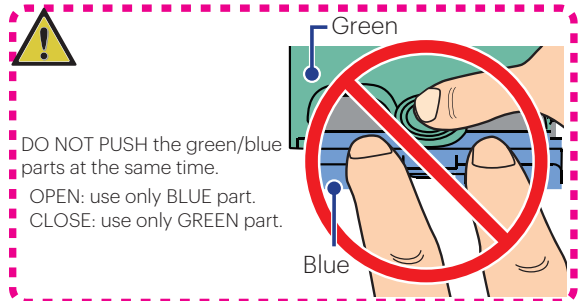

Load paper

■ Set paper onto the paper support

- 1 Slide the paper guide to the left first.

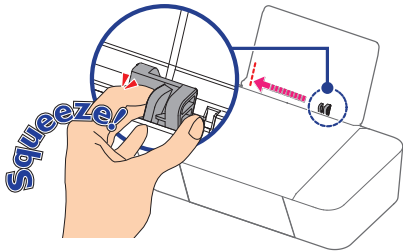

- 2 Fan the plain paper to be printed and then tap the paper sheets so the ends are all the same.

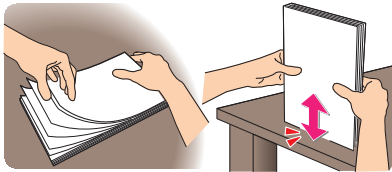

- 3 Set the plain paper (Letter or A4 size 20 lb. or 75 g/m2) onto the paper support. You can load up to 60 plain paper sheets. Slide the paper guide firmly against the edge of the paper.

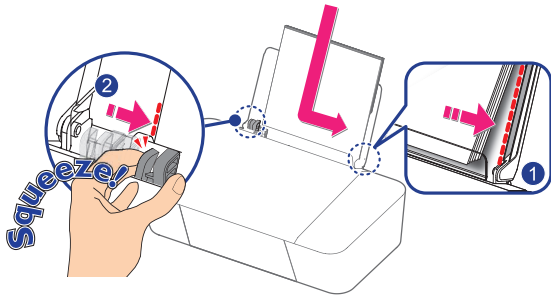

- 4 Open the paper exit tray and the exit tray extender.

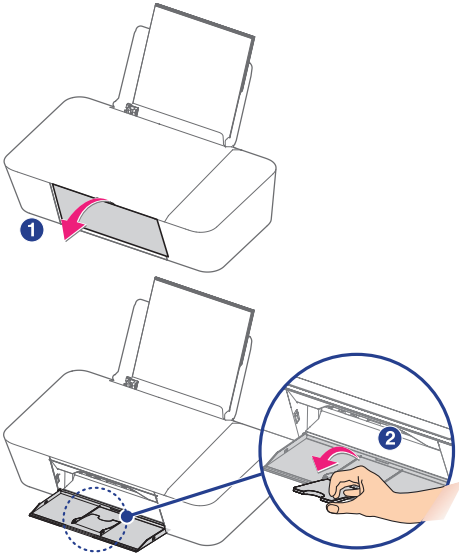

□ Note(s)

Loading Paper

- You can load up to 15 index cards or postcards, 10 glossy paper sheets or 5 envelopes on the paper support.
 - » Refer to "Print media" on page 27.

Turn On the unit

- 1 Connect the AC plug to the AC outlet.

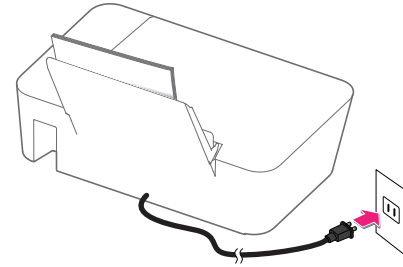

- 2  (Power) LED will light up, when the unit is turned On.

Initial setup

Before you download the printer driver to your PC

Requirements

Your PC must have one of the following operating systems.

Microsoft® Windows®

OS Version	Processor	Browser	USB port
Windows® 10	32-bit (x86) or 64-bit (x64)	Microsoft Edge	USB 2.0 High Speed or Full Speed
Windows® 8.1		Internet Explorer®	
Windows® 8			
Windows® 7			
Windows® Vista			
Windows® Server 2012			
Windows® Server 2008			

Apple Mac OS

OS Version	Processor	Browser	USB port
macOS 10.12 (Sierra)	Intel® Core™ Processor	Safari	USB 2.0 High Speed or Full Speed
OS X v10.11 (El Capitan)			
OS X v10.10 (Yosemite)			
OS X v10.9 (Mavericks)			
OS X v10.8 (Mountain Lion)			

- Make sure that your PC is turned On and you are logged on with administrator rights.
- In this Extended User Guide, the file extensions of the programs, files are omitted. If you set your PC to show the file extensions, the program and file names appear to be different from those described in this User Guide.
- In this Extended User Guide, the appearance of the screen images are based on Windows® 10; however, other operating systems (e.g. Windows® 8, etc.) provide basically the same operations. (There may be programs and functions named differently.)

CAUTION

- If there are any programs running, close them first.
- The screens may differ depending on your operating system.

How to download the printer driver

- 1 From your PC go to www.kodakverite.com/support and confirm that the "DOWNLOADS" is selected.
- 2 Select the model number of your unit from [SELECT PRINTER].
- 3 Select "PC drivers and software" from [HOW CAN WE HELP:], then follow the Instructions on your PC.



Extraction of printer driver installer

For Windows® users

- 1 Double-click on the downloaded installer file to extract it.

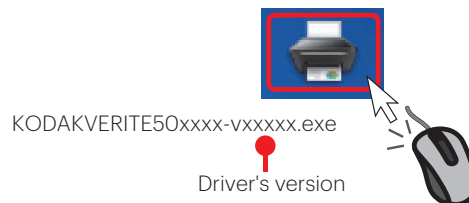

- 2 If "User Account Control" window appears, click "Yes".

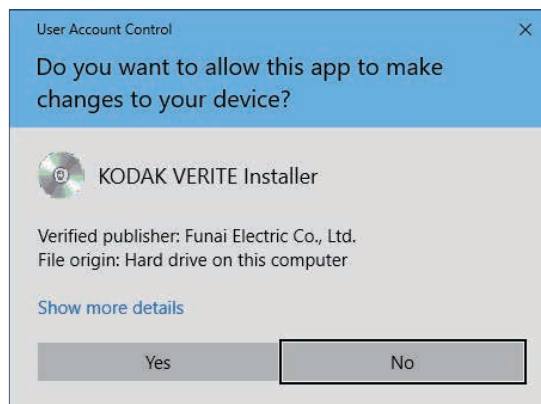

For Mac users

- 1 Double-click the downloaded installer file to mount it.



- 2 The following window will appear.

Double-click on **[KODAK-VERITE 50 Installer.mpkg]**.

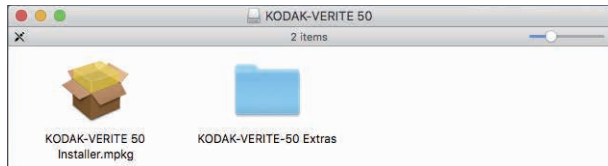

Note(s)

- If the installer does not start when you double-click **[KODAK-VERITE 50 Installer.mpkg]**, please try the following steps:
- 1 Select **[System Preferences]** in the Apple Menu. The Apple Menu is located on the top left of the screen. Click the Apple Icon to display the pull-down menu.
 - 2 Click **[Security & Privacy]**.
 - 3 Click the **[General]** tab and you will see the **[Allow application downloaded from:]** option. If the setting is locked, please unlock it. The Lock Icon is displayed on the bottom left of the **[Security & Privacy]** window. Click the lock icon to unlock. You may be required to enter the login password to proceed.
 - 4 Select **[Anywhere]** from options listed. For more information, visit our FAQ on the website at - www.kodakverite.com/support

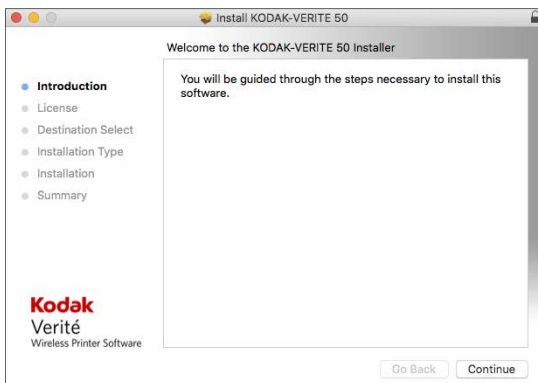

Install the printer driver to your PC

There are two ways to connect to the unit.

Using Wi-Fi (Recommended)

When your PC finds the unit in your network, this unit's serial number will appear on the Menu display.

- Double-click the printer driver installer and select "Wi-Fi Connect". If you accept the License Agreement, the installation of the driver will begin. Select this unit's serial number to complete the printer driver installation.

- 1 Click **[Wi-Fi Connect]**.



- 2 Click **[Agree]**.

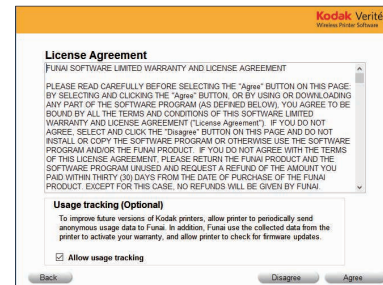

- 3 The following guidance will appear while the PC is searching the Network.

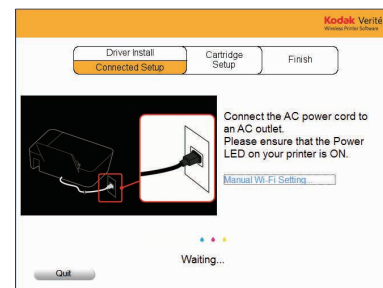

- 4 If your PC cannot find the unit, the pop-up menu will appear for 5 seconds. Click the instruction for the connection method you have chosen, then read the help text for more details.

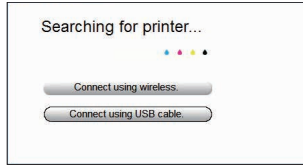

- 5 The unit's serial number will appear when the PC finds the unit. Select the serial number, then click "Next". The unit's serial number is located on the sticker on the back side of the unit.



- 6 Make sure plain Letter or A4 size paper is loaded in the paper support, click **[Start]**.

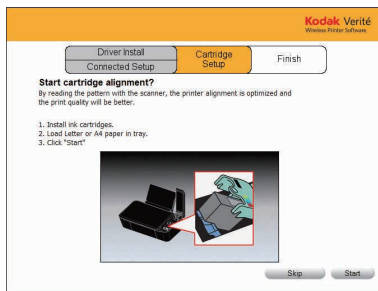

- 7 The unit will start printing the alignment pattern.

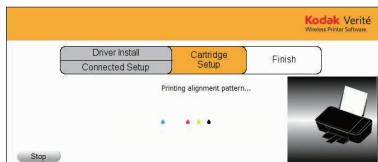

- 8 Open the scanner lid and place the alignment pattern paper facing down on the scanner glass, then click **[Confirm]** after closing the scanner lid.

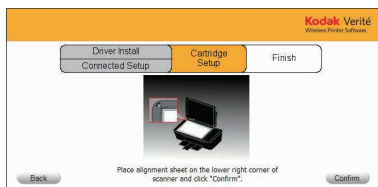

- 9 The unit will start scanning the alignment pattern to set an appropriate alignment on this unit.

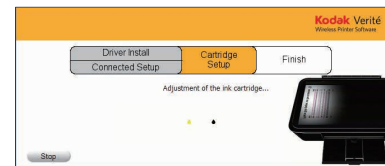

Note(s)

- Make sure to use only blank white paper (sold separately). Never use colored or patterned paper when you set the alignment.

- 10 The following guidance will appear when the printer driver is installed to your PC successfully.

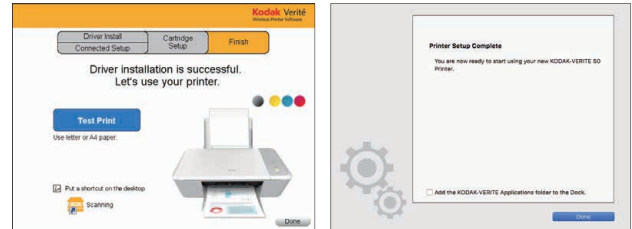

- Click "Test Print" to make sure the printer driver is installed properly (for Windows®).

Using USB Printer cable

- Double-click the printer driver installer and select "USB Connect". If you accept the License Agreement, the installation of the driver will begin. Select this unit's serial number to complete the printer driver installation.

1 Click [USB Connect].

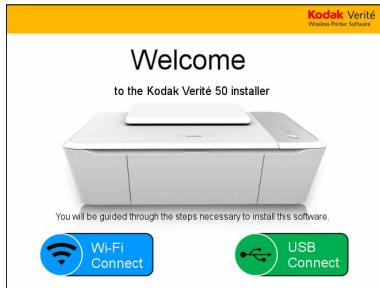

2 Click [Agree].

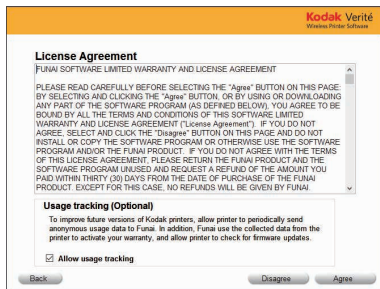

3 When the following window appears, connect printer AC Power Cord to AC Outlet and then connect the USB cable between the unit and your PC.

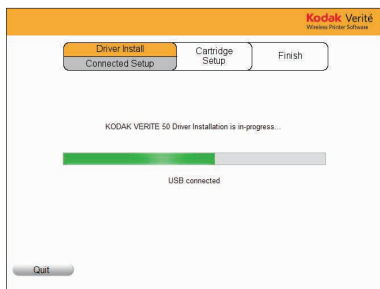

4 [Cartridge Setup] screen will be displayed on the Menu display. Make sure plain Letter or A4 size paper is loaded in the paper support, click [Start].

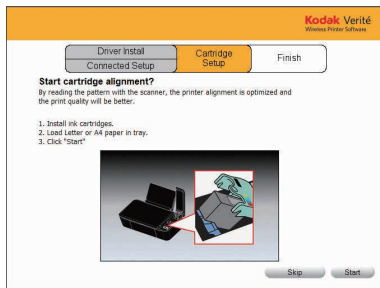

5 The unit will start printing the alignment pattern.

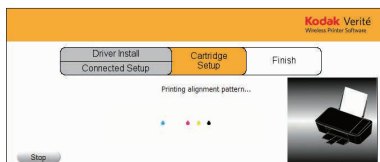

6 Open the scanner lid and place the alignment pattern paper facing down on the scanner glass, then click [Confirm] after closing the scanner lid.

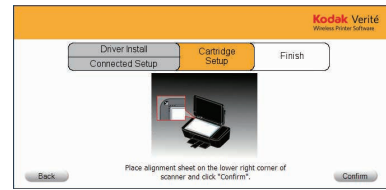

7 The unit will start scanning the alignment pattern to set an appropriate alignment on this unit.

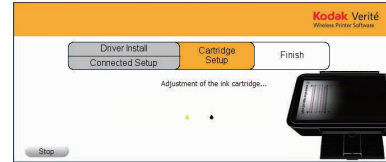

Note(s)

- Make sure to use only blank paper (sold separately). Never use colored or patterned paper when you set the alignment.

8 The following guidance will appear when the printer driver is installed to your PC successfully.

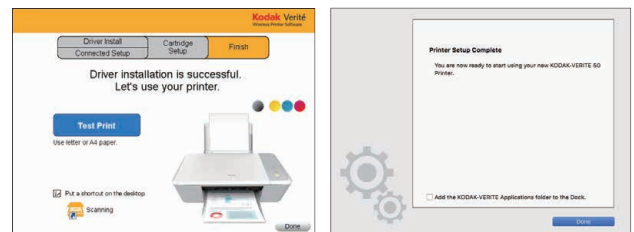

- Click "Test Print" to make sure the printer driver is installed properly. (for Windows®)

Wi-Fi Setup

Select Wi-Fi Setup type and follow the Menu display instructions.

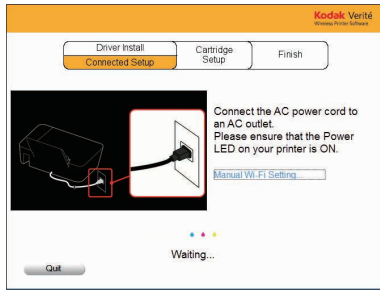

- Click Manual Wi-Fi Settings.

Manual Connect Setting

- 1 Fill in the blank, Network Name(SSID), Security type, Security key, then click **[Next]**.

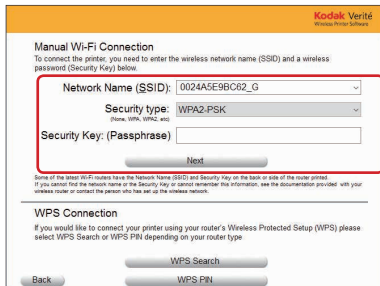

- 2 Connect up the Unit to your PC.



WPS Search

- 1 Click **[WPS Search]**.

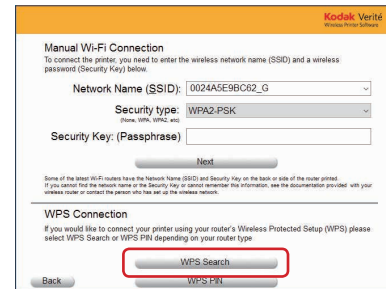

- 2 Press and hold the WPS button on your Router for a few seconds.

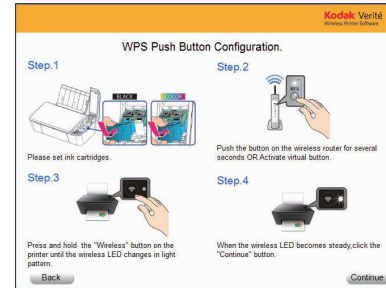

- 3 Press and hold  (Wireless) until the blinking pattern of

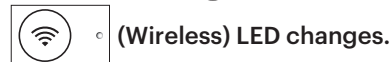

- 4 Click **[Continue]**.

WPS PIN

1 Click [WPS PIN].

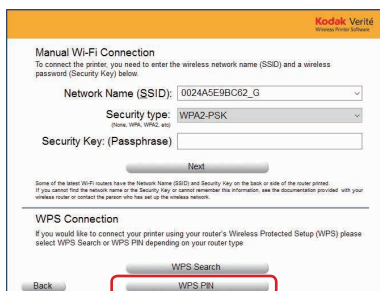

2 Connect up the Unit to your PC.

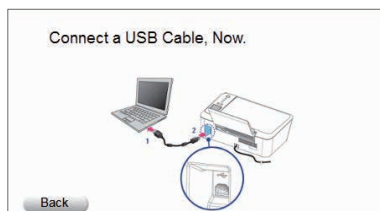

3 Enter Wireless PIN code password.

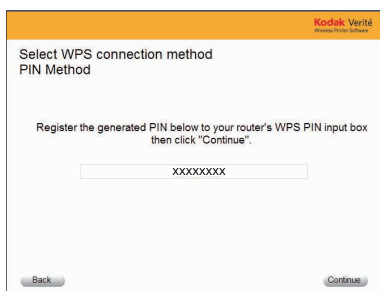

4 Click [Continue].

Note(s)

- When performing Network connection, make sure the unit is not placed too far away from the access point/router and the access point/router is powered On and its settings are correct.

If you need additional help on Network problems, visit our website at www.kodakverite.com/support

- If there are multiple printers on the Network, the window below will appear.



- Select your printer's serial number and click [Next].

Changing connection from USB to Wi-Fi

USB always has priority.

If you would like to change connection from USB to Wi-Fi, refer to the following instructions.

Microsoft® Windows®

- Disconnect the USB cable between this unit and your PC first.
- From the Windows® start menu, select [All apps] > [KODAK VERITE 50] > [Device setting].
- Click [Printer re-search] in the [Device setting] window.
- Change the connection type automatically.

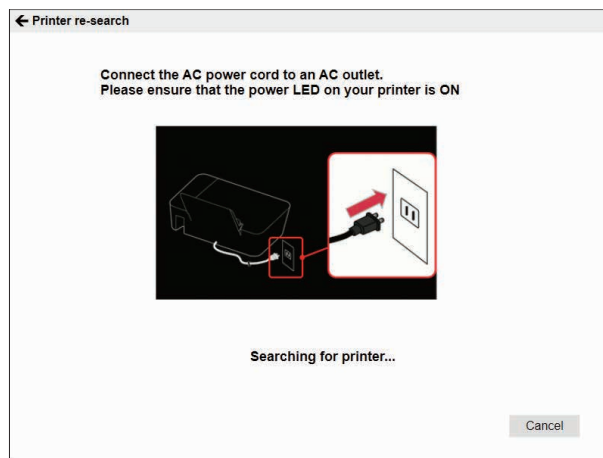

Apple Mac OS

- Disconnect the USB cable between this unit and your PC.
- Activate [System Preferences].
- Click [Printers & Scanners].

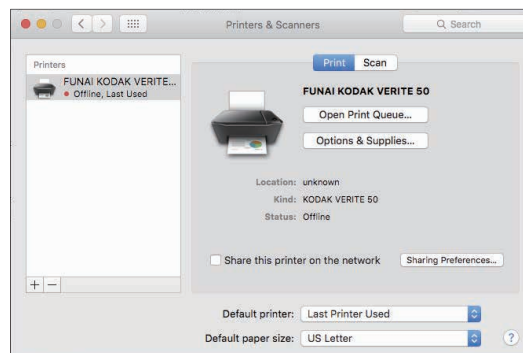

- Click [+] > [Add printer or Scanner...].

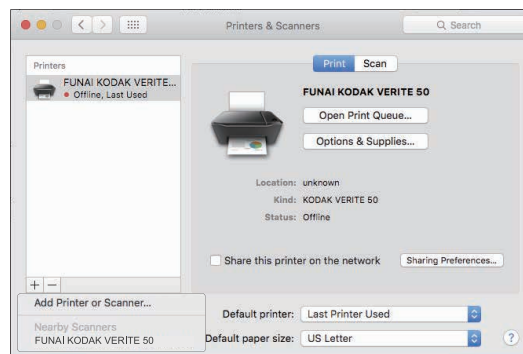

- Click the printer, select the driver from pull-down menu **[Use]**, then click **[Add]**.
 - Make sure to choose FUNAI KODAK VERITE 50 with **[Bonjour Multifunction]** in **[Kind]**.

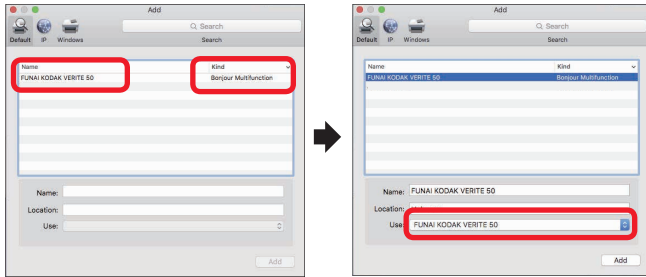

- Select **[FUNAI KODAK VERITE 50]** added.

Changing connection from Wi-Fi to USB

If you would like to change connection from Wi-Fi to USB, refer to the following instructions.

Microsoft® Windows®

- Connect the USB cable between this unit and your PC first.
- From the Windows® start menu, select **[All apps]** > **[KODAK VERITE 50]** > **[Device setting]**.
- Click **[Printer re-search]** in the **[Device setting]** window.
- Change the connection type automatically after checking one of the connections.

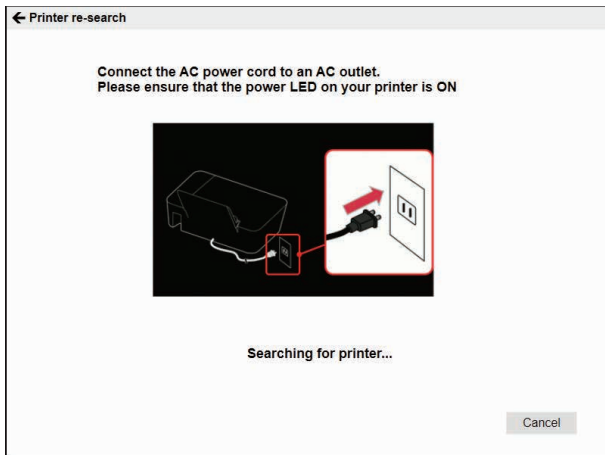

Apple Mac OS

- Connect the USB cable between this unit and your PC.
- Activate **[System Preferences]**.
- Click **[Printers & Scanners]**.

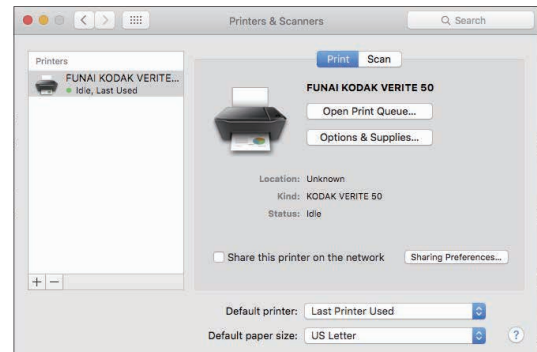

- Click **[+]** > **[Add printer or Scanner...]**.

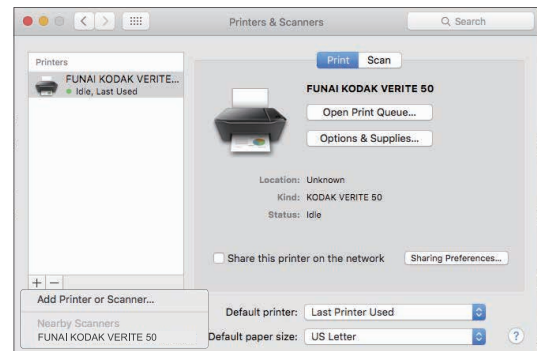

- Click the printer, select the driver from pull-down menu **[Use]**, then click **[Add]**.
 - Make sure to choose FUNAI KODAK VERITE 50 with **[USB Multifunction]** in **[Kind]**.

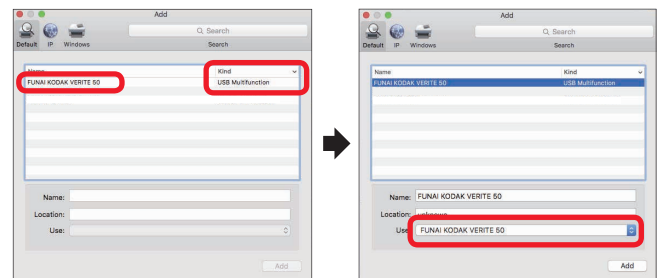



- Select **[FUNAI KODAK VERITE 50]** added.

ECO mode

You can easily save on ink consumption using  (ECO).

ECO mode status

Mode	Ink Density	Print Size
ECO mode 0 (ECO Off) 	100%	100%
ECO mode 1 	80% SAVE 20%!	100%
ECO mode 2 	80% SAVE 20%!	88% (Reduced 12%)
SAVE 30% in total!!		

- In **ECO mode 2**, the length and width of the print area will be reduced approx. 94%, resulting in a centered image that is approx. 88% of the original image size.

e. g. 1) Paper size : Letter



e. g. 2) Poster

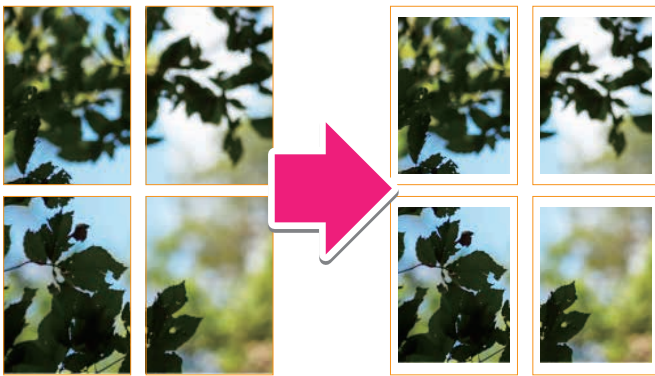

e. g. 3) Resizing
(Paper : Letter changes to a smaller print size on Letter paper.)

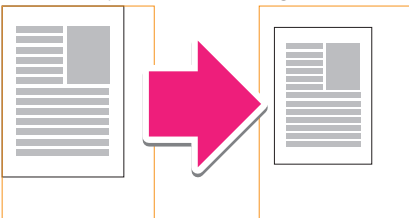

e. g. 4) Layout : 2-up

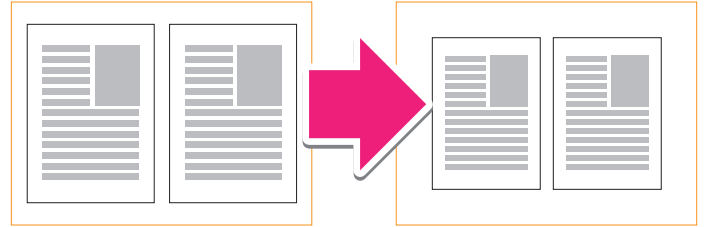

- Selecting ECO mode, you can automatically save ink and reduce the size of your print.
- You can also select ECO mode under Printer Preferences on your PC.
- If you set photo print borderless, the print size is not reduced.
- If the printer goes into Sleep mode or is turned Off (Standby), ECO mode will return to its default setting OFF.

Print using your smartphone/tablet

'Easy Simple Print' can print the data in your smartphone/tablet directly to the unit.

Printing is also available by using the mobile App for Android™ or iOS. For more information, read the following requirements and usage for your smartphone/tablet.



Requirements

Your smartphone/tablet must have one of the following operating systems.

Android™

OS Version	Memory required	Required product specification	Recommended product specification
Android™ 4.0.3 or later	10 MB or more free space	Wi-Fi	Built-in camera

iOS

OS Version	Memory required	Required product specification	Recommended product specification
iOS 8.0 or later (iPhone, iPod touch, iPad)	30 MB or more free space	Wi-Fi	Built-in camera

- In order to download the mobile App, you will need a Google Account or an Apple ID.

Note(s)

- Connect your mobile to the same Wireless Network that your unit is using.

Use the mobile App

Printing using the print application is available.

How to download the mobile App

- 1 From your mobile device go to www.kodakverite.com/support
- 2 Confirm that the "DOWNLOADS" is selected, then select the model number of your unit from [SELECT PRINTER].
- 3 Select "Connect your Mobile Device", then follow the Instructions.
- 4 Install Printer App on your smartphone/tablet using process defined by App Site.

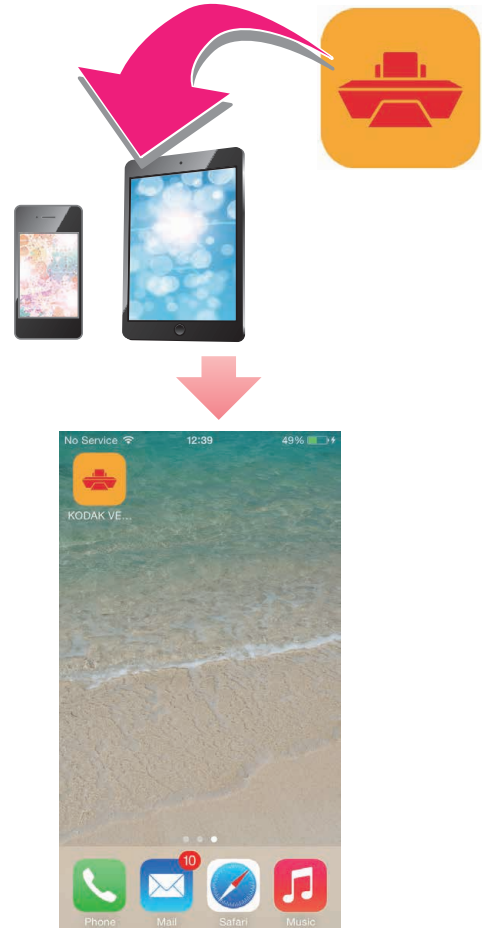

- 5 When the install Icon appears on your smartphone/tablet display, then tap the install Icon.

- Please visit our website for more information about the mobile App - www.kodakverite.com/support

Note(s)

- The mobile App's name and screen images display the current version. They may be changed due to updates.

Mobile connection by (Wireless)

Note(s)

- Check whether your smartphone/tablet supports the code reading first.

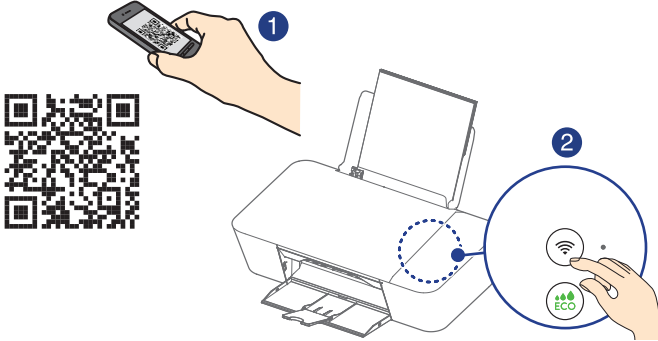

- 1 Scan the code below (or on the Quick Start Guide) with your smartphone/tablet and visit the address obtained.



- 2 Your smartphone/tablet will be connected to the website (store) where you can download the mobile App.

- 3 Install the mobile App.

- 4 After installation is completed, run the mobile App and follow its directions and press  (Wireless) in order to connect your smartphone/tablet with the unit.

-  (Wireless) LED will change from blinking to steady lighting when connection is completed.
- If your smartphone/tablet and the unit have already connected to the same router (Network), you do not need to press  (Wireless).
- From the next time on, you do not need to scan the code. Simply run the mobile App, then follow its directions and press  (Wireless) to connect your smartphone/tablet with the unit.

Note(s)

- The code is a type of two-dimensional barcodes that can be read using smartphones/tablets.

Print from a Mobile Device

This unit supports Google Cloud Print™ and iOS / OS X / macOS AirPrint.

Google Cloud Print™

Google Cloud Print™ is a service provided by Google that allows you to print to the unit registered to your Google account using a Network-compatible device (such as a smartphone/tablet or PC), without installing the printer driver on the unit.

» Refer to “Google Cloud Print™” on page 42.

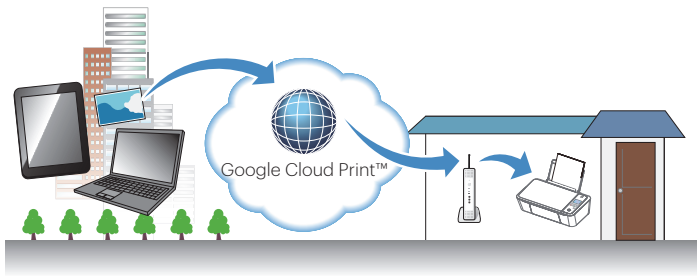

Note(s)

- In order to use Google Cloud Print™, you must have a Google account and sign in to your account.
- Make sure the unit and your smartphone/tablet or PC are connected to the Internet.

Supported operating systems and applications

Google Cloud Print™ is compatible with the following operating systems and applications:

Supported operating systems

- Chrome OS™
- Android™ 2.1 or later
- iOS 3.0 or later

Applications that can be used for printing

- Applications for Chrome OS™
- Google Chrome™ browser
- Google Drive™ for mobile
- Gmail™ webmail service for mobile
- For more information about Google Cloud Print™, visit website at - www.kodakverite.com/support

Information about Google Cloud Print™

For information about Google Cloud Print™, visit website at - www.kodakverite.com/support

- The contents of the website are subject to change without notice.

1 Click **[TROUBLESHOOTING]**.

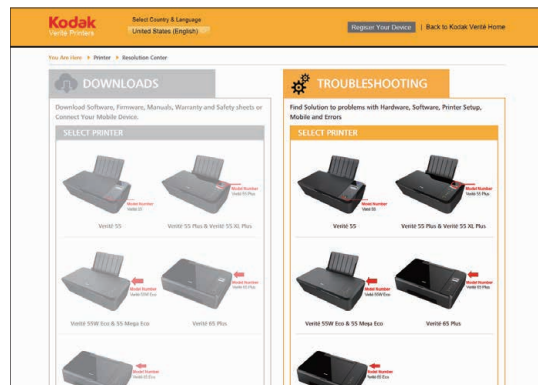

2 Select the model number of your unit from **[SELECT PRINTER]**.

3 Select **[Software - How to]** from **[HOW CAN WE HELP:]**.

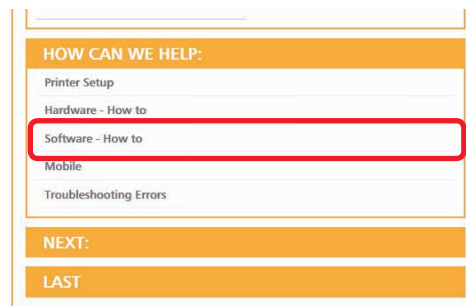

4 Select **[Google Cloud Print]** from **[NEXT:]**.

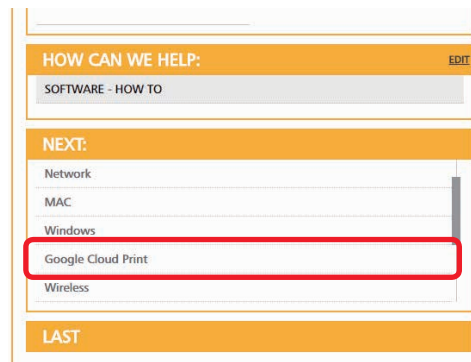

5 Select necessary item from **[LAST]**.

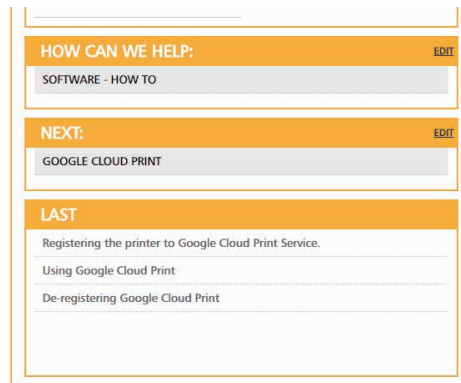

AirPrint

With iOS / OS X / macOS AirPrint, you can print photos, emails, web pages, and documents wirelessly from your Apple devices (iPhone, iPod touch, iPad).

iOS / OS X / macOS AirPrint does not require a driver to be installed.

» Refer to "AirPrint" on page 43.

Note(s)

- Your Apple devices need to be connected to the same Wireless Network that your unit is using.



Supported operating systems

Following Apple devices running the latest version:

- iPhone (3GS or later)
 - iPod touch (3rd generation or later)
 - iPad (all models)
 - OS X (v10.7 or later)
 - macOS (v10.12)
- For more information about AirPrint, visit website at - www.kodakverite.com/support

Information about AirPrint

For information about AirPrint, visit website at - www.kodakverite.com/support

- The contents of the website are subject to change without notice.

1 Click [TROUBLESHOOTING].

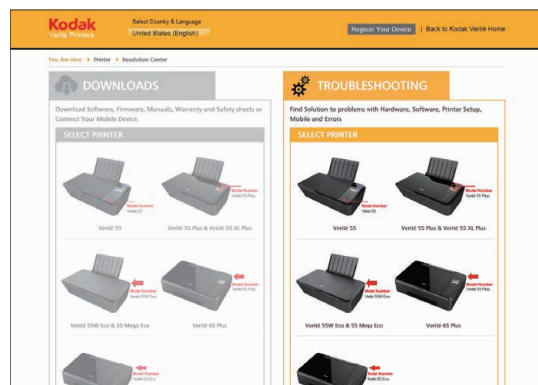

2 Select the model number of your unit from [SELECT PRINTER].

3 Select [Mobile] from [HOW CAN WE HELP:].

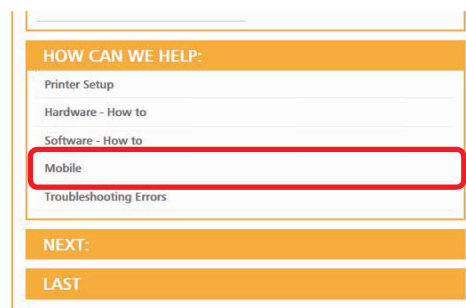

4 Select [Printing] from [NEXT:].

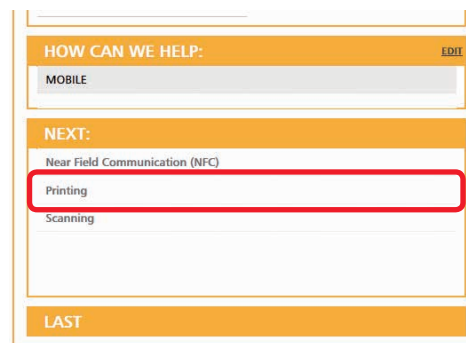

5 Select necessary item from [LAST].

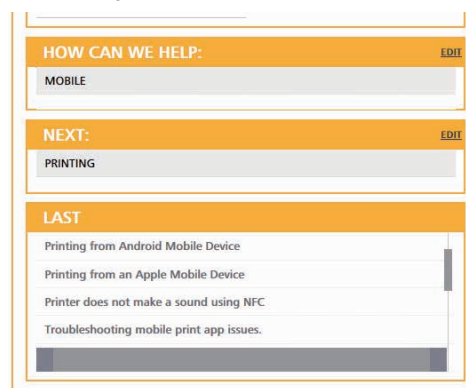

Check print status from your PC

Status Messenger for Windows®

The Status Messenger application automatically displays an error when a unit error has occurred. It is installed together with the printer driver and is added to the Start-up program by default, so it will automatically launch at startup. It can also be activated from the Windows Start Menu. When the Status Messenger is activated, an icon appears in the Windows® system tray.

Normal state :  Color: Green

Error or Warning :  Color: Red

For example, if there is no paper in the paper support, an error occurs when you try to print...

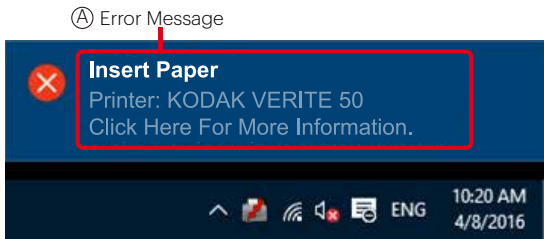

A pop-up appears from the system tray icon to provide immediate error notification. If you click on the pop-up, an error recovery guide appears so that you can confirm a detailed explanation on how to fix the problem.

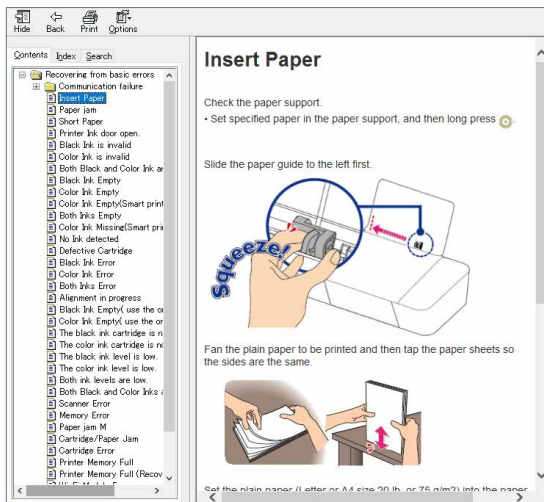

Settings for pop-up message and detailed information display can be configured in Status Messenger Settings. For how to configure the settings, refer to the following instructions.

Status Messenger Settings

To configure the Status Messenger, right click on the icon in the system tray and select **[Settings]**.

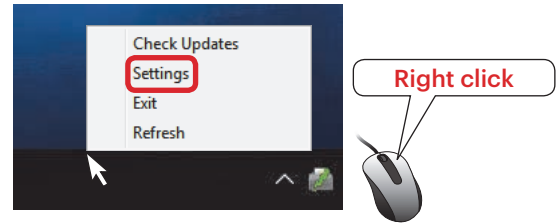

You can change the following items in the Status Messenger Settings.

- **Alert me when a problem prevents printing**
When checked: A message will pop up when an error occurs.
- **Alert me when my supplies are low**
When checked: A message will pop up when information is available.
- **Show me detailed status about my supplies**
When checked: Status Monitor Center will be launched by clicking on the pop-up or the icon in the Windows® system tray.

Print media

Specifications for print media

You can set up normal printer paper, envelopes or printed documents (forms) onto the paper support.

Paper support	
Paper Sizes	Letter · Legal · JIS B5 · A4 · Executive · A5 · Statement · A6 · 3x5 in. · 4x6 in. · 5x7 in. · Hagaki · 3.5x5 in.(L) · 10 Envelope · DL Envelope · C5 Envelope
Weight	Plain paper: 17 - 24 lb. (64 - 90 g/m ²) Cards: 90 - 110 lb. (163 - 200 g/m ²) Envelopes: 20 - 24 lb. (75 - 90 g/m ²) Photo paper: 50 - 65 lb. (180 - 240 g/m ²)
Capacity	Plain paper (20 lb. or 75 g/m ²): Up to 60 Cards (110 lb. or 200 g/m ²): Up to 15 Envelopes (24 lb. or 90 g/m ²): Up to 5 Photo paper (65 lb. or 240 g/m ²): Up to 10

- Borderless printing is supported with paper sizes Letter, A4, A5, A6, 3x5 in., 4x6 in., 5x7 in., and Hagaki, when printing from your PC.

Note(s)

- A4, A5, A6, DL Envelope and C5 Envelope are International Paper Sizes.

CAUTION

Unsuitable Paper!

- DO NOT insert any sheets of paper into the paper support...
 - that are wet, have been edited with correction fluid, are soiled or have a coated surface.
 - that are held together with office or notebook staples or with tape or glue.
 - that are pasted with note paper.
 - that are creased, crumpled or torn
 - that are curled.

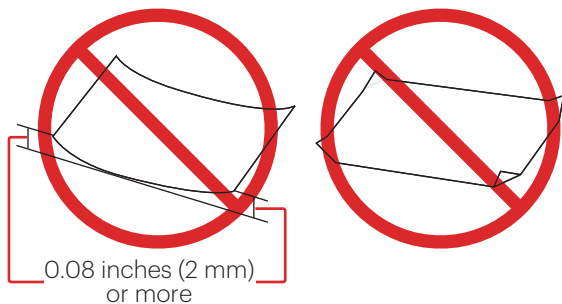

Forms from a Laser Printer!

- Forms that have been printed out by a laser printer are not suitable for further printing.

Note(s)

Curled Paper

- If paper is curled, use it after flattening paper. 0.08 inches (2 mm) or more curl may cause paper jam.

Storing Paper

- To avoid curling, when you do not use the unit, unused paper is put into package, please keep it in a flat state. And also, store it avoiding heat, humidity and direct sunlight.

Insert paper into the paper support

- 1 Slide the paper guide to left side.

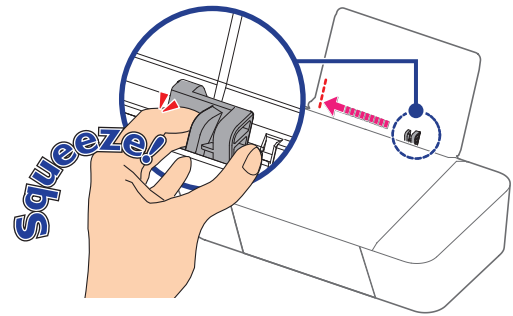

- 2 Fan the plain paper to be printed and then tap the paper sheets so the ends are all the same.

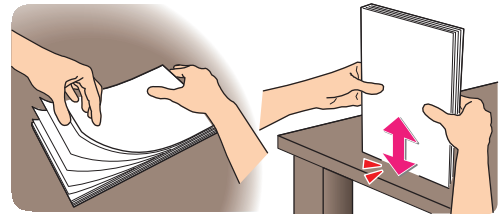

- 3 Insert the paper into the paper support. You can load up to 60 plain paper sheets (20 lb. or 75 g/m²). Slide the paper guide firmly against the edge of the paper.

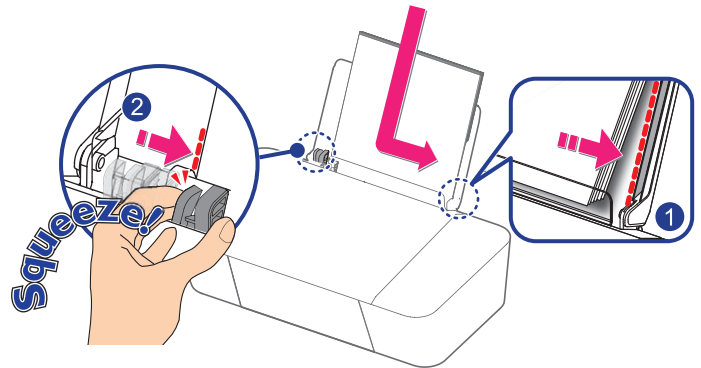

- 4 Open the paper exit tray and exit tray extender.

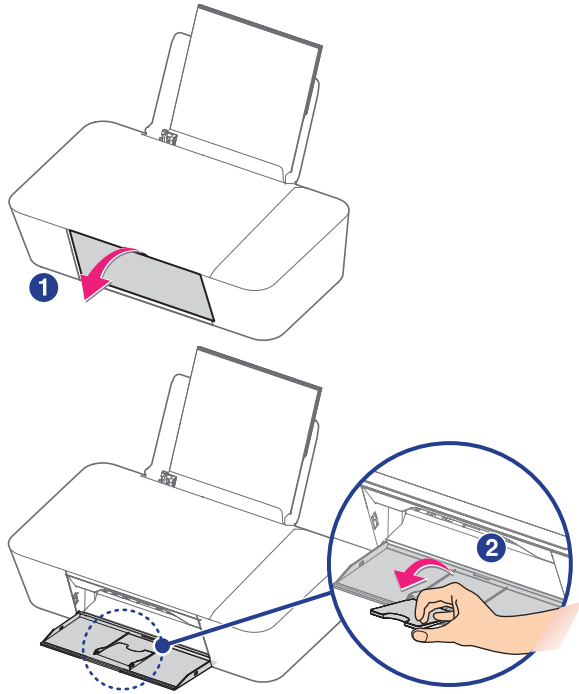

Note(s)

Loading Envelopes

- Insert the envelopes into the paper support. You can load up to 5 envelopes. Place the envelopes with the non-printed side facing forward in the paper support.

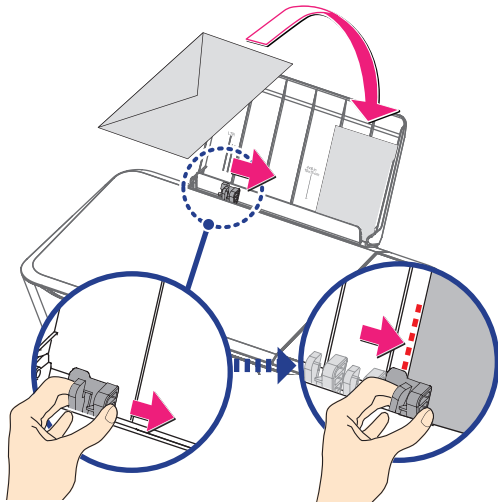

Loading Pre-printed Material

- If you would like to print on an input sheet (for example, forms or stationery), place the input sheet with the Pre-printed side facing front in the paper support.

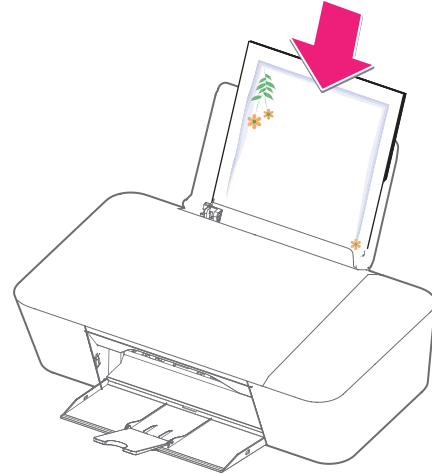

CAUTION

Forms from a Laser Printer!

- Forms that have been printed out by a laser printer are not suitable for further printing.

Child Safety

- DO NOT pull out the paper support swiftly, otherwise the tray may fall resulting in injury.

- 5 Make sure the inserted paper format and paper type matches the printer settings.

» Refer to "Print settings" on page 29.

CAUTION

- DO NOT reverse the direction when loading envelopes.

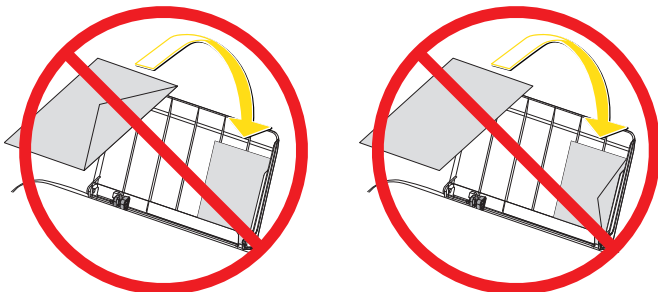

Print settings

Confirming Printing Preferences for Windows®

Note(s)

Microsoft® Windows® Screenshots

- The screen shots in this guide were made with Windows® 10. If you use Windows® OS other than Windows® 10, the screen interfaces look slightly different. The functions, however, are the same.

Edit print settings

When you print a document, the **[Print]** dialog box appears. Select **[VERITE 50]** (this unit) and click on **[Properties]** or **[Preferences]** and such. The changes to the settings only apply to a print job of the respective application and only until this application is closed.

Select default print setting on the Quick menu

You can adjust the default print settings using the **[Quick]** menu. Click on **[Start] > [Settings] > [Devices] > [Devices and printers]**. Right click on the name of the unit and select **[Printer properties]**. Click on **[Preferences...]** in the **[General]** tab.

Note(s)

[Devices and printers] on Windows® OS other than Windows® 10

- Right-click on the Windows® start menu, click **[Control Panel]**, **[Hardware and Sound]** and **[Devices and printers]** (Windows® 8.1).
- Right-click at the bottom left corner on your desktop, click **[Control Panel]**, **[Hardware and Sound]** and **[Devices and printers]** (Windows® 8).
- From the Windows® start menu, click **[Devices and printers]** (Windows® 7).
- From the Windows® start menu, click **[Control Panel] > [Hardware and Sound] > [Printers]** (Windows® Vista).

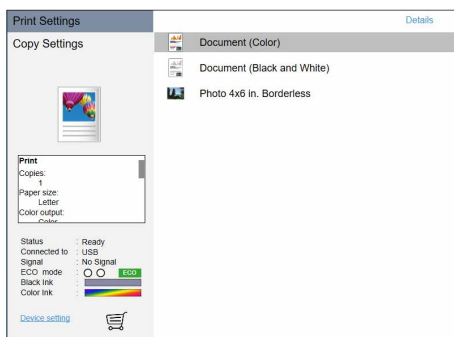

Quick

After you have selected one of the default settings you want to change the selection will be saved when you click **[X]** to close the **[Quick]** menu window.

Edit detailed print setting on the Details menu

Click **[Details]** on the top right corner if you want to change specific detailed settings.

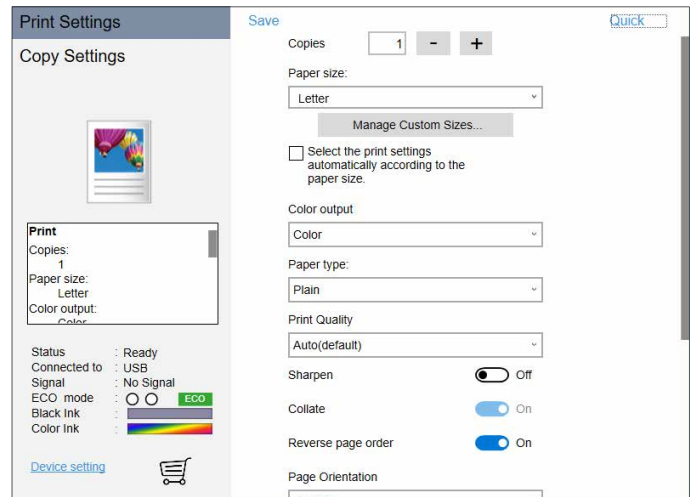

Change to ECO Mode:

You can easily use less Ink.

[○○]	ECO mode is not effective.
[●○]	ECO mode is effective for saving 20% ink.
[●●]	ECO mode is effective for saving 20% ink and reducing 12% printed area.

- For more details, refer to “ECO mode” on page 21.

Copies:

Enter the number of copies you would like to print. Activate **[Collate]**, if you would like to print the copies sorted and not have all the copies of one page behind each other in succession. Activate **[Reverse page order]**, if you would like to change the print order to print the last page of your document first.

Paper size:

Select the format of the document.

- Letter (8 1/2 x 11 in)
 - Letter Borderless
- Legal (8 1/2 x 14 in)
- Executive (7 1/4 x 10 1/2 in)
- Statement (5 1/2 x 8 1/2 in)
- A4 (210 x 297 mm)
 - A4 Borderless
- JIS B5 (182 x 257 mm)
- A5 (148 x 210 mm)
 - A5 Borderless
- A6 (105 x 148 mm)
 - A6 Borderless
- Postcard (4 x 6 in.)
 - Postcard (4 x 6 in.) Borderless
- Index Card (3 x 5 in.)
- 5x7 in.(2L) (127 x 178 mm)
 - 5x7 in.(2L) Borderless
- 3.5x5 in.(L) (89 x 127mm)
 - 3.5x5 in.(L) Borderless
- Hagaki (100 x 148 mm)
 - Hagaki Borderless
- Envelope #10 (4 1/8 x 9 1/2 in)
- Envelope DL (110 x 220mm)
- Envelope C5 (162 x 229mm)

Note(s)

- A4, JIS B5, A5, A6, Hagaki, Envelope DL and Envelope C5 are International Paper Sizes.**

Adjusting this setting in the print settings of each application is the best option as many programs overwrite the settings of the printer driver.

You can also create, edit or delete to manage custom paper size by selecting **[Manage Custom Sizes...]**.

[Select the print settings automatically according to the paper size.] can be selected depend on the paper size.

Color Output:

Select print output for **[Color]** or **[Black and White]**.

[Color]	Color print
[Black and White]	Black-and-white print

Paper type:

Select the desired paper type. Ensure that the selected paper size is used.

Print Quality:

Select the Quality settings to match the document type to be printed. You can select the type of Print Quality **[Auto/Draft/Normal/Best]**.

[Auto (default)]	Printing with a quality suitable for the paper type that is selected.
[Draft]	High-speed printing, but low image quality.
[Normal]	Standard speed printing and image quality.
[Best]	Highest quality image, but printing speed is low.

Sharpen:

Adds sharpness to the image.

[On]	Activates Sharpen.
[Off]	Deactivates Sharpen.

Collate:

The Collate feature controls the order of printed pages when printing multiple copies of a document. For example, if you are printing two copies of a five-page document, then the page order of the collated output would be 1, 2, 3, 4, 5, 1, 2, 3, 4, 5. The page order of the non-collated output would be 1, 1, 2, 2, 3, 3, 4, 4, 5, 5.

[On]	Activates Collate
[Off]	Deactivates Collate

Reverse page order:

[On]	Print from the last page.
[Off]	Print from the first page.

Page Orientation:

This function allows you to select the direction of printing on a page. You can set whether to print in Portrait or Landscape format. Adjusting this setting in the print settings of the application is the best option as many programs overwrite the settings of the printer driver.

[Portrait]	Portrait indicates vertical orientation, where the page is taller than it is wide.
[Landscape]	Landscape indicates horizontal orientation, where the page is wider than it is tall.

Resizing Options:

If you would like to resize the printing document, click on **[On]**.

[On]	Resizes the printing document to the selected paper size.
[Off]	Does not resize. Keep the document size.

Print on both sides (Duplex):

You can select whether to print on one side only or manually print on both sides.

[On]	Prints manually on both sides.
[Off]	Prints on one side.

Note(s)**When [Print on Both Sides] is set to On.**

- When “Manually print on both sides” is selected for two-sided printing, this unit will operate as follows:
 - 1 Odd pages will be printed.
 - 2 After completion of odd page printing, a pop-up menu will appear on your PC. Follow the instructions in the pop-up menu.

After the pop-up menu has appeared, you must manually turn the stack of printed pages over and place them in the paper support.

Before placing the pages with the front printed sides in the paper support, make sure of the following items to avoid a paper jam or double-feed:

 - All other paper (unused paper) has been removed from the paper support.
 - The ink is completely dry.
 - The paper is not curled or creased. If it is, flatten the paper.
 - Align the corners of the paper.
 - A paper jam or double-feed may occur if the paper is in a bad condition or the printed page is placed incorrectly.
 - Maximum number of sheets by paper type:
Plain paper (20 lb.): 30 sheets (60 pages)
Postcard: 15 sheets
 - 3 Click **[OK]** in the pop-up menu, then even-numbered pages will be printed.
 - * Because the default setting is **[Reverse page order]**, for an even-numbered document, odd-numbered pages will be printed after even-numbered pages are printed.

Page Layouts:

[Normal]	Prints the Normal printing.
[Multiple pages per side(N-UP)]	Prints Multiple pages on one side of a paper for the page layout e.g. like 2 pages printed on 1 sheet of paper like a book.
[Poster]	Prints a document in a larger format. The Poster option lets you enlarge a print job to several times the standard size.
[Mirror]	Prints a horizontally flipped document

Note(s)**When [Poster] is selected.**

- Depending on the poster size that you select, your document is divided into an equal number of sections, each of which prints on a full sheet of paper. When all sections have printed, you can trim the extra white space around each page and join the individual sheets to create a poster. Supported size of poster - 2 x 2 (4 pages), 3 x 3 (9 pages), or 4 x 4 (16 pages).

Watermark:

You can choose a watermark from two modes. (Same watermark on all pages or a different watermark on first page.) Select a watermark that you would like to add to your print job.

[Use the same watermark on all pages]

- (None)
- Confidential
- Date and Time
- Draft
- Username

[First page]

You can choose the same selection above ([[None]]) to [Username] on the first page.

[Other pages]

You can choose the same selection above ([[None]]) to [Username] on the other pages.

To add or remove watermark, click on [Edit Watermarks].

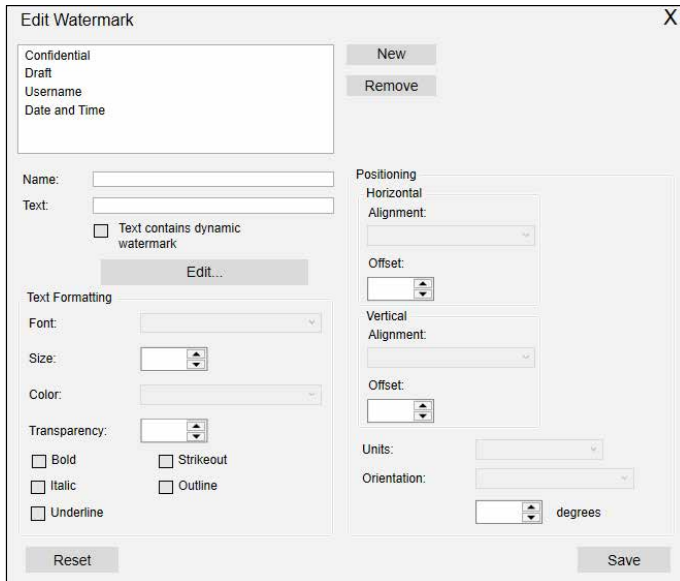

Save Detail changes

Click on [Save] on the [Details] settings in the top left corner to save the changes to the respective register.

The saved configuration information will be managed by names. You can type the substitute name for [Custom 1] when [Save Print Settings] windows appears.

Click on [Quick] or [X] to close the [Details] settings window without saving.

Delete Custom settings

You can delete custom settings by Quick menu. Select the one of the registered settings, then click [Delete].

Confirming Print Settings for Mac

Note(s)

Macintosh Screenshots

- The screen shots in this guide were made with the Preview (Applications) of OS X 10.11. If you use another version of OS X or another application, the screen interfaces look slightly different. The functions, however, are the same.

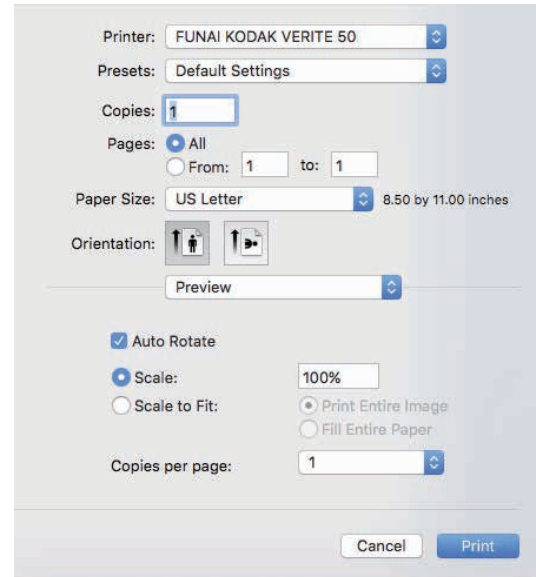

Paper Size:

Select the format of the document. Adjusting this setting in the print settings of each application is the best option as many programs overwrite the settings of the printer driver. You can also create and manage custom paper size by selecting [Manage Custom Sizes...].

Orientation:

Choose Portrait or Landscape output.

Edit Print Settings for a print job

When you print a document, follow the Steps below.

- 1 Open the file you want to print.
- 2 Select [File] on the menu bar.
- 3 Select [Print...], then the Printer Setting menu will be displayed.
- 4 If details are not displayed, select [Show Details] on the bottom of the Print Menu. You can edit Print Settings when details are displayed.

Save changes

- 1 Click on **[Presets]** list box, and select **[Save Current Settings as Preset...]**. The saved configuration information will be managed by names.
- 2 Input name in **[Preset Name:]** textbox, then select **[Preset Available For:]** radio button.
- 3 Click on **[OK]** to save and close the window.
- 4 Select **[Cancel]** to close window without saving.

Load settings

- You can access the saved settings quickly by selecting a name from **[Show Presets...]** in **[Presets]** list box.

Change Print options

- In the Print Setting menu, select the Print options you want to change in the red frame below.

Printer: FUNAI KODAK VERITE 50
Presets: Default Settings
Copies: 1
Pages: All
 From: 1 to: 1
Paper Size: US Letter 8.50 by 11.00 inches
Orientation: Portrait Landscape
Preview
 Auto Rotate
Scale: 100%
 Scale to Fit: Print Entire Image Fill Entire Paper
Copies per page: 1
Cancel Print

Preview

Preview
 Auto Rotate
Scale: 100%
 Scale to Fit: Print Entire Image Fill Entire Paper
Copies per page: 1
Cancel Print

Auto Rotate:

Automatically selects portrait or landscape.

Scale:

Enter the scaling ratio.

Scale to Fit:

Input the scaling ratio of **[Print Entire Image]** or **[Fill Entire Paper]** automatically.

Copies per page(s):

Print multiple copies of the page(s).

Layout

Layout
Pages per Sheet: 1
Layout Direction: Portrait Landscape
Border: None
Two-Sided: Off
 Reverse page orientation
 Flip horizontally
Cancel Print

Pages per Sheet:

Print multiple pages on one sheet.

Layout Direction:

If you print multiple pages on a sheet, select the layout direction.

Border:

Print the border on the sheet.

Reverse page orientation: If you would like to reverse page orientation, select the checkbox.

Flip horizontally:

If you would like to flip horizontally, select the checkbox.

Paper Handling

Paper Handling
 Collate pages
Pages to Print: All pages
Page Order: Automatic
 Scale to fit paper size
Destination Paper Size: Suggested Paper: US Letter
 Scale down only
Cancel Print

Pages to Print:

If you would like to print odd/even pages only, select **[Odd only]** or **[Even only]**.

Page Order:

If you would like to print in reverse order, select **[Reverse]**.

Scale to fit paper size:

If you would like to scale to fit your printer paper, select the checkbox and select **[Destination Paper Size]**.

Destination Paper Size:

Select the paper size to scale.

Scale down only:

If you don't want to scale up, select the checkbox.

■ Cover Page

If necessary, you can print the cover page.

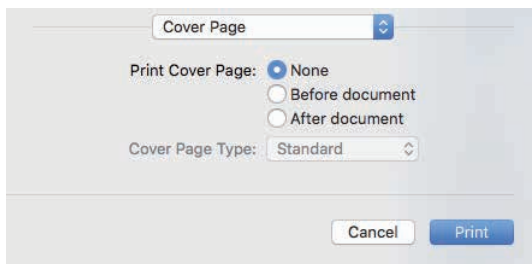

Print Cover Page:

If you would like to print the cover page, select **[Before document]** or **[After document]**.

Cover Page Type:

If you would like to print the Cover Page, select the type of Cover Page.

■ Quality & Media

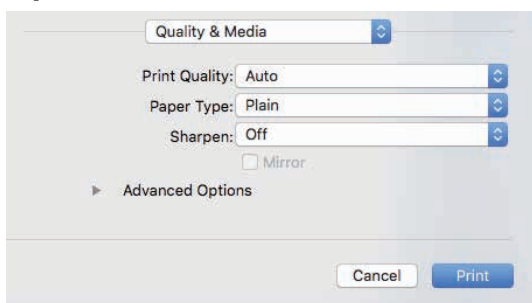

Print Quality:

Select the Quality settings to match the type of document to be printed. You can select the type of Print Quality **[Auto/Draft/Normal/Best]**.

[Auto]	Printing with a Quality suitable for the type of Paper that is selected.
[Draft]	High-speed printing, but low image quality.
[Normal]	Standard speed printing and image quality.
[Best]	Highest quality image, but printing speed is low.

Paper Type:

Select the desired Paper Type. Ensure that the selected paper size is used.

Sharpen:

Activate Sharpen, if you would like to add sharpness to the image.

■ Advanced Options

Color Output:

Select the Print output using **[Color]** or **[Black & White]**.

Making Copies

The Copy function is available using  (Copy) on the unit.

- 1 Lift the scanner lid on the unit.
- 2 Load the original print side down on the scanner glass.

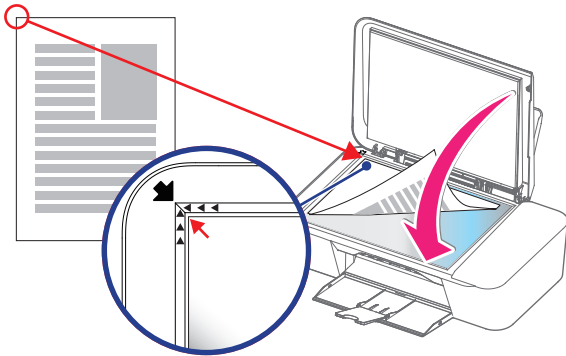

- 3 Close the scanner lid.
- 4 Specify the Settings as necessary.
- 5 Press  (Copy).



- 6 The unit will start copying.
 - To cancel Copy mode, press and hold  (Power).

Copy Setting

Printing using the available print application.
From the Windows® start menu, select **[All apps] > [KODAK VERITE 50] > [Copying]**.

Copies

Set the number of Copies.

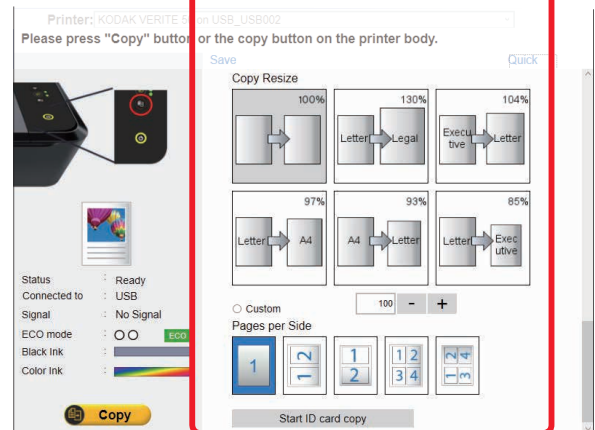
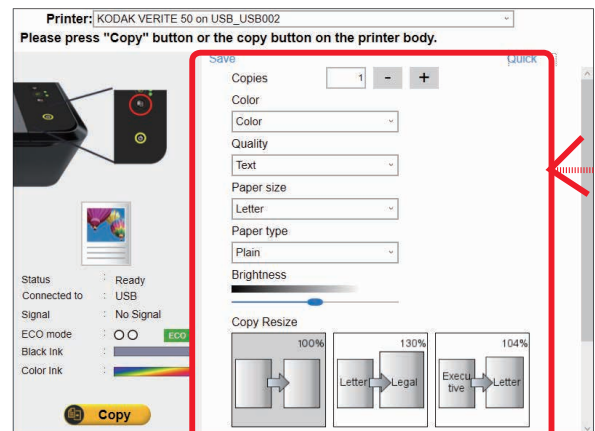
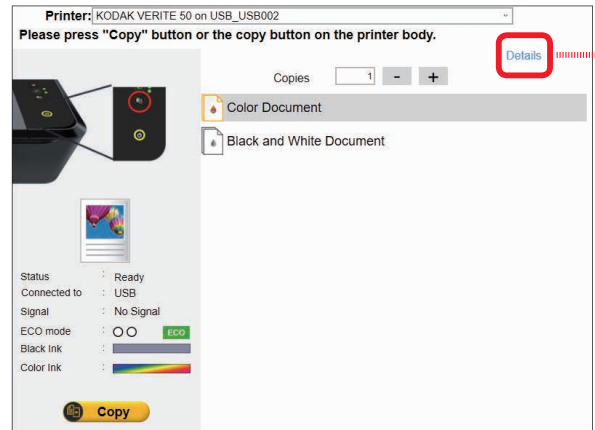

- 1 Select the number of copies **[1]** to **[99]**.
Enter the number **[1]** to **[99]** directly in the box, or click **[+]** to increase the number of copies or **[-]** to decrease the number of Copies.
- 2 Click **[Copy]** or press  (Copy).

■ Color

Set the copy Color setting from pull-down menu.

- Color
- Black and White

■ Quality

Set the copy Quality from pull-down menu.

- Text
- Photo
- Text/Photo
- Draft

■ Paper Size

Set the Paper Size for the document copy from pull-down menu.

- Letter
- Legal
- Executive
- Statement
- A4
- JIS B5
- A5
- A6
- Postcard (4 x 6 in.)
- Index Card (3 x 5 in.)
- 5 x 7 in. (2L)
- 3.5 x 5 in. (L)
- Hagaki
- Envelope #10
- Envelope DL
- Envelope C5

□ Note(s)

- A4, JIS B5, A5, A6, Hagaki, Envelope DL and Envelope C5 are International Paper Sizes.

■ Paper Type

Set the Paper Type from pull-down menu.

- Plain
- Labels
- Envelope
- Glossy Photo
- Matte Photo

■ Brightness

Set the level of Brightness. Adjust the slider to the right to get lighter and to the left to get darker.

■ Copy Resize

Set the Resize for enlarging or compressing the document copy from pull-down menu.

- 100% Default
- 130% Letter->Legal
- 104% Executive->Letter
- 97% Letter->A4
- 93% A4->Letter
- 85% Letter->Executive
- Custom*

* You can select custom Resize range from 25% to 400%. Enter the number [1] to [99] directly in the box, click [+] or [-] to select the Resize value. The default value is 100%.

⚠ CAUTION



- [Copy Resize] and [Pages per side] can never be set at the same time. If either setting is set, another one will be reset to the [Copy Resize]: [100%] or [Pages per side]: [One].

■ Pages per Side

You can copy multiple pages on one sheet by printing smaller images on each page.

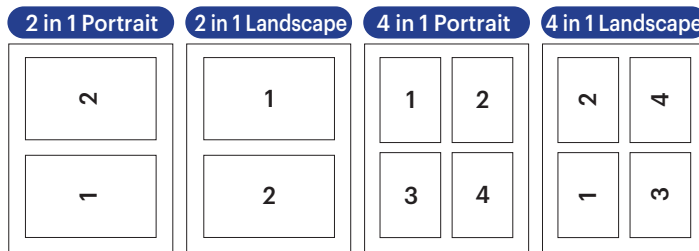
- 1 Lift the scanner lid on the unit.
- 2 Load the original print side down on the scanner glass.
- 3 Close the scanner lid.
- 4 Click either printing option
 - One
 - 2 in 1 Portrait
 - 2 in 1 Landscape
 - 4 in 1 Portrait
 - 4 in 1 Landscape



- 5 Click [Copy] or press  (Copy).
- 6 Remove the first page from the scanner glass and place the next page.
- 7 Click [Copy] or press  (Copy) to continue scanning the next page. Repeat this until you have scanned all the pages.

⚠ CAUTION

- [Copy Resize] and [Pages per side] can never be set at the same time. If either setting is set, another one will be reset to the [Copy Resize]: [100%] or [Pages per side]: [One].

ID Card Copy

You can copy both sides of a small document (e.g. ID card, business card) onto one page.

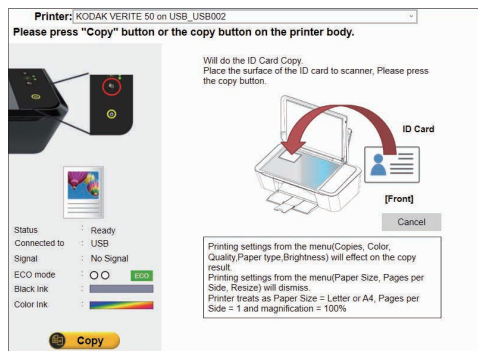

Note(s)

- This function is valid only with Letter or A4 size paper.

- 1 Click **[Start ID card copy]**.
- 2 Load plain Letter or A4 size paper on the paper support.
- 3 Lift the scanner lid on the unit.
- 4 Load the front side of the ID card facedown on the scanner glass in the left rear placement corner with arrows and then Click **[Copy]** or press  (Copy), then Copying process will start.

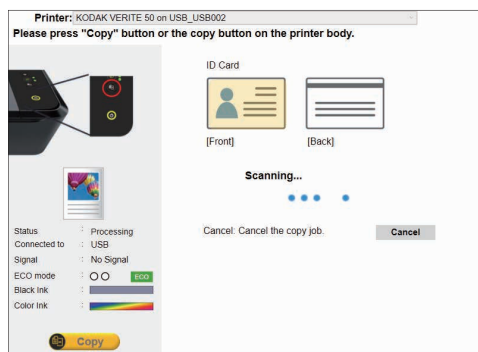

- 5 Lift the scanner lid on the unit, flip ID card over and click **[Copy]** or press  (Copy).

Note(s)

- If you have changed the Paper Settings in the Setup Menu, the default value of Paper Settings in the Copy Menu will also be changed.

Scanner

You can use a variety of scanner functions from your smartphone/tablet or PC. The "Scanning" application is available if your PC has a Windows® platform.

The scanner function is also available by using an application called "Image Capture" bundled as a default for OS X.

Or the mobile App for Android™ and iOS. For information on the mobile App, refer to "Print using your smartphone/tablet" on page 22.

Note(s)

- You cannot use the scan function directly with this unit.
- Load the original print side down on the scanner glass. Make sure to align the original print to the left rear corner of the scanner glass with arrow marks.

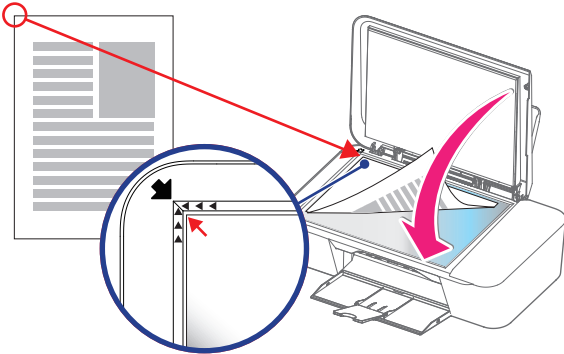

- The readable area of the scanner is not equal to the area of the scanner glass. Therefore, when placing the document in the left rear corner of the scanner the edges of the document may not be scanned.
- 0.079 inch (2 mm) is missing on the short side, and 0.024 inch (0.6 mm) is missing on the long side of the scan area.

Scan in [Scanning] application by Windows®

Run [Scanning] from the [Start] menu as it appears in the window below.

From the Windows® start menu, select [All apps] > [KODAK VERITE 50] > [Scanning].

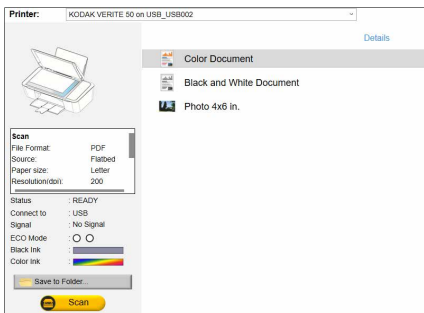

Click [Scan] to start the scanning.

Settings

If you would like to change the settings, click [Details].

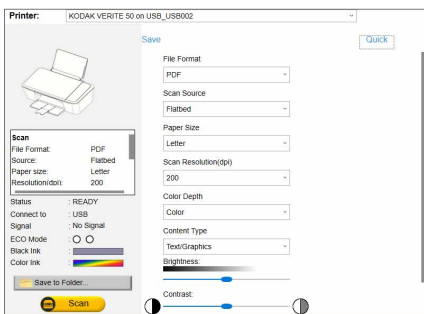

File Format:

Select the File Format from below:

- JPEG
- PDF

Paper Size:

Select the Paper Size from below:

- Letter
- Executive
- Statement
- A4
- JIS B5
- A5
- A6
- Postcard (4x6 in.)
- Index Card (3x5 in.)
- 5x7 in.(2L)
- 3.5x5 in.(L)
- Hagaki
- Envelope #10
- Envelope DL
- Envelope C5
- Entire Flatbed (216x297mm)

Note(s)

- A4, JIS B5, A5, A6, Hagaki, Envelope DL and Envelope C5 are International Paper Sizes.
- Entire Flatbed (216x297mm) is the setting that scans the entire scanner glass.

Scan Resolution (dpi):

Select the scan Resolution from below:

- 75 dpi
- 100 dpi
- 150 dpi
- 200 dpi
- 300 dpi
- 600 dpi
- 1200 dpi

Note(s)

- Scanning at 2400 dpi or more is available on the "High Resolution Scanning" application included with the Software.

Color Depth:

Select the scan Color Depth from below:

- Color
- Gray
- Black & White

Content Type:

Specify the Content Type of the scan document from below:

- Text
- Text/Graphics
- Photo

Brightness:

Select the Brightness level. Adjust the bar toward the left end to set the reproduction darker. Adjust the bar toward the right end to set the reproduction lighter. The Brightness level will be reflected in the scanned data.

Contrast:

Select the Contrast level. Adjust the bar toward the left end to reduce the Contrast. Adjust the bar toward the right end to increase the Contrast. The Contrast level will be reflected in the scanned data.

Background Removal:

Select Background Removal to remove the background on the scan data. The Background Removal feature adjusts the amount of background that is visible in the scanned data.

Save to Folder:

If you would like to change the Folder to Save the scanned file to, click [Save to Folder...].

- 1 Click on [Save to Folder...], then [Browse For Folder] will appear.
- 2 Select the Folder you want to save the scanned file to, then click [OK].
- 3 The scanned file will be Saved to the selected Folder.
 - The Folder you have chosen is automatically selected for the next time. Perform Step 1 and 2 if you want to save the scanned file to another Folder.

Scan in Mac

Run the Image Capture application. (Scanning with other applications such as "Preview" is a very similar process.)

Simplified scan mode

In the "Simplified" scanner interface, follow these Steps:

- 1 Place the document you would like to scan on the scanner glass.
- 2 Open Image Capture located in the Applications folder.
- 3 Select this unit from the list of devices.
- 4 Select the desired destination where the scanned document is to be saved from the **[Scan To]** pop-up menu.
- 5 Click **[Scan]** to start scanning.
- 6 A preview will appear on your monitor when scanning is completed.

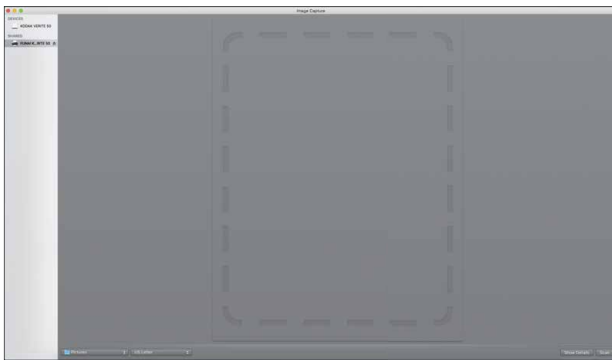

Advanced scanning options

In the "Simplified" scanner interface, click **[Show Details]** if you want to enter a detailed scan mode with more advanced options.

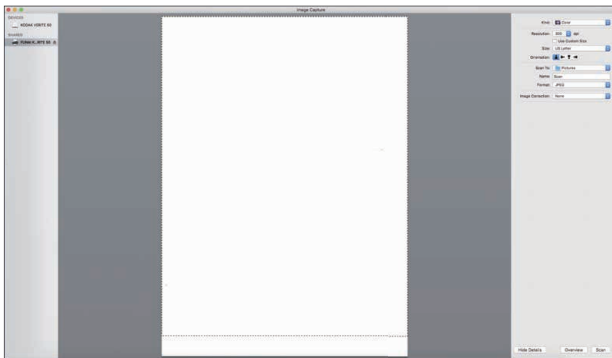

Kind:

Select the scan type from below:

- **Color**
 - **Black & White**
 - **Text**
- Choose "Color" to scan an object in Color.
 - Choose "Black & White" to scan an object in Grayscale (256 or Thousands of grays).
 - Choose "Text" to scan text documents.

Resolution:

Select the scan Resolution from below:

- **75 dpi**
- **150 dpi**
- **300 dpi**
- **1200 dpi**
- **100 dpi**
- **200 dpi**
- **600 dpi**

- Select the **[Use Custom Size]** checkbox to enable the **[Size]** fields to specify the width and height you want to scan. Select pixels, inches or cm (centimeters).

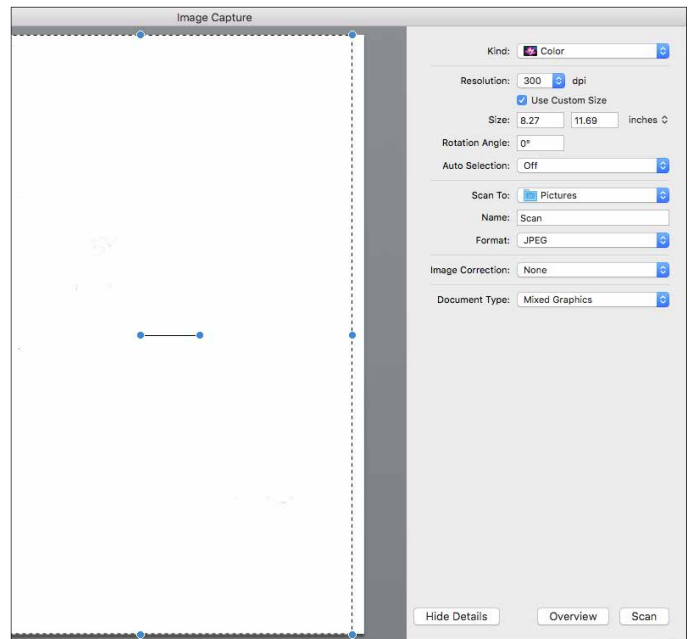

Rotation Angle:

Set the number of degrees for the clockwise rotation of your scanned image.

Auto Selection:

Choose one of the following from the **[Auto selection]** pop-up menu.

[Off]	to normally select the object.
[Detect Separate Items]	to automatically select and straighten the objects you are scanning.
[Detect Enclosing Box]	to include all the items on the scanner bed in one image.

Scan To:

Select the desired destination where the scanned document is to be saved.

Name:

Enter the name of scanned images. For multiple scans, the name entered will be a part of incrementally named scans. For example, enter "doc", and the names of the scanned images will be "doc1.jpeg", "doc2.jpeg", and so forth.

Format:

Select the image format of the scan from below:

- JPEG
- BMP
- TIFF
- PDF
- PNG

- **[Combine into single document]** is only available when the format PDF or TIFF is selected. In order to save multiple pages as a single file, select the checkbox.

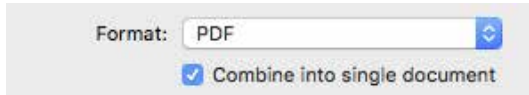

Image Correction:

When **[Manual]** is selected, the adjustment of the following parameters are possible.

Document Type:

Select the type of document to be scanned from below:

- Text Only
- Photo
- Mixed Graphics

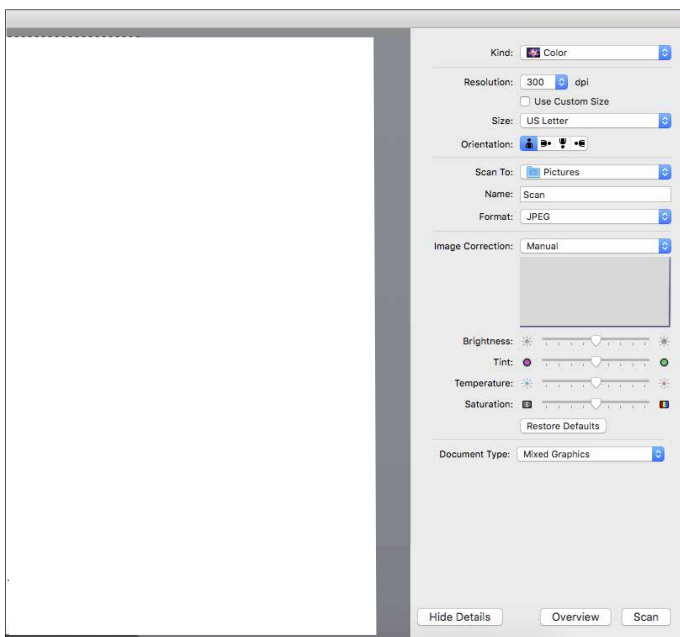

When choosing [Color] in [Kind:]

[Brightness]	to adjust the balance between light and dark.
[Tint]	to adjust the Color balance between red and green.
[Temperature]	to adjust the Color balance of warm and cool.
[Saturation]	to adjust the vividness of Colors.

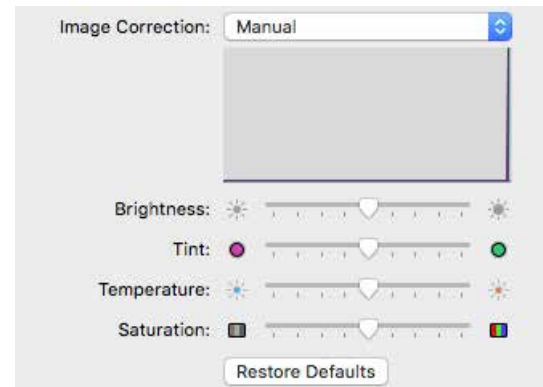

When choosing [Black & White] in [Kind:]

[Brightness]	to adjust the balance between light and dark.
[Contrast]	to adjust the balance of sharpness and softness.



When choosing [Text] in [Kind:]

- **[Threshold]** to adjust the transition point between dark and light.

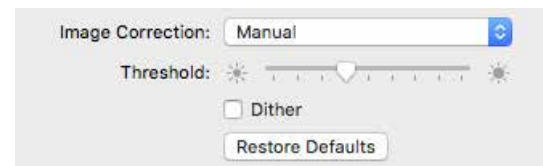

Note(s)

- Those images are created based on the screen of OS X 10.11. If the version of the OS is different or the OS is updated, it is possible that the display on the screen has changed.
- When Dither is checked the printer will only use Black and White or Color Dots and no Grayscale or Multicolor dots are used (e.g. Newspaper photographs are Dithered).

Settings

You can set up the unit as you like depending on your needs.

- From the Start Menu, activate **[Device setting]**.

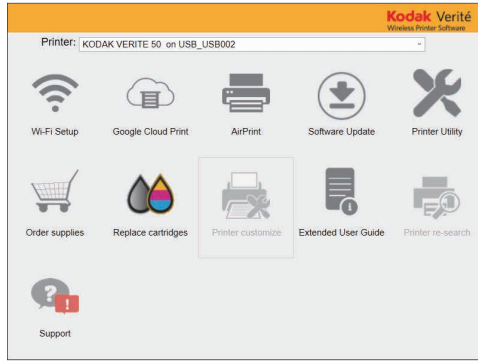

Wi-Fi Setup

You can set the following Wi-Fi settings.

- Click **[Wi-Fi setup]**.

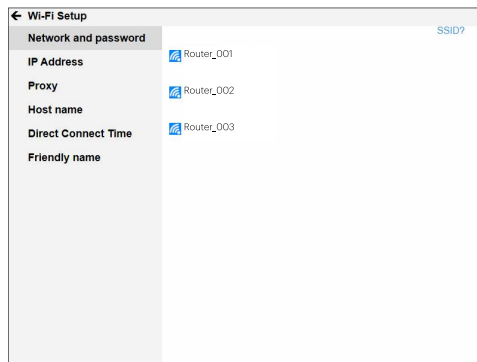

Network and Password

If you would like to connect to a router manually, follow the Steps below.

- 1 Click the SSID you would like to connect.

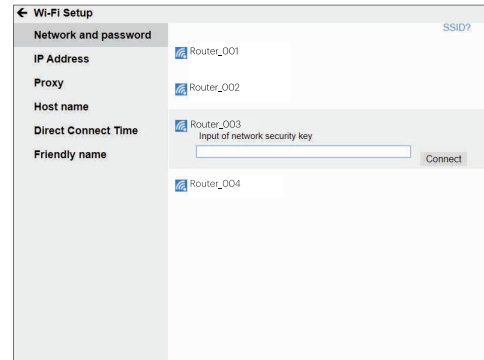

- 2 Enter Password and click **[Connect]**.

IP Address

- 1 Click **[IP Address]**.

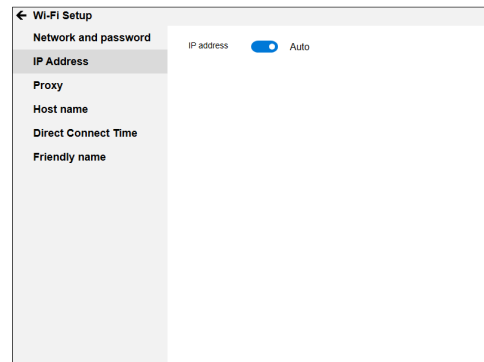

- 2 Select **[Auto]** or **[IP address]**.

[Auto] DHCP (Dynamic Host Configuration Protocol) mode

It's easy to Automatically get the IP address of this unit from the Network.

[IP address] Static mode

Set the Network address manually.

- 3 If you select **[Manual]**, set the items below.

- IP Address
- Subnet Mask
- Default gateway
- DNS address

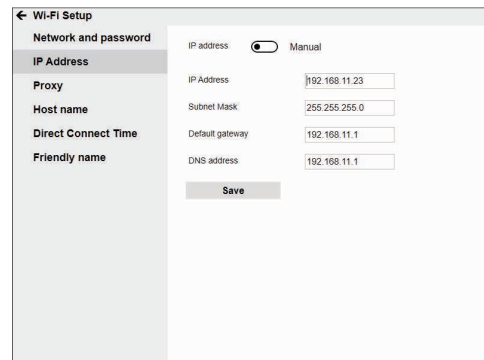

- 4 Click **[Save]**.

Proxy

1 Click [Proxy].

The screenshot shows the 'Wi-Fi Setup' screen. The 'Proxy' option is selected in the left-hand menu. The main area shows a toggle switch for 'Proxy' which is currently set to 'OFF'.

2 Select [OFF] or [Proxy].

3 If you select [Proxy], set the items below.

- Address
- Port

The screenshot shows the 'Wi-Fi Setup' screen with 'Proxy' selected. The 'Proxy' toggle is now 'ON'. Below it, there are input fields for 'Address' and 'Port', and a 'Save' button.

4 Click [Save].

Host Name

1 Click [Host name].

The screenshot shows the 'Wi-Fi Setup' screen with 'Host name' selected in the left-hand menu. The main area shows a text input field containing 'Verite50-0000' and a 'Save' button. A note above the field states: '"Host name" is the name of the printer on the network.'

- Current Host Name is displayed.

2 If you would like to change it, enter Host Name.

3 After entering the Host Name, click [Save].

Direct Connect Time

1 Click [Direct Connect Time].

The screenshot shows the 'Wi-Fi Setup' screen with 'Direct Connect Time' selected in the left-hand menu. The main area shows a pull-down menu for 'Direct Connect Time' currently set to '5 min'. A note above the menu states: 'For a long time no operation, the application exits.'

2 Select Direct Connect Time from pull-down menu.

- Disconnect
- 5 min
- 10 min
- 60 min
- Unlimited

- If you select [Unlimited], when the mobile is connected by Direct Mode until selecting [Disconnect] this unit remains in the Direct Mode.

- If you select [Disconnect], the Direct Connection will be immediately terminated.

Friendly name

1 Click [Friendly name].

The screenshot shows the 'Wi-Fi Setup' screen with 'Friendly name' selected in the left-hand menu. The main area shows a text input field containing 'FUNAI KODAK VERITE 50' and a 'Save' button. A note above the field states: '"Friendly name" is the printer name to be used is iOS(Apple).'

2 Enter the name you would like.

3 After entering the Friendly Name, click [Save].

Google Cloud Print™

You can set the Google Cloud Print™ settings.

- Click **[Google Cloud Print]**.

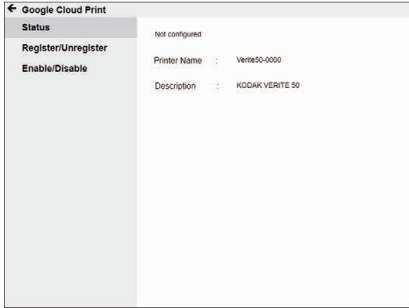

Status

1 The Google Cloud Print™ connection (or registration) status, unit name, and unit description will be displayed.

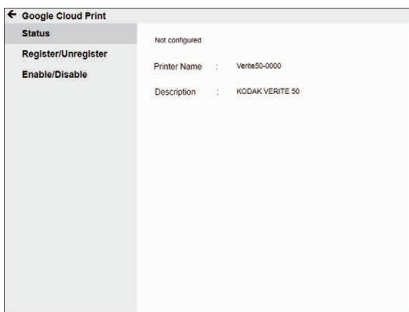

The following table shows the Google Cloud Print™ service registration and connection status of this unit.

Status	Unit state
Not configured	Unit is not registered to the Google Cloud Print™ service. The Google Cloud Print™ feature is not available.
Disabled	The Google Cloud Print™ service has been disabled. The Google Cloud Print™ feature is not available. (Unit is registered in the Google Cloud Print™ service.)
Not connected	Unit is not connected from the Google Cloud Print™ service. The Google Cloud Print™ feature is not available. (Unit is registered in the Google Cloud Print™ service.)
Connected	Unit is connected to use the Google Cloud Print™ service. The Google Cloud Print™ feature is available. (Unit is registered in the Google Cloud Print™ service.)
Disconnected	Unit has been disconnected from the Google Cloud Print™ service. The Google Cloud Print™ feature is not available. (Unit is registered in the Google Cloud Print™ service.)
Registration in progress	Registration is in process to use the Google Cloud Print™ service. The Google Cloud Print™ feature is not available. Registration should complete, please wait.

Register to Google Cloud Print™

1 Click **[Register/Unregister]**.

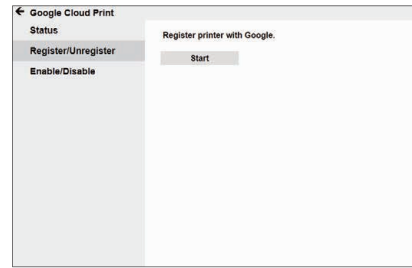

2 Click **[Start]**, then registration will start. The unit will print a registration URL for the Google Cloud Print™ registration.

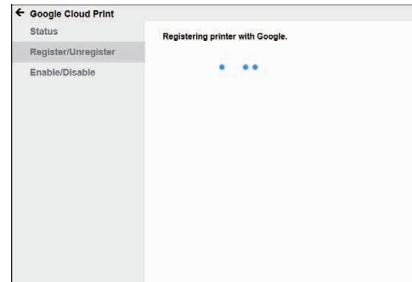

Note(s)

- Load plain Letter or A4 -size paper.

3 Access that registration URL within 14 minutes and follow its instructions.

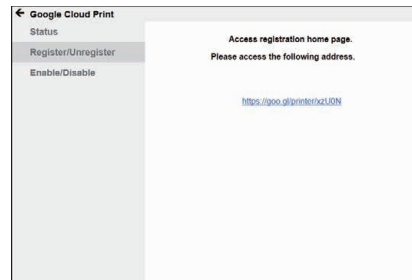

Enable/Disable

1 Click **[Enable/Disable]**.

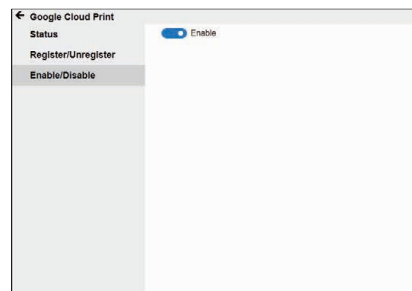

2 Select **[Enable]** or **[Disable]**.

Select Action	Action
Register	Register to Google Cloud Print™
Unregister	Unregister from Google Cloud Print™
Enable	Enable Google Cloud Print™
Disable	Disable Google Cloud Print™

AirPrint

Enable or disable the AirPrint function.

- 1 Select **[Enable]** or **[Disable]**.

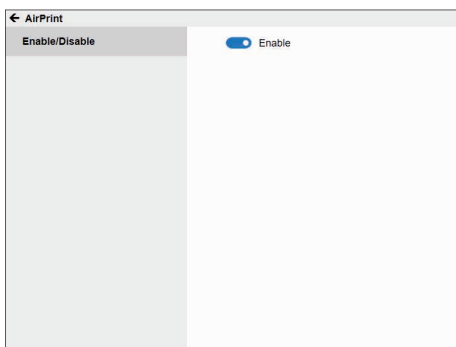

Software update

You can update your printer's Software.

- 1 Click **[Update Now]**, then automatically starts updating.

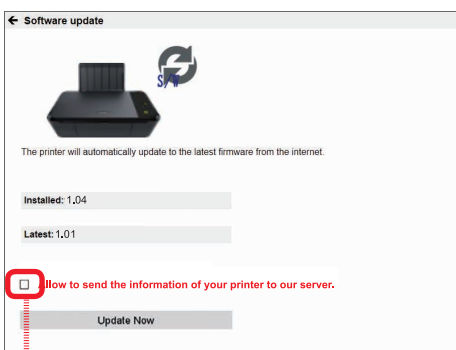

Once you check , the server will receive your printer's data.

Printer Utility

You can perform maintenance operations.

- Click **[Printer utility]**.

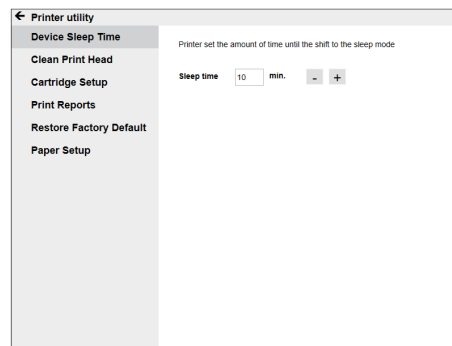

Device Sleep Time

You can set the time to go into Sleep mode.

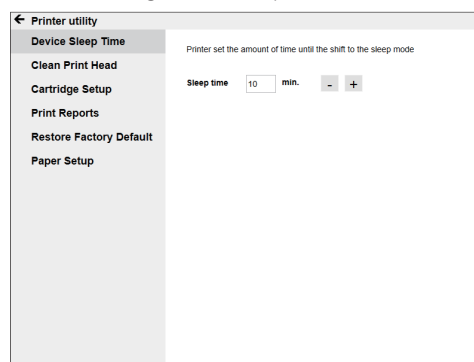

- 1 Enter the number **[1]** to **[120]** directly or click **[-]** or **[+]** by minute.

Clean Printhead

- 1 Load plain blank white Letter or A4 -size paper.
- 2 Click **[Clean Print Head]**.

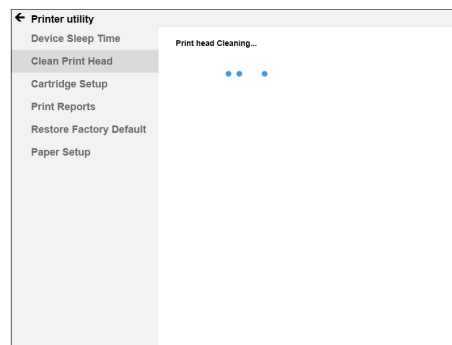

- 3 A page prints, forcing ink through the ink cartridge nozzles to clean them.
- 4 Print the document again to verify that the print quality has improved.

■ Cartridge Setup

Print the alignment pattern for alignment adjustment. By reading the pattern with the scanner, the printer alignment is optimized and the print quality will be better.

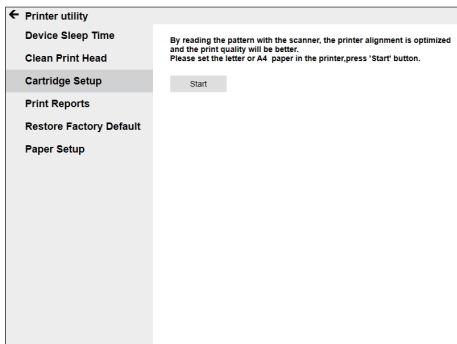

- 1 Load plain blank white Letter or A4 -size paper.
- 2 Click **[Cartridge Setup]**.

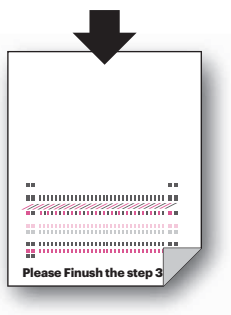
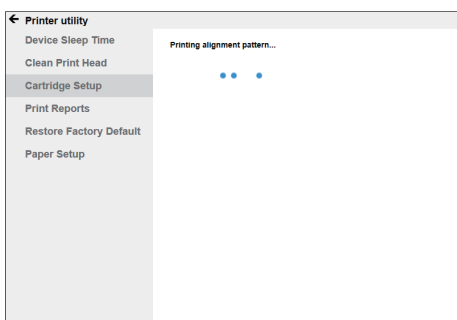

- 3 Click **[Start]**.



- 4 The unit will start printing the alignment pattern.

- The  (Power) LED will light up then blink rapidly. LED lighting pattern is "Blinking 6" .
- » Refer to "Meaning of LED behavior and lights" on page 9.

- 5 Open the scanner lid on the unit. Load the front side of the alignment pattern result facedown at the placement corner of the scanner glass (see below), then click **[Next]** to start the alignment adjustment after closing the scanner lid.

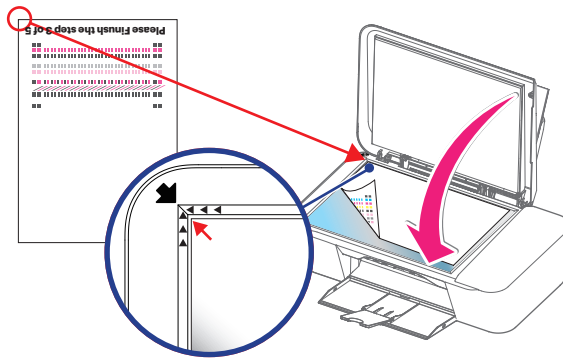

- 6 The unit will start scanning the alignment pattern to set an appropriate alignment on this unit.
- 7 When alignment is completed, **[End Cartridge setup.]** message will be displayed on the PC screen.

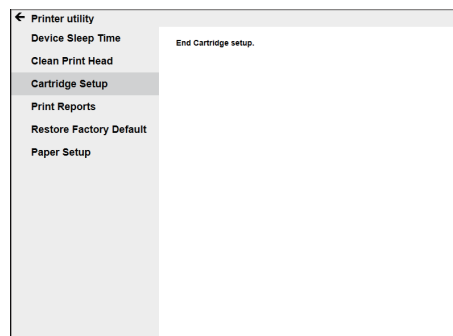

Print Reports

Print out the configuration information.

- 1 Click **[Print Reports]**.
- 2 Click **[Start]** to start printing the configuration report.

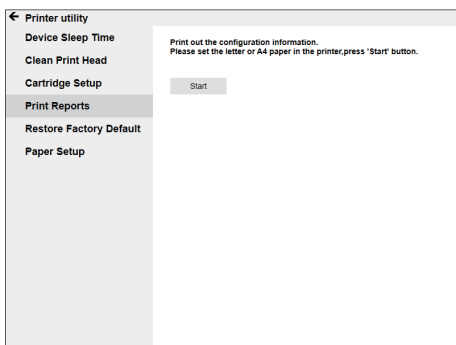

Restore Factory Default

All of the unit settings will be reset to the Factory Default.

- 1 Click **[Restore Factory Default]**.

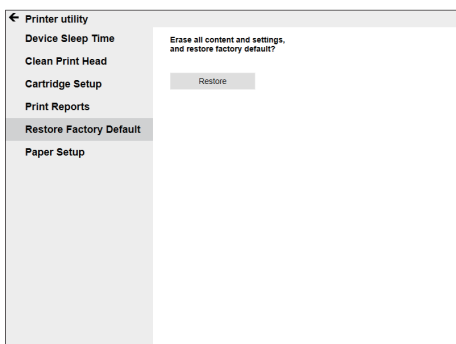

- 2 Click **[Restore]**.
- If you choose **[Restore]**, all settings will be restored to factory defaults and the unit will restart. The connection between PC and printer will be disconnected.

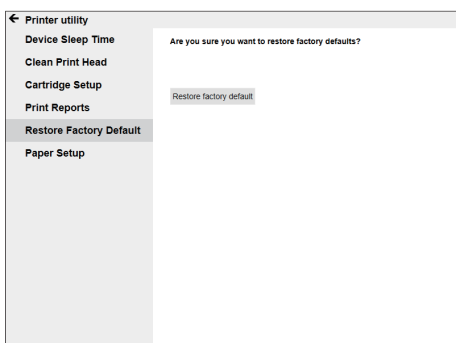

- 3 Click **[Restore Factory Default]**.

Paper Setup

Sets the paper type and paper size.

Note(s)

- If you change the following Paper Settings, the default paper setting values in the Copy Menu will also be changed.
 - This setting will also affect the AirPrint paper size setting.
- Click **[Paper Setup]**.

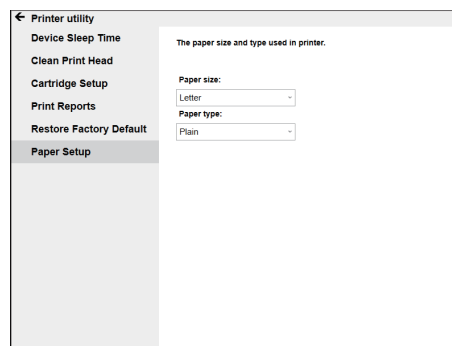

Paper Size

Set the Paper Size for the document copy.

- 1 Select the Paper Size from pull-down menu.
- Letter (8.5 x 11 in.)
 - Legal (8.5 x 14 in.)
 - Executive
 - Statement
 - A4 (210 x 297 mm)
 - JIS B5 (182 x 257 mm)
 - A5 (148 x 210 mm)
 - A6 (105 x 148 mm)
 - KG (4 x 6 in.)
 - Index Card(3 x 5 in.)
 - 5 x 7 in. (2L)
 - 3.5 x 5 in. (L)
 - Hagaki (100 x 148 mm)
 - Envelope #10
 - Envelope DL
 - Envelope C5

Note(s)

- A4, A5, A6, Envelope DL and Envelope C5 are International Paper Sizes.

Paper Type

- 1 Select the Paper Type from pull-down menu.
- Plain
 - Labels
 - Envelope
 - Glossy Photo
 - Matte Photo

Web interface

The Web interface is available to you on all operating systems. You can access the web interface with an Internet browser on your PC and conduct many different settings to your unit. You can access the Web interface if the unit is connected to a Network via Wireless Connection.

Note(s)

- Before you start, make sure your PC and the unit are connected to the SAME NETWORK.
- When the unit is connected to the Network,



(Wireless) LED lights up.

Confirming the IP Address

You will need the current IP address of the unit in order to access the Web interface. You can verify the IP address by printing out the Configuration Report.

» Refer to “Print Reports” on page 45.

Configuration Report		[2017-07-04 07:42:39(UTC)]
Device Information		
Model Name	KODAK VERITE 50	
Serial Number	XXXXXXXXXXXXXXXXXX	
Software Version	X.XX.XXX (XXXXXXXXXX)	
Device Statistics Information		
Printed Page	44	
Scanned Page	65	
Supply Information		
Black Cartridge		
Cartridge Status	Installed	
Cartridge Type	XXL	
Ink Level	43%	
Color Cartridge		
Cartridge Status	Installed	
Cartridge Type	XXL	
Ink Level	75%	
Device Configuration		
Language	English	
Default Paper Size	Letter	
Default Paper Type	Plain	
Sleep Time-out	10 min	
EWS Access path	http://xxx.xxx.xxx.xxx	
Network Information		
:	:	
:	:	

EWS Access path

http://xxx.xxx.xxx.xxx

Unit's IP address

Calling the Web interface

For the first time use, you will need to set the Password to get the entire features on the Web interface. After you have set the Password, you do not need to set the Password anymore.

- 1 Start an Internet browser on a PC, which is connected to the Network.

Note(s)

Suitable Internet browser

- We recommend the following Internet browser.
 - Windows®: Internet Explorer® (version 8.0 or above)
 - Mac: Safari (version 1.3 or above)

- 2 Enter the IP address of the unit into the address bar of the browser.



http://xxx.xxx.xxx.xxx Unit's IP address

- 3 The following screen will be displayed.

The screenshot shows the 'Kodak Verite' web interface. At the top, there's a 'Status Monitor: Ready' indicator and a language selection dropdown set to 'English'. A left sidebar contains menu items: Device Status, Device Configuration, Network, Manuals, Order Supplies, and Login Password. The main content area is divided into sections: Device Information (Serial Number, Software Version), Device Statistics Information (Printed Page: 1, Scanned Page: 6, Total Jam Count: 0), Supply Information (Black Cartridge: Installed, 97% ink level; Color Cartridge: Installed, 88% ink level). A red box highlights the 'Device Status' section, and a red arrow points from the text below to it.

Click on the item to check the information or change its settings.

The printer's status is displayed here.

[Ready / Busy / Status message]

More details on Status messages and how to correct problems can be found under “Status messages and LED behaviors”.

» Refer to “Status messages and LED behaviors” on page 59.

Changes the display language.

After selecting the language, click on **[Accept]**.

Input “admin” into the “Password” field, then click on **[Login]** then, create the Password as you like.

» Refer to “Login Password” on page 49.

Device Status

You can check the status of the unit, such as remaining ink level.

Device Configuration

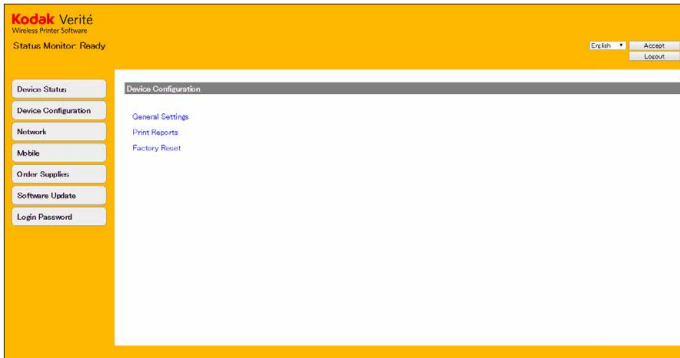

General Settings

You can change the following items.

- Default paper size/type
If you change this setting, the default paper size/type in Copy Menu setting are also changed.
- Sleep mode time
You can change the time required before unit enters Sleep mode from [1 min/10 min/20 min/30 min/40 min/50 min/60 min/70 min/80 min/90 min/100 min/110 min/120 min].

Print Reports

You can print out the configuration report.

Factory Reset

You can restore the default settings to the unit.

Note(s)

- The unit will automatically restart after reset to factory settings. (The Web Interface will be disconnected.)

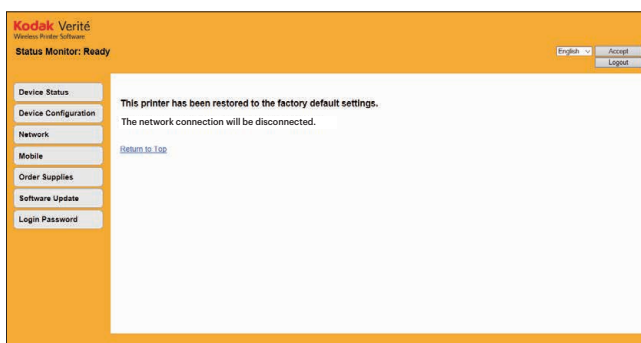

Network

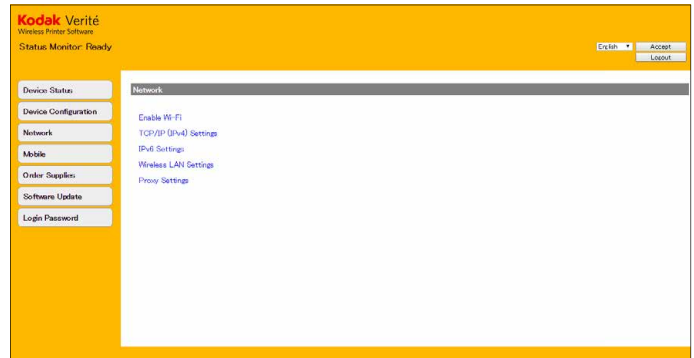

If necessary, you can confirm or set the state of the Network. If you are not familiar with Network management, use the default settings.

Note(s)

- Be careful if you want to assign the IP address manually. If the IP address you entered is not correct, you will not be able to connect to the unit. When you cannot connect to the unit after a configuration change, please reset the unit to the factory default.
 - » Refer to "Restore Factory Default" on page 45.
- When the connection of the unit is changed, the Web interface will be disconnected. If necessary, reconnect the Web interface.

Enable Wi-Fi

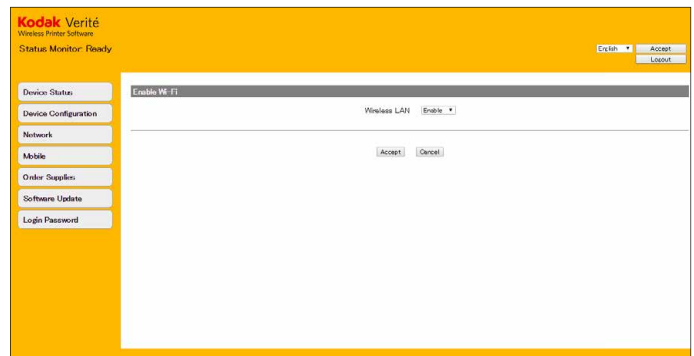

You can turn On / Off the Wireless function.

Note(s)

- Even if the Wireless function is set to Off, when you connect by Easy Simple Print, the Wireless function will be valid.
- When you have connected the unit to the access point/router, if you disable Wi-Fi, you will not be able to operate from the Web Interface. If you connect to Wi-Fi again, press



(Wireless).

TCP/IP (IPv4) Settings

You can change the IP source / IP address or the like.

Note(s)

- The initial value of the IP Source of Wireless is DHCP (Dynamic Host Configuration Protocol).

IPv6 Settings

This unit supports IPv6 in order to support AirPrint. You can check the information on IPv6.

Wireless LAN Settings

- You can change connection settings by setting the SSID / Security / Password for Wireless Connection.

Proxy Settings

- You can connect to Internet through a proxy server.

Mobile

AirPrint

You can AirPrint Settings.

- Refer to "AirPrint" on page 25 for more information.

Note(s)

- When you select **[Certificate Installation]** or **[Generate Certificate Request]**, you can set the encrypted communication.

AirPrint Configuration

You can turn On/Off the AirPrint function. If set to On, you can print using the AirPrint.

- The printer name (Friendly Name) and its information are displayed when you are using AirPrint.

Google Cloud Print™

You can set the Google Cloud Print™ settings.

- Registration and connection status of Google Cloud Print™ will be shown. More information can be found under "Google Cloud Print™".
 - Refer to "Google Cloud Print™" on page 42 for more information.
- The printer name and its information are displayed when you are using Google Cloud Print™.

Select Action

You can set the following for the Google Cloud Print™ setting. After you select the Action, click on **[Accept]**.

Select Action	Action
Register to Google Cloud Print	Register to Google Cloud Print™
Disable Cloud Print	Disable Google Cloud Print™
Suspend Cloud Print	Suspend Google Cloud Print™
Enable Cloud Print	Enable Google Cloud Print™
Resume Cloud Print	Resume Google Cloud Print™
Unregister from Google	Unregister from the Google Cloud Print™
Register Cancel	Cancel the Google Cloud Print™ registration
Set XMPP Ping Interval	Set the interval time to communicate with the Google Cloud Print™ service.

* Usually, set the XMPP Ping Interval to 5 minutes (default).

To change this setting, select **[Set XMPP Ping Interval]** in **[Select Action]** and choose the communication interval from 1 minute to 10 minutes.

Note(s)

- When you select **[Register to Google Cloud Print]**, then ensure plain Letter or A4-size paper is loaded.

Order Supplies

If you would like to purchase consumable material, visit the following website at www.kodakverite.com/support

Software Update

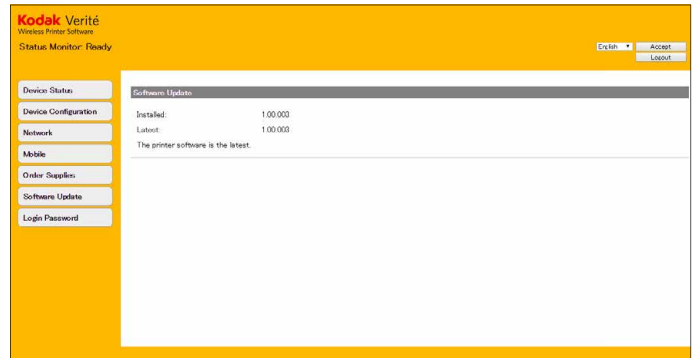

- If the Software Update for this unit is available, the Update button is displayed. Click it and start to update the Software.
- When the Software is the latest version, the Update button is not displayed.

Login Password

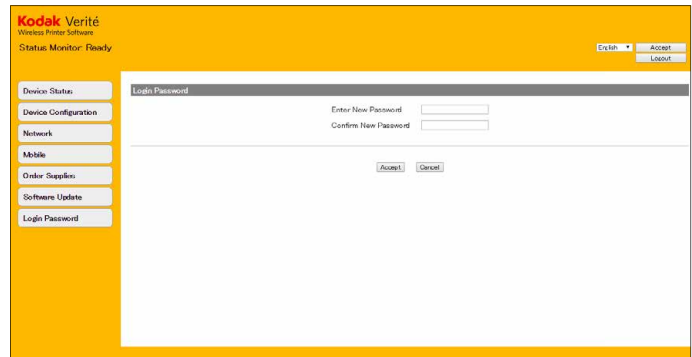

- Once you have logged in to the Web interface using "admin", it is recommended that you change the Password.

Note(s)

- Record the Password in case you forget it.
- If you have forgotten the Password, you can perform **[Restore Factory Default]** to reset all settings, including the Password, to their factory default. After resetting the unit, you can login with the default Password "admin".
- Passwords may only contain alphanumeric characters, and are from 1 to 32 characters in length.
- The default Password "admin" provides you with full access to all setup functions, but can allow access by an unauthorized third party. It is recommended that you change the Password.

Service

Note(s)

- If any problems occur, please see the notifications on the Status Messenger (Windows®).
- » Refer to "Status Messenger for Windows®" on page 26.

Checking ink levels

Using PC

- » Refer to "Status Messenger for Windows®" on page 26.

Changing the ink cartridge

CAUTION

Use Original Consumable Materials!

- Use only original consumable materials. These are available from a specialized retailer or through our order service. Other consumable materials can cause damage to the unit.

Observe Packaging Instructions

- Follow the instructions on the packaging of the consumable materials.

- 1 Open the unit by lifting the Ink door.

DO NOT Open During a Print Job!

- Never open the Ink door while printing.

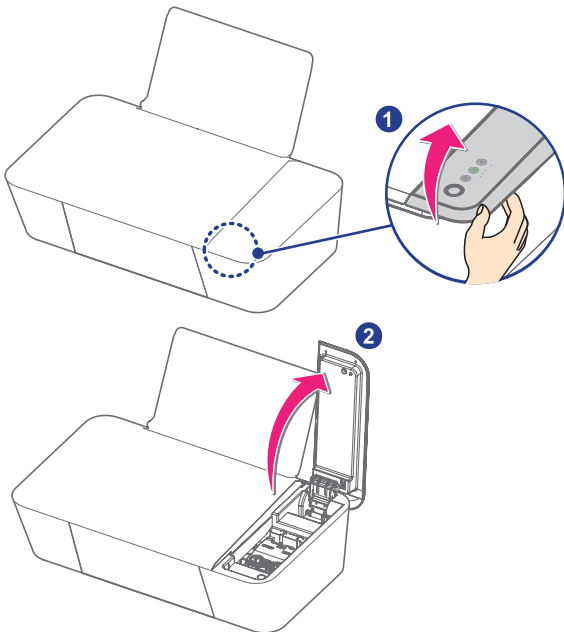

- 2 Press front side blue Cartridge tab with 2 fingers to open the Cartridge slot.

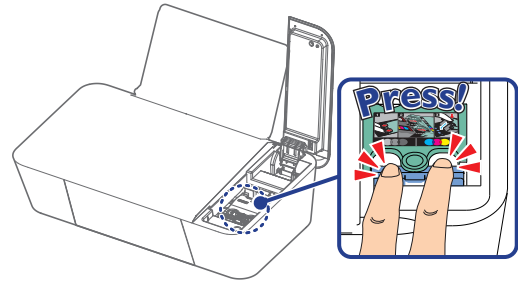

- 3 Remove the cartridges.

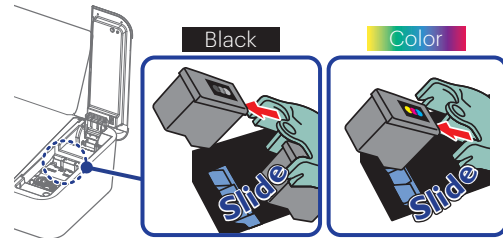

- 4 Remove the Black and Color Ink cartridges from the packaging.

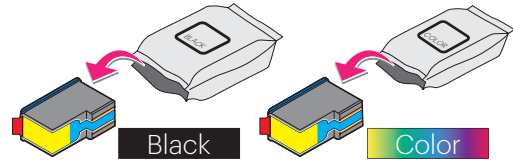

- 5 Remove the plastic tape on the Black and Color Ink cartridges using the red pull tab.

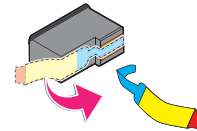

DO NOT TOUCH

- DO NOT TOUCH the gold contact area on the back or the metal nozzles on the bottom of the Cartridge.

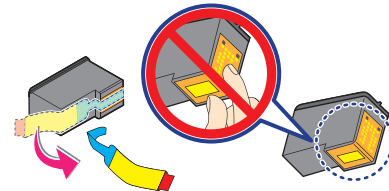

- 6 Slide the Color Ink cartridge all the way into the right slot using the green rail.

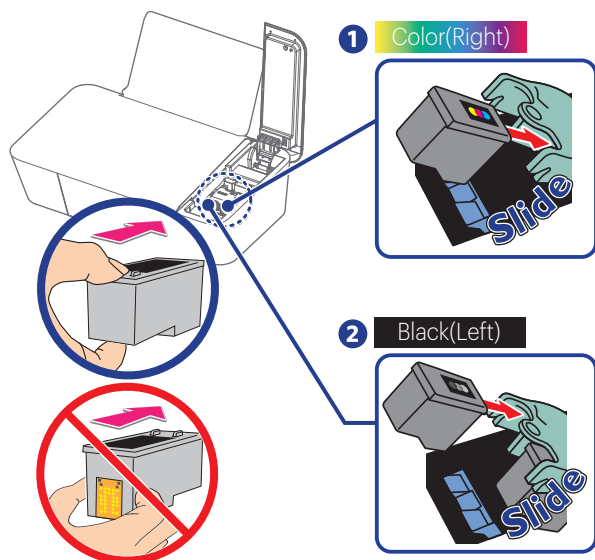

- 7 Slide the Black Ink cartridge all the way into the left slot using the green rail.

- 8 Push and click the center green Cartridge tab to close the slot until the cover snaps securely into position.

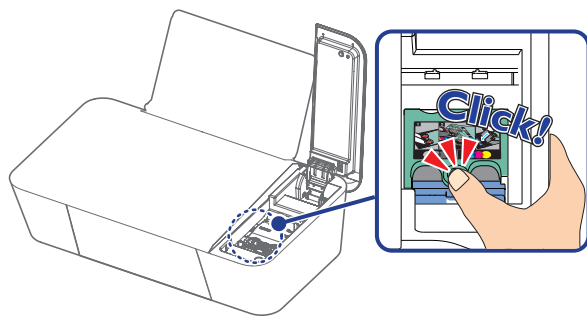

- 9 Close the Ink door.

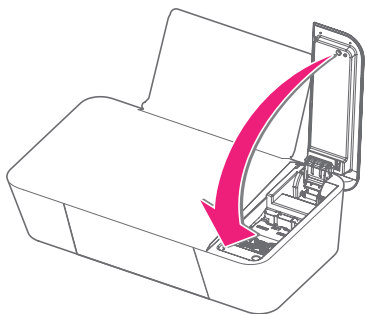

CAUTION

Ink Cartridge Not Inserted Correctly!

- If the Ink door does not close properly, the Ink cartridges are not inserted correctly. Remove the Ink cartridges and then correctly insert them again.



DO NOT PUSH the green/blue parts at the same time.

OPEN: use only BLUE part.

CLOSE: use only GREEN part.

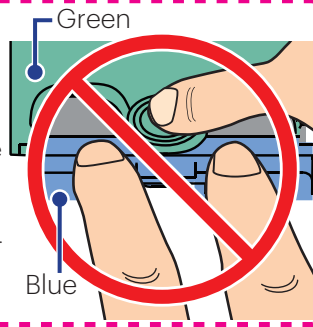

Ordering supplies

If you would like to purchase consumable material, visit the following website at www.kodakverite.com

Ordering ink cartridges

Product Name	Ink Page Yield
KODAK VERITÉ 5 Standard Black Ink Cartridge	~200 pages
KODAK VERITÉ 5 Standard Color Ink Cartridge	~180 pages
KODAK VERITÉ 5 XL Black Ink Cartridge	~400 pages
KODAK VERITÉ 5 XL Color Ink Cartridge	~360 pages
KODAK VERITÉ 5 XXL Black Ink Cartridge	~600 pages
KODAK VERITÉ 5 XXL Color Ink Cartridge	~500 pages
KODAK VERITÉ 5 3XL Black Ink Cartridge	~1200 pages
KODAK VERITÉ 5 3XL Color Ink Cartridge	~1080 pages
KODAK VERITÉ 5 XL Combo Ink Cartridge	Black: ~400 pages/ Color: ~360 pages
KODAK VERITÉ 5 3XL Combo Ink Cartridge	Black: ~1200 pages/ Color: ~1080 pages

Ink page yield values for color graphics and text document obtained by continuous printing in accordance with ISO/IEC 24711. Actual results may vary.

Note(s)

- For page yield information, visit www.kodakverite.com/support
- The cartridges used for printing documents can also be used for printing photos.
- For best results, use only genuine KODAK VERITÉ Ink Cartridges.

Using genuine KODAK VERITÉ Ink Cartridges

KODAK VERITÉ Ink Cartridges are designed to perform for superior print quality, and our inks are formulated to work with the unit and help extend the life of your product.

We recommend that you use only genuine KODAK VERITÉ Ink Cartridges sold by Funai Corporation, Inc.

Funai's warranty does not cover damage caused by non-KODAK VERITÉ Ink or Ink Cartridges.

Fixing a paper jam

Clearing paper jam in the unit

Note(s)

- The Parts inside the unit are Sensitive. Avoid unnecessarily touching Parts while Clearing Jams.

- 1 Check the paper support or the paper exit tray for jammed paper.
- 2 Firmly grasp both sides of the paper, then gently pull it out.

Note(s)

- Be careful not to tear the paper while removing it.

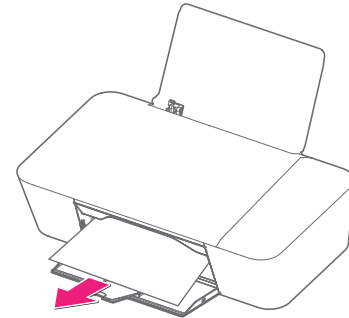

- 3 Press and hold **⏻** (Power/Standby) to cancel the rest of the print job.

Restoring the factory settings

You can restore the default settings on the unit using the web interface.

- » Refer to "Device Configuration" on page 47.
- » Refer to "Restore Factory Default" on page 45.

Hard Reset

- » Refer to "Troubleshooting" on page 55.

If a problem occurs that cannot be corrected with the instructions in "Troubleshooting", follow the Steps given here.

- 1 Press and hold **⏻** (Power/Standby) longer than 3 seconds to turn the unit Off (Standby).
- 2 Unplug the AC plug from the AC outlet.
- 3 Wait at least 30 seconds, then reconnect the AC plug back into the AC outlet.
- 4 Follow the instructions on the display and in the error report. If the problem repeats, visit the following website at www.kodakverite.com/support

Cleaning the ink cartridge nozzles and contacts

- 1 Remove the ink cartridge(s).
- 2 Dampen a clean, lint-free soft cloth with water and then place the cloth on a flat surface.
- 3 Gently hold the nozzles against the cloth for about 3 seconds and then wipe in the direction shown below.

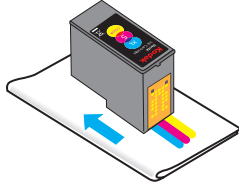

e.g.) KODAK VERITÉ 5 XL Color Ink Cartridge

- 4 Using another clean section of the cloth, gently hold the cloth against the contacts for about 3 seconds and then wipe in the direction shown below.



e.g.) KODAK VERITÉ 5 XL Color Ink Cartridge

- 5 With another clean section of the cloth, repeat Step 3 and Step 4, and then let the nozzles and contacts dry completely.
- 6 Reinsert the ink cartridge(s) and then print the document again.
- 7 If the print quality does not improve, clean the print nozzles and then try printing the document again.
- 8 Repeat Step 7 up to two more times.
- 9 If print quality is still not satisfactory then replace the ink cartridge(s).

Preserving the ink cartridges

- Keep new ink cartridges in their packaging until you are ready to install them.
- DO NOT remove an ink cartridge from the unit except to replace, clean or store it in an airtight container. The cartridges do not print correctly if left exposed for an extended period of time.

⚠ CAUTION

Refilling ink cartridges

- The warranty does not cover repair of failures or damage caused by a refilled ink cartridge.
- Kodak does not recommend use of a refilled ink cartridge.
- Refilling an ink cartridge can affect print quality and may cause damage to the unit.
- For the best results, use Kodak Supplies.

Warning - Drying out of the Printheads:

- DO NOT move the Ink Cartridge Holder by hand. If you move the Cartridge Holder to the left of the printhead Cover Caps will not protect the Printheads from Drying out.

Cleaning the scanner glass

- 1 Dampen a clean, lint-free soft cloth with water.
- 2 Gently wipe the scanner glass clean.
- 3 Use a dry lint-free soft cloth to wipe the moisture left over.

□ Note(s)

- Make sure all ink or corrective fluid on a document is dry before placing the document on the scanner glass.

Cleaning the exterior of the unit

- 1 Make sure that the unit is turned Off (Standby) and unplugged from the AC outlet.



SHOCK HAZARD

- To avoid the risk of electric shock, disconnect the AC Power cord from the AC outlet and disconnect all cables to the unit before proceeding.

- 2 Remove paper from the paper support and paper exit tray.
- 3 Dampen a clean, lint-free soft cloth with water.

CAUTION

Warning-Potential Damage:

- DO NOT use household cleaners or detergents, as they may damage the finish on the unit.

- 4 Wipe only the outside of the unit, making sure to remove any ink residue that has accumulated on the paper exit tray.

CAUTION

Warning-Potential Damage:

- Using a damp cloth to clean the interior may cause damage to your unit.

- 5 Make sure the paper support and paper exit tray are dry before beginning a new print job.

Periodic maintenance is required

The unit will automatically clean the nozzle itself regularly to keep an appropriate print quality. This maintenance begins automatically even when the unit is in Sleep mode.











Important Notice Regarding Printheads



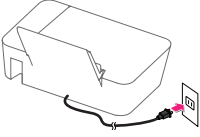

This unit automatically protects the printhead (caps) on each ink cartridge in order to prevent the printheads from drying. This function is only performed when pressing  (Power/Standby) button to select the Power-Off (Standby) mode. DO NOT Unplug the AC Power cord from the AC outlet to shut down the unit or move the ink cartridge access holder after the unit was shut down. Failure to do so may result in Clogging of the Printhead Nozzles.



Troubleshooting

You can correct most problems by yourself. If you need additional help, the Kodak Solutions Center offers the most up-to-date driver, manuals, the latest FAQs and troubleshooting tips. Visit our website at www.kodakverite.com/support

Setup troubleshooting

 (Power) LED is not lit	<ul style="list-style-type: none"> • Press  (Power/Standby) Make sure the unit is on by pressing  (Power/Standby). • Disconnect and reconnect the AC plug <ol style="list-style-type: none"> 1 Press and hold  (Power/Standby) longer than 3 seconds to turn the unit Off (Standby). 2 Disconnect the AC plug from the AC outlet for 30 sec. 3 Reconnect the AC plug to an AC outlet that other electrical devices have been using or check this outlet with another device. 4 If the  (Power) LED is not lit, press  (Power/Standby). 																																																					
Software did not install	<p>If you encountered problems while installing, or if the unit does not appear in the list in the printers folder or as the unit option when sending a print job, you can try uninstalling and reinstalling the Software.</p> <p>Make sure your operating system is supported The following operating systems are supported:</p> <table border="1" data-bbox="568 772 1453 982"> <thead> <tr> <th colspan="5">Microsoft® Windows®</th> </tr> <tr> <th colspan="2">OS Version</th> <th>Processor</th> <th>Browser</th> <th>USB port</th> </tr> </thead> <tbody> <tr> <td>Windows® 10</td> <td>Windows® Server 2012</td> <td rowspan="4">32-bit (x86) or 64-bit (x64)</td> <td rowspan="4">Microsoft Edge (Only Windows® 10), Internet Explorer®</td> <td rowspan="4">USB 2.0 High Speed or Full Speed</td> </tr> <tr> <td>Windows® 8.1</td> <td>Windows® Server 2008</td> </tr> <tr> <td>Windows® 8</td> <td>Windows® Vista</td> </tr> <tr> <td>Windows® 7</td> <td>Windows® Server 2016</td> </tr> </tbody> </table> <table border="1" data-bbox="568 997 1453 1180"> <thead> <tr> <th colspan="5">Apple Mac OS</th> </tr> <tr> <th colspan="2">OS Version</th> <th>Processor</th> <th>Browser</th> <th>USB port</th> </tr> </thead> <tbody> <tr> <td>macOS v10.12 (Sierra)</td> <td>OS X v10.10 (Yosemite)</td> <td rowspan="2">Intel® Core™ Processor</td> <td rowspan="2">Safari</td> <td rowspan="2">USB 2.0 High Speed or Full Speed</td> </tr> <tr> <td>OS X v10.11 (El Capitan)</td> <td>OS X v10.9 (Mavericks)</td> </tr> </tbody> </table> <table border="1" data-bbox="568 1192 1453 1339"> <thead> <tr> <th colspan="5">Linux</th> </tr> <tr> <th colspan="2">OS Version</th> <th>Processor</th> <th>Browser</th> <th>USB port</th> </tr> </thead> <tbody> <tr> <td>Debian 8.0</td> <td>Ubuntu 14.04 LTS</td> <td>700MHz (about Intel® Celeron™ or better)</td> <td>Firefox</td> <td>USB 2.0 High Speed or Full Speed</td> </tr> </tbody> </table> <p>Check that your computer meets the minimum system requirements listed on the printer box.</p> <ul style="list-style-type: none"> • Check the USB connection <ol style="list-style-type: none"> 1 Check the USB cable for any obvious damage. If the cable is damaged, use a new one. 2 Firmly plug the square end of the USB cable into the back of the unit. 3 Firmly plug the rectangular end of the USB cable into the USB port of your PC. The USB port is marked with the USB symbol. • Disconnect and Reconnect the Power Supply <ol style="list-style-type: none"> 1 Press and hold  (Power/Standby) to turn the unit Off (Standby). 2 Disconnect the AC plug from the AC outlet for 30sec. 3 Reconnect the AC plug to the AC outlet. 4 If the  (Power) LED is not lit, press  (Power/Standby) to turn the unit On. • Temporarily disable security programs in Windows® <ol style="list-style-type: none"> 1 Close all open programs. 2 Disable any security programs. 3 Double-click the downloaded installer file to extract it. 4 Follow the instructions on the computer screen to install the Software. 5 When the installation is completed, enable the security Software again. 	Microsoft® Windows®					OS Version		Processor	Browser	USB port	Windows® 10	Windows® Server 2012	32-bit (x86) or 64-bit (x64)	Microsoft Edge (Only Windows® 10), Internet Explorer®	USB 2.0 High Speed or Full Speed	Windows® 8.1	Windows® Server 2008	Windows® 8	Windows® Vista	Windows® 7	Windows® Server 2016	Apple Mac OS					OS Version		Processor	Browser	USB port	macOS v10.12 (Sierra)	OS X v10.10 (Yosemite)	Intel® Core™ Processor	Safari	USB 2.0 High Speed or Full Speed	OS X v10.11 (El Capitan)	OS X v10.9 (Mavericks)	Linux					OS Version		Processor	Browser	USB port	Debian 8.0	Ubuntu 14.04 LTS	700MHz (about Intel® Celeron™ or better)	Firefox	USB 2.0 High Speed or Full Speed
Microsoft® Windows®																																																						
OS Version		Processor	Browser	USB port																																																		
Windows® 10	Windows® Server 2012	32-bit (x86) or 64-bit (x64)	Microsoft Edge (Only Windows® 10), Internet Explorer®	USB 2.0 High Speed or Full Speed																																																		
Windows® 8.1	Windows® Server 2008																																																					
Windows® 8	Windows® Vista																																																					
Windows® 7	Windows® Server 2016																																																					
Apple Mac OS																																																						
OS Version		Processor	Browser	USB port																																																		
macOS v10.12 (Sierra)	OS X v10.10 (Yosemite)	Intel® Core™ Processor	Safari	USB 2.0 High Speed or Full Speed																																																		
OS X v10.11 (El Capitan)	OS X v10.9 (Mavericks)																																																					
Linux																																																						
OS Version		Processor	Browser	USB port																																																		
Debian 8.0	Ubuntu 14.04 LTS	700MHz (about Intel® Celeron™ or better)	Firefox	USB 2.0 High Speed or Full Speed																																																		

<p>Page does not print</p>	<ul style="list-style-type: none"> • Check messages If an error message appears, then resolve the error before trying to print again. • Check power If the  (Power/Standby) LED is not lit, then make sure that the AC Power cord is properly connected to the unit and the AC plug is connected to a known working AC outlet that other electrical devices have been using or check this outlet with another device. • Remove and then reload paper • Check ink Check the ink levels and then install new ink cartridges if necessary. • Check cartridges <ol style="list-style-type: none"> 1 Remove the ink cartridges. 2 Make sure the sticker and tape have been removed. 3 Reinsert the cartridges. • Check printer default and pause settings <p>Using Windows® 10 / 8.1 / 8 / 7 / Vista</p> <ol style="list-style-type: none"> 1 Proceed to Default print setting screen. <ol style="list-style-type: none"> a. Right-click the Windows® start menu, click [Control Panel], [Hardware and Sound] and [Devices and printers] (Windows® 10 / 8.1). b. Right-click at the bottom left corner on your desktop, click [Control Panel], [Hardware and Sound] and [Devices and printers] (Windows® 8). c. From the Windows® start menu, click [Devices and printers] (Windows® 7). d. From the Windows® start menu, click [Control Panel], [Hardware and Sound] and [Printers] (Windows® Vista). 2 Either double-click the Icon for your unit or right-click the Icon for your unit and select, see what's printing to open the print queue. 3 On the menu, make sure there are no check marks next to Pause Printing or Use Printer Offline. 4 If you made any changes, try to print again. If a check mark does not appear next to Set As Default Printer, then you must select the unit for each file that you want to print. <ul style="list-style-type: none"> • Disconnect and Reconnect Power Supply <ol style="list-style-type: none"> 1 Press and hold  (Power/Standby) to turn the unit Off (Standby). 2 Disconnect the AC plug from the AC outlet for 30 sec. 3 Reconnect the AC plug to the AC outlet. 4 If the  (Power) LED is not lit, press  (Power/Standby) to turn the unit On. • Remove and reinstall the Software If you encountered problems while installing, or if the unit does not appear in the printers folder or as a printer option when sending a print job, then try uninstalling and reinstalling the Software.
<p>Print unexpectedly or it prints garbage data.</p>	<ul style="list-style-type: none"> • Make sure that the USB cable is not too long. • Make sure that the USB cable is not damaged or broken. • If you are using a USB interface-switching device, remove it. Connect your computer directly to your unit and then try again. • Make sure that you have chosen the correct printer driver to [Set as Default Printer]. • Make sure that this unit is not connected to the same port that is also connected to a storage device or scanner device. Remove all other devices and connect only this unit (printer) to this port.

Solving the power problems	<ul style="list-style-type: none"> • The unit and the PC do not communicate. • Make sure the power supply is attached correctly to the unit <ol style="list-style-type: none"> 1 Press and hold  (Power/Standby) longer than 3 seconds to turn the unit Off (Standby). 2 Disconnect the AC plug from the AC outlet. 3 Wait 30 seconds and then reconnect the AC plug to the AC outlet. 4 If the  (Power) LED is not lit, press  (Power/Standby) to turn the unit On.
Removing and Reinstalling the Printer Software	<p>If the unit is not working properly, or if a communication error message appears when you try to use the unit, then you may need to remove and reinstall the Software.</p> <p>Using Windows® 10 / 8.1 / 8 / 7 / Vista</p> <ol style="list-style-type: none"> 1 Open All Programs or All apps. <ol style="list-style-type: none"> a. Click [Start] button, Click [All apps], and then select the printer Software folder “KODAK VERITE 50” from the list (Windows® 10 / 8.1). b. Display [Start] screen, right-click for [All apps] Icon to fade into the bottom right, click [All apps], select the printer Software folder “KODAK VERITE 50” from the list (Windows® 8). c. Click [Start] button, Click [All Programs], and then select the printer Software folder “KODAK VERITE 50” from the list (Windows® 7 / Vista). 2 Select Uninstall. 3 Follow the instructions on your PC screen to remove the printer Software. 4 Restart the PC before Reinstalling the printer Software. 5 Click Cancel on all New Hardware Found screens. 6 From your computer go to www.kodakverite.com/support and confirm that the “DOWNLOADS” is selected. 7 Select the model number of your unit from [SELECT PRINTER]. 8 Click “PC drivers and software”. 9 Click OS you use. 10 Click [download] from [LAST]. <p>» Refer to “Before you download the printer driver to your PC” on page 14.</p>
Enabling the USB port in Windows®	<ul style="list-style-type: none"> • To confirm that the USB port is enabled on your PC: <p>Using Windows® 10 / 8.1 / 8 / 7 / Vista</p> <ol style="list-style-type: none"> 1 Proceed to Control panel. <ol style="list-style-type: none"> a. Right-click [Start] (Windows® 10 / 8.1). b. Right-click at the bottom left corner on your desktop (Windows® 8). c. Click [Start] button (Windows® 7 / Vista). 2 Click [Control Panel] > [Hardware and Sound]. 3 Under [Devices and printers], click [Device Manager]. 4 Double-click [Universal Serial Bus Controller]. <p>If USB Host Controller and USB Root Hub are listed, then the USB port is enabled. For more information, see your PC documentation.</p>

■ **Status Messenger Error Message appears**

- » Refer to “Check print status from your PC” on page 26.
- » Refer to “Status messages and LED behaviors” on page 59.

■ **Paper handling**

- » Refer to “Print media” on page 27.
- » Refer to “Status messages and LED behaviors” on page 62 (status message: Paper Jam).

■ **Pages are printed, but there are problems with:**

- Print quality
 - » Refer to “Improving the print quality” on page 64.

■ **Network problems**

If you need additional help, the Funai Solutions Center offers the most-up-to-date driver, manuals, the latest FAQs and troubleshooting tips.

Visit our website at www.kodakverite.com/support

■ **Alignment problems**

A failure notification will only be displayed on the App being used to print. Status Messenger will not notify if an alignment failure occurs.

Status messages and LED behaviors

The Status information will report problems with the unit. Take the proper action by referring to the following table.

» Refer to “Check print status from your PC” on page 26.

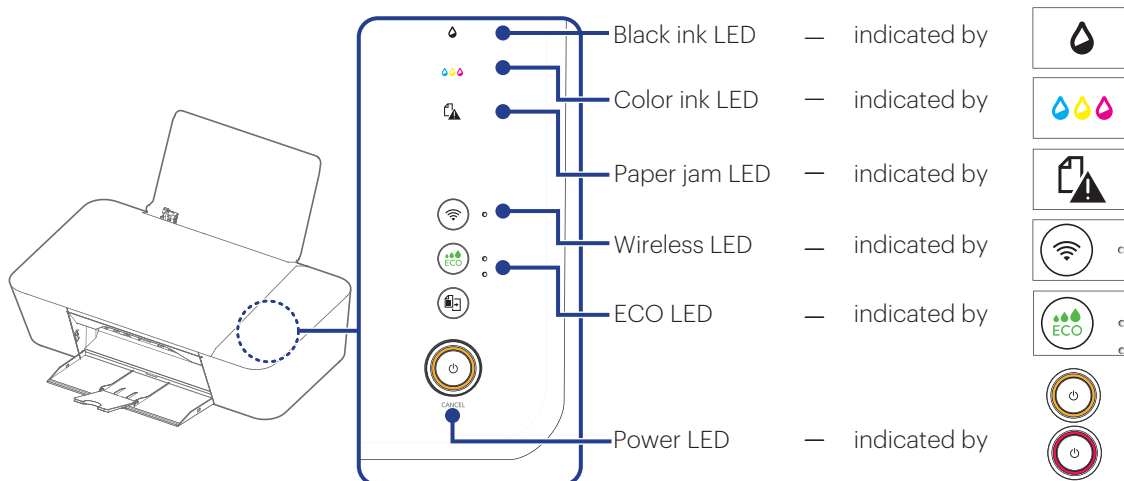

























LED lighting patterns

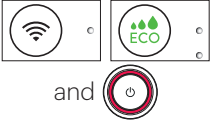























Blinking 1	Lights up for 1 sec. No light for 1 sec.
Blinking 2	Lights up very rapidly No light for more than 1 sec.
Blinking 3	Blinking very rapidly 2 times No light for 1 sec.
Blinking 4	Blinking very slowly









Blinking 5	Blinking slowly
Blinking 6	Blinking rapidly
Blinking 7	Blinking very rapidly
Blinking 8	Blinking very rapidly 4 times No light for 2 sec.
Blinking 9	Blinking slowly (in Power-On mode)

LED behaviors	Status messages	Unit status or possible causes	Refer to
<p>and blink as pattern 1</p>	Scanner Error: Unplug and replug the power cable.	Unplug the AC plug. - <i>Wait at least 30 seconds, then reconnect the AC plug back into the AC socket.</i> • If this error occurs occasionally, visit our website at www.kodakverite.com/support for the latest troubleshooting. • If you cannot solve the problem, disconnect the AC plug and contact an Authorized Service Center.	“Hard Reset” on page 52.
<p>and blink as pattern 1</p>	Memory Error: Unplug and replug the power cable.	Unplug the AC plug. - <i>Wait at least 30 seconds, then reconnect the AC plug back into the AC socket.</i> • If this error occurs occasionally, visit our website at www.kodakverite.com/support for the latest troubleshooting. • If you cannot solve the problem, disconnect the AC plug and contact an Authorized Service Center.	“Hard Reset” on page 52.
<p>and blink as pattern 1</p>	Wi-Fi Module Error: Unplug and replug the power cable.	Unplug the AC plug. - <i>Wait at least 30 seconds, then reconnect the AC plug back into the AC socket.</i> • If this error occurs occasionally, visit our website at www.kodakverite.com/support for the latest troubleshooting. • If you cannot solve the problem, disconnect the AC plug and contact an Authorized Service Center.	“Hard Reset” on page 52.

LED behaviors	Status messages	Unit status or possible causes	Refer to
 <p>and </p> <p>blinks as pattern 1</p>	<p>Paper Jam: Unplug and replug the power cable.</p>	<p>A paper jam has occurred inside of the unit.</p> <ul style="list-style-type: none"> - <i>Firmly grasp both sides of the paper, then gently pull it out. Press and hold  (Power/Standby) longer than 3 seconds to turn the unit Off (Standby). Unplug the AC plug. Wait at least 30 seconds, then reconnect the AC plug back into the AC socket.</i> • If this error occurs occasionally, visit our website at www.kodakverite.com/support for the latest troubleshooting. • If you cannot solve the problem, disconnect the AC plug and contact an Authorized Service Center. 	<p>“Clearing paper jam in the unit” on page 52. “Hard Reset” on page 52.</p>
 <p>blink as pattern 6</p> <p> blinks as pattern 1</p>	<p>Check cartridge lock</p>	<p>An ink cartridge is not installed correctly.</p> <ul style="list-style-type: none"> - <i>If the packaging paper is stuck in the Ink door, remove it.</i> - <i>Reinstall the cartridge, then close the lid completely.</i> • Confirm the ink cartridge is correctly installed, then press  (Power/Standby). 	<p>“Unpack” on page 11. “Install ink cartridges” on page 12. “Changing the ink cartridge” on page 50.</p>
 <p>blink as pattern 6</p> <p> blinks as pattern 1</p>	<p>Remove and Reinsert both black and color ink cartridges.</p>	<p>Soiled or unsupported ink cartridge(s) has been inserted.</p> <ul style="list-style-type: none"> - <i>Clean the surface of the nozzles and contacts on the Ink cartridge(s) with a dampened soft cloth then let them dry before reinserting cartridge(s).</i> - <i>Replace the current Ink cartridge(s) with an authorized Ink cartridge(s).</i> 	<p>“Cleaning the ink cartridge nozzles and contacts” on page 53. “Changing the ink cartridge” on page 50.</p>
 <p>blink as pattern 6</p> <p> blinks as pattern 1</p>	<p>Both inks are empty.</p>	<p>The ink is empty in the ink cartridge(s).</p> <ul style="list-style-type: none"> - <i>Replace with a new Ink cartridge(s).</i> • Order new Ink cartridge(s) from our website at www.kodakverite.com 	<p>“Changing the ink cartridge” on page 50.</p>
 <p>blink as pattern 6</p> <p> blinks as pattern 1</p>	<p>No Ink detected</p>	<p>No ink detected.</p> <ul style="list-style-type: none"> - <i>Remove and reinstall the Ink cartridges.</i> - <i>Make sure the Ink cartridges are inserted correctly.</i> - <i>Clean the surface of the nozzles and contacts on the Ink cartridges with a dampened soft cloth then let them dry before reinserting cartridges.</i> 	<p>“Changing the ink cartridge” on page 50. “Cleaning the ink cartridge nozzles and contacts” on page 53.</p>
 <p>blink as pattern 6</p> <p> blinks as pattern 1</p>	<p>Both Inks Error</p>	<p>Ink cartridges error.</p> <ul style="list-style-type: none"> - <i>Clean the surface of the nozzles and contacts on the Ink cartridges with a dampened soft cloth then let them dry before reinserting cartridges.</i> - <i>Replace the current Ink cartridges with authorized Ink cartridges.</i> • If this error occurs occasionally, try to replace the current Ink cartridges with new Ink cartridges. 	<p>“Cleaning the ink cartridge nozzles and contacts” on page 53. “Changing the ink cartridge” on page 50.</p>
 <p>blink as pattern 4 and</p> <p> blink as pattern 4</p>	<p>Both ink levels are low.</p>	<p>Both inks are low in the ink cartridges.</p> <ul style="list-style-type: none"> - <i>You should purchase a new Ink cartridges.</i> • Order new Ink cartridges from our website at www.kodakverite.com 	<p>—</p>

LED behaviors	Status messages	Unit status or possible causes	Refer to
 <p>and blink as pattern 1</p>	<p>Cartridge/Paper Jam: Unplug and replug the power cable.</p>	<p>An ink cartridge is not installed correctly.</p> <ul style="list-style-type: none"> - Press and hold  (Power/Standby) longer than 3 seconds to turn the unit Off (Standby). Unplug the AC Plug. Check that the Ink Cartridges have no obstacles and clear pathways. Connect the AC plug to the AC outlet. <p>A paper jam has occurred inside of the unit.</p> <ul style="list-style-type: none"> - Firmly grasp both sides of the paper, then gently pull it out. Press and hold  (Power/Standby) longer than 3 seconds to turn the unit Off (Standby). Unplug the AC Plug. Wait at least 30 seconds, then connect the AC plug back into the AC socket. <ul style="list-style-type: none"> • If this error occurs occasionally, visit our website at www.kodakverite.com/support for the latest troubleshooting. • If you cannot solve the problem, disconnect the AC plug and contact an Authorized Service Center. 	<p>“Clearing paper jam in the unit” on page 52. “Fixing a paper jam” on page 52. “Hard Reset” on page 52.</p>
 <p>blink as pattern 6 blinks as pattern 1</p>	<p>Remove and Re-insert black ink cartridge.</p>	<p>Soiled or unsupported ink cartridge has been inserted.</p> <ul style="list-style-type: none"> - Clean the surface of the nozzles and contacts on the Ink cartridge with a dampened soft cloth then let them dry before reinserting cartridge. - Replace the current Ink cartridge with an authorized Ink cartridge. <ul style="list-style-type: none"> • If this error occurs occasionally, try to replace the current Ink cartridge with a new Ink cartridge. 	<p>“Cleaning the ink cartridge nozzles and contacts” on page 53. “Changing the ink cartridge” on page 50.</p>
 <p>blink as pattern 6 blinks as pattern 1</p>	<p>Black ink is empty.</p>	<p>Black ink is empty in the ink cartridge.</p> <ul style="list-style-type: none"> - Replace with a new Ink cartridge. <ul style="list-style-type: none"> • Order a new Ink cartridge from our website at www.kodakverite.com 	<p>“Changing the ink cartridge” on page 50.</p>
 <p>blink as pattern 6 blinks as pattern 1</p>	<p>Black Ink Error</p>	<p>Black ink cartridge error.</p> <ul style="list-style-type: none"> - Clean the surface of the nozzles and contacts on the Ink cartridge with a dampened soft cloth then let them dry before reinserting cartridge. - Replace the current Ink cartridge with an authorized Ink cartridge. <ul style="list-style-type: none"> • If this error occurs occasionally, try to replace the current Ink cartridge with a new Ink cartridge. 	<p>“Cleaning the ink cartridge nozzles and contacts” on page 53. “Changing the ink cartridge” on page 50.</p>
 <p>blink as pattern 6 blinks as pattern 1</p>	<p>Remove and Re-insert color ink cartridge.</p>	<p>Soiled or unsupported ink cartridge has been inserted.</p> <ul style="list-style-type: none"> - Clean the surface of the nozzles and contacts on the Ink cartridge with a dampened soft cloth then let them dry before reinserting cartridge. - Replace the current Ink cartridge with an authorized Ink cartridge. 	<p>“Cleaning the ink cartridge nozzles and contacts” on page 53. “Changing the ink cartridge” on page 50.</p>
 <p>blink as pattern 6 blinks as pattern 1</p>	<p>Color ink is empty.</p>	<p>Color ink is empty in the ink cartridge.</p> <ul style="list-style-type: none"> - Replace with a new Ink cartridge. <ul style="list-style-type: none"> • Order a new Ink cartridge from our website at www.kodakverite.com 	<p>“Changing the ink cartridge” on page 50.</p>
 <p>blink as pattern 6 blinks as pattern 1</p>	<p>Color Ink Error</p>	<p>Color ink cartridge error.</p> <ul style="list-style-type: none"> - Clean the surface of the nozzles and contacts on the Ink cartridge with a dampened soft cloth then let them dry before reinserting cartridge. - Replace the current Ink cartridge with an authorized Ink cartridge. <ul style="list-style-type: none"> • If this error occurs occasionally, try to replace the current Ink cartridge with a new Ink cartridge. 	<p>“Cleaning the ink cartridge nozzles and contacts” on page 53. “Changing the ink cartridge” on page 50.</p>

LED behaviors	Status messages	Unit status or possible causes	Refer to
 blink as pattern 4 and  lighting	Black ink is empty.	Black ink is empty in the ink cartridge. - <i>You get good printed results with Color mode in this condition.</i> • If you want to use both Ink cartridges, please cancel the print job then press and hold  (Power/Standby) and replace with a new Black Ink cartridge.	"Changing the ink cartridge" on page 50.
 blink as pattern 4 and  lighting	Black ink cartridge is not detected.	Black ink is not inserted. - <i>You get good printed results with Color mode in this condition.</i> • If you want to use both Ink cartridges, please cancel the print job then press and hold  (Power/Standby) and replace with a new Black Ink cartridge.	—
 blink as pattern 4 and  blink as pattern 4	Black ink level is Low.	Black ink level is low. - <i>You should purchase a new Ink cartridge.</i> • Order a new Ink cartridge from our website at www.kodakverite.com	—
 blink as pattern 4 and  lighting	Color ink is empty.	Color ink is empty in the ink cartridge. - <i>You get good printed results with Mono mode in this condition.</i> • If you want to use both Ink cartridges, please cancel the print job then press and hold  (Power/Standby) and replace with a new Color Ink cartridge.	"Changing the ink cartridge" on page 50.
 blink as pattern 4 and  lighting	Color ink cartridge is not detected.	Color ink is not inserted. - <i>You get good printed results with Mono mode in this condition.</i> • If you want to use both Ink cartridges, please cancel the print job then press and hold  (Power/Standby) and replace with a new Color Ink cartridge.	—
 blink as pattern 4 and  blink as pattern 4	Color Ink level is Low.	Color ink level is low. - <i>You should purchase a new Ink cartridge.</i> • Order a new Ink cartridge from our website at www.kodakverite.com	—
 and  blinks as pattern 1	Insert Paper	Insert Paper. - <i>Check the paper support.</i>	"Insert paper into the paper support" on page 27.
 and  blinks as pattern 1	Paper Jam	A paper jam has occurred inside of the unit. - <i>Firmly grasp both sides of the paper, then gently pull it out.</i>	"Clearing paper jam in the unit" on page 52.
 lighting	Black ink is empty.	Black ink is empty in the ink cartridge. - <i>You get good printed results with Color mode in this condition.</i> • If you want to use both Ink cartridges, please cancel the print job then press and hold  (Power/Standby) and replace with a new Black Ink cartridge.	—
 lighting	Black ink cartridge is not detected.	Black ink is not inserted. - <i>You get good printed results with Color mode in this condition.</i> • If you want to use both Ink cartridges, please cancel the print job then press and hold  (Power/Standby) and replace with a new Black Ink cartridge.	—

LED behaviors	Status messages	Unit status or possible causes	Refer to
 lighting	Color ink is empty.	Color ink is empty in the ink cartridge. - <i>You get good printed results with Mono mode in this condition.</i> • If you want to use both Ink cartridges, please cancel the print job then press and hold  (Power/Standby) and replace with a new Color Ink cartridge.	—
 lighting	Color ink cartridge is not detected.	Color ink is not inserted. - <i>You get good printed results with Mono mode in this condition.</i> • If you want to use both Ink cartridges, please cancel the print job then press and hold  (Power/Standby) and replace with a new Color Ink cartridge.	—
 blinks as pattern 1	Defective Cartridge	Ink cartridge(s) error. - <i>Clean the surface of the nozzles and contacts on the Ink cartridges with a dampened soft cloth then let them dry before reinserting cartridge(s).</i> - <i>Replace the current Ink cartridges with authorized Ink cartridge(s).</i> • If this error occurs occasionally, try to replace the current Ink cartridges with new Ink cartridges.	“Cleaning the ink cartridge nozzles and contacts” on page 53. “Changing the ink cartridge” on page 50.
 blinks as pattern 5	Alignment in progress	Alignment in progress. - <i>Print jobs cannot start while running alignment.</i> <i>Run the alignment or run cancel operation on the device.</i>	—
 blinks as pattern 1	Printer's ink door is open.	Ink Door Open. - <i>Close Ink Door.</i>	—
 blinks as pattern 1	Printer Memory Full	Memory of the unit is full. - <i>You cannot print with this print setting.</i> - <i>Please change the print setting and try again.(Resolution, size or number of copies)</i>	“Confirming Printing Preferences for Windows® -Page Layouts” on page 30 or “Confirming Print Settings for Mac - Layout” on page 32.
 blinks as pattern 1	Printer Memory Full (Recoverable)	Memory of the unit is full. - <i>You cannot print the multiple copies with this print setting.</i> - <i>Please change the print setting and try again.(Resolution, Size or Number of copies)</i>	“Confirming Printing Preferences for Windows® -Print Quality” on page 30 or “Confirming Print Settings for Mac - Quality & Media” on page 33.
—	Please proceed with cartridge setup.	• Cartridge setup is not done yet. You need to set up for ink cartridges before use.	“Cartridge Setup” on page 44.
—	Communication failure	Communication failed on the unit. - <i>Check the AC plug is connected to the AC outlet properly, the unit is turned On, or the connection environment (USB, Wireless) to the unit.</i> <i>Then follow the procedures by showing the help text on your connected unit.</i> • If this error occurs occasionally, visit our website at www.kodakverite.com/support for the latest troubleshooting. • If you cannot solve the problem, disconnect the AC plug and contact an Authorized Service Center.	—

Improving the print quality

If printout is like below, please try the suggestions in order.

Examples of poor image quality	Suggestions
 <p>Faint</p>	<ol style="list-style-type: none"> 1 Using genuine ink cartridges » Refer to "Ordering ink cartridges" on page 52. 2 Checking ink levels » Refer to "Checking ink levels" on page 50. 3 Cleaning the ink cartridge nozzles » Refer to "Clean Printhead" on page 43. 4 Aligning ink cartridges » Refer to "Cartridge Setup" on page 44. 5 Cleaning the ink cartridge nozzles and contacts » Refer to "Cleaning the ink cartridge nozzles and contacts" on page 53. 6 Cleaning the scanner glass (Copy function) » Refer to "Cleaning the scanner glass" on page 53. 7 Cleaning the exterior of the unit » Refer to "Cleaning the exterior of the unit" on page 54. 8 Please change to the higher quality mode. (Faint or White lines) » Refer to "Confirming Printing Preferences for Windows® -Print Quality" on page 30. » Refer to "Confirming Print Settings for Mac -Quality & Media" on page 33.
 <p>Faded colors / Incorrect color</p>	
 <p>White lines across on the page</p>	
<p>No printing results on the page</p>	

Appendix

Specifications

For more product specifications, see the Product Data Sheet at www.kodakverite.com/support

Technical Data

Dimensions (width x depth x height)	17.7 x 10.7 x 6.0 inches (450.4 x 272.5 x 153 mm)
Maximum dimensions (width x depth x height)	17.7 x 18.5 x 10.3 inches (450.4 x 470.6 x 262 mm)
Weight	8.0 lb. (3.65 kg)
Power requirements	100 - 127 VAC (-10%/+5%), 50/60 Hz (+/- 3 Hz)
Operating temperature	41 °F (5 °C) to 95 °F (35 °C)
Operating humidity	10 – 60 % (no condensation)

Printer

Print technology	Thermal inkjet
Standard printer language(s)	GDI
Print resolution (best)	Up to 4800 x 1200(black) Up to 4800 x 1200(color)

Copier

Copy resolution (Black & Color/Text and Photo)	Scan up to 600 x 600 dpi Print up to 4800 x 1200 dpi(black) Print up to 4800 x 1200 dpi(color)
---	--

Scanner

Scanner type	Flatbed scanner
Scan resolution (optical) (Software enhanced)	Up to 1200 x 1200 dpi Up to 19,200 x 19,200 dpi
Maximum scan area	8.5 x 11.7 inches (216 x 297 mm)
Supported file types	JPEG, PDF

Paper

Input capacity	Plain paper (20 lb. or 75 g/m2): Up to 60
Output capacity	Plain paper (20 lb. or 75 g/m2): Up to 25
Size	Letter, Legal, JIS B5, A4, Executive, A5, Statement, A6, 3x5 in., 4x6 in., 5x7 in., Hagaki, 3.5x5 in.(L), 10 Envelope, DL Envelope, C5 Envelope
Weight	Plain paper: 17 -24 lb. (64 - 90 g/m2)

PC-Network Connection

Connection type	USB 2.0 (High Speed) Wi-Fi IEEE 802.11 b/g/n
Supported operating systems	Visit our website at www.kodakverite.com/support
Direct print support capability	Wireless Direct Printing

- Technical specifications subject to change without notice.

Note(s)

- **A4, A5, A6, DL Envelope and C5 Envelope are International Paper Sizes.**

Note about recycling

- This unit's packaging materials are recyclable and can be reused. Please dispose of any materials in accordance with your local recycling regulations.



Safety Data Sheet (SDS)

To obtain Safety Data Sheets (SDS) for supplies containing chemical substances (e.g. ink), visit our website at www.kodakverite.com/support

■ Notes on statutory limitations, data protection and legal validity

The reproduction of certain documents (e.g. by scanning, printing, copying) is prohibited in many countries. The list of such documents below is not intended to be complete, it only offers a general overview. In case of doubt, consult your legal adviser.

- Passports (personal identification)
- Entrance and exit visa papers (immigration papers)
- Military service documents
- Paper Currency, Bank notes, travel checks, payment orders
- Postage stamps, tax stamps (stamped or unstamped)
- Loan papers, certificates of deposit, bonds
- Documents protected by copyright

Neither Funai nor its affiliates shall be liable to the purchaser of this product or third parties for damages, losses, costs, or expenses incurred by the purchaser or third parties as a result of accident, misuse, or abuse of this product or unauthorized modifications, repairs, or alterations to this product, or failure to strictly comply with Funai operating and maintenance instructions. Funai shall not be liable for any damages or problems arising from the use of any options or any consumable materials other than those designated as original products or approved products. Funai shall not be held liable for any damage resulting from electromagnetic interference that occurs from the use of any interface cables other than those designated as products.

Limited Warranty

Wireless All-In-One Inkjet Printer

FUNAI warrants this Product to be free from malfunctions and defects in both materials and workmanship for one year from the date of purchase unless the product is sold as refurbished in which case it then comes with a (90) day Limited Warranty.

LIMITS AND EXCLUSIONS:

Warranty service is only available from within the country where the Product was originally purchased. You may be required to ship Product, at your expense, to the authorized service facility for the country where the Product was purchased.

Funai will repair or replace this Product if it fails to function properly during the warranty period, subject to any conditions and/or limitations stated herein. Warranty service will include all labor as well as any necessary adjustments and/or replacement parts. If Funai is unable to repair or replace a Product, Funai will, at its option, refund the purchase price paid for the Product provided the Product has been returned to Funai along with proof of the purchase price paid. Repair, replacement, or refund of the purchase price are the sole remedies under this warranty.

If replacement parts are used in making repairs, those parts may be remanufactured or may contain remanufactured materials. If it is necessary to replace the entire Product, it may be replaced with a remanufactured Product. Remanufactured Products, parts and materials are warranted for the remaining warranty term of the original Product, or 90 days after the date of the repair or replacement, whichever is longer.

THIS WARRANTY IS EXTENDED ONLY TO THE ORIGINAL RETAIL PURCHASER. A PURCHASE RECEIPT OR OTHER PROOF OF ORIGINAL RETAIL PURCHASE WILL BE REQUIRED TOGETHER WITH THE PRODUCT TO OBTAIN SERVICE UNDER THIS WARRANTY.

This warranty shall not be extended to any other person or transferee.

This warranty is void and of no effect if any serial numbers on the product are altered, replaced, defaced, missing or if service was attempted by an unauthorized service center.

This warranty only covers failures due to defects in material or workmanship which occur during normal use. It does not cover damage which occurs in shipment, or failures which are caused by repairs, alterations or products not supplied by FUNAI, or damage, which results from accident, misuse, abuse, mishandling, misapplication, alteration, faulty installation, improper maintenance, commercial use such as hotel, rental or office use of this product, or damage which results from fire, flood, lightning or other acts of God.

THIS WARRANTY DOES NOT COVER PACKING MATERIALS, ANY ACCESSORIES, ANY COSMETIC PARTS, COMPLETE ASSEMBLY PARTS, DEMO OR FLOOR MODELS. FUNAI AND ITS REPRESENTATIVES OR AGENTS SHALL IN NO EVENT BE LIABLE FOR ANY GENERAL, INDIRECT OR CONSEQUENTIAL DAMAGES ARISING OUT OF OR OCCASIONED BY THE USE OF OR THE INABILITY TO USE THIS PRODUCT. THIS WARRANTY IS MADE IN LIEU OF ALL OTHER WARRANTIES, EXPRESS OR IMPLIED, AND OF ALL OTHER LIABILITIES ON THE PART OF FUNAI, ALL OTHER WARRANTIES INCLUDING THE WARRANTY OF MERCHANTABILITY AND FITNESS FOR A PARTICULAR PURPOSE, ARE HEREBY DISCLAIMED BY FUNAI AND ITS REPRESENTATIVES. ALL WARRANTY INSPECTIONS AND REPAIRS MUST BE PERFORMED BY AN AUTHORIZED SERVICE CENTER.

IMPORTANT: Some states or jurisdictions do not allow exclusion or limitation of incidental or consequential damages, so the above limitation or exclusion may not apply to you. Some states or jurisdictions do not allow limitations on how long an implied warranty lasts, so the above limitation may not apply to you.

This warranty gives you specific rights, and you may have other rights which vary from state to state or by jurisdiction.

Outside the United States and Canada

In countries other than the United States and Canada, the terms and conditions of this warranty may be different. Unless a specific Funai warranty is communicated to the purchaser in writing by a Funai company, no warranty or liability exists beyond any minimum requirements imposed by law, even though defect, damage, or loss may be by negligence or other act.

ATTENTION: FUNAI RESERVES THE RIGHT TO MODIFY ANY DESIGN OF THIS PRODUCT WITHOUT PRIOR NOTICE.

WARRANTY STATEMENT REGARDING NON AUTHORIZED REPAIRS:

To obtain warranty service, you must take the product, or deliver the product freight prepaid, in either its original packaging or packaging affording an equal degree of protection, to any AUTHORIZED SERVICE CENTER. FUNAI will not reimburse you for any service done by unauthorized service providers without prior written approval.

To locate your nearest AUTHORIZED SERVICE CENTER or for general service inquiries, please contact us at:

FUNAI SERVICE CORPORATION

www.kodakverite.com/support

2425 Spiegel Drive, Groveport, OH 43125



The Kodak trademark, logo and trade dress are used under license from Kodak.
www.kodakverite.com

© 2017 Funai Electric Co., Ltd. All rights reserved.