

> EYE, EAR, NOSE AND THROAT

Otoscopes

> MacroView Otoscope	4
> 3.5 V Diagnostic Otoscope	5
> Pneumatic Otoscope	6
> Operating Otoscope	7
> 3.5 V Pneumatic Consulting Otoscope	7
> PocketScope Otoscope with Throat Illuminator	8
> CompacVideo Otoscope	8
> Reusable Otoscope Specula	9
> Disposable Specula and Dispensers	10

Ophthalmoscopes

> PanOptic Ophthalmoscope	11
> 3.5 V Coaxial Ophthalmoscope	12
> 3.5 V Standard Ophthalmoscope	13
> PocketScope Ophthalmoscope	13
> 3.5 V AutoStep Coaxial Ophthalmoscope	14
> Prestige Coaxial-Plus Ophthalmoscope	14

Power Handles, Sources and Wall Units

> 3.5 V Lithium Ion Rechargeable Handle	15
> 3.5 V Nickel-Cadmium Rechargeable Handles	15
> Universal Charger and Desk Sets	16
> Universal Desk Charger Sets	17

767 Integrated Wall Systems

> 767 Integrated Diagnostic Systems and Wall Transformer Sets	18
> Wall Set Accessories	21

Diagnostic Sets

> Otoscope Sets	22
> Ophthalmic Sets	23
> Diagnostic Sets	24

Retinoscopes

> Elite Retinoscope	28
---------------------	----

Vision Screeners

> Binocular Indirect Ophthalmoscope	29
> SureSight Vision Screener	30
> StrabismoScope Unidirectional Occluder	30

Hearing Screeners

> OAE Hearing Screener	31
------------------------	----

Tympanometric Systems

> MicroTym 2 Portable Tympanometric Instrument	32
> TM 262 AutoTym	33

Audiometers

> AM 232 Manual Audiometer	34
> AudioScope 3 Screening Audiometer	35

Ear Care

> LumiView Portable Binocular Microscope	36
---	----

Ear Wash System

> Ear Wash System	37
-------------------	----

Illuminators

> 3.5 V Halogen Fiber Optic Transilluminators	38
> 3.5 V Bivalve Nasal Speculum	38
> 3.5 V Larynx/Nasopharynx Illuminators	39
> 3.5 V Nasal Illuminators	39

Rhinolaryngoscopes

> RL-150 Rhinolaryngoscope	40
----------------------------	----

Laryngoscopes

> Fiber Optic Laryngoscope Blades	42
> Fiber Optic Laryngoscope Handles	43
> Fiber Optic Laryngoscope Sets	44
> Standard (Lamp) Laryngoscope Blades	45
> Standard Laryngoscope Handles	46
> Standard Laryngoscope Sets	47
> Mixed-Blade Standard Laryngoscope Sets	47
> Portable Standard Laryngoscope Sets	47
> Expendable Laryngoscopes	48



4 Oscopes

EYE, EAR, NOSE AND THROAT

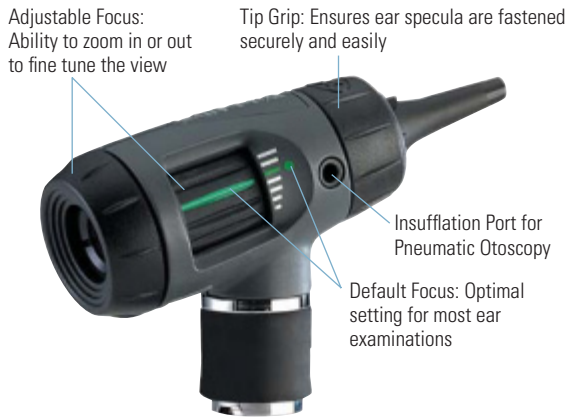

23810
MacroView Oscope

MacroView™ Oscope

Delivers almost twice the field of view at higher magnification compared to standard otoscopes, making it easier to visualize the auditory canal and tympanic membrane.

- > A nearly complete view of the tympanic membrane with approximately twice the field of view and 30% greater magnification than a traditional otoscope
- > Better clarity and definition of landmarks
- > The ability to adjust focus for variable ear canal length or farsighted eyes
- > Tip grip for secure fastening and ejection of ear specula
- > Fiber optics produce cool light with no reflections, no obstruction

23820 MacroView Oscope with Throat Illuminator



23810 MacroView Oscope



23814 MacroView Oscope with Insufflation Bulb

23824 MacroView Oscope with Throat Illuminator and Insufflation Bulb



23820
MacroView Oscope with Throat Illuminator shown with 3.5 V Lithium Ion Handle

Convert the Welch Allyn Oscope into a Throat or Nasal Illuminator	Optional Nasal Illuminator Attachment
 <p>Hold the throat illuminator's collar stationary (the black portion below the silver ring) and twist the otoscope section loose until it is removed. The throat illuminator is now ready for use.</p>	 <p>Optional fiber optic nasal illuminator attachment with 9 mm distal opening quickly twists onto the throat illuminator base for full view of nasal passages.</p>

FIELD OF VIEW	
 <p>Standard Oscope</p>	 <p>MacroView Oscope</p>
2X LARGER VIEW	



KleenSpec Disposable Ear Specula	
52432-U 2.75 mm Universal KleenSpec Pediatric Disposable Ear Specula	52434-U 4.25 mm KleenSpec Disposable Ear Specula
2.75 mm	4.25 mm

MacroView™ Otoscope Accessories

- 23804** Otoscope Insufflation Bulb and Tube with Tip for the MacroView Otoscope
- 06500-U** 3.5 V Halogen Lamp for MacroView Otoscope
- 23857** 3.5 V Throat Illuminator Section only for 23820, 26035 and 26535
- 52432-U** 2.75 mm Universal KleenSpec® Pediatric Disposable Ear Specula for Diagnostic Otoscopes (case of 10 bags, 850/bag)
- 52434-U** 4.25 mm KleenSpec® Disposable Ear Specula for Diagnostic Otoscopes (case of 10 bags, 850/bag)
- 24400-U** Set of Four Reusable Ear Specula for Diagnostic and MacroView Otoscopes—2.5, 3, 4 and 5 mm
- 24320** SofSeal, Small—recommended for 2-4.25 mm ear specula (case of 6 boxes, 80/box)
- 24330** SofSeal, Medium—recommended for 3-5 mm ear specula (case of 6 boxes, 80/box)
- 52700** Slotted Specula Instrumentation Tip—compatible with 23810 and 23820 MacroView Otoscopes (case of 4 boxes, 48/box)

24400-U Set of Four Reusable Ear Specula				
	2.5 mm	3 mm	4 mm	5 mm



25020
Diagnostic Otoscope

3.5 V Diagnostic Otoscope

Halogen HPX™ illumination and fiber optics to the distal tip for easy examinations.

- > Halogen HPX™ lamp provides 30% more light output than standard halogen lamps for true tissue color and long-lasting performance
- > Fiber optics project cool light to the distal tip with no reflections or obstructions for superior views of the tympanic membrane
- > Wide-angle viewing lens allows for instrumentation under magnification
- > Sealed system for pneumatic otoscopy and accurate diagnosis of otitis media

25020 Diagnostic Otoscope with Specula

25021 Diagnostic Otoscope with Insufflation Bulb

(3.5 V Diagnostic Otoscope accessories continued on next page)

6 Oscopes

EYE, EAR, NOSE AND THROAT



3.5 V Diagnostic Oscope Accessories (continued)

- 21504** Insufflation Bulb with Tip

- 03100-U** 3.5 V Halogen Lamp for Diagnostic Oscopes

- 23557** 3.5 V Throat Illuminator Section Only (thread on)

- 24320** SofSeal, Small—recommended for 2-4.25 mm ear specula (case of 6 boxes, 80/box)

- 24330** SofSeal, Medium—recommended for 3-5 mm ear specula (case of 6 boxes, 80/box)

- 24400-U** Set of Four Reusable Ear Specula for Diagnostic and MacroView Oscopes—2.5, 3, 4 and 5 mm

- **52432-U** 2.75 mm Universal KleenSpec® Pediatric Disposable Ear Specula for Diagnostic Oscopes (case of 10 bags, 850/bag)

- **52434-U** 4.25 mm KleenSpec® Disposable Ear Specula for Diagnostic Oscopes (case of 10 bags, 850/bag)



24400-U Set of Four Reusable Ear Specula				
	2.5 mm	3 mm	4 mm	5 mm
	○	○	○	○

Pneumatic Oscope



20200
Pneumatic Oscope

Provides 30% brighter, whiter light output and a rotating lens with ultraseal for pneumatic otoscopy.

- > Halogen HPX™ lamp provides 30% more light output than standard halogen lamps for true tissue color and consistent, long-lasting illumination
- > Rotating lens with ultraseal enables easy pneumatic otoscopy
- > Fiber optic illumination produces cool light

- 20200** 3.5 V Pneumatic Oscope with Specula
- 20201** 3.5 V Pneumatic Oscope without Specula
- 20250** 3.5 V Pneumatic Oscope with 12-Diopter Lens and Specula
- 20251** 3.5 V Pneumatic Oscope with 12-Diopter Lens

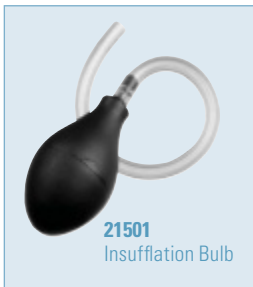

3.5 V Pneumatic Oscope Accessories

- 21501** Insufflation Bulb without Tip

- 03100-U** 3.5 V Halogen Lamp



21700
3.5 V Operating Otoscope

Operating Otoscope

Open system with rotatable lens and optional speculum for convenient procedures, plus 30% brighter, whiter light output than standard halogen lamps.

- > Halogen HPX™ lamp produces 30% brighter, whiter light for true tissue color and long-lasting performance
- > Open system makes use during procedures more convenient
- > Rotatable lens and speculum for ease of use
- > Fiber optic illumination produces cool light

21700 3.5 V Operating Otoscope with Specula

21701 3.5 V Operating Otoscope without Specula

3.5 V Operating Otoscope Accessories

209026-501 Replacement Lens Assembly (black)

03100-U 3.5 V Halogen Lamp



20202
3.5 V Pneumatic
Consulting Otoscope

3.5 V Pneumatic Consulting Otoscope

Ultrasealed for pneumatic otoscopy, with two viewing lenses for dual observation of the tympanic membrane.

- > Halogen HPX lamp provides 30% more light output than standard halogen lamps for true tissue color and consistent, long-lasting illumination
- > Two viewing lenses make dual observation, teaching, and consulting easy
- > Fiber-optic illumination produces cool light
- > Sealed system for pneumatic otoscopy
- > Rotatable head for left- and right-sided viewing

20202 3.5 V Pneumatic Consulting Otoscope with Specula

20203 3.5 V Pneumatic Consulting Otoscope without Specula

3.5 V Pneumatic Consulting Otoscope Accessories

21501 Insufflation Bulb without Tip

03100-U 3.5 V Halogen Lamp



21501
Insufflation Bulb

8 Oscopes

EYE, EAR, NOSE AND THROAT



22820
PocketScope
Otoscope with
"AA" Handle

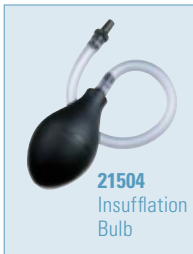

21504
Insufflation
Bulb

PocketScope™ Otoscope with Throat Illuminator

Small, convenient, and easy to use with bright, white halogen light and a built-in throat illuminator.

- 22820** PocketScope Otoscope with "AA" Handle
- 21111** PocketScope Otoscope (head only)
- 22800** PocketScope Otoscope with Rechargeable Handle
- 22811** PocketScope Otoscope with Rechargeable Handle and Soft Case
- 22821** PocketScope Otoscope with "AA" Handle and Soft Case
- 22822** PocketScope Otoscope with "AA" Handle and Hard Case

PocketScope™ Otoscope/Throat Illuminator Accessories

- | | |
|---|---|
| 21504 Insufflation Bulb with Tip for Diagnostic Otoscope | 72600 2.5 V Rechargeable Battery for PocketScope |
| 03400-U 2.5 V Halogen Lamp for PocketScope Instruments | 211026-502 Otoscope Illuminator Assembly |

CompacVideo™ Otoscope

All the advantages of the most sophisticated video otoscopes, at a fraction of the price.

- > Ideal for pediatric environments
- > Provides crisp, clear images to promote patient education and compliance
- > Assists in training of medical students/residents and staff
- > Prefocused and fully automatic so it is simple to operate
- > Portable, lightweight unit fits in the palm of your hand
- > Powered by any Welch Allyn 3.5 V battery handle
- > Totally self-contained system requires no separate power source, light source or video processor
- > Connects to any TV or monitor with a video input jack



23101
CompacVideo Otoscope

- 23100** CompacVideo™ Otoscope Head with 10 Disposable (4 mm) Specula and Video Cable
- 23101** CompacVideo Otoscope Head with 10 Disposable (4 mm) Specula, Video Cable and Convertible NiCad Handle

CompacVideo Otoscope Accessories

- 03500-U** Replacement Lamp Assembly
- 45518** Video Cable, RCA/RCA, 12 ft

Reusable Otoscope Ear Specula

Economical and reliable.

- > Reusable specula are lightweight yet durable, and may be autoclaved, boiled, or sterilized in solution
- > SofSpec® reusable specula also have an elastomer tip specially contoured for an ultra pneumatic seal



22002
Reusable Otoscope
Specula

Pneumatic/Operating/Consulting Standard Reusable Specula

- **22002** 2.0 mm Reusable Otoscope Ear Speculum
- **22003** 3.0 mm Reusable Otoscope Ear Speculum
- **22004** 4.0 mm Reusable Otoscope Ear Speculum
- **22005** 5.0 mm Reusable Otoscope Ear Speculum
- **22009** 9.0 mm Reusable Otoscope Ear Speculum
- 22100** Set of Five Reusable Otoscope Ear Specula for Pneumatic, Operating and Consulting Otoscopes—2.0, 3.0, 4.0, 5.0 and 9.0 mm



22023
SofSpec Extra Comfort
Reusable Otoscope Specula

Pneumatic/Operating/Consulting SofSpec® Reusable Specula

- **22023** 3.0 mm SofSpec Extra Comfort Reusable Otoscope Ear Specula
- **22025** 5.0 mm SofSpec Extra Comfort Reusable Otoscope Ear Specula
- **22027** 7.0 mm SofSpec Extra Comfort Reusable Otoscope Ear Specula
- 22120** Set of 3 SofSpec Extra Comfort Reusable Otoscope Ear Specula 3.0, 5.0, 7.0 mm for Pneumatic, Operating and Consulting Otoscopes



24302-U
Reusable Otoscope
Specula

Diagnostic/MacroView/Standard Reusable Specula

- **24302-U** 2.5 mm Reusable Otoscope Ear Speculum
- **24303-U** 3.0 mm Reusable Otoscope Ear Speculum
- **24304-U** 4.0 mm Reusable Otoscope Ear Speculum
- **24305-U** 5.0 mm Reusable Otoscope Ear Speculum
- 24400-U** Set of Four Reusable Otoscope Ear Specula for Diagnostic and MacroView Otoscopes—2.5, 3.0, 4.0 and 5.0 mm



24323
SofSpec® Extra Comfort
Reusable Otoscope Ear
Specula

Diagnostic SofSpec Reusable Specula

- *** 24323** 3.0 mm SofSpec Extra Comfort Reusable Otoscope Ear Specula
- *** 24325** 5.0 mm SofSpec Extra Comfort Reusable Otoscope Ear Specula
- *** 24327** 7.0 mm SofSpec Extra Comfort Reusable Otoscope Ear Specula
- * 24420** Set of 3 SofSpec Extra Comfort Reusable Otoscope Ear Specula for Diagnostic Otoscopes—3.0, 5.0 and 7.0 mm

*** For use with models 25020 and 20000 otoscopes only.**

10 Oscopes

EYE, EAR, NOSE AND THROAT

Disposable Specula and Dispensers

Safe, convenient, and affordable.

- > KleenSpec Disposable Specula are economical and convenient
- > KleenSpec Disposable Specula are made from non-toxic plastic and are available in a variety of sizes
- > KleenScoop™ cerumen removal disposable specula are designed for curettage of the outer ear canal and will reach just beyond the anterior prominence of the ear canal in patients over 10 years old
- > The dispenser holds all specula sizes within a series
- > Dispenser is available with and without a storage compartment



52401
Disposable Oscope
Specula Dispenser for 524
Series Oscope Specula

KleenSpec Diagnostic and KleenScoop Cerumen Removal Disposable Specula—524 Series

- > KleenSpec Diagnostic and KleenScoop cerumen removal disposable specula (524 Series) are compatible with any Welch Allyn otoscope, model series 200, 250, 238 and PocketScope

Disposable Oscope Specula

- **52432-U** 2.75 mm Universal KleenSpec Pediatric Disposable Ear Specula for Diagnostic Oscopes (case of 10 bags, 850/bag)
- **52434-U** 4.25 mm KleenSpec Disposable Ear Specula for Diagnostic Oscopes (case of 10 bags, 850/bag)
- **52450** KleenScoop (case of 10 boxes, 100 pieces per box), not compatible with 238 MacroView Oscopes

Disposable Oscope Specula Dispenser

- **52401** Dispenser for Disposable Ear Specula with storage 524—Series (case of 10 Dispensers)
- **52400** Dispenser for Disposable Ear Specula without storage 524—Series (case of 10 Dispensers)



52100
Disposable Oscope
Specula Dispenser for
521 Series Oscope
Specula

KleenSpec Pneumatic, Operating and Consulting Disposable Specula—521 Series

- > KleenSpec Pneumatic, Operating and Consulting disposable specula (521 Series) are compatible with otoscope models 20200, 21700, 20202, 20100 and 21600

Disposable Oscope Specula

- **52133** 3.0 mm KleenSpec® Disposable Ear Specula for Pneumatic, Operating and Consulting Oscopes (case of 10 bags, 500/bag)
- **52134** 4.0 mm KleenSpec® Disposable Ear Specula for Pneumatic, Operating and Consulting Oscopes (case of 10 bags, 500/bag)
- **52135** 5.0 mm KleenSpec® Disposable Ear Specula for Pneumatic, Operating and Consulting Oscopes (case of 10 bags, 500/bag)

Disposable Oscope Specula Dispenser

- **52101** Dispenser for Disposable Ear Specula with storage 521—Series (case of 10 Dispensers)
- **52100** Dispenser for Disposable Ear Specula without storage 521—Series (case of 10 Dispensers)



11820
PanOptic Ophthalmoscope head shown with Lithium Ion Power Handle

PanOptic™ Ophthalmoscope

Provides easy entry into the eye, together with a wider field of view to more easily observe conditions such as hypertension, diabetic retinopathy, and papilledema.

- > Fast, easy entry into undilated pupils
- > 5X larger view of the fundus vs. standard ophthalmoscopes in an undilated eye
- > 25° field of view vs. the standard 5° field of view
- > Greater working distance improves comfort for both practitioner and patient
- > Helps detect corneal abrasions with cobalt blue filter and corneal viewing lens (model 11820 only)
- > Patented Glare Extinguishment System prevents interference from unwanted glare and reflections
- > Halogen HPX™ lamp provides bright, white light
- > Compatible with all existing Welch Allyn 3.5 V power sources

11810 PanOptic Ophthalmoscope

11820 PanOptic Ophthalmoscope with Cobalt Blue Filter and Corneal Viewing Lens

PanOptic Ophthalmoscope Accessories

03800-U Halogen HPX Lamp

11870 Patient Eyecup (pkg of 5)

11875 Corneal Viewing Lens

05258-M PanOptic Diagnostic Set Carrying Case (rigid)

05815-M PanOptic Diagnostic Set Carrying Case (soft)



11870
Patient Eyecup for PanOptic Ophthalmoscope



11875
Corneal Viewing Lens for PanOptic Ophthalmoscope

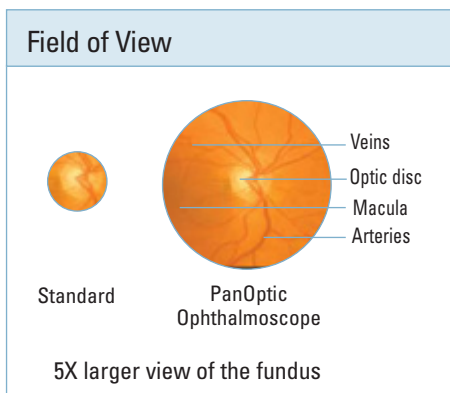

Instrument Head	Lenses	Filters	Optical System
	+20 to -20	Red-free Cobalt Blue (model 11820 only)	Patented Axial PointSource™ Optics

12 Ophthalmoscopes

EYE, EAR, NOSE AND THROAT



3.5 V Coaxial Ophthalmoscope

The patented Welch Allyn Coaxial Vision System facilitates ophthalmoscopy by enabling easier entry into the eye, a larger field of view, and reduced glare compared to standard ophthalmoscopes.

- > Halogen HPX™ lamp provides 30% whiter, brighter light than standard halogen lamps for true tissue color and long-lasting performance
- > Coaxial optics produce a shadow-free spot, easier entry into undilated pupils, and a larger field of view versus standard ophthalmoscopes
- > Detect corneal abrasions with cobalt blue filter
- > Polarizing filter virtually eliminates corneal reflection
- > Sealed optics keep out dust and dirt
- > 18 unique aperture/filter combinations for greater versatility
- > Red-free filter may be used with any aperture
- > 28 focusing lenses with a range of -25 to +40 diopters

11720 Coaxial Ophthalmoscope

3.5 V Coaxial Ophthalmoscope Accessories

04900-U 3.5 V Halogen Lamp for 11720 Ophthalmoscopes

Lenses	Filters	Optical System
28 Lenses	Cross-linear Polarizing Red-free Cobalt Blue	Coaxial Optics

APERTURES FOR:

3.5 V Coaxial Ophthalmoscope, 3.5 V AutoStep® Coaxial Ophthalmoscope and Prestige Coaxial-Plus Ophthalmoscope (models 11720, 11730 and 11735)



MICRO-SPOT APERTURE: allows quick entry into small, undilated pupils.



SMALL APERTURE: provides excellent view of fundus through an undilated pupil.



LARGE APERTURE: standard aperture for a dilated pupil and general examination of the eye.



FIXATION APERTURE: has graduated cross-hairs for measuring eccentric fixation or locating lesions.



COBALT FILTER: used with fluorescein dye to view small lesions, abrasions, and foreign objects on the cornea.



SLIT: used to determine levels of lesions and tumors.



RED-FREE FILTER: excludes red rays from examination field for easy identification of veins, arteries and nerve fibers.



11710
Standard Ophthalmoscope

APERTURES FOR: 3.5 V Standard Ophthalmoscope



MICRO-SPOT APERTURE: allows quick entry into small, undilated pupils.



SMALL APERTURE: provides excellent view of fundus through an undilated pupil.



LARGE APERTURE: standard aperture for a dilated pupil and general examination of the eye.



FIXATION APERTURE: has graduated cross-hairs for measuring eccentric fixation or locating lesions.



SLIT: used to determine levels of lesions and tumors.



RED-FREE FILTER: excludes red rays from examination field for easy identification of veins, arteries and nerve fibers.

3.5 V Standard Ophthalmoscope

Uses halogen light for true tissue color and consistent, long-lasting illumination. Versatile and reliable at an economical price.

- > Six apertures for generalist use: micro, small, and large spot sizes, fixation target, slit aperture, and red-free filter
- > 28 focusing lenses with a range of -25 to +40 diopters
- > Rubber brow rest prevents scratching of eyeglasses

11710 Standard Ophthalmoscope (head only)

3.5 V Standard Ophthalmoscope Accessories

03000-U 3.5 V Halogen Lamp for 11710 Standard Ophthalmoscope

Lenses	Filters	Optical System
28 Lenses	Red-free	Standard Optics



12800
PocketScope Ophthalmoscope with Rechargeable Handle

PocketScope™ Ophthalmoscope

Lightweight, compact diagnostic instruments deliver high performance in a slightly smaller package.

- > Halogen light for true tissue color and consistent, long-lasting illumination
- > 12 aperture/filter combinations for greater versatility: micro, small, and large spot sizes, cobalt blue filter for corneal exams, fixation target, and slit aperture, plus red-free filter and unfiltered halogen
- > 48 focusing lenses for better resolution

12800 PocketScope Ophthalmoscope with Rechargeable Handle

13000 PocketScope Ophthalmoscope (head only)

12811 PocketScope Ophthalmoscope with Rechargeable Handle and Soft Case

12820 PocketScope Ophthalmoscope with "AA" Handle

12821 PocketScope Ophthalmoscope with "AA" Handle and Soft Case

PocketScope™ Ophthalmoscope Accessories

03900-U 2.5 V Halogen Lamp

72600 2.5 V Rechargeable Battery

05280-1 Hard Case for PocketScope Sets and Instruments

05928-U Soft Zipper Case for PocketScope Set

14 Ophthalmoscopes

EYE, EAR, NOSE AND THROAT



Lenses	Filters	Optical System
68 Lenses	Cobalt Blue Cross-linear Polarizing Red-free	Coaxial Optics

3.5 V AutoStep® Coaxial Ophthalmoscope

Patented coaxial optics, Halogen HPX™ illumination, and 68 focusing lenses combine for premium quality.

- > Halogen HPX™ lamp provides 30% brighter, whiter light output than standard halogen lamps for true tissue color and consistent, long-lasting illumination
- > Coaxial optics produce a shadow-free spot, easier entry into undilated pupils, and a larger field of view
- > 18 aperture/filter combinations for greater versatility: micro, small, and large spot sizes, cobalt blue filter for corneal exams, fixation target, or slit aperture can be combined with red-free filter, polarizing filter, or unfiltered Halogen HPX illumination
- > 68 lenses in single-diopter steps for precise resolution (+38 to -30)
- > Sealed optics keep out dust and dirt for years of maintenance-free operation
- > Rubber brow rest prevents scratching of eyeglasses

11730 AutoStep Coaxial Ophthalmoscope (head only)

3.5 V AutoStep Coaxial Ophthalmoscope Accessories

04900-U 3.5 V Halogen Lamp



Lenses	Filters	Optical System
68 lenses: -30 to +38 diopters	Neutral Density Opacity Setting Red-free Cobalt Blue	Coaxial-Plus Optics

Prestige Coaxial-Plus Ophthalmoscope

Patented Coaxial-Plus optics enable easy entry into undilated pupils for more accurate diagnoses, while two filter selections provide optimum light levels for entering healthy eyes and those with cataracts.

- > Enables easy entry into undilated pupils through precise lamp filament and optical alignment
- > The neutral filter provides the ideal amount of color-accurate Halogen HPX light for entering healthy eyes without unwanted reflex
- > The opacity setting provides the brightest Halogen HPX light for easy entry into eyes with cataract or other media opacity
- > 68 lenses provide extensive range of focus for optimum resolution (+38 to -30)

11735 Prestige Coaxial-Plus Ophthalmoscope (head only)

Prestige Coaxial-Plus Ophthalmoscope Accessories

04900-U 3.5 V Halogen Lamp

3.5 V Lithium Ion Rechargeable Handle

Twice the on-time as a conventional handle, half the weight, and fits more comfortably in your hand.

- > Half the weight of traditional 3.5 V handles
- > Fits all Welch Allyn 3.5 V instrument heads
- > 120 minutes of on-time (compared to 60 minutes for standard NiCad handles)
- > Made of sturdy CYCOLOY® engineering resin
- > Low-battery indicator
- > Lithium ion battery technology that has no “memory” effect
- > AC charging module is easily removable from the handle and has retractable AC prongs (model 71900 only)
- > Optional charging well adapter allows the handle to be charged in consoles or 71110 Desk Charger

71900 Lithium Ion Handle with AC Charging Module

71930 Lithium Ion Handle with Well Adapter

3.5 V Lithium Ion Rechargeable Handle Accessories

71950 Lithium Ion Power Handle AC Charging Module only

71980 Lithium Ion Power Handle Well Adapter Module only (For use with 71110 Desk Charger)

71990 Lithium Ion Power Handle Well Adapter Module only (For use with select stand console chargers)

71960 Replacement Lithium Ion Battery

3.5 V Nickel-Cadmium Rechargeable Handles

A choice of convenient rechargeable power sources that fit all our 3.5 V instrument heads.

- > Rechargeable nickel-cadmium battery included
- > Smooth, nonabrasive knurled finish ensures a no-slip grip
- > Chrome-plated brass construction for durability and reliable long-life
- > Rechargeable or can be converted for use with standard C-cell batteries (model 71000-C only)
- > Recharges in the Welch Allyn desk charger and numerous stand consoles and well-chargers (model 71670)

71000-A Rechargeable Handle

71000-C Rechargeable/Convertible Handle

71670 Rechargeable NiCad handle for Desk/Well Chargers

(continued on next page)



71900
Rechargeable 3.5 V Lithium Ion Handle



71980

71950



71000-C
Convertible Rechargeable Nickel Cadmium (NiCad) Handle



Transformer ETL/UL Recognized

NiCad Battery

C-cell Converter

C-cell Battery

16 Power Handles, Sources and Wall Units

EYE, EAR, NOSE AND THROAT



71000-A
Rechargeable Nickel
Cadmium (NiCad) Handle

3.5 V Nickel-Cadmium Rechargeable Handles (continued)

72300 Replacement NiCad Rechargeable Battery (orange) for 71000-A/71000-C

710168-501 Battery Converter Ring (section only) for 71000-A/71000-C

72200 Replacement NiCad Rechargeable Battery (black) for 71000 and 71670

Universal Charger and Desk Sets

Compact, portable unit provides convenient drop-in recharging of desk/well-charger instrument handles.

- > Colored LEDs indicate power to the unit and that handles are charging
- > Advanced circuitry for constant automatic safe charging and optimum lamp performance and life
- > Compact for convenience and mobility
- > Optional wall mount kit for permanently mounting to wall or cabinet
- > Optional specula tray conveniently stores swabs, otoscope specula, and currettes
- > Accepts 3.5 V or 2.5 V well-rechargeable NiCad handles, Lithium Ion and PocketScope™ handles (PocketScope requires an adapter)



71140
Universal Desk Charger for
Lithium Ion, NiCad and
Pocket Handles



71249
PocketScope Adapter Sleeve
for Universal Desk Charger

71140 Universal Desk Charger

71630 Desk Charger with two NiCad Handles

71640 Desk Charger with two Lithium Ion Handles

79290 Universal Desk Charger with two PocketScope Adapter Sleeves

Universal Charger and Desk Sets Accessories

71420 Wall Mount Kit for Desk Charger

71310 Specula Tray

71249 PocketScope Adapter Sleeve

71670 3.5 V Rechargeable NiCad Handle for Universal Charger

71910 3.5 V Lithium Ion Handle for Universal Charger

Universal Desk Charger Sets

The chart below outlines the specific products/devices that are included in each set.



DESK CHARGER SET COMPONENTS													
Part Number	Ophthalmoscopes				Otosopes			Handles			Desk Charger	Cases	
	11810	11820	11720	13000	20200	23810	21111	71670*	71910*	72800/ 71249 Pocket*	71140	Hard	Soft
71510-PSM		●			●				●		●		
71630								●			●		
71640									●		●		
71641-M			●			●		●			●		
71641-MS			●			●			●		●		
71811-MP	●					●		●			●		
71811-MPS	●					●			●		●		
71821-MP		●				●		●			●		
92850				●			●			●	●	●	
92851				●			●			●	●		●

*All desk sets come with two handles

18 767 Integrated Wall Systems

EYE, EAR, NOSE AND THROAT

767 Integrated Diagnostic Systems and Wall Transformer Sets

A convenient, modular package that puts everything needed for fast, accurate diagnoses at arm's length. By combining a wall aneroid, ophthalmoscope, otoscope, specula dispenser, and thermometer (optional), Welch Allyn puts all the basic diagnostic tools within easy reach. These systems are attractive, modular, and easy to order and install.

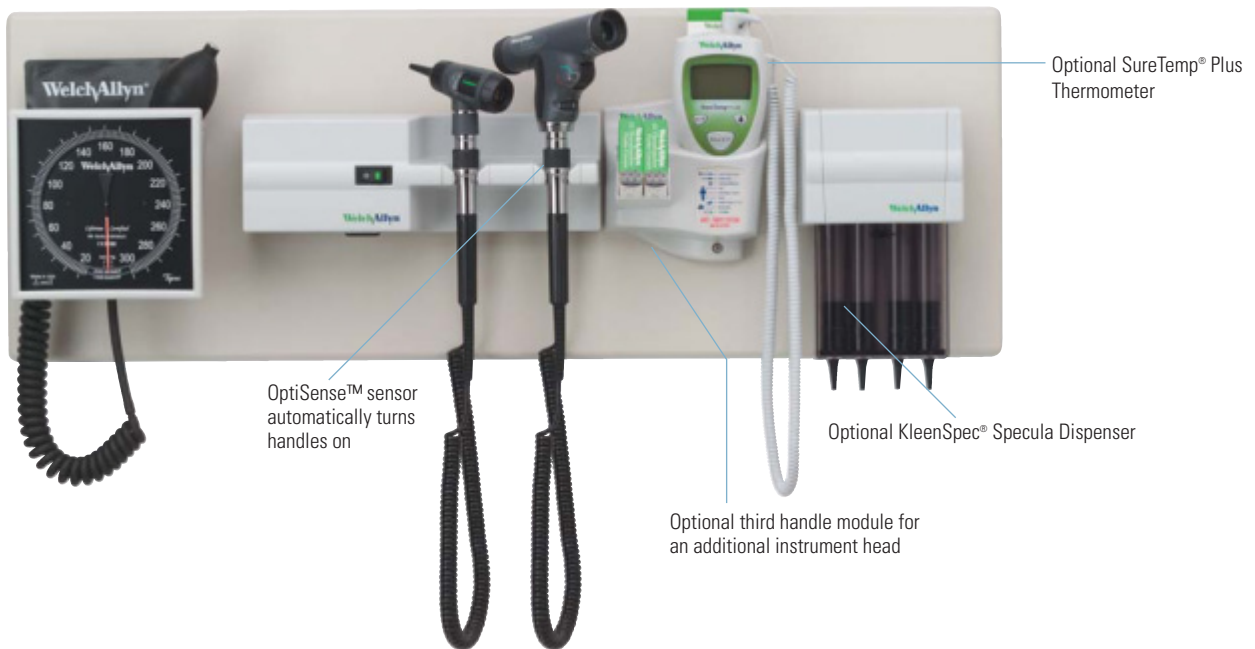

- > All the instruments you'll need to perform a complete diagnostic examination
- > Handle-based rheostats for quick light-intensity adjustments
- > Comfortable, contoured handles are easy to hold and maneuver
- > Durable, easy-to-clean, high-impact ABS housing
- > OptiSense™ sensor automatically turns handles on when they are removed from the cradles and off when they are replaced
- > Optional KleenSpec® Diagnostic or Pneumatic Specula Dispenser
- > Optional digital clock with pulse timer
- > Choose one of four halogen ophthalmoscopes, including the innovative PanOptic™ Ophthalmoscope that makes it easy to view the fundus 5X larger than ever before. Choose either PanOptic model 11810 or model 11820 with cobalt blue filter and corneal viewing lens. Other options include the traditional Standard Ophthalmoscope (11710) and the sealed (dust-free) Coaxial Ophthalmoscope (11720)
- > Otoscope options include the MacroView™, which provides 30% more magnification and nearly twice the field of view of traditional otoscopes and a Pneumatic Otoscope
- > 767 Wall Aneroid with easy-to-read dial face, certified accuracy and lifetime calibration program
- > Sturdy, predrilled mounting board mounts easily to any wall, preventing loss or theft
- > Optional SureTemp® Plus Electronic Thermometer for highly accurate oral readings in approximately 4 to 6 seconds, rectal readings in approximately 15 seconds

(See next page for full list of configurations)



76791-2MPX
767 Integrated Diagnostic System with PanOptic Ophthalmoscope, MacroView Otoscope, Tycos Wall Aneroid, SureTemp Plus Thermometer and Otoscope Specula Dispenser











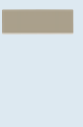

WELCH ALLYN INTEGRATED DIAGNOSTIC SYSTEM AND WALL TRANSFORMER SETS—COMPONENTS CHART

Part Number	Wall Board	767 Wall Transformer		Standard Ophthalmoscopes		PanOptic Ophthalmoscopes		Diagnostic MacroView Otoscopes		Pneumatic Otoscopes	767 Aneroid	KleenSpec Dispenser (Small)	KleenSpec Dispenser (Large)	SureTemp Plus Thermometer
			76720 (clock)											
	76710			11710	11720	11810	11820	23810	23820	20200	7670-01	52401	52101	01690-300
76791-MX	●	●		●				●			●	●		●
76791-1MPX	●	●				●		●			●	●		●
76791-2MPX	●	●					●	●			●	●		●
76791-22MPX	●		●				●	●			●	●		●
76792-M	●	●		●				●			●	●		
76792-MNOBP	●	●		●				●				●		
76792-1MP	●	●				●		●			●	●		
76792-2MP	●	●					●	●			●	●		
76793-MX	●	●			●			●			●	●		●
76794-M	●	●			●			●			●	●		
76795-1MPX	●	●				●			●		●	●		●
76795-2MPX	●	●					●		●		●	●		●
76796-M	●	●		●					●		●	●		

20 767 Integrated Wall Systems

EYE, EAR, NOSE AND THROAT

WELCH ALLYN INTEGRATED DIAGNOSTIC SYSTEM AND WALL TRANSFORMER SETS—COMPONENTS CHART

Part Number	Wall Board	767 Wall Transformer		Standard Ophthalmoscopes		PanOptic Ophthalmoscopes		Diagnostic MacroView Otoscopes		Pneumatic Otoscopes	767 Aneroid	KleenSpec Dispenser (Small)	KleenSpec Dispenser (Large)	SureTemp Plus Thermometer
			76710	76720 (clock)										
76796-1MP	•	•				•			•		•	•		
76796-2MP	•	•					•		•		•	•		
76797X	•	•			•					•	•		•	•
76797-2PX	•	•					•			•	•		•	•
76798-2P	•	•					•			•	•		•	
76710-71M		•			•			•						
76710-72M		•				•		•						
76710-81M		•				•		•						
76710-82M		•					•	•						
76710-TX		•												•
76710-TAX		•									•			•
76710-TAKX		•									•	•		•
76710-TAPX		•									•		•	•
76710-TKX		•										•		•
76710-TPX		•											•	•

WELCH ALLYN INTEGRATED DIAGNOSTIC SYSTEM AND WALL TRANSFORMER SETS—COMPONENTS CHART

Part Number	Wall Board	767 Wall Transformer		Standard Ophthalmoscopes		PanOptic Ophthalmoscopes		Diagnostic MacroView Oscopes		Pneumatic Oscopes	767 Aneroid	KleenSpec Dispenser (Small)	KleenSpec Dispenser (Large)	SureTemp Plus Thermometer
			76720 (clock)											
		76710	76720 (clock)	11710	11720	11810	11820	23810	23820	20200	7670-01	52401	52101	01690-300
76794-MSPOT*	●	●			●			●				●		
76794-MLXI*	●	●			●			●				●		
76794-2MPSPOT*	●	●				●		●				●		
76794-2MPLXI*	●	●				●		●				●		

*Spot Vital Signs® or Spot Vital Signs® LXi monitor and mounting bracket ordered separately.

Wall Set Accessories

Customize your Wall Set to match your individual needs.







76710	767 Wall Transformer	7670-01	767 Tycos® Wall Aneroid with Durable One-Piece Adult Cuff
76720	767 Wall Transformer with Digital Clock	52101	KleenSpec® Pneumatic, Operating, and Consulting Oscope Disposable Specula Dispenser with Storage Compartment
76730	767 Third Handle Module	52401	Universal KleenSpec® MacroView Oscope Disposable Specula Dispenser with Storage Compartment
76790-3	Wall Board for mounting Instruments	76700	Locking Collar for theft protection (set of 2)
76790-4	Wall Board for mounting instruments and Spot Vital Signs® Monitor		
76790-5	Wall Board for mounting instruments and Spot Vital Signs® LXi Monitor		
01690-300	SureTemp® Plus 690 Electronic Thermometer, One Room, Wall Mount, 9 ft Cord and Oral Probe with Oral Probe Well		

22 Diagnostic Sets

EYE, EAR, NOSE AND THROAT

Otoscope Sets

Innovative technology with a variety of options to fit your requirements.

OTOSCOPE SET COMPONENTS							
Part Number	Otosopes				Handles	Cases	
							
	23810	23820	20200	21700	71000-A*	Hard	Soft
20270			●		●	●	
20271			●		●		●
21770				●	●	●	
21771				●	●		●
25070-M	●				●	●	
25270-M		●			●	●	

*Note: Add a "C" to the end of the item numbers above for a set with the 71000-C Convertible handle in place of the 71000-A.
(i.e., 25070-MC to receive the 71000-C handle)



18320-PSM
PanOptic Smart Set

Ophthalmic Sets

Many busy practitioners find that the best way to carry and store equipment is in a diagnostic set, so Welch Allyn offers a variety of customized equipment options to fit your specific needs.

OPHTHALMIC SET COMPONENTS										
Part Number	Ophthalmoscopes				Retinoscopes		Fixation Cards	Handles		Case
18335		•			•		•	•		•
18335-SM		•			•		•		•	•
18330			•		•		•	•		•
18330-SM			•		•		•		•	•
18430			•			•	•	•		•
18320				•	•		•	•		•
18320-PC	•				•		•	•		•
18320-PSM	•				•		•		•	•
18420				•		•	•	•		•
11790			•					•		•
11770				•				•		•

*Available with Convertible Handle; add "-C" to set number when ordering (e.g., 18335 to 18335-C)
 **All sets available in Soft Case by changing last numeric digit of set to 1 (e.g., 18335 to 18331)

24 Diagnostic Sets

EYE, EAR, NOSE AND THROAT

Diagnostic Sets

The chart below outlines the specific products/devices that are included in each set.

DIAGNOSTIC SET COMPONENTS														
Part Number	Ophthalmoscopes				Otosopes				Handles			Nasal Illuminators	Cases	
														
	11810	11820	11710	11720	23810	23820	20200	21700	71000-A	71000-C	71900	26535	Hard	Soft
97100-M			•			•			•				•	
97100-MC			•			•				•			•	
97100-MPC	•					•				•			•	
97100-MPS	•					•					•		•	
97100-MS			•			•					•		•	
97101-M			•			•			•					•
97101-MC			•			•				•				•
97101-MPC	•					•				•				•
97101-MPS	•					•					•			•
97110-M			•			•			•			•	•	
97110-MC			•			•				•		•	•	
97110-MPC	•					•				•		•	•	
97110-MPS	•					•					•	•	•	
97110-MS			•			•					•	•	•	
97111-M			•			•			•			•		•
97111-MC			•			•				•		•		•
97120			•				•		•				•	
97120-C			•				•			•			•	
97121			•				•		•					•
97121-C			•				•			•				•

DIAGNOSTIC SET COMPONENTS														
Part Number	Ophthalmoscopes				Otosscopes				Handles			Nasal Illuminators	Cases	
														
	11810	11820	11710	11720	23810	23820	20200	21700	71000-A	71000-C	71900	26535	Hard	Soft
97150-M			•		•				•				•	
97150-MC			•		•					•			•	
97150-MPC	•				•					•			•	
97150-MPS	•				•						•		•	
97150-MS			•		•						•		•	
97151-M			•		•				•					•
97151-MC			•		•					•				•
97151-MS			•		•						•			•
97170			•					•	•				•	
97171			•					•	•					•
97171-C			•					•		•				•
97200-M				•		•			•				•	
97200-MC				•		•				•			•	
97200-MPC		•				•				•			•	
97200-MPS		•				•					•		•	
97200-MS				•		•					•		•	
97201-M				•		•			•					•
97201-MC				•		•				•				•
97201-MPS		•				•					•			•
97201-MS				•		•					•			•
97210-M				•		•			•			•	•	
97210-MC				•		•				•		•	•	
97210-MPC		•				•				•		•	•	
97210-MPS		•				•					•	•	•	

26 Diagnostic Sets

EYE, EAR, NOSE AND THROAT

DIAGNOSTIC SET COMPONENTS														
Part Number	Ophthalmoscopes				Otosopes				Handles			Nasal Illuminators	Cases	
														
	11810	11820	11710	11720	23810	23820	20200	21700	71000-A	71000-C	71900	26535	Hard	Soft
97210-MS				•		•					•	•	•	
97211-M				•		•			•			•		•
97211-MC				•		•				•		•		•
97211-MPS		•				•					•	•		•
97211-MS				•		•					•	•		•
97250-M				•	•				•				•	
97250-MC				•	•					•			•	
97250-MPC		•			•					•			•	
97250-MPS		•			•						•		•	
97250-MS				•	•						•		•	
97251-M				•	•				•					•
97251-MC				•	•					•				•
97251-MPS		•			•						•			•
97251-MS				•	•						•			•
97220				•			•		•				•	
97220-C				•			•			•			•	
97220-SM				•			•				•		•	
97221				•			•		•					•
97221-C				•			•			•				•
97270				•				•	•				•	
97270-C				•						•			•	
97271				•				•	•					•
97271-C				•				•		•				•



92000
2.5 V CompacSet

2.5 V CompacSet™

The perfect “second set” for a fast paced environment.

- > Full-featured ophthalmoscope and fiber-optic otoscope integrated into one, easy-to-use instrument
- > Fold-away design keeps instruments protected on the go
- > Halogen illumination gives brighter, whiter, long-lasting light
- > Instrument heads swivel for easy access from any position
- > Powered by AA or rechargeable batteries

92000 CompacSet™ with AA batteries

92100 CompacSet™ with NiCad rechargeable batteries



92821
2.5 V PocketScope
with Soft Case

2.5 V PocketScope™ Set

Have all the accuracy of Welch Allyn diagnostics right in your lab coat pocket.

- > 2.5 V PocketScope Ophthalmoscope with consistent, long-lasting halogen illumination for true tissue color
- > 2.5 V PocketScope Otoscope with built-in throat illuminator gives you two instruments in one, with halogen illumination and fiber optics for cool light
- > Adjustable rheostat to control light intensity
- > Powered by AA batteries
- > Available in either hard or soft case

92820 PocketScope Set with Hard Case

92821 PocketScope Set with Soft Case

28 Retinoscopes

EYE, EAR, NOSE AND THROAT



18245
Elite Retinoscope
Shown with 719
Lithium Ion Handle

Elite™ Retinoscope

Makes refractions easier than ever by producing one of the brightest, sharpest, and cleanest streaks available.

- > Provides 2.8X the brightness of our standard retinoscopes
- > Superior streak quality enables easier and quicker refractions—even in patients with small pupils
- > Crossed linear polarizing filter eliminates bothersome glare from trial lenses, helping you perform a more precise exam
- > External focusing sleeve improves comfort and maneuverability
- > Sealed optics keep the lenses cleaner for more effective exams

18245 Welch Allyn Elite Streak Retinoscope

18300 Welch Allyn Elite Spot Retinoscope

Elite™ Retinoscope Accessories

Spot Retinoscope Interchangeability

Simply insert a spot filament bulb in place of the streak filament bulb and the Welch Allyn Elite Retinoscope is converted into a Spot Retinoscope. This allows you to perform spot retinoscopy without having to buy a second scope.

08200-U Halogen HPX Streak Replacement Lamp

08300-U Halogen HPX Spot Replacement Lamp

18250 Fixation Cards for dynamic retinoscopy (set of 4)

Spot/Streak Interchangeability



For those preferring a spot retinoscope, the Welch Allyn streak retinoscope converts to a spot retinoscope by simply replacing the streak lamp with a spot lamp.

Fixation Cards



Set of four fixation cards quickly and easily attach to magnetic logo on instrument head for dynamic retinoscopy.

Brightness vs Our Standard Retinoscope

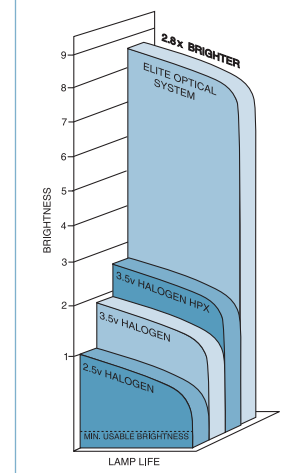



12500
Binocular Indirect Ophthalmoscope

Small Pupil Capability

Convergence control allows illumination and visual pathways to be synchronized for excellent viewing in patients with pupils as small as 2 mm.



74360
Portable Power Source for BIO



74350
Wall/Desk Power Source for BIO



05120-U
Soft Carrying Case for BIO (large)

Binocular Indirect Ophthalmoscope

State-of-the-art, convenient features plus lightweight, comfortable fit and increased stability.

- > Video-aligned optical system ensures precise positioning of components for easy viewing
- > Well-padded leather headband and swooped design combined with ergonomic controls provide comfort and simple operation
- > Illumination and visual pathways can be converged for excellent visualization and true small-pupil capability
- > Adjusts to handle interpupillary distances of 48 mm to 75 mm—the widest BIO range available
- > SoftTilt park/rest feature allows optics to be moved to a stationary position out of your line of vision
- > Halogen light source is one of the brightest, longest-lasting BIO lamps
- > Vital optics and mirror assemblies are sealed against dirt and dust for long-term clear viewing and durability
- > Diffuser filter broadens the illumination beam for enhanced viewing of the peripheral retina
- > Choose portable power source or versatile wall/desk power source

12500 Binocular Indirect Ophthalmoscope

12500-D Binocular Indirect Ophthalmoscope with Diffuser Filter

12500-Y Binocular Indirect Ophthalmoscope with Yellow Filter

12500-DY Binocular Indirect Ophthalmoscope with Diffuser and Yellow Filter

Note: Power Source Sold Separately

Binocular Indirect Ophthalmoscope Accessories

74350 Wall/Desk Power Source for BIO

74360 Portable Power Source for BIO

05120-U Soft Carrying Case for BIO (large)

05122-U Soft Carrying Case for BIO (small)

12550 Teaching Mirror

12551 Voltage Adapter (4.5 V- 6 V)

12060 Scleral Depressor

73300 Extension Cord, 8 ft

01200-U BIO Halogen Lamp

72240 BIO Portable Power Supply Replacement Battery

30 Vision Screeners

EYE, EAR, NOSE AND THROAT



14000
SureSight™ Vision Screener

SureSight™ Vision Screener

Test for the primary vision disorder in children, refractive error, with this child-friendly unit that engages youngsters, puts them at ease, and requires minimal cooperation.

- > Five-second, automatic test makes patient compliance easier
- > Lights and sounds engage child's attention
- > Measures and indicates abnormal readings automatically—no provider interpretation required
- > Operates at a nonthreatening 14 inches (35 cm) distance
- > Minimal cooperation is necessary, making it equally effective for children, disabled patients and those with a language barrier
- > Screens for common vision problems, including near- and farsightedness (myopia/hyperopia), astigmatism (asymmetrical focus) and anisometropia (unequal power between eyes)

14000 SureSight Vision Screener (English)

SureSight™ Vision Screener Accessories

14042 Thermal Printer

05140-U Carrying Case

53600A Printer Paper (1 roll)

72420 Lithium Ion Battery

71040 Charging Transformer only

StrabismoScope™ Unidirectional Occluder

Makes diagnosing strabismus easier than ever. Ideal for visualizing dissociated vertical deviation.

- > Efficient testing for strabismus, both latent (heterophorias) and manifest (heterotropias)
- > Simultaneously view the movement of covered and uncovered eyes
- > Halogen light increases the ambient light on the patient's side and aids visualization by the practitioner
- > Durable—rugged ABS housing resists damage from drops
- > Fits all Welch Allyn 3.5 V power sources
- > Laminated wall chart for patient education

12400 3.5 V StrabismoScope Unidirectional Occluder



12400
StrabismoScope
Unidirectional Occluder
shown on a 3.5 V handle

StrabismoScope™ Unidirectional Occluder Accessories

03000-U 3.5 V Halogen Lamp

71000-A 3.5 V Direct Plug-in Rechargeable Handle

71000-C 3.5 V Convertible Rechargeable Handle

71900 3.5 V Lithium Ion Smart Handle with Removable AC Adapter



OAE Hearing Screener

Precisely and objectively screen for hearing loss in newborns, infants, toddlers, preschool and school-age children in just seconds.

- > Requires minimal patient cooperation
- > Fast, accurate results—about 10 seconds per ear
- > Objective testing—no patient response required
- > Clear results that don't require caregiver interpretation—Pass/Refer result provided by instrument
- > Portable design
- > 10-test memory storage in device
- > Simple printer interface for easy patient data documentation
- > Patient information can be downloaded into a PC ASCII file
- > Optional power supply: rechargeable lithium battery or AC power
- > One-year warranty, extended warranty available
- > Can be fitted with a variety of ear tip sizes

29400 Welch Allyn OAE Hearing Screener Set, including Printer



29440
OAE Hearing Screener
Carrying Case (optional)



29420
OAE Ear Tip
Sampler Pack

OAE Hearing Screener Accessories

29450 OAE Label Printer

29451 OAE Label Roll Replacement, Self-adhesive, (220/roll)

29440 OAE Carrying Case (Optional case for Screener Set only, no Printer)

29410 OAE Test Cavity (5/bag)

29411 Ear Probe Body Nozzle, OAE (5/bag)

29460EX Extended Warranty—One Year (Covers hearing screener, unit, probe, calibration once every two years, battery replacement)

29420 OAE Ear Tip Sampler Pack (Newborn, Infant, Pediatric, Adolescent)

29421 OAE Tree Ear Tips, Newborn (20/bag)

29422 OAE Tree Ear Tips, Newborn (100/bag)

29423 OAE Blue Infant Ear Tips (20/bag)

29424 OAE Blue Infant Ear Tips (100/bag)

29425 OAE Pediatric Foam Ear Tips (20/bag)

29426 OAE Pediatric Foam Ear Tips (100/bag)

29427 OAE Adolescent Foam Ear Tips (20/bag)

29428 OAE Adolescent Foam Ear Tips (100/bag)



29421
OAE Tree Ear Tip,
Newborn

29423
OAE Blue Infant
Ear Tips

29426
OAE Pediatric Foam
Ear Tips

29427
OAE Adolescent
Foam Ear Tips

32 Tympanometric Systems

EYE, EAR, NOSE AND THROAT



23623
Large MicroTym
Probe Tip (Gray)

23640
MicroTym 2 Handle only



23630
Set of four Color Coded Tips



Charging Stand

Thermal Printer
Paper

93690
MicroTym® 2 Set with
Charging Stand and
Printer

MicroTym® 2 Portable Tympanometric Instrument

One of the fastest, easiest and most complete portable tympanometric instruments.

- > Provides objective information for the diagnosis of otitis media
- > Useful for other middle ear conditions, such as patent tympanostomy tube, otosclerosis, ossicular disruption and cholesteatoma
- > Test in one second, print out results in five seconds
- > LCD preview screen ensures reliable results before printing
- > Printouts include tympanogram, numerical form, and interpretive messages
- > Laminated wall chart for patient education

93670 MicroTym 2 Set with Charging Stand

93690 MicroTym 2 Set with Charging Stand and Printer

MicroTym 2 Accessories

23640 MicroTym 2 Handle Only with two Sets of Probe Tips

23621 Small MicroTym Probe Tip (white)

23622 Medium MicroTym Probe Tip (black)

23623 Large MicroTym Probe Tip (gray)

23624 Extra Large MicroTym Probe Tip (blue)

23630 Set of MicroTym Tips (Four color-coded sizes)

23639 Multi-Pack of MicroTym Probe Tips (5 small, 10 medium, 10 large, 5 x-large)

56100 Thermal Paper (5 rolls/box, 12 boxes/case)

71170 MicroTym 2 Portable Tympanometric Instrument Printer/Charger

72900 2.4 V NiCad Rechargeable Battery for MicroTym 2

05276-U Carrying Case for MicroTym® 2

TM 262™ AutoTymp®

More data for a more complete diagnosis.

- > Conduct tympanometry and ipsilateral acoustic reflex testing, with the option to add manual audiometry
- > Unique probe design achieves ear seal easily
- > Detect and document indicators of otitis media, perforated tympanic membrane, patent tympanostomy tube, ossicular disruption, tympanosclerosis and cholesteatoma
- > Laminated wall chart for patient education

26200 TM 262 AutoTymp with IPSI Reflex Testing

26230 TM 262 AutoTymp with IPSI Reflex Testing and Audiometer

TM 262™ AutoTymp® Accessories

05260-U Carrying Case	26008 Eartips, 8 mm (box of 25)
23220 Response Hand Switch	26011 Eartips, 11 mm (box of 25)
23222 Earphone Sound Enclosures	26013 Eartips, 13 mm (box of 25)
23223 Replacement Headset (THD 39; calibration with unit required)	26015 Eartips, 15 mm (box of 25)
26100 Eartips for TM 262 (6 sizes, 2 each)	26017 Eartips, 17 mm (box of 25)
26240 Dust Cover	26019 Eartips, 19 mm (box of 25)
26241 Test Cavity	52600 Printer Paper



34 Audiometers

EYE, EAR, NOSE AND THROAT



23200
AM 232 Manual
Audiometer with
AC power



23222
Earphone Sound Enclosures

AM 232™ Manual Audiometer

Threshold audiometry to quantify hearing loss.

- > Quantifies specific dB and frequency of hearing loss with precision testing
- > Offers a full range of frequencies and intensity levels
- > Frequency-modulated stimulus mode for reliable results with children and elderly patients

23200 AM 232 Manual Audiometer with AC Power

23210 AM 232 Manual Audiometer with AC and Rechargeable Battery

AM 232 Manual Audiometer Accessories

23220 Response Hand Switch

23221 Patch Cord

23222 Earphone Sound Enclosures

23223 Replacement Headset—THD 39
(calibration with unit required)

52300 Audiogram form (1 pad of 50, 10
pads/case)

72320 Rechargeable Battery Pack only

72329 Complete Battery Pack Assembly with
Rechargeable Batteries



23210
AM 232™ Manual
Audiometer with
AC Power and
Rechargeable Battery



92680
AudioScope 3 Complete



23300
AudioScope 3 handle only shown with
Replacement NiCad Rechargeable Battery 72300

AudioScope® 3 Screening Audiometer

View the tympanic membrane and ear canal while screening for hearing loss, quickly and accurately.

- > Halogen light and fiber optics enable brilliant view of tympanic membrane and ear canal before and during screening
- > Choice of three screening levels—20 dB HL, 25 dB HL and 40 dB HL—at 500, 1000, 2000 and 4000 Hz for all ages
- > Built-in 1000 Hz pretone lets patients “practice” listening first

92600 AudioScope 3 Set (AudioScope 3, set of AudioSpec® Specula, 110-130 V Charging Transformer and Recording Forms)

92680 AudioScope 3, Complete (AudioScope 3, set of AudioSpec Specula, 110-130 V Charging Transformer, Charging Stand and Recording Forms)

23300 AudioScope 3 with AudioSpec Specula (handle only)

AudioScope® 3 Screening Audiometer Accessories

71123 3.5 V AudioScope 3 Charging Stand only

71040 Charging Transformer only

05232-U Soft Carrying Case for AudioScope 3

23303 Small AudioSpec Speculum for AudioScope 3

23305 Medium AudioSpec Speculum for AudioScope 3

23307 Large AudioSpec Speculum for AudioScope 3

23400 Set of Three AudioSpec Specula for AudioScope (Small, Medium, Large)

72300 Replacement NiCad Rechargeable Battery (orange) for 71000-A/71000-C

55230 AudioScope 3 Recording Forms (100/pkg, 10 pkg/box)

Note: Reference number on product is not order number.

06200-U 3.5 V Halogen Lamp



23400
Set of Three AudioSpec® Specula



20500H
Portable Binocular
Microscope

LumiView™ Portable Binocular Microscope

Unique 3-D optics for viewing into small cavities.

- > Adapts optical properties of binocular microscope to converge user's vision into a magnified, stereoscopic three-dimensional view
- > Directs cool halogen light to the spot for clear 3-D image and accurate depth perception
- > Simple to use, easy to carry and very affordable

- 20500H** LumiView Portable Binocular Microscope, Head Mount with Portable Battery Pack
- 20510H** LumiView Portable Binocular Microscope, Head Mount with Direct Power Source
- 20520H** LumiView Portable Binocular Microscope, Headband Flat-Surface Magnifier with Portable Battery Pack
- 20530H** LumiView Portable Binocular Microscope, Head Mount Only
- 20530S** LumiView Portable Binocular Microscope, Spectacle Mount Only
- 20520S** LumiView Portable Binocular Microscope, Spectacle Flat-Surface Magnifier with Portable Battery Pack
- 20510S** LumiView Portable Binocular Microscope, Spectacle Mount with Direct Power Source



75260
Portable Power Source (**75210**)
With Charger (**74180**)

LumiView Portable Binocular Microscope Accessories

- 08500-U** LumiView Replacement Lamp
- 72250** Rechargeable Battery
- 05374-U** Carrying Case for Spectacle LumiView
- 75260** Portable Power Source with Charger
- 75210** Direct Power Supply
- 21502** Spectacle Holder
- 74180** Charger only for Portable Power Source
- 75200** Portable Power Source only



72250
Rechargeable Battery

Ear Wash System

Turn cerumen removal into a clean, quick, safe procedure with the first system to simultaneously irrigate and suction discharge using revolutionary Hydrovac Action.

- > Eliminates messy outflow by automatically dislodging, removing and disposing of cerumen
- > Transparent tip seals tightly and directs outflow back to sink and away from you and your patient
- > The device automatically controls suction, water temperature and pressure
- > Safe—reduces typical side effects like vertigo, nausea and tympanic membrane damage

29350 Ear Wash System

Ear Wash System Accessories

29360 Eartips for Ear Wash System (case of 4 boxes or 100 eartips)

29373 Domestic Aerator Adapter Kit

29330 Hose Assembly (10 ft)



29350
Ear Wash System

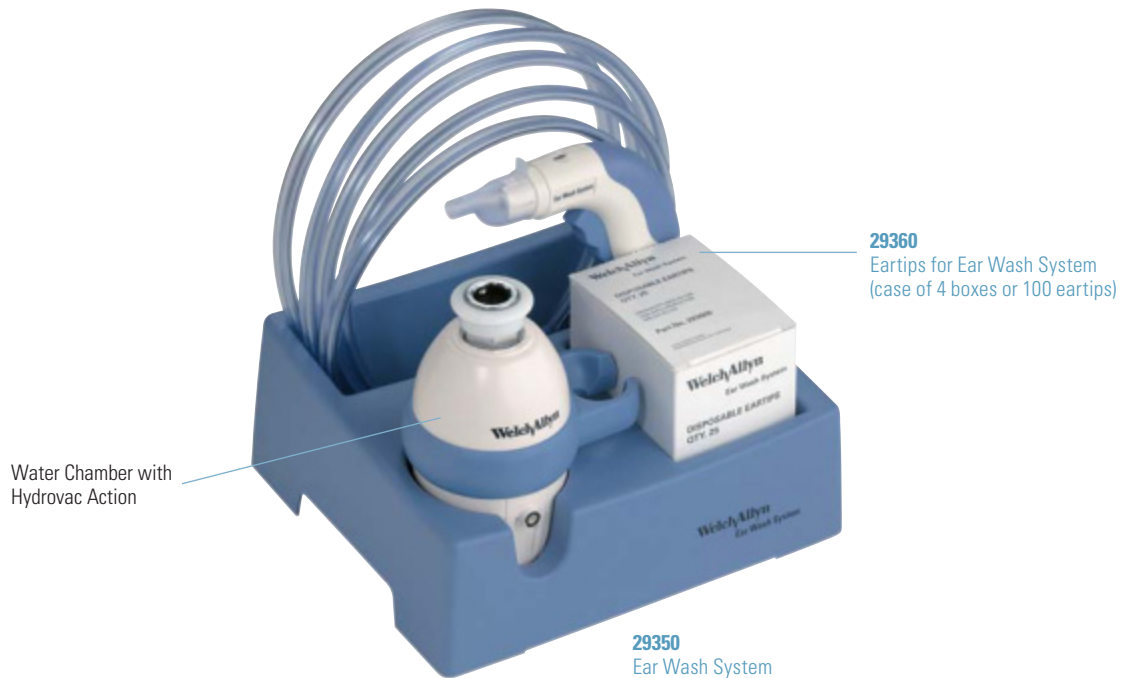

Water Chamber with Hydrovac Action

29360
Eartips for Ear Wash System
(case of 4 boxes or 100 eartips)

29350
Ear Wash System

38 Illuminators

EYE, EAR, NOSE AND THROAT



41100
3.5 V Finnoff Transilluminator

3.5 V Halogen Fiber Optic Transilluminators

General fiber optic examination light for checking pupil reflex. May reduce patient discomfort in transillumination of frontal and maxillary sinuses.

- > Halogen HPX™ lamp provides 30% more light output than standard halogen lamps for true tissue color and consistent, long-lasting illumination
- > Fiber-optic light transmission for cool distal light
- > Fully sterilizable with steam, water, gas or solutions
- > Optional cobalt blue filter

41100 3.5 V Finnoff Transilluminator

41101 3.5 V Finnoff Transilluminator with Cobalt Blue Filter

43300 3.5 V Curved All-Purpose Transilluminator

3.5 V Halogen Fiber Optic Transilluminators Accessories

03100-U 3.5 V Halogen Lamp

41102 Cobalt Blue Filter only



26038
3.5 V Bivalve
Nasal Speculum

3.5 V Bivalve Nasal Speculum

Halogen HPX illumination, fiber optics, and adjustable speculum facilitate removal of foreign bodies.

- > Halogen HPX™ lamp provides 30% brighter, whiter light output than standard halogen lamps for true tissue color and consistent, long-lasting illumination
- > Fiber-optic light transmission produces cool distal light
- > Adjustable speculum facilitates removal of foreign bodies
- > Autoclavable for complete sterilization

26038 3.5 V Bivalve Nasal Speculum complete with Illuminator

26035 3.5 V Bivalve Nasal Speculum Section only

3.5 V Bivalve Nasal Speculum Accessories

03100-U 3.5 V Halogen Lamp

26330 Magnifying Lens

23557 3.5 V Throat Illuminator Section only
(thread on) for 20000

23857 3.5 V Throat Illuminator Section only
for 23820, 26035 and 26535

3.5 V Larynx/Nasopharynx Illuminators

Halogen HPX™ illumination and fiber-optic light transmission for improved exams.

- > Halogen HPX™ lamp provides 30% more light output than standard halogen lamps for true tissue color and consistent, long-lasting illumination
- > Fiber-optic light transmission produces cool distal light
- > Wide-angle rotatable mirror with pilot aperture
- > Fully sterilizable with steam, water, gas or solutions

27000 3.5 V Complete Larynx Illuminator

27050 3.5 V Complete Nasopharynx Illuminator



27000
3.5 V Complete Larynx
Illuminator

3.5 V Larynx/Nasopharynx Illuminators Accessories

03100-U 3.5 V Halogen Lamp

27010 3.5 V Larynx Mirror Section only

27070 3.5 V Fiber Optic Illuminator only

3.5 V Nasal Illuminators

Halogen HPX illumination and reusable tip for easy nasal examinations.

- > Halogen HPX™ lamp provides 30% more light output than standard halogen lamps for true tissue color and consistent, long-lasting illumination
- > Fiber optics project cool distal light
- > Simply detach the head to use as a throat illuminator/penlight

26538 3.5 V Complete Nasal Illuminator

26535 3.5 V Nasal Illuminator section only



26535
3.5 V Nasal Illuminator

3.5 V Nasal Illuminators Accessories

03100-U 3.5 V Halogen Lamp

22009 9 mm Speculum

9 mm

40 Rhinologyngoscopes

EYE, EAR, NOSE AND THROAT



RL-150™ Rhinologyngoscope

Get a fast, comprehensive view of upper-respiratory anatomy with this powerful, portable system.

- > 20% more fibers in the fiber optic bundle for brighter, larger, high-resolution images
- > Thin insertion tube for minimal patient discomfort and access to virtually all anatomical areas
- > Highly portable at only 2.2 lbs
- > Optional disinfection tray makes reprocessing more convenient

- 65050** RL-150 Rhinologyngoscope only
- 65053** RL-150 Rhinologyngoscope and Solarc® Light Source
- 49500** MFI Solarc® Light Source only

RL-150 Rhinologyngoscope Accessories

- | | |
|---------------------------------------|------------------------------------|
| 65002 RL-150 Disinfection Tray | 65010 Olympus ILK-3 Adapter |
| 65003 RL-150 Instrument Hanger | 65011 Machinda Adapter |
| 65013 RL-150 Carrying Case | 65014 Pentax Adapter |
| 86545 PENTAX Leak Tester | 65016 Wolf Adapter |
| 65005 Olympus CLK-4 Adapter | 65017 ACMI Adapter |
| 65006 LX-150 Adapter | 65018 Storz Adapter |

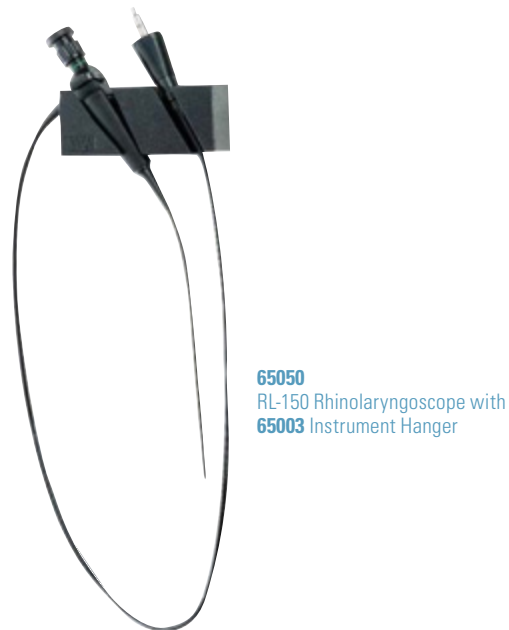

RL-150™ Rhinolaryngoscope Accessories



	65010 Olympus ILK-3 Adapter
	65011 Machinda Adapter
	65014 Pentax Adapter
	65016 Wolf Adapter
	65017 ACMI Adapter
	65018 Storz Adapter

42 Laryngoscopes

EYE, EAR, NOSE AND THROAT

Fiber Optic Laryngoscope Blades

Removable, repolishable light pipes make these an affordable choice in fiber optic laryngoscope blades.

- > Single-piece stainless steel construction ensures blade integrity
- > Damaged light pathways can be repaired at a fraction of the cost of replacement blades
- > Free repolishing service ensures long life



MacIntosh Fiber Optic Blades

MacIntosh Fiber Optic Blades			
Part Number	Blade Size	Overall Length	Inside Length (Base to Tip)
69061	1	89 mm	63 mm
69062	2	108 mm	82 mm
69063	3	126 mm	101 mm
69064	4	160 mm	135 mm



English MacIntosh Fiber Optic Blades

English MacIntosh Fiber Optic Blades*			
Part Number	Blade Size	Overall Length	Inside (Base to Tip)
69211	1	95 mm	70 mm
69212	2	116 mm	90 mm
69213	3	135 mm	110 mm
69214	4	156 mm	130 mm

*Dimensions are approximate.



Miller Halogen Fiber Optic Blades

Miller Halogen Fiber Optic Blades*			
Part Number	Blade Size	Inside Vertical	Inside (Base to Tip)
68065	00	8 mm	36 mm
68060	0	8 mm	53 mm
68061	1	8 mm	79 mm
68062	2	10 mm	132 mm
68063	3	11 mm	172 mm
68064	4	13 mm	182 mm

*Dimensions are approximate.

Fiber Optic Laryngoscope Handles

Bright, white HPX illumination offers a clear, color-corrected view.

- > Patented HPX™ technology blends halogen and xenon gases under pressure to produce a bright, white light for true tissue color and consistent, long-lasting illumination
- > Up to 40% lighter than our previous design, for increased responsiveness and maneuverability
- > Knurled finish ensures secure grip
- > Single HPX lamp cartridge design used across all sizes of 2.5 V handles



60813
2.5 V Medium



60814
2.5 V Penlight



60815
2.5 V Stubby

Lightweight Fiber Optic HPX Handles	
Part Number	Description
60813	2.5 V Medium, uses two C-size batteries
60814	2.5 V Penlight, uses two AA-size batteries
60815	2.5 V Stubby, uses two AA-size batteries
608125-501	2.5 V Halogen HPX Gold Lamp Cartridge Assembly
608107	Switch Plunger/Lamp Shield
06000-U	2.5 V Halogen HPX Replacement Lamp



60713
2.5 V Handle only

2.5 V Rechargeable Fiber Optic HPX Handle	
Part Number	Description
60713	2.5 V Handle only
71140	Charger only, 110-130 V, 50/60 Hz
72000	2.5 V NiCad Rechargeable Battery
608125-501	2.5 V Halogen HPX Gold Lamp Cartridge Assembly
608107	Switch Plunger/Lamp Shield
06000-U	2.5 V Halogen HPX Replacement Lamp



60835
3.5 V Handle only

3.5 V Rechargeable Fiber Optic HPX Handle	
Part Number	Description
60835	3.5 V Handle only
71140	Charger only, 110-130 V, 50/60 Hz
72200	3.5 V NiCad Rechargeable Battery
608351-501	3.5 V Halogen HPX Gold Lamp Cartridge Assembly
608107	Switch Plunger/Lamp Shield
00300-U	3.5 V Halogen HPX Replacement Lamp

44 Laryngoscopes

EYE, EAR, NOSE AND THROAT

Fiber Optic Laryngoscope Sets

A unique design that's stronger, safer, upgradeable and lower cost over the life of the instrument.

- > Single-piece stainless steel construction ensures blade integrity
- > Removable light pipe and smooth surface design
- > Free fiber optic repolishing service ensures long life
- > Blades are upgradeable and repairable at a fraction of the cost of replacement blades



68696
Miller
#0, 1, 2, 3, 4

Fiber Optic Sets with Case

Part Number	Blades	Handles	Case
69696	MacIntosh #1, 2, 3, 4	Medium and Penlight	05691-U
69697	English MacIntosh #1, 2, 3, 4	Medium and Penlight	05791-U
68696	Miller #0, 1, 2, 3, 4	Medium and Penlight	05681-U



65122
Miller #0 and 2, MacIntosh #3 and 4, with
Medium (68013) and Stubby (60815) Battery
Handles and case (05700)

Popular Mixed Blade Style Fiber Optic Sets with Case

Part Number	Blades	Handles	Case
65121	Miller #0 and 2 and MacIntosh #3 and 4	Medium (60813) and Penlight (60814)	05700
65122	Miller #0 and 2, MacIntosh #3 and 4	Medium (60813) and Stubby (60815)	05700
65123	Miller #0 and 2, MacIntosh #3 and 4	Stubby (60815) and Penlight (60814)	05700
65124	Miller #0 and 2, E-MacIntosh #3 and 4	Medium (60813) and Penlight (60814)	05701
65125	Miller #0 and 2, E-MacIntosh #3 and 4	Medium (60813) and Stubby (60815)	05701
65126	Miller #0 and 2, E-MacIntosh #3 and 4	Stubby (60815) and Penlight (60814)	05701



65103
MacIntosh #3, MacIntosh #4 and Medium Handle

Portable Fiber Optic Sets

Sets include a choice of two blades options, two handle options and a soft vinyl case. The blade options are for small to medium and medium to large size patients.

Part Number	Blades	Handle
65101	MacIntosh #3, Miller #0, Miller #2	Medium (60813)
65102	MacIntosh #3, Miller #0, Miller #2	Penlight (60814)
65103	MacIntosh #3, MacIntosh #4	Medium (60813)
65104	MacIntosh #3, MacIntosh #4	Penlight (60814)

05620-U Portable Case Only, Soft Vinyl Zippered

Standard (Lamp) Laryngoscope Blades

Reduced blade weight improves balance and maneuverability for even the toughest intubations.

- > Single-piece stainless steel construction ensures blade integrity
- > Removable light pipe and smooth surface design
- > Blades can be economically upgraded from lamp to fiber-optic illumination
- > Repairable at a fraction of the cost of a replacement blade

MacIntosh Standard (Lamp) Blades

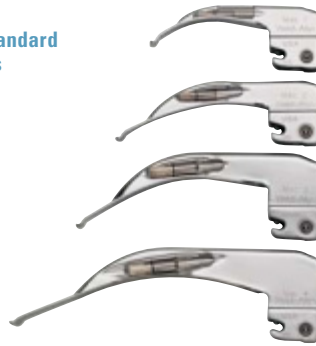

MacIntosh Standard (Lamp) Blades

Part Number	Blade Size	Overall Length	Inside (Base to Tip)	Replacement Lamp
69041	#1	89 mm	63 mm	04700-U
69042	#2	108 mm	82 mm	04700-U
69043	#3	126 mm	101 mm	04800-U
69044	#4	160 mm	135 mm	04800-U

English MacIntosh Standard (Lamp) Blades



English MacIntosh Standard (Lamp) Blades

Part Number	Blade Size	Overall Length	Inside (Base to Tip)	Replacement Lamp
69241	# 1	95 mm	70 mm	04700-U
69242	# 2	116 mm	90 mm	04700-U
69243	# 3	135 mm	110 mm	04800-U
69244	# 4	156 mm	130 mm	04800-U

Miller Standard (Lamp) Blades



Miller Standard (Lamp) Blades

Part Number	Blade Size	Inside Vertical	Inside (Base to Tip)	Replacement Lamp
68045	#00	8 mm	36 mm	04700-U
68040	#0	8 mm	53 mm	04700-U
68041	#1	8 mm	79 mm	04700-U
68042	#2	10 mm	132 mm	04800-U
68043	#3	11 mm	172 mm	04800-U
68044	#4	13 mm	182 mm	04800-U

46 Laryngoscopes

EYE, EAR, NOSE AND THROAT

Standard Laryngoscope Handles

Built to last. Comfortable grip and finish enhance laryngoscope use.

- > Universal design accepts any ASTM-standard blade
- > Crafted from durable chrome-plated brass with knurled finish for sure grip



Standard Handles

Part Number	Description
60200	Large (uses two "D" batteries)
60300	Medium (uses two "C" batteries)
60400	Penlight (uses two "AA" batteries)
60305	Stubby (uses two "AA" batteries)



Rechargeable Standard Handles

Part Number	Description
60715	Rechargeable Handle and Transformer 110-130 V, 50/60 Hz
60710	Handle only, 2.5 V
71040	Transformer only, 110-130 V, 50/60 Hz
72000	NiCad Rechargeable Battery

60715
Rechargeable Handle
and Transformer

Standard Laryngoscope Sets

A unique design that's stronger, safer, upgradeable and lower cost over the life of the instrument.

- > Single-piece stainless steel construction ensures blade integrity
- > Removable light pipe and smooth surface design
- > Blades are upgradeable to fiber optic and repairable at a fraction of the cost of replacement blades
- > Free blade repolishing service ensures long life



69096
MacIntosh Laryngoscope Set #1, 2, 3 and 4 with Medium (60813) and Penlight (60814) Handles with Case

Specific Blade Style Standard Sets (Lamp)			
Part Number	Blades	Handles	Case
69096	MacIntosh Laryngoscope Set #1, 2, 3 and 4	Medium and Penlight	05691-U
69097	English MacIntosh Laryngoscope Set #1, 2, 3 and 4	Medium and Penlight	05791-U
68096	Miller Laryngoscope Set #0, 1, 2, 3 and 4	Medium and Penlight	05681-U

Mixed-Blade Standard Laryngoscope Sets

Popular Mixed-Blade Style Standard Sets (Lamp)		
Part Number	Blades	Handles
65221	Miller Set #0 and 2, Universal MacIntosh #3 and 4	Medium and Penlight
65222	Miller Set #0 and 2, Universal MacIntosh #3 and 4	Medium and Stubby
65223	Miller Set #0 and 2, Universal MacIntosh #3 and 4	Stubby and Penlight
65224	Universal Miller #0 and 2, English MacIntosh Set #3 and 4	Medium and Penlight
65225	Universal Miller #0 and 2, English MacIntosh Set #3 and 4	Medium and Stubby
65226	Universal Miller #0 and 2, English MacIntosh Set #3 and 4	Stubby and Penlight

Sets include four blades, two handles and a case. Two blades are Miller blades sizes #0 and 2. The other two blades are sizes #3 and 4 in either MacIntosh or English MacIntosh style. The models also vary by handle configuration.

Portable Standard Laryngoscope Sets

Portable Standard Sets		
Part Number	Blades	Handles
65201	MacIntosh #3, Miller #0, Miller #2	Medium
65202	MacIntosh #3, Miller #0, Miller #2	Penlight
65203	MacIntosh #3, MacIntosh #4	Medium
65204	MacIntosh #3, MacIntosh #4	Penlight

Sets include choice of two blade options, two handle options and a soft vinyl case. The blade options are for small to medium and medium to large size patients.



65202
MacIntosh #3, Miller #0 and Miller #2 and Penlight Handle (60814) with Case

48 Laryngoscopes

EYE, EAR, NOSE AND THROAT



60500
Reusable
Illuminator

69090
Expendable Laryngoscope Kit

Expendable Laryngoscopes

Designed to mimic the MacIntosh blade, expendable laryngoscopes are available in two sizes.

> Ideal for emergency rooms, ambulances, emergency bags, field hospitals and doctors' offices—wherever a low-cost, dependable laryngoscope is needed

> Individually wrapped for safety and convenience

69090 Complete Kit (Includes: large and small blades, illuminator, batteries and case)

56901 Expendable Laryngoscopes, Small, box of 10 (77.5 mm length x 18.2 mm width)

56903 Expendable Laryngoscopes, Large, box of 10 (123 mm length x 25.7 mm width)

60500 Reusable Illuminator (uses two "AA" batteries)

03600-U Lamp