

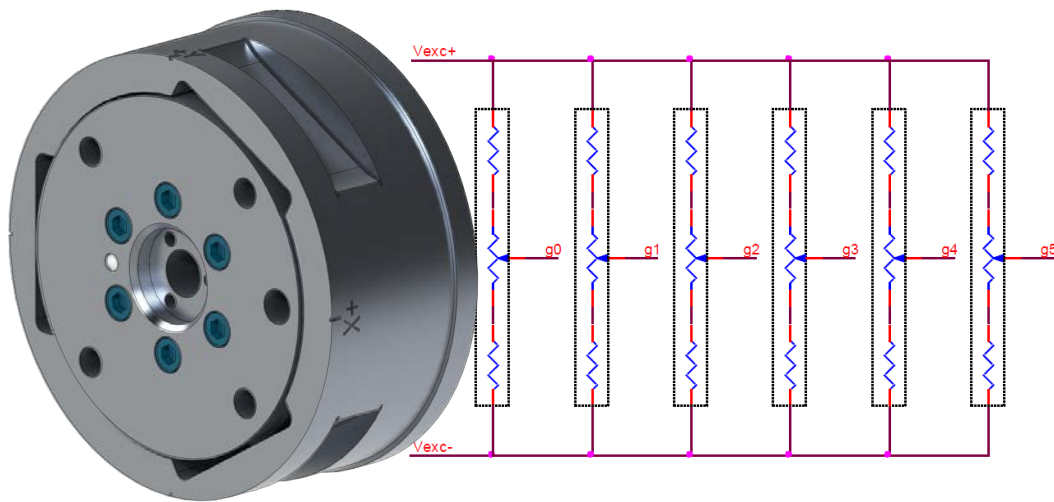

F/T Transducer Without Electronics (TWE)

Manual



Document #: 9620-05-TWE

Foreword

Information contained in this document is the property of ATI Industrial Automation, Inc. (ATI) and shall not be reproduced in whole or in part without prior written approval of ATI Industrial Automation, Inc. The information herein is subject to change without notice and should not be construed as a commitment on ATI Industrial Automation, Inc. This manual is periodically revised to reflect and incorporate changes made to the F/T system.

ATI Industrial Automation, Inc. assumes no responsibility for any errors or omissions in this document.

Copyright © (2020) by ATI Industrial Automation, Inc., Apex, North Carolina USA. All Rights Reserved.
Published in the USA.

In consideration that ATI Industrial Automation, Inc. (ATI) products are intended for use with robotic and/or automated machines, ATI does not recommend the use of its products for applications wherein failure or malfunction of an ATI component or system threatens life or makes injury probable. Anyone who uses or incorporates ATI components within any potentially life threatening system must obtain ATI's prior consent based upon assurance to ATI that a malfunction of ATI's component does not pose direct or indirect threat of injury or death, and (even if such consent is given) shall indemnify ATI from any claim, loss, liability, and related expenses arising from any injury or death resulting from use of ATI components.

All trademarks belong to their respective owners.

Windows is registered trademarks of Microsoft Corporation.

Electromagnetic Compatibility

This device complies with Part 15 of the FCC Rules, Class A. Operation is subject to the following two conditions: (1) this device may not cause harmful interference, and (2) this device must accept any interference received, including interference that may cause undesired operation.

This device complies with EMC Directive 2004/108/EC and conforms to the following standards:
EN55022:1998+A1:2000 +A2:2003, EN61000-4-2:1995 +A1:1998+A2:2001, EN61000-4-3:2002, EN61000-4-4:2004, EN61000-4-5:1995 +A1:1996, EN61000-4-6:1996 +A1:2001, EN61000-4-8:1995, EN61000-4-11:2001.

Note:

Please read the manual before calling customer service. Before calling, have the following information available:

1. Serial number (e.g., FT01234)
2. Transducer model (e.g., Nano17, Gamma, Theta, etc.)
3. Calibration (e.g., US-15-50, SI-65-6, etc.)
4. Accurate and complete description of the question or problem
5. Computer and software information. Operating system, computer type, drivers, application software, and other relevant information about your configuration.

If possible, be near the F/T system when calling.

Please contact an ATI representative for assistance, if needed:

Sale, Service and Information about ATI products:

ATI Industrial Automation

1031 Goodworth Drive
Apex, NC 27539 USA

www.ati-ia.com

Tel: +1.919.772.0115

Fax: +1.919.772.8259

Application Engineering

Tel: +1.919.772.0115, Extension 511

Fax: +1.919.772.8259

E-mail: ft_support@ati-ia.com

Table of Contents

1. Safety	7
1.1 Explanation of Notifications	7
1.2 General Safety Guidelines	8
1.3 Safety Precautions	8
2. System Overview	9
2.1 System with Transducer, Customer Electronics, and DAQ Device	9
2.2 Interface Plates	10
2.3 Transducer	10
2.4 Transducer Cable	10
2.5 TWE Calibration Spreadsheet Overview	11
3. Electrical Setup	12
3.1 Excitation Voltage Supply and Six Amplifiers	13
3.1.1 Excitation Voltage Supply.....	13
3.1.2 Six Amplifiers.....	14
3.1.3 DAQ System.....	15
3.1.4 Computer.....	15
3.1.5 Connections (cables and connectors).....	15
3.2 TWE Calibration Spreadsheet (FTxxxxx TWE.xlsx)	15
3.2.1 Worksheet 1. Overview	16
3.2.2 Worksheet 2. Electrical Setup	17
3.2.3 Worksheet 3. System Characterization	18
3.2.4 Worksheet 4. Sample Calculations	20
3.2.5 Worksheet Gain Worksheet	21
3.3 How to Use the TWE Calibration Spreadsheet	22
4. Periodic Maintenance	23
4.1 Inspection of Cables	23
4.2 Calibration	23
5. Troubleshooting	24
6. Appendix	25
6.1 Appendix A—Transducer Cable Connectors and Signals	25
6.1.1 Transducer Mating Connectors.....	25
6.1.2 Pin Connections on the Cable Connectors.....	25
6.1.2.1 Nano/Mini Integral Cable Connectors.....	25
6.1.2.2 9105-C-x-A Cable Connectors.....	26

6.2	Appendix B—Amplification and Excitation	27
6.2.1	Examples.....	27
6.3	Appendix C—Mechanical and Electrical Overview of the Transducer	29
6.3.1	Mechanical Description	29
6.3.2	Electrical Description.....	30
6.4	Appendix D—Resolution	31
6.5	Appendix E—Detecting Sensitivity Changes	31
6.6	Appendix F—Buffer Circuit	31
7.	Terms and Conditions of Sale.....	32

Glossary of Terms

Term	Definition
Accuracy	See Measurement Uncertainty.
Bit/Byte	A unit of computer data.
Calibration	The act of measuring a transducer's raw response to loads and creating data used in converting the response to forces and torques.
Calibration Certificate	A statement that certifies the equipment measures correctly. These statements mean the equipment has been tested against national standards. The statements are produced as a result of calibration or re-calibration.
Compound Loading	Any load that is not purely in one axis.
Force	The push or pull exerted on an object.
F/T	Force/Torque.
F/T Transducer	The device that converts force and torque into an electrical signal.
Fxy	The resultant force vector comprised of components Fx and Fy.
Hysteresis	A source of measurement error caused by the residual effects of previously applied loads.
IP	Ingress Protection is a rating code per <i>IEC</i> standard. The rating classifies the extent to which a device is protected from outside extremities.
MAP	Mounting Adapter Plate. The MAP part of the transducer is attached to the fixed surface or robot arm.
Maximum Single-Axis Overload	The largest amount of load in a single axis (all other axes are unloaded) that the transducer can withstand without damage.
Measurement Uncertainty	The maximum expected error in measurements, as specified on the calibration certificate.
Overload	The condition where more load is applied to the transducer than the transducer can measure. Overload results in saturation.
Quantization	The way the continuously variable transducer signal is converted into discrete digital values. Usually used when describing the change from one digital value to the next.
Resolution	The smallest change in load that can be measured. This is usually much smaller than accuracy.
Saturation	The condition where the transducer has a load or signal outside its sensing range.
Sensor	The complete system that includes a transducer, cabling, and external electronics.
SG	Strain Gage
TAP	Tool Adapter Plate. The TAP part of the transducer attaches to the load that is to be measured.
TWE	Transducer Without Electronics. An F/T transducer for advanced users who need to bypass standard ATI Industrial Automation electronics.
TWL	A TWE F/T transducer with environmental connector. See TWE.
Torque	The measurement of a rotational force exerted on an object.
Transducer	The electro-mechanical component that is placed in-line with the load to be measured.
Txy	The resultant torque vector comprised of components Tx and Ty.

1. Safety

The safety section describes general safety guidelines to be followed with this product, explanations of the notifications found in this manual, and safety precautions that apply to the product. More specific notifications are imbedded within the sections of the manual where they apply.

1.1 Explanation of Notifications

The following notifications are specific to the product(s) covered by this manual. It is expected that the user heed all notifications from the robot manufacturer and/or the manufacturers of other components used in the installation.



DANGER: Notification of information or instructions that if not followed will result in death or serious injury. The notification provides information about the nature of the hazardous situation, the consequences of not avoiding the hazard, and the method for avoiding the situation.



WARNING: Notification of information or instructions that if not followed could result in death or serious injury. The notification provides information about the nature of the hazardous situation, the consequences of not avoiding the hazard, and the method for avoiding the situation.









CAUTION: Notification of information or instructions that if not followed could result in moderate injury or will cause damage to equipment. The notification provides information about the nature of the hazardous situation, the consequences of not avoiding the hazard, and the method for avoiding the situation.

NOTICE: Notification of specific information or instructions about maintaining, operating, installing, or setting up the product that if not followed could result in damage to equipment. The notification can emphasize, but is not limited to: best operating practices and maintenance tips.

1.2 General Safety Guidelines

The customer should verify that the transducer selected is rated for maximum loads and torques expected during operation. Because static forces are less than the dynamic forces from the acceleration or deceleration of the robot, be aware of the dynamic loads caused by the robot.

1.3 Safety Precautions

- | | |
|---|--|
|  | WARNING: Performing maintenance or repair on the sensor, while circuits such as power are energized, could result in serious injury. Discharge and verify all energized circuits are de-energized in accordance with the customer's safety practices and policies. |
|  | CAUTION: Modifying or disassembly of the sensor could cause damage and void the warranty. Use the supplied mounting adapter plate (MAP) and the provided tool side mounting bolt pattern to mount the sensor to the robot and customer tooling to the sensor. For more information, refer to Section 7—Terms and Conditions of Sale . |
|  | CAUTION: Using fasteners that exceed the customer interface depth penetrates the body of the sensor, damages the electronics, and voids the warranty. For more information, refer to Section 7—Terms and Conditions of Sale for more information. |
|  | CAUTION: Do not remove any fasteners or disassemble transducers, without a removable mounting adapter plate. Doing so can cause irreparable damage to the transducer and void the warranty. Leave all fasteners in place and the transducer in its assembled state. This applies to Nano, IP-rate, and some Omega transducers. |
|  | CAUTION: Probing openings in the transducer causes damage to the instrumentation. Avoid prying into openings of the transducer. |
|  | CAUTION: Do not exert excessive force on the transducer. The transducer is a sensitive instrument and can be damaged by applying a force that exceeds any of the single-axis overload values of the transducer, causing irreparable damage. Small Nano and Mini transducers can easily be overloaded during installation. For specific transducer overload values, refer to the F/T transducer manual, 9620-05-Transducer Section . |

2. System Overview

The Transducer Without Electronics (TWE) Force/Torque (F/T) is a multi-axis force and torque detection system that simultaneously measures forces (F_x , F_y , and F_z) and torques (T_x , T_y , and T_z). TWE systems require the user to amplify and digitize the transducer signals. The user converts the digitized signals into force and torque values through a factory supplied calibration matrix.

This manual uses the term TWE to refer to both TWE and TWL F/T transducers.

2.1 System with Transducer, Customer Electronics, and DAQ Device

Figure 2.1—A TWE System

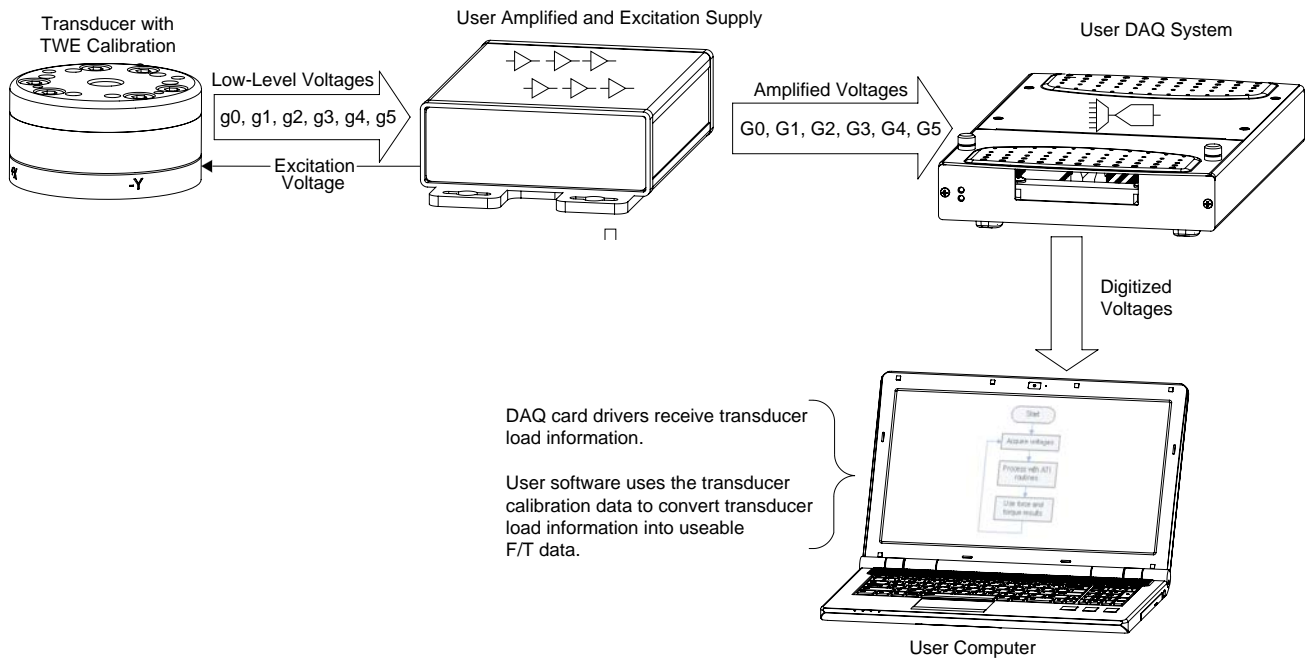

A TWE system usually consists of the following:

- TW, TWE, or TWL transducer with TWE calibration
- transducer cable
- interface plates for larger transducers (optional)
- spreadsheet with calibration information (sent to the user from ATI via e-mail, refer to [Section 2.5—TWE Calibration Spreadsheet Overview](#))
- excitation voltage and six amplifiers with adjustable gain (user-supplied)
- data acquisition (DAQ) system for converting analog data into numerical values (user-supplied)
- computer and software (user-supplied)
- cables and connectors to connect the components (user-supplied)

To convert raw voltages into F/T values a user can perform the necessary mathematical operations either with the supplied spreadsheet or a (user-supplied) custom software application.



CAUTION: The F/T sensor and the calibration matrix provided with it have been assigned matching serial numbers when the transducer was calibrated. If these serial numbers assigned to the F/T system do not match, the F/T output data will be incorrect.

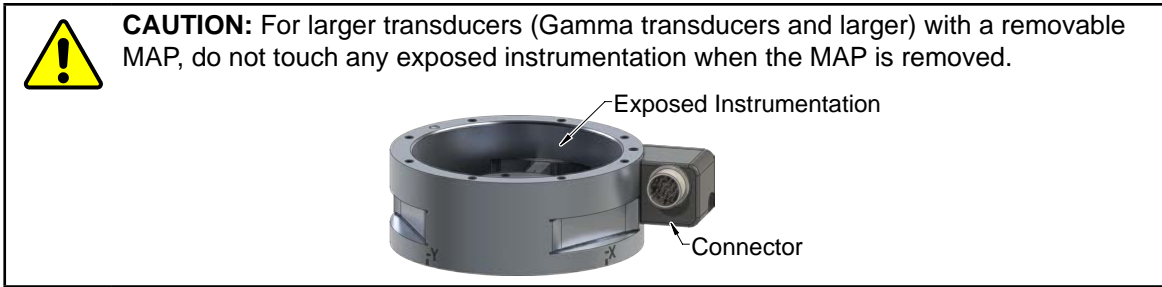

2.2 Interface Plates

Larger transducers come with a standard mounting interface plate to mechanically attach the transducer to the apparatus that applies the force. Gamma, Delta, Theta, and Omega 160 transducers also have a standard tool interface plate with an ISO 9409-1 interface for attaching to the customer tool.

The plate consists of a plate and mounting fasteners. For more information, refer to the installation section and drawings in the F/T transducer manual, [9620-05-Transducer Section](#).

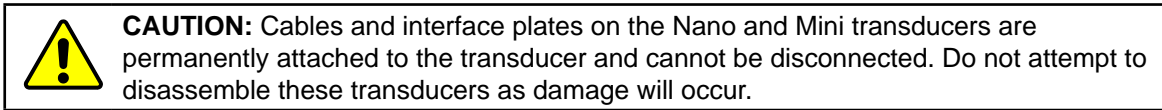

2.3 Transducer

The ATI TWE transducer is a compact, monolithic structure that converts force and torque into analog strain gage signals. [Figure 2.2](#) shows the transducer with a standard tool adapter.

For more information, refer to the installation section and drawings in the F/T transducer manual, [9620-05-Transducer Section](#).

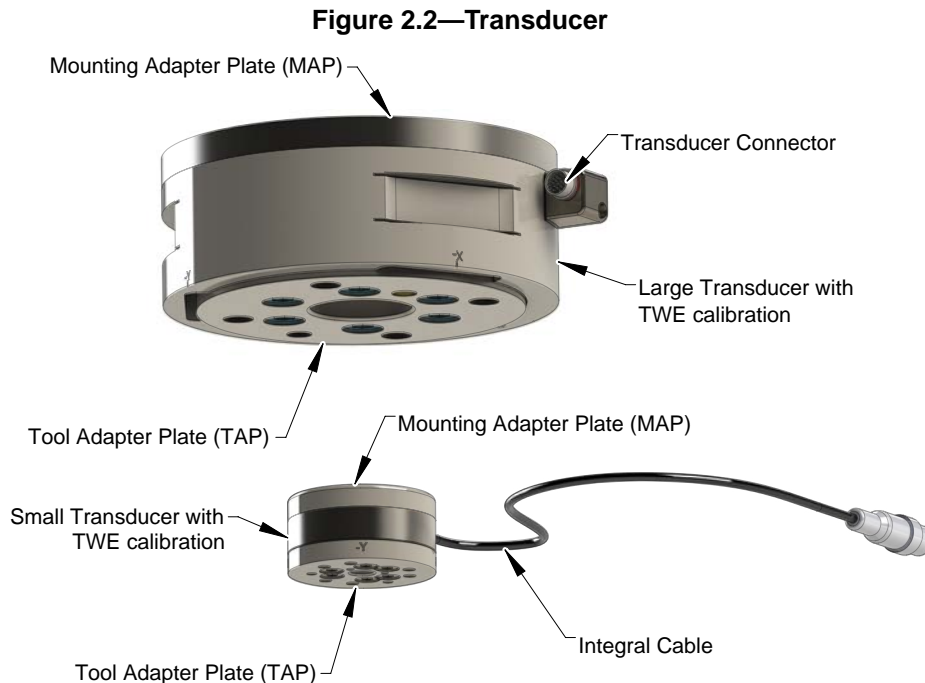

2.4 Transducer Cable

The high-flex transducer cable is electrically shielded to protect transmission of transducer data. The cables used in the Nano and Mini models are integrated into the unit. Other models use detachable cables. For information regarding the transducer's electrical connections, refer to [Appendix A—Transducer Cable Connectors and Signals](#).

2.5 TWE Calibration Spreadsheet Overview

Upon shipment of the TWE, ATI sends to the user via e-mail a spreadsheet with calibration information. This information is needed for the user's system or computer to convert the transducer readings into a usable F/T output.

To maximize accuracy, each transducer, sent to a user, is individually calibrated. Included with the transducer is a Microsoft® Excel® document named: FTxxxxx TWE.xlsx, where FTxxxxx is the transducer's serial number. The calibration information specific to the transducer is included within the spreadsheet.

This spreadsheet assists the user with the design of a signal conditioning system by calculating the gains and hardware bias offsets to optimize the system's range and resolution. Within the spreadsheet are sample calculations for converting voltages into forces and torques.

The worksheets within this spreadsheet provide the following functions:

- an overview of the spreadsheet contents
- instructions for how to construct a system
- a place for users to record key properties of the system
- calculate F/T values read by the transducer
- assist the user to calculate the electrical gain of the user-supplied amplifiers.

For additional information to assist with the setup and use of this spreadsheet, refer to [Section 3.2—TWE Calibration Spreadsheet \(FTxxxxx TWE.xlsx\)](#).

3. Electrical Setup

This setup guide details how to connect a TWE transducer to a user's DAQ system. In [Section 6—Appendix](#), additional information such as the transducer cable connectors and signals and advanced topics such as amplification/excitation, resolution, and detecting sensitivity changes are covered in detail. A system includes the components in the following table:

Table 3.1—Components of a TWE System	
Component	Description
Transducer with TWE Calibration	An ATI transducer supplied with TWE calibration
Excitation Supply (user-supplied)	Excitation voltage supply to power the ATI transducer's strain gages (refer to Section 3.1.1—Excitation Voltage Supply).
Amplifiers (user-supplied)	Amplifiers for each of the six ATI transducer low-level outputs (refer to Section 3.1.2—Six Amplifiers).
DAQ System (user-supplied)	A DAQ system that converts the six amplified voltages from the amplifier into digital values.
Computer (user-supplied)	A computer to use the digital values from the DAQ system.
Software (user-supplied)	Software that uses the data provided by the TWE Calibration Spreadsheet and the digital values from the DAQ system to convert the values into the transducer's F/T loads.
TWE Calibration Spreadsheet	The ATI Calibration Spreadsheet with the correct FTxxxxx serial number, after the user has input the system characterization data (refer to Section 3.2.3—Worksheet 3. System Characterization).
Cables and Connectors (user-supplied)	Cables and connectors for the following: <ul style="list-style-type: none"> • to connect the transducer to amplifier inputs and excitation voltage supply • to connect the amplifier outputs to the inputs of a DAQ system • to connect the DAQ system to a computer

Signals in a TWE system are detailed in the following table:

Table 3.2—Signals in a TWE System			
Signal Name	Source:	Used By:	Description
Excitation Voltage	User Excitation Supply	ATI Transducer	A voltage supply that powers the transducer. It should have low noise and low drift.
Low-level Voltages	Transducer	User's Amplifiers	Six outputs (g0, g1, g2, g3, g4, and g5) of the ATI transducer before amplification.
Amplified Voltages	User's Amplifiers	User's DAQ system	Six amplified outputs (G0, G1, G2, G3, G4, and G5) of the user's amplifiers.
Digitized Voltages	User's DAQ System	User's Computer	Digital representation of the six amplified outputs (G0, G1, G2, G3, G4, and G5).

3.1 Excitation Voltage Supply and Six Amplifiers

The excitation voltage supply and the six amplifiers are grouped together in this section because these functions are commonly put on the same circuit board or are found in the same off-the shelf equipment. A graph in [Appendix B—Amplification and Excitation](#) shows the relationship between amplification, excitation, and output range.

3.1.1 Excitation Voltage Supply

The customer-supplied excitation voltage supply (V_{exc}) provides power to the transducer. The signals output by the transducer are directly proportional to the excitation voltage supply and the applied load. Because these signals are directly proportional to the excitation voltage supply, it is critical that the supply has both low noise and low drift.

The recommended values and specifications for excitation voltage supply (V_{exc}) are in the following tables:

Parameter	Value	Notes
V_{exc}	5 VDC	Lower voltages increase thermal stability but may lower signal to noise ratio.

Parameter	Value		Notes
	Minimum	Maximum	
V_{exc}	N/A	10 VDC	Thermal drift increases as output voltage increases.
Transducer Input Resistance	Gamma Transducer	275 Ω	The excitation voltage supply must be able to provide current to a resistive load at this amount or lower.
	Other Transducers	500 Ω	

Output noise on the excitation voltage supply is notated as V_{exc_noise} . For each transducer gage signal the output the V_{exc_noise} is halved and amplified with the strain gage signals. The noise passed to the unamplified transducer gage signal in mV/V form equals:

$$\left(\frac{V_{exc_noise}}{V_{exc}} \div 2 \right) \times \frac{1000 \text{ mV}}{1 \text{ V}}$$

Output drift on the excitation voltage supply is notated as V_{exc_drift} . For each transducer gage signal the output the V_{exc_drift} is halved and amplified with the strain gage signals. The noise passed to the unamplified transducer gage signal in mV/V form equals:

$$\left(\frac{V_{exc_drift}}{V_{exc}} \div 2 \right) \times \frac{1000 \text{ mV}}{1 \text{ V}}$$

Use an excitation voltage supply based on a precision voltage reference. Precision voltage reference integrated circuits (ICs) can have excellent noise and drift characteristics and perform much better than laboratory power supplies. Precision voltage reference evaluation boards are available from many electronics distributors and manufacturers of precision voltage references. A web search for “precision voltage reference evaluation board” will help locate information about such boards.

The amount of excitation voltage supply noise it takes to create one bit of noise on the DAQ system is shown in the following graph. This graph does not account for noise added during amplification, noise coupled from external sources, or mechanical noise sensed by the transducer. Four excitation voltages are shown in the graph: 2.5 V, 3.3 V, 5 V, and 10 V. A DAQ system analog-to-digital converter (ADC) resolutions of 10 bits through 24 bits are shown in the graph, for example: a system with a 3.3 V excitation and a 16-bit ADC creates one bit of noise, if V_{exc_noise} exceeds 1×10^{-4} V (100 μ V).

Figure 3.1— V_{exc_noise} Resulting in One ADC Bit of Noise

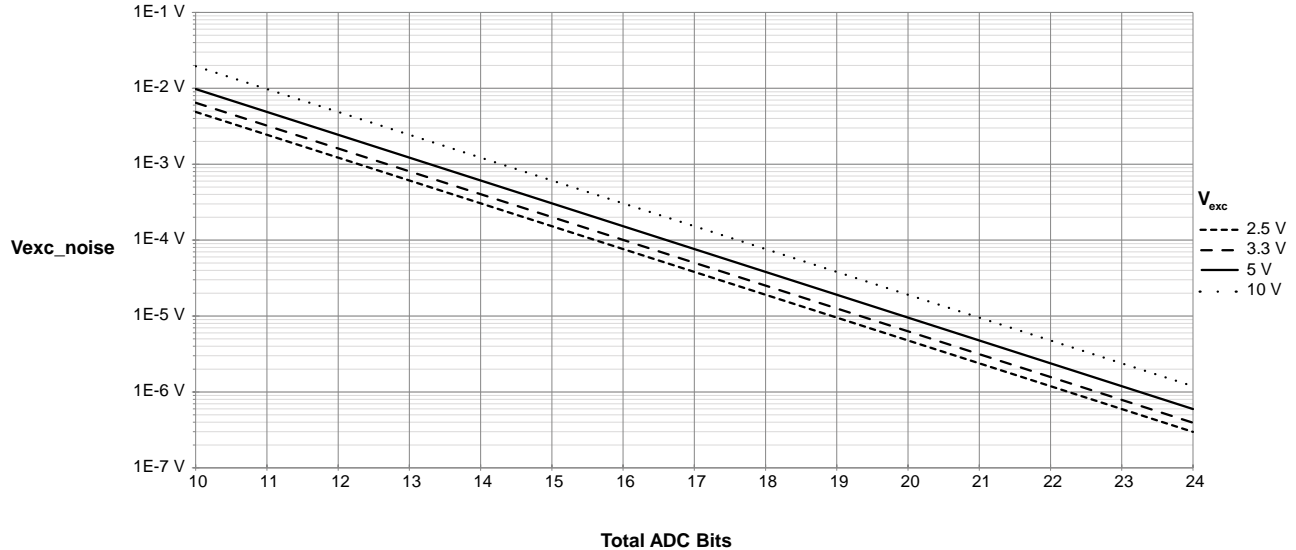

3.1.2 Six Amplifiers

The TWE transducer’s outputs need to be amplified to work with a user’s DAQ system. Each of the TWE transducer’s six outputs require a user-supplied amplifier. The amplifiers perform the following functions:

- to increase the transducer’s low-level outputs to a range appropriate for the DAQ system
- to remove any offset from the transducer’s signals

While fixed-gain amplifiers may be used, variable-gain amplifiers are preferred because they can be adjusted to more closely match the ideal gain. Closely matching the ideal gains helps ensure the system provides the best combination of resolution and range. Gains that are too high result in coarser resolution, while gains that are too low result in limited range.

The ideal gain for each amplifier can be calculated by the *TWE Calibration Spreadsheet* (*TWE FTxxxx.xls*). The ideal gain amplifies the transducer’s outputs to best fit the DAQ systems inputs. This matching ensures the full loading range of the transducer can be read at the highest resolution. [Appendix B—Amplification and Excitation](#) has a graph that shows the relationship between amplification, excitation voltage, and transducer signal output range.

To ensure the full loading range can be read, the amplifiers need to trim any offset from the transducer signals.

The nominal unloaded output of each half bridge is a voltage halfway between V_{exc-} (lower excitation voltage) and V_{exc+} (upper excitation voltage), expressed mathematically as:

$$g_{nom} = \frac{V_{exc+} + V_{exc-}}{2}$$

All strain gage output voltages have some offset bias voltage present. This offset bias voltage is the shift of the strain gage output from ideal unloaded output (g_{nom}). Removing this offset voltage, prior to amplifying the signals, allows user-supplied equipment to operate at the most sensitive measurement range. The most effective way to remove offset voltage is to use a differential amplifier with a fixed bias reference voltage identical to this offset voltage. This bias reference voltage serves as the amplifier's negative voltage input, while the strain gage voltage is the positive.

An easy way to generate this bias reference voltage for each strain gage is with a single 10-turn 200 Ω potentiometer and two 1000 Ω resistors (see [Figure 3.2](#)). Adjust the reference output voltage without anything mounted to the transducer. Place it on a level surface. Adjust the potentiometers so the DAQ output reads midrange.

Figure 3.2—Example Bias Reference Voltage Circuit (user-supplied)

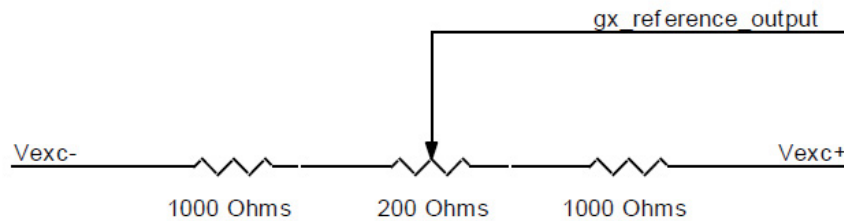

3.1.3 DAQ System

The user-supplied DAQ system converts the six amplified strain gage signals from voltages to digital values for a computer to process.

3.1.4 Computer

The user-supplied computer reads the digital values from the DAQ system. These values can be entered into the *TWE Calibration Spreadsheet* (refer to [Section 3.2—TWE Calibration Spreadsheet \(FTxxxx TWE.xlsx\)](#)).

3.1.5 Connections (cables and connectors)

Users must electrically connect their supplied amplifiers and excitation to the transducer. For information on the connections from the transducer, refer to [Appendix A—Transducer Cable Connectors and Signals](#). Install the DAQ system software on the computer. Connect the DAQ system to the computer. Connect the DAQ system inputs to the outputs of the amplifiers.

3.2 TWE Calibration Spreadsheet (FTxxxx TWE.xlsx)

For a general overview of the spreadsheet, refer to [Section 2.5—TWE Calibration Spreadsheet Overview](#). A more detailed description of each worksheet and instructions to use the spreadsheet are in the following sections. In the spreadsheet, the first four of the worksheets are numbered in the order that they should be used. The last worksheet (*Gain Worksheet*) is not required for users to operate their system. This worksheet is intended as an optional help-aid to assist users as they measure their amplifiers' gain.

Most cells in the spreadsheet should not be modified. The cells for entering data are shaded. The five worksheets in the spreadsheet are described in the following sections.

NOTICE: Depending on the transducer, the worksheets may vary slightly in appearance from the following example figures of each worksheet, but the worksheet functionality is the same.

3.2.1 Worksheet 1. Overview

The *1. Overview* worksheet provides a summary for each of the five worksheets in the spreadsheet and brief instructions for how the each worksheet should be used.

Figure 3.3—Screen Capture of Worksheet 1. Overview

Transducer model: Delta IP65/SI-165-15, Serial Number: FT12345

Transducer with TWE Calibration - Overview

This workbook contains worksheets used to help the user set up and use their TWE- or TWL-calibrated transducer system to measure forces and torques. (TWE and TWL calibrations are for transducers that do not include electronics. The user must supply the electronics and connections described in worksheet 2. *Electrical Setup*.)

Instructions

This spreadsheet is intended to be used in conjunction with the user manual.
Read each of the worksheets, in numeric order, and follow the instructions on each.

Worksheets (tabs) in this Spreadsheet Workbook

- 1. Overview**
This worksheet.
- 2. Electrical Setup**
The *2. Electrical Setup* worksheet gives an overview of the required electrical connections. It includes a list of required equipment and a list with checkboxes to aid the user in setting up their system.
- 3. System Characterization**
The *3. System Characterization* worksheet collects information about the user's equipment and creates the Amplified Calibration Matrix. The Amplified Calibration Matrix is used to convert the amplified transducer voltages into force and torque measurements.

The worksheet requires the exact excitation voltage supplied to the transducer (at its connector) and the input range of the DAQ system used to digitize the amplified strain gage output. From these it will calculate the ideal amplification values for each strain gage. These values are to be used as target values for the amplifier gains. The actual amplifier gain and the measured excitation voltage are used to create the Amplified Calibration Matrix. The worksheet *Gain Worksheet* may be used to help with the gain measurements.
- 4. Sample Calculations**
The *4. Sample Calculations* worksheet performs the conversion of amplified strain gage voltages into resolved force and torque data. This worksheet requires that system information is filled out in the *3. System Characterization* worksheet. The highlighted cells in this worksheet are for the amplified voltages read from the transducer. Rows for two cases are provided, one for an unloaded case (a reference or bias load) and one for a loaded case.

Gain Worksheet

The *Gain Worksheet* steps the user through the process of measuring the gains of their amplifiers. It is provided as a helpful resource and not required to be used. If used, the gain values in the *Measured Gain Results* section should be copied to the ④ *Actual Gain Results* section of worksheet 3. *System Characterization*.

3.2.2 Worksheet 2. Electrical Setup

The 2. *Electrical Setup* worksheet guides the user through building a TWE system. The **Electrical Overview** schematic shows the necessary components for a TWE system and describes how signals pass from one component to another.

The **Building the Transducer System** section contains a setup procedure for connecting the system components. After a task is completed, select the corresponding check box. In the following image, the user has checked boxes as steps were completed.

Figure 3.4—Screen Capture of Worksheet 2. Electrical Setup

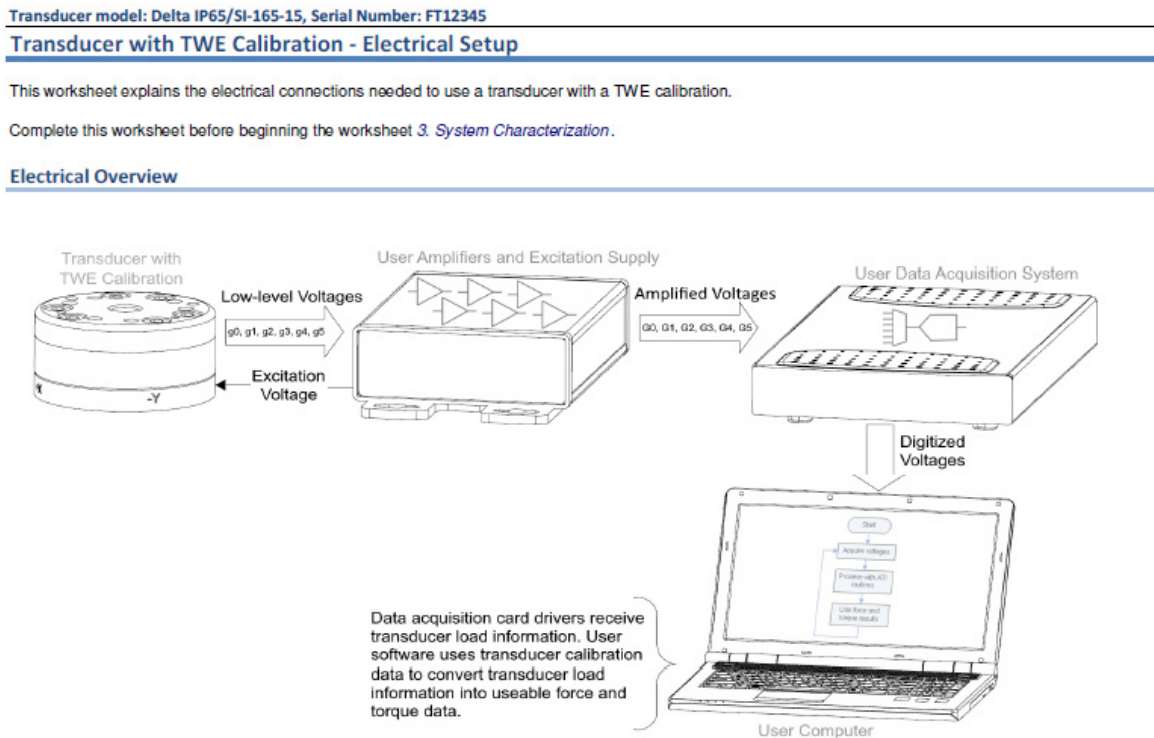

Building the Transducer System

This is a summary of how to connect the transducer. See manual for detailed information.

Required Equipment

- ATI transducer with TWE calibration
- Excitation power supply
- Voltmeter to measure excitation voltage
- Amplifiers with settable gains and settable offsets (six channels)
- Data acquisition system (six channels)
- Cables and connectors to connect transducer, amplifiers, excitation, and DAQ

Procedure

- | Done? | Task Description |
|-------------------------------------|--|
| <input checked="" type="checkbox"/> | 1. Wire a mating transducer connector to the following (see TWE manual for pin assignments): |
| <input checked="" type="checkbox"/> | - Two connections to the excitation power supply |
| <input checked="" type="checkbox"/> | - Six connections to the amplifier inputs |
| <input checked="" type="checkbox"/> | - Connect connector shell to system ground (Optional but recommended) |
| <input checked="" type="checkbox"/> | 2. Connect amplifier outputs to DAQ card inputs |
| <input type="checkbox"/> | 3. Proceed to the next tab of this spreadsheet, "3. System Characterization". |

3.2.3 Worksheet 3. System Characterization

In this worksheet (*Figure 3.5*), the user inputs values for various characteristics of their TWE system. These values are used to develop the *Amplified Calibration Matrix* that is used to convert digitalized voltages into usable F/T values.

In the **Overview** section schematic, the numbered call outs point to system components. These call outs reference to a step in the **Instructions** section of the worksheet. These steps require the TWE system is electrically connected and operating.

For step four, the user needs measure the user-supplied amplifier gains and type these values in the worksheet. For this step, temporarily disconnect the TWE transducer from the amplifies, and then apply voltages to the amplifier inputs. Use a voltmeter to measure the values. Record the readings in the *Gain Worksheet* (refer to *Section 3.2.5—Worksheet Gain Worksheet*). The *Gain Worksheet* can assist the user to calculate the amplifier gains for step four in the *3. System Characterization* worksheet.

Figure 3.5—Screen Capture of Worksheet 3. System Characterization

Transducer model: Delta IP65/SI-165-15, Serial Number: FT12345

Transducer with TWE Calibration - System Characterization

This worksheet creates a transducer calibration matrix matched to the user amplifiers and data acquisition system.

Overview

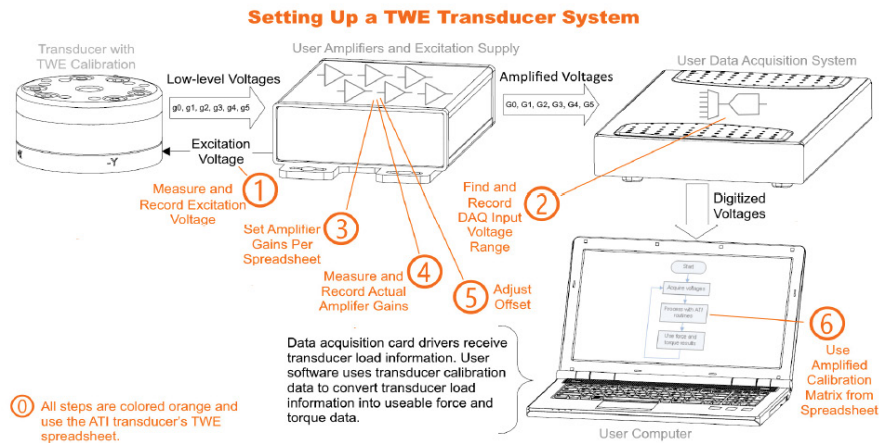

Instructions

- ① Measure excitation voltage at the transducer connector.

Item	Value	Units	Description
Excitation Voltage (Vexc+)	4.9979	VDC	Enter the excitation voltage. (Five volts is typically used.)
Excitation Voltage Reference (Vexc-)	0	VDC	Usually zero. (Ground voltage is typically used.)

- ② Enter DAQ input voltage range. For example, a ±5 V DAQ would use +5 V and -5 V.

Item	Value	Units	Description
DAQ Maximum Input Voltage	5	VDC	Enter the maximum input signal voltage for connected data acquisition hardware.
DAQ Minimum Input Voltage	-5	VDC	Enter the minimum input signal voltage for connected data acquisition hardware.

- ③ Set amplifier gains as follows:

Gage	G0	G1	G2	G3	G4	G5	Description
Target Gain	139.294	146.180	131.494	135.127	135.414	137.321	Gains for optimum range and resolution

- ④ Measure actual amplifier gains and enter values. Use *Gain Worksheet* if needed.

Gage	G0	G1	G2	G3	G4	G5	Description
Measured Gain	130.1	130.3	130	129.9	130.1	130.2	Enter the actual gain of each amplifier

- ⑤ Adjust amplifier offsets so unmounted, unloaded transducer reads middle of DAQ input range, such as 0 V for ±5 V range or 2.5 V for 0 V to 5 V range.

Note: Allow transducer to warm up for about half of an hour after applying the excitation voltage. Doing so will help stabilize the transducer output offsets.

- ⑥ This is the Amplified Calibration Matrix: Use this calibration matrix to convert DAQ readings into force and torque values

	G0	G1	G2	G3	G4	G5	Units
Fx	2.792168191	0.115797332	-2.48521227	-37.5466177	0.030840735	36.55045929	N/V
Fy	-0.38949265	42.57769012	2.535232767	-21.4533014	-3.78866348	-21.3951167	N/V
Fz	60.23221584	-1.41385212	59.83297587	0.596193548	60.16400128	0.653726313	N/V
Tx	-0.02820373	0.910380207	-2.07141903	-0.47898615	2.099582569	-0.43308492	N-m/V
Ty	2.410217915	-0.05615514	-1.15858394	0.801226223	-1.26177232	-0.80873168	N-m/V
Tz	-0.00184481	-1.32832754	-0.04788941	-1.34571467	-0.02646463	-1.32103441	N-m/V

Supplemental Information

Transducer Low-level Voltage Output Ranges

	g0	g1	g2	g3	g4	g5	Units
Range with 4.9979 V excitation	0.072	0.068	0.076	0.074	0.074	0.073	VDC
Maximum output	2.571	2.567	2.575	2.573	2.573	2.572	VDC
Minimum output	2.427	2.431	2.423	2.425	2.425	2.426	VDC
In nV/V form	14.364	13.688	15.216	14.807	14.776	14.571	mV/V

Transducer Amplified Voltage Output Ranges

	G0	G1	G2	G3	G4	G5	Units
With 4.9979 V excitation and amplified	9.340	8.914	9.886	9.613	9.608	9.481	VDC

Intermediate Calculations

Excitation Calculations

Item	Value	Units	Description
Excitation	4.9979	VDC	Transducer excitation (= ExcitationHigh - ExcitationLow).
Nominal Unloaded Output	2.49895	VDC	The strain gage outputs will be centered on this voltage, the midpoint between excitation voltages.
Excitation Data Entered	TRUE		For spreadsheet internal use. TRUE if excitation voltage numbers are present.

DAQ Input Range Calculations

Item	Value	Units	Description
DAQ Input Range	10	VDC	Input range of the DAQ (= Maximum Input Voltage - Minimum Input Voltage.)
DAQ Input Midpoint	0	VDC	Midpoint (= halfway point between Minimum Input Voltage and Maximum Input Voltage)
DAQ Input Range Entered	TRUE		For spreadsheet internal use. TRUE if DAQ input range numbers are present.

3.2.4 Worksheet 4. Sample Calculations

This worksheet performs the conversion of the DAQ system’s amplified strain gage voltages into resolved F/T data. Formulas for the calculations are provided on the worksheet. Users can use these formulas to aid them as they create their own software to complete F/T calculations.

Figure 3.6—Screen Capture of Worksheet 4. Sample Calculations

Transducer model: Delta IP65/SI-165-15, Serial Number: FT12345

Transducer with TWE Calibration - Sample Calculations

This worksheet calculates calibrated output (resolved loads for Fx through Tz) from the amplified strain gage voltages.

Place transducer's amplified voltages in the *Reference Measurement* or *Loaded Measurement* cells as appropriate. The reference measurement, also known as a *tare* or *zero* measurement, accounts for any gravity load and offset reported by the transducer before the load of interest is applied. The resulting force and torque values are in the *Resolved Loads* section.

Strain Gage Measurements (Amplified)

	G0	G1	G2	G3	G4	G5 Units
Reference Measurement (reading 1)	0	0	0	0	0	0 V
Loaded Measurement (reading 2)	2.54691074	0.02098288	-1.19746329	-1.93524508	-1.21510802	2.03568065 V

F/T Calculation

Amplified Gages

	G0	G1	G2	G3	G4	G5 Units
Loaded - Reference:	2.54691074	0.02098288	-1.19746329	-1.93524508	-1.21510802	2.03568065 V

Resolved Loads

axis:	Fx	Fy	Fz	Tx	Ty	Tz
Resolved Loads:	157.119279	-0.56704234	8.79985566	-0.07816835	5.86109447	-0.02798397
units:	N	N	N	N-m	N-m	N-m

Equation for Converting Voltages to Resolved Loads

The equation for converting the measured amplified strain gage voltages into forces and torques is represented below as an Excel formula as well as in standard mathematical notation.

Excel Formula

$$=TRANSPOSE(MMULT(AmpCalMatrix,TRANSPOSE(AmplifiedGages)))$$

where

- The result is 1 × 6 array of the calculated forces and torques {Fx, Fy, Fz, Tx, Ty, Tz}
- AmpCalMatrix is the 6 × 6 array Amplified Calibration Matrix from the 3. *System Characterization* tab of this spreadsheet
- AmplifiedGages is a 1 × 6 array of DAQ gage voltages {G0, G1, G2, G3, G4, G5}

Mathematical Notation

$$R = [C G^T]^T$$

where

- R is the resulting 1 × 6 matrix containing the calculated forces and torques as follows: $[F_x, F_y, F_z, T_x, T_y, T_z]$
- C is the 6 × 6 Amplified Calibration Matrix from the 3. *System Characterization* tab of this spreadsheet
- G is a 1 × 6 matrix of DAQ gage voltages as follows: [G0, G1, G2, G3, G4, G5]

3.2.5 Worksheet *Gain Worksheet*

The *Gain Worksheet* steps the user through the process of measuring the gains of their amplifiers. This worksheet is intended as a helpful resource and not required to be used.

The user applies a series of test voltages to the input of an amplifier while measuring the test voltages and the amplifier outputs. The worksheet suggests three test voltages to use. These test voltages are based on the values input to the worksheet *Worksheet 3. System Characterization*. In the provided table, the user records the actual test voltages used and the amplifier output voltages. Note that the user can change the **Units** column of the table to either mV or V, as appropriate for the measurements.

The calculated gains are in the **Measured Gain Results** section. These values should be copied and pasted as values into step four of worksheet 3. *System Characterization* (refer to [Section 3.2.3—Worksheet 3. System Characterization](#)).

Figure 3.7—Screen Capture of *Gain Worksheet*

Transducer model: Delta IP65/SI-165-15, Serial Number: FT12345

Transducer with TWE Calibration - Gain Worksheet

This Gain Worksheet helps the user determine the what gain the amplifiers are producing.

Required Equipment

- Connected amplifiers, DAQ, and computer shown on worksheet 3. *System Characterization*.
- Voltmeter
- Adjustable DC voltage source

Process Overview

The user will apply a test voltage to the input of an amplifier, record the test voltage and record the amplifier output voltage as reported by the DAQ system. This will be repeated for the remaining strain gage amplifiers. Then the test will be repeated using other test voltages. A minimum of three test voltages is recommended (suggested test voltages are in the Info: Suggested Test Voltages section below).

Process

Step	Instruction
1	Apply a test voltage to amplifier's input.
2	Record applied voltage in <i>User Test Data</i> table, <i>Unamp</i> row, appropriate gage column.
3	Record voltage reported by DAQ system for that input in <i>Amplfd</i> Row.
4	Repeat for each gage.
5	Repeat to apply at least three sets of test voltages (this worksheet supports up to six sets).

Info: Suggested Test Voltages (based on user excitation voltage and DAQ input range)

Test voltage 1	2.437 V
Test voltage 2	2.499 V
Test voltage 3	2.561 V

User Test Data (a minimum of three test sets is recommended)

Test	G0	G1	G2	G3	G4	G5	Units
1 Unamp	2.437	2.437	2.437	2.437	2.437	2.437	V
1 Amplfd	-8.0562	-8.0686	-8.05	-8.0438	-8.0562	-8.0624	V
2 Unamp	2.499	2.499	2.499	2.499	2.499	2.499	V
2 Amplfd	0.01	0.01	0.01	0.01	0.01	0.01	V
3 Unamp	2.561	2.561	2.561	2.561	2.561	2.561	V
3 Amplfd	8.0762	8.0886	8.07	8.0638	8.0762	8.0824	V
4 Unamp							V
4 Amplfd							V
5 Unamp							V
5 Amplfd							V
6 Unamp							V
6 Amplfd							V

Measured Gain Results (not valid until all data has been entered)

G0	G1	G2	G3	G4	G5	Units
130.1000	130.3000	130.0000	129.9000	130.1000	130.2000	V/V

3.3 How to Use the TWE Calibration Spreadsheet

An overview of the TWE calibration spreadsheet is in [Section 2.5—TWE Calibration Spreadsheet Overview](#).

To ensure the transducer is used over its entire calibration range with maximum resolution, use the spreadsheet per the following instructions.

1. Electrically connect the transducer to the user-supplied excitation voltage, amplifiers, and DAQ system as outlined in the worksheet [Worksheet 2. Electrical Setup](#).
2. Input the values of the system into the [Worksheet 3. System Characterization](#).
 - a. In the [3. System Characterization](#) worksheet, type the high and low excitation voltages of the system. For information regarding the excited voltage supply, refer to [Section 3.1.1—Excitation Voltage Supply](#).
 - b. Next, type the maximum and minimum desired output of the system. If using a DAQ system, the desired output range is determined by the input range of the DAQ. For example: a DAQ with a ± 5 V input range would use 5 V for the maximum input voltage and -5 V for the minimum input voltage.

NOTICE: The worksheet uses the information from step *b* to provide optimum target gain settings for each gage. This amplification allows the transducer to be used over its entire calibration range with maximum resolution.

- c. Adjust the amplifiers to provide gains approximately equal to the values from step *b* (for general information about amplification, refer to [Section 3.1.2—Six Amplifiers](#)).
 - d. Measure the actual gains of each strain gage channel in the circuit and enter them into the worksheet.
 - e. Adjust the hardware bias circuitry so the amplified outputs are midrange when the unmounted transducer is placed MAP side down on a level surface. Making this adjustment ensures the transducer's full range is available. For general information about bias circuitry, refer to [Section 3.1.2—Six Amplifiers](#).
3. Use the workbook [Worksheet 4. Sample Calculations](#) to test the complete system's operation.
 - a. With the transducer at rest, take a measurement of all six strain gage channels.
 - b. Type these values into the **reference measurement** cells in the [Worksheet 4. Sample Calculations](#).
 - c. Place a known load on the transducer, and type this measurement value into the *loaded measurement* cells.

NOTICE: The easiest scenario for taking this test load is to place a weight on the Z axis. If the mass is centered on the Z axis, there will be little Tx and Ty readings. For this test, ATI suggests using a weight that applies at least one quarter of the transducer's Fz sensing range.

- d. Verify that the resolved loads calculated by the spreadsheet match the expected results.
4. Incorporate the formulas from the [Worksheet 4. Sample Calculations](#) page and the **Amplified Calibration Matrix** from the [Worksheet 3. System Characterization](#) into the final application.



CAUTION: Before performing the F/T conversion, every voltage measurement should be checked for saturation of the A/D converter. If one or more of the six gage channels is saturated, F/T values cannot be accurately calculated and the transducer may be in danger of damage due to excessive loading.

4. Periodic Maintenance

To keep the transducer functioning at peak performance, incorporate the following maintenance items on an annual basis.

4.1 Inspection of Cables

For most applications there are no parts that need to be replaced during normal operation. With industrial-type applications that continuously or frequently move the system's cabling, you should periodically check the cable jacket for signs of wear.

The transducer must be kept free of excessive dust, debris, or moisture. The internal structure of the transducer can become clogged with particles and will become uncalibrated or even damaged. For example, in applications with metallic debris such as electrically-conductive material, protect the transducer from debris by keeping the transducer enclosed in a resistant housing. Non-IP rated sensors are considered to have no ingress protection.

4.2 Calibration

Periodic calibration of the transducer is required to maintain traceability to national standards. Follow any applicable ISO-9000-type standards for calibration. ATI Industrial Automation recommends annual recalibrations, especially for applications that frequently cycle the loads applied to the transducer.

5. Troubleshooting

Customer service is available for problems or questions not addressed in the manuals.

Note

Please read the manual before calling customer service. Before calling, have the following information available:

1. Serial number (e.g., FT01234)
2. Transducer model (e.g., Nano17, Gamma, Theta, etc.)
3. Calibration (e.g., US-15-50, SI-65-6, etc.)
4. Accurate and complete description of the question or problem
5. Computer and software information. Operating system, computer type, drivers, application software, and other relevant information about your configuration.

If possible, be near the F/T system when calling.

Please contact an ATI representative for assistance, if needed:

ATI Industrial Automation

1031 Goodworth Drive
Apex, NC 27539 USA
www.ati-ia.com

Application Engineering

Tel: +1.919.772.0115, Extension 511
Fax: +1.919.772.8259
E-mail: ft_support@ati-ia.com

6. Appendix

Information in these appendixes aid the user during initial setup of the TWE system.

6.1 Appendix A—Transducer Cable Connectors and Signals

6.1.1 Transducer Mating Connectors

The connector styles for each transducer type are listed in the following table:

Transducer Type	ATI Transducer Example	Connector Style	Manufacturer	Manufacturer P/N
9105-TWE	non-IP rated Gamma, Delta, and Omega	cable mount	Hirose	HR25-9TP-205(73)
9105-TWL	IP-rated Gamma, Delta, and Omega sensors.	cable mount	Lemo	FGG.3K.320.CLA
9105-TW	Nano and Mini	cable mount	Amphenol	T-3636-001
		chassis mount	Amphenol	T-3638-009

6.1.2 Pin Connections on the Cable Connectors



CAUTION: Although the cables used by ATI Industrial Automation are robust, the individual wires in the cables must be handled with care to avoid damaging them. Correctly-sized wire strippers are required and the wires must be strain relieved and anchored where ever they are soldered to prevent breaking.

6.1.2.1 Nano/Mini Integral Cable Connectors

Connector pin numbers with their corresponding signal description are listed in the following table:

Schematic of the Connector Pin Out (pin side of transducer connector)	Pin	Wire Color	Description
	A	---	No connection
	B	Yellow	g4 output
	C	Brown	g5 output
	D	Violet	g2 output
	E	Blue	g3 output
	F	Green	g0 output
	G	Orange	g1 output
	H	---	No connection
	J	Black	V_{exc-} excitation input
	K	Red	V_{exc+} excitation input

6.1.2.2 9105-C-x-A Cable Connectors

Connector pin numbers with their corresponding signals are listed in the following table

Table 6.3—Connector Connections in 9105-C-x¹-A Cables				
Pin Number for Connector:			Wire Color	Signal
H²	L³	A⁴		
6	1	K	Red	V _{exc+}
10	4	J	Black	V _{exc-}
1	7	F	Brown	g0
7	9	G	Yellow	g1
17	11	D	Green	g2
8	13	E	Blue	g3
13	15	B	Violet	g4
9	17	C	Grey	g5
2	5	Not Connected	Orange	N/A
3	8		Brown/White	
4	14		Blue/White	
5	18		Grey/White	
11	2		Red/White	
12	10		Yellow/White	
14	19		White	
15	3		Black/White	
16	6		Orange/White	
18	16		Violet/White	
19	20		White/Black	
20	12		Green/White	
Notes: <ol style="list-style-type: none"> In the part number 9105-C-x-A, x is either H or L for the transducer end of the cable), and A for the electronics end of the cable. Column H applies to the 9105-TWE transducers. Column L applies to the 9105-TWL transducers. Column A applies to the 9105-TW transducers. The cable part number for TW transducers is 9105-C-X-A. 				

6.2 Appendix B—Amplification and Excitation

Figure 6.1 shows how much amplification is needed to achieve a given output range for a given excitation voltage and transducer sensitivity. The chart in the following figure shows the gain calculations made by the spreadsheet FTxxxxx TWE.xlsx (refer to [Section 3.2—TWE Calibration Spreadsheet \(FTxxxxx TWE.xlsx\)](#)). Output ranges can be bipolar ($\pm x$ V, on the left axis) or unipolar (0 V to x V, on the right axis). The required amplification for a 5 V excitation is shown on the top axis. The bottom axis is the product of amplification and the excitation voltage.

To use the *Figure 6.1*:

1. Determine the required output type, either bipolar or unipolar. This is usually determined by the input range of the DAQ used to read the amplifier outputs.
2. Determine the required output range in volts. This is usually determined by the input range of the DAQ used to read the amplifier outputs.
3. Determine the excitation voltage that supplies the transducer.
4. Determine the transducer signal output range in mV/V. This can be found in the FTxxxxx TWE.xlsx spreadsheet, [Worksheet 3. System Characterization](#), in the **Supplemental Information** section ([Figure 3.5](#)), **Transducer Low-level Voltage Output Ranges** table, row **In mV/V form**.

NOTICE: If the excitation voltage is 5 V, then use the top axis to determine the amount of amplification needed. If the excitation voltage is not 5 V, then use the bottom axis. In that case, divide the values on the bottom axis by the excitation voltage to get the amplification.

5. Plot a line for the transducer signal output range on the graph. Find where the selected output range on the appropriate vertical axis crosses the plotted line for the transducer signal output range. Follow this point to the appropriate horizontal axis. This will show the amount of gain needed.

6.2.1 Examples

The following examples demonstrate how to use the graph (*Figure 6.1*) to find the amount of gain needed.

Example One:

The DAQ input range is unipolar, ranging from 0 V to 20 V. The excitation voltage is 5 V. The transducer signal output range of the strain gage of interest is 55 mV/V.

Use the right vertical axis because the DAQ input range is unipolar. Use the top horizontal axis because the excitation voltage is 5 V. The 20 V level of the left vertical axis intersects the 55 mV/V line at 72.7 on the top horizontal axis. The required amplification is 72.7.

Example Two:

The DAQ input range is bipolar, ranging from -10 V to +10 V (± 10 V). The excitation voltage is 4 V. The transducer signal output range of the strain gage of interest is 15 mV/V.

Use the left vertical axis because the DAQ input range is bipolar. Use the bottom horizontal axis because the excitation voltage is not 5 V. The ± 10 V level of the left vertical axis intersects the 15 mV/V line at 666.7 V on the bottom horizontal axis. Divide the 666.7 V by the 4 V excitation to get 166.7. The required amplification is 166.7.

Figure 6.1—Amplification vs. Output Range for Various Sensitivities

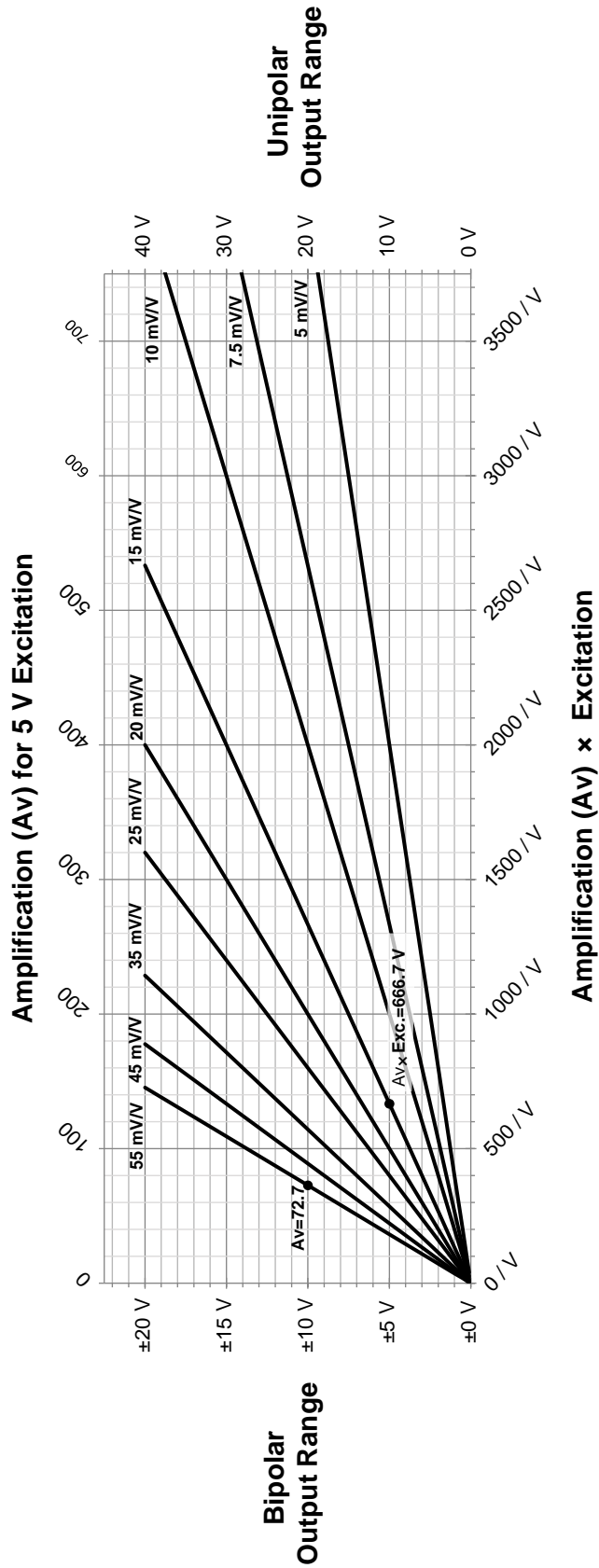

6.3 Appendix C—Mechanical and Electrical Overview of the Transducer

An overview of the transducer requires a brief mechanical and electrical summary of the design. Mechanical principles define the movement of the transducer. Based on these mechanical principles, ATI integrates electronics into the transducer to measure its physical movements. These electronics relay signals that report F/T data to the user's system.

6.3.1 Mechanical Description

The transducer reacts to applied forces and torques using Newton's third law of motion: to every action there is always opposed an equal reaction; or, the mutual action of two bodies upon each other are always equal, and directed to contrary parts.

Figure 6.2—Applied force and torque vector on transducer

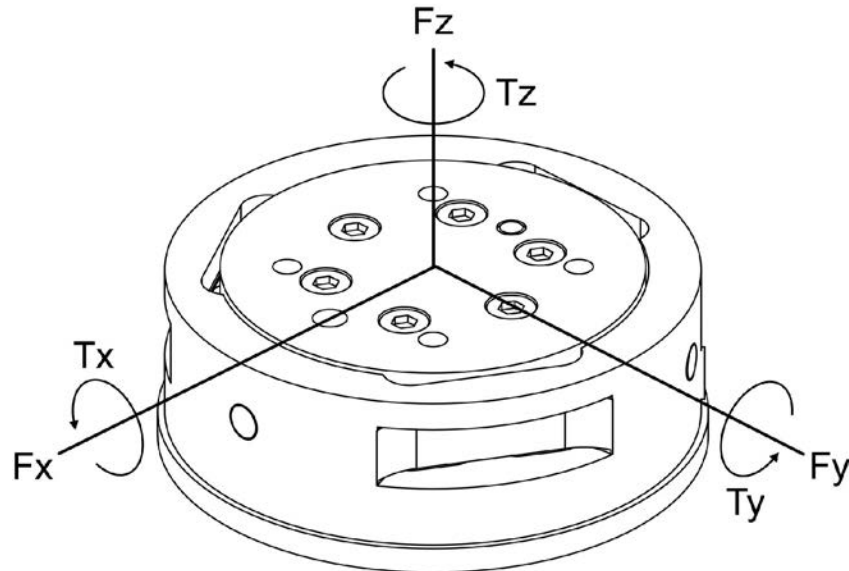

Force and torque are three-dimensional vectors, which can be broken into three orthogonal components.

The force applied to the transducer flexes three symmetrically placed beams using Hooke's law: $\sigma = E \cdot \epsilon$

where:

σ = stress applied to the beam (σ is proportional to force)

E = elasticity modulus of the beam

ϵ = strain applied to the beam

NOTICE: The transducer is a monolithic structure. The beams are machined from a solid piece of metal. This decreases hysteresis and increases the strength and repeatability of the structure.

Silicon semiconductor strain gages are attached to the beams and function as strain-sensitive resistors. The resistance of the strain gage changes as a function of the applied strain:

$$\Delta R = S_a \cdot R_o \cdot \epsilon$$

where:

ΔR = Change in resistance of strain gage

S_a = Gage factor of strain gage

R_o = Resistance of strain gage unstrained

ϵ = Strain applied to strain gage

The output voltages from the transducer's gages are used to measure the change in resistance. They must be combined mathematically to be converted into forces and torques (refer to [Section 3.2—TWE Calibration Spreadsheet \(FTxxxx TWE.xlsx\)](#)).

6.3.2 Electrical Description

The transducer is instrumented with high-quality silicon semiconductor strain gages. The high output of these silicon strain gages requires far less amplification than foil-based strain gages. The higher amplification required by foil strain gages boosts their signals and any noise present. Since silicon strain gages require less amplification there is less noise amplification. Silicon strain gages also allow transducers to survive higher overload conditions without damage.

The transducer uses six half-bridge strain gage pairs to sense loads. For all transducers except the Gamma, the excitation power supply (V_{exc+} , V_{exc-}) must supply a 500 Ω load. The Gamma requires the ability to supply a 275 Ω load. [Figure 6.3](#) shows the electrical equivalent schematic of the transducer.

Each half-bridge strain gage pair measures a portion of the total transducer load. A load places compressive strain on one member of the gage pair and equally tensile strain on the other member. The pair works together as a voltage divider to produce a signal representing the pair's load.

Figure 6.3—Transducer Equivalent Schematic

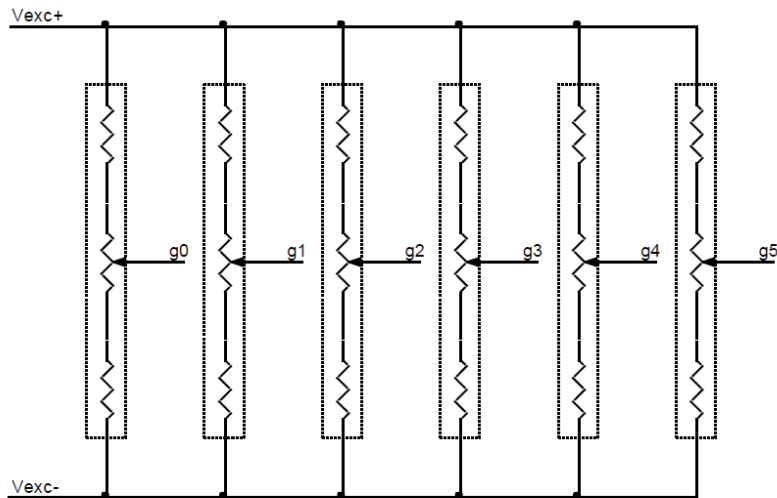

6.4 Appendix D—Resolution

ATI's transducers have a three sensing beam configuration, where the three beams are equally spaced around a central hub and attached to the outside wall of the transducer. This design transfers applied loads to multiple sensing beams and allows the transducer to increase its sensing range in a given axis if a counterpart axis has reduced loading (for compound loading information, refer to the F/T Transducer manual).

The resolution of each transducer axis depends on how the applied load is spread among the sensing beams. The best resolution occurs in a scenario when the quantization of the gages is evenly distributed as load is applied. In the worst case scenario, the discrete value of all involved gages increases at the same time. The typical scenario will be somewhere in between the two aforementioned scenarios.

F/T resolutions are specified as typical resolution, defined as the average of the worst and best case scenarios. Because both multi-gage effects can be modeled as a normal distribution, this value represents the most commonly perceived, average resolution. The DAQ F/T resolutions are based on real-number calculations and do not result in clean fractions. To express the values as clean fractions, use the best values achieved by a 16-bit data acquisition system. Although this misrepresents the actual performance of the transducers, it results in a close (and always conservative) estimate.

6.5 Appendix E—Detecting Sensitivity Changes

Sensitivity checking of the transducer can also be used to measure the transducer system's health. This can be done by applying known loads to the transducer and verifying the system output matches the known loads.

For example, for a transducer with an end-effector attached:

1. If the end-effector has moving parts, they must be moved in a known position.
2. Place the transducer in an orientation that allows the gravity load from the end-effector to exert load on many transducer output axes.
3. Record the output readings.
4. Position the transducer to apply another load, this time causing the outputs to move far from the earlier readings.
5. Record the second set of output readings.
6. Find the differences from the first and second set of readings and use it as your sensitivity value.

Even if the values vary somewhat from sample set to sample set, they can be used to detect gross errors. Either the resolved outputs or the raw transducer voltages may be used (the same must be used for all steps of this process).

6.6 Appendix F—Buffer Circuit

If a data acquisition system has an input impedance of 5 k Ω or less, implement an amplifier circuit or a simple follower to provide a high-impedance output. If designing a simple voltage follower, then enter a gain of 1 into the TWE calibration spreadsheet. Otherwise, measure the gain and offset of the circuit. The gain is the ratio of Δ output \div Δ input.

7. Terms and Conditions of Sale

The following Terms and Conditions are a supplement to and include a portion of ATI's Standard Terms and Conditions, which are on file at ATI and available upon request.

ATI warrants to Purchaser that force torque sensor products purchased hereunder will be free from defects in material and workmanship under normal use for a period of one (1) year from the date of shipment. The warranty period for repairs made under a RMA shall be for the duration of the original warranty, or ninety (90) days from the date of repaired product shipment, whichever is longer. ATI will have no liability under this warranty unless: (a) ATI is given written notice of the claimed defect and a description thereof with thirty (30) days after Purchaser discovers the defect and in any event, not later than the last day of the warranty period and (b) the defective item is received by ATI not later than (10) days after the last day of the warranty period. ATI's entire liability and Purchaser's sole remedy under this warranty is limited to repair or replacement, at ATI's election, of the defective part or item or, at ATI's election, refund of the price paid for the item. The foregoing warranty does not apply to any defect or failure resulting from improper installation, operation, maintenance, or repair by anyone other than ATI.

ATI will in no event be liable for incidental, consequential, or special damages of any kind, even if ATI has been advised of the possibility of such damages. ATI's aggregate liability will in no event exceed the amount paid by the purchaser for the item which is the subject of claim or dispute. ATI will have no liability of any kind for failure of any equipment or other items not supplied by ATI.

No action against ATI, regardless of form, arising out of or in any way connected with products or services supplied hereunder, may be brought more than one year after the cause of action accrued.

No representation or agreement varying or extending the warranty and limitation of remedy provisions contained herein is authorized by ATI, and may not be relied upon as having been authorized by ATI, unless in writing and signed by an executive officer of ATI.

Unless otherwise agreed in writing by ATI, all designs, drawings, data, inventions, software, and other technology made or developed by ATI in the course of providing products and services hereunder, and all rights therein under any patent, copyright, or other law protecting intellectual property, shall be and remain ATI's property. The sale of products or services hereunder does not convey any expressed or implied license under any patent, copyright, or other intellectual property right owned or controlled by ATI, whether relating to the products sold or any other matter, except for the license expressly granted below.

In the course of supplying products and services hereunder, ATI may provide or disclose to Purchaser confidential and proprietary information of ATI relating to the design, operation, or other aspects of ATI's products. As between ATI and Purchaser, ownership of such information, including without limitation any computer software provided to Purchaser by ATI, shall remain in ATI and such information is licensed to Purchaser only for Purchaser's use in operating the products supplied by ATI hereunder in Purchaser's internal business operations.

Without ATI's prior written permission, Purchaser will not use such information for any other purpose or provide or otherwise make such information available to any third party. Purchaser agrees to take all reasonable precautions to prevent any unauthorized use or disclosure of such information.

Purchaser will not be liable hereunder with respect to disclosure or use of information which: (a) is in the public domain when received from ATI, (b) is thereafter published or otherwise enters the public domain through no fault of Purchaser, (c) is in Purchaser's possession prior to receipt from ATI, (d) is lawfully obtained by Purchaser from a third party entitled to disclose it, or (f) is required to be disclosed by judicial order or other governmental authority, provided that, with respect to such to maintain the confidentiality of such information.