



# SCREEN

Façade and glass roof awnings

MICRO 850 (Z) / 1000 (Z) – 4000 Z



*Just  
enjoy life!*

**Lewens**  
MARKISEN

# A CLEAR VIEW OF EVERYTHING

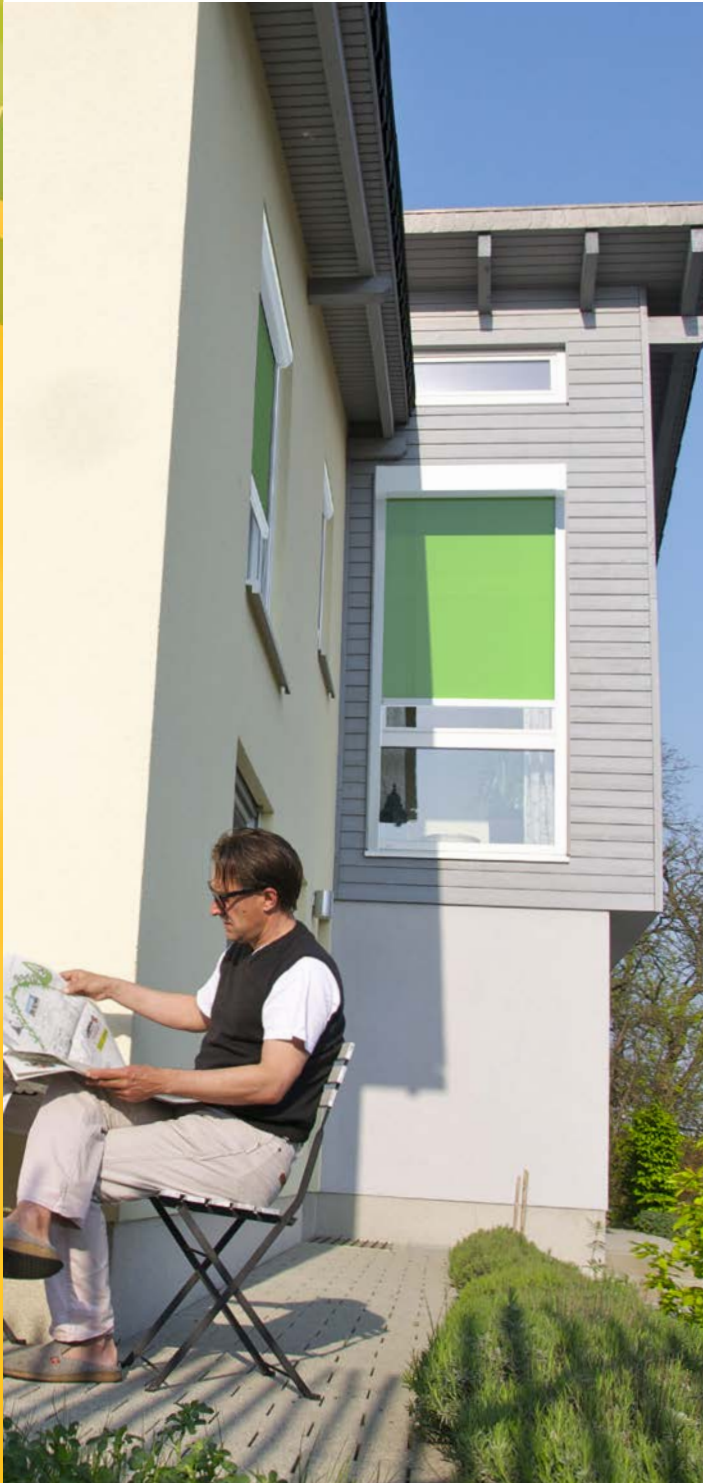

It's nice to chat across the garden fence, but nicer still to retain the privacy of one's personal domain indoors or on the patio. Awnings with a semi-transparent screen create the perfect solution, providing efficient protection from the heat, glare and prying eyes while offering an unobstructed view of the outside.

# The guide type holds the key

Vertical awnings with heavy awning materials such as screen, Soltis or blackout fabrics that are also exposed to increased wind pressure call for a robust, carefully conceived design and secure guidance. Lateral guide tracks provide the awning with a stable frame. On models with a “closed” lateral guide (types with the “Z” suffix) the awning fabric is mounted and guided using the zipper system.

Choose your individual privacy and sun protection from the following models to meet your personal requirements and to suit your house or glass roof with regard to format and design. Like all Lewens awnings, they are manufactured with centimetre accuracy:

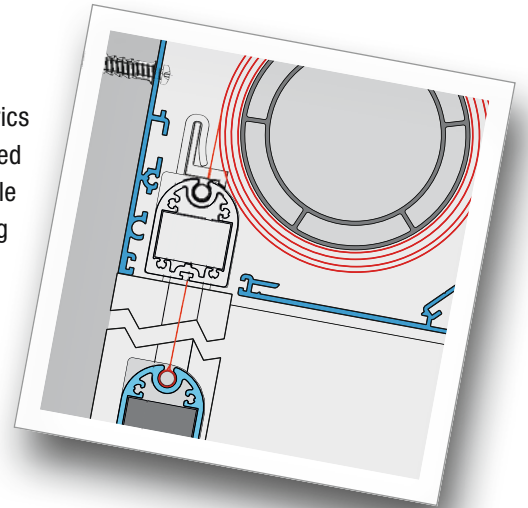

## MICRO 850 (Z) / 1000 (Z)

### Vertical awning

especially for use with **glass fibre screen fabric**, **Soltis 92** or blackout fabric.

Optionally with **laterally open or closed guidance (Z)**.

Max. 300 or 400 cm width  
and max. 250 or 375 cm height  
(depending on model and type).\*

Linked units possible.

Read **more on page 4**.

## MICRO 4000 Z

The **vertical awning for large single-unit widths**, especially for use with **glass fibre screen fabric**.

Always with **laterally closed guidance (Z)**.

Max. 550 cm width (up to 300 cm in height)  
or 600 cm height (up to 300 cm in width).\*

Read **more on page 6**.

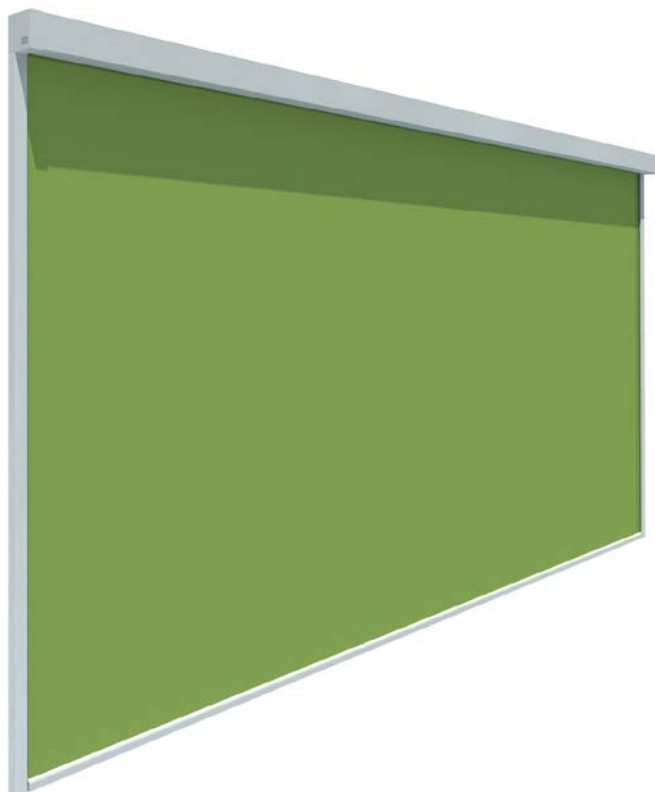

# MICRO 850 MICRO 1000

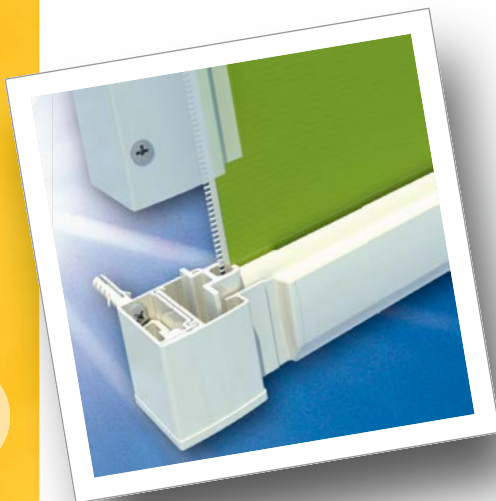

The MICRO 850/1000 vertical awning will enhance your façade, conservatory or glass roof in several ways – perfect shade from the sun and glare, a sophisticated decorative feature, and a special quality of light while retaining the view.

The Micro 850/1000 was developed especially for use with conservatories, windows and loggias. It features a lateral guide track and a compact cassette, which offers optimum protection for the awning fabric when closed.

Choose from the **open** or **closed lateral guide** model depending on your requirements and opt for **additional features** for even greater comfort.

The specification includes **electric motor operation**. Manual crank operation from inside or outside is also possible on request (reduced price).

## Options

- ▶ **Radio remote control**
- ▶ **Automatic weather monitoring**



# VERTICAL SCREEN AWNING



- ▶ The **MICRO 850** and **850 Z\*** have cassette dimensions of 86.5 x 87.5 mm.  
**Panel width**, 1 panel, motor drive:  
 MICRO 850 max. 300 cm  
 MICRO 850 Z max. 275 cm  
**Unit height**, motor drive:  
 MICRO 850 max. 250 cm  
 MICRO 850 Z max. 175 cm

- ▶ The **MICRO 1000** and **1000 Z\*** have cassette dimensions of 101.5 x 102.5 mm.  
**Panel width**, 1 panel, motor drive:  
 max. 400 cm  
**Unit height**, motor drive:  
 MICRO 1000 max. 375 cm  
 MICRO 1000 Z max. 350 cm

- ▶ **Awning fabrics** in a wide range of colours:
 
  - Glass fibre **screen fabric** (Sergé)
  - **Soltis 92** (extra charge)
  - **Blackout fabrics** (extra charge)



*Optional vertical awnings on the front offer shade from the sun and privacy*

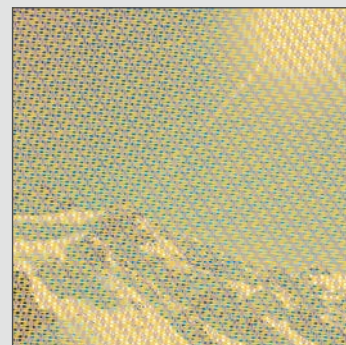

*Glass fibre screen fabric for sun and glare protection with a view to the outside.*

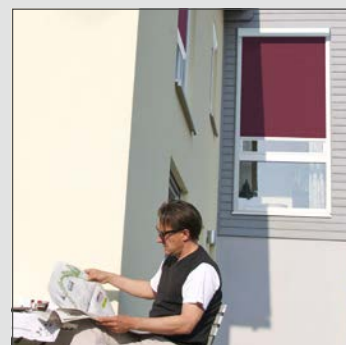

*The MICRO 850/1000 is a window awning that blends harmoniously into the façade.*

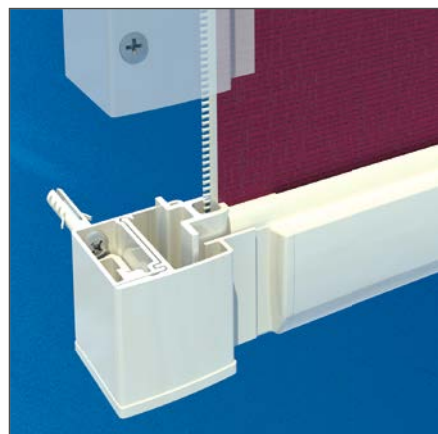

*CLOSED GUIDE type*

*OPEN GUIDE type*

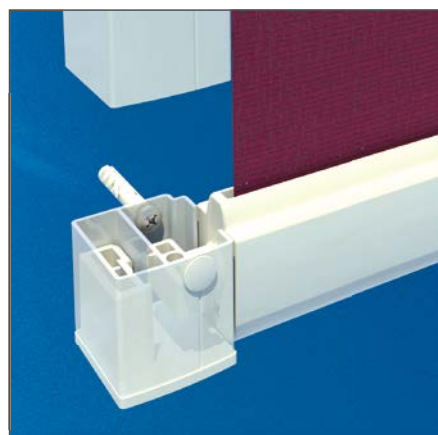

## CLOSED GUIDE TYPE (Z)

On the MICRO 850 Z and 1000 Z types, the fabric runs in a lateral guide (zipper method).

**Wind protection:** The lateral attachment reliably prevents excessive flapping caused by the wind.

**Sun protection:** In addition, the fabric and lateral guide tracks form an integral unit. This prevents any slits of light from penetrating at the side.

**Insect barrier:** The lateral guide also prevents the ingress of leaves and insects.

## OPEN GUIDE TYPE

On the MICRO 850 and 1000 types, the awning fabric is extended “open”, i.e. without any lateral guide.



*The compact dimensions and modern design of the cassette will grace any façade.*



*Lateral track and bottom profile form a unified whole visually.*

\* Please refer to the technical data in the current Lewens price list for possible dimensions and restrictions.

# MICRO 4000 Z



*“... sunshine and privacy tailored to our requirements!”*

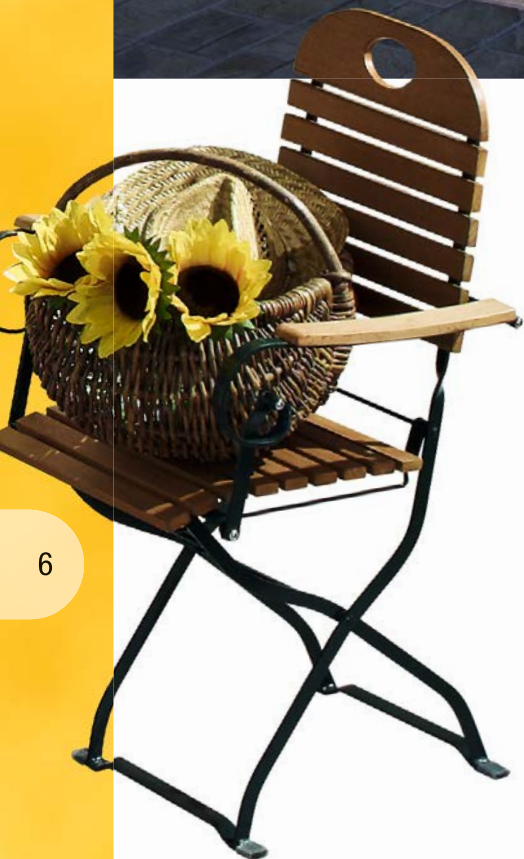

No matter how much we love the sun, sometimes it is simply too much. When it is low in the sky, the MICRO 4000 Z offers the perfect protection from sun and glare as well as creating a special quality of light. And the best thing about it is that you retain the view thanks to the screen fabric!

At widths of up to 550 cm and heights of up to 600 cm the Micro 4000 Z vertical awning is especially suitable for large windows and transits on glass roofs and conservatories. It has been specially developed for these applications and is equipped with a lateral guide track, into which the fabric is inserted like a zip. \*

This awning is operated by **electric motor**. For even greater convenience you can choose other **additional features** to suit your requirements:

## Options

- ▶ **Radio remote control**
- ▶ **Automatic weather monitoring \***

\* Please refer to the technical data in the current Lewens price list for possible dimensions and restrictions and for the complete list of electronic accessories.



## VERTICAL SCREEN AWNING

When closed, the compact cassette offers optimal protection for the awning fabric and mechanism. With a cassette that is just 15 cm high, straight lines and flat clip-on end caps, the MICRO 4000 Z is also ideal for installation in niche locations.



*Mounting on the house wall  
or in the window surround (niche installation)*

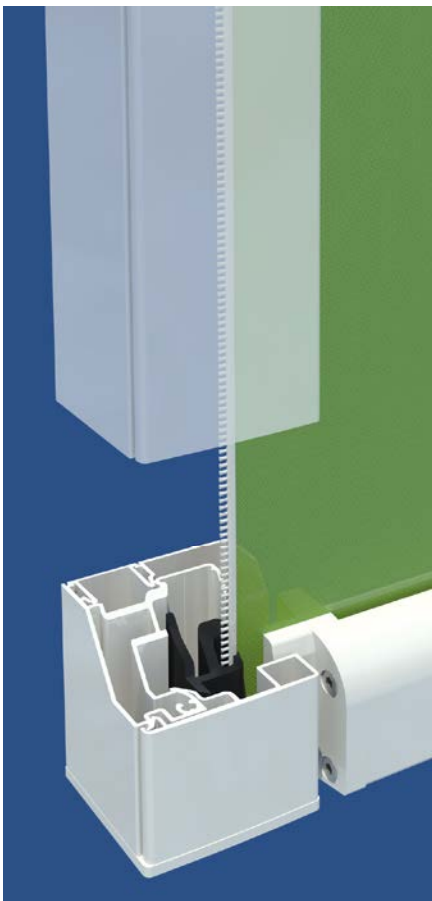

## CLOSED GUIDE TYPE (Z)

On the Micro 4000 Z awning, the fabric runs in a lateral guide (zipper method).

**Wind protection:** The lateral attachment reliably prevents excessive flapping caused by the wind.

**Sun protection:** In addition, the fabric and lateral guide tracks form an integral unit, preventing any slits of light from penetrating at the side.

**Insect barrier:** When used as a window awning, the screen fabric acts virtually as a fly screen if the bottom profile sits flush against the sill, permitting ventilation while largely preventing the ingress of leaves and insects.



*The front profile disappears completely into the cassette when the awning is retracted.*

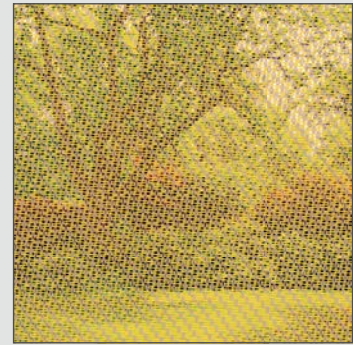

*Glass fibre screen fabric for protection against sun and glare while retaining the view outwards.*



*The perfect complement to a conservatory or glass roof.*

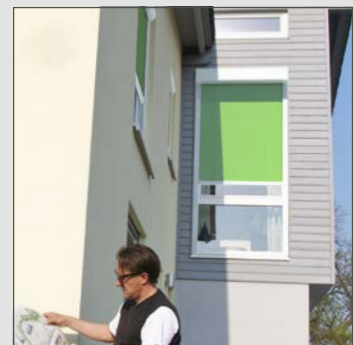

*Blends harmoniously into the façade when used as a window awning.*

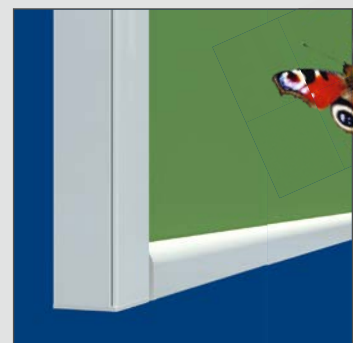

*The lateral track and bottom profile form a unified whole visually.*

# TECHNICAL DATA

## MICRO 850/1000 – MICRO 4000 Z

MODEL	MICRO 850 VERTICAL SCREEN AWNINGS		MICRO 1000 VERTICAL SCREEN AWNINGS		MICRO 4000 Z VERTICAL SCREEN AWNINGS
	850 OPEN	850 Z CLOSED	1000 OPEN	1000 Z CLOSED	4000 Z CLOSED
<b>Panel widths Motor drive</b>	max. 300 cm	max. 275 cm	max. 400 cm	max. 400 cm	max. 550 cm (up to 300 cm height)
1 panel					
2 panels	–	–	800 cm	800 cm	
<b>Unit heights Motor drive</b>	max. 250 cm	max. 175 cm	max. 375 cm	max. 350 cm	max. 600 cm (up to 300 cm wide)
<b>Panel widths Crank drive</b>	max. 300 cm	max. 200 cm	max. 340 cm	max. 200 cm	
1 panel					
<b>Unit heights Crank drive</b>	max. 200 cm	max. 175 cm	max. 200 cm	max. 200 cm	

**Centimetre-accurate manufacture** in all intermediate widths and heights!

<b>Drive</b>	<ul style="list-style-type: none"> <li>– <b>Motor drive (electric motor)</b></li> <li>– Crank drive with worm gear possible on request (reduced price), optionally for external operation or internal operation (crank handle)</li> </ul>	– <b>Motor drive (electric motor)</b>
<b>Scope of supply, attachment</b>	Delivery <b>incl. lateral tracks</b> , no consoles required!	
<b>Framework colours</b>	<ul style="list-style-type: none"> <li>– <b>17 RAL colours</b> and <b>6 textured finishes</b> to choose from (see LEWENS price list for colour chart)</li> <li>– <b>Natural silver:</b> E6/EV 1 anodized; small components silver RAL 9006</li> <li>– Special RAL (extra charge)</li> <li>– Special colours and effect coatings on request</li> </ul>	
<b>Awning fabrics</b> <i>from the LEWENS collection</i>	<ul style="list-style-type: none"> <li>– <b>Glass fibre screen fabric (Sergé)</b></li> <li>– Blackout fabrics (extra charge)</li> </ul>	<ul style="list-style-type: none"> <li>– <b>Glass fibre screen fabric (Sergé)</b></li> </ul>
	– Soltis 92	<ul style="list-style-type: none"> <li>– Soltis 92</li> <li>– Branded acrylic</li> <li>– Branded polyester <i>(up to max. 300 x 300 cm, web processed horizontally)</i></li> </ul>
<b>Options</b>	<ol style="list-style-type: none"> <li>1. Radio remote control / electric motor with integral radio control</li> <li>2. Sun / wind monitoring</li> </ol>	

Please refer to technical data in the current Lewens price list for possible dimensions and restrictions and for the complete list of electronic accessories.

## CERTIFICATION



**CE Standard:** Look for the mark that guarantees the technical safety of our products.

**Branded goods from Germany:** Lewens awnings are manufactured and assembled in Germany – quality “made in Germany”!



# FITTING and operation

## MICRO 850 (Z) / 1000 (Z)

The guide tracks of the MICRO 850 (Z) / 1000 (Z) are attached to the wall, the cassette is mounted on top.

The MICRO 850 (Z) / 1000 (Z) is supplied as standard with motor drive.

If you prefer a crank drive instead (reduced price), you can choose either external or internal operation (with crank handle).

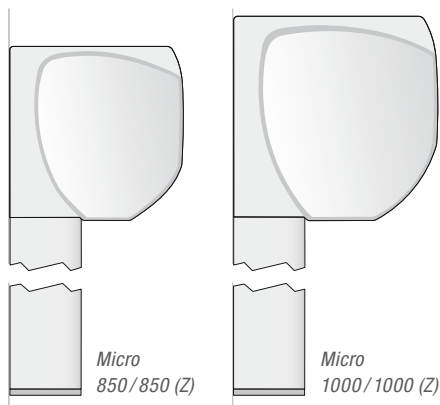

MICRO 850/850 (Z)

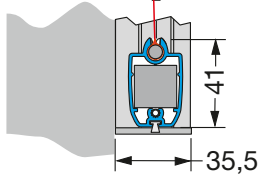
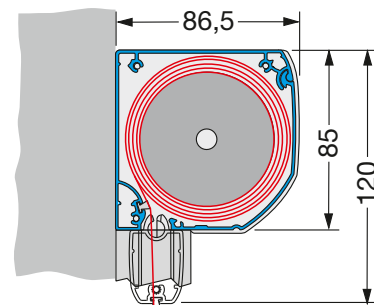

Wall attachment of lateral tracks (top view)

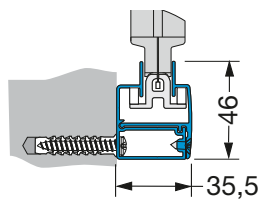

MICRO 1000/1000 (Z)

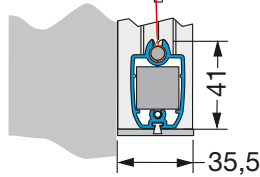
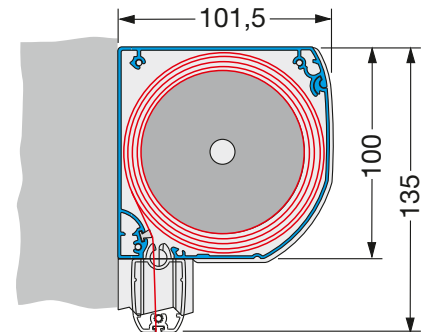

Wall attachment of lateral tracks (top view)

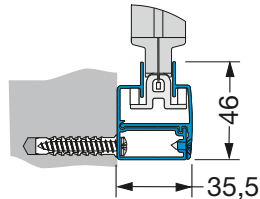

## MICRO 4000 Z

On the Micro 4000 Z, the cassette and guide tracks are attached directly to the wall or mounting base without consoles.

The screw positions for the cassette and guide tracks are freely selectable, making installation easier.

Variable tensioning of the fabric in the lateral guides permits a tolerance of up to 15 mm on each side.

The MICRO 4000 Z is supplied as standard with motor drive.

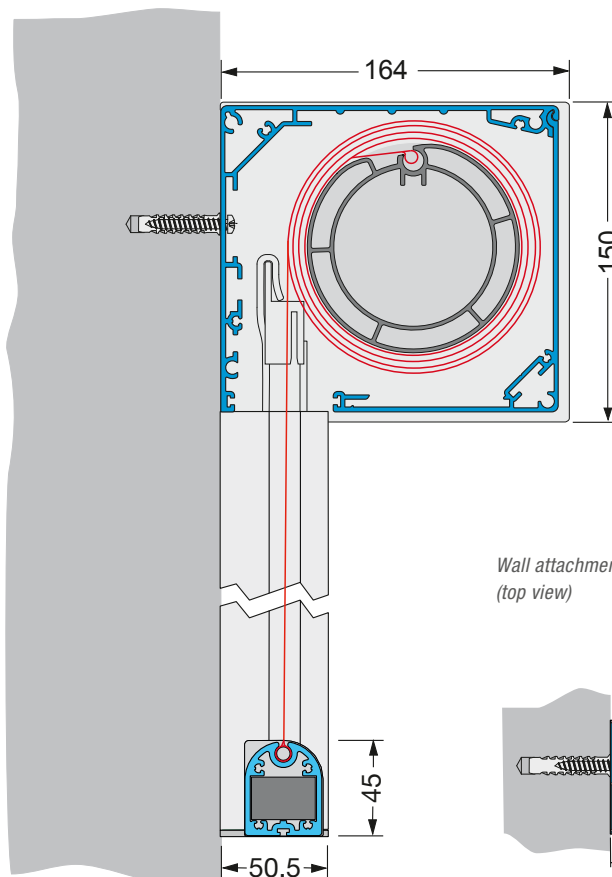

Wall attachment of lateral tracks (top view)

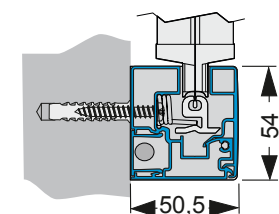

# SOLAR WORLDS



## **Voilà, sunshine à la carte!**

Click through the Lewens solar worlds and choose your own personal sun protection made to measure, with plenty of accessories for even greater pleasure from life.

[www.lewens-markisen.de](http://www.lewens-markisen.de)

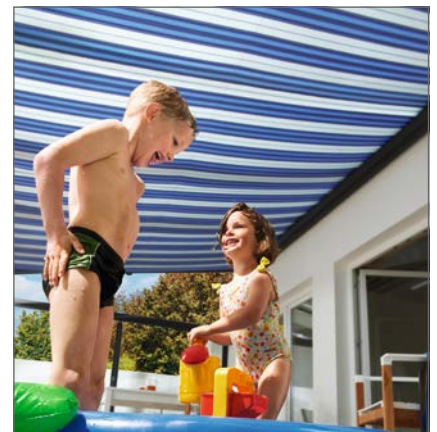
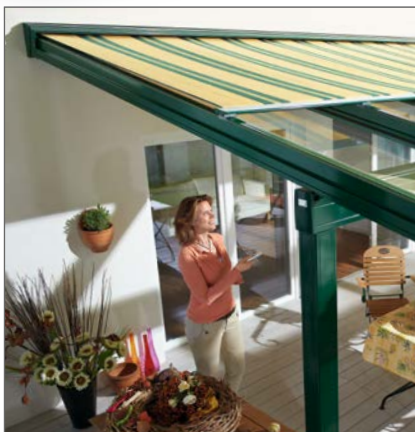

## FRAME COLOURS

Lewens offers a wide range of **standard frame colours at no extra charge** for all awning models (exception: Economy):

STANDARD RAL		
	1015	Light ivory
	3002	Carmine red
	3003	Ruby red
	3004	Purple red
	5002	Ultramarine blue
	5005	Signal blue
	6005	Moss green
	6009	Fir green
	7016	Anthracite grey
	7024	Graphite grey
	8019	Grey brown
	8077	Dark brown
	9001	Cream
	9006	White aluminium
	9007	Grey aluminium
	9010	Pure white
	9016	Traffic white
STANDARD TEXTURED FINISHES		
	Textured finish RAL 7016	Anthracite grey, fine texture, matt
	Textured finish RAL 9005	Jet black, fine texture, matt
	Textured finish RAL 9007	Grey aluminium fine texture, matt
	Textured finish SL 92	Terra / brown
	Textured finish SL 93	Grey / marble
	Textured finish SL 94	DB 703 fine texture
NATURAL SILVER		
	E6/ EV1	Silver anodized, small components silver RAL 9006 powder-coated

(Colour differences may result from the printing process.)

SPECIAL COLOURS	
<b>Special RAL</b> (please see current Lewens price list for selection)	Extra charge
<b>Special colours and effect finishes:</b> – all non-listed RAL colours – fine and coarse texture – metallic finishes – pearlescent/glimmer-effect finishes – NCS colours	On request

## AWNING FABRICS



With more than 300 samples to choose from, the Lewens collection offers you acrylic and polyester fabrics and also air-permeable screen and Soltis woven fabrics across the entire colour spectrum.

Lewens awning fabrics have been created especially to provide shade outdoors and are treated to make them water- and dirt-repellent. We make the awnings up using the latest sewing techniques for distortion-free seams and also using ultrasonic bonding. We have designed our manufacturing facility so that the awning fabrics can be laid out entirely flat (not folded) for making up.

### Some of our quality features:

- Secure lockstitch used for making up, optionally also with ultrasonically bonded seam (surcharge).
- Awning and valance are produced from one piece (identical repeat pattern)
- Seams on top and bottom and valance seam neatened (clean completion)
- Repeat-symmetrical completion left and right
- Use of Tenara® quality sewing yarn



No matter which fabric you choose from the Lewens collection, top-class fabrics, high-quality materials and a modern assembly method will guarantee you many years of pleasure from your awning.

# WE GUARANTEE



**Advanced technology, high-quality materials and outstanding workmanship in manufacturing guarantee that quality products from Lewens will give reliable operation and pleasure for many years.**

Beyond the implied warranty, Lewens offers an extraordinary long-term guarantee for its sunshade systems via its specialist contractors:

- ▶ **5-year guarantee** on all parts of sunshade systems from Lewens
- ▶ **2-year guarantee** on motors, electric control systems and coatings on awning frames

*You can find details of the guarantee scope and services in the current Lewens price list. Please ask your dealer for a copy.*



## L.UST FOR LIFE

*means being able to enjoy the summer outdoors without fear of sunburn, well protected against the heat and glare. Lewens awnings don't just provide shade, they are capable of more: they help us to enjoy the best aspects of summer.*

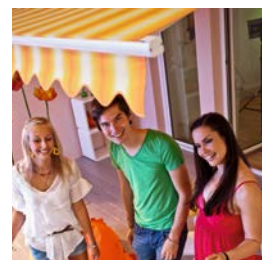

## I.NTELLIGENCE

*isn't just in the head. Sometimes it is to be found elsewhere, in the technical details and workmanship of high-quality Lewens awnings – so that you, the user, can operate our products without any problems and can find a suitable solution for any task.*

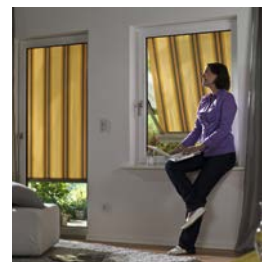

## F.REEDOM

*always has something to do with freedom of choice. Whether it's an awning for a small balcony or large patio or solutions for your conservatory that you need, Lewens specialist dealers provide professional advice and assembly. They are also happy to help you choose the colours and fabrics – so that you are entirely satisfied with every aspect of your awning!*

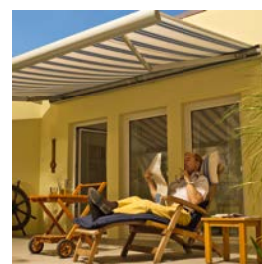

## E.ASY LIVING

*is now more in demand than ever. Everyday life is stressful enough, the world turns ever faster and the pace of news quickens. It's good to have time to unwind and be able to relax with family and friends. It is precisely for these valuable occasions that we have created our awnings.*

Your stockist will be happy to advise you:



**Lewens**  
MARKISEN

*Just  
enjoy life!*

[www.lewens-markisen.de](http://www.lewens-markisen.de)

