

FABRICATION OF PANTOGRAPH MILLING MACHINE

Mehul V. Patel

B.E Mechanical, Mechanical Engineering Department, S.B. Polytechnic, K.J Campus, Savli, Gujarat, India

ABSTRACT

This project namely Pantograph Milling Machine (PMM) is designed and fabricated mainly to cut wood, plastics, mild steel plates in to any shapes with desired accuracy and precision. The Pantograph consists of the traditional cutting equipment along with a pantograph which is a Mechanical linkage connected in a manner based on parallelograms and used for copying and scaling line drawings. The working principle of pantograph milling machine based on four bar mechanism in which one link is fixed and other links are pivoted and these other links moves according to the movement of the tracing link. This is low cost and high valuable equipment. In this project, a model of the Pantograph milling machine will be designed using CAD packages like AutoCAD, pro- e etc. taking into consideration of commercially available components. Care has been taken in the fabrication of components. Because the lack of accuracy in fabricated components would lead to a diminished performance of the machine.

Keyword: - pantograph, milling, engraving, degree of freedom, kinematic analysis etc.

1. INTRODUCTION

A pantograph is a system of mechanical linkages which reproduces the motion of one point of the linkage at a second point, usually at an increased or decreased size. It originated in the 17th century, and while it's most familiar application has probably been as a mechanical drawing instrument, it appears throughout engineering. The so-called "parallel motion" of James Watt's steam engines, for example, employs a pantograph mechanism for the transmission of power and motion.

“The pantograph is a movable framework – a parallelogram with two arms extending out, hinged in a fashion similar to a trellis or a folding gate. It is used to make scale copies of two-dimensional figures. When the stylus at the center of the pantograph is manipulated, an arm with an attached pen mimics the motion, exactly copying the shape. The framework can be adjusted so that the pen covers a longer or shorter distance than the stylus while maintaining shape and proportion, meaning that copies can be made smaller or larger than the original.”

“An instrument for copying plans, maps, and other drawings, on the same, or on a reduced or an enlarged, scale.”

“A pantograph engraving machine, or pantograph engraver, is a pantograph which uses a cutting tool at one position on the pantograph's mechanism to engrave (cut) into a work piece a design traced out by a tracer or stylus at another position on the mechanism. The cutting tool is most frequently either a sharp scribe fixed to the mechanism or a rotary cutter.”

“An instrument for copying a plane figure to a desired scale, consisting of styluses for tracing and copying mounted on four jointed rods in the form of a parallelogram with extended sides.”

Milling is the machining process of using rotary cutters to remove material from a work piece advancing (or feeding) in a direction at an angle with the axis of the tool. It covers a wide variety of different operations and machines, on scales from small individual parts to large, heavy-duty gang milling operations. It is one of the most commonly used processes in industry and machine shops today for machining parts to precise sizes and shapes.

2. MECHANISM

A pantograph is a mechanical linkage connected in a manner based on parallelograms so that the movement of one pen, in tracing an image, produces identical movements in a second pen. If a line drawing is traced by the first point, an identical, enlarged, or miniaturized copy will be drawn by a pen fixed to the other.

Because of their effectiveness at translating motion in a controlled fashion, pantographs have come to be used as a type of motion guide for objects large and small. A common example of the use of a pantograph assembly as mechanical guide frame is the extension arm of an adjustable wall-mounted mirror.

2.1 Link

A link or element need not to be a rigid body, but it must be a resistant body. A body is said to be a resistant body if it is capable of transmitting the required forces with negligible deformation. Thus a link should have the following two characteristics:

1. It should have relative motion, and
2. It must be a resistant body.

2.2 Types of Links

The usual types of joints in a chain are

- Binary link
- Ternary link
- Quaternary link

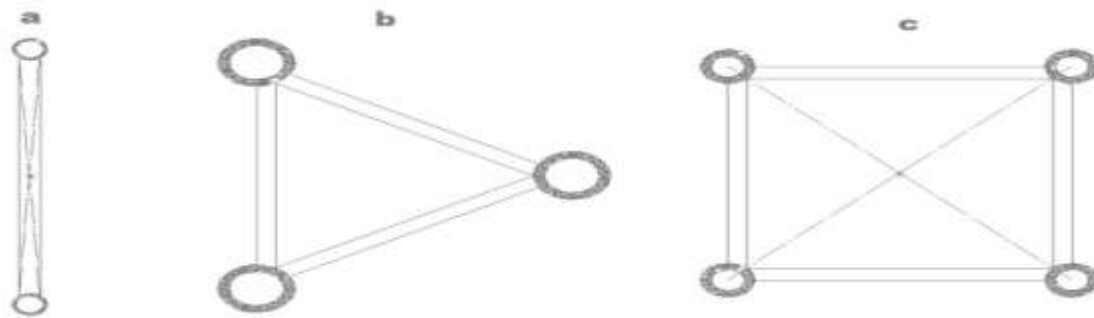

Figure 1: Binary, Ternary, Quaternary Link

- **Binary link:** If two links are joined at the same connection; it is called a binary joint and is shown in fig. 1 (a).
- **Ternary link:** If three links are joined at a connection, it is known as a ternary joint and is shown in fig. 1(b). It is considered equivalent to two binary joints since fixing of any one link constitutes two binary joints with each of the other two links.
- **Quaternary link:** If four links are joined at a connection, it is known as a quaternary joint and is shown in fig. 1(c). It is considered equivalent to three binary joints since fixing of any one link constitutes three binary joints.

2.3 Degrees of Freedom

It is defined as the number of input parameters which must be independently controlled in order to bring the mechanism in to useful engineering purposes.

It is also defined as the number of independent relative motions, both translational and rotational, a pair can have.

Degrees of freedom = 6 – no. of restraints.

To find the number of degrees of freedom for a plane mechanism we have

Grubler's equation $F = 3(n - 1) - 2j_1 - j_2$

F = Mobility or number of degrees of freedom

n = Number of links including frame

j_1 = Joints with single (one) degree of freedom

j_2 = Joints with two degrees of freedom

$F > 0$, results in a mechanism with 'F' degrees of freedom

$F = 0$, results in a statically determinate structure
 $F < 0$, results in a statically indeterminate structure.

3. BRIEF ABOUT PANTOGRAPH MILLING MACHINE AND DEVELOPMENT

A pantograph is a mechanical linkage connected in a manner based on parallelograms so that the movement of one pen, in tracing an image, produces identical movements in a second pen. If a line drawing is traced by the first point, an identical, enlarged, or miniaturized copy will be drawn by a pen fixed to the other. Using the same principle, different kinds of pantographs are used for other forms of duplication in areas such as sculpture, minting, engraving and milling.

Because of the shape of the original device, a pantograph also refers to a kind of structure that can compress or extend like an accordion, forming a characteristic rhomboidal pattern. This can be found in extension arms for wall-mounted mirrors, temporary fences, scissor lifts, and other scissor mechanisms such as the pantograph used in electric locomotives and trams.

Before the advent of control technologies such as numerical control (NC and CNC) and programmable logic control (PLC), duplicate parts being milled on a milling machine could not have their contours mapped out by moving the milling cutter in a "connect-the-dots" ("by-the-numbers") fashion. The only ways to control the movement of the cutting tool were to dial the positions by hand using dexterous skill (with natural limits on a human's accuracy and precision) or to trace a cam, template, or model in some way, and have the cutter mimic the movement of the tracing stylus. If the milling head was mounted on a pantograph, a duplicate part could be cut (and at various scales of magnification besides 1:1) simply by tracing a template. (The template itself was usually made by a tool and die maker using tool room methods, including milling via dialing followed by hand sculpting with files and/or die grinder points.) This was essentially the same concept as reproducing documents with a pen-equipped pantograph, but applied to the machining of hard materials such as metal, wood, or plastic. Pantograph routing, which is conceptually identical to pantograph milling, also exists (as does CNC routing).

The development and dissemination throughout industry of NC, CNC, PLC, and other control technologies provided a new way to control the movement of the milling cutter: via feeding information from a program to actuators (servos, selsyns, lead screws, machine slides, spindles, and so on) that would move the cutter as the information directed. Today most commercial machining is done via such programmable, computerized methods. Home machinists are likely to work via manual control, but computerized control has reached the home-shop level as well (it's just not yet as pervasive as its commercial counterparts). Thus pantograph milling machines are largely a thing of the past. They are still in commercial use, but at a greatly reduced and ever-dwindling level. They are no longer built new by machine tool builders, but a small market for used machines still exists. As for the magnification-and-reduction feature of a pantograph (with the scale determined by the adjustable arm lengths), it is achieved in CNC via mathematic calculations that the computer applies to the program information practically instantaneously. Scaling functions (as well as mirroring functions) are built into languages such as G-code.

3.1 Project Objective

Construct a pantograph and use it to draw similar figures (reduced or enlarged). A pantograph is an instrument used to copy line drawings or pictures, and enlarging or reducing them as you draw. The pantograph in this exercise will allow you to double the size of your picture and it is shown in fig. 2.

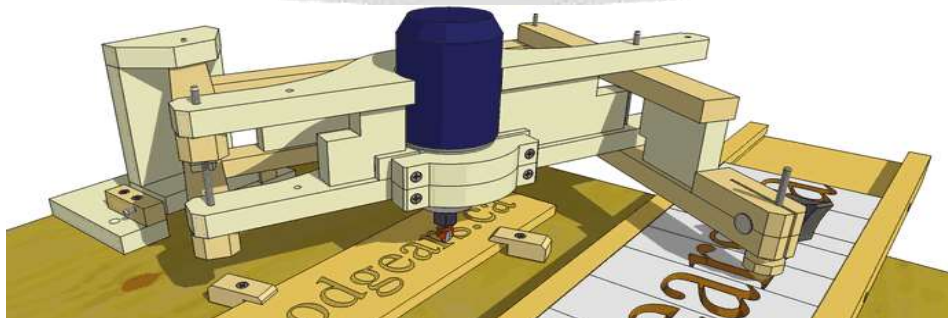

Figure 2: Pantograph Mechanism

3.2 Scope of Project

In the present era of production and manufacturing a large variety of components there should be the necessity for large industries with highly qualified personnel. Now days the competitors are increased and to stand among the competitor requires some ideas in the production and manufacturing facilities that leads the company to earn more profit with less effort. Pantograph milling machine is the machine which is manually operated and is used for cutting M.S plate in a short duration with variety of geometries and shapes. Also the cost of operation is less which leads to more economical. This kind of machine is used in almost all fabrication industries where there is a need to cut the M.S plate which may be require for various production purposes. The project has been innovated by means of initiating the various ideas from our project which makes us to design and fabricate the machine in a right manner.

In modern times, the word pantograph has taken additional meanings. Due to its resemblance to the drafting tool, the diamond shaped framework on the roof of an electric train or trolley that connects to the overhead power lines is also called a pantograph.

4. WORKING PRINCIPAL

4.1 Working Principle of pantograph

The working principle of pantograph milling machine is mainly based on the four bar mechanism in which one link is fixed and other links are pivoted and these other links moves according to movement of stylus it is shown in fig. 3.

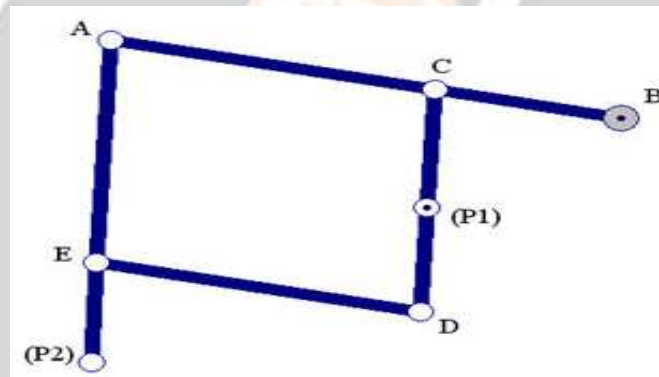

Figure 3: Four Bar Mechanism

In figure:

Point B is fixed.

Points A, C, D, and E are pivot points.

Point P2 is cutting point.

Point P1 is pencil point.

4.2 Brief Working of Machine

A pantograph machine can be helpful for people who enjoy projects like patch work, woodworking and modeling. We can also enlarge or reduce the drawing two, three, four or even five times the original size.

But pantograph milling machine is working based on the same principle as that of the pantograph engraving machine. In the pantograph milling machine the milling cutter or the milling tool is used instead of the pen (tracing point) then the same pantograph are also used for grinding, engraving and milling. The working of this pantograph machine is simple and is mainly based on the four bar mechanism in which the four links are arranged according to some designed mechanism. In this machine there is one fixed link and manually the movement is given to the other line joined with the fixed link. Due to this movement and according to the pantograph mechanism the link with the attached cutting tool makes the movement with defined scale used. The cutting tool is fixed with the motor in such a way that it can rotate freely.

In 2-D machines, the cutting tool moves in a plane, and the depth of the engraving is controlled by the depth setting of the cutter. This depth is commonly set up and held constant for any given engraving operation. Some 2-D engraving machines have attachments which allow 2-D engraving of contoured surfaces of 3-D work pieces, usually within relatively narrow limits. These options need not be considered here.

In 3-D machines, the tracing stylus and cutting tool both move in three dimensions within relatively wide limits. 3-D pantograph engravers were commonly used for the manufacture of stamping dies. When they operate at a scale of 1:1 they are often called "die sinking" machines. Various mechanisms were used for achieving 3-D capability; the "ratio bar" method of Gorton machines was particularly sophisticated. It is of course possible to do 2-D work on a 3-D machine.

4.3 Main Parts of Machine

- Work Table
- Links
- Stylus (Cutting tool)
- Pencil
- Motor
- Clamping screw

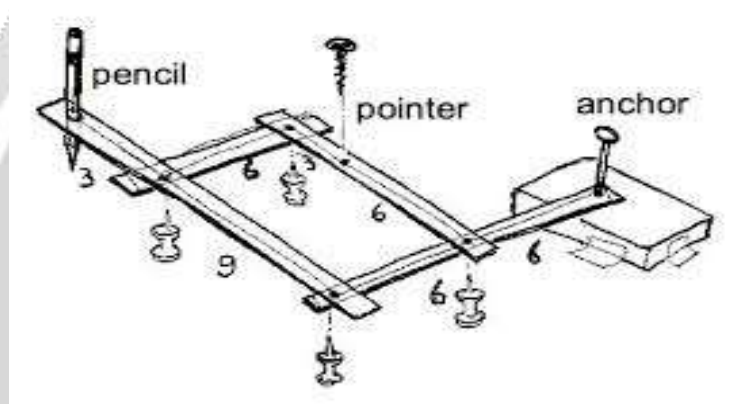

Figure 4: Parts of Machine

4.4 Application

- This machine can be used almost in all types of industries. (Large, small, medium scale industries).
- This machine is mainly used in fabrication oriented industries.
- The material can be removed at any shape like oval, rectangular, ellipse, square, circular, pentagon, hexagon shapes etc.
- This machine is used to guide the cutting tools.
- This machine is used for reproduction of maps and plans on enlarged or reduced scale.
- A modified pantograph is used to collect the electric power at the top of an electric locomotive (e.g. electric train)

4.5 Advantage of Pantograph

- Setting of machine is easy.
- It reduces the fatigue of the worker.
- Skilled labor is not required.
- Labor cost is less.
- Production cost decreases.
- Machine looks compact in size, so it can be carried from one place to another place.
- The process is most economical.

4.6 Modeling a Pantograph

A pantograph is a simple mechanical device that uses two pens to copy and enlarge or reduce drawings or maps. Thomas Jefferson made one, hoping he could use it to write more than one letter at a time. Then, if you're brave and if you have enough time, you'll construct a model that more closely resembles a physical pantograph is shown in fig 5.

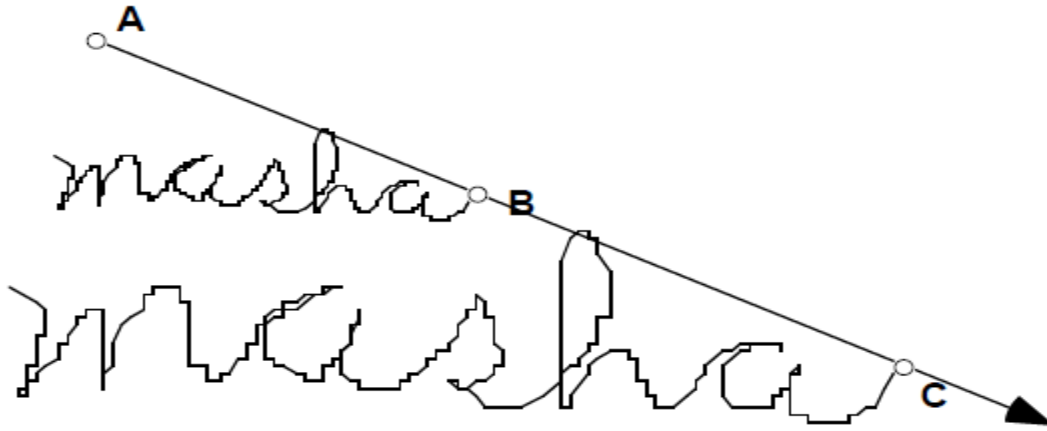

Figure 5: Concept of pantograph

4.7 Sketch and Investigate

1. Construct AB .
 2. Construct point C on AB , beyond point B .
 3. Select points B and C ; then, in the Display menu, turn on Trace Point.
 4. Drag point B to write your name.
 5. Measure AB and AC .
 6. Calculate AB/AC .
 7. Draw something with point B . Notice that point C moves on the ray so that the ratio AB/AC stays constant.
 8. Move point C to make a different ratio. Experiment drawing things with point B using different ratios.
- 5 What does the ratio have to do with the traces of points B and C ? An actual, physical pantograph is constructed of rigid material, such as strips of wood. These pieces don't stretch the way a dynamic Sketchpad ray does. So an actual pantograph depends on linkages that make inflexible.

The following pages describe a construction that models a physical pantograph.

- **Modeling a Pantograph (continued)**
- **Modeling an Actual Pantograph**

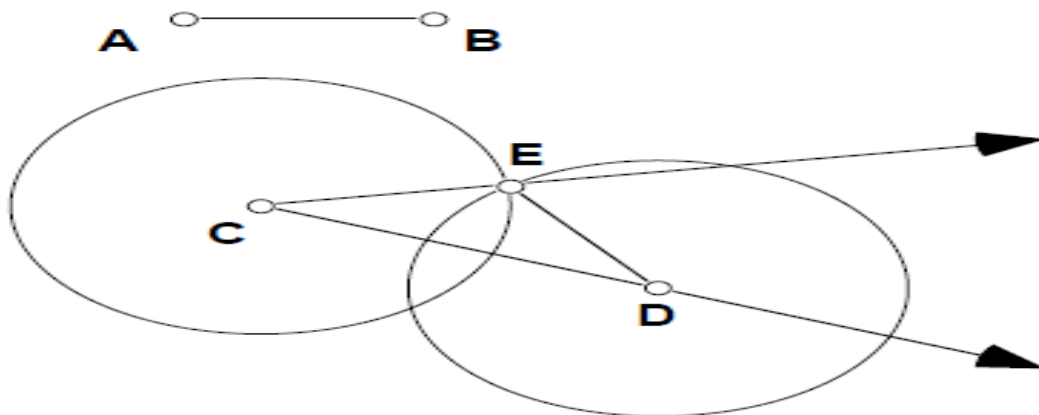

Figure 6: Construction of Pantograph (a)

9. In a new sketch, construct AB . (This is not part of the pantograph, but it's a control segment that will make parts of your pantograph both rigid and adjustable.)
10. Construct CD .
11. Construct a circle with CenterPoint C and radius AB .
12. Construct a circle with CenterPoint D and radius AB .
13. Construct point E at one intersection of these circles. (If the circles don't intersect, drag point D until they do.)
14. Construct CE .
15. Construct DE .

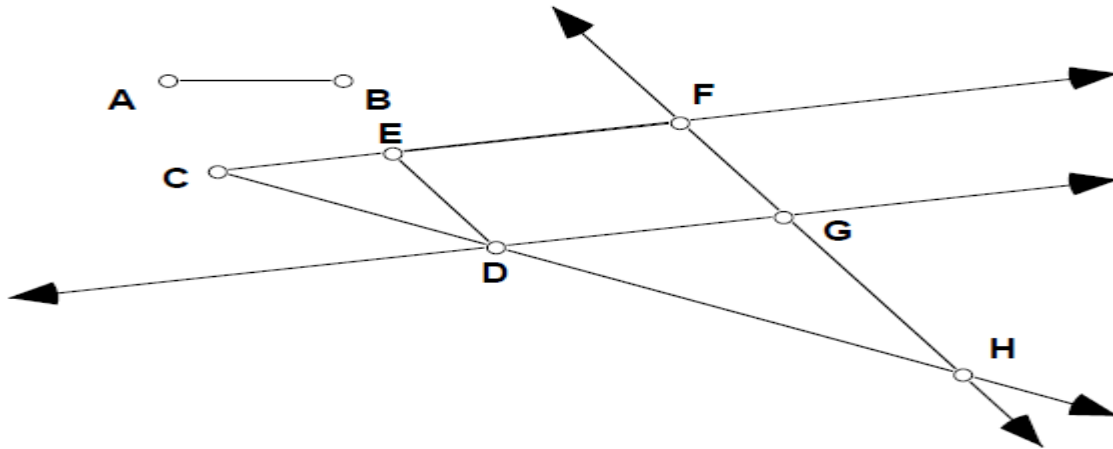

Figure 7: Construction of Pantograph9 (b)

16. Hide the circles.
17. Construct EF on CE .
18. Construct a line through point F parallel to DE .
19. Construct a line through point D parallel to CE .
20. Construct point G where these lines intersect.
21. Construct point H at the intersection of FG and CD .
22. Hide CE , CD , FG , and DG .
23. Construct CE , FG , DG , and GH . This is something like what a real pantograph looks like.

5. FINAL PROJECT

5.1 Specifications of Motor

| | |
|-----------------------|-------------|
| Rated Power Input | 350 W |
| No-Load Speed | 30000 r/min |
| Collet Chuck Capacity | 6.35 mm |
| Net Weight | 1.8 kg |

Table-1: Motor specification

5.2 Real world application of project

Pantograph milling machine is the machine which is manually operated and is used for cutting M.S plate in a short duration with variety of geometries and shapes. Also the cost of operation is less which leads to more economical. This kind of machine is used in almost all fabrication industries where there is a need to cut the M.S plate which may be require for various production purposes. The project has been innovated by means of initiating the various ideas from our project which makes us to design and fabricate the machine in a right manner.



Figure 8: Pantograph Milling Machine

6. CONCLUSION

Our work and the results obtained so far are very encouraging and reinforce the conviction that pantograph milling machine are practical and potentially very contributive to the production and manufacturing industries.

7. REFERENCES

- [1]. <https://en.wikipedia.org/wiki/Pantograph>
- [2]. Wang Hongguang, Zhao Mingyang, Fang Lijin, Li Shujun, Zhang Bo “The mechanism and kinematics of a 3-DOF in-parallel actuator manipulator” in Proceedings of the 2003 IEEE, International Conference on Robotics Intelligent Systems and Signal Processing, Changsha, China - October 2003
- [3]. Seon Joong Ryu, et al., Proc. Of the ASME, MED, V01.8, 1998
- [4]. R. S. Khurmi, J.K. Gupta, “Theory of Machines”, Edition : 2005e
- [5]. A. K. S. Kwan and S. Pellegrino, “A cable rigidized 3D pantograph,” Proc. of 4th European symposium on Mechanisms and Tribology, France, Sept. 1989 (ESA-SP-299, March 1990).
- [6]. Yavin, Y., (1998) ‘The control of a motion of a pantograph’ Mathematical computing Modelling, vol. 28, No.2, pp. 13-23.