



FAI Sporting Code

*Fédération
Aéronautique
Internationale*

Section 4 – Aeromodelling

Volume F3 Radio Control Soaring Model Aircraft

2020 Edition

Effective 1st January 2020

F3B – RC MULTI-TASK GLIDERS

F3F – RC SLOPE SOARING GLIDERS

F3J – RC THERMAL DURATION GLIDERS

F3K – RC HAND LAUNCH GLIDERS

F3G – RC MULTI-TASK GLIDERS WITH ELECTRIC MOTOR
(Provisional)

F3H – RC SOARING CROSS COUNTRY GLIDERS (Provisional)

F3Q – RC AERO-TOW GLIDERS (Provisional)

ANNEX 3A – RULES FOR WORLD CUP EVENTS

*Maison du Sport International
Avenue de Rhodanie 54
CH-1007 Lausanne
Switzerland
Tel: +41(0)21/345.10.70
Fax: +41(0)21/345.10.77
Email: sec@fai.org
Web: www.fai.org*

FEDERATION AERONAUTIQUE INTERNATIONALE

MSI - Avenue de Rhodanie 54 – CH-1007 Lausanne – Switzerland

Copyright 2020

All rights reserved. Copyright in this document is owned by the Fédération Aéronautique Internationale (FAI). Any person acting on behalf of the FAI or one of its Members is hereby authorised to copy, print, and distribute this document, subject to the following conditions:

- 1. The document may be used for information only and may not be exploited for commercial purposes.**
- 2. Any copy of this document or portion thereof must include this copyright notice.**
- 3. Regulations applicable to air law, air traffic and control in the respective countries are reserved in any event. They must be observed and, where applicable, take precedence over any sport regulations.**

Note that any product, process or technology described in the document may be the subject of other Intellectual Property rights reserved by the Fédération Aéronautique Internationale or other entities and is not licensed hereunder.

RIGHTS TO FAI INTERNATIONAL SPORTING EVENTS

All international sporting events organised wholly or partly under the rules of the Fédération Aéronautique Internationale (FAI) Sporting Code¹ are termed *FAI International Sporting Events*². Under the FAI Statutes³, FAI owns and controls all rights relating to FAI International Sporting Events. FAI Members⁴ shall, within their national territories⁵, enforce FAI ownership of FAI International Sporting Events and require them to be registered in the FAI Sporting Calendar⁶.

An event organiser who wishes to exploit rights to any commercial activity at such events shall seek prior agreement with FAI. The rights owned by FAI which may, by agreement, be transferred to event organisers include, but are not limited to advertising at or for FAI events, use of the event name or logo for merchandising purposes and use of any sound, image, program and/or data, whether recorded electronically or otherwise or transmitted in real time. This includes specifically all rights to the use of any material, electronic or other, including software, that forms part of any method or system for judging, scoring, performance evaluation or information utilised in any FAI International Sporting Event⁷.

Each FAI Air Sport Commission⁸ may negotiate agreements, with FAI Members or other entities authorised by the appropriate FAI Member, for the transfer of all or parts of the rights to any FAI International Sporting Event (except World Air Games events⁹) in the discipline¹⁰, for which it is responsible¹¹ or waive the rights. Any such agreement or waiver, after approval by the appropriate Air Sport Commission President, shall be signed by FAI Officers¹².

Any person or legal entity that accepts responsibility for organising an FAI Sporting Event, whether or not by written agreement, in doing so also accepts the proprietary rights of FAI as stated above. Where no transfer of rights has been agreed in writing, FAI shall retain all rights to the event. Regardless of any agreement or transfer of rights, FAI shall have, free of charge for its own archival and/or promotional use, full access to any sound and/or visual images of any FAI Sporting Event. The FAI also reserves the right to arrange at its own expense for any and all parts of any event to be recorded.

-
- 1 FAI Statutes, Chapter 1, para. 1.6
 - 2 FAI Sporting Code, Gen. Section, Chapter 4, para 4.1.2
 - 3 FAI Statutes, Chapter 1, para 1.8.1
 - 4 FAI Statutes, Chapter 2, para 2.1.1; 2.4.2; 2.5.2 and 2.7.2
 - 5 FAI By-Laws, Chapter 1, para 1.2.1
 - 6 FAI Statutes, Chapter 2, para 2.4.2.2.5
 - 7 FAI By-Laws, Chapter 1, paras 1.2.2 to 1.2.5
 - 8 FAI Statutes, Chapter 5, paras 5.1.1, 5.2, 5.2.3 and 5.2.3.3
 - 9 FAI Sporting Code, Gen. Section, Chapter 4, para 4.1.5
 - 10 FAI Sporting Code, Gen. Section, Chapter 2, para 2.2.
 - 11 FAI Statutes, Chapter 5, para 5.2.3.3.7
 - 12 FAI Statutes, Chapter 6, para 6.1.2.1.3

PAGE DELIBERATELY LEFT BLANK

VOLUME F3 SOARING
SECTION 4C – MODEL AIRCRAFT – F3 RADIO CONTROL SOARING

Part Five – Technical Regulations for Radio Controlled Contests

- 5.3 Class F3B – RC Multi-task Gliders
- 5.6 Class F3J – RC Thermal Duration Gliders
- 5.7 Class F3K – RC Hand Launch Gliders
- 5.8 Class F3F – RC Slope Soaring Gliders

Annex 3A – Rules for World Cup Events

Provisional Classes:

- 5.G.1 Class F3G – RC Multi-task Gliders with Electric Motor
- 5.H.1 Class F3H – RC Soaring Cross Country Gliders
- 5.Q.1 Class F3Q – RC Aero-Tow Gliders



THIS 2020 EDITION INCLUDES THE FOLLOWING AMENDMENTS MADE TO THE 2019 CODE

These amendments are marked by a double line in the right margin of this edition

Paragraph	Plenary meeting approving change	Brief description of change	Change incorporated by
F3B	2019		Kevin Dodd Technical Secretary & Tomas Bartovsky, F3 Soaring Subcommittee Chairman
5.3.1.3 d)		Inclusion of a more detailed statement regarding permitted and not permitted technological devices.	
5.3.1.3 g)		Deletion of redundant frequency paragraph and inclusion of statement forbidding turbulators.	
5.3.1.5 b), c)		Changes to circumstances when a competitor may claim new working time.	
5.3.1.5.e)		Deletion of reference to clash of frequencies.	
5.3.2.1 b)		Clarification.	
5.3.2.3 b)		Changed penalty for landing outside the defined flying site – Task A.	
5.3.2.3 e)		Clarification of when the time ends for the Task A – Duration.	
5.3.2.4 f)		Changed penalty for landing outside the defined flying site – Task B.	
5.3.2.5 f)		Changed penalty for landing outside the defined flying site – Task C.	
5.3.2.5 h)		Clarification of how the penalty for crossing the safety plane is applied.	
F3K			
5.7.4.2		Amendment to reflight rule for collision during start phase.	
5.7.7 & 5.7.9.1		Change to timing from full seconds to tenths of seconds.	
5.7.9.4		Change to make it mandatory to have a 60 sec preparation time on the ground before the working time.	
5.7.9.5		Consequence of the change to 5.7.9.4.	
5.7.9.5		Change to flight testing time.	
5.7.10.1		Change to the number of rounds to be flown before the lowest score can be dropped.	
5.7.11.4		Change to create a new Task D.	
5.7.11.5		Change to number of target times in Task E.	
5.7.11.12		Added an additional Task L.	
5.7.11.13		Added an additional Task M.	
F3G		New Provisional Class	
5.G.1 – 5.G.2.9		New rules for the class.	

Four-year Rolling Amendments for Reference.../cont

Four-Year Rolling Amendments for Reference			
Paragraph	Plenary meeting approving change	Brief description of change	Change incorporated by
F3F	2018		Kevin Dodd Technical Secretary & Tomas Bartovsky, F3 Soaring Subcommittee Chairman
5.8.1 – 5.8.17		Replace "model aircraft" by "model"	
5.8.2.		Deletion of examples of prohibited devices	
5.8.3.		Role of helper clarified	
5.8.5.		Number of attempts and reason for repeat attempt clarified	
5.8.7.		Introduction of ' <i>scored flight</i> ' and slight correction to organisation of starts	
5.8.9.		The speed course clarified	
5.8.10.		Penalty for contact with person and objects	
F3J			
5.6.1.3.		Minimum wing loading increased to 20 g/dm ²	
5.6.4.		Reflights only if hindering within first 60 seconds	
5.6.8.6.		The winch allowed for launching	
5.6.8.		Launching penalisation clarified	
5.6.8.7.		Clarification connected with the introduction of winches	
5.6.11.4.		No discard of worst result at fly-off	

Paragraph	Plenary meeting approving change	Brief description of change	Change incorporated by
F3B	2017		Kevin Dodd Technical Secretary & Tomas Bartovsky, F3 Soaring Subcommittee Chairman
5.3.1.11.		Add new paragraph <i>weather conditions/interruptions</i> as a consequence of this being deleted from CGR.	
5.3.2.3.b)		Penalty for not landing on the defined landing area.	
5.3.2.4.c)		Clarification.	
5.3.2.4.d)		Change to start procedure.	
5.3.2.4.f)		Consequential change. Penalty for not landing on the defined landing area.	
5.3.2.5.c)		Clarification.	
5.3.2.5.d)		Consequential change. Clarification.	
5.3.2.5.f)		Consequential change. Penalty for not landing on the defined landing area.	
5.3.2.5.h)		Consequential change. Clarification.	
5.3.2.9.		New paragraph. Team classification method stated.	
5.3.2.10.		Renumbered paragraph. New diagram of F3B flying field layout	
F3J			
5.6.11.5.		New paragraph. Team classification method stated.	
F3K			
5.7.1.		Removed detail on minimum number of rounds – clearly defined in 5.7.10.	
5.7.5.		Amend paragraph <i>weather conditions/interruptions</i> to clarify responsibilities and measurement procedure.	
5.7.7.		Clarification of scoring.	
5.7.10.		Clarification of the validity of a competition.	
5.7.10.1.		Clarification.	
5.7.10.4.		New paragraph. Team classification method stated.	
5.7.11.3.		Sentence added to disallow any help during Task C.	
5.7.11.5.		Addition of 'end-of-working time' call in Task E.	
F3F			
5.8.14.	New paragraph. Team classification method stated.		
5.8.15.-18.	Renumbered as consequence of inserted 5.8.14.		

Paragraph	Plenary meeting approving change	Brief description of change	Change incorporated by
F3F	2016		Kevin Dodd Technical Secretary & Tomas Bartovsky, F3 Soaring Subcommittee Chairman
5.8.1		Minimum number of rounds moved to 5.8.13	
5.8.7			
5.8.8		Numbers added to words and words to numbers where values are stated.	
5.8.9			
5.8.13		Amended wording to clarify how many rounds must be flown for the result to be valid.	
5.8.15		Changes of flight/landing areas allowed also between groups	
5.8.16		Amended wording of the paragraph and obligatory interruption introduced also in case of rain	
5.8.17		Drawing of recommended flying field layout added	
F3J			
5.6.2003		Amended statement of necessary number of rounds for the competition to be valid	
5.6.2011		Amended wording of paragraph	
5.6.2012		New paragraph Weather Conditions and Interruptions	
Annex 3A			
3		Definition of minimum rounds for counting of results in World Cup	
10	Replacing World Cup Jury by World Cup Board according to new General Section		

Paragraph	Plenary meeting approving change	Brief description of change	Change incorporated by
5.H.1. i)	2015	Consequential change for ABR Section 4B Para. B.17.6. : inclusion of FAI Unique ID number for marking purposes.	Kevin Dodd Technical Secretary
Annex 3A, 10		Consequential change for ABR Section 4B Para. B.18.1. : increase protest fee from 35 to 50 Euro.	
F3B	2015		Kevin Dodd Technical Secretary & Tomas Bartovsky, F3 Soaring Subcommittee Chairman
5.3.1.5.d)		Change of damaged model	
5.3.1.8.a)		Introduction of the working team	
5.3.1.10.a)		Reference to sketch added	
5.3.2.1.b)		Possibility to fly task A/B before the task C of previous round	
5.3.2.2.f)		Battery must not be charged in the winch area	
5.3.2.2.s)		Six winches for each working team	
5.3.2.9		New sketch of the flying field	

Four-year Rolling Amendments for Reference.../cont

cont/... Four-year Rolling Amendments for Reference

F3K			
5.7.1.3		Reference to Volume ABR for transmitter pound	
5.7.2.1		Amended definition of launch peg	
5.7.2.5		Amended definition of frequency usage	
5.7.4.3		Amended wording concerning safety area and penalties	
5.7.4.4		Clarified definition of forbidden airspace. Corrected unintentional mention of 'safety area' instead of 'forbidden airspace'.	
5.7.9.1	2015	Defined rounding of normalised scores	
5.7.9.3		New description of landing window	
5.7.9.4		Amended wording of preparation time and introduction of 60 s preparation time between each flight attempt of Task C (All up)	
5.7.9.5		Amended description of Flight Testing time	
5.7.10.2		Updated tie resolution procedure	
5.7.10.3		Updated description of fly-off procedure	
5.7.11.1		The word 'to' replaced by 'or'	
5.7.11.3		60 s preparation time between flight attempts of Task C (All up)	
5.7.11.11		New Task K (Increasing time by 30 seconds, « Big Ladder »)	

RULE FREEZE FOR THIS VOLUME

With reference to paragraph A.10.2 of CIAM General Rules:

In all classes, the two-year rule for no changes to model aircraft/space model specifications, manoeuvre schedules and competition rules will be strictly enforced. For Championship classes, changes may be proposed in the year of the World Championship of each category.

For official classes without Championship status, the two-year cycle begins in the year that the Plenary Meeting approved the official status of the class. For official classes, changes may be proposed in the second year of the two-year cycle.

- a) for category F3B changes can next be agreed at the Plenary meeting 2021 for application from January 2022;
- b) for category F3K changes can next be agreed at the Plenary meeting 2021 for application from January 2022;
- c) for category F3F changes can next be agreed at the Plenary meeting 2020 for application from January 2021;
- d) for category F3J changes can next be agreed at the Plenary meeting 2020 for application from January 2021
- e) provisional classes are not subject to this restriction.

VOLUME F3 SOARING

PART FIVE - TECHNICAL REGULATIONS FOR RADIO CONTROLLED CONTESTS

5.3. CLASS F3B – MULTI-TASK GLIDERS

5.3.1. General Rules

5.3.1.1. Definition of a Radio Controlled Glider

Model aircraft which is not provided with a propulsion device and in which lift is generated by aerodynamic forces acting on surfaces remaining fixed in flight, except control surfaces. Model aircraft with variable geometry or area must comply with the specification when the surfaces are in maximum and minimum extended mode. The model aircraft must be controlled by the competitor on the ground using radio control. Any variation of geometry or area must be actuated at distance by radio control.

5.3.1.2. Prefabrication of F3B Model Aircraft

Paragraph B.3.1 a) of Section 4B (Builder of the Model aircraft) is not applicable to class F3B.

5.3.1.3. Characteristics of Radio Controlled Gliders F3B

- a) Maximum surface area 150 dm²
 Maximum flying mass 5 kg
 Loading ≤ 75 g/dm²
 Minimum radius of fuselage nose 7.5 mm (see template)

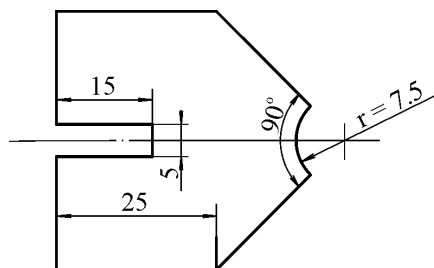

TEMPLATE FOR NOSE RADIUS, TOW HOOK AND MARKING

- b) No fixed or retractable arresting device (i.e. bolt, sawtooth-like protuberance, etc.) is allowed to slow down the model aircraft on the ground during landing.

The underside of the model aircraft must not have any protuberance other than the tow-hook and surface control linkages. The tow-hook must not be larger than 5 mm in frontal width and 15 mm in frontal height.

- c) The radio shall be able to operate simultaneously with other equipment at 10 kHz spacing below 50 MHz and 20 kHz spacing above 50 MHz.
 d) The use of any onboard-sensed data to automatically move the control surfaces or to modify the aircraft geometry is prohibited.

Any technological device used to aide in supplying data of the air's condition or direct feedback of the model's flight status is prohibited during the flight. These devices include any transmission or receiving devices not used to directly control the model aircraft (telephones, walkie-talkies, telemetry of airspeed and altitude etc.), temperature detecting devices (thermal imaging cameras, thermometers etc), optical aids (such as binoculars, telescopes etc.), and distance/altitude measuring devices (GNSS, laser range finders etc.). Telemetry of signal strength at the aircraft receiver and state of the receiver battery is permitted. Use of corrective eyeglasses and sunglasses are permitted. If an infringement of this rule occurs, the pilot will be disqualified from the contest.

- e) The competitor may use a maximum of three (3) model aircraft in the contest. All exchangeable parts (wing, fuselage, tail planes) must be marked uniquely and in a way that does not allow replication of this mark on additional parts.

- f) The competitor may combine the parts of the model aircraft during the contest; provided the resulting model aircraft used for flight conforms to the rules and that the parts have been checked before the start of the contest. See also 5.3.2.1.
- g) The use of turbulators to influence the air flow at the wings is forbidden.

5.3.1.4. Competitors and Helpers

The competitor must operate his radio equipment personally. Each competitor is permitted up to three (3) helpers at the winch line, including the team manager, who must not give any turning signals near base B during tasks B and C.

A maximum of two (2) more helpers are permitted to be utilised only at the turn-around pulleys to cover all wind directions.

5.3.1.5. Definition of an Attempt

- a) For each task (ref. 5.3.2.1.), during the working time allocated, the competitor is entitled an unlimited number of attempts. An attempt starts when the model aircraft is released from the hands of the competitor or his helper(s) under the tension of the tow-line. No change of model aircraft or parts of the model aircraft is allowed after starting the first attempt.
- b) The competitor is entitled to a new working time period if any of the following conditions occur and are duly witnessed by an official of the contest:

- ..i) his model aircraft in flight collides with another model aircraft in flight, or another model aircraft in the process of launch (released for flight by the competitor or his helper) or, with a launch cable during the process of launching.
- ii) his model aircraft or launch cable in the process of launch collides with another model aircraft or launch cable also in the process of launch (released for flight by the competitor or his helper), or with another model aircraft in flight.
- iii) his launch cable is crossed or fouled by that of another competitor at the point of launch of his model aircraft (released for flight by the competitor or his helper).

To claim a re-flight in the cases i) to iii) the competitor must land his model as soon as possible after the collision. If the competitor continues his flight, he has waived his right for a new working time.

- iv) the flight has not been judged by the fault of the judges or timekeepers.
- v) in the case of an unexpected event, outside the competitor's control, the flight has been hindered or aborted.
- c) If the competitor continues to fly or continues to launch or he does a re-launch, he has waived his right for a new working time.
- d) The competitor has the right to change his model during a current round and this is not withstanding rule 5.3.2.1. if:
 1. his model collides with another model in flight; he has the right for a reflight, but his model is not reparable in time.
 2. his model has landed (final or intermediate landing) and is damaged by a landing model of another competitor and the model is not reparable in time.
 3. in the case of 1) or 2) above, once the competitor has exercised his right to change his damaged model aircraft, that model must not be used in any subsequent task(s) in the current round, with the exception stated in paragraph 5.3.1.3.f).

- e) In case of additional attempts in task A (Duration) during a round or task B (Distance) during a round, the competitors entitled to that additional attempt must fly within a group that is not complete in number or in one or more groups newly formed. If this is not possible, those entitled to another flight fly within their original group once more. The better of the two results will be the official score except for those competitors who are flying the additional attempt. For those the result of the repetition is the official score.

5.3.1.6. Definition of the Official Flight

The official flight is the last flight performed during the working time.

5.3.1.7. Cancellation of a Flight and Disqualification

- a) Unless otherwise specified a flight in progress will be annulled for an infraction of any rule. In the case of intentional or flagrant violation of the rules, in the judgement of the Contest Director, the competitor may be disqualified.
- b) The flight in progress will be penalised with 100 points if the model aircraft loses any part either during the launch or the flight. The loss of any part in a collision with another model aircraft or during landing (i.e. in contact with the ground) is not taken into account. The penalty of 100 points will be a deduction from the competitor's final score and shall be listed on the score sheet of the round in which the penalisation was applied.
- c) The competitor is disqualified if the model aircraft in flight is controlled by anyone other than the competitor.
- d) If the model aircraft touches either the competitor or his helper during landing manoeuvres of task A, no landing points will be given.
- e) The upwind turnaround device must be fixed safely to the ground. If the pulley comes loose from its mounting support or the turnaround device is torn out of the ground, the competitor shall be given a penalty of 1000 points. The penalty of 1000 points will be a deduction from the competitor's final score and shall be listed on the score sheet of the round in which the penalisation was applied.
- f) The winch must be fixed safely to the ground. If the winch is torn out of the ground or rotating parts of the winch are separated (excluding parts of the tow-line) the flight is penalised with 1000 points. The penalty of 1000 points will be a deduction from the competitor's final score and shall be listed on the score sheet of the round in which the penalisation was applied.

5.3.1.8. Organisation of Starts

- a) The competitors shall be combined in groups with a draw, in accordance with the radio frequencies used, to permit as many flights simultaneously as possible. Incomplete teams may be to their request combined into a working team. The draw is organised in such a way that there are no competitors of the same working team in the same group. At World and Continental Championship the reigning champion, if participating outside the national team, may join his national team to form a working team.
- b) The composition of the groups must be changed every round in order to have different combinations of competitors. For task A (duration), there must be a minimum of five competitors in a group. For task B (distance) there must be a minimum of three competitors in a group. For task C (speed) a group may consist of a minimum of eight competitors or all competitors.

It is preferable for the organiser to orientate the starting order for task C at the inverted ranking calculated out of the results of all tasks flown until that moment. For the first round the starting order for task C should always be identical with the starting order of task A. Alternatively the organiser may use the task A starting order in subsequent task C rounds.

- c) The result of a group is annulled if only one competitor has a valid result. In this case, the group will fly again and the result will be the official result.
- d) The flying order of different groups is established with the draw too. A different starting order shall be used for each round.
- e) The competitors are entitled to 5 minutes of preparation time before the starter gives the order to count off working time.

5.3.1.9. Organisation of Contests

- a) For transmitter and frequency control see Section 4B, para B.10.
- b) The official will issue the transmitter to the competitors only at the beginning of their preparation time, according to 5.3.1.8.
- c) Sighting apparatus, winches or any device constituting an obstacle, should be placed on Base A and Base B, a minimum of 5 metres from the safety line for task C. Apparatus for judging the safety plane in task C shall be placed a minimum distance of 5 metres from Base A or B outside the course.
- d) The contest director must inform without delay the competitor and/or his team manager about any decision taken, eg in the case of a re-fly, a penalty etc.

5.3.1.10. Safety Rules

- a) The organiser must clearly mark the boundary between the landing area and the safety area assigned for other activities. (See sketch “F3B flying field layout” page 19.)
- b) After release of the model aircraft from the hand of the competitor or helper, any contact of the model aircraft with any object (earth, car, stick, plant, tow-line, etc) within the safety area will be penalised by 300 points, except in the circumstances described in paragraph 5.3.1.5 b) items 1, 2, 3, and 5, and in the case of a line break at the moment of release of the model aircraft. Contact with a person within the safety area will be penalised by 1000 points. The number of contacts during one attempt does not matter (maximum one penalty for one attempt). The penalty will be a deduction of 300 or 1000 points from the competitor’s final score and shall be listed on the score sheet of the round in which the penalisation was applied.

5.3.1.11. Weather Conditions / Interruptions

- a) The maximum wind speed for F3B contests is twelve (12) m/sec. The contest has to be interrupted or the start delayed by the contest director if the wind speed exceeds twelve (12) m/sec measured three (3) times for at least twenty (20) seconds in a time interval of five (5) minutes two (2) metres above the ground at the start and landing area.
- b) In the case of rain, the contest director can interrupt the contest during task A and task B. When the rain stops, the contest starts again with the group that was flying, which receives a re-flight.
- c) In the case of rain, the contest director must interrupt the contest during task C. When the rain stops, the contest starts again with the pilot that was flying, who receives a re-flight.

The whole group of task C must be divided in three (3) or four (4) groups depending on the total number of competitors before the task starts. If the weather is stable only one group is evaluated; if the competition must be interrupted more than fifteen (15) minutes, then the interrupted group must start from the beginning and the results are evaluated for each group.

5.3.2. RULES FOR MULTI-TASK CONTESTS**5.3.2.1. Definition**

- a) This contest is a multi-task event for radio controlled gliders, which includes three tasks:
 - A) Duration
 - B) Distance
 - C) Speed
- b) The combination of task A, B and C constitutes a round. A minimum of one (1) round and one (1) task must be flown that the competition is valid. The result of a World or Continental Championship is valid if five (5) complete rounds are flown; if more than five (5) complete rounds are flown, see paragraph 5.3.2.8. Classification. At the discretion of the contest director, any task may be flown first in a scheduled round.

At the discretion of the organiser any task may be flown first in a scheduled round. In the case of unstable weather conditions, lack of time or technical issues it is possible fly task A or B of the following round before the task C of the current round. No other change of the schedule is allowed. The scheduled task must be completed. If the model is damaged during the predrawn task (A or B) the competitor is entitled to change the model for task C of the previous round.

- c) Any single round must be completed with the same model aircraft, without any change of parts. Only the addition of ballast (which must be located internally in the model aircraft and with which the model aircraft must conform to rule 5.3.1.3.) and/or change of angles of setting are allowed.
- d) Variation of geometry or area is allowed if actuated at distance by radio control.

5.3.2.2. Launching

- a) All launching shall take place in an area as designated by the organiser with provisions made for launching into the wind. All launches will be made with an electrical powered winch approved by the organiser or Contest Director.
- b) Upwind turnaround devices, which must be used, shall be no more than 200 metres from the winch. The height of the axis of the turnaround pulley from the ground must not exceed 0.5 metre.

Release of the model must occur within approximately 3 metres of the winch. An automatic means must be provided to prevent the line unwinding from the reel during launch.

- c) The winch shall be fitted with a single starter motor. The starter motor must come from serial production. It is allowed to fit the arbor of the rotor with ball or needle roller bearings at each end. The drum may be driven directly by the motor or by a gear with a constant and unchangeable transmission ratio. Any further change of the original motor will lead to disqualification according to paragraph B.18.1. The drum must have a fixed diameter.
- d) The power source shall be a 12 volt lead/acid battery. The cold cranking capability of the winch battery must be specified according to one of the following standards:

300 amperes max. according to DIN 43539-02 (30s/9V at -18°C)
 355 amperes max. according to IEC/CEI 95-1 (60s/8,4V at -18°C)
 500 amperes max. according to SAE J537, 30s Test (30s/7,2V at 0°F)
 510 amperes max. according to EN 60095-1 (10s/7.5V at -18°C)

Other standards are acceptable if evidence is provided that these standards are equivalent to one of the above stated standards.

- e) The battery must supply the winch motor with current through a magnetically or mechanically actuated switch. The use of any electronic device between the winch motor and the battery is forbidden. A competitor may interchange various parts as he wishes provided the resulting winch conforms to the rules.
- f) The battery must not be charged in the winches area. The motor must not be cooled, and the battery must not be heated.
- g) The purpose of this rule is to limit the power used for the launch. Therefore with the exception of the single winch battery, line stretch, and the small amount of energy in the rotating rotor and winch drum, no energy storage devices like flywheels, springs, weights, pneumatic devices or any similar devices is allowed.
- h) The complete winch (battery, cables, switch and motor) must have a total resistance of at least 23.0 milliohms. The allowed resistance may be obtained by adding a fixed resistor or resistors between the motor and battery. The design must not allow an easy change of the total resistance at the launch line (eg by shorting the resistor, or resistors) except opening and closing the circuit.
- i) The plus and minus pole of the battery must be readily accessible with alligator (crocodile) clips for voltage measurements. One of the cables from the battery (through which the total current flows) must be accessible for the clamp transducer (clamp meter) and the calibrated resistor.
- j) Measuring: The battery must stay unloaded for at least two minutes after the previous test or launch. The measuring of the circuit resistance consists of recording the battery voltage U_b immediately before closing the winch switch and of recording the current I_{300} and the voltage U_{300} 300 milliseconds (+-30 ms) after the winch current starts to flow. Before the end of this 300 ms interval the rotor of the motor shall stop rotating.
- k) For the test a digital voltage-measuring instrument (accuracy less or equal to 1%) is used, which enables the measurement of the voltage of the battery and the output voltage from the I/U-transducer 300 ms (+-30 ms) after the current to the winch is applied. The transducer for measuring the current may be a clamp transducer (range 0-600 or 0-1000A, accuracy less or equal to 2%) or a calibrated resistor (0.1 milliohm, accuracy less or equal to 0.5%) in the negative path of the circuit.

The resistance is calculated with the formula:

Measurement with clamp transducer $R_{\text{tot}} = 1000 \times U_b / I_{300}$

Measurement with shunt $R_{\text{tot}} = (1000 \times U_b / I_{300}) - 0.1$
 (R_{tot} in milliohms, U_b in volts, I_{300} in amperes)

- l) A first measurement is taken in order to check the correct functioning of the measuring equipment and is discarded.

Three subsequent measurements should be made with an interval of at least two minutes after the previous test or launch. The total resistance of the winch equipment is the average of these three (3) respective results.

Voltage and current must be displayed to be able to calculate the total resistance by hand. If the total resistance is calculated automatically then it must be shown simultaneously with the voltage and current values.

The winch equipment is declared as being in accordance with the rules if its total resistance is at least 23 mΩ.

- m) At the test of the winch before the competition the voltage of the battery U_{300} must be greater or equal to 9V; this does not apply for testing during the competition.
- n) The organiser must appoint at least two processing officials, who will process the winches with a single measuring apparatus, or several measuring apparatus proven to produce reproducible results within a tolerance of 0.5 %.
- o) There must be a quick release mechanism on the power lead to the battery in order to remove power from the motor in an emergency. (Connections to the battery must be removable without the need for tools). If slotted pole shoes are used then both of them have to be slotted.
- p) The flight is penalised with 1000 points if the winch is not in accordance with the rules; this is valid for the flight before the test. The penalty of 1000 points will be a deduction from the competitor's final score and shall be listed on the score sheet of the round in which the penalisation was applied.
- q) After release of the model aircraft from the towline, the towline must be rewound without delay by operating the winch, until the parachute arrives at the turnaround device. During this procedure the towline should be guided by a helper to avoid damage to other competitors' towlines. The towline must be provided with a measure eg a stopper or a metal ring, to prevent it being drawn down through the towline pulley. Then, the towline(s) must be retrieved by hand to the winch. A winch must not be operated when the towline is lying on the ground and across other towlines or strikes another towline during launching
- r) The towline (which must be of non-metallic material except for linkages) must be equipped with a pennant having a minimum area of 5 dm². A parachute (5 dm² minimum area) may be substituted for the pennant provided it is not attached to the model aircraft and remains inactive until the release of the cable. During complete rewinding of the line on to the winch, the parachute, if used, must be removed and inactivated.
- s) In the case of Continental and World Championships, a maximum of six (6) winches and six (6) batteries may be used at any time on the winches line(s) by any working team. Interchanging among winches and batteries while keeping compliance with the minimum resistance rule is totally under the responsibility of the competitor.

5.3.2.3. Task A - Duration

- a) This task must be completed within 12 minutes from the order of the starter, including the towing time.
- b) One point will be awarded for each full second from the time the model aircraft is free flying to the time the model aircraft comes to rest on the defined flying site, up to a maximum of 600 points (i.e. 10 minutes maximum), for each full second of flight within the working time; if the model does not land on the defined flying site, the whole flight is zero, except in the case of midair collision. No points will be awarded for flight time in excess of working time. The free flying of the model aircraft commences when the model aircraft is released from the towline.
- c) One point will be deducted for each full second flown in excess of 600 seconds (10 minutes).
- d) Additional points will be awarded for landing, depending upon distance from the spot marked by the organiser, according to the following table:

Distance from spot (m)	Points	Distance from spot (m)	Points
1	100	9	60
2	95	10	55
3	90	11	50
4	85	12	45
5	80	13	40
6	75	14	35
7	70	15	30
8	65	over 15	0

The distance is measured from the model aircraft nose when at rest to the centre of the spot.

No points will be awarded for the quality of landing.

No landing bonus will be awarded if the flight time exceeds 630 seconds.

The measured distance is rounded to the nearest higher metre.

- e) If the model has not come to rest when the 12 minutes expire, the elapsed flight time only will be taken into consideration for scoring, without any additional points for the precision landing.
- f) A classification based on decreasing number of points awarded will be compiled, called "Partial Score A" - see 5.3.2.6.

5.3.2.4. Task B - Distance

- a) This task must be completed within 7 minutes from the order of the starter, including towing time. The trial begins only after the glider has been released from the tow.
- b) When the model aircraft, in flight, first crosses Base A (imaginary vertical plane) in the direction to Base B, the actual flight time of 4 minutes maximum starts, during which time the model aircraft must complete as many legs as possible from the starting Base A to Base B and conversely.
- c) A visual system or a combined audiovisual system announces to the competitor when his model aircraft crosses the Base A or Base B (imaginary vertical planes). The absence of a signal will indicate that the model aircraft has failed to correctly cross the base. The instruments used to check the crossing of the vertical planes must assure the parallelism of such planes. Timing and signalling shall occur when any part of the complete model aircraft in flight crosses the base. If an audiovisual system is used, signalling is also valid when the audio system fails.
- d) The models will be identified by flags of different colours for each competitor in the group. When the competitor intends to start, his helper waves the flag; when the model is identified by the associated helpers at base A and base B, they wave the flag with the corresponding colour as well. At that moment the pilot can launch.

The competitor must stay within a distance of 10 metres either side of Base A during the timed flight.

- e) For a model aircraft which lands within 4 minutes flight time only the full 150 metre legs will be counted. For model aircraft still in the air when the 4 minutes flight time or 7 minutes expires, whichever comes first, only the completed legs at that moment will be taken into account.
- f) After having completed the task, the model aircraft must land on the defined flying site, otherwise the flight is zero, except in the case of midair collision.
- g) A classification based on decreasing number of total flown legs during the flight time will be compiled, and points given as described in 5.3.2.6., thus establishing the "Partial Score B".

5.3.2.5. Task C - Speed

- a) This task must be completed within 4 minutes, from the order of the starter including towing time. The trial begins only after the glider has been released from the tow. After release of the tow-hook, the model aircraft must start the task at Base A within one minute. If the one minute period expires before the model aircraft has crossed Base A for the first time, flying from Base A to Base B, then the model aircraft must be landed and re-launched within the original working time period.
- b) The task consists of flying the distance starting from Base A, to Base B, and conversely, four legs in the shortest possible time.
- c) The flight time is recorded to at least 1/100 sec when in flight the model aircraft first crosses Base A at the predetermined side of the safety-plane and completes four legs of the 150 metre course.
- d) An audio system will inform the competitor when the model aircraft crosses the Base A or Base B (imaginary vertical planes). The absence of a signal will indicate that the model aircraft has failed to correctly cross the Base. The instruments used to check the crossing of the vertical planes must assure the parallelism of such planes. The signal is given when any part of the complete model aircraft in flight crosses the base. The source of the signal (horn, loudspeaker) must not be further than 30 metres away from the intersection of base A and the safety plane.
- e) During the timed flight the competitor must stay within a distance of 10 metres either side from Base A.
- f) After having completed the task, the model aircraft must land on the defined flying site, otherwise the flight is zero.

- g) Model aircraft which come to rest before having completed the task will score zero.
- h) During task C the timed flight shall take place at the predetermined side of the safety plane, whilst all judges/time-keepers shall remain on the other side of the safety plane. The side which is to be flown shall be indicated by the organiser taking into account the direction of the sun, etc.

The flight will be penalised with 300 points, when sighted by means of an optical aid, the safety plane is crossed or multiple crossed by any part of the intact model aircraft. The instrument used to check the crossing of the vertical safety plane must also assure that the safety plane is orthogonal to Base A and Base B. The penalty of 300 points will be a deduction from the competitor's final score and shall be listed on the score sheet of the round in which the penalisation was applied.

- i) After release of the tow-hook, when the model aircraft has crossed Base A for the first time, flying in the direction from Base A to Base B, no further attempt is permitted unless the competitor signals his intention to re-launch before Base A is crossed.
- j) A classification based on increasing times to complete the four 150 metre legs will be compiled, and points given as described in 5.3.2.6., thus establishing "Partial Score C".

5.3.2.6. Partial Scores

For each task the winner of each group receives 1000 points.

- a) Partial Score A for each competitor is determined as follows:

$$\text{Partial Score A} = 1000 \times \frac{P_1}{P_w}$$

Where P_1 = points of the competitor obtained as 5.3.2.3.

P_w = points of the winner in the related group.

- b) Partial Score B for each competitor is determined as follows

$$\text{Partial Score B} = 1000 \times \frac{D_1}{D_w}$$

Where D_1 = distance covered by the competitor as for 5.3.2.4

D_w = distance covered by the winner in the related group.

- c) Partial Score C for each competitor is determined as follows

$$\text{Partial Score C} = 1000 \times \frac{T_w}{T_1}$$

Where T_1 = time of the competitor as for 5.3.2.5.

T_w = time of the winner in the related group.

5.3.2.7. Total Score

The competitor's Total Score for each round is compiled by adding the Partial Scores of all tasks.

5.3.2.8. Classification

If only five rounds are flown, the competitor's classification is determined by the sum of all Total Scores for each round. If more than five complete rounds are flown the lowest partial score of each task with more than five results is omitted from the sum of all partial scores. To decide the winner when there is a tie, the two (or all who have the equal score) competitors will fly an additional round (three tasks).

5.3.2.9. Team Classification

To establish the ranking for international team classification, add the final individual scores of three best members of the team. Teams are ranked according to the highest numerical score to lowest. In the case of a national team tie, the team with the lower sum of place numbers, given in order from the top, wins. If still equal, the best individual placing decides.

5.3.2.10. Site

The competition must be held at a site having reasonably level terrain, with a reasonably low probability of slope or wave soaring.

The diagram of **F3B Flying Field Layout** follows:

F3B Flying Field Layout

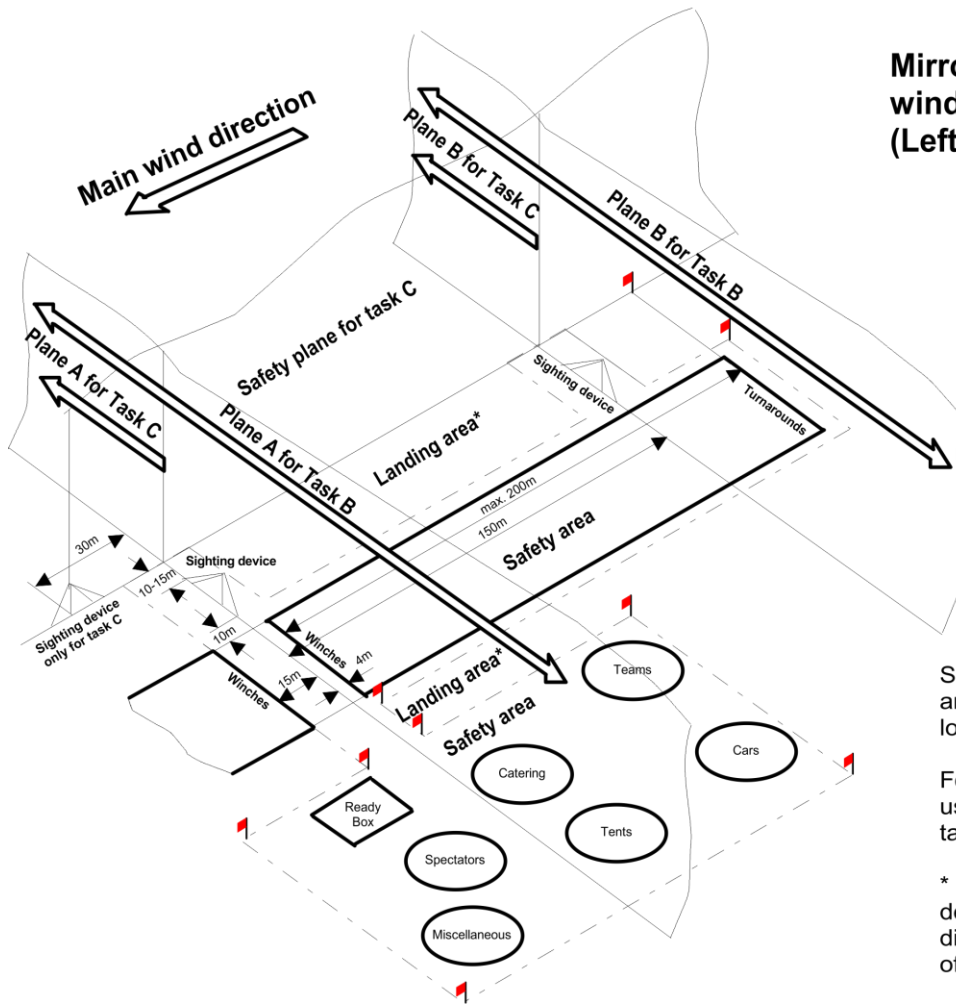

**Mirrored layout in the main wind direction
(Left hand layout shown)**

Size and shape of the safety area should be adopted to local conditions

For marking the bountry use flags in the corner and/or tape along the border

* Other landing areas are determined by the contest director at the beginning of the competition

PAGE DELIBERATELY LEFT BLANK

5.6. CLASS F3J - THERMAL DURATION GLIDERS

Object: To provide a man-on-man contest for competitors flying radio-controlled thermal duration soaring gliders. In the contest, several qualifying rounds are flown. For each qualifying round, competitors are divided into groups. The scores in each group are normalised to give them meaningful scores irrespective of changing weather conditions during a round. The competitors with the top aggregate scores in the qualifying rounds then fly at least two further fly-off rounds as a single group to determine the final placing. The scheduled number of fly-off rounds shall be announced by the Contest Director before the start of the contest.

5.6.1. General Rules

5.6.1.1. Definition of a Radio Controlled Glider

A model aircraft which is not provided with a propulsion device and in which lift is generated by aerodynamic forces acting on surfaces remaining fixed. Model aircraft with variable geometry or area must comply with the specification when the surfaces are in maximum and minimum extended mode. The model aircraft must be controlled by the competitor on the ground using radio control. Any variation of geometry or area must be actuated at distance by radio. The use of any onboard-sensed data to automatically move the control surfaces or to modify the aircraft geometry is prohibited.

5.6.1.2. Prefabrication of the Model aircraft

Paragraph B.3.1 a) of Section 4, Part 2 (builder of the model aircraft) is not applicable to this class.

5.6.1.3. Characteristics of Radio Controlled Gliders

- a) Maximum Surface Area 150 dm²
 Maximum Flying Mass 5 kg
 Loading 20 to 75 g/dm²
 Minimum radius of fuselage nose 7.5 mm
- b) The radio shall be able to operate simultaneously with other equipment at 10 kHz spacing below 50 MHz and at 20 kHz spacing above 50 MHz. When the radio does not meet this requirement, the working bandwidth (max. 50 kHz) shall be specified by the competitor.
- c) Any technological device used to aid in supplying data of the air's condition or direct feedback of the model's flight status is prohibited during the flight. These devices include any transmission or receiving devices not used to directly control the model aircraft (telephones, walkie-talkies, telemetry of airspeed and altitude etc), temperature detecting devices (thermal imaging cameras, thermometers etc), optical aids (such as binoculars, telescopes etc), and distance/altitude measuring devices (GPS, laser range finders etc). Telemetry of signal strength at the aircraft receiver and state of the receiver battery and GPS location data that is not displayed in any form to the pilot or helpers during a flight, and not used for aircraft control is permitted. Use of corrective eyeglasses, lenses and sunglasses are permitted. If an infringement of this rule occurs, the pilot will be disqualified from the contest.
- d) The competitor may use three model aircraft in the contest.
- e) The competitor may combine the parts of the model aircraft during the contest, provided the resulting model aircraft conforms to the rules and the parts have been checked before the start of the contest.
- f) For the sake of randomness of the starting order among the successive rounds, each competitor must enter three different transmitter frequencies with 10 kHz minimum spacing. The organiser is entitled to use any of these three frequencies for setting the flight matrices. Once the competitor is given one of these three frequencies he must not change to another frequency for all flights during the whole of the preliminary rounds other than for reflights. In case of a reflight the competitor can be called to use either of these three frequencies for this reflight only, as long as the call is made at least 1/2 hour prior to the beginning of the reflight in written form to the competitor (or team manager when applicable).
- g) All ballast must be carried internally and fastened securely within the airframe.
- h) No fixed or retractable arresting device (i.e. bolt, saw tooth-like protuberance, etc) is allowed to slow down the model aircraft on the ground during landing. The underside of the model aircraft must not have any protuberances other than the tow hook and surface control linkages (with or without fairings). The tow hook must not be larger than 5 mm in frontal width and 15 mm frontal height.

5.6.1.4. Competitors and Helpers

- a) The competitor must operate his radio equipment himself.
- b) Each competitor is allowed three helpers. When a team manager is required, he is also permitted to help the competitor. A maximum of two helpers are permitted for towing during the launch as described in 5.6.8.2.

5.6.2. The Flying Site

5.6.2.1. The competition must be held on a site having reasonably level terrain, which will minimise the possibility of slope and wave soaring.

5.6.2.2. a) The flying site shall include a marked launch corridor of 6 metres width with a central launch line. The launch corridor shall be arranged crosswind and must include launch marks on the central launch line at least 15 metres apart, one for each competitor of a group.

- b) The flying site must include landing spots, one for each competitor in a group. Each landing spot will correspond to one of the launch marks and will be arranged at least 30 metres downwind of the launch corridor.

5.6.2.3. The centres of the landing circles and the launch line must always be marked. At the discretion of the Contest Director, marks indicating the circumference of the circles may be omitted and replaced by the use of other means of measuring, such as a tape, to check distances from the centre of the circles.

5.6.2.4. Safety Rules

- a) Contact with an object within the defined safety area (including the launch corridor) will be penalised by deduction of 300 points from the competitor's final score.
- b) Contact with a person within the defined safety area (including the launch corridor) will be penalised by deduction of 1000 points from the competitor's final score.
- c) For each attempt only one penalty can be given. If a person and at the same attempt an object is touched the 1000 points penalty is applied.
- e) Penalties shall be listed on the score sheet of the round in which the infringement(s) occurred.
- f) If necessary the organiser may define a part of the airspace as safety space. In such a case he must appoint at least one official who observes the border (vertical plane) by a sighting device. This official must warn the pilot if his glider crosses the border. If the glider does not leave the safety space immediately a penalty of 300 points is given.

5.6.3. Contest Flights

5.6.3.1. a) A minimum of four (4) qualification rounds must be flown for the competition to be valid. If more than seven qualification rounds are flown, then the lowest score will be discarded before determining the aggregate score.

- b) The competitor has an unlimited number of attempts during the working time.
- c) There is an official attempt when the model aircraft has left the hands of the competitor or those of a helper under the pull of the towline.
- d) In the case of multiple attempts, the result of the last flight will be the official score.
- e) All attempts are to be timed by two stopwatches. If no official time has been recorded, the competitor is entitled to a new working time according to the priorities mentioned in paragraph 5.6.4.

5.6.4. Re-flights

The competitor is entitled to a new working time if:

- a) his model in flight or in the process of being launched collides with a model in the process of being launched.
- b) his model in flight or in the process of being launched collides with another competitor's towline.
- c) the competitor's towline is hit by another model in the process of being launched.
- d) the attempt has not been judged by the official time-keepers.
- e) his attempt was hindered or aborted by an unexpected event within the first 60 seconds of the working time, not within his control. Crossed lines are not considered as reason for re-flight.

- f) A towline (other than his own) was not removed after launch and is blocking (covering) his own towline.

To claim a re-flight considering the above mentioned conditions, the competitor has to make sure that the official timekeepers have noticed the hindering conditions and land his model as soon as possible after this event.

Note that in the case the competitor continues to launch or continues to fly after hindering conditions affected his flight or does re-launch after clearing of the hindering condition(s), he is deemed to have waived his right to a new working time.

The new working time is to be granted to the competitor according to the following order of priorities:

1. in an incomplete group, or in a complete group on additional launching/landing spots, if there is no member of his team in this group;
2. if this is not achievable, then in a new group of several (minimum 4) re-flyers. The new group of re-flyers will be completed by other competitors selected by random draw to the number of 4. If the frequency or team membership of the drawn competitor does not fit or the competitor will not fly, the draw is repeated;
3. if this is also not achievable, then with his original group at the end of the ongoing round.

In priority-case 2 and 3, the better of the two results of the original flight and the re-flight will be the official score, except for the competitors who are allocated the new attempt. For those the result of the re-flight is the official score. A competitor of this group who was not allocated the new attempt will not be entitled to another working time in case of hindering.

5.6.5. Cancellation of a flight and/or disqualification

- 5.6.5.1.**
- a) The flight is cancelled and recorded as a zero score if the competitor used a model aircraft not conforming to any item of rule 5.6.1. In the case of intentional or flagrant violation of the rules, in the judgement of the Contest Director, the competitor may be disqualified.
 - b) The flight in progress is annulled and recorded as a zero score if the model aircraft loses any part during the launch or the flight, except when this occurs as the result of a mid-air collision with another model aircraft or towline.
 - c) The loss of any part of the model aircraft during the landing (coming into contact with the ground) is not taken into account.
 - d) The flight is cancelled and recorded as a zero score if the model aircraft is piloted by anyone other than the competitor.
 - e) The flight is cancelled and recorded as a zero score if, during landing, some part of the model aircraft does not come to rest within 75 metres of the centre of the competitor's designated landing circle.

5.6.5.2. Neutralisation of a flight group

During the fly-off rounds and for the last group of a qualification round, and only within the first 30 seconds of the working time, the Contest Director has the right to neutralise the ongoing flight group in events leading to a reflight according to 5.6.4 a) – e).

If an event according to 5.6.4.a) – e) occurs within the first 30 seconds of the working time, the Contest Director needs to:

- state the immediate neutralisation of the group clearly to all competitors; stop the running working time;
- call all competitors to land as soon as possible.

This round will be started again with the preparation time as soon as possible.

5.6.6. Organisation of the Flying.

5.6.6.1. Rounds and Groups

- a) The flying order for the initial qualifying rounds shall be arranged in accordance with the transmitter frequencies in use to permit as many simultaneous flights as possible. A minimum of 6 and preferably 8 to 10 competitors should be scheduled for each group.
- b) The flying order shall be scheduled in rounds sub-divided into groups.
- c) The flying order shall be determined by a matrix system that minimises situations where competitors fly together more than once (see paragraph 5.6.12.3).

5.6.6.2. Flying in Groups

- a) Competitors are entitled to five minutes preparation time, which is counted from the moment his group is called to take position at the designated launching area, to the start of the group's working time.
- b) The working time allowed to each competitor in a group shall be of exactly ten (10) minutes duration.
- c) The organisers must positively indicate the start of a group's working time, by audible signal; see 5.6.12.1 for details.
- d) Audible and visual signals must be given when eight (8) minutes of the group's working time has elapsed.
- e) The end of the group's working time must be positively indicated by audible signal, as for the start.
- f) Any model aircraft airborne at the completion of the working time must land immediately.

5.6.7. Control of Transmitters

- 5.6.7.1. a) Competitors using 2.4 GHz spread spectrum transmitters may retain their transmitters during the competition. Transmitters using other frequencies may be impounded at the discretion of the Contest Director. (See also ABR B.11.2; B.11.3 & B.11.4.)
- b) If a transmitter pound has to be used for am/fm transmitters then
 - Failure to hand in a transmitter before the official starting time of the contest may result in the competitor forfeiting his first round flight.
 - The competitor must hand over his transmitter to the designated official (usually the timekeeper) immediately after finishing his flight
- c) The only permitted flying during the competition hours are the official competition flights. Other than for ground testing of equipment using 2.4 GHz spread spectrum, any other transmission or any flight shall only take place with the permission of the Contest Director.
- d) A penalty of 300 points shall be applied to any competitor making an unauthorised transmission or flight without the permission of the Contest Director. If this transmission or flight results in injury to personnel or damage to property, then the competitor will be disqualified from the whole competition.

5.6.8. Launching

5.6.8.1. The contest director defines the start direction. The start should be executed as far as possible against the wind inside of the marked launch corridor (5.6.2.2). An attempt is annulled and recorded as zero if the model aircraft is launched outside the launch corridor.

5.6.8.2. The launch of the model aircraft will be by hand held towline or winch.

- a) All launching shall take place in an area as designated by the organiser with provisions made for launching into the wind. All launches will be made with an electrical powered winch approved by the organiser or Contest Director.
- b) Upwind turnaround devices, which must be used, shall be no more than 150 metres from the winch. The height of the axis of the turnaround pulley from the ground must not exceed 0.5 metre. Release of the model must occur within approximately 3 metres of the winch. An automatic means must be provided to prevent the line unwinding from the reel during launch.
- c) The winch shall be fitted with a single starter motor. The starter motor must come from serial production. It is allowed to fit the arbor of the rotor with ball or needle roller bearings at each end. The drum may be driven directly by the motor or by a gear with a constant and unchangeable transmission ratio. Any further change of the original motor will lead to disqualification according to paragraph B.18.1. The drum must have a fixed diameter.
- d) The power source shall be a 12 volt lead/acid battery.
- e) The battery must supply the winch motor with current through a magnetically or mechanically actuated switch. The use of any electronic device between the winch motor and the battery is forbidden. A competitor may interchange various parts as he wishes provided the resulting winch conforms to the rules.
- f) The battery must not be charged in the winches area. The motor must not be cooled, and the battery must not be heated.
- g) The purpose of this rule is to limit the power used for the launch. Therefore with the exception of the single winch battery, line stretch, and the small amount of energy in the rotating rotor

and winch drum, no energy storage devices like flywheels, springs, weights, pneumatic devices or any similar devices is allowed.

- h) The complete winch (battery, cables, switch and motor) must have a total resistance of at least 23.0 milliohms. The allowed resistance may be obtained by adding a fixed resistor or resistors between the motor and battery. The design must not allow an easy change of the total resistance at the launch line (eg by shorting the resistor, or resistors) except opening and closing the circuit.
- i) The plus and minus pole of the battery must be readily accessible with alligator (crocodile) clips for voltage measurements. One of the cables from the battery (through which the total current flows) must be accessible for the clamp transducer (clamp meter) and the calibrated resistor.
- j) Measuring: The battery must stay unloaded for at least two minutes after the previous test or launch. The measuring of the circuit resistance consists of recording the battery voltage U_b immediately before closing the winch switch and of recording the current I_{300} and the voltage U_{300} 300 milliseconds (± 30 ms) after the winch current starts to flow. Before the end of this 300 ms interval the rotor of the motor shall stop rotating.
- k) For the test a digital voltage-measuring instrument (accuracy less or equal to 1%) is used, which enables the measurement of the voltage of the battery and the output voltage from the I/U-transducer 300 ms (± 30 ms) after the current to the winch is applied. The transducer for measuring the current may be a clamp transducer (range 0-600 or 0-1000A, accuracy less or equal to 2%) or a calibrated resistor (0.1 milliohm, accuracy less or equal to 0.5%) in the negative path of the circuit. The resistance is calculated with the formula: Measurement with clamp transducer $R_{tot} = 1000 \times U_b / I_{300}$ Measurement with shunt $R_{tot} = (1000 \times U_b / I_{300}) - 0.1$ (R_{tot} in milliohms, U_b in volts, I_{300} in amperes)
- l) A first measurement is taken in order to check the correct functioning of the measuring equipment and is discarded. Three subsequent measurements should be made with an interval of at least two minutes after the previous test or launch. The total resistance of the winch equipment is the average of these three (3) respective results. Voltage and current must be displayed to be able to calculate the total resistance by hand. If the total resistance is calculated automatically then it must be shown simultaneously with the voltage and current values. The winch equipment is declared as being in accordance with the rules if its total resistance is at least 23 m Ω .
- m) At the test of the winch before the competition the voltage of the battery U_{300} must be greater or equal to 9V; this does not apply for testing during the competition.
- n) The organiser must appoint at least two processing officials, who will process the winches with a single measuring apparatus, or several measuring apparatus proven to produce reproducible results within a tolerance of 0.5 %.
- o) There must be a quick release mechanism on the power lead to the battery in order to remove power from the motor in an emergency. (Connections to the battery must be removable without the need for tools). If slotted pole shoes are used then both of them have to be slotted.
- p) The flight is penalised with 1000 points if the winch is not in accordance with the rules; this is valid for the flight before the test. The penalty of 1000 points will be a deduction from the competitor's final score and shall be listed on the score sheet of the round in which the penalisation was applied.
- q) After release of the model aircraft from the towline, the towline must be rewound without delay by operating the winch, until the parachute arrives at the turnaround device. During this procedure the towline should be guided by a helper to avoid damage to other competitors' towlines. The towline must be provided with a measure eg a stopper or a metal ring, to prevent it being drawn down through the towline pulley. Then, the towline(s) must be retrieved by hand to the winch. A winch must not be operated when the towline is lying on the ground and across other towlines or strikes another towline during launching
- r) The towline (which must be of non-metallic material except for linkages) must be equipped with a pennant having a minimum area of 5 dm². A parachute (5 dm² minimum area) may be substituted for the pennant provided it is not attached to the model aircraft and remains inactive until the release of the cable. During complete rewinding of the line on to the winch, the parachute, if used, must be removed and inactivated.
- s) In the case of Continental and World Championships, a maximum of six (6) winches and six (6) batteries may be used at any time on the winches line(s) by any working team. Interchanging among winches and batteries while keeping compliance with the minimum resistance rule is totally under the responsibility of the competitor.

- 5.6.8.3.** a) Tow persons are allowed no mechanical aids, other than pulleys, to facilitate towing but may use a hand reel (hand winch) to recover the towline after launching is complete.
- b) Immediately after release of the model aircraft from the launching cable, without delay the towline helpers must either recover the towline on a hand reel (hand winch) or, when a pulley is used, they must continue to pull the towline until it is completely removed from the towing area in order to avoid crosscutting with other lines which are still in a state of towing or will be used for towing.

This is not applicable if a line break occurs. In this case only the residual line attached to the ground or used by the towing helpers has to be removed from the launching area. A designated judge (launch line-manager) has to overview and control and, if necessary, - call on towline helpers to remove their lines from the launching area after the model aircraft is released. The pilot, whose towline helpers do not remove the tow line within 30 seconds after release of the pilot's model, shall be penalised by 100 points.

The penalty of 100 points will be a deduction from the competitor's final score and shall be listed on the score sheet of the round in which the penalty was applied.

- c) If towing with pulley, behind the pulley an unbreakable shield with diameter of minimum 15 cm must be fixed to protect the towing helpers against broken whipping line ends.

In the case of towing with a pulley, two helpers have to operate the pulley and one of the following preventive measures must be taken:

- The pulley and protective shield must be connected to a 5 mm minimum diameter cord arranged in a V , the arms of which must have a length of 1,5 to 3,0 metres and with hand loops on each end; or
- The pulley and protective shield must be connected to the centre of a sufficiently strong yoke of minimum 80 cm length with handholds at each end.

In the case of towing with a pulley, the towline end must be attached to a ground anchor, which is fixed by metal ropes to two additional safety pins. The length of the main stake must be at least 50 cm from the towline linkage. The safety stakes must be at least 30 cm long. The main stake must be driven into the ground to a depth at least 40 cm. The towline linkage must not exceed 10 cm above the ground. The ground anchor-dimensions and its setup could look like as shown in the drawing "Guideline for proven ground anchor setup".

- 5.6.8.4.** The Contest Director will designate a launching area. Tow-persons must remain within this area whenever they are launching a model aircraft.

- 5.6.8.5.** The launching device (hand-reel, pulley, anchor, if used, and all other equipment used during launch, except the launching cable with or without any attachment of maximum 5 cm³ or 5 grams) must neither come loose nor be released by the competitor or his helpers during the launch. The competitor will be penalised by the cancellation of his flight and no other attempt is permitted.

- 5.6.8.6.** Any model aircraft launched prior to the start of a group's working time must be landed as soon as possible and re-launched within the working time. Failure to comply will result in cancellation of the competitor's score for that round.

5.6.8.7. Towlines

- a) This point applies for hand launches and reels only.
- b) Tow-lines for each competitor must be laid out only during the competitor's five-minute preparation time and must be retrieved by the end of his working time.
- c) The length of the towline shall not exceed 150 metres when tested under a tension of 20 N.
- d) The towline must be made of polyamide monofilament material throughout its length. It must have pennant with an area of 5 dm². A parachute (of five (5) dm² minimum area) may be substituted for the pennant provided it is not attached to the model aircraft and remains inactive until the release of the towline. Linkages (couplings, knots, loops, etc.) of different material are permitted up to a total length of 1.5 metres. They shall be included in the total length of 150 metres.

5.6.9. Landing

- 5.6.9.1.** Before the contest commences, organisers must allocate a landing circle to each competitor. It is the competitor's responsibility to ensure that he always uses the correct circle for landing.

- 5.6.9.2.** Officials (timekeepers) must remain upwind of the 15 metre radius circle during the working time before the landing. The competitor and one helper are allowed inside the 15 metre radius circle.

5.6.9.3. After landing, competitors may retrieve their model aircraft before the end of their working time providing they do not impede other competitors or model aircraft in their group.

5.6.10. Scoring

5.6.10.1. The attempt will be timed from moment of release from the launching device to either:

- a) the model aircraft first touches the ground; or
- b) the model aircraft first touches any object in contact with the ground. Parts of launching devices (tow-lines) extending away from the ground shall not be interpreted as objects in contact with the ground; or
- c) completion of the group's working time.

5.6.10.2. The flight time in seconds shall be recorded to one decimal place.

5.6.10.3. A penalty of thirty (30) points will be deducted from the flight score for overflying the end of the group's working time for up to a maximum of one (1) minute.

5.6.10.4. A zero score will be recorded for overflying the end of the group's working time by more than one (1) minute.

5.6.10.5. A landing bonus will be awarded in accordance with distance from the landing spot marked by the organisers according to the following tabulation:

Distance from spot (meters)	points	Distance from spot (meters)	points
up to m	Points	up to m	Points
0.2	100	5	80
0.4	99	6	75
0.6	98	7	70
0.8	97	8	65
1.0	96	9	60
1.2	95	10	55
1.4	94	11	50
1.6	93	12	45
1.8	92	13	40
2.0	91	14	35
3	90	15	30
4	85	over 15	0

5.6.10.6. The distance for landing bonus is measured from the model aircraft nose at rest to landing spot allocated to the competitor by the organisers.

5.6.10.7. A contest number, derived from the matrix, must be allocated to each competitor, which must be retained throughout the qualifying rounds.

5.6.10.8. If the model aircraft touches either the competitor or his helper during the landing manoeuvre, no landing points will be given.

5.6.10.9. No landing bonus points will be awarded if the model aircraft overflies the end of the group's working time.

5.6.10.10. The competitor who achieves the highest aggregate of points comprising of flight points plus landing bonus points minus penalty points will be the group winner and will be awarded a corrected score of one thousand points for that group.

5.6.10.11. The remaining competitors in the group will be awarded a corrected score based on their percentage of the group winner's total score before correction (i.e. normalised for that group) calculated from their own total score as follows:

$$\frac{\text{Competitor's own score multiplied by 1000}}{\text{Highest points total scored in the group before correction}}$$

The corrected score shall be recorded (truncated) to one place after the decimal point.

5.6.11. Final Classification

- 5.6.11.1.** At the end of the qualifying rounds, a minimum of nine (9) competitors with the highest aggregate scores will be placed together in a single group to fly the fly-off rounds. At the discretion of the Contest Director, the number of competitors qualifying for the fly-off may be increased.
- 5.6.11.2.** The working time for each competitor who qualifies for the fly-off rounds will be of fifteen (15) minutes duration. As before, audible signal will be given at the start of the group working time, at exactly thirteen (13) minutes and at exactly fifteen (15) minutes.
- 5.6.11.3.** The scoring of the fly-off rounds shall be as in section 5.6.10.
- 5.6.11.4.** Final placing of the competitors who qualify for the fly-off shall be determined by their aggregate fly-off scores.

In the event that two or more competitors have the same aggregate fly-off score, final positions of those competitors shall be determined by their respective position in the qualifying rounds; the higher positioned competitor being awarded the higher final position.

- 5.6.11.5.** To establish the ranking for international team classification, add the final individual scores of three best members of the team. Teams are ranked according to the highest numerical score to lowest. In the case of a national team tie, the team with the lower sum of place numbers, given in order from the top, wins. If still equal, the best individual placing decides.

5.6.12. Weather Conditions and Interruptions

The maximum wind speed for F3J contests is twelve (12) m/sec two (2) m above the ground at the centre of the launch corridor. The start of the contest must be delayed or the contest has to be interrupted by the contest director if the wind speed exceeds twelve (12) m/sec measured three (3) times for at least twenty (20) sec in a time interval of five (5) minutes at the start and landing area.

In the case of rain, the contest director may interrupt the contest.

5.6.13. Advisory Information

5.6.13.1. Organisational Requirements

- a) The organisers shall ensure that each competitor has no doubt about the precise second that the group's working time starts and finishes.
- b) Audible indication may be by automobile horn, bell or public address system etc. It must be remembered that sound does not travel far against the wind; therefore the positioning of the audio source must be given some thought.
- c) To be a fair contest, the minimum number of fliers in any one group is four. As the contest proceeds, some competitors may be obliged to drop out for various reasons. When a group occurs with three (3) or fewer competitors in it, the organisers move up a competitor from a later group, ensuring if possible, that he has not flown against any of the others in previous rounds and of course that his frequency is compatible.

5.6.13.2. Time-keeper Duties

- a) Organisers must make sure that all who are to act as timekeepers are fully aware of just how important their duties are and to make certain that they are conversant with the rules particularly those that require quick positive action in order not to jeopardise a competitor's chances in the contest.
- b) The timekeepers will be responsible for handing transmitters to competitors prior to the start of the working time and for returning them to Control immediately after the end of the flight.
- c) The organisers must ensure that an official is nominated to note any competitor who overflies the end of the group's working time and to time his excess flight time.

5.6.13.3 Groups

- a) The composition of groups should minimise the situations where any competitor flies against another many times, except in the fly-off. It is recognised that, in practice, with certain numbers of competitors or where more than three rounds are flown, a situation where a competitor flies against another more than once may be unavoidable. This must be kept to a minimum.
- b) In order to minimise the time needed to run the contest, it is very important to arrange the starting order to get the minimum number of groups per round, with the maximum possible competitors in each group. It is recommended that groups with vacant starting positions are put at the end of each round, to keep space free for any reflights.

- c) The starting order has to ensure that, as far as possible, there are no competitors of the same team in the same group.

PAGE DELIBERATELY LEFT BLANK

5.7. CLASS F3K - HAND LAUNCH GLIDERS

5.7.1. General

This event is a multitasking contest where the RC gliders must be hand-launched and perform specific tasks.

5.7.1.1. Timekeepers

The organiser should provide a sufficient number of well-trained, official timekeepers in order to allow enough simultaneous flights at all time. The official timekeeper is not allowed to assist the competitor or his helper in any way. The competitor and his helper are entitled to read their results during the working time.

Official timekeepers may position themselves anywhere inside or outside the start and landing field in order to observe the flight. They must at all times ensure that they do not impede any pilot or model.

5.7.1.2. Helper

Each competitor is allowed one helper who is not allowed to become physically involved in the flight, except for retrieving the airplane, if it has landed outside the start and landing field. The helper is the only person allowed to help the competitor during his working time.

After the end of the working time the competitor and the timekeeper must sign the results of the round. If the result is not signed by the competitor, then the score for the round will be 0 points.

5.7.1.3. Transmitter Pound

The organiser should consider the need for a transmitter pound with reference to Volume ABR Section 4B, B11.2 - B.11.6.

5.7.2. Definition of model glider

5.7.2.1. Specifications

Model gliders are gliders with the following limitations:

Wingspan maximum 1500 mm

Weight maximum 600 g

Radius of the nose must be a minimum of 5 mm in all orientations. (See F3B nose definition for measurement technique.)

The model glider must be launched by hand and is controlled by radio equipment acting on an unlimited number of surfaces.

The use of gyros and variometers onboard the model glider is not allowed.

The model glider may be equipped with holes, pegs or reinforcements, which allow a better grip of the model glider by hand. The pegs must be stiff and an integral part of the model glider, and be neither extendable nor retractable. Devices, which do not remain a part of the model glider during and after the launch, are not allowed.

5.7.2.2. Losing a part of the model glider

If the model glider loses any part during the flight, then the flight shall be scored zero. If the model glider loses a part as a result of a mid-air collision or during the landing; that means after the first contact of the model glider with the ground, any object or person, then the flight is valid.

5.7.2.3. Change of model glider

Each competitor is allowed to use five model gliders in the contest. It is permissible to change parts between these five model gliders. The competitor may change his model gliders at any time as long as they conform to the specifications and are operated on the assigned frequency. The organiser has to mark the five model gliders and all interchangeable parts of each of the five model gliders.

Each competitor may only have one model glider in the start and landing field at any moment during the working time. Only the model gliders that are in a spare model area or in the start and landing field at the start of the working time may be used during the working time. To change model gliders, the 'old' one must be placed in the same spare model area as the 'new' one, before the 'new' one is taken out.

5.7.2.4. Retrieving of model glider

If the competitor lands the model glider outside the start and landing field during his preparation and working time, then it has to be retrieved back to the start and landing field either by the competitor or his helper. Other people are not allowed to retrieve the model glider. Illegal retrieving of the model glider by another member of his team will be penalised by disqualification in that round. If a person other than a competitor or his helper (such as spectator) accidentally moves or retrieves a competitor's model, that competitor will be entitled to a new working time.

While retrieving the model, it is not permissible to fly it back to the start and landing field. Launching outside the start and landing field in this situation will be penalised with 100 points that will be deducted from the final score.

5.7.2.5. Radio frequencies

Each competitor not using a Spread Spectrum Technology Transmitter must provide at least two frequencies on which his model glider may be operated, and the organiser may assign any of these frequencies for the duration of the complete contest. The organiser is not allowed to change the frequency assigned to a competitor during the event. The organiser may re-assign frequencies to competitors only if a separate fly-off is flown and only for the duration of the complete fly-off.

5.7.2.6. Ballast

Para B3.1 of Section 4b (builder of the model airplane) is not applicable to class F3K. Any ballast must be inside the model glider and must be fixed safely.

5.7.3. Definition of the flying field

5.7.3.1. Flying field

The flying field should be reasonably level and large enough to allow several model gliders to fly simultaneously. The main source of lift should not be slope lift.

5.7.3.2. Start and landing field

The organiser must define the start and landing field before the start of the contest. Within the start and landing field each competitor must have adequate space to conduct his launches and landings, at least 30 metres distance to any person in the start direction. The organiser should consider about 900 m² per competitor, (square of 30 m x 30 m).

The border line defining the start and landing field is part of the start and landing field.

Competitors may leave the start-and-landing field while flying their model glider. For starting their model glider and in order to achieve a valid landing (see 5.7.6.2) the competitor must be inside the start and landing field.

Areas for storage and changing of spare models must be defined outside but within 2 meters of the start and landing field. About 4 square metres must be available for each competitor in a group in each area.

5.7.4. Safety

5.7.4.1. Contact with a person

In order to guarantee the highest level of safety, any contact between a model glider being launched or a flying model glider and any other person (except the competitor) either in or outside the start and landing field has to be avoided. This includes contact that happens while the glider is flying or while the glider is being handled by the competitor between landing and launching.

If such contact happens on the start and landing field during the preparation time, working time or landing window, the competitor will receive a penalty according to paragraph 5.7.4.3. In addition, if the contact happens during the preparation or working time at the launch of the model glider, this will result in a zero score for the whole round

5.7.4.2. Mid air collision

In cases of mid-air collisions of two or more model gliders in flight, the competitors will not be granted reflights, nor will penalties be levied. However, affected competitors are entitled to a new working time if their models collide while one of the models is in the start phase.

The start phase is defined by the moment when the pilot releases his model glider, until it reaches the highest point.

5.7.4.3. Safety area

The organiser may define safety areas outside of the start and landing field, for protecting people and objects. The organiser must ensure that the safety areas are well defined, clearly marked and permanently monitored.

Contact of the model glider:

- i) with an object, including the ground, within the defined safety area will be penalised by deduction of 100 points from the competitor's final score.
- ii) while airborne with a person (except its pilot) within the defined safety area will be penalised by deduction of 300 points from the competitor's final score.
- iii) while airborne with a person (except its pilot) anywhere outside the defined safety area will be penalised by deduction of 100 points from the competitor's final score.

Each flight attempt may only incur a single penalty. If multiple safety infractions happened during the same flight attempt only the highest penalty will be applied. For example, if during the same flight attempt a competitor's model contacted a person and an object inside the safety area, the 300 points penalty will be applied.

In all of the above cases, if the infractions occurred as a result of a mid-air collision, no penalties will be levied, according to 5.7.4.2.

Penalties shall be listed on the score sheet of the round in which the infringement(s) occurred.

5.7.4.4. Forbidden airspace

The organiser may define forbidden airspace, flying inside of which is strictly forbidden at any altitude. If a competitor flies his model glider inside such a forbidden airspace, a notification is announced to the competitor. The competitor has to fly his model glider out of the forbidden airspace immediately and by the shortest route. . If not following this way the flight shall be scored zero.

For major events the declaration of forbidden airspace should only be used as a last resort if a field cannot be found that will allow the contest site to be set out free of such constraints.

5.7.5. Weather conditions / Interruptions

The maximum wind speed for F3K contests is eight (8) m/sec. The start of the contest must be delayed or the contest has to be interrupted by the contest director if the wind speed exceeds eight (8) m/sec measured three (3) times for at least twenty (20) sec in a time interval of five (5) minutes at two (2) metres above the ground at the start and landing field. In the case of rain, the contest director can interrupt the contest. When the rain stops, the contest starts again with the group that was flying, which receives a re-flight.

5.7.6. Definition of landing**5.7.6.1. Landing**

The model glider is considered to have landed (and thereby terminated its flight) if:

- (a) The model glider comes to a rest anywhere.
- (b) The competitor touches the airborne model glider for the first time by hand or any part of his body.

5.7.6.2. Valid landing

Landing is considered valid, if:

- (a) At least one part of the model glider at rest touches the start and landing field or overlaps the start and landing field when viewed from directly above (this provision includes any ground based object within the starting and landing field, as well as the tape marking the boundary of the landing field).
- (b) The competitor touches the airborne model glider for the first time, while standing on the ground with both feet inside the starting and landing field.

5.7.7. Flight time

The flight time is measured from the moment the model glider leaves the hands of the competitor until a landing of the model glider as defined in 5.7.6. or the working time expires.

The flight time shall be recorded to 0.1 seconds. Rounding up is not applied. ||

The flight time is official if:

The launch happened from inside the start and landing field and the landing is valid according to 5.7.6. and the launch happened within the working time of the task.

This means that if the airplane is launched before the beginning of the working time then that flight receives a zero score.

5.7.8. Local rules

Local rules may **be used only in cases of safety issues** in local flying areas, but not for changing tasks.

5.7.9. Definition of a round**5.7.9.1. Groups and round scores**

The contest is organised in rounds. In each round the competitors are arranged in as few groups as possible. A group must consist of at least 5 competitors. The composition of groups has to be different in each round.

The results are normalised within each group, 1000 points being the basis for the best score of the winner of the group. The result of a task is measured in tenths of seconds according to 5.7.7. The normalised scores within a group are calculated by using the following formula: normalised score = competitor's score / best competitor's score x 1000. The normalised scores are rounded to tenths of a point. |||

5.7.9.2. Working time

The working time allocated to a competitor is defined in the task list. The start and end of the working time must be announced with a distinct acoustic signal. The first moment, at which the acoustic signal can be heard, defines the start and end of the working time.

5.7.9.3. Landing window

No points are deducted for flying over the maximum flight time or past the end of the working time.

For all Tasks except Task C (All up), a 30 seconds landing window will begin at the end of the working time. Any model gliders still airborne must land before the end of the landing window. If a model glider lands later, then that flight will score zero.

For Task C (All up), the landing window for each flight attempt will begin at 3:03 and end at 3:33 after the start of the acoustic signal indicating the 3 second launch window. If a model glider lands after the end of the landing window, then that flight will score zero. If this happens between any two flight attempts of Task C, and the model glider is airborne during the special 60 second preparation time before the next flight attempt, the next flight attempt will also score zero according to 5.7.11.3. If this happens after the last flight attempt of Task C, the competitor will receive a 100 point penalty according to 5.7.9.4.

The organiser should announce the last ten seconds of the landing window by counting down.

5.7.9.4. Preparation time

For each round, the competitors receive at least 5 minutes of preparation time. This preparation time should ideally start 3 minutes before the end of the working time of the previous group (or at the beginning of the last flight attempt in Task C (All up) of the previous group), in order to save time.

At the beginning of a preparation time, the organisers must call the names and/or starting numbers of the competitors flying in the next group.

Before each working time, there must be a preparation time period of 60 seconds when flying is not allowed. ||

5.7.9.5. Flight testing time

After all the model gliders of the previous group have landed, the competitors flying in the next group receive 45 seconds of flight testing time, which is part of the preparation time. |||

During this flight testing time the competitors are allowed to perform test flights from the start and landing field.

The last 5 seconds before the start of the working time and before the end of the testing time have to be announced by the organiser. The first moment, at which the acoustic signal can be heard, defines the start and end of the testing time.

A competitor will receive a penalty of 100 points if he starts or flies his model glider outside of the testing time, working time or landing window of his assigned group.

Competitors may test fly before the transmitter impound and after the last working time of the day.

5.7.9.6. Re-Flights

The competitor is entitled to a new working time if his attempt could not be performed correctly due to organisers fault.

The new working time is to be granted to the competitor according to the following order of priorities:

- a) in a following group;
- b) if this is not achievable, then in a new group of a minimum of 4 re-flyers. The new group of re-flyers can be completed by other competitors selected by random draw. If the frequency or team membership of the drawn competitor does not fit or the competitor will not fly, the draw is repeated;
- c) if this also is not achievable, then with his original group at the end of the ongoing round.

In b) and c) above the better of the two results of the original flight and the re-flight will be the official score, except for the competitors (re-flyers) who are allocated the new attempt. For those, the result of the re-flight is the official score. A competitor of this group who was not allocated the new attempt will not be entitled to another working time in case of an organiser's fault.

5.7.10. Scoring

A minimum of five (5) rounds each with different tasks must be flown that the competition is valid.

5.7.10.1. Final score

The final score is the sum of the normalised scores of all rounds minus penalty points.

If twelve (12) or more rounds are flown then the lowest score is dropped.

The penalty points will be a deduction from the competitor's final score and shall be listed on the score sheet of the round in which the penalisation was applied.

The penalty points are retained even if the score of the round in which the offence occurred is dropped.

5.7.10.2. Resolution of a tie

In the case of a tie, the best dropped score defines the ranking. If the tie still exists, a separate fly-off for the relevant competitors will be flown to achieve a ranking. In this case the contest director will define one task that will be flown for the tie-break fly-off.

5.7.10.3. Fly-off

The organiser may announce a fly-off prior to the beginning of the event. For World and Continental Championships, the fly-off is mandatory for seniors. The fly-off should consist of at least three (3) rounds with a maximum of six (6) rounds. If less than three (3) fly-off rounds can be completed, the result of the preliminary rounds determine the final ranking.

A junior fly-off may be held with the maximum number of competitors being 2/3 of the seniors fly-off. A separate junior fly-off is not mandatory.

If a fly-off is flown, the points (including penalties) of the previous rounds are not considered.

5.7.10.4. Team Classification

To establish the ranking for international team classification, add the final individual scores of three best members of the team. Teams are ranked according to the highest numerical score to lowest. In the case of a national team tie, the team with the lower sum of place numbers, given in order from the top, wins. If still equal, the best individual placing decides.

5.7.11. Definitions of tasks

Detailed specifications including the tasks to be flown for the day must be announced by the organiser before the start of the contest. The tasks of the program are defined below. Depending on the weather conditions and the number of competitors, the tasks and the related working time may be reduced by a decision of the organiser as defined in the task description.

5.7.11.1. Task A (Last flight)

Each competitor has an unlimited number of flights, but only the last flight is taken into account to determine the final result. The maximum flight time is limited to 300 seconds. Any subsequent launch of the model glider annuls the previous time.

Working time: 7 minutes or 10 minutes

5.7.11.2. Task B (Next to last and last flight)

Each competitor has an unlimited number of flights, but only the next to last and the last flight will be scored.

Maximum time per flight is 240 seconds for 10 minutes working time. If the number of competitors is large, the maximum flight time may be reduced to 180 seconds and 7 minutes working time.

Example:	1st flight	65 s
	2nd flight	45 s
	3rd flight	55 s
	4th flight	85 s

Total score: $55\text{ s} + 85\text{ s} = 140\text{ s}$

5.7.11.3. Task C (All up, last down)

All competitors of a group must launch their model gliders simultaneously, within 3 seconds of the acoustic signal. The maximum measured flight time is 180 seconds.

The official timekeeper takes the individual flight time of the competitor according to 5.7.6 and 5.7.7 from the release of the model glider and not from the start of the acoustic signal. Launching a model glider before or more than 3 seconds after the start of the acoustic signal will result in a zero score for the flight.

The number of launches (3 to 5) must be announced by the organiser before the contest begins.

The preparation time between attempts is limited to 60 seconds after the end of the landing window. During this time the competitor may not perform test flights.

The competitor is not allowed any help during the flight testing time, working time or landing window.

The flight times of all attempts of each competitor will be added together and will be normalised to calculate the final score for this task.

No working time is necessary.

Example for 3 flights:

Competitor A:	$45\text{ s} + 50\text{ s} + 35\text{ s} = 130\text{ s} = 812.50\text{ points}$
Competitor B:	$50\text{ s} + 50\text{ s} + 60\text{ s} = 160\text{ s} = 1000.00\text{ points}$
Competitor C:	$30\text{ s} + 80\text{ s} + 40\text{ s} = 150\text{ s} = 937.50\text{ points}$

5.7.11.4. Task D (Two flights)

Each competitor has two (2) flights. These two flights will be added together. The maximum accounted single flight time is 300 seconds. Working time is 10 minutes.

5.7.11.5. Task E (Poker - variable target time)

Each competitor has an unlimited number of flights to achieve or exceed up to three (3) target times. Before the first launch of a new target, each competitor announces a target time to the official timekeeper. He can then perform an unlimited number of launches to reach or exceed, this time.

If the target is reached or exceeded, then the target time is credited and the competitor can announce the next target time, which may be lower, equal or higher, before he releases the model

glider during the launch.

If the target time is not reached, the announced target flight time cannot be changed. The competitor may try to reach the announced target flight time until the end of the working time. For the competitors last flight he may announce "end of working time". For this specific call, the competitor has ONLY one attempt.

The target time must be announced clearly in the official contest language or alternatively shown to the timekeeper in written numbers (e.g. 2:38) by the competitor's helper immediately after the launch. If the competitor calls "end of working time" the competitor's helper writes the letter "W".

The target(s) (1 - 3) with achieved target times are scored. The achieved target times are added together.

This task may be included in the competition program only if the organiser provides a sufficient number of official timekeepers, so that each competitor in the round is accompanied by one official timekeeper.

The working time may be 10 or 15 minutes.

Example:	Announced time	Flight time	Scored time
	45 s	1st flight 46 s	45 s
	50 s	1st flight 48 s	0 s
		2nd flight 52 s	50 s
	47 s	1st flight 49 s	47 s
	Total score is 142 s		

5.7.11.6. Task F (3 out of 6)

During the working time, the competitor may launch his model glider a maximum of 6 times. The maximum accounted single flight time is 180 s. The sum of the three longest flights up to the maximum of 180 s for each flight is taken for the final score.

Working time is 10 minutes.

5.7.11.7. Task G (Five longest flights)

Each competitor has an unlimited number of flights. Only the best five flights will be added together. The maximum accounted single flight time is 120 seconds.

Working time is 10 minutes.

5.7.11.8. Task H (One, two, three and four minute target flight times, any order)

During the working time, each competitor has an unlimited number of flights. He has to achieve four flights each of different target flight times duration.

The target flight times are 60, 120, 180 and 240 seconds in any order. Thus the competitor's four longest flights flown in the working time are assigned to the four target flight times, so that his longest flight is assigned to the 240 seconds target flight time, his 2nd longest flight to the 180 seconds target flight time, his 3rd longest flight to the 120 seconds target flight time and his 4th longest flight to the 60 seconds target flight time.

Only the flight time up to the target flight time is taken into account for scoring.

Working time is 10 minutes.

Example:	Flight time	Scored time
1st flight	63 s	60 s
2nd flight	239 s	239 s
3rd flight	182 s	180 s
4th flight	90 s	90 s

Total score of this task would be 60 s + 239 s + 180 s + 90 s = 569 s

5.7.11.9 Task I (Three longest flights)

During the working time, each competitor has an unlimited number of flights.

Only the best three flights will be added together. The maximum accounted single flight is 200 seconds.

Working time is 10 minutes.

5.7.11.10 Task J (Three last flights)

During the working time, each competitor has an unlimited number of flights, but only the three last flights will be scored.

Maximum time per flight is 180 seconds for 10 minutes working time.

Example: 1st flight 150 s
 2nd flight 45 s
 3rd flight 180 s
 4th flight 150 s
 Total score: 45 s + 180 s + 150 s = 375 s

5.7.11.11 Task K (Increasing time by 30 seconds, “Big Ladder”)

Each competitor must launch his/her model glider exactly five (5) times to achieve five (5) target times as follows: 1:00 (60 seconds), 1:30 (90 seconds), 2:00 (120 seconds), 2:30 (150 seconds), 3:00 (180 seconds). The targets must be flown in the increasing order as specified. The actual times of each flight up to (not exceeding) the target time will be added up and used as the final score for the task. The competitors do not have to reach or exceed the target times to count each flight time.

Working time: 10 minutes.

5.7.11.12 Task L (One flight)

During the working time, the competitor may launch his model glider one single time. The maximum flight time is limited to 599 seconds (9 minutes 59 seconds).

Working time: 10 minutes.

5.7.11.13 Fly-off Task M (Increasing time by 2 minutes “Huge Ladder”)

Each competitor must launch his/her model glider exactly three (3) times to achieve three (3) target times as follows: 3:00 (180 seconds), 5:00 (300 seconds), 7:00 (420 seconds). The targets must be flown in the increasing order as specified. The actual times of each flight up to (not exceeding) the target time will be added up and used as the final score for the task. The competitors do not have to reach or exceed the target times to count each flight time.

Working time: 15 minutes.

5.8 CLASS F3F - RADIO CONTROL SLOPE SOARING

5.8.1. **Definition:** This contest is a speed event for radio controlled slope gliders.

5.8.2. Characteristics of Radio Controlled Slope Gliders

Paragraph B.3.1 a) of Section 4B (Builder of the Model) is not applicable to class F3F.

Maximum surface area 150 dm²

Maximum flying mass 5 kg

Loading less than 75 g/dm²

The use of any onboard-sensed data to automatically move the control surfaces or to modify the aircraft geometry is prohibited.

Minimum radius of fuselage nose 7.5 mm in all orientations (see template below).

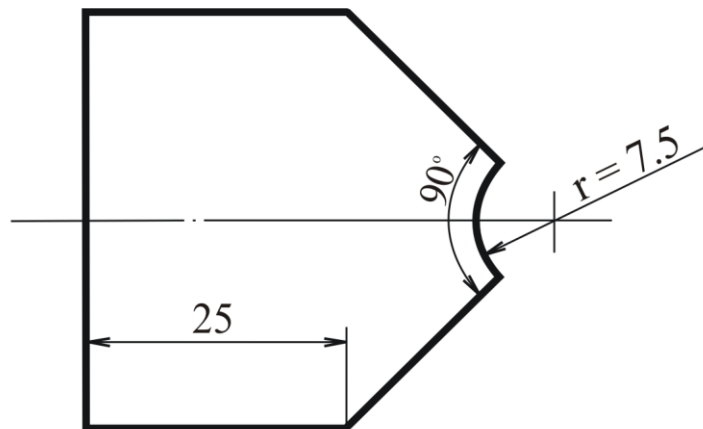

TEMPLATE FOR NOSE RADIUS AND MARKING

The radio shall be able to operate simultaneously with other equipment at the normally used spacing in the allocated R/C bands (i.e. 35 MHz : 10 kHz).

The competitor may use three models in the contest. The competitor may combine the parts of the models between the rounds provided the resulting model used for flight conforms to the rules and that the parts have been checked before the start of the contest. Addition of ballast (which must be located internally in the model) and/or change of angles of setting are allowed. Variation of geometry or area is allowed only if it is actuated at distance by radio control.

Any technological device used to aid in supplying data of the air's condition or direct feedback of the model's flight status is prohibited during the flight. These devices include any transmission or receiving devices not used to directly control the model. Telemetry of signal strength at the aircraft receiver and state of the receiver battery is permitted. The usage of corrective eyeglasses and sunglasses is permitted. If an infringement of this rule occurs, the pilot will be disqualified from the contest.

5.8.3. **Competitor and Helper:** The competitor must operate his radio equipment personally. Each competitor is permitted one (1) helper. The helper is only to assist and advise the competitor until the model is passing Base A for the first time in direction to Base B and after the scored flight is completed.

5.8.4. **Definition of an Attempt:** There is an attempt when the model has left the hands of the competitor or his helper.

5.8.5. **Number of Attempts:** The competitor has one (1) attempt on each flight. An attempt can be repeated if:

- a) the launching attempt is impeded, hindered or aborted by circumstances beyond the control of the competitor, duly witnessed by the official judges;
- b) his model collides with another model in flight or other impediment and the competitor is not to blame on that account;

- c) the flight was not judged by the fault of the judges.
- d) any part of the model fails to pass above a horizontal plane, level with the starting area, within five (5) seconds of exiting the course, due to circumstances beyond the control of the competitor, duly witnessed by the official judges.

The repeated flight ("re-flight") shall happen as soon as possible considering the local conditions and the radio frequencies.

5.8.6. Cancellation of a Flight: A flight is official when an attempt is carried out, whatever result is obtained.

A flight is official but gets a zero score if:

- a) the competitor used a model not conforming to FAI rules;
- b) the model loses any part while airborne;
- c) the helper advises the competitor during the timed flight;
- d) the model is controlled by anyone other than the competitor;
- e) the flight is not carried through;
- f) the model lands outside the assigned landing area;
- g) the model is not launched within 30 seconds from the moment the starting order is given.
- h) any part of the model fails to pass above a horizontal plane, level with the starting area, within five seconds of exiting the course.
- i) the model is not seen entering the course by the Judge at Base A.

5.8.7. Organisation of Starts: The flights are to be performed round by round. The starting order is settled by draw in accordance with the radio frequencies used.

The competitor is entitled to three (3) minutes of preparation time from the moment he is called to the ready box.

After the three (3) minutes have elapsed, the starter may give the order to start. After the starter has given the order to start, the competitor or his helper must launch the model within thirty (30) seconds by hand from the starting area indicated by the organiser.

If possible, the starting area, including the audio system, shall be situated in the middle of the course (equal distance from Base A and Base B).

The time from launch to the moment the model enters the speed course must not exceed thirty (30) seconds.

If the model has not entered the speed course (i.e. first crossing of Base A in the direction of Base B) within the thirty (30) seconds, the scored flight will commence at the moment the thirty (30) seconds expire. If the model has not entered the speed course within the thirty (30) seconds, this is to be announced by the contest director.

5.8.8. Task: The task is to fly ten (10) legs on a closed speed course of one hundred (100) metres in the shortest possible time from the moment the model first crosses Base A in the direction of Base B. If some irremovable obstacles do not allow one hundred (100) metres the course may be shorter but not less than eighty (80) metres. This exception does not apply for world or continental championships.

The competitor's model must be visible to the appropriate judge on the turns at Bases A and B.

5.8.9. The Speed Course: The speed course is laid out along the edge of the slope and is marked Base A and Base B with two (2) clearly visible flags. The organiser must ensure that the two (2) turning planes are mutually parallel and perpendicular to the slope.

Base A is the official starting plane. At Base A and Base B, an Official announces the passing of any part of the intact model in flight with a sound signal when the model is flying out of the speed course. Furthermore, a signal announces the first time the model is crossing Base A in the direction of Base B.

5.8.10. Safety:

The sighting device used for judging the turns must be placed in a safe position.

The organiser must clearly mark a safety line representing a vertical plane which separates the speed course for the timed flight (from leaving the hand until completing the scored flight) from the

area where judges, other officials, competitors and spectators stay. Crossing or multiple crossing the safety plane by any part of the intact model in direction to the safety area during the timed flight will be penalised by 100 points. The organiser must appoint one (1) judge to observe, using an optical sighting device, any crossing of the safety plane.

Additionally, the organiser must clearly mark the boundary between the landing area and the safety area assigned for other activities. After release of the model from the hand of the competitor or helper, any contact of the model with any object (earth, car, stick, plant, etc) within the safety area will be penalised by 100 points. Contact with a person within the safety area will be penalised by 1000 points. The number of contacts does not matter (maximum one penalty).

If there was an additional penalty of 100 points because of crossing the safety plane only 1000 points will be deducted. The penalty will be a deduction of 100 or 1000 points from the competitor's final score and shall be listed on the score sheet of the round in which the penalty was applied.

5.8.11. Judging: The flights are judged by two judges who do not have to be the same for all competitors.

The judges' task is to control that the flights are performed according to the rules, to be time keepers and to ensure that the right distance is flown.

5.8.12. Scoring: The result of the flight is stated as the time in seconds and hundredths of seconds obtained by each competitor. For the purpose of calculating the result of the round or group (see paragraph 5.8.16), the competitor's result is converted this way:

$$1000 \times \frac{P_w}{P}$$

where P_w is the best result in the round or group (see paragraph 5.8.16) and P is the competitor's result.

5.8.13. Classification: A minimum of four (4) rounds must be flown for the competition to be valid. In this case the lowest round score of each competitor will be discarded. If more than fourteen rounds were flown, the two lowest round scores will be discarded. The remaining results are added to obtain the final score which will determine the position of the pilot in the final classification.

To avoid ties in the classification concerning the five best scores, "classification rounds" are flown until the ties are broken. If this is not possible, the result of the discarded round will determine each competitor's position in the final classification.

5.8.14. Team Classification: To establish the ranking for international team classification, add the final individual scores of three best members of the team. Teams are ranked according to the highest numerical score to lowest. In the case of a national team tie, the team with the lower sum of place numbers, given in order from the top, wins. If still equal, the best individual placing decides.

5.8.15. Organisation of the Contest: The competition must be held at a site which is suitable for slope soaring.

When marking the starting and landing areas and the turning planes, the organiser must take into account the configuration of the terrain and the wind direction.

5.8.16. Changes: Any changes of the flight and landing areas may be made only between rounds or between groups.

5.8.17. Weather Conditions and interruptions: A round in progress must be interrupted if:-

- a) the wind speed is below three (3) m/sec or more than twenty five (25) m/sec for at least twenty (20) seconds two (2) metres above the ground at the flight-line.
- b) the direction of the wind constantly deviates more than 45° from a line perpendicular to the main direction of the speed course.
- c) In the case of rain.

If these conditions arise during the flight the contest director must interrupt the contest and the competitor is entitled to a re-flight.

The whole group must be divided into groups of equal size (+one (1) competitor) with a minimum number of competitors in one group of ten (10) before the round starts.

If the weather is stable during the whole round only one group is evaluated; if the competition must be interrupted more than thirty (30) minutes, then the interrupted group must start from the beginning and the results are evaluated for each group (see paragraph 5.8.12).

5.8.18 Site: The diagram of recommended F3F Flying Field Layout follows.

F3F Flying Field Layout

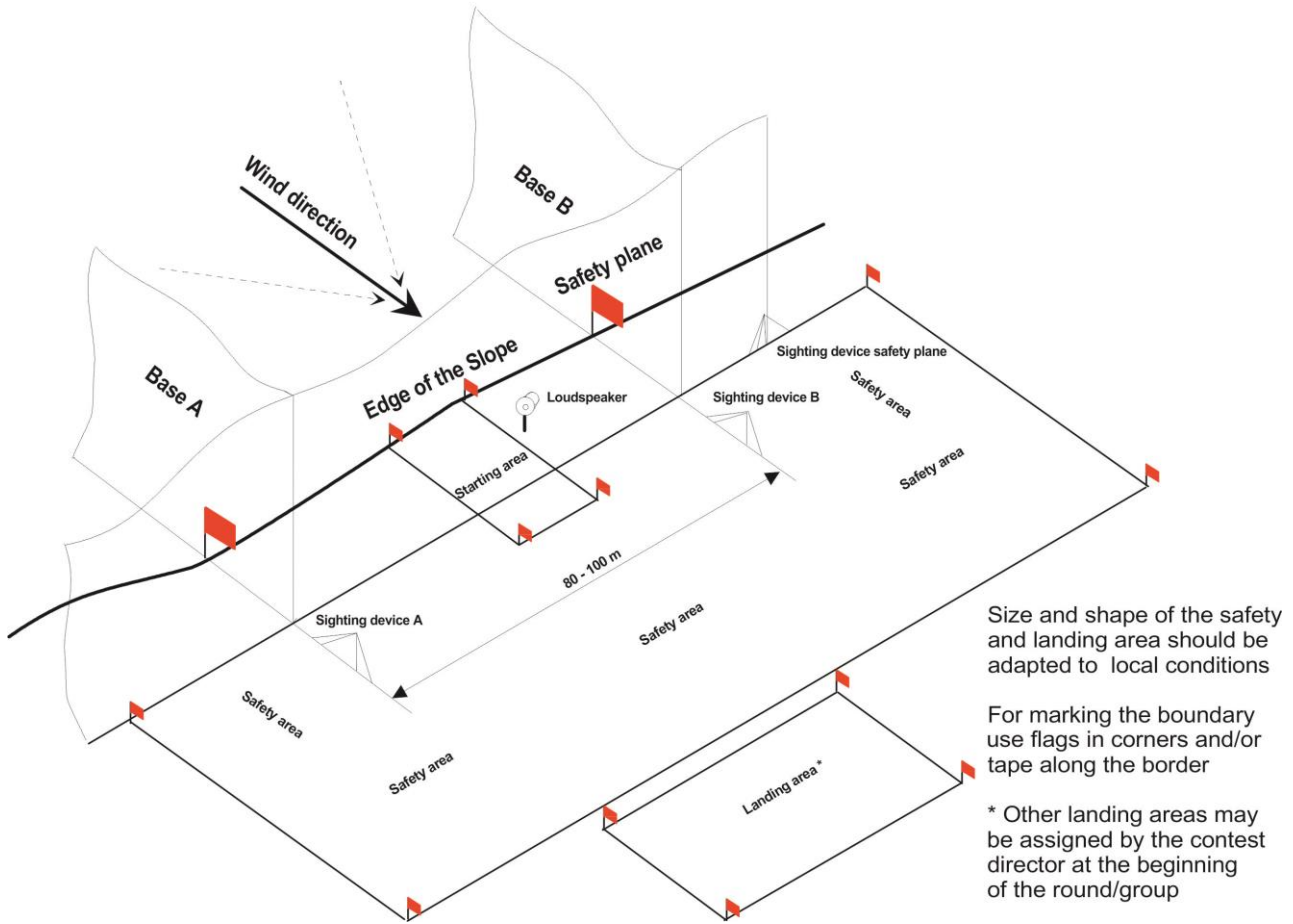

ANNEX 3A

RULES FOR WORLD CUP EVENTS

RC SOARING WORLD CUPS

1. **Classes:** The following separate classes are recognised for World Cup competition: F3B, F3F, F3K and F3J.
2. **Competitors:** All competitors in the open international contests are eligible for the World Cup.
3. **Contests:** Contests included in the World Cup must appear on the FAI contest calendar and be run according to the FAI Sporting Code. In the contests competitors of at least two different nations must take part. For the results to be counted as part of the World Cup the following number of rounds must be completed: F3B — 1 round and 1 task, F3F — 4 rounds, F3J — 4 preliminary rounds, F3K — 5 rounds all of different tasks.

4. Points Allocation

Points are to be allocated to competitors at each contest according to their placing in the results and to the number of participants as given in the following table and the conditions given below:

Placing	1	2	3	4	5	6	7	8	9	10	11	12
Points	50	40	30	25	20	19	18	17	16	15	14	13
Placing	13	14	15	16	17	18	19	20	21	22	23	24
Points	12	11	10	9	8	7	6	5	4	3	2	1

The number of competitors considered for the awarding of points is limited to those who gained a counted result.

The number of points awarded depends on the number of competitors. For every two competitors lacking to 51 one point is deducted from the points given in the table.

In the event of a tie for any placing, the competitors with that placing will share the points which would have been awarded to the places covered had the tie been resolved (round up the score to the nearest whole number of points).

5. Classification

The World Cup results are determined by considering the total number of points obtained by each competitor in the World Cup events. Each competitor may count the result of all competitions. In the case of more than three competitions in one country, the best results of a maximum of two competitions will count. To determine the total score, the results of up to three competitions may be counted, selecting each competitor's best results during the year. If there are more than three competitions in one country, the results of four competitions will be counted.

In the event of a tie the winner will be determined according to the following scheme. The number of counted events will be increased from three, one at a time not considering in which country the result was achieved, until the winner is obtained. If this does not separate the tied competitors then the winner will be determined by considering the points obtained in the best three events multiplied by the number of competitors flying in each event. The winner is the one with the greatest total thus calculated.

6. Awards

The winner earns the title of Winner of the World Cup. Certificates, medals and trophies may be awarded by the Subcommittee as available.

7. Organisation

The Subcommittee shall be responsible for organising the World Cup and may nominate a responsible person or special subcommittee to administer the event.

8. Communications

The F3 Soaring Subcommittee should receive the results from each contest in the World Cup and then calculate and publish the current World Cup positions. These should be distributed to the news agencies and should also be available by payment of a subscription to any interested bodies or individuals. Latest results will also be sent to the organiser of each competition in the World Cup for display at the competition. Final results of the World Cup are to be sent also to the FAI, National Airports Controls and model press.

9. Responsibilities of Competition Organisers

Competition organisers must propose their event for inclusion in the World Cup when nominating events for the FAI International Sporting Calendar. The final selection of events from these proposals is made by the CIAM Bureau as defined in paragraph 3.

Immediately after the event, the competition organiser must send the results to the World Cup organiser, at least within one month as required in the Sporting Code B.6.5. Any failure to return results promptly will be reviewed by the CIAM Bureau when considering the competition calendar for the following year.

10. World Cup Board

A Board of three persons shall be nominated by the CIAM RC Soaring Subcommittee Chairman to rule on any issue concerning the implementation of World Cup rules during a year. Any such issue must be submitted in writing to the RC Soaring Subcommittee Chairman and the Board. The World Cup Board is not entitled to deal with any kind of complaint or protest concerning a single competition, which must be considered by the FAI Jury for that competition.

PROVISIONAL RULES

CLASS F3G - RADIO CONTROLLED MULTI-TASK GLIDERS WITH ELECTRIC MOTOR

5.G.1. General Rules

5.G.1.1. Definition of a Radio Controlled Glider with Electric Motor

Model which is provided with an electric motor. Model with variable geometry or area must comply with the specification when the surfaces are in maximum and minimum extended mode. The model must be controlled by the competitor on the ground using radio control. Any variation of geometry and / or area must be actuated at distance by radio control.

5.G.1.2. Characteristics data of Radio Controlled Gliders F3G

Minimum wing-loading	35 g/dm ²
Maximum wing-loading	75 g/dm ²
Maximum flight mass	5 kg
Minimum wingspan	2,8 m
Maximum "Average Input power" 1)	800 W
Maximum energy	350 + 1 Wmin
Maximum run-time of the motor	30 + 0,1 s
Battery	Any type of rechargeable batteries (U ≤ 42 Volt)
Motor	Any type of motor
Minimum nose-/spinner radius 2)	7.5 mm (see template)

- 1) During the total energy-consumption of 350 Wmin
- 2) If a spinner with an air-inlet ($d \geq 6$ mm) for better cooling of the motor ("turbo spinner", "cool nose", etc.) is used, this rule is not valid.

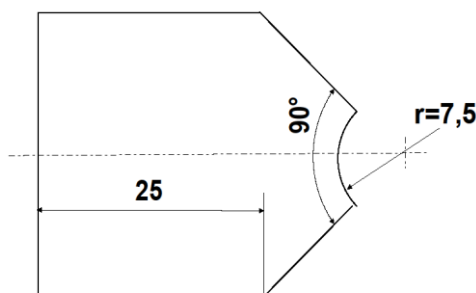

TEMPLATE FOR NOSE-/SPINNER-RADIUS

5.G.1.3. Technical equipment

- a) Each model must be fitted with an approved Logger (LOG) in accordance with the Technical Specification published in F3G LOG Technical Documentation.
- b) The LOG must be approved by the EDIC (ELECTRONIC DEVICES IN COMPETITIONS WORKING GROUP).
- c) The LOG is located in the electric circuit between the battery and the ESC (Electronic Speed Controller). The logger shall have for a random check the following connectors:
 - "Plus battery" male connector four (4) mm diameter
 - "ESC" female connector four (4) mm diameter
 - "Minus battery male / female connector four (4) mm diameter
- d) Installation of the LOG in the model shall be in accordance with the requirements as detailed in the Technical Guidance Documentation.

- e) Proper operation of the LOG including any associated display and its compatibility with other control equipment installed in the model is the responsibility of the individual competitor.
- f) To facilitate initial technical processing, the LOG must be easily removable for compliance checking.
The receiver command signal connection to the LOG must be easily accessible so that at any time during the competition the organisers have the option of installing a monitoring LOG via a branching Y lead.
- g) To enable the timekeeper to record data required for scoring purposes there must be easy access to the display or the connector for a plug-in-display. It must not be necessary to disconnect the LOG from the receiver and / or the ESC or to remove it from the model.
- h) The use of an additional extension cable is permitted for connecting the display. It is the responsibility of the competitor to ensure that any incorrect connection does not result in damage to the LOG or the display.
- i) Any device other than an approved LOG which is carried in or on the model and which enables total or partial independent control over the model's electric drive motor-operation, is prohibited. Receivers and ESC's are not affected by this rule.
- j) The functions of the LOG is to record "altitude", "voltage" and "current" and to represent "altitude", "average power", "amount of energy" and the "run-time of the motor" at a display.
- k) The motor can be stopped by the pilot or is stopped automatically after thirty point 0,1 (30.1) seconds or if the energy-limit of three hundred fifty plus one (350 + 1) Wmin is reached; afterwards the motor can't be switched on again.
- l) If the "average power" exceeds 800 W there is a penalty of two (2) point / one (1) Watt.
If the run-time of the motor exceeds 30,1 seconds or the energy-limit exceeds 351 Wmin the flight is penalised with 1000 points.
The number of infractions during one attempt does not matter (maximum one (1) penalty for one attempt).
The penalties will be a deduction from the competitor's final score and shall be listed on the score sheet of the round in which the penalisation was applied.
- m) LOG data must be shown to the official immediately after the flight.

5.G.1.4. General requirements

- a) No fixed or retractable arresting device (i.e. bolt, saw tooth-like protuberance, etc.) is allowed to slow down the model on the ground during landing.
- b) The use of any onboard-sensed data to automatically move the control surfaces or to modify the aircraft geometry is prohibited.
Any technological device used to aide in supplying data of the air's condition or direct feedback of the model's flight status is prohibited during the flight. These devices include any transmission or receiving devices not used to directly control the model aircraft (telephones, walkie-talkies, telemetry of airspeed and altitude etc.), temperature detecting devices (thermal imaging cameras, thermometers etc), optical aids (such as binoculars, telescopes etc.), and distance / altitude measuring devices (GPS, laser range finders etc.).
Telemetry of signal strength at the aircraft receiver and state of the receiver battery is permitted. Use of corrective eyeglasses and sunglasses are permitted. If an infringement of this rule occurs, the pilot will be disqualified from the contest.
- c) The competitor may use a maximum of three (3) models in the contest. All exchangeable parts (wing, fuselage, tail planes, canopy, joiner, maximal three (3) batteries / model) must be marked uniquely and in a way that does not allow replication of this mark on additional parts.
- d) The competitor may combine the parts of the model during the contest; provided the resulting model used for flight conforms to the rules and that the parts have been checked before the start of the contest. See also 5.G.2.1.

5.G.1.5. Competitors and Helpers

The competitor must operate his radio equipment personally. Each competitor is permitted up to three (3) helpers, including the team manager, who must not give any turning signals near base B during tasks B and C.

5.G.1.6. Definition of an Attempt

- a) For each task (ref. 5.G.2.1.), during the working time allocated, the competitor is entitled an unlimited number of attempts. An attempt starts when the motor of the model is switched on. No change of model or parts of the model (except a damaged propeller) is allowed after starting the first attempt.
- b) The competitor is entitled to a new working time period if any of the following conditions occur and are duly witnessed by an official of the contest:
 - 1) His model in flight collides with another model in flight, or another model in the process of launch (released for flight by the competitor or his helper).
 - 2) His model in the process of launch collides with another model also in the process of launch (released for flight by the competitor or his helper), or with another model in flight.
To claim a re-fly in the cases 1) and 2) the competitor must land his model as soon as possible after the collision. If the competitor continues his flight, he has waived his right for a new working time.
 - 3) The flight has not been judged by the fault of the judges or timekeepers.
 - 4) In the case of an unexpected event, outside the competitor's control, the flight has been hindered or aborted.
- c) The competitor has the right to change his model during a current round and this is not withstanding rule 5.G.2.1. if:
 - 1) His model collides with another model in flight; he has the right for a re-fly but his model is not reparable in time.
 - 2) His model has landed (final or intermediate landing) and is damaged by a landing model of another competitor and the model is not reparable in time.
 - 3) In the case of 1) or 2) above, once the competitor has exercised his right to change his damaged model, that model must not be used in any subsequent task(s) in the current round.
- d) In case of additional attempts in task A (Duration) or task B (Distance) during a round the competitors must fly within a group that is not complete in number or in one or more groups newly formed.

5.G.1.7. Definition of the Official Flight

The official flight is the last flight performed during the working time.

5.G.1.8. Cancellation of a Flight, Penalty and Disqualification

- a) Unless otherwise specified a flight in progress will be annulled for an infraction of any rule. In the case of intentional or flagrant violation of the rules, in the judgement of the Contest Director, the competitor may be disqualified.
- b) The flight in progress will be penalised with 100 points if the model loses any part either during the launch or the flight. The loss of any part in a collision with another model or during landing (i.e. in contact with the ground) is not taken into account. The penalty of 100 points will be a deduction from the competitor's final score and shall be listed on the score sheet of the round in which the penalisation was applied.
- c) The competitor is disqualified if the model in flight is controlled by anyone other than the competitor.
- d) If the model touches either the competitor or his helper during landing manoeuvres of task A, no landing points will be given.

5.G.1.9. Organisation of Starts

- a) The competitors shall be combined in groups with a draw, to permit as many flights simultaneously as possible. Incomplete teams may be to their request combined into a working team. The draw is organised in such a way that there are no competitors of the same working team in the same group. At World and Continental Championship the reigning champion, if participating outside the national team, may join his national team to form a working team.
- b) The composition of the groups must be changed every round in order to have different combinations of competitors. For task A-Duration there must be a minimum of five (5) competitors in a group.

For task B-Distance there must be a minimum of three (3) competitors in a group. For task C- Speed a group may consist of eight (8) competitors or all competitors.

It is preferable for the organiser to orientate the starting order for task C at the inverted ranking calculated out of the results of all tasks flown until that moment. For the first round the starting order for task C should always be identical with the starting order of task A. Alternatively the organiser may use the starting order for task A-Duration in subsequent task C-Speed rounds.

- c) The result of a group is annulled if only one (1) competitor has a valid result. In this case, the group will fly again and this result will be the official result.
- d) The flying order of different groups is established with the draw too. A different starting order shall be used for each round.
- e) The competitors are entitled to five (5) minutes of preparation time before the starter gives the order to count off the working time.

5.G.1.10. Organisation of Contests

- a) Transmitter pound see C.16.2.2
- b) Sighting apparatus or any device constituting an obstacle, should be placed on Base A and Base B, a minimum of five (5) metres from the safety plane for task C. Apparatus for judging the safety plane in task C shall be placed a minimum distance of five (5) metres from Base A or B outside the course.
- c) The contest director must inform without delay the competitor and / or his team manager about any decision taken, e.g. in the case of a re-fly, a penalty etc.

5.G.1.11. Safety Rules

- a) The organiser must clearly mark the boundary between the landing area and the safety area assigned for other activities. (See sketch "F3B/F3G flying field layout")
- b) After release of the model from the hand of the competitor or helper, any contact of the model with any object (earth, car, stick, plant, tow-line at combined F3B/F3B-E competitions, etc.) within the safety area will be penalised by 300 points, except in the circumstances described in paragraph 5.B-E.1.6 b) items 1, 2, 3, and 4. Contact with a person within the safety area will be penalised by 1000 points. The number of contacts during one attempt does not matter (maximum one (1) penalty for one attempt). The penalty will be a deduction of 300 or 1000 points from the competitor's final score and shall be listed on the score sheet of the round in which the penalty was applied.

5.G.1.12. Weather Conditions/Interruptions

- a) The maximum wind speed for E F3B contests is twelve (12) m/sec. The contest has to be interrupted or the start delayed by the contest director if the wind speed exceeds twelve (12) m/sec measured three (3) times for at least twenty (20) seconds in a time interval of five (5) minutes two (2) metres above the ground at the start and landing area.
- b) In the case of rain, the contest director can interrupt the contest during task A and task B. When the rain stops, the contest starts again with the last group that was flying; this group receives a re-fly.
- c) In the case of rain, the contest director must interrupt the contest during task C. When the rain stops the contest starts again with the last pilot that was flying; he receives a re-fly. The whole group of task C must be divided in a meaningful number of equal groups depending on the total number of competitors before the task starts. If the weather is stable only one (1) group is evaluated; if the competition must be interrupted more than fifteen (15) minutes, then the interrupted group must start from the beginning and the results are evaluated for each group.

5.G.2. RULES FOR MULTI-TASK CONTESTS

5.G.2.1. Definition

- a) This contest is a multi-task event for radio controlled gliders with electric motor, which includes three tasks:
 - A) Duration
 - B) Distance
 - C) Speed

- b) The combination of task A, B and C constitutes a round. A minimum of one (1) round and one (1) task must be flown that the competition is valid. The result of a World or Continental Championships is valid if five (5) complete rounds are flown; if more than five (5) complete rounds are flown, see paragraph 5.G.2.8. Classification.

At the discretion of the organiser any task may be flown first in a scheduled round. In the case of unstable weather conditions, lack of time or technical issues it is possible fly task A or task B of the following round before task C of the current round. No other change of the schedule is allowed. The scheduled task must be completed. If the model is damaged during the pre-drawn task A or task B the competitor is entitled to change the model for task C of the previous round.

- c) Any single round must be completed with the same model, without any change of parts, except the battery and a damaged spinner and/or propeller. Only the addition of ballast (which must be located internally the model) and with which the model must conform to rule 5.G.1.2. and/or change of angles of setting are allowed.

5.G.2.2. Launching / Relaunching

- a) All hand-launches and hand-relaunches (no start carriage and catapult) shall take place in an area as designated by the organiser with provisions made for launching into the wind (see “flying field layout”).
- b) The landing for a relaunch has to take place in an area designed by the contest director.
- c) For safety reasons it is not allowed to catch the model.
- d) The reset of the logger must be done manually; a reset via transmitter is forbidden.

5.G.2.3. Task A – Duration

- a) This task must be completed within twelve (12) minutes from the order of the starter, including the rise time.
- b) The model shall be launched in the direction(s) determined by the contest director. The maximum run-time of the motor is limited to thirty point one (30,1) seconds. One (1) point will be awarded for each full second from the time the motor is switched on to the time the model comes to rest on the defined flying site, up to a maximum of 600 seconds, or each full second of flight within the working time; if the model does not land on the defined flying site the whole flight is zero. No points will be awarded for flight time in excess of working time.
- c) One point will be deducted for each full second flown in excess of 600 seconds.
- d) The “start altitude” is the altitude attained above a ground level reference between the motor is switched on and ten (10) seconds after the motor is stopped.
 - 1) The “start altitude” shall be rounded down to the nearest metre.
 - 2) Each metre of the recorded “start altitude” results in a deduction of half (0,5) a second / metre up to 250 metres and three (3) seconds / metre above 250 metres.
 - 3) Where the score is negative (below zero), a zero score will be recorded.
- e) Additional points will be awarded for landing, depending upon distance from the spot marked by the organiser, according to the following table:

Distance from spot (m)	Points	Distance from spot (m)	Points
1	100	9	60
2	95	10	55
3	90	11	50
4	85	12	45
5	80	13	40
6	75	14	35
7	70	15	30
8	65	over 15	0

The distance is measured from the model nose (spinner) when at rest to the centre of the spot; the measured distance is rounded to the nearest higher metre.

No points will be awarded for the quality of landing and if the flight time exceeds 630 seconds.

- f) If a model has not come to rest when the twelve (12) minutes expire, the elapsed time only will be taken into consideration for scoring, without any additional points for the precision of landing.

- g) The motor can be stopped by the pilot or is stopped automatically after 30+0,1 seconds; or if the energy-limit of 350+1 W_{min} is reached; afterwards the motor can't be switched on again.
- h) Not allowed is to stop the motor automatically at a certain altitude boundary.
- i) A classification based on decreasing number of points awarded will be compiled, called "Partial Score A" - see 5.G.2.6.

5.G.2.4. Task B Distance

- a) The model shall be launched in the direction(s) determined by the contest director. The time between the motor is switched on and entering the course the first time at Base A in direction to Base B shall be equal or more than forty (40) seconds. The flight is penalised with 300 points if this time is less than forty (40) seconds. The penalty of 300 points will be a deduction from the competitor's final score and shall be listed on the score sheet of the round in which the penalisation was applied. Crossing Base A in the direction to Base B with running motor is penalized with a zero result.
- b) This task must be completed within seven (7) minutes from the order of the starter, including the rise time. The trial begins only after the motor has stopped.
- c) When the model, in flight, first crosses Base A (imaginary vertical plane) in the direction to Base B, the actual flight time of four (4) minutes maximum starts, during which time the model must complete as many legs as possible from the starting Base A to Base B and conversely.
- d) A visual system or a combined audio-visual system announces to the competitor when his model crosses Base A or Base B (imaginary vertical planes). The absence of a signal will indicate that the model has failed to correctly cross the base. The instruments used to check the crossing of the vertical planes must assure the parallelism of such planes. Timing and signalling shall occur when any part of the intact model in flight crosses the base. If an audio-visual system is used, signalling is also valid when the audio system fails.
- e) The models will be identified by flags of different colours for each competitor in the group. When the competitor intends to start his helper waves the flag; when the model is identified by the associated helpers at base A and base B they wave the flag with the corresponding colour as well. At that moment the pilot or his helper can launch the model. The competitor must stay within a distance of ten (10) metres either side of Base A during the timed flight.
- f) For a model which lands within four (4) minutes flight time only the full 150 metres legs will be counted. For model still in the air when the four (4) minutes flight time or seven (7) minutes expires, whichever comes first, only the completed legs at that moment will be taken into account.
- g) After having completed the task, the model must land on the defined flying-site outside the safety area(s) otherwise the flight is zero.
- h) A classification based on decreasing number of total flown legs during the flight time will be compiled, and points given as described in 5.G.2.6., thus establishing the "Partial Score B".

5.G.2.5. Task C – Speed

- a) The model shall be launched in the direction(s) determined by the contest director. The time between the motor is switched on and entering the course the first time at Base A in direction to Base B shall be equal or more than forty (40) seconds. The flight is penalised with 300 points if this time is less than forty (40) seconds. The penalty of 300 points will be a deduction from the competitor's final score and shall be listed on the score sheet of the round in which the penalisation was applied. Crossing Base A in the direction to Base B with running motor is penalized with a zero result.
- b) This task must be completed within four (4) minutes, from the order of the starter including the climb time. The trial begins only after the motor has stopped. The model must start the task at Base A within ninety (90) seconds after the motor was switched on. If the ninety (90) seconds period expires before the model has crossed Base A for the first time, flying from Base A to Base B the flight is penalised with 300 points. The penalty of 300 points will be a deduction from the competitor's final score and shall be listed on the score sheet of the round in which the penalisation was applied.

- c) The task consists of flying the distance starting from Base A to Base B, and conversely, four (4) legs in the shortest possible time.
- d) The flight time is recorded to at least 1/100 sec when the model in flight first crosses Base A at the predetermined side of the safety-plane and completes four (4) legs of the 150 metres course.
- e) An audio system will inform the competitor when the model crosses the Base A or Base B (imaginary vertical planes). The absence of a signal will indicate that the model has failed to correctly cross the Base. The instruments used to check the crossing of the vertical planes must assure the parallelism of such planes. The signal is given when any part of the intact model in flight crosses the base. The source of the signal (horn, loudspeaker) must not be further than thirty (30) metres away from the intersection of base A and the safety plane.
- f) During the timed flight the competitor must stay within a distance of ten (10) metres either side from Base A.
- g) After having completed the task, the model must land on the defined flying-site outside the safety area(s) otherwise the flight is zero.
- h) Model which comes to rest before having completed the task will score zero.
- i) During task C the timed flight shall take place to one side of the safety plane, whilst all judges/time-keepers shall remain on the other side of the safety plane. The side which is to be flown shall be indicated by the organisers taking into account the direction of the sun, etc. The flight will be penalised with 300 points, when sighted by means of an optical aid, the safety plane is crossed or multiple crossed by any part of the intact model. The instrument used to check the crossing of the vertical safety plane must also assure that the safety plane is orthogonal to Base A and Base B. The penalty of 300 points will be a deduction from the competitor's final score and shall be listed on the score sheet of the round in which the penalisation was applied.
- j) After the stop of the motor, when the model has crossed Base A flying in the direction to Base B, no further attempt is permitted unless the competitor signals his intention to re-launch before Base A is crossed.
- k) A classification based on increasing times to complete the four 150 metres legs will be compiled, and points given as described in 5.G.2.6., thus establishing "Partial Score C".

5.B-E.2.6. Partial Scores

- a) Partial Score for Task A for each competitor is determined as follows:

$$\text{Partial Score A} = 1000 \times P1 / PW$$

$$P1 \leq 250 \text{ m} = \text{Flight [s]} - 0,5 \times \text{height-start altitude [m]} \text{ (5.B-E.2.3.)}$$

$$P1 > 250 \text{ m} = \text{Flight [s]} - ((250 \text{ [m]} \times 0,5) + (3 \times (\text{height-start altitude [m]} - 250 \text{ [m]}))) \text{ (5.B-E.2.3)}$$

PW = points of the winner in the related group.

- b) Partial Score for Task B for each competitor is determined as follows

$$\text{Partial Score B} = 1000 \times D1/DW$$

Where D1 = distance covered by the competitor as for 5.G.2.4.

DW = distance covered by the winner in the related group.

- c) Partial Score for Task C for each competitor is determined as follows

$$\text{Partial Score C} = 1000 \times TW/T1$$

Where T1 = time of the competitor as for 5.G.2.5.

TW = time of the winner in the related group.

5.G.2.7. Total Score

The competitor's Total Score for each round is compiled by adding the Partial Scores of all tasks.

5.G.2.8. Classification

If only five (5) rounds are flown, the competitor's classification is determined by the sum of all Total Scores for each round. If more than five (5) complete rounds are flown the lowest partial

score of each task with more than five (5) results is omitted from the sum of all partial scores. To decide the winner when there is a tie, the two (2) (or all who have the equal score) competitors will fly an additional round (duration, distance and speed).

5.G.2.9. Site

The competition must be held at a site having reasonably level terrain, with a reasonably low probability of slope or wave soaring.

F3B / F3G Flying Field Layout

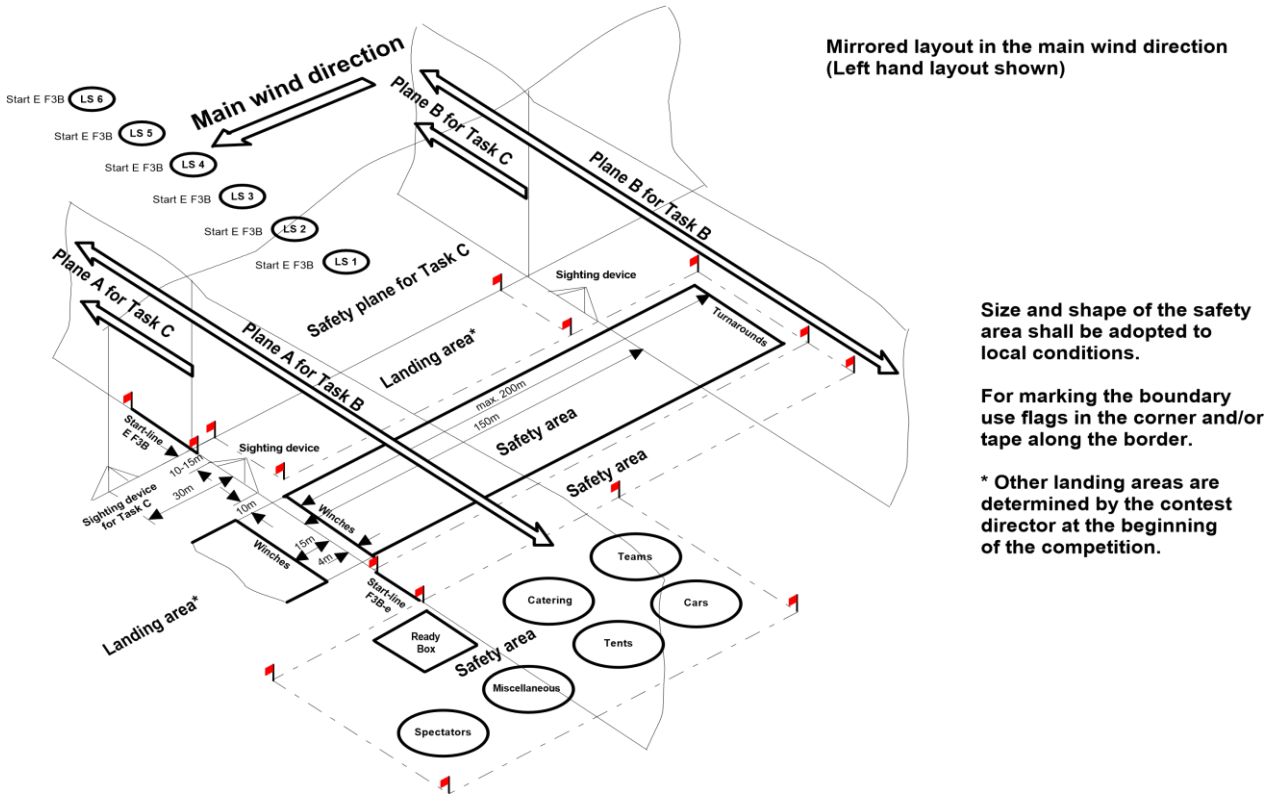

For a combined F3B / F3G competition the launch of the F3G models takes place at the “start-line(s) E F3B”.

For an F3G competition the launch takes place at the “start-line E F3B” (former F3B winch-line).

PROVISIONAL RULES

CLASS F3H - RADIO CONTROLLED SOARING CROSS COUNTRY RACING

5.H.1. Rules for Entry

- a) Open to any country affiliated with the FAI member National Airports Control.
- b) Each National Airports Control may enter up to two teams. A team consists of a pilot and up to two helpers, all of whom must be in possession of an FAI Sporting Licence, from their National Airports Control.
- c) Each team shall include one timer who will be assigned by the organisers as official timer for another team. The official timer shall also be responsible to certify distance travelled if less than the full course distance.
- d) Each team may enter any number of gliders. Each glider must be flown on the same assigned frequency.
- e) There is no restriction on the type or number of chase ground vehicles. Suitable space must be provided in one of the vehicles for the official timer.
- f) All gliders shall fall within FAI limitations with regard to size and weight. (Refer to 5.3.1.3., Characteristics of Radio Controlled Gliders).
- g) There is no restriction on the number of controls or sensors.
- h) All ballast must be carried internally and cannot be jettisonable except for water ballast.
- i) All gliders shall bear the FAI Sporting Licence number and/or the FAI Unique ID number and national flag of the primary flyer.

5.H. 2. Description of Task

- a) Object is to fly the course non-stop with one model. Fastest time wins. Any pilot of the team may fly the model.
- b) If all flights are less than the course length then the longest distance flown wins. In the case of ties, the shortest time will determine the winner.

5.H. 3. Description of Course

- a) Depending on local conditions, the course may be any of the following:
 - 1) Point A to Point B, (distance to a goal);
 - 2) Point A to Point B to Point C, (broken leg distance to a goal);
 - 3) Point A to Point B and return to Point A, (out and return);
 - 4) Distance around a closed course with three or more turn points (triangle, quadrilateral etc.);
 - 5) Free distance
- b) On the days of the competition, the organiser shall define the nature and length of the course to be consistent with the local wind and weather conditions which exist and/or are forecast for that day.
- c) The exact nature and length of the course will be announced by the organiser at a pilots' briefing held on the day of the event. A different task may be used on each day of a multi-day competition.
- d) Minimum course length for a World Championship event shall be 20 km. A World Championship event shall include at least three days of official flying.
- e) It is the responsibility of the organiser to provide sight gates and observers at the turn points, if any.

5.H.4. Launching

- a) All launching shall be by electric winches which shall be set-up and remain in a launch area designated by the organiser.
- b) Winches may be supplied by the organiser or may be supplied by the teams.
- c) Winches will be 12-volt launch systems with a maximum line length of 600 metres with the turn-around located 300 metres from the winch.

- d) The towline must be equipped with a pennant having a minimum area of 5 dm² (77.5 in².) A parachute (5 dm².) may be substituted for the pennant provided it is not attached to the model and remains inactive until the release of the cable.
- e) More than one team may share the use of the same winch.
- f) Each team will provide and is responsible for its own line retrieval.
- g) To prevent lines from fouling on the ground, immediately after release from the glider, every towline must be wound down to the turnaround. Failure to do so will allow the organiser to add a five minute time penalty to the flight time.

5.H.5. Flight Rules

- a) All launching sequences shall be at each team's discretion.
- b) Re-launches on the course are not permitted.
- c) Flight time for each attempt will begin only when the glider crosses the start line in the direction of the course. Prior to crossing the start line, the pilot is responsible to inform the officials that he is making a start. Flight time stops when any of the following occurs:
 - 1) the glider crosses the finish line; or
 - 2) the pilot declares the glider is lost; or
 - 3) the glider touches the ground.
- d) A team may change planes with no restrictions other than the initially assigned frequency must be used.
- e) Any number of attempts will be allowed within the contest time period; the best flight each day will be used in the final scoring.
- f) Once on the course the chase vehicle(s) must travel the designated route except for possible off-course retrievals.
- g) The glider need not fly directly over the prescribed route.
- h) In the event of off-course landings (less than full course length) the point of landing shall determine the distance flown.
- i) If the glider is destroyed in flight or goes out of sight for a period of not less than five minutes, the official timer will log its point of furthest progress up to that point.

5.H.6. Scoring

- a) The winner of each task shall receive 1000 points.
 - 1) Except for Free Distance, the fastest finisher is the winner of the task. If there are no finishers, the winner is the team which flew the longest distance.
 - 2) In Free Distance, the winner is the team which makes the longest distance flight.
- b) When a team lands off course, an imaginary perpendicular line from the course to the landing spot shall determine the distance flown. A marker shall be placed by the official timer at the projected point on the course.

c) Score Computations:

1) If there is a finisher:

Fastest finishing team's score:

$$\text{Score} = 1000$$

Other finishing teams' score:

$$\text{Score} = 700 + \left(\frac{T_w}{T_i} \times 300 \right)$$

Non-finishing team's score:

$$\text{Score} = \frac{D_i}{D_w} \times 700$$

Where:-

T_i = team's time to finish the course;

T_w = fastest time to finish the course;

D_i = team's distance flown;

D_w = distance of the task.

2) If there are no finishers, then each team receives a score as below:

Longest Distance Flight = 1000 points

$$\text{Score} = 1000 \times \frac{D_i}{D_w}$$

Where:

D_i = team's distance flown;

D_w = longest distance flown

3) The overall winner shall be determined by adding together all the daily scores.

5.H.7. Organiser Responsibility

- a) Provide sufficient personnel to ensure that all rules are observed and that the correct distances are measured.
- b) Control all frequencies assigned to the competing teams to ensure that each team has a clear frequency.
- c) Provide a map to each team describing the course area and pertinent features at least one month prior to the start of the event.

PAGE DELIBERATELY LEFT BLANK

PROVISIONAL RULES

CLASS F3Q - RADIO CONTROLLED AERO TOW GLIDERS

5.Q.1 General

5.Q.1.1 Definition of an Aero Tow soaring contest

An aero tow soaring contest is made of successive rounds comprising a speed and a duration task. The gliders are towed up to 200 metres altitude by a model aircraft tug.

The two tasks of any round must be performed with the same glider, without any change of component; the model weight must be identical for the two tasks.

The model glider must be flown by radio by a pilot staying on the ground.

The competition must take place on a reasonably flat and horizontal airfield with very low probability of slope or wave lift.

As soon as the model glider is hooked to the tug aircraft, the competitor must use his radio equipment by himself. He is entitled to one helper in the course of any task from the beginning of the take-off run.

5.Q.1.2 Models and equipment

5.Q.1.2.1 Aerotow gliders

- a The models shall have an appearance similar to full-size gliders.
- b The fuselage shall have a transparent canopy, similar to the ones in use on full-size gliders.
- c Aerotow glider characteristics:
 - i Maximal mass in flight order5.0 kg
 - ii Minimal wingspan3.50 m
 - iii The fuselage width at the master cross-section, not including the wing fillets, must be at least equal to 3.2 % of the glider's wingspan (example: 400cm x 3.2 % = 12.8 cm).
 - iv The fuselage height measured at the master cross-section must be at least equal to 4% of the glider wingspan (example: 400 cm x 4 % = 16 cm).
- d The variable geometry models must be in accordance with the rules in any configuration.
- e Any change of geometry or area must be actuated at distance by radio control.
- f The glider must be fitted with a towing device working with a simple nylon loop and located not more than 10 cm behind the model glider's forward point.
- g The glider must be fitted with a wheel providing a minimum of 1 cm clearance at take-off, measured with the glider on a horizontal surface.
- h Prefabrication of the model aircraft. Paragraph B.3.1 a) of Section 4, Part 2 (builder of the model aircraft) is applicable to this class. The only models allowed are those built by the pilot from ready-made parts and in which he installs the equipment.
- l Technical control : every competitor shall declare that his model glider(s) conform to the Sporting Code. If the competitor uses a glider which is not in accordance with the rules, he shall be disqualified

5.Q.1.2.2 Aerotow model aircraft tug

- a The organiser shall make tugs and pilots available to tow the gliders up to altitude. The tugs shall be able to tow the gliders up to 200 metres of altitude in less than 90 s. The tug model aircraft shall be in accordance with the Sporting Code and the pilots shall have the required qualification and accreditation.
- b The towing cable must be 25 metres long and must be fitted with a nylon loop at each end. A red pennant shall be attached to the cable to improve visibility.
- c The tug must be fitted with an altimeter.
- d The tugs' altimeters must be calibrated at the contest's opening and at the beginning of every day of contest. In the course of the day, the Contest Director may ask the tug pilots to perform a calibration flight in order to verify that releases are made at identical altitude.

5.Q.1.2.3 Radio equipment

- a Every competitor must have at least two different frequencies available with a minimum 20 kHz spacing. The contest director shall decide which frequency shall be used by the competitors in order to establish flight groups of four pilots (or a minimum of three).

5.Q.1.3 Officials required for an F3Q contest

For organisational purpose, an official may simultaneously hold several functions.

- a - Contest Director: He runs the contest, manages the officials, and ensures the smooth running of the contest in all respects, especially regarding compliance with rules and safety.
- b - Timekeepers: They time the tasks and flights duration.
- c - Field Marshall: He watches the model gliders at take-off and landing (tugs and gliders). He manages the whole runway security/safety.
- d - Aerotow Pilots: They are in charge of towing the gliders up to release altitude.

5.Q.2 Contest technical and sporting rules**5.Q.2.1 Definition of a round**

- a A round is made of two tasks, each of them scored as a percentage of the task winner's 1000 points.
 - i. A speed flight task over 1,000 metres distance made up of two laps, each of two 250 metre legs, between two parallel imaginary vertical planes 250 metres apart.
 - ii. A duration task of an 8-minute flight ending with a precision landing in a rectangular landing box 20 metres wide and 40 metres long.

5.Q.2.1.2 Organisation of a round

- a The tasks may take place in any order within a round.
- b The previous round must be completed before beginning a new round.
- c The competitors' starting order is established by a draw before the beginning of any round.
- d The aero tow tugs release the gliders at 200 metres altitude. This altitude is automatically measured by an onboard altimeter.
- e The competitors are allowed two model gliders during a contest.
- f The two tasks of any round must be carried out with the same glider, without any change of elements, except in the case of a collision with another model glider in flight. However, the pilot can assemble a model made of components from the two gliders, provided the resulting model glider conforms to § 5.Q.1.2.1. The competitor must inform the Contest Director whenever he changes to another model glider. This change must be registered in the results list.
- g While on the ground, the only allowed changes are switching radio frequency, model wing and empennage angle of attack and centre of gravity position.
- h In flight, lifting area, angle of attack and centre of gravity may be altered by remote control.
- i Any in-flight altitude measuring device (altimeter or variometer) is forbidden.
- j During aero tow a competitor may chose any flight path he wants and shall instruct the tug pilot accordingly, provided the safety guidelines set by the Contest Director are followed.
- k Any competitor not taking part in a round receives a zero score for that round

5.Q.2.1.3 Timing

- a The flight's timing shall be done by one timekeeper with two stopwatches used simultaneously.
- b An official times a 2 minutes preparation time, starting the moment the competitor is called for his flight

5.Q.2.1.4 Processing

The weight of the model gliders must be checked at random before and after the speed and duration flights of each round. The gliders to be processed shall be chosen by means of a draw. The selected competitors shall be instructed at the end of a flight that they have to bring their glider to the weighing station. A minimum of 20% of the gliders must be checked during each round.

5.Q.2.2 Speed task**5.Q.2.2.1 Definition of a speed task**

- a The speed task is flown over four legs between two parallel, virtual vertical planes ('A' & 'B') 250 metres apart. The glider must cross the virtual vertical planes 5 times from initial entry to final exit for the flight to be valid.
- b Speed flight definition. The glider crosses the start plane 'A', toward 'B'; crosses the 'B' plane, flies back to plane 'A' and crosses this plane to complete a first lap. It then repeats this sequence to complete a second lap. The flight is complete at the moment the glider crosses

plane 'A' out of the course at the end of the second lap. The flight is valid, even if the glider touches the ground during the timed part of the flight. A vertical plane is deemed to have been crossed when the nose of the glider has flown through it.

- c At both 'A' & 'B' vertical planes, a sighting device is used to assess the moment the glider nose crosses the vertical plane. An acoustic or optical system signals the crossing to the pilot.
- d A virtual vertical plane perpendicular to the turning planes limits the flight space. Flights must be on the safety plane side defined by the Organiser and nobody shall be allowed on that side. If any part of the model crosses the safety plane in flight, the flight is scored zero.

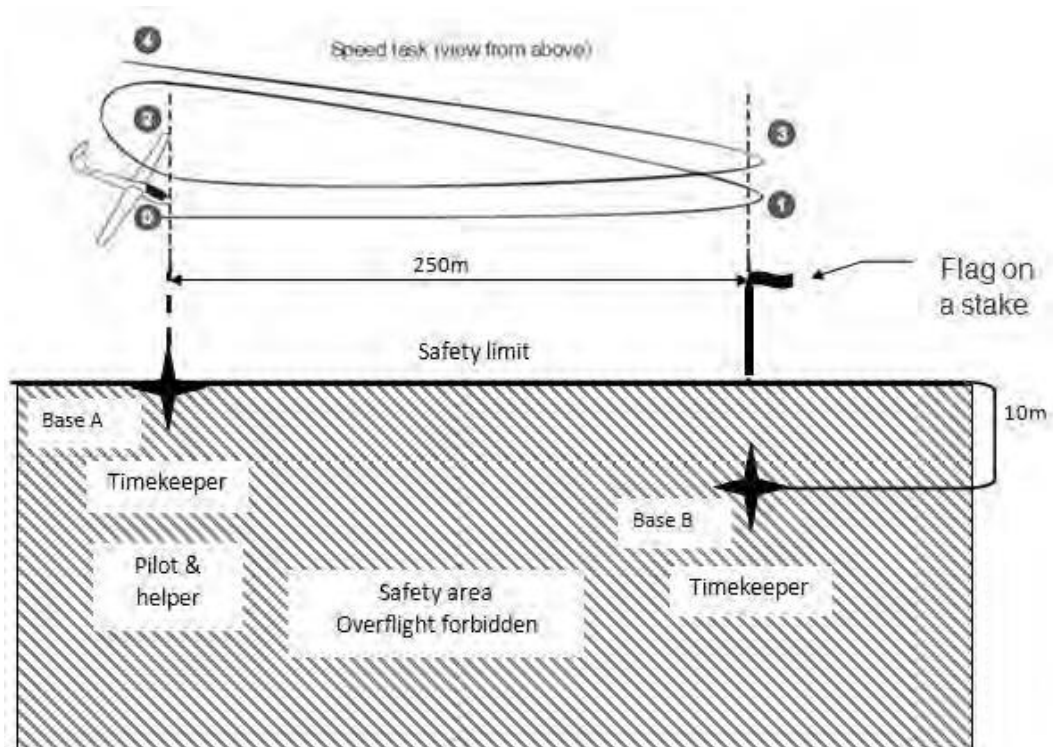

5.Q.2.2.2 Speed task organisation

- a Competitors are allowed a 2-minute preparation time before take-off from the moment they are called for their flight. The attempt shall be deemed to have taken place if at the end of the preparation time, the model glider is not ready to take off.
- b Only timekeepers are allowed to tell the glider's position relative to the starting plane at the competitor's request.
- c The glider must cross the starting plane 'A' towards plane 'B' between 10 and 120 seconds after release from the tug. The timed part of the flight begins when, after release, the glider crosses the starting plane 'A' for the first time towards plane "B" and ends when the glider crosses the starting plane out of the course when completing the second lap.
- d A timekeeper times the flight and may inform the competitor of the time remaining for crossing the starting plane A for the beginning of the timed portion of the flight..

5.Q.2.2.3 Speed task attempt

- a The competitor may choose to abort his flight and to make a second attempt at any time between the glider's take-off and the beginning of the timed part of the flight.
- b A flight is considered to have been attempted if :
 - i The glider is not ready to take off at the end of the 120 seconds preparation time;
 - ii The aero tow is interrupted for any reason due to the competitor;
 - iii Every competitor is allowed two attempts. If the first attempt is not successful, the second attempt is the one to be validated, whatever the result.

5.Q.2.2.4 Speed task reflight

A reflight may only be allowed by the Contest Director. The flight is repeated if:

- a The flight has not been properly timed by the timekeepers.
- b The aero tow is interrupted for any reason outside of the competitor's responsibility.

cont/...

5.Q.2.2.5 Speed flight cancellation

The flight is cancelled and the task is scored 0 (zero) if:

- a The glider is not ready to take-off at the end of the second attempt preparation time;
- b The glider in flight crosses the safety line;
- c The glider does not complete the two laps;
- d The glider loses any part during the timed portion of the flight.

5.Q.2.2.6 Speed task scoring

- a The time to complete the two laps course is recorded and rounded to the lowest tenth of second (example: 32.48 seconds = 32.4 seconds).
- b The best result from a group is awarded a 1000 points score. Other times are scored relative to the best score over a 1000 points scale (rounded down to one place after the decimal point).
- c If a speed task lasts two days, scores are computed separately for each day.
- d The partial score (**PS**) for each competitor's speed task is :

- $PS = (1000 \times BT / CT)$

- **BT** = Best time

- **CT** = Competitor's time

Example : Best time (BT) = 32.0 seconds

- The competitor timed 32.0 seconds scores 1,000 points.
- The competitor timed 32.6 seconds scores 981.60 points (1,000 X 32 / 32.6).
- The competitor timed 43.0 seconds scores 744.20 points (1,000 X 32 / 43).

5.Q.2.3 Duration task**5.Q.2.3.1 Duration flight**

The aim of the duration task is to fly for 8 minutes after release from the tug aircraft at 200 metres altitude. Landing must be in the same direction as take-off in a rectangular landing box 40 metres long and 20 metres wide. The glider must not rotate more than 90° from the landing box length axis at touch down.

5.Q.2.3.2 Duration task organisation

- a Competitors are arranged in groups of 4 pilots. Groups of 3 competitors, but not less, may be setup to complete the roster.
- b The aero tow duration between take-off and glider release must not exceed 90 seconds.
- c The time span between the first and the last glider releases of any group must not exceed 10 minutes for a group of 4 competitors or 7 minutes 30 s for a group of 3 competitors.
- d Definition of the landing box : A 40 m x 20 rectangle marked on the ground and with its length parallel to the runway axis.
- e Definition of the landing point : The point located directly under the model nose after landing.
- f Definition of a correct landing : The glider must approach the landing box over its downwind side (see drawing).
- g Once the glider comes to rest at landing, its nose must be inside the landing box
- h After landing the glider must point to the take-off and landing direction and must not have rotated more than 90 ° relative to the landing box length axis.

The landing box diagram appears overleaf

Duration Take-off & Landing Box

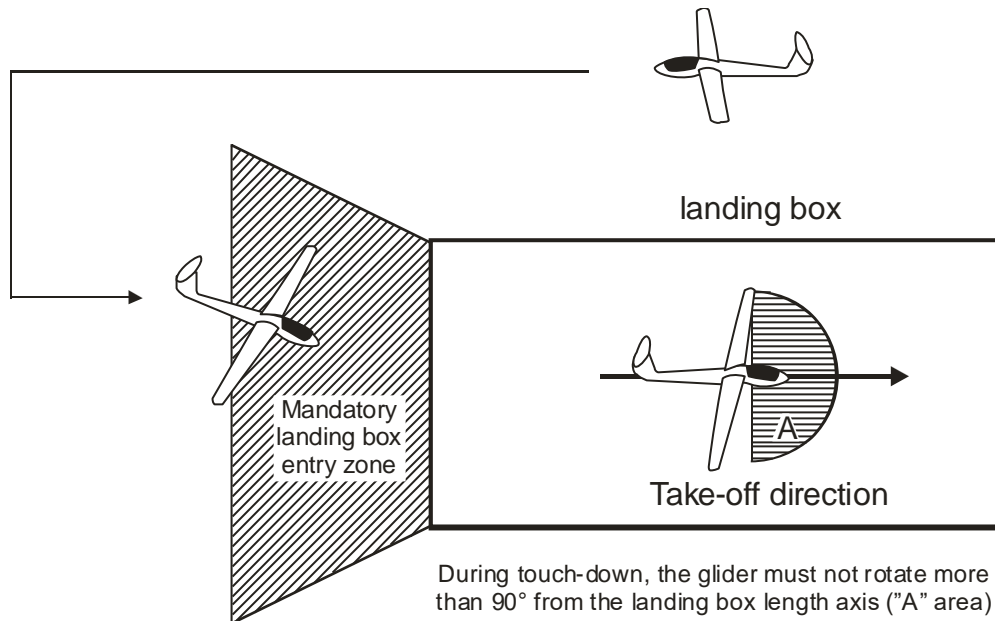
**5.Q.2.3.3 Duration flight attempt**

- a A competitor may elect to abort his flight and make a second attempt at any time between his glider take-off and release.
- b A flight is also considered an attempt if :
 - i The glider is not ready to take-off before the end of the 2-minute preparation time;
 - ii The aero tow is aborted for any reason due to the competitor.

5.Q.2.3.4 Duration task reflight

A reflight may only be allowed by the Contest Director. The flight is repeated if :

- i The flight has not been properly timed by the timekeeper.
- ii The aero tow is interrupted for any reason outside of the competitor's responsibility.
- iii The glider collides with another model. In this case, both models must land in order to check their structural integrity.
- iv All the gliders of a group are not released within the allowed time span. In this case, the Contest Director may decide whether the entire group may start again immediately or at the end of the flight task. The group starts again for a single flight with no other attempt allowed.
- v If one competitor is responsible for the group reflight, his score is the one achieved in the reflight. The other competitors from the group score the best result from the two flights.

5.Q.2.3.5 Cancellation of a duration flight

A flight is cancelled and the task scored 0 (zero) if :

- a The glider is not ready to take off for the second attempt within the allowed preparation time.
- b The glider overflies the safety areas at low altitude.

5.Q.2.3.6- Duration flight task scoring

- a The flight time recorded is rounded down to the lower full second (example: 7:59:99 scores 7:59 s).
- b The timekeeper times the flight, from the glider release from the tug until :
 - i The moment the glider comes to rest after landing;
 - ii The glider collides with a fixed obstacle while in flight;
 - iii The glider disappears from the timekeeper's eyesight and it becomes obvious that it will not reappear. In case of doubt, only one of the timepieces may be stopped.

cont/...

- c Flight scoring :
- i Only full seconds of flight are taken into account up to a maximum of 480 (8 minutes).
 - ii Twenty additional seconds (bonus) are awarded if the landing is performed within the prescribed limits (5.Q.2.3.2.d, e & f).
- d No landing bonus is awarded if, in addition to (b) above, the glider :
- i Comes to land into the landing box over a long side;
 - ii Touches the pilot or his helper during landing;
 - iii Comes to a rest inverted;
 - iv Rotates more than 90° from the landing box length axis.
- e Deducted time :
- i When the flight duration exceeds 480 seconds (8 minutes), 1 second is deducted for every full second of flight in excess of 480 s (example: 8:10s flight scores 480 - 10 = 470 seconds).
- f Penalty points
- i 200 penalty points are deducted from the score if the glider lands and comes to a rest more than 100 metres from the landing box centre.
 - ii 200 penalty points are deducted from the score if any part of the glider is lost during the timed part of the flight.
- g Calculation of the task score :
- i The best result from a group is awarded 1,000 points score, other results are scored as a percentage of the best score over a 1,000.0 points scale (down to one decimal).
 - ii Penalty points are deducted from the competitor's task score.

$$\text{Points} = (1000 \times (\text{TC} + \text{LB}) / (\text{BTC} + \text{LB})) - \text{PP}$$

CT = Competitor's time

LB = Landing Bonus

BTC = Best time of the group

PP = Penalty Points

Example 1 - Group 1 : Best time is (480 + 20)

Competitor	score	Calculation	result
1	8 min + landing bonus	$1,000 \times (480 + 20) / (480 + 20)$	1,000.0
2	7 min 50 s + landing bonus	$1,000 \times (470 + 20) / (480 + 20)$	980.0
3	8 min 10 s + landing bonus	$1,000 \times (480 + 20 - 10) / (480 + 20)$	980.0
4	8 min + landing bonus & loss of any part of the glider	$[1,000 \times (480 + 20) / (480 + 20)] - 200$	800.0

Example 2 – Group 2 : Best time is (480+ 0)

Competitor	score	Calculation	result
1	6 min + no landing bonus	$1,000 \times (360 + 0) / (480 + 0)$	750.0
2	5 min 50 s + landing bonus	$1,000 \times (350 + 20) / (480 + 0)$	770.8
3	5 min 10 s + landing bonus	$1,000 \times (310 + 20) / (480 + 0)$	687.5
4	8 min & landing + 100m	$[1,000 \times (480 + 0) / (480 + 0)] - 200$	800.0

5.Q.3 Final classification

- a The score of any round is the sum of the speed and duration scores.
- b The competitor's score is the sum of the rounds scores.
- c The final score does not take into account :
 - i The lowest round score, if three rounds or more are flown;
 - ii The two lowest round scores, if five rounds or more are flown;
 - iii The three lowest round scores, if nine rounds or more are flown.

---oOo---