



# **Falcon Player Manual**

**Version 2.2  
February 2020**

**Written by Rick Harris  
Technical editor Mark Amber**

**This couldn't have been possible without the help and support of Chris Pinkham and Daniel Kulp answering my never ending questions.**

Version	Comments	Date Published
2.0	Updated to FPP 3.1 Release	August 22, 2019
2.1	Changed Wi Fi Tethering instructions	August 28, 2019
2.2	Update to FPP ver 3.6	February 21, 2020

# Introduction

The Falcon Player (FPP) is a lightweight, optimized, feature-rich sequence player designed to run on low-cost Single Board Computers (SBC). It was originally created to run on the \$35 Raspberry Pi, hence the middle 'P' in the short name but now the FPP supports many more systems. The FPP shorthand is still used but it is now just called Falcon Player. FPP is a software solution that you download and install on hardware which can be purchased from numerous sources around the internet. FPP aims to be controller agnostic, it can talk E1.31, DDP, DMX, Pixelnet, and Renard to hardware from multiple hardware vendors. This includes controller hardware from Falcon Christmas or in the store on <https://FalconChristmas.com>.

Up until the end of the 2015 Christmas season, most users of FPP used the Raspberry Pi as the main player. Since then it has expanded with the BeagleBone series of SBCs being utilized as well.

The FPP can interface to a number of controllers. It can also play synchronized audio via an audio port /FM transmitter, synchronized video (via an HDMI), It supports USB devices and external interfaces via the GPIO bus. It can also drive pixels directly via the GPIO bus.

Many people use FPP as the main and only player by connecting it to one or more (E.131/DMX) controllers and run their light show sequences and audio off it. Others will use several FPPs operating in various modes to run their shows, play videos from a remote projector, control animatronics, or handle outside events that are all synched to the main (master) FPP.

The Raspberry Pi hardware running FPP software can be utilized with a cape to act as a controller to control a small matrix (36 P10 or 15 P5 panels) or 2 strings of pixels (approximately 1600 pixels per string at 20 fps, 800 pixels per string at 40 fps.)

The BeagleBone series SBCs have been extensively used with a cape to drive up to 96 P10 or 40 P5 panels (depending on the cape, a PocketBeagle only has 6 ports so can control 72 P10 or 30 P5 panels). The Beagle Bone series SBCs can also support other capes and act as a controller, such as the F4-B, F8-B, F16-B, F32-B, F8-PB, F40D-PB etc.

This manual covers the functional aspects of installing, configuring and operating the FPP, the most popular show player for Christmas and Halloween animated lighting displays.

The current version of Falcon Player will run on the following hardware:

- Raspberry Pi 2 Model B
- Raspberry Pi 3 Model B
- Raspberry Pi 3 Model B+
- Raspberry Pi 3 Model A+
- Raspberry Pi 4 Model B
- Raspberry Pi Zero-W
- Raspberry Pi Zero (A micro USB hub might be needed)
- BeagleBone Black (Rev C)
- BeagleBone Black Wireless
- BeagleBone Green
- BeagleBone Green Wireless (not recommended if using any capes)
- PocketBeagle

The philosophy of the FPP developers is to make the FPP as easy to install and use as possible, while still providing for much of the flexibility required by a diverse group of enthusiasts.

The FPP software is free to download and use and is provided by and supported by a number of volunteers.

Please refer to the Falcon Christmas website <https://FalconChristmas.com> for the latest news and discussions. In particular, the FPP forum page on the website is a great resource for help.

## **Acknowledgements**

The developers and authors of this software are volunteers.

A very special thanks go out to our families for supporting us in this hobby. Without their support we could not do this.

# Table of Contents

Introduction .....	2
Acknowledgements.....	3
Table of Contents .....	4
Hardware Needed.....	8
Raspberry Pi .....	8
BeagleBone series (BB) .....	8
FPP Quick Start Guide.....	9
Installing the FPP Software.....	9
Required Programs .....	9
Configuring the Micro SD (uSD) Card.....	9
Getting the FPP software.....	10
Software Installation .....	12
USB Tethering Installation .....	13
Network Connection Installation.....	14
Wi-Fi Tethering Installation .....	14
Initial Configuration .....	15
Initial Network Configuration .....	18
Wi-Fi Network settings .....	18
Ethernet Network Settings .....	19
Host & DNS Settings .....	20
Final configurations.....	22
Updating the Software .....	23
FPP Details.....	26
Program Settings and Navigation.....	26
Status/Control .....	28
Status Page.....	28
Set UI Password .....	31
Config/Set Time .....	31
Network.....	32
Interface Settings.....	33
Host & DNS Settings .....	34
Tethering .....	35
Wi-Fi Tethering.....	35
USB Tethering.....	35
Interface Routing .....	36
MultiSync .....	36
FPP Settings .....	38

Beagle Bone only settings .....	41
Advanced Settings .....	41
FPP Advanced Settings .....	41
MQTT .....	43
FPP Backup .....	44
JSON Configuration Backup .....	44
Backup Configuration (creating a backup) .....	44
Restore Configuration .....	45
File Copy Backup.....	46
Email Settings .....	47
Proxy Settings .....	48
Events .....	48
Creating an Event to be Triggered in a Playlist .....	51
Creating an Event to be Triggered in a Sequence.....	52
Creating an Event to be Triggered by a GPIO Button. ....	54
Effects .....	55
Display Testing.....	56
Channel Testing.....	56
Test Patterns.....	57
Sequence .....	58
Content Setup.....	59
File Manager .....	59
Playlists.....	60
Scheduler .....	63
Script Repository Browser .....	66
Plugin Manager .....	66
Retrieve Plugin Info .....	67
Installed Plugins.....	67
Available Plugins .....	68
Template Plugin.....	68
Incompatible Plugins.....	68
Input/Output Setup.....	69
Channel Inputs .....	69
Adding E1.31 Bridge Mode Input .....	70
Channel Outputs .....	71
E1.31/ ArtNet/ DDP.....	72
Adding E1.31 Output Channels .....	74
Pi Pixel Strings.....	75
BBB Strings .....	76

LED Panels.....	78
Pi LED Panels Screen.....	78
BB LED Panels Screen .....	78
LED Panel Layout .....	79
Standard LED Panel Layout.....	80
Advanced Layout View .....	80
Other .....	82
Output Processors.....	82
Pixel Overlay Models.....	84
GPIO Inputs .....	85
Help .....	86
FPP Manual .....	86
Wiki/Help.....	86
Help Index.....	86
fpp & fppmm.....	87
Troubleshooting Commands .....	88
SSH Shell.....	90
About.....	90
Version Info .....	90
System Utilization .....	91
Player Stats .....	91
Disk Utilization .....	92
Credits.....	92
Glossary .....	93
Advanced Options .....	96
Network Configuration.....	96
Common Network Setups .....	96
Standalone.....	96
Wired on Home Network .....	97
Wired with Separate Show Network .....	98
Master/Remote.....	99
Virtual Matrix .....	100
Creating a Virtual Matrix .....	100
Playing Video .....	103
Virtual Display .....	104
Bootng from eMMC on BeagleBone .....	105
Using USB for Media Storage .....	105
Common Plugins.....	106
Big Buttons .....	107

Matrix Tools .....	110
Message Queue Aggregator for Plugins .....	113
Message Queue to Matrix Overlay.....	114
Event Date.....	116
Projector Control.....	118
Plugin Development.....	119
Resources .....	122
Help.....	122
Configuring a Static Route.....	122
GPIO Button Input.....	124
Networks .....	126
Universes, Channels and Ports, oh my! .....	127
Troubleshooting .....	128

# Hardware Needed

The Raspberry Pi and BeagleBone series SBC's have different requirements and setup instructions. Follow the instructions for your specific case. These instructions are the basics to get your device(s) running. Depending on your setup, you will need additional items after the initial setup to actually run your show (like power supply, network cables, wiring etc.)

## Raspberry Pi

### Required Items:

- Supported Raspberry Pi
- Micro SD memory card. 4GB minimum, Class10 or better. 16GB will probably be easier to find.
- Power Supply for the Pi.
  - 5vdc 2.0A microUSB for the Pi Zero and Pi 2 series
  - 5vdc 2.5A microUSB for Pi 3 series
  - 5vdc 3.0A USB-C for Pi 4 series

### Optional Items:

- Ethernet cable (If you are connecting to your network via Ethernet or want to use the Network Configuration process)
- USB to Micro USB cable (for devices that support USB Tethering. USB Tethering is usually an easier process)
- Wi-Fi USB adapter if you're using a Pi that does not have built-in Wi-Fi (Edimax Nano is recommended but it is best to stick with a 2.4Ghz only, the some of the 5Ghz cards have compatibility issues)
- Cape installed if you are using one.

## BeagleBone series (BB)

It is recommended to use the Beaglebone Black or PocketBeagle. The BeagleBone Green is better suited for embedded applications than the BeagleBone Black, but you can still use the BeagleBone Green as an FPP device. The BeagleBone Green Wireless cannot be used with capes.

### Required Items:

- Supported BeagleBone SBC
- Micro SD memory card. 4GB minimum, Class10 or better. 16GB will probably be easier to find.
- Appropriate power supply.
- **If you are using a PocketBeagle- A Wireless USB adapter or USB Ethernet adapter is required to complete your setup depending on how you are going to connect your FPP to your network.** (Edimax Nano is recommended but it is best to stick with a 2.4Ghz only, the some of the 5Ghz cards have compatibility issues)

### Optional Items:

- Ethernet Cable (if you are connecting your FPP device to the network via Ethernet or want to use the Network Configuration process)
- USB Cable- If you want to install and configure the FPP device using the USB Tether method then you will need a USB to Mini USB cable (Micro USB if you are using a PocketBeagle) USB Tethering for installation is probably the easiest.
- Octoscroller type Cape if connecting the BB to (P10/P5) Panels
- Other cape installed if you are using one.



# FPP Quick Start Guide

This section will give you the basic configurations to get you up and running but may not be the ultimate configuration that you will need to get your show up and running. Refer to the [FPP Details](#) for more in depth explanations of each function/setting of FPP.

## Installing the FPP Software

### Required Programs

To install the software, you will need a couple programs, one for formatting the MicroSD card and one for “burning” the image.

**Note: You cannot just copy the files to the card!**

If you don't have programs to accomplish this, here are a couple suggestions:

An SD card formatter

<https://www.sdcard.org/downloads/index.html> has a version for both Mac and Windows.  
<https://gparted.org/> has a version for Linux systems.

An image writer program

<https://www.balena.io/etcher/> has a version for Windows, Mac and Linux operating systems.  
<https://sourceforge.net/projects/dotnetdiskimager/> is a good option for Windows users.

Canispater Christmas has some great tutorials and he has one on how to install the FPP software at [https://youtu.be/X95Rv4JGG\\_Y](https://youtu.be/X95Rv4JGG_Y) and you can follow the instructions there if you like but the videos might be out of date.

Note: If this is the **first** time you are installing a version of FPP greater than 2.0 on a BeagleBone **Black** (not any other derivative) then you have to hold down the boot button as shown in the video on powering up. Some people miss this while watching the video.

If you don't know how you are going to use FPP in your network, you should refer to the [Common Network Setups](#) section of the manual.

## Configuring the Micro SD (uSD) Card

After you have installed the two programs listed above (or use the versions that you have), then insert the MicroSD (uSD) card into your computer and do a Quick Format using the Formatting software (Not Windows or MAC file managers).

Below is a Windows screenshot as an example.

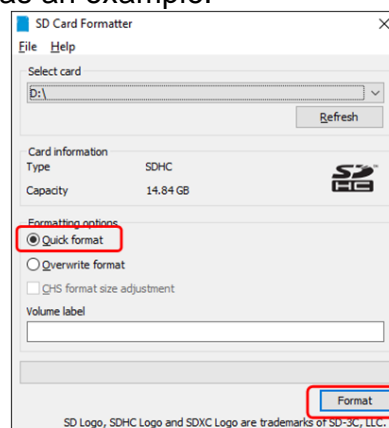

# Getting the FPP software

You will then need to go to <https://github.com/FalconChristmas/fpp/releases> and download the **most current Image File**, not the source code for your application! The Image file has the **.img.zip** in the file name.

The Image Files are the files that start with FPP and then indicates the version and SBC image. Download the file that corresponds to the SBC you are using (Pi or BB). On the Github website there will be several releases listed. Not all of them have an image available. Scroll down until you find the first version with the images.

Note: you might have to expand the Assets section to see if an image is available.

Here is an example of the most current release as of February 2020 (pick the most current release for your application)

## Before expanding:

### 3.6.1

Edit

 dkulp released this 12 days ago · 60 commits to master since this release

This is an optional bug fix release that contains a few fixes for issues encountered by users.

## Enhancements:

- Add a "Hold Value" output processor to hold the last value if a zero is encountered
- Several enhancements for the PCA9685 "Servo" output:
  - Add a "Center" value to control what the "128" channel value outputs
  - Add ability to control what happens with 0 value (hold, to center, normal, shut off pwm)
  - Fix some issues adding multiple PCA9685 outputs if multiple boards are on the same i2c bus

## Bug Fixes:

- Fix problems scrolling multi-line text on Pixel Overlay Models
- Fix problems on PocketScroller related to manual updates
- Fix problems on PocketScroller where the i2c bus wasn't properly being disabled when output 6 was used
- Fix problems with bbg-reportpins.sh script not reporting for pins 1-9 on each header
- Fix several bugs with the "Advanced UI" for the LED Panels
- Add "/" to list of directories for Restore from USB
- Fix ArtNet output causing hang at startup (requires a reboot after update)

## Upgrade Instructions:

If you have a system running 3.5.x or 3.6.x, you can go to the FPP about page (about.php) and click on the "Manual Update" button. It should only take a minute or two to upgrade.

For older versions, it's recommended to grab the 3.6.1 image from the bottom of <https://github.com/FalconChristmas/fpp/releases/tag/3.6.1>, install that.

▶ Assets 4

## After Expanding:

### Upgrade Instructions:

If you have a system running 3.5.x or 3.6.x, you can go to the FPP about page (about.php) and click on the "Manual Update" button. It should only take a minute or two to upgrade.

For older versions, it's recommended to grab the 3.6.1 image from the bottom of <https://github.com/FalconChristmas/fpp/releases/tag/3.6.1>, install that.



**Depending on your image-writing software, you may have to unzip the file before you can use it.**

Once you have downloaded the zip file for your application, you might have to extract the file first, depending on your imaging program. Then you have to burn the image onto the uSD card using the software for burning images (in this case, I am using Etcher) Make sure you are flashing the .img file and not the .zip file if your imaging software does not support imaging from a .zip file. If you are not sure, unzip the file first.

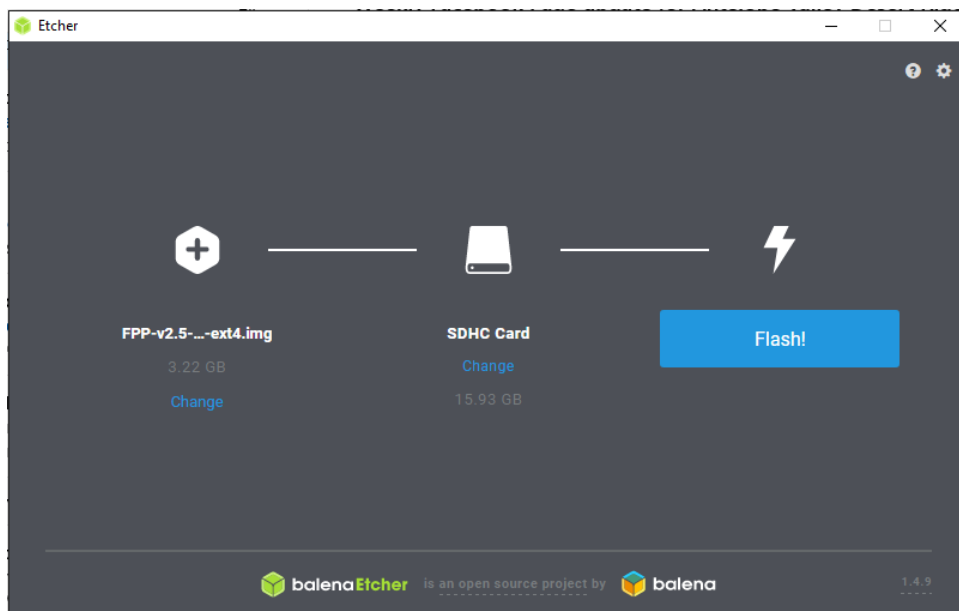

The image that is burned onto the card is not in a format that Windows or Macs can read so you might get an error message after the image is burned. DO NOT perform the format process after you have loaded the image.

Once you have the image file on the uSD card, make sure your Pi or BB is turned off and insert the uSD card into your Pi/BB.

Because the PocketBeagle, BeagleBone Black Wireless and Raspberry Pi Zero W do not have an Ethernet connection, you will need to follow a slightly different process. Follow the method below for installing FPP on the device you are using.

Note: Some capes have RJ45 ports but they are NOT Ethernet ports they are used for DMX or Differential Receivers. They are not network connections and you cannot use these ports for initial setup.

## Software Installation

**FPP is configured from a Web based interface, you do not need to connect a monitor directly to the FPP and you can't access FPP directly using a keyboard and monitor connected to the Pi!**

You will access the FPP interface from your computer using a web browser.

**Note: Google Chrome is recommended. Internet Explorer and Microsoft Edge have problems displaying the interface correctly.**

Before you begin the software installation and configuration process, you should decide how you are ultimately going to have your FPP device connected to your network, either Wi-Fi, Ethernet, or in a few cases both. And then make sure that your FPP device has the appropriate connection or adapter installed prior to installing/configuring FPP. You also need to know what your home network router's IP address is (the 2 most common ones are 192.168.0.1 and 192.168.1.1 but there are many other common ones as well)

**Note: If your home router has an IP address with a subnet of 192.168.6.xxx, 192.168.7.xxx or 192.168.8.xxx then your FPP will have problems communicating in these environments. Those subnets are the default subnets used by Windows, Mac and Linux for USB tethering and could cause conflicts. You should change your home network to a different subnet to avoid problems.**

If you don't know how you are going to use FPP in your network, you should refer to the [Common Network Setups](#) section of the manual.

If you are unsure how you are going to ultimately configure your show network, then it is recommended to use the Network Connection installation process.

Due to the different configurations of each model of Pi and BeagleBone, the software installation is different and there can be more than one way to install the software. The following steps are a suggested method of installing the software on each model of SBC.

There are 3 basic ways of installing the software onto your FPP device and they are:

**USB Tethering-** USB Tethering is probably the easiest method to install and configure FPP. To install and configure FPP using USB Tethering, you will connect your computer directly to the FPP device with a USB cable. There are only a few devices that support USB Tethering.

The following devices can have the software installed and configured using USB Tethering:

- Raspberry Pi Zero W
- BeagleBone Black

- PocketBeagle
- BeagleBone Green

**Network Connection-** Installing and configuring the FPP software through a network connection can be accomplished almost as easily as the USB Tethering method. To install and configure your FPP device using a Network Connection requires you to connect your FPP device to your local network via an Ethernet cable. If your FPP device does not have an Ethernet adapter, then you can usually install a USB to Ethernet adapter or choose another method to install and configure your FPP device.

Any of the Pis or BeagleBone SBCs can have the software installed and configured using the Network Connection method if they have an Ethernet connection or Ethernet adapter installed.

**Wi-Fi Tethering-** If you don't have a way to install and configure the FPP software through one of the more traditional methods, you can use the Wi-Fi tethering method on any FPP device that has Wi-Fi tethering capabilities, either on board or through a Wi-Fi adapter.(not all USB Wi-Fi adapters support Wi-Fi tethering.)

**Note: If the FPP device needs an adapter for a network connection that you are going to use for your network connection, then make sure it is installed before you start your setup.** (Like a Pi Zero that you want to connect to your network via Ethernet)

## USB Tethering Installation

**Note: If the FPP device needs an adapter for a network connection that you are going to use for your network connection then make sure it is installed before you start your setup.** (Like a PocketBeagle that you are going to ultimately connect via Wi-Fi)

1. Make sure the uSD card with the proper image is inserted into the slot.
2. Make sure you have any network adapters that you will need for your network configuration.
3. Connect one end of the USB cable to your computer.
4. Plug the USB cable into the FPP device.

Note: The Raspberry Pi Zero has two places to connect a micro USB. One is for power only and one is for USB. Make sure you plug the USB cord into the USB Port.

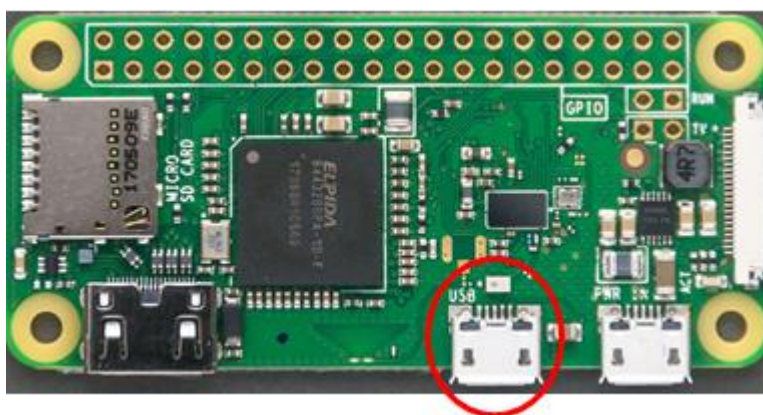

5. Wait approximately one minute (A Pi Zero might take slightly longer).

6. Open a web browser on your computer and if you are using a Windows computer, then enter 192.168.7.2 in the browser's address bar, if you are using a Mac or Linux computer then enter 192.168.6.2.
7. Continue to the [Initial Configuration](#) section of the manual to complete the setup.

## Network Connection Installation

**Note:** If the FPP device needs an adapter for a network connection that you are going to use for your network connection, then make sure it is installed before you start your setup. (Like a BeagleBone Black that you want to connect to your network via Wi-Fi)

1. Make sure the uSD card with the proper image is inserted into the slot.
2. Make sure you have any network adapters that you will need for your network configuration.
3. Connect the Raspberry Pi/BB to your router with the Ethernet cable.
8. If you are installing to a BeagleBone **Black** and it is the **first time** that an FPP version release 2.0 or higher is being installed, then press and hold the S2 button and plug in the appropriate power supply. Hold the S2 button for 5 seconds after you connect the power supply. (Located near the uSD card.)

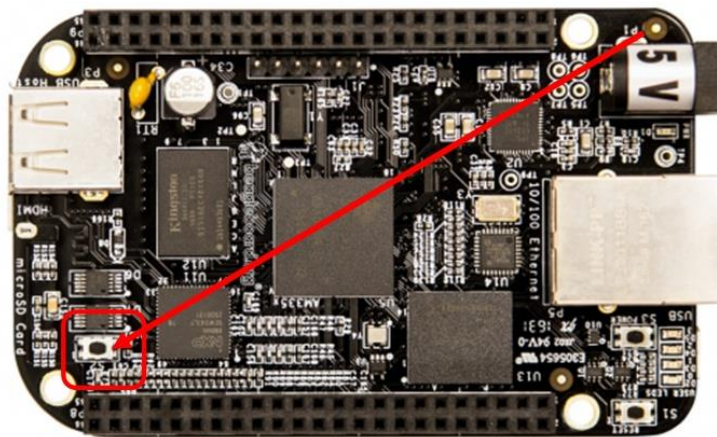

4. All other devices-connect the appropriate power to the device.
5. Wait approximately one minute (A Pi Zero might take slightly longer).
6. Enter <http://fpp> or <http://fpp.local/> in your browser. (If you are unable to connect to the FPP device using one of these addresses, go to the [Troubleshooting](#) section.)
7. Continue to the [Initial Configuration](#) section of the manual to complete the setup.

## Wi-Fi Tethering Installation

You can use Wi-Fi Tethering if your FPP device supports Wi-Fi Tethering. You can also use this method if your FPP Device cannot connect to your network so that you can make changes without having to erase the uSD card.

This will require using a computer with a wireless connection. Depending on your computer operating system, the method and screenshots will be slightly different.

1. Make sure the uSD card with the proper image is inserted into slot.
2. Make sure you have any network adapters that you will need for your network configuration.

**Note: Many Wi-Fi adapters do NOT support Wi-Fi tethering (on board Wi-Fi usually does) so if you installed a USB Wi-Fi adapter the Wi-Fi tethering might not work.**

3. If you are installing to a BeagleBone **Black** and it is the **first time** that an FPP version release 2.0 or higher is being installed, then press and hold the S2 button and plug in the appropriate power supply. Hold the S2 button for 5 seconds after you connect the power supply. (Located near the uSD card.)

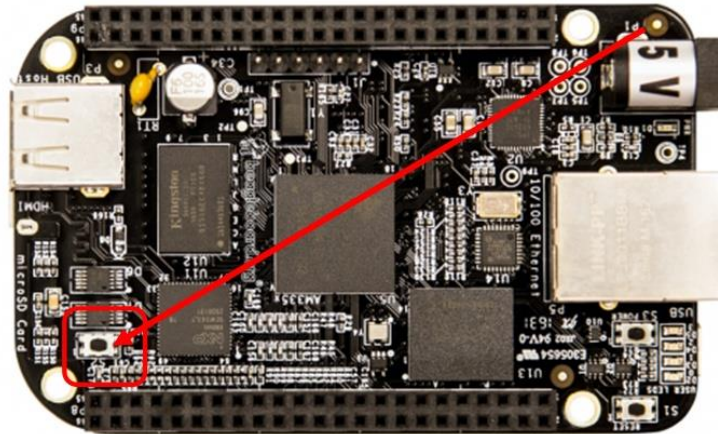

4. All other devices-connect the appropriate power to the device.
5. Wait approximately one minute (A Pi Zero might take slightly longer).
6. Go to your wireless networks on your computer and connect to the wireless network identified as FPP. The password is Christmas. (This process will vary depending on your operating system)
7. Type in 192.168.8.1 in your web browser to open the user interface.
8. Continue to the [Initial Configuration](#) section of the manual to complete the setup.

## Initial Configuration

Once the FPP has been installed on your Pi/BB, then you need to complete your setup.

Your screen will look similar to these. The logo on the right will indicate the type of SBC that is being used.

### Beaglebone Device

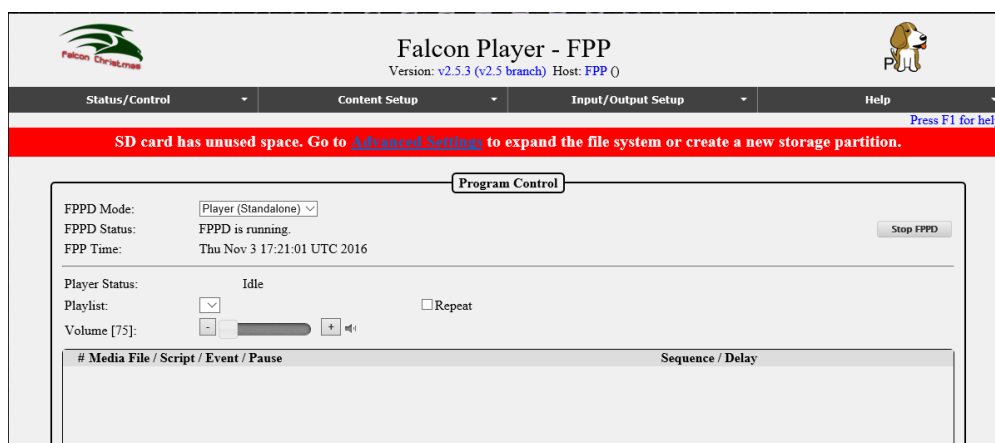

# Raspberry Pi Device

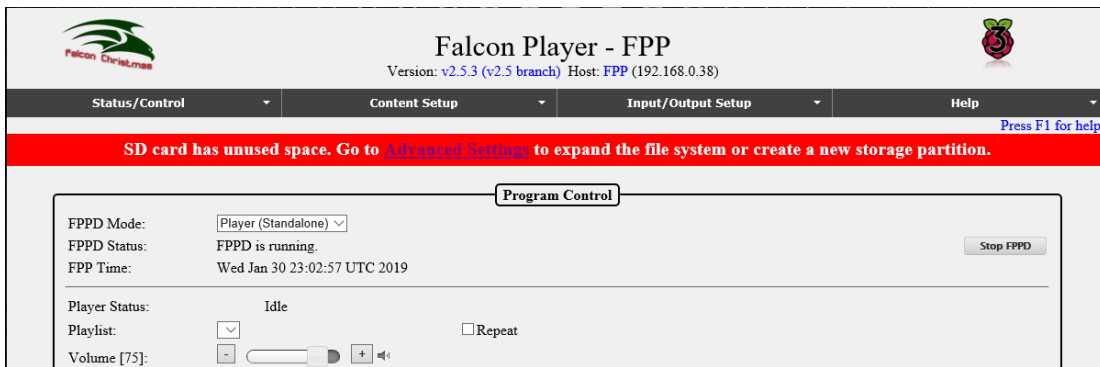

Click on the Advanced Settings that is in the red banner.

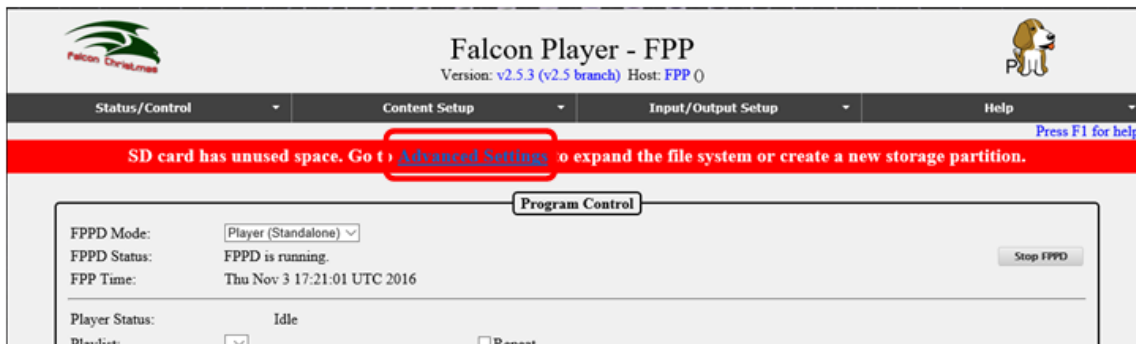

Click on the Grow Filesystem button.

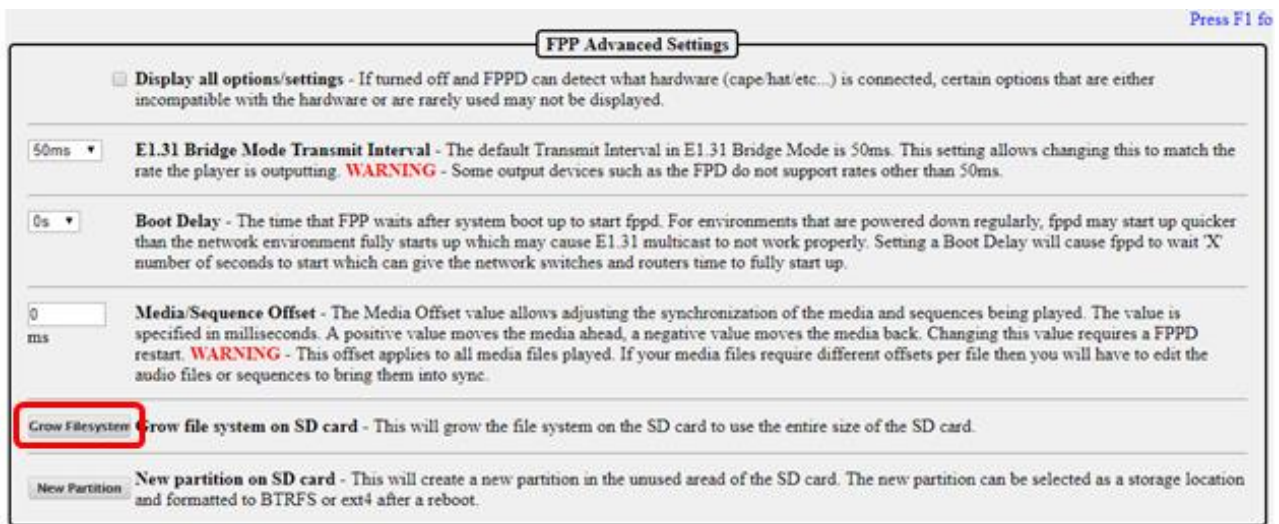

This should bring you to this screen, click on Yes:

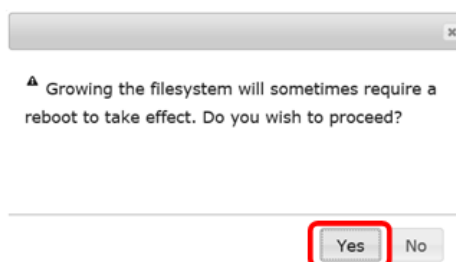



You should get to a screen similar to this:

## Grow SD Card Filesystem

```
Command: sudo /usr/bin/raspi-config --expand-rootfs
```

```
.....  
Welcome to fdisk (util-linux 2.33.1).  
Changes will remain in memory only, until you decide to write them.  
Be careful before using the write command.
```

```
Command (m for help): Disk /dev/mmcblk0: 58.2 GiB, 62537072640 bytes, 122142720 sectors  
Units: sectors of 1 * 512 = 512 bytes  
Sector size (logical/physical): 512 bytes / 512 bytes  
I/O size (minimum/optimal): 512 bytes / 512 bytes  
Disklabel type: dos  
Disk identifier: 0x17869b7d
```

```
Device      Boot  Start    End  Sectors  Size Id Type  
/dev/mmcblk0p1  8192  532480  524289  256M  c W95 FAT32 (LBA)  
/dev/mmcblk0p2 540672 7708671 7168000  3.4G  83 Linux
```

```
Command (m for help): Partition number (1,2, default 2):  
Partition 2 has been deleted.
```

```
Command (m for help): Partition type  
  p  primary (1 primary, 0 extended, 3 free)  
  e  extended (container for logical partitions)
```

```
Select (default p): Partition number (2-4, default 2): First sector (2048-122142719, default 2048): Last sector,  
Created a new partition 2 of type 'Linux' and of size 58 GiB.
```

```
Command (m for help):  
Disk /dev/mmcblk0: 58.2 GiB, 62537072640 bytes, 122142720 sectors  
Units: sectors of 1 * 512 = 512 bytes  
Sector size (logical/physical): 512 bytes / 512 bytes  
I/O size (minimum/optimal): 512 bytes / 512 bytes  
Disklabel type: dos  
Disk identifier: 0x17869b7d
```

```
Device      Boot  Start    End  Sectors  Size Id Type  
/dev/mmcblk0p1  8192  532480  524289  256M  c W95 FAT32 (LBA)  
/dev/mmcblk0p2 540672 122142719 121602048  58G  83 Linux
```

```
Command (m for help): The partition table has been altered.  
Syncing disks.
```

```
Please reboot
```

[Go to FPP Main Status Page](#)

Click on the “Go to FPP Main Status Page” to go back to your FPP main page.

When you get back to the main screen, click on the Reboot button

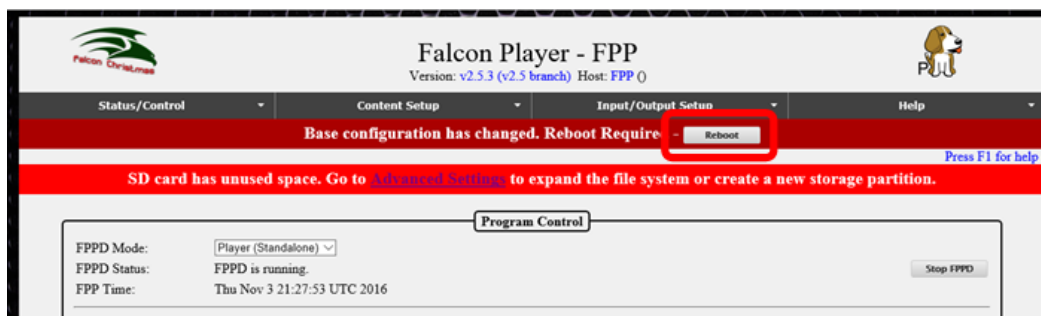

You will get a confirmation screen, click on “OK”

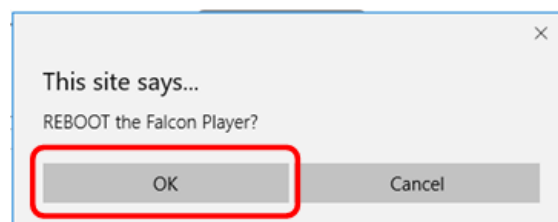

It will take several seconds for it to reboot (Pi Zeros could take about a minute to boot). After it reboots, you will need to set up other configurations and update the system to the current version. This is covered in the next section.

# Initial Network Configuration

You should have decided how you want your network configured before you edit your network settings. If you are not sure, then refer to the [Network Configuration](#) section of the manual for more information. If you want a temporary network configuration you can use the [Wired with Separate Show Network](#) configuration so that you update the software and make final configurations before use the FPP in your final network configuration. This would be a good configuration for testing purposes as well.

Click on the Status/Control and then Network tab.

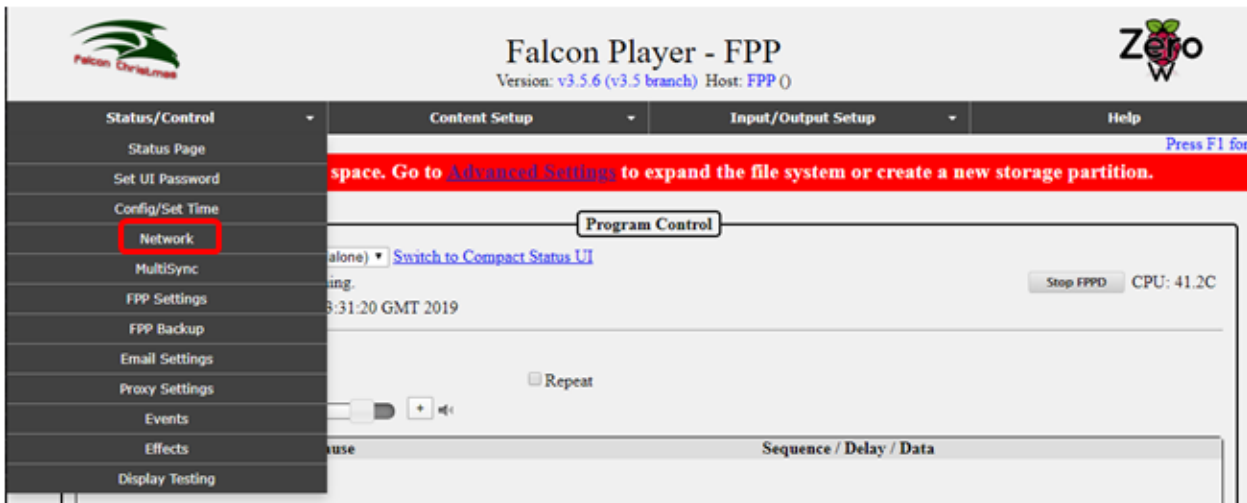

You should have a screen similar to this:

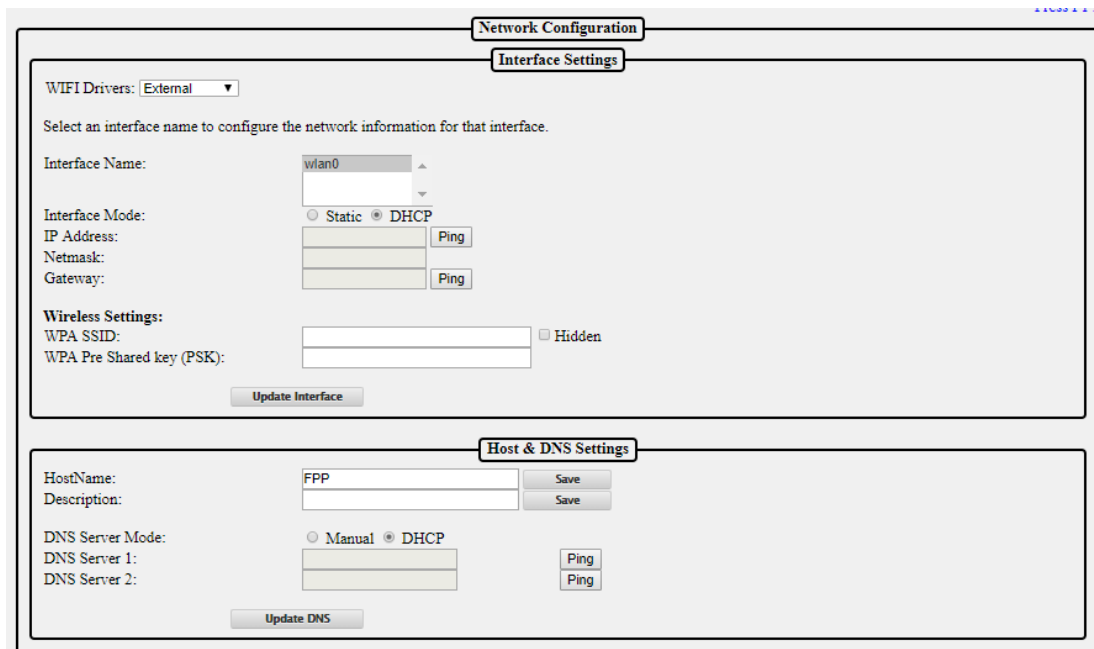

## Wi-Fi Network settings

If you do not need to configure a Wi-Fi connection, then skip to the [Ethernet Network Settings](#) section.

**Note: Many Wi-Fi adapters do not support 5 GHz.**

Normally the External Wi-Fi drivers work best so keep that setting.

1. Click on the wlan0 interface (wlan0 is the wireless interface)
2. Select DHCP if you want your router to assign the IP address, select Static if you want to assign the IP address yourself.  
Note: If you use DHCP, then the Host Name and DNS server is important to be configured correctly.
3. If you selected the Static option, enter your IP address, the Netmask should usually be 255.255.255.0 (it should be the same as your show or home network router) and the Gateway will be the IP address of your home or show router and will usually get filled in, but make sure it is correct.
4. Enter your WPA SSID and WPA Pre Shared Key (PSK). The WPA SSID is the name of your wireless network. The WPA Pre Shared key (PSK) is the password for your wireless network.
5. After you enter your wireless name and password, click on Update Interface
6. The Restart Network button will appear. **Do Not click on the Restart Network button.**

The screenshot shows the 'Network Configuration' page with the 'Interface Settings' tab selected. The 'WiFi Drivers' dropdown is set to 'External'. Below it, the 'Interface Name' dropdown is set to 'wlan0'. The 'Interface Mode' section has 'Static' unselected and 'DHCP' selected. There are input fields for 'IP Address', 'Netmask', and 'Gateway', each with a 'Ping' button to its right. The 'Wireless Settings' section has a 'WPA SSID' input field with a 'Hidden' checkbox to its right, and a 'WPA Pre Shared key (PSK)' input field. At the bottom, there are three buttons: 'Update Interface', 'Create Persistent Names', and 'Clear Persistent Names'.

## Ethernet Network Settings

If you do not need to configure an Ethernet connection, then skip to the [Host & DNS Settings](#) section.

1. Click on the eth0 interface (eth0 is the wired interface)
2. Select DHCP if you want your router to assign the IP address, select Static if you want to assign the IP address yourself. (Static is recommended)
3. If you selected the Static option, enter your IP address, the Netmask should usually be 255.255.255.0 (it should be the same as your show or home network router) and will usually get filled in automatically.
4. **If you are using both network interfaces** (wlan0 and eth0) such as connecting to your home network through Wi-Fi and connecting to a controller or switch through the eth0 interface then **make sure the Gateway on the eth0 interface is left blank** while the Gateway on the wlan0 interface is set to your home (or show) Wi-Fi router (only one interface should have a gateway defined all other interfaces should leave the gateway blank).
5. If you selected the Static option and are not using the wlan0 interface, the Gateway will be the IP address of your home or show router and will usually get filled in, but make sure it is correct.

- After you made sure that you have the correct Gateway address, click on Update Interface.
- The Restart Network button will appear. **Do Not click on the Restart Network button.**

## Host & DNS Settings

The HostName is the “human” name that you can use to access your FPP. It is like typing google.com instead of typing 172.217.3.174 but be aware that if you don’t have a proper DNS server set up or another part of your network isn’t configured properly, then the HostName might not work properly but you will still be able to access the FPP by typing in the IP address. You will need to change the HostName to something that is meaningful to you. Something like FPPMaster, FrontLawn, HouseOutline, whatever fits your situation and makes sense to you. If you are not going to have any other FPP instances then you can keep it as FPP if you want but it is not recommended because in this hobby, people have a tendency to expand their show and it is highly recommended that you rename it so there will be no confusion in the future. The HostName can only have letters, numbers, and hyphens (-). It may not begin or end with a hyphen and cannot have any spaces. Once you change the HostName you will no longer be able to access it in your web browser using <http://fpp.local/>. You can access it using the name that you just created or the IP address, which is why the name should make sense to you. Make sure you save your name after entering it. So if you changed the HostName to YardProps, then you could access the FPP by typing <http://Yardprops>. You can also add more descriptive information about this FPP in the Description box that will show up in other sections of FPP such as Multisync.

The screenshot shows the FPP web interface. At the top, there is a 'Network Configuration' tab. Below it, the 'Interface Settings' section is active. It includes a dropdown for 'WIFI Drivers' set to 'External', a prompt to 'Select an interface name to configure the network information for that interface.', and a dropdown for 'Interface Name' set to 'wlan0'. There are radio buttons for 'Interface Mode' with 'Static' and 'DHCP' options, and 'DHCP' is selected. Below that are input fields for 'IP Address', 'Netmask', and 'Gateway', each with a 'Ping' button. The 'Wireless Settings' section includes 'WPA SSID' (HarrisChristmas) and 'WPA Pre Shared key (PSK)' (6618163951), with a 'Hidden' checkbox. An 'Update Interface' button is at the bottom of this section. Below the 'Interface Settings' is the 'Host & DNS Settings' section, which has a 'HostName' field containing 'YourMeaningfulName' and a 'Description' field, both with 'Save' buttons. The 'HostName' field and its 'Save' button are highlighted with a red box.

If the FPP is going to be connected to a Wi-Fi interface and to a controller with an Ethernet cable or as a Standalone player sending data to a switch via Ethernet, then you need to check the box at the bottom of the page to allow the data to pass through the FPP to the eth0 (this does not apply if you are using a cape or hat or running in Standalone mode.)

The screenshot shows the FPP web interface. At the top, there is a 'Tethering' tab. Below it, the 'Tethering' section is active. It includes a dropdown for 'Tethering Mode' set to 'If no connection', and input fields for 'Tethering SSID' (FPP) and 'Tethering Pre Shared key (PSK)' (Christmas). Below this is a 'Warning' message: 'Warning: Turning on tethering may make FPP unavailable. Many WIFI adapters do not support simultaneous tethering and client modes. Having multiple WIFI adapters will work, but it's relatively unpredictable as to which WIFI adapter CONNMAN will bring tethering up on. Also, enabling tethering disables the automatic IP assignment on the USB0/1 interfaces on the BeagleBones and thus connecting to the BeagleBone via a USB cable will require you to manually set the IP address to 192.168.6.1 (OSX/Linux) or 192.168.7.1 (Windows)'. Below the 'Tethering' section is the 'Interface Routing' section, which has a checkbox labeled 'Enable Routing between network interfaces' that is checked and highlighted with a red box.

Once you have configured all of your network settings, eth0, wlan0, Host and DNS, double check them to make sure they are correct. If they are correct, then click on the Restart Network button. You will get the following message:

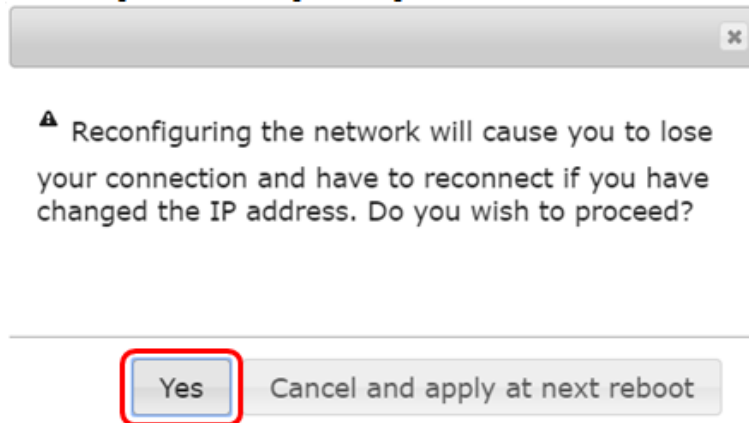

Click on the Yes button.

**At this point, your FPP will need to be connected to your network based on the configuration you set it for during the installation.**

# Final configurations

Once you have your FPP connected to the network based on the configuration you entered in your network settings, you will have to open the FPP's web page. Depending on how you configured your settings the process to get to your FPP page might be different. Usually you can get to it by typing the Host Name or IP address that you configured. If you cannot get to the FPP page, refer to the [Troubleshooting](#) section.

The next step is to configure your time settings, click on Status/Control and then Config/Set Time.

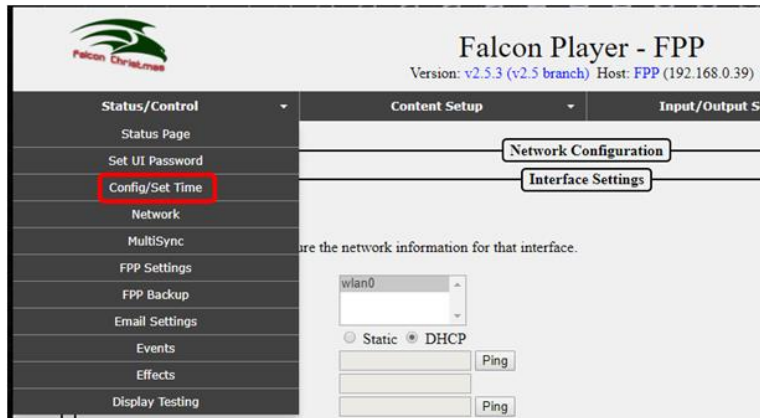

This will get you to this page. In most setup configurations, the FPP will have access to the internet and you can use the internet to keep the correct time.

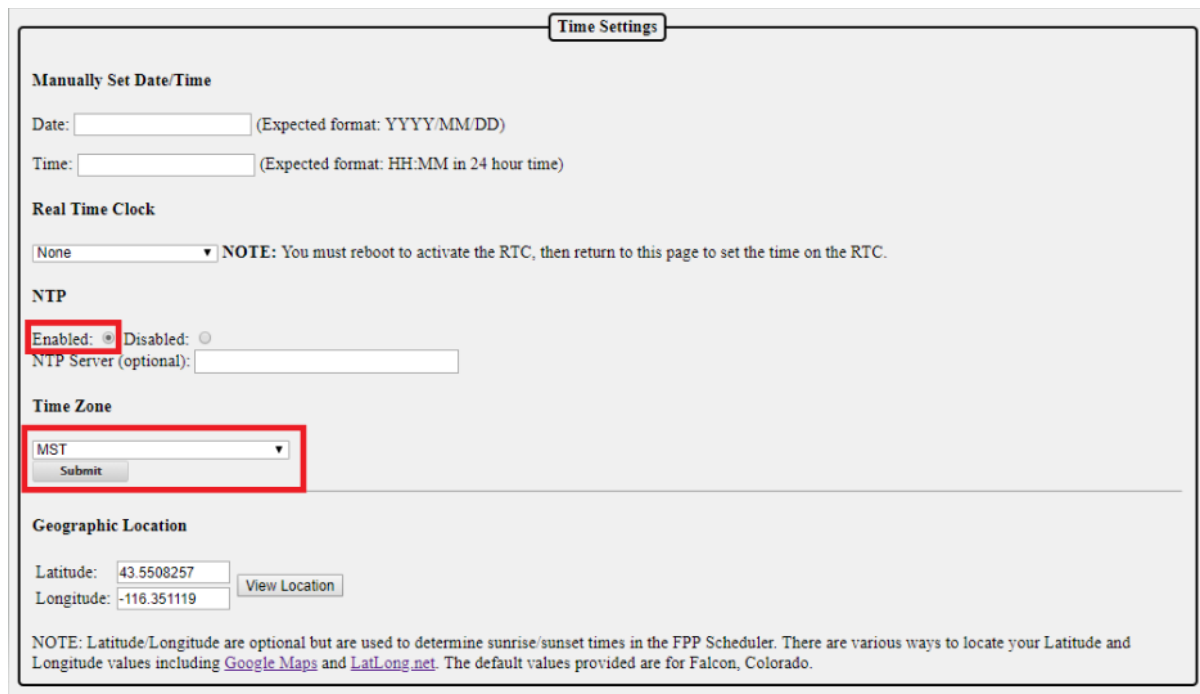

**Time Settings**

**Manually Set Date/Time**

Date:  (Expected format: YYYYMM/DD)

Time:  (Expected format: HH:MM in 24 hour time)

**Real Time Clock**

**NOTE:** You must reboot to activate the RTC, then return to this page to set the time on the RTC.

**NTP**

Enabled:  Disabled:

NTP Server (optional):

**Time Zone**

**Geographic Location**

Latitude:

Longitude:

NOTE: Latitude/Longitude are optional but are used to determine sunrise/sunset times in the FPP Scheduler. There are various ways to locate your Latitude and Longitude values including [Google Maps](#) and [LatLong.net](#). The default values provided are for Falcon, Colorado.

To use the internet to keep accurate time, select Enabled for the NTP and select the correct time zone. NTP is Network Time Protocol and will get the current time from the internet.

If your FPP will not have access to the internet, then you can manually set the date and time. Most Pi and BB computers do not have a Real Time Clock installed so if you power down the FPP device it will lose the current date and time. If you power down the FPP, you will need to reset the time and date if you need an accurate time (for scheduling the start and stop time of your show). See the [Config/Set Time](#) section for more information.

# Updating the Software

You should update to the current version of the software. To check for updates click on the Help then About:



On this screen, you will see the FPP Version you are using (in this case it is 3.5.6) and if there is an update available, it will give you a notice. Click on the Manual Update button.

If next to Remote Git Version it says Unknown, that usually means FPP can not reach the Internet. In most cases that means your network (usually the DNS configuration) is not set up properly. Refer to the [Troubleshooting](#) section for help.

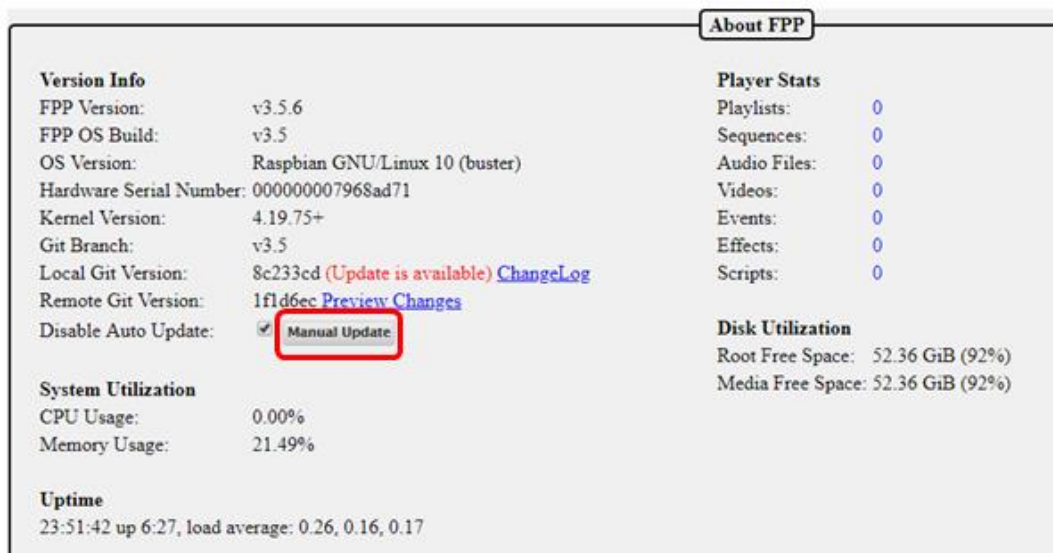

You will get a progress screen similar to this; it could take several minutes to update:

## FPP Manual Update

```
Stopping fppd...
-----
Pulling in updates...
Upgrading git revision from branch v2.5
From https://github.com/FalconChristmas/fpp
 926a5c03..15ce23a8 v2.5    -> origin/v2.5
 b220c744..a13a82d5 master  -> origin/master
 2eee8c92..34a30217 v1.10  -> origin/v1.10
 50b3a89b..10d0ee8d v2.4    -> origin/v2.4
 * [new branch]      v2.6    -> origin/v2.6
 * [new branch]      zstd    -> origin/zstd
 * [new tag]         2.6      -> 2.6
Updating 926a5c03..15ce23a8
Fast-forward
 www/js/fpp.js | 2 +-
 www/menu.inc | 4 +---
 2 files changed, 2 insertions(+), 4 deletions(-)
Synchronizing submodule url for 'external/RF24'
Synchronizing submodule url for 'external/rpi-rgb-led-matrix'
Synchronizing submodule url for 'external/rpi_ws281x'
```

Once it has updated, scroll to the bottom of the screen and click on the Go back to FPP About page.

```
ccache g++ -DUSEHTTAPI -g -I . -I channeloutput -I mediaoutput -mno-write-strings -mno-narrowing -DNOROOT -DPLATFORM_BBB -I/usr/local/include -O1 -std=gnu++14 -c Sequence.cpp -o Sei
ccache g++ -DUSEHTTAPI -g -I . -I channeloutput -I mediaoutput -mno-write-strings -mno-narrowing -DNOROOT -DPLATFORM_BBB -I/usr/local/include -O1 -c settings.c -o settings.o
ccache g++ -DUSEHTTAPI -g -I . -I channeloutput -I mediaoutput -mno-write-strings -mno-narrowing -DNOROOT -DPLATFORM_BBB -I/usr/local/include -O1 -std=gnu++14 -c httpAPI.cpp -o htt
ccache g++ -DUSEHTTAPI -g -I . -I channeloutput -I mediaoutput -mno-write-strings -mno-narrowing -DNOROOT -DPLATFORM_BBB -I/usr/local/include -O1 -std=gnu++14 -c channeloutput/BBBB4
ccache g++ -DUSEHTTAPI -g -I . -I channeloutput -I mediaoutput -mno-write-strings -mno-narrowing -DNOROOT -DPLATFORM_BBB -I/usr/local/include -O1 -std=gnu++14 -c channeloutput/BBBB5
ccache g++ -DUSEHTTAPI -g -I . -I channeloutput -I mediaoutput -mno-write-strings -mno-narrowing -DNOROOT -DPLATFORM_BBB -I/usr/local/include -O1 -std=gnu++14 -c channeloutput/BBBB6
ccache g++ -DUSEHTTAPI -g -I . -I channeloutput -I mediaoutput -mno-write-strings -mno-narrowing -DNOROOT -DPLATFORM_BBB -I/usr/local/include -O1 -std=gnu++14 -c channeloutput/BBBB7
ccache g++ -DUSEHTTAPI -g -I . -I channeloutput -I mediaoutput -mno-write-strings -mno-narrowing -DNOROOT -DPLATFORM_BBB -I/usr/local/include -O1 -std=gnu++14 -c channeloutput/BBBB8
ccache g++ -DUSEHTTAPI -g -I . -I channeloutput -I mediaoutput -mno-write-strings -mno-narrowing -DNOROOT -DPLATFORM_BBB -I/usr/local/include -O1 -std=gnu++14 -c channeloutput/BBBB9
ccache g++ channeloutput/ChannelOutputBase.o channeloutput/ThreadedChannelOutputBase.o channeloutput/channeloutput.o channeloutput/channeloutputthread.o channeloutput/ArtNet.o channe
.....
Restarting fppd...
Update Complete.
Go to FPP Main Status Page
Go back to FPP About page
```

Sometimes there will be an additional update available, if so, click on the Upgrade button.



You will usually get a Release notes page, click on the Upgrade button.

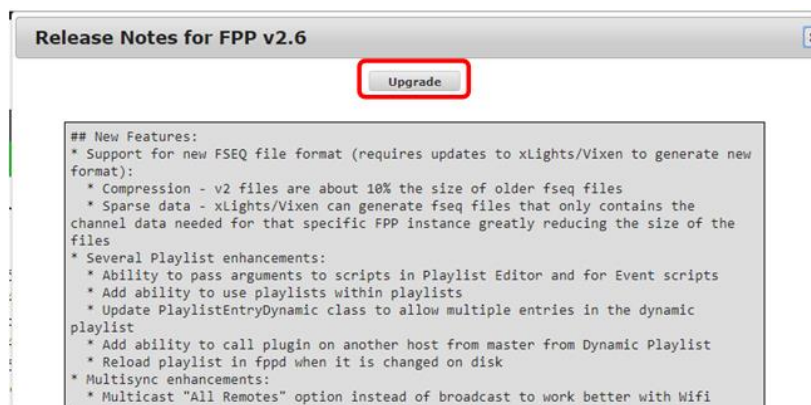

You should get a confirmation page, click OK

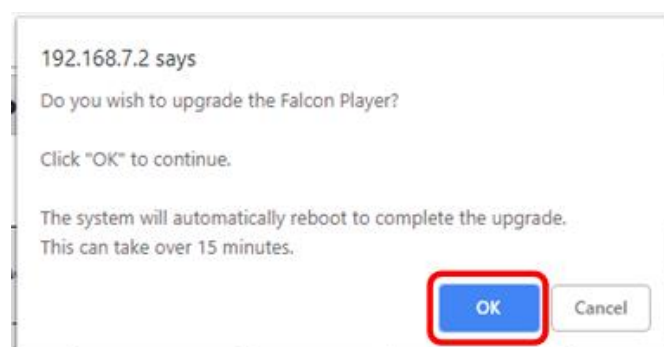

It will take a while to update and look like nothing is happening.



When the update is complete, the screen will return to the About Page. You can verify that it is up to date. If it is up to date, the Local Git version will be the same as the Remote Git Version.

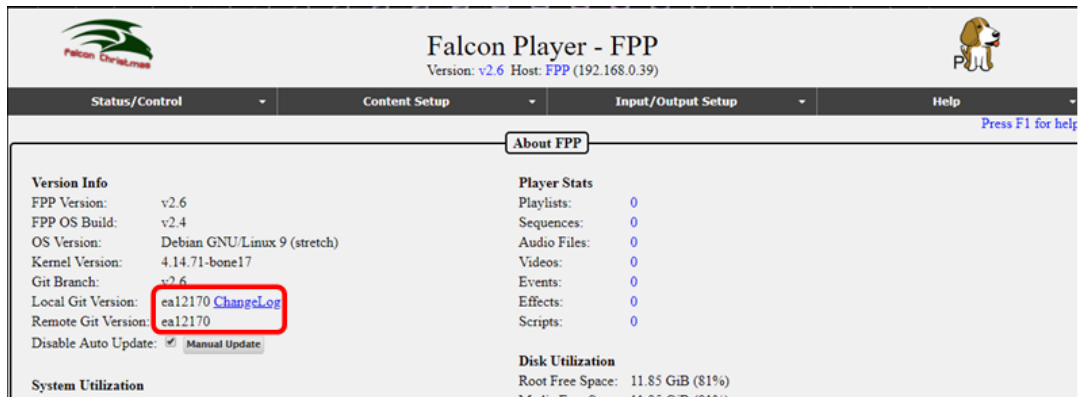

Your FPP software is now installed and up to date. There are many ways that FPP can be used and the settings required to run your show will vary depending on your particular setup. Refer to the appropriate section(s) for more information.

# FPP Details

The following sections go over each section of the FPP interface with more detailed explanation of each feature.

## Program Settings and Navigation

The following sections will explain the program sections and settings and explain how they work. Depending on your current setup or version of FPP, the screens might be slightly different. There are 4 main sections in FPP. Status/Control, Content Setup, Input/Output Setup and Help.

At the top of each page is a status/navigation page.



The Main Page is accessed by using a web browser and entering the IP address or HostName of the Raspberry Pi/BB that you previously setup. For example in this case: 192.168.0.101 or <http://YardPi> (the actual IP or host name will be different depending on your setup).

1. Main navigation toolbar for different areas for settings/configurations and will be on every page. Clicking on one of these headings will give you more options to choose for that category and will be explained in the section pertaining to that selection below.
2. At the top of each page, the current FPP version number is displayed along with the host name and IP address(es) of the FPP.
  - a. In this case, the Version is 2.6.
  - b. In this case, the HostName is YardPi and can be used to access this FPP using <http://YardPi> (your actual name may be different depending on how you set it up)
  - c. There are two IP addresses listed here, one for the wired (eth0 Ethernet connection) 192.168.101.1 and a wireless (wlan0) connection connecting to my home network, 192.168.0.101, (your IP addresses will be different or missing depending on your setup.) If your network is setup correctly, then you can access the FPP using either IP address.

Note: You will normally need to configure a static route in your computer or router in order to access both subnets (see the [Network Configuration](#) in the Advanced settings)

3. This is a graphical representation of the SBC that the FPP is installed on. It will be different for the different versions of Pi or BB.
4. In the upper right corner is a link that says “Press F1 for help.” Clicking on this link or pressing F1 on the keyboard will bring up help topics specific to the page you are currently viewing.



- At the bottom of each page are controls for the Pi/BB SBC. These are used to reboot or shut down the Pi/BB. The Restart FPPD button, turns off the FPP Daemon, and restarts it. This allows the FPP to reload many of the configuration changes without having to do a full reboot of the Pi/BB.

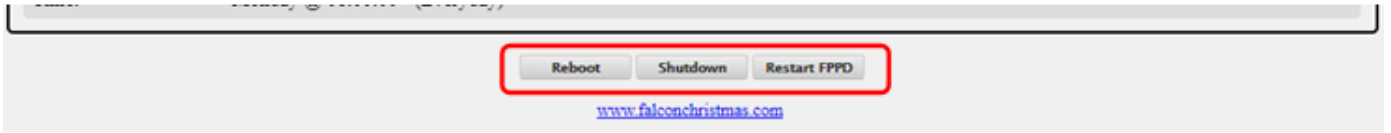

If there is a major upgrade available for the installed version, then a green bar will be displayed to give you the opportunity to upgrade to the next version. Minor versions will have to be manually installed (this is the default setting) unless you have the settings set to automatically update (not recommended)

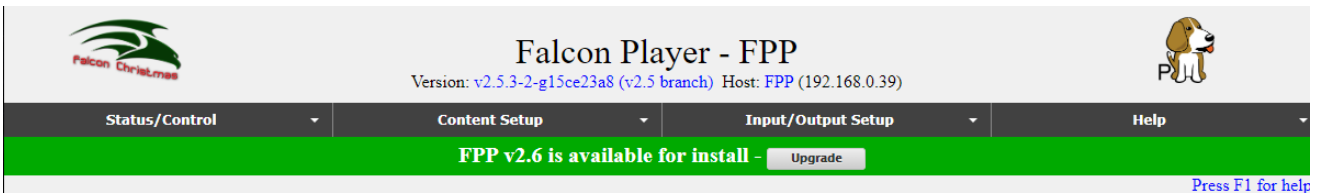

# Status/Control

This section is for various settings and status reports. Clicking on the Status/Control tab will give you several options to choose from:

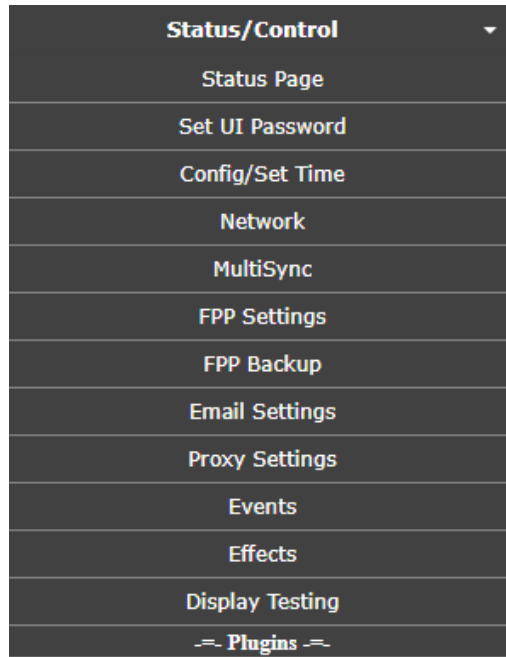

## Status Page

The Status Page is the default page that will load when you first log into FPP.

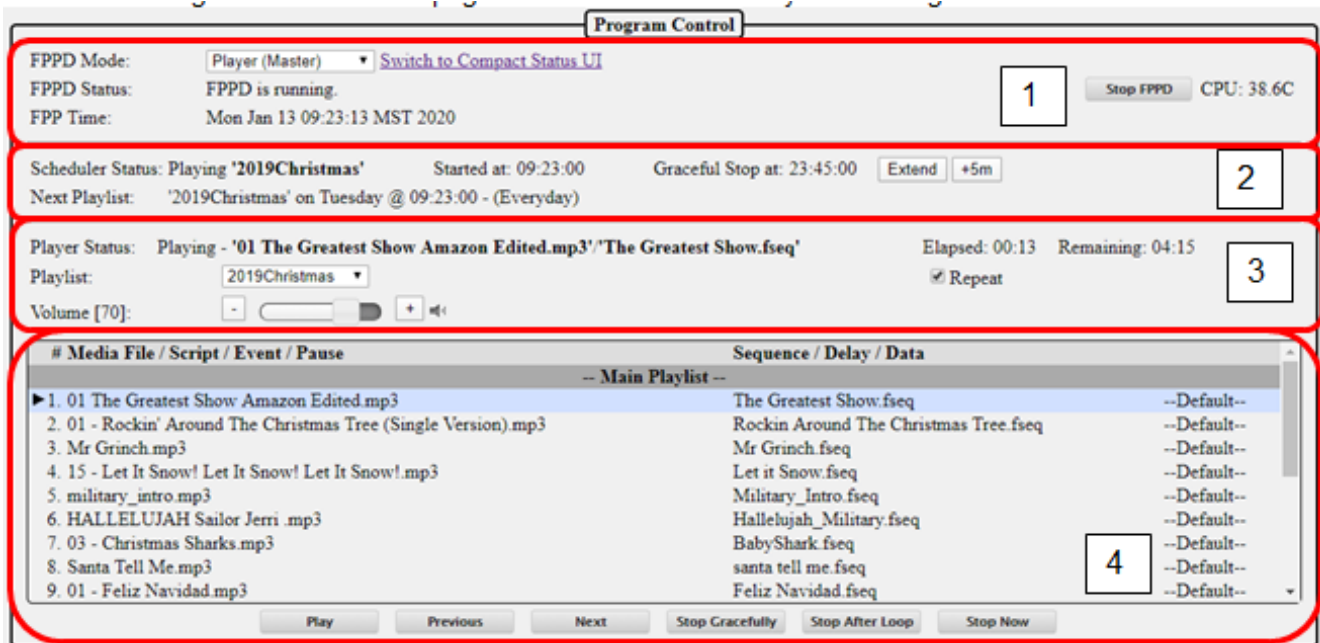

1. Program Control-this will give you the main settings for the mode of the FPP and the current status.
  - a. FPPD Mode- There are four modes for the FPP
    - i. Player (Standalone)-This setting is used when this FPP is going to operate without any interaction from an outside source like xSchedule, xLights, or another FPP. This is commonly used if you only have one FPP in your show and have a playlist and schedule set up, or if you have

- an independent display that is not synchronized to the rest of your show. You will also need to have the appropriate Channel Outputs setup.
- ii. **Player (Master)**-This setting is used if you are going to have more than one FPP and you want them to all be synchronized. The Master will need a copy of the sequences (.fseq) and media (music) files. The Master FPP will also be where your Playlists and Schedules are created. The Remotes that you want to be synchronized need to be identified in the MultiSync page as well. If the Master is also connected to a controller then the appropriate Channel Outputs will need to be setup.
  - iii. **Player (Remote)**-This setting is used if you are going to synchronize this FPP and attached controller to a Master FPP. The Remote will need a copy of all the sequences (.fseq) that are going to be played. If the remote is going to be projecting videos to a projector, the video file will need to be saved on the remote as well. You will also need to have the appropriate Channel Outputs setup.
  - iv. **Bridge**-This setting is used to accept E.131 or DDP input data and pass them on to the attached controllers (i.e. Bridge). This is typically used for testing directly from XLights without creating a sequence.
- b. **FPPD Status**- This will show you the current status of the FPP.
    - i. **FPPD is Running**-This indicates that the FPP is running and ready to run your show.
    - ii. **FPPD is Stopped**-This indicates that the FPPD has been temporarily stopped, either manually or via a script.
    - iii. **FPPD is Updating**-This indicates that the FPPD is updating the software and when complete should resume to FPPD is Running.
  - c. **FPP time**-This will show the current date and time for the FPP. This is important if you have playlists or events scheduled.
  - d. **Switch to Compact Status UI**- This will make the browser window show a minimal list which is good if you are viewing the webpage from a cell phone.

### Falcon Player - FPP

Version: [v3.x-master-367-g99808236 \(master branch\)](#)  
Host: [FPPMaster](#) (192.168.1.100)

---

FPP Mode: Master  
FPP Status: FPPD is running.  
FPP Time: Sun Jan 12 21:09:40 MST 2020

---

Playing - '18 - Text Me Merry Christmas (feat. Kristen Bell).mp3'/'Text Me Merry Christmas.fseq'

Playlist: 2019Christmas ▾ Repeat:

Volume [70]   :

---

---

'StaticLights' on Sunday @ 23:45:00 - (Everyday)

[Return to Full UI](#)

- e. **Stop/Start FPPD**-This is used to stop or start the FPPD system.
- f. **Temperature**- Raspberry Pis (the newer models) have a temperature sensor on the board and if you are using one of those then you can see the temperature.

Some of the newer KulpLights.com controllers have temperature sensor(s) and voltage sensors and will display that info as well.

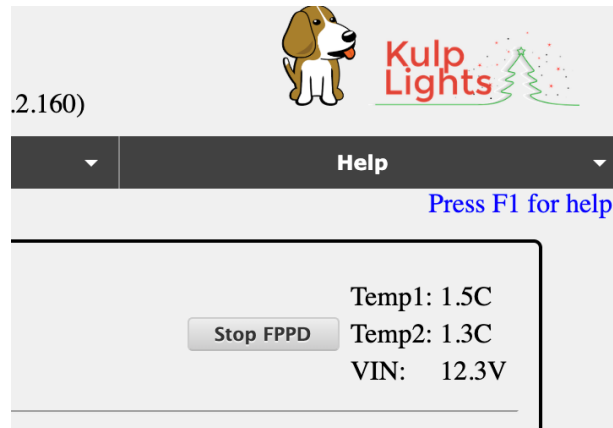

If you click on the temperature, it will toggle between Fahrenheit and Celsius.

2. Scheduler- This section shows the status of your scheduler and options to control a playlist that is playing.
  - a. Scheduler Status-This will show the status of any playing playlist. It will show what time it started and the time that it is scheduled to end and the type of ending strategy that was scheduled.
  - b. Playlist time extension-You can manually extend (or reduce) your currently playing playlist. If you click on the Extend button, you can change the scheduled end time in minutes (you can use a negative number to shorten the end time). There is another button to extend the playlist in increments of 5 minutes. You can only change the end time by a maximum of 720 minutes (12 hours) or reducing it by 360 minutes (3 hours). Once a playlist has reached its scheduled end time, this option will no longer be available even though a song might still be playing (Graceful shutdown)
  - c. Next Playlist-The next scheduled playlist will show indicating the start time and day that it will start.
3. Playlist Info-This section will give you the current status of your playlist.
  - a. Player Status-this tells you if a playlist is playing and what the current song is playing. It will also tell you how long the current song has been playing and how much time is left until the end of the song. If there is no playlist playing, the status will be "Idle." It will also indicate if a song is shutting down gracefully (finishing the song and then shutting down.)
  - b. Playlist-This is a dropdown box with your playlists so that you can manually start one of your stored playlists.
  - c. Volume-This is where you can control the output volume for the currently playing sequence. This can be used to control the volume supplied to an FM transmitter or external speakers.
  - d. Repeat-If this box is checked then the playlist will continue to play until it is manually stopped.
4. Player controls-This controls the currently queued playlist.
  - a. Media file/Script/Event-This will show you the details of the currently queued playlist. If the playlist is playing, it will indicate which song is playing by highlighting it and putting an arrow next to it.
  - b. Play-This will play the queued playlist at the element selected. If the Repeat box is checked, the playlist will continue to play until manually stopped or a scheduled playlist starts.
  - c. Previous- This will step to the previous playlist item when a playlist is playing.
  - d. Next- This will step to the next playlist item when a playlist is playing.

- e. Stop Gracefully-This will finish the song that is currently playing and then stop the playlist.
- f. Stop After Loop-This will stop the playlist when the end of the currently playing playlist is reached.
- g. Stop Now-This will stop the playlist immediately.

## Set UI Password

Press F1 for

UI Password

Enabled:  Disabled:

Username:

Password:

Confirm Password:

There is no password required to access FPP via the web interface. **Changing the password is only for advanced users as it could cause some of the functionality of FPP to be disabled without additional formatting.** It is not usually required to setup a UI password because the UI can only be reached from a computer that has access to your local network. You can setup a user password to access the UI. The password has to be at least 8 characters. Once the password is set, you will have to use the username of admin and the password you set to access any of the screens.

## Config/Set Time

This page is used to configure your time and location settings. If you want your Playlists to automatically start at scheduled times, then the FPP has to be configured to keep accurate time.

Time Settings

**Manually Set Date/Time**

Date:  (Expected format: YYYY/MM/DD)

Time:  (Expected format: HH:MM in 24 hour time)

**Real Time Clock**

**NOTE:** You must reboot to activate the RTC, then return to this page to set the time on the RTC.

**NTP**

Enabled:  Disabled:

NTP Server (optional):

**Time Zone**

---

**Geographic Location**

Latitude:

Longitude:

NOTE: Latitude/Longitude are optional but are used to determine sunrise/sunset times in the FPP Scheduler. There are various ways to locate your Latitude and Longitude values including [Google Maps](#) and [LatLong.net](#). The default values provided are for Falcon, Colorado.

**Manually Set Date/Time-**If your FPP doesn't have access to the internet, then you can manually set the date and time in this section. The time is in 24 hour format (Military Time).

Note: if your FPP is not configured to get the current time from the internet or a Real Time Clock Hat/Cape is not attached and configured, then the time on the FPP will gradually drift away from the actual current Date/Time

Real Time Clock-If you have a Cape/Hat attached that has a Real Time Clock (RTC), you can select the Cape/Hat from the drop down list. Once you select the correct Hat/Cape, you will need to reboot the FPP device and then setup the time from this page.

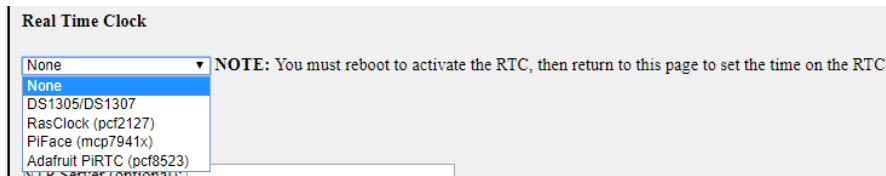

NTP-This is Network Time Protocol and if your FPP device is connected to the internet, then you can configure your FPP to keep current time with the NTP. You would select the Enabled radio button. If you want a different Time server than the default then you can enter the http address of the Time Server you want to use. You should normally keep the NTP Server blank.

Time Zone-If you are using a Network Time Protocol server to keep the current Date/Time, then you will need to select your time zone so that your FPP can adjust the time accordingly.

Geographic Location- If you want to use the Sunrise or Sunset option of scheduling your Playlist to start or end, then you will need to enter your location in Latitude and Longitude. You can get this information by entering your address into LatLong.net or GoogleMaps.com. If you use GoogleMaps, then after you enter your address, the Latitude and Longitude will be in the address bar after the @ symbol. The Latitude is listed first and then the Longitude. Make sure to use the – sign if it is indicated. You can double check the entry by clicking on the View Location button and verify that the coordinates are correct.

## Network

The Network Configuration page is where you setup your Network settings so that you can communicate with your FPPs and controllers and all of your FPPs and controllers can communicate as needed with each other. Networking works similar whether you use wireless or wired and they work together.

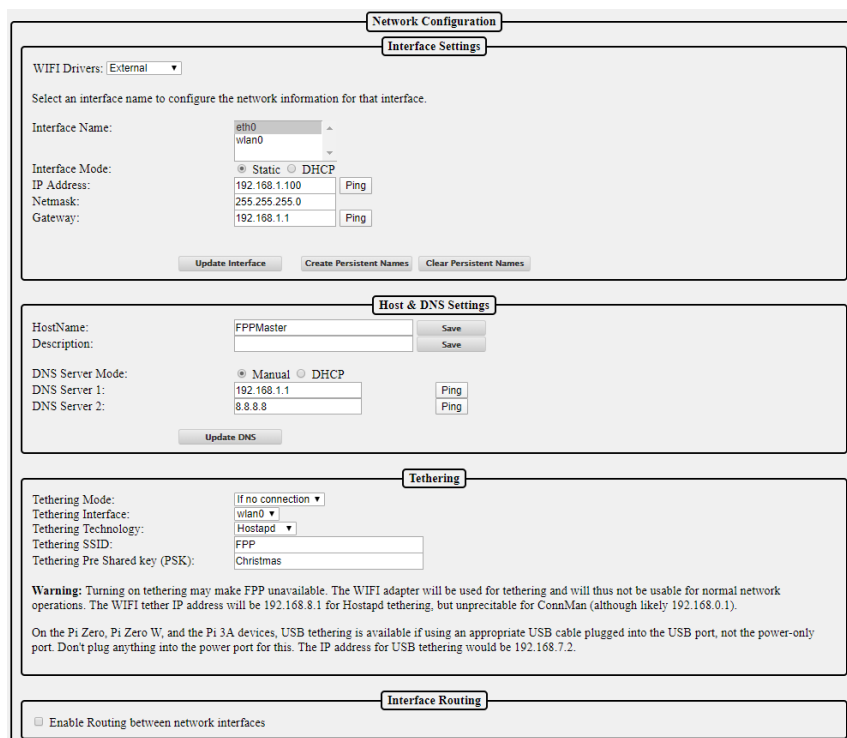



Because there are so many variations of setting up your network, the network settings seem to be problematic for some people. The basic setup at the beginning of this manual should get you running. That setup might not be the best for you in the long run. The following should get you a better understanding for a better setup for your particular situation.

Canispater Christmas has a good video at <https://youtu.be/kn1BiolQbgw> and Keith Westley, one of the xLights developers, has a good video as well at <https://youtu.be/g0fOZs6UqXw>.

There is a good article that you should read about wireless and remotes at: <https://falchristmas.com/forum/index.php/topic,4231.0.html>.

If you need more information on networks and IP addresses and how they work, then refer to the [Networking Configuration](#) section of the Advanced Options section.

## Interface Settings

Depending on the device, the FPP could have up to 2 network devices built-in (more if you install additional network adapters, but this is not common). One is labeled eth0 for Ethernet connections (wired) and the other is wlan0 connections (wireless). If you have both eth0 and wlan0 on your FPP, then you have to select and set each one up separately.

The screenshot shows the 'Interface Settings' section of the network configuration interface. It includes a dropdown for 'WIFI Drivers' set to 'External'. Below that, a prompt asks to 'Select an interface name to configure the network information for that interface.' The 'Interface Name' dropdown is currently set to 'eth0'. The 'Interface Mode' is set to 'Static' (radio button selected). The 'IP Address' field contains '192.168.1.100', the 'Netmask' is '255.255.255.0', and the 'Gateway' is '192.168.1.1'. Each of these three fields has a 'Ping' button to its right. A red box highlights the 'eth0' and 'wlan0' options in the 'Interface Name' dropdown, with a red arrow pointing to it from a box labeled 'Select Network'. Another red box highlights the 'IP Address', 'Netmask', and 'Gateway' fields, with a red arrow pointing to it from a box labeled 'Enter Details'. At the bottom, there is a red box around the 'Update Interface' button, and also buttons for 'Create Persistent Names' and 'Clear Persistent Names'.

There are two options for Interface Mode, Static and DHCP.

- DHCP-Your home router will assign and manage the IP address(es) for your FPPs and controllers, this is the easiest method but has some drawbacks. Your router might not save the IP address if your FPP has been disconnected from the network for a lengthy time so it might cause problems in the future.
- Static-You will assign the IP address for your FPPs and controllers. This is usually the preferred method so that you can always access your devices. Using this option, you have to make sure that the IP addresses are unique. You have to be careful to not assign an IP address to an address that your router has already assigned to another device through the DHCP process. Most routers will assign DHCP addresses at the lower end of the range, but this isn't always true. Some routers have the ability for you to limit the range of IP addresses that it will use for DHCP in order to prevent any conflicts.

**NOTE: If you are using both network interfaces they must be on different subnets! Also only assign one interface to have a Gateway.**

To set up your networks, select the network (Interface Name) you want to setup and enter the details. Once that is complete, then click on the Update Interface button. This saves your

settings. If you need to setup the other network, click on that network and then you will have new options to enter your details. Click on Update Interface when completed. When you are finished with all of your changes, reboot the FPP. If you are setting up your eth0 network, the Wireless Settings will not be available.

If you are unsure of what your settings should be, refer to the [Networks](#) and [Network Configuration](#) section of the manual.

If you are using more than one Ethernet interface (common for users with a Color-Light board) and you need the Ethernet adapter to keep the configuration order, then you can create a Persistent Name. The best practice would be:

- Power down the FPP device.
- Make sure that only the primary Ethernet interface is installed.
- Power up the FPP device.
- Plug in the USB Ethernet adapter.
- configure the eth0 and eth1 devices
- Click on Update Interface
- Click on Create Persistent Name

This will save your eth0 and eth1 configurations so that they will load up in the correct order..

## Host & DNS Settings

This section is to assign some networking settings that are for this device.

Host & DNS Settings

HostName:  Save

Description:  Save

DNS Server Mode:  Manual  DHCP

DNS Server 1:  Ping

DNS Server 2:  Ping

Update DNS

HostName- You can give a meaningful name to your FPP device and this can be used to access your device in a web browser instead of using the IP address. It is important that your FPP/Controllers have unique Host names. If you are not going to have any other FPP instances then you can keep it as FPP if you want but it is not recommended because in this hobby, people have a tendency to expand their show and it is highly recommended that you rename it so there will be no confusion in the future. The HostName can only have letters, numbers, and hyphens (-). It may not begin or end with a hyphen and cannot have any spaces.

Description-This is used to provide some additional information or a more meaningful name for your device and does not have the limitations as the Host Name. This will show up in your Multi-Sync page and the xLights FPP connect screen.

DNS Server Mode- This is to select what DNS server the FPP is going to use. Selecting Manual allows you to set the IP address for the DNS server. You have the option of selecting a main DNS Server and a backup one. If you select DHCP then the FPP device will attempt to get a DNS address from the DHCP Server (usually your home router). Not all connected devices have a DNS server so selecting DHCP might not work. (See the [Network](#)

[Configuration](#) for more information.) It is usually recommended to set one server to 8.8.8.8 and the other to the IP address of your router.

## Tethering

There are two types of Tethering that can be used with FPP. One is Wi-Fi Tethering where the FPP will behave as its own Access Point and USB Tethering where the FPP is connected directly the computer via a USB cable.

### Wi-Fi Tethering

Wi-Fi Tethering is useful in order to access the FPP if there is no network connected to either the Ethernet or Wi-Fi connection. This is especially useful for the Raspberry Pi where there is no Ethernet connection and the Wi-Fi connection has not been set up yet. To connect to the FPP device when the Tethering mode is active, your FPP device will need to be fairly near your computer. You will then need to connect to the FPP WI-FI network that should be visible in your computer's network settings. Depending on your Operating system the process could be different but the process is the same as when you first connected your computer to your home Wi-Fi.

The password for the network will be Christmas. Once you are connected to the FPP network, you can access the FPP with the IP address of 192.168.8.1

Tethering

Tethering Mode:	<input type="text" value="If no connection"/>
Tethering Interface:	<input type="text" value="wlan0"/>
Tethering SSID:	<input type="text" value="FPP"/>
Tethering Pre Shared key (PSK):	<input type="text" value="Christmas"/>

**Warning:** Turning on tethering may make FPP unavailable. The WIFI adapter will be used for tethering and will thus not be usable for normal network operations. The WIFI tether IP address will be 192.168.8.1.

On the Pi Zero, Pi Zero W, and the Pi 3A devices, USB tethering is available if using an appropriate USB cable plugged into the USB port, not the power-only port. Don't plug anything into the power port for this. The IP address for USB tethering would be 192.168.7.2.

There are 3 WI-FI tethering modes available

- If no connection-This is the default setting. If the FPP device does not detect a network connected to any of the network ports, it will activate a Wi-Fi access point when it powers up called FPP.
- Enabled-When this option is selected; the FPP device will boot up and activate the Wi-Fi access point.
- Disabled-When this option is selected; the Wi-Fi access point will not be activated.

You can change the SSID name and password if you want, but it is not recommended.

There is a warning but this warning is more for the BeagleBone SBCs where you have to add a separate USB Wi-Fi adapter. The Raspberry Pi's internal Wi-Fi works well in the Wi-Fi Tether option and if you are using a BB SBC it is recommended to use a USB tether connection or Ethernet connection.

### USB Tethering

There is also the option of using USB tethering for the BB SBCs, Raspberry Pi Zero, and the Pi Zero. To connect using the USB tethering, connect the SBC via the USB port to your computer. (On the Pi Zeros, there are two USB ports, one is for power only, the other is a true USB connection, make sure you connect to the correct port. This will supply the power

as well.) After the SBC is properly connected and is booted up, you can access the FPP by using the IP address of 192.168.7.2

**Note: Due to the number of various USB Wi Fi adapters, the Wi Fi Tethering might not work using a USB Wi Fi adapter (this does not apply to the internal Wi Fi adapters on the Raspberry Pis or BeagleBones). The recommended method of Tethering the BeagleBones is through the USB connection.**

## Interface Routing

If you are using your FPP device to communicate to one network via Wi-Fi and passing the communication through your eth0 interface then you need to check the Enable Routing between network interfaces. (Like a controller attached to your FPP device, not a hat or cape.) This will allow communications to pass through your FPP device to the connected controller.

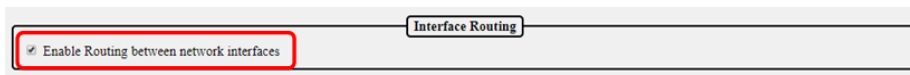

## MultiSync

The Multi Sync page is where you setup a Master/Remote Layout. A Master/Remote layout eliminates the need for Ethernet cables connecting all of your FPPs/controllers and allows for widespread model placement. See the [Master/Remote](#) section of the Advanced Settings section for more information on the setup and functionality of the Master/Remote layout.

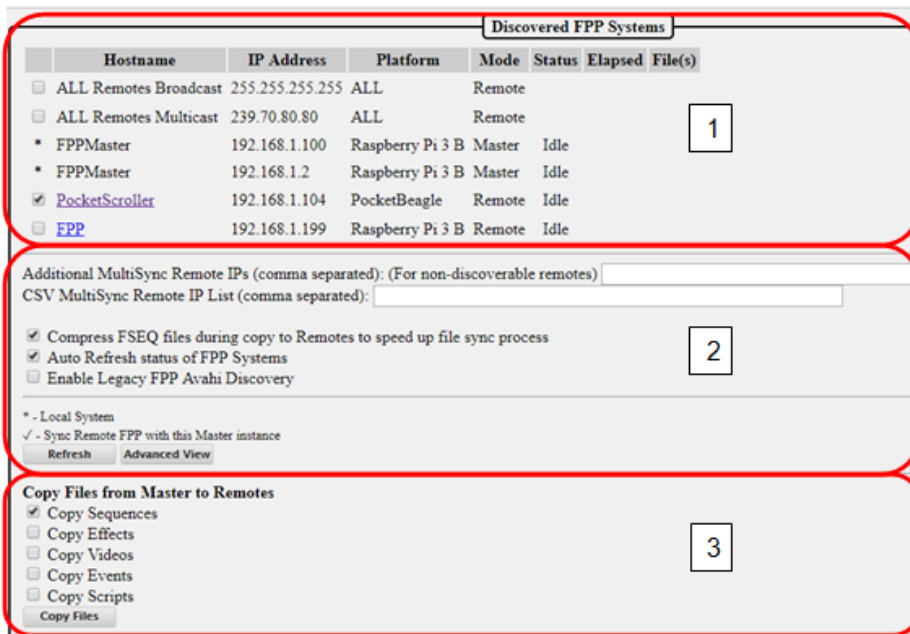

1. Discovered FPP systems-This section will list all of the FPP devices that were discovered. In this section, you can select which FPP systems you want to sync with your master.
  - a. ALL Remotes Broadcast-This will send a Broadcast sync packet to every device on the network whether they need it or not. This is an older method that was used but not commonly used. Broadcast packets are sent at a slower speed and not as often as Multicast.

- b. ALL Remotes Multicast-This will send a Multicast packet to all devices that have been identified as needing the sync packets. This is a newer method and preferred over All Remotes Broadcast but does not work with FPPs with a version less than 2.6 or if you are using a Falcon Controller as a remote\*
- c. Individual FPP selection-This can be used if you want to specifically select the FPPs that you want to synchronize or upload files from the Master FPP. If any of your FPP devices are not using a version of FPP equal or greater than 2.6 or you have a Falcon Controller as a remote\* than this is the recommended method.

\* As of the writing of this manual, the Falcon Controllers did not support the Multicast format but this should be fixed in a future update to the Falcon Controller. Also, not all home networking equipment supports Multicast.

2. Additional Settings-This section is to add some additional options in how you want your Master FPP to sync with your remotes.
  - a. Additional MultiSync Remote IPs-This field will show previously synched remotes that were not discovered when the MultiSync page loaded. It can also be used to manually add devices that don't respond to the discovery process, such as Falcon controllers set to Remote or a Remote FPP that is on a different network subnet.
  - b. CSV MultiSync Remote IP list-This is no longer used. It was used for setting up a few devices, but those devices have been updated and this will probably be removed in a future update.
  - c. Compress FSEQ Files-If this box is checked, the Master FPP will compress the files before sending them to the remotes. This saves a lot of time in the copy process.
  - d. Auto Refresh status of FPP Systems-If this box is checked, the status and the currently playing file will continually update and show how much time has elapsed on the current file. If it is not checked, it will just show the status of the controllers at the moment the page was loaded.
  - e. Enable Legacy FPP AVAHI Discovery- If any of your remotes are running a version of FPP before 2.4 then you will need to enable this. The AVAHI discovery is slower.
  - f. Refresh button-If the Auto Refresh status is not checked, this will refresh the status of all the discovered remotes.
  - g. Advanced View-This will show you some additional information on all of your remotes, such as current FPP version, if an update is available and the CPU utilization.

Discovered FPP Systems							Version	Git Version(s)	Auto Updates	Utilization
<input type="checkbox"/>	ALL Remotes Broadcast	255.255.255.255	ALL	Remote						
<input type="checkbox"/>	ALL Remotes Multicast	239.70.80.80	ALL	Remote						
<input checked="" type="checkbox"/>	FPPMaster	192.168.0.23	Raspberry Pi 3 Model B	Master	Playing 01:02	Text Me Merry Christmas.fseq 18 - Text Me Merry Christmas (feat. Kristen Bell).mp3	2.x-185-g9893d11b	R: 9893d11 L: 9893d11	Disabled	CPU: 67% Mem: 19% Uptime: 8 days
<input checked="" type="checkbox"/>	FPPMaster	192.168.0.100	Raspberry Pi 3 Model B	Master	Playing 01:01	Text Me Merry Christmas.fseq 18 - Text Me Merry Christmas (feat. Kristen Bell).mp3	2.x-185-g9893d11b	R: 9893d11 L: 9893d11	Disabled	CPU: 67% Mem: 19% Uptime: 8 days
<input type="checkbox"/>	YardPI Yard PI controller	192.168.101.1	Raspberry Pi 3 Model B	Remote	Syncing 01:01	Text Me Merry Christmas.fseq	2.5.3	R: 15ce23a L: 926a5c0	Disabled Update Available	CPU: 18% Mem: 17% Uptime: 5 days
<input checked="" type="checkbox"/>	YardPI Yard PI controller	192.168.0.101	Raspberry Pi 3 Model B	Remote	Syncing 01:02	Text Me Merry Christmas.fseq	2.5.3	R: 15ce23a L: 926a5c0	Disabled Update Available	CPU: 14% Mem: 17% Uptime: 5 days
<input checked="" type="checkbox"/>	PocketScroller	192.168.0.104	BeagleBone Black PocketBeagle	Remote	Syncing 01:01	Text Me Merry Christmas.fseq	2.6	R: ea12170 L: ea12170	Disabled	CPU: 89% Mem: 28% Uptime: 21:35

- Copy files from Master to Remotes-When you click this button, the Master FPP will upload all of the selected files that are stored on the Master FPP to all of the selected Remotes. The Master will try to upload to the controllers that are in the Additional MultiSync Remote IP field as well. During the upload, the Master will only upload files that are needed. If the Remote already has the most current file that is saved on the Master, it will skip that file.

## FPP Settings

This page is to setup some administrative functions and master settings.

FPP Global Settings

Blank screen on startup:	<input type="checkbox"/>
Force HDMI Display:	<input type="checkbox"/>
Force Legacy audio outputs (mpg123/ogg123):	<input type="checkbox"/>
Pi 2x16 LCD Enabled:	<input type="checkbox"/>
Always transmit channel data:	<input type="checkbox"/>
Blank between sequences:	<input type="checkbox"/>
Pause Background Effect Sequence when playing a FSEQ file:	<input type="checkbox"/>
Default Video Output Device:	HDMI ▾
OMXPlayer (mp4 playback) Audio Output:	ALSA ▾
Disable IP announcement during boot:	<input type="checkbox"/>
Audio Output Device:	Sound Blaster Play! 3 ▾
Audio Output Mixer Device:	Speaker ▾
Audio Output Format:	Default ▾
UI Border Color:	No Border ▾
OLED Status Display:	Disabled ▾
Locale:	USA ▾
Log Level:	Info ▾
Log Mask:	<input type="checkbox"/> ALL <input checked="" type="checkbox"/> Most (default)
	<input type="checkbox"/> Channel Data <input checked="" type="checkbox"/> GPIO
	<input checked="" type="checkbox"/> Channel Outputs <input checked="" type="checkbox"/> Media Outputs
	<input checked="" type="checkbox"/> Commands <input checked="" type="checkbox"/> MultiSync
	<input checked="" type="checkbox"/> Control Interface <input checked="" type="checkbox"/> Playlists
	<input checked="" type="checkbox"/> E1.31 Bridge <input checked="" type="checkbox"/> Plugins
	<input checked="" type="checkbox"/> Effects <input checked="" type="checkbox"/> Scheduler
	<input checked="" type="checkbox"/> Events <input checked="" type="checkbox"/> Sequence Parser
	<input checked="" type="checkbox"/> General <input checked="" type="checkbox"/> Settings

[Advanced Settings](#)

**Blank Screen on Startup-** If you are using this FPP to play video through the HDMI port, then you want to enable this setting. By default the FPP will display system data to the HDMI port so that you can connect a monitor, but if you are using the HDMI to output video, the video will not block the system output to the HDMI port so you could get the system display showing along with your video. The screen blanking will turn the text console off after one minute so that it does not show through when you are not playing a video or when playing a video that doesn't match the screen's aspect ratio.

**Force HDMI Display-** This option should be enabled if you are playing video on a projector via the HDMI output.

**Force Legacy audio outputs (mpg123/ogg123)-** This was an old option to allow mpg123/ogg123 files to be processed by an external program and not the FPP. The FPP now has the capability to process those files so will probably be deleted in a future release.

Pi 2x16 LCD enabled- Enable use of the PI Plate with 16x2 Character LCD display and Keypad.

Always transmit channel data- Force transmission of channel data out to controllers whenever FPP is running. FPP will normally only transmit data when there is a sequence playing or the system is running in Bridge mode or a Pixel Overlay model is enabled. Some older controllers go into test mode when not receiving data. This setting causes FPP to always send data so the controllers do not go into test mode. If selected, FPP will ensure that lights turn off at the end of a sequence or when a 'Stop Now' is selected.

Blank between sequences-This setting will send out blanking data to turn the pixels off when a sequence finishes. This is for some older DMX controllers that keep sending out the last command that they were given so models would stay lit until the next sequence began to play.

Pause Background Effect Sequence when playing a FSEQ file- Effect sequences take priority over FSEQ files. Select this option if you have Background Effect Sequences and you want the FSEQ file to take priority over the Background Effect Sequence.

Default Video Output Device- If you are using your FPP to directly play a video, then you can select which device you want the video to play on. You can select the HDMI output port or you can select a Pixel Overlay model which is usually a P10 or P5 panel display.

OMXPlayer (mp4 playback) Audio Output- If you are using your FPP to directly play a video, and you want to use the audio from the video file, then you can select what device you want to play the audio. This is normally used when the FPP playing the video is acting as a stand-alone set up. If you want the video to be synched with the rest of your show, then your saved video will need to have the same filename as the sequence file that is playing on your master.

Disable IP announcement during boot-When the Raspberry Pi boots up, it will announce its IP address over the audio device. If you do not want this announcement, then select this option.

Audio Output Device-You can select which device you want to play your audio. If you do not have any audio devices installed, like a SoundBlaster, then you will only have the option of the onboard audio device. The BeagleBone SBC does not have onboard audio. If you have a Raspberry Pi then you will have the option of bcm2835 ALSA. The Pi onboard audio will output the sound to the 3.5mm audio jack on the Pi.

Audio Output Mixer Device- FPP will identify the available installed output devices and provide the option to select which device you want to output the audio. By default, it is normally set to speaker which is normally the preferred device.

Audio Output Format- You can select a specific sampling rate and device, normally the default works the best.

UI Border Color-You can select the border color of the user interface (webpage). This could be helpful if you have several devices and you want some visual clue which FPP device you are working on.

## No Border

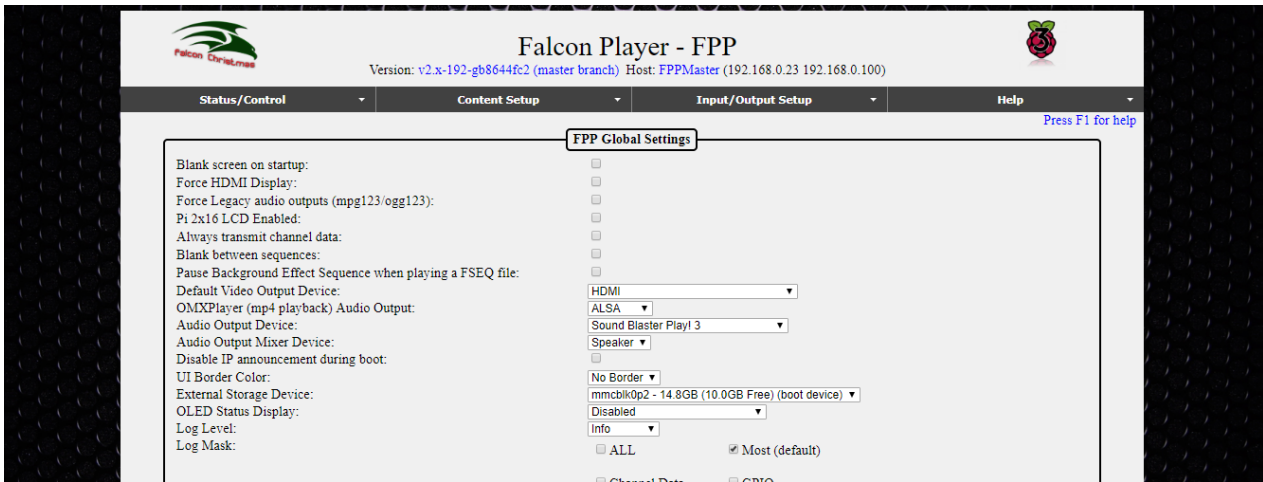

## Blue Border



OLED Status display-You can attach a small OLED display that will give you some basic information on the FPP. The FPP will accept a few different types of OLED boards.



Locale: You can select the Locale that you are in if you want to use the scheduler to set start and end times based on a holiday name instead of entering the date manually.



Log Level-This setting is used for advanced trouble shooting. You should leave this setting at "Info" unless directed by the FPP development team.

Log Mask- This setting is used for advanced trouble shooting. You should leave this setting at "Most" unless directed by the FPP development team.

### Beagle Bone only settings

The BeagleBone series of SBCs have 4 LEDs on the board and the function of each can be controlled.

BeagleBone LEDs:	USR1: Heartbeat ▼
	USR2: SD Card Activity ▼
	USR3: CPU Activity ▼
	USR4: eMMC Activity ▼
	Power: Enabled ▼
<a href="#">Advanced Settings</a>	

You can change the default settings for the LEDs, the most common change is to disable them if the lights might be distracting. It is recommended to keep the defaults.

## Advanced Settings

The Advanced settings are used for some specialized settings. **These settings are for the advanced user so take caution in changing these settings as the results could not be what you intended.**

### FPP Advanced Settings

FPP Advanced Settings	
<input type="text" value="mmcblk0p2 - 29.6GB (24.8GB Free) (boot device) ▼"/>	
<b>Storage Device:</b>	Changing the storage device to anything other than the SD card is strongly discouraged. There are all kinds of problems that using USB storage introduce into the system which can easily result in various problems include network lag, packet drops, audio clicks/pops, high CPU usage, etc... Using USB storage also results in longer bootup time. In addition, many advanced features and various capes/hats are known to NOT work when using USB storage.
	In addition to the above, since it is not recommended, using USB storage is not tested nearly as extensively by the FPP developers. Thus, upgrades (even "patch" upgrades) have a higher risk of unexpected problems. By selecting a USB storage device, you assume much higher risk of problems and issues than when selecting an SD partition.
<input type="checkbox"/>	<b>Display all options/settings</b> - If turned off and FPPD can detect what hardware (cape/hat/etc...) is connected, certain options that are either incompatible with the hardware or are rarely used may not be displayed.
50ms ▼	<b>E1.31 Bridge Mode Transmit Interval</b> - The default Transmit Interval in E1.31 Bridge Mode is 50ms. This setting allows changing this to match the rate the player is outputting. <b>WARNING</b> - Some output devices such as the FPD do not support rates other than 50ms.
0s ▼	<b>Boot Delay</b> - The time that FPP waits after system boot up to start fppd. For environments that are powered down regularly, fppd may start up quicker than the network environment fully starts up which may cause E1.31 multicast to not work properly. Setting a Boot Delay will cause fppd to wait 'X' number of seconds to start which can give the network switches and routers time to fully start up.
0 ms	<b>Media/Sequence Offset</b> - The Media Offset value allows adjusting the synchronization of the media and sequences being played. The value is specified in milliseconds. A positive value moves the media ahead, a negative value moves the media back. Changing this value requires a FPPD restart. <b>WARNING</b> - This offset applies to all media files played. If your media files require different offsets per file then you will have to edit the audio files or sequences to bring them into sync.
0 ms	<b>Open/Start Delay</b> - An extra delay (in ms) between the master sending the "Open" command and actually starting the sequence. This can be used to allow the remotes to have extra time to open the sequence, process videos, etc... This requires master and remote to both be running FPP 3.2 or newer. For complex MP4 files on remotes, a value of around 650-800 is likely needed for the remote video to be loaded and buffers filled prior to first frame being displayed.

Storage Device- You can change the storage location of your settings, sequences, media, etc. to a USB drive; however **this might cause problems** due to the advancement of FPP and technology. USB storage used to be the preferred method of storing your media files but many changes have been made in both xLights and FPP so that the best

method of storing your settings and media is on the SD card. There are also advanced backup methods that make using a USB drive for storage obsolete.

Display all options/settings- FPP can detect most hardware configurations and by default will not show options that are incompatible with your configuration. You can allow FPP to show all options by checking this box, but you will then be able to select settings that might not work as intended.

E1.31 Bridge Mode Transmit Interval- This setting allows for a different timing interval when operating in Bridge mode. The default is 50ms and it is recommended to keep this setting.

Boot Delay- You can add a delay to booting up the FPP. This is helpful if you power down all components in your show, like routers and switches, and turn them on all at the same time. FPP could start before the routers and/or switches have had a chance to fully initialize which can cause communication errors. If you are not powering down your routers and/or switches, then leave the default setting of 0.

Media/Sequence Offset- This setting is used to synchronize the media to the sequence. This can be used if your FM transmitter or other audio processing device(s) creates a consistent lag in the broadcast (this is rare, but it does happen). This can also be used to fine tune the synchronization in a Master/Remote configuration where there is consistent network delay between Master and Remote. (e.g. if you are using a Wi-Fi extender to reach an FPP remote that is far away from the Master and has additional network delay because of the extender)

Open/Start Delay- You can add an extra delay from when the Master sends an “Open Command” to when it actually starts the sequence. Some complex or large video files might take a little longer to buffer before they can start playing.

Grow filesystem on SD card- When you do a fresh install, the microSD card will be partitioned for just the size needed for the operating system. You will need to expand the filesystem so that you have access to the entire microSD card for storing sequences and media files. If the filesystem has been expanded, this option will not be available.

Flash to eMMC- (BeagleBone SBCs only) if you are using a BB series device, then you have two options if you want the device to boot from its internal memory and not the uSD card. Selecting the Flash to eMMC option will save the boot information in the BeagleBone’s native file format. **(This is not the recommended setup)**

Flash to eMMC BTRFS root option - (BeagleBone SBCs only) This will save the boot information in the compressed BTRFS format which will take up less space on the BB memory but will cause a slight impact on CPU usage. **(This is not the recommended setup)**

New partition on SD card- If you select this setting, then you can create a separate partition on your microSD card and format it different than the operating system of the microSD card. This will allow you to remove the SD card and access the FSEQ files, media files, configuration settings, etc. on a different device such as your computer. This is an advanced option and should only be configured if you are familiar with the different file formats used. **(This is not the recommended setup)**

# MQTT

This section is used to setup MQTT settings if you are going to automate your FPP with an MQTT server such as a home automation system.

**MQTT**

MQTT Broker Host:

MQTT Broker Port:

MQTT Prefix:

MQTT Username:

MQTT Password:

CA File (Optional):

MQTT Publish Frequency (Optional):

MQTT events will be published to "\$prefix/falcon/player/\$hostname/" with playlist events being in the "playlist" subtopic.  
CA file is the full path to the signer certificate. Only needed if using mqtt server that is self signed.  
Publish Frequency should be zero (disabled) or the number of seconds between periodic mqtt publish events

FPP will respond to certain events:

Topic	Action
\$prefix/falcon/player/\$hostname/set/playlist/\${PLAYLISTNAME}/start	Starts the playlist (optional payload can be index of item to start with)
\$prefix/falcon/player/\$hostname/set/playlist/\${PLAYLISTNAME}/next	Forces playing of the next item in the playlist (payload ignored)
\$prefix/falcon/player/\$hostname/set/playlist/\${PLAYLISTNAME}/prev	Forces playing of the previous item in the playlist (payload ignored)
\$prefix/falcon/player/\$hostname/set/playlist/\${PLAYLISTNAME}/repeat	If payload is "1", will turn on repeat, otherwise it is turned off
\$prefix/falcon/player/\$hostname/set/playlist/\${PLAYLISTNAME}/sectionPosition	Payload contains an integer for the position in the playlist (0 based)
\$prefix/falcon/player/\$hostname/set/playlist/\${PLAYLISTNAME}/stop/now	Forces the playlist to stop immediately. PLAYLISTNAME can be ALLPLAYLISTS.
\$prefix/falcon/player/\$hostname/set/playlist/\${PLAYLISTNAME}/stop/graceful	Gracefully stop playlist. PLAYLISTNAME can be ALLPLAYLISTS.
\$prefix/falcon/player/\$hostname/set/playlist/\${PLAYLISTNAME}/stop/afterloop	Allow playlist to finish current loop then stop. PLAYLISTNAME can be ALLPLAYLISTS.
\$prefix/falcon/player/\$hostname/event/	Starts the event identified by the payload. The payload format is MAJ_MIN identifying the event.
\$prefix/falcon/player/\$hostname/effect/start	Starts the effect named in the payload
\$prefix/falcon/player/\$hostname/effect/stop	Stops the effect named in the payload or all effects if payload is empty

You will need to configure the settings for your MQTT Host on this page. Refer to your MQTT Broker host for the relevant settings.

# FPP Backup

FPP has several backup options available. You can update just your configuration files through the JSON Configuration Backup or your configuration and all relevant files through the File Copy Backup. This can be useful in restoring your FPP device.

## JSON Configuration Backup

The JSON Configuration Backup will save all or a portion of your different settings and store them on your computer to restore at a later time. This will only save the selected configuration files; it will not save sequence files, audio files, etc.

The screenshot shows the 'FPP Backups' web interface. It has two tabs: 'JSON Configuration Backup' (selected) and 'File Copy Backup'. The 'Backup Configuration' section contains the following elements: a heading 'Backup Configuration', a description 'Select settings to backup, then download the selected system configuration in JSON format.', a checked checkbox for 'Protect sensitive data?', a 'Backup Area' dropdown menu set to 'All', and a 'Download Configuration' button. The 'Restore Configuration' section contains: a heading 'Restore Configuration', a red warning message 'JSON Backups made from FPP v1.x are incompatible with the FPP 3.x system.', a description 'Select settings to restore and then choose backup file containing backup data.', checked checkboxes for 'Keep Existing Network Settings' and 'Keep Existing Master/Slave Settings', a 'Restore Area' dropdown menu set to 'All', a 'Choose File' button (with 'No file chosen' text next to it), and a 'Restore Configuration' button.

### Backup Configuration (creating a backup)

Protect sensitive data- If you have this selected, then the password to your wlan0 network will not be saved and you will have to log into the device once the configurations have been restored and enter your wlan0 password. If it is not selected, then a complete backup will be saved and when restored the FPP should be functional. Just be aware that anyone that has access to the backup file you saved will be able to view your wireless password if they open up the backup file. If you change the setting to allow a complete backup, you will get the following information box.

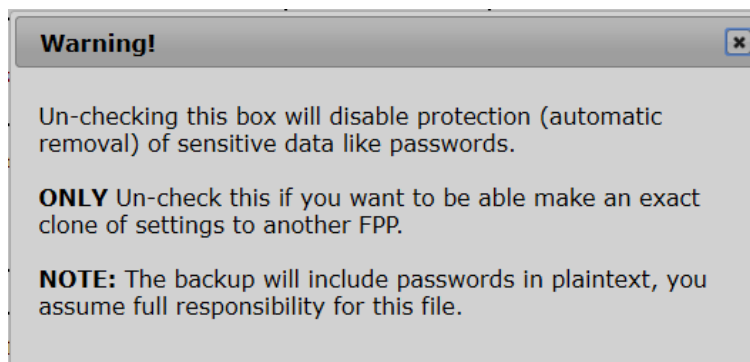

Backup area-This will select what portion of your FPP configuration you want to save, normally you will select all. You can select individual sections if you want.

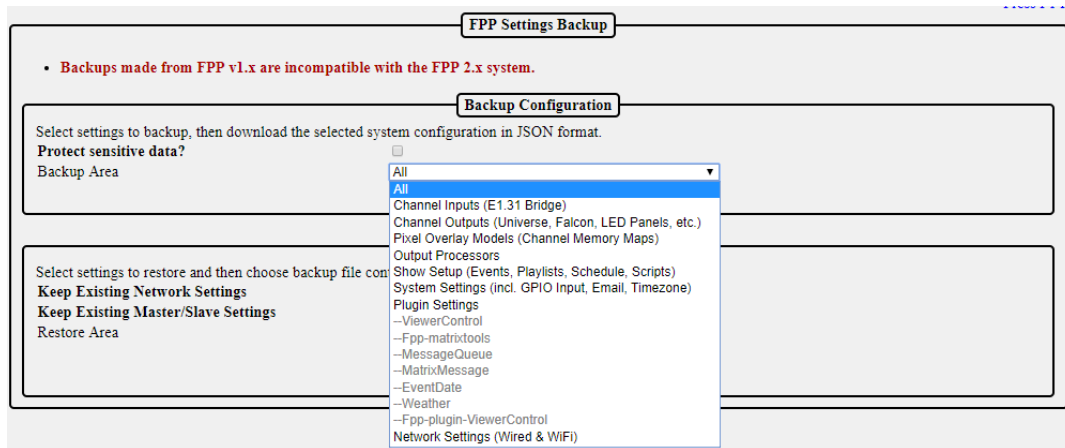

Download Configuration- click on this button to save your configuration settings. This will prompt you for a location to save your configuration file onto your computer. The file will be named with the device name and a timestamp in the name so that you can identify the most current version in case you have more than one backup.

**NOTE:** This will not save your media files such as sequences, music, or videos.

## Restore Configuration

Keep Existing Network Settings-If this is selected, then the network settings that are saved on the FPP will not be updated to the settings on the saved backup.

Keep Existing Master/Slave Settings- If this is selected, then the Master/Slave settings that are saved on the FPP will not be updated to the settings on the saved backup.

Restore Area-You can select only a specific area to restore on the FPP. Any other settings that are configured on the FPP will not be updated.

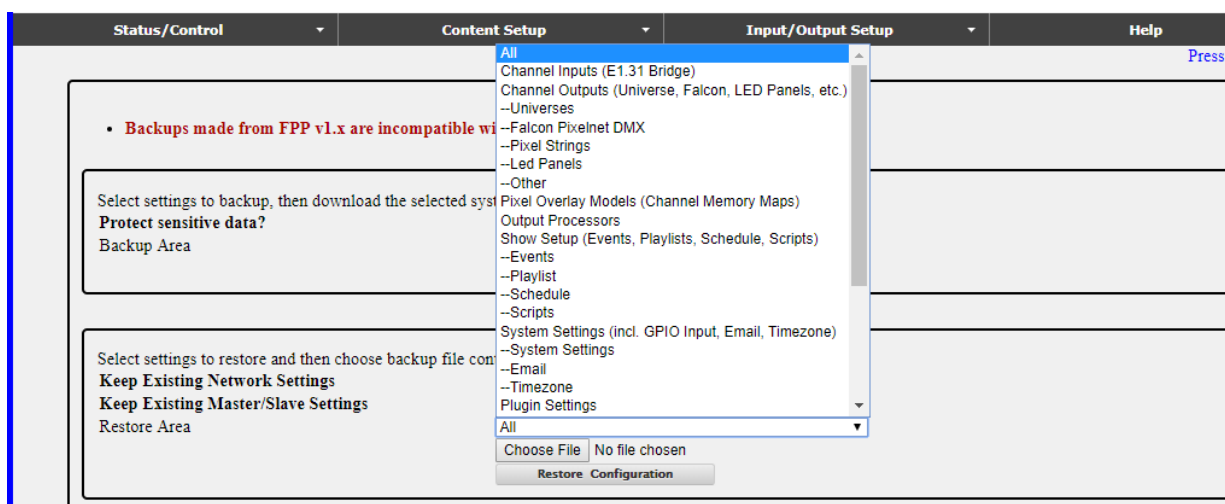

Choose File-Click on this button and find the backup file that you want to use for your restored settings. Make sure it is the correct one if you have multiple configurations saved.

Restore Configuration-If you have a backup file selected, then you can click this button to restore the FPP from your backup file with the settings selected.

# File Copy Backup

The File Copy Backup utility gives you the ability to copy every item stored on your FPP device with the exception of the operating system. This can be very useful in maintaining copies of your FPP devices in case of an unforeseen event. You can save your backups to several different locations depending on your needs.

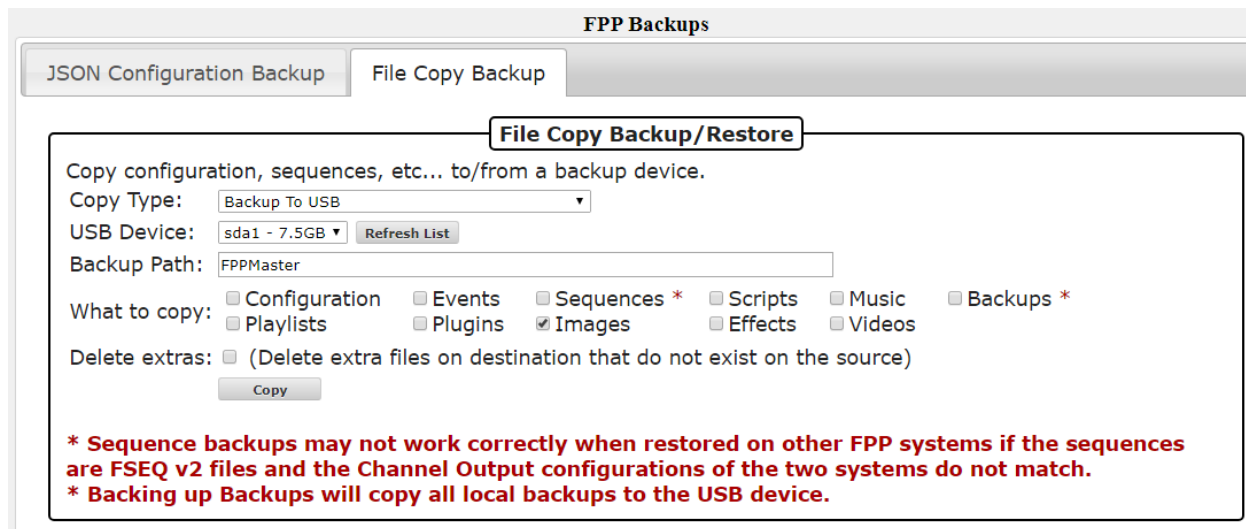

Note: if you plugged in the USB drive after the FPP device booted up, you might have to press the Refresh List button to get the current USB status.

Copy Type- Select the type of copy function that you want to perform.

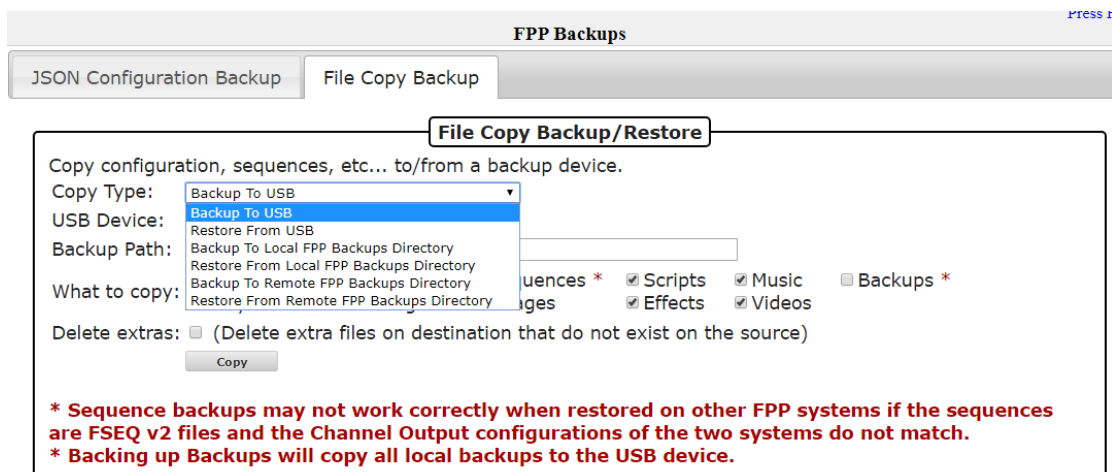

- Backup To USB- This will allow you to copy the selected items from this FPP device to the USB drive you select.
- Restore From USB- This will allow you to copy the selected items from the selected USB drive to the original locations on this FPP device.

**NOTE: This will overwrite any files currently on your FPP Device.**

- Backup to Local FPP Backups Directory- This will allow you to copy the selected items from this FPP device to a backup folder on the uSD card that is on this FPP device.
- Restore From Local FPP Backups Directory- This will allow you to copy the selected items from a backup folder on this FPP device to the original locations on this FPP device.

**NOTE: This will overwrite any files currently on your FPP Device.**

- Backup To Remote FPP Backups Directory- This will allow you to copy the selected items from this FPP device to a backup folder on a different FPP device within your show network. When you select this option, you will get an additional field to enter the Hostname or IP address of the FPP device that you want to send the Backup files.
- Restore From Remote FPP Backups Directory- This will allow you to copy the selected items from a backup folder on a remote FPP device to the original locations on this FPP device.

**NOTE: This will overwrite any files currently on your FPP Device.**

USB Device- When you choose any of the USB options, this will become available. You will select the USB drive that you want to load files to or from. If your USB drive is not visible, click on the Refresh List button.

Hostname/IP- When you choose any of the Copy to Remote or Copy From Remote options, this will become available. You will enter either the Hostname or IP address of the remote FPP device that you want to load files to or from.

Backup Path- If you select any of the Copy To options, this will populate with the Hostname of the FPP device, you can change this if you want but make sure you know which FPP the backup belongs to. If you select any of the Copy From options, this will populate with the available backup directories. If you selected the Copy From USB option and the USB does not display the correct Backup path, then click the Refresh List button.

What to copy- You can select the items that you want to copy to the backup folder selected.

Delete extras- If you select this option, the restore function will delete any existing files that are on the FPP device before restoring from the selected backup folder.

**There is no advanced warning if there is not enough space to save your backup files, but during the backup process there will be an error message similiar to this if there wasn't enough space:**

```
rsync: write failed on
"/var/tmp/ctp/nutcracker/.git/objects/pack/pack-
736c8d4bcafdd7ab17fd41db17e9159af688db24.pack": No space left on device (28)
rsync error: error in file IO (code 11) at receiver.c(393) [receiver=3.1.2]
```

**If you didn't get a complete backup, the restoration process will not be complete.**

## Email Settings

You can setup an email account in FPP to use for sending information to an email account by using a script. Due to some ISP blocking protocols, the FPP has to be setup to use a Gmail account to send the emails.

**Email Setup**

Outbound email requires a Gmail account to relay mail thru. Nothing is stored in/on your Gmail account. Gmail accounts are free by going to [Gmail.com](http://Gmail.com). By routing thru Gmail we go around when ISPs block outbound port 25 making you route email thru them.

To send email from a script:  
 1. Create your message to a temp file of your choosing  
 2. Execute the mail utility: mail -s "This is the subject line" root@localhost < tempfile.txt  
 3. If you need to attach a file also you can use the -a attachment\_file param  
 All outbound email via scripts needs to be sent to **root@localhost**.

---

Enable Email System:

Gmail Username:

Gmail Password:

Destination From Text:

Destination To Email:

Enable Email System- This box has to be checked if you want to allow FPP to send emails through the Gmail account set up.

Gmail Username-This is the username of the Gmail account you want to use to send your email. It will be your full Gmail login name, such as [john.doe@gmail.com](mailto:john.doe@gmail.com).

Gmail Password-This is the password for the Gmail account you identified.

Destination From Text-This can be used to identify the FPP that is sending the email. Usually it is the Gmail account used for the FPP emails.

Destination To Email-You need to enter the email address that you want your email messages to be sent.

Configure Email-this will save your email settings, you will be prompted to reboot.

Test Mail-You can test your configuration by using the test button.

Note: you might have to change your security settings in Gmail to allow FPP to use the Gmail account.

## Proxy Settings

The Proxy Settings allows you to route network traffic through an FPP device to a connected controller.

This is a list of ip/hostnames for which we can reach their HTTP configuration pages via proxy through this FPP instance.

For example, if this FPP instance is used as a wireless proxy to another e1.31 controller where FPP communicates to the "show network" via the WIFI adapter and to the controller via the ethernet adapter, you can put the IP address of the e1.31 controller here and access the configuration pages by proxy without having to setup complex routing tables.

Save Add Delete

#	IP/HostName	Link
1	192.168.101.2	<a href="http://192.168.101.2">192.168.101.2</a>

You can configure the FPP to act as a Proxy Host by entering the IP address of the controller(s) that are attached to the FPP device. By doing so, you do not need to enter static route(s) in either your computer or router. This is helpful for people using Mac computers where the route is not persistent. If you need to access the controller through the web UI then you can click on the link in the Proxied Hosts page or type the IP address of your FPP device that is connected to the controller followed by /proxy/ and then the address of your controller. (Not all controllers support the Proxy Host functionality. Falcon controllers (with current firmware) and KulpLights.com controllers support the Proxy Host functionality.)

Note: If you use xLights for configuration settings, then you can enter the controller's proxy settings in xLights and xLights will be able to communicate with your controller.

## Events

Events are a method to activate an effect, FPP Command or script. Examples of how to configure these are at the end of this section. Events can be triggered in 4 different ways.

- Playlist- You can trigger an event as part of a Playlist like a Lead In item. This could be useful for things like starting a radio or other device through a relay at the beginning of your show and turn them off at the end of the show.
- Sequence- You can trigger an event in the middle of a sequence. This could be useful for things like triggering a Count Down display on a Matrix panel at certain points in a sequence.



- **GPIO Input-** You can trigger an event through one of the GPIO input pins on your FPP device. This could be useful for things like having a push button play a certain sequence or start your show.
- **Manual Trigger-** you can trigger an event from the Event page. This can be useful for testing your Events.

The screenshot shows the 'Events' page in FPP. At the top, there are 'Event Control Channels' with 'Major' set to 31233 and 'Minor' set to 31234. A checkbox 'Use Raw Event ID's in Control Channels (instead of 10x Event ID):' is checked. A 'Save' button is present. Below this is a table of events:

ID	Name	Command	Arguments
1 / 1	Extend 20	Extend Schedule	"1200"
1 / 3	RunCountdown	Run Script	"RUN-COUNTDOWN-SCRIPT.sh" "" ""
1 / 7	MatrixTest	Remote Run Script	"192.168.1.104" "RUN-COUNTDOWN-SCRIPT.sh" "" ""
1 / 21	NextItem	Next Playlist Item	

Below the table are buttons for 'Add Event', 'Trigger Event', 'Edit Event', and 'Delete Event'. The 'Event Editor' section below has the following fields:

- Event ID (Major/Minor): 1 / 1
- Event Name: Extend 20
- Effect Command: Extend Schedule
- Seconds: 1200

Buttons for 'Save Event' and 'Cancel Edit' are at the bottom of the Event Editor.

**Event Control Channels-** You can trigger an event from within a sequence. In order to do so, you need to set up a “dummy” pixel in your layout to capture your trigger signals. If you are not going to trigger your event from within a sequence, then you don’t need to set these channels. The Event Control Channels are used to identify the channel number of your dummy pixel. If you are going to trigger events from within a sequence, then your dummy pixel will be a 1 pixel single line model in your layout as a placeholder to process your events. The Major Event Control Channel will be the first channel for this pixel and the Minor Event Control Channel will be the next channel. If you make changes to the Event Control Channels, make sure you click on the Save button.

**Use Raw Event ID’s-**Some sequencing programs do not reflect channel numbers from 0-255 on DMX channels internally as 0-255 so a method was developed so all sequencers worked the same. In order to do so, when you entered the Major and Minor ID number in your DMX channel for your Major and Minor ID numbers, you had to enter the ID numbers after you multiplied them by 10. xLights and most current sequencing software handles channel numbers from 0-255. You can select this option if you want to enter the event ID in your sequencing program without multiplying it by 10.

**Event List-**This will list all of the events that you have created along with the relevant details. From this section you can add an event, trigger an event, edit an existing event or delete an existing event.

**Event Editor-** This section is for editing saved Events or entering the details of a new Event that you want to setup.

The screenshot shows the 'Event Editor' form with the following fields and buttons:

- Event ID (Major/Minor): [Dropdown menu]
- Event Name: [Text input field]
- Effect Command: [Dropdown menu]
- Buttons: Save Event, Cancel Edit

- **Event ID (Major/Minor)-** The Event ID is just a way to identify each event so that you can trigger the event that you want to trigger. If you are triggering an event from a playlist, you will select the Event ID of the event that you want to trigger.

If you want to trigger an event from within a sequence then you will set the Event ID to be sent to a model in your layout.

- Event Name-Enter a name that makes sense to you as to what the event does. You might have several events that are similar so make the name clear as to what it does like StartMainPlaylist and StartOvernightPlaylist.
- Effect Command-There are several Effect Commands available and depending on the Effect Command, there will be additional options to select.
  - All Lights Off- This will turn all of the lights off;
  - Effect Start- This will start an effect that has been previously saved on the FPP device.
  - Effect Stop- This will start an effect that has been previously saved on the FPP device.
  - Extend Schedule- You can extend (or shorten) the playlist that is currently playing if it was started through your scheduler. You will enter the number of minutes that you want to change your schedule end time. Negative numbers will shorten the playlist.
  - FSEQ Effect Start- You can start any of your stored .FSEQ files. You can select it to loop so it will play until you manually stop it. You also have the option to run it in the Background (running in the background will play an effect until a playlist is played and when the playlist ends, the background effect will resume)
  - FSEQ Effect Stop- You can stop any of your stored .FSEQ files that are currently playing through an Event.
  - GPIO- You can set the state of the GPIO pins to on or off.
  - Insert Playlist After Current-You can insert a saved playlist to start after the currently playing playlist completes.
  - Next Playlist Item- This will start the next playlist item in a currently playing playlist. If you are on the last item in your playlist, it will start the first item in your playlist.
  - Prev Playlist Item- This will start the previous playlist item in a currently playing playlist. If you are on the first item in your playlist, it will start the last item in your playlist.
  - Remote Effect Start- This will start an effect that is stored on one of your remote devices. You will have to enter the effect name exactly as it is stored on the remote.
  - Remote Effect Stop- This will stop an effect that is currently playing on one of your remote devices. You will have to enter the effect name exactly as it is stored on the remote.
  - Remote FSEQ Effect Start- You can start any of your stored .FSEQ files on a remote FPP device. You can select it to loop so it will play until you manually stop it. You also have the option to run it in the Background (running in the background will play an effect until a playlist is played and when the playlist ends, the background effect will resume)
  - Remote Run Script- This will start a script that is stored on one of your remote devices. You will have to enter the script name exactly as it is stored on the remote.
  - Remote Trigger Event- This will start an event that is stored on one of your remote devices. You will have to enter the Major and Minor Event ID for the event you want to trigger.
  - Restart Playlist Item- This will restart a currently playing playlist item.
  - Run Script- This will start a script that is stored on this FPP device. You will select the script and enter any Arguments or Variables if needed

- Start Playlist- This will start a playlist that is stored on this FPP Device. You will need to select the Playlist and if you want it to repeat.
- Start Playlist at Item- This will start a playlist at a specific item in that Playlist. You will need to select the Playlist and if you want it to repeat.
- Start Playlist at Random Item- This will start a playlist at a random item in that Playlist. You will need to select the Playlist and if you want it to repeat.
- Stop Gracefully-This will stop the currently playing playlist Gracefully (complete the currently playing item and then stop)
- Stop Now--This will stop the currently playing playlist immediately
- Trigger Event- This will start an event that is stored on this FPP device. You will have to enter the Major and Minor Event ID for the event you want to trigger.
- Trigger Multiple Events- This will start up to 4 events that are stored on this FPP device. You will have to enter the Major and Minor Event ID for each event you want to trigger.
- URL- You can use URL GET or POST actions to control/communicate with your PFF Device. Enter the URL, Method and any data required.
- Volume Adjust- You can adjust the volume either up or down in steps.
- Volume Decrease- You can adjust the volume down in steps.
- Volume Increase- You can adjust the volume either up in steps.
- Volume Set. - You can set the volume to a set level from 0 to 100%.

Don't forget to save your event(s) once you are done.

The following steps will demonstrate how to create an event to get triggered from the three methods that can trigger an event.

## Creating an Event to be Triggered in a Playlist

This example is to demonstrate how you can display a countdown to Christmas (or any date that you want) by using a Playlist entry. This will assume that you have already set up the [Event Date Plugin](#) (and associated Plugins and script). But you can trigger any other Event that is properly configured.

- Go to the Events page and click on Add Event, this will open the event Editor.
- Set the Event ID to an available number. (1/3 for this example)
- Enter an Event Name that would explain what the event is doing (RunCountdown for this example.)
- Select the Run Script option for the Effect Command.
- Select the Script that you want to run (RUN-COUNTDOWN-SCRIPT.sh for this example) and save the event.

Event Editor

Event ID (Major/Minor):

Event Name:

Effect Command:

Script Name:

Script Arguments:

Environment Variables:

- Go to the Playlist section in FPP.
- Select the Playlist that you want the Event to be triggered from.
- In the New Playlist Entry select:
  - Type- Event, the window will change to allow the relevant options.
  - Event- Select the Event that you want triggered (for this example it is 01/03-RunCountdown) and click on Add.

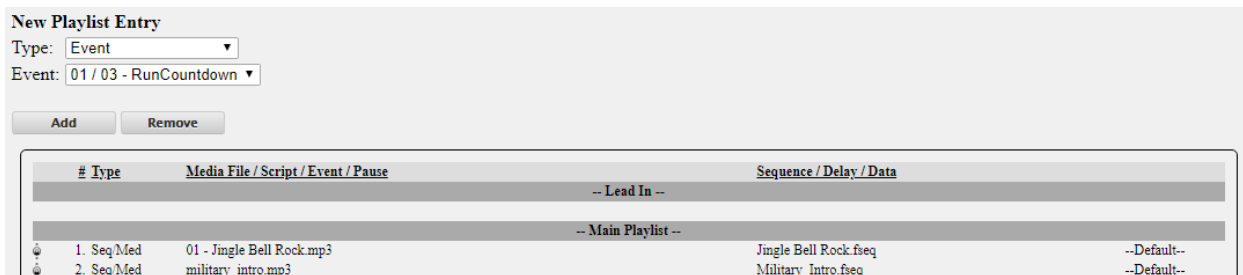

- Drag the Event to the location in the playlist that you want it to be activated.

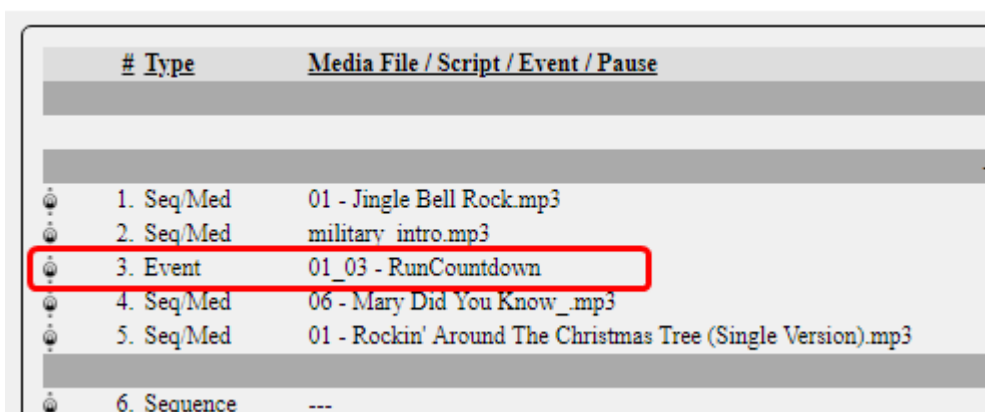

## Creating an Event to be Triggered in a Sequence.

This example is to demonstrate how you can activate a Projector from within a sequence. This will assume that you have already set up the [Projector Control Plugin](#) (and associated scripts). But you can trigger any other Event that is properly configured.

Open xLights and determine what unused channels you are going to use for triggering your event. This will vary greatly depending on how you have your layout configured. Usually you can add a DDP or E1.31 Universe to the end of the Controller that you are configuring the event for or use an unused channel in an existing DDP or E1.31 Universe.

Here is a screenshot of the Setup screen of a display in xLights.

Number	Network...	Port	Universe or Id	Num...	xLights/Vixen/FPP Mappi...	A...	Description
1	E131	192.168.101.2	100-114	512	Channels 1 to 7680	Yes	F16V3-Yard
2	E131	192.168.1.106	120-127	512	Channels 7681 to 11776	Yes	F8B Right Yard
3	E131	192.168.1.102	200-210	512	Channels 11777 to 17408	Yes	F8PB-LeftRoof
4	E131	192.168.1.103	300-301	512	Channels 17409 to 18432	Yes	F8PB-RightRoof
5	E131	192.168.1.104	400-427	512	Channels 18433 to 32768	Yes	PocketScroller
6	E131	192.168.1.105	500-505	512	Channels 32769 to 35840	Yes	F8PB Singing Elements

And we want to put the Event on the F16V3-Yard Controller. You can see that channels 1-7680 have been designated for this controller.

Here is a screenshot of the layout screen of the same display.

> Whole House			
Mega Tree	#100:1 (1)	#114:32 (7200)	WS2811:1-8
> Boscoyo Star 23 3 ring	>Mega Tree:1 (7201)	#114:302 (7470)	WS2811:9
Arches 04	#120:1 (7681)	#120:150 (7830)	WS2811:10
Arches 03	>Arches 04:1 (7831)	#120:300 (7980)	WS2811:10
Arches 02	>Arches 03:1 (7981)	#120:450 (8130)	WS2811:10
Arches 01	>Arches 02:1 (8131)	#121:88 (8280)	WS2811:10

From these screenshots you can see that the last Universe (114) on the F16V3-Yard ends on Channel 7680, but the last model on that controller, Boscoyo Star 23 3 Ring, ends on 7470 so we have 210 unused channels that are designated for the controller that are not getting used and we can use any of those to trigger the event. For simplicity sake, we will use Channels 7471 and 7472 for our Major and Minor Event Control Channels, but keep in mind that if you change models on this controller, you might have to redo your Event settings and Layout in xLights.

Open xLights and go to the Layout tab (or the method for your sequencing software) and add a Single Line model. Set the following properties:

- Name- TriggerPixel (or whatever name makes sense to you)
- # Strings- 1
- Nodes/String- 1
- Start Channel- 7471

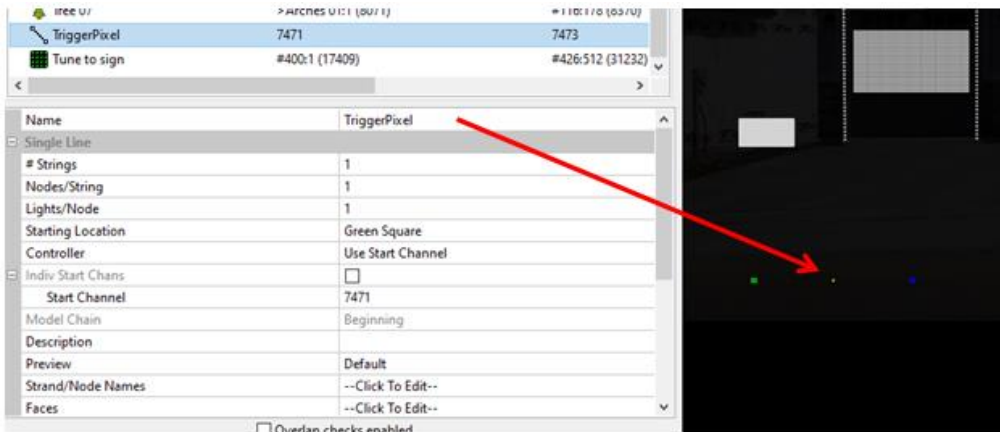

Go to your FPP Event Page and you will set the Event Control Channels, the Major channel is the first channel of your pixel that you configured in your sequencing software, for this example we are using 7471, then enter the next channel, 7472 in the Minor box. Also check the box to use Raw Event IDs. The Projector Control Plugin will create the events you need if properly configured.

ID	Name	Command	Arguments
1 / 1	PROJECTOR-PROTOCOL	Run Script	"PROJECTOR-PROTOCOL.sh" "" ""
1 / 2	PROJECTOR-ON	Run Script	"PROJECTOR-ON.sh" "" ""
1 / 3	PROJECTOR-OFF	Run Script	"PROJECTOR-OFF.sh" "" ""
1 / 4	PROJECTOR-RGB	Run Script	"PROJECTOR-RGB.sh" "" ""
1 / 5	PROJECTOR-VIDEO	Run Script	"PROJECTOR-VIDEO.sh" "" ""
1 / 6	PROJECTOR-DIGITAL	Run Script	"PROJECTOR-DIGITAL.sh" "" ""
1 / 7	PROJECTOR-IP	Run Script	"PROJECTOR-IP.sh" "" ""
1 / 8	PROJECTOR-PASSWORD	Run Script	"PROJECTOR-PASSWORD.sh" "" ""

You see that the Projector-On Event has an Event ID of 1/2 and Projector Off is 1/3.

Then go to the Sequencer tab and open the sequence that you want to create your trigger. Add a DMX Effect to your TriggerPixel (or whatever you called it) and we want to turn the Projector on at the beginning of the sequence, so we will set Channel 1 to 1 (which is the first part of the Event ID 1/2) and Channel 2 to 2 (which is the second part of the Event ID 1/2)

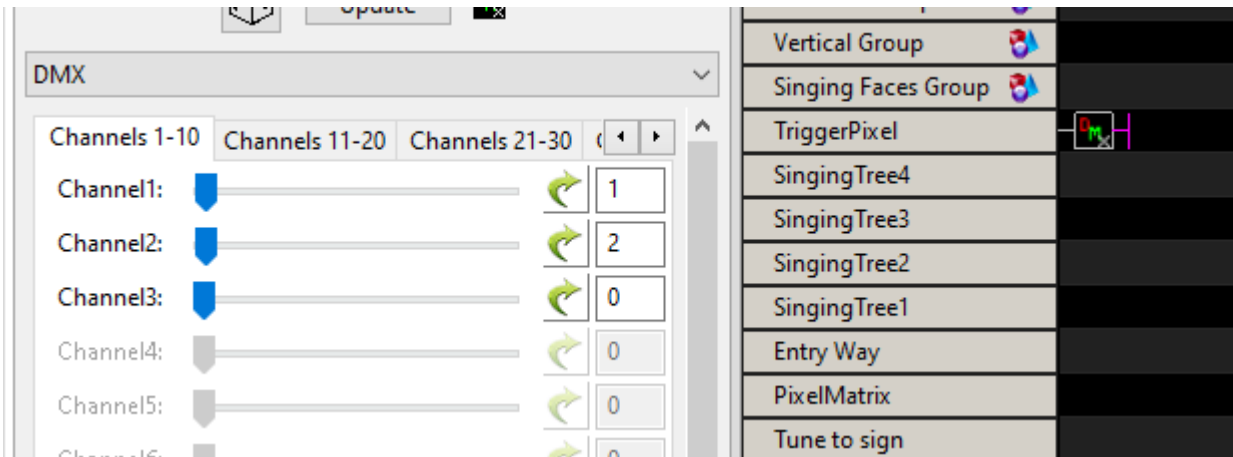

Then a little bit later in the sequence, we want to turn the projector off. The Projector Off has the Event ID of 1/3 so we will configure Channel 1 to 1 and Channel 2 to 3.

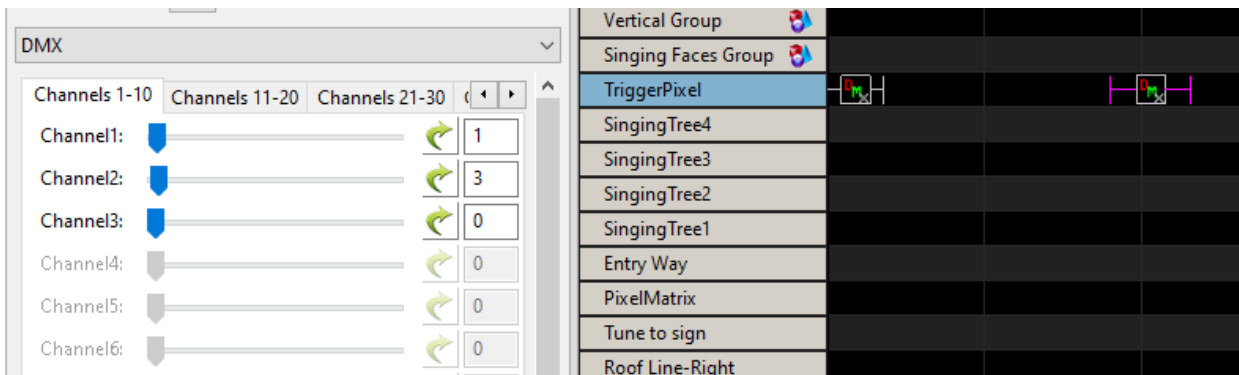

## Creating an Event to be Triggered by a GPIO Button.

This example is to demonstrate how you can start a playlist from a pushbutton connected to one of the GPIO pins. This will assume that you have already wired up the button to the GPIO pin. If you are not sure how to do this, refer to the [GPIO Button Input](#) section. But you can trigger any other Event that is properly configured.

- Go to your Events Page in FPP.
- Click on Add Event and the Event editor will open.
- Set the Event ID (this is just a number to identify the event, there is no significance in the number, just pick one of the available numbers) For this example we set the Event ID to 6/9.
- Enter an Event Name. Make the name something that reflects what the event does.
- Select "Start Playlist" from the Effect Command drop down box.
- Select the Playlist that you want to start when the button is pressed. For this example, we used the "Christmas" Playlist.
- Click on the Save Event button.

ID	Name	Command	Arguments
6 / 9	StartPlaylist	Start Playlist	"Christmas" "false"

### Event Editor

Event ID (Major/Minor):

Event Name:

Effect Command:

Playlist Name:

Repeat:

- Go to the GPIO Inputs in the Input/Output tab of FPP
- Click on the En. (enable) box next to the pin that you are using (you might have to refer to a Pinout chart to see which pins are GPIO pins). For this example, we are using gpio2\_25 (which is Header 1 Pin4)
- Select the event that you want for either the Rising or Falling trigger that you are using (this will depend on how you wire your button.) For this example, we are using the Falling Trigger and selecting the 6/9- StartPlaylist Event.
- Set the Pull Up/Down if you want to use the internal Pull up or Pull Down resistors. Select None/External if you are going to wire your button circuit with a Pull up or Pull Down resistor.
- Click on the Restart FPPD button at the top of the page.

**Settings have changed. FPPD Restart Required** -

Press F

### GPIO Input Triggers

Built-in GPIO Inputs							
En.	GPIO #	wiring #	Events		Pull Up/Down	Hdr - Pin	
<input type="checkbox"/>	gpio2_23	87	Rising: -- No Event --	Falling: -- No Event --	None/External	P1-02	
<input checked="" type="checkbox"/>	gpio2_25	89	Rising: -- No Event --	Falling: 6 / 9 - StartPlaylist	Pull Up	P1-04	
<input type="checkbox"/>	gpio0_5	5	Rising: -- No Event --	Falling: -- No Event --	None/External	P1-06	
<input type="checkbox"/>	gpio0_2	2	Rising: -- No Event --	Falling: -- No Event --	None/External	P1-08	
<input type="checkbox"/>	gpio0_3	3	Rising: -- No Event --	Falling: -- No Event --	None/External	P1-10	

## Effects

Effects or effect sequences are normally used where you want to have some components of your show run and/or turn off or in parallel with and independent of the main show sequences.

### Effects

Loop Effect:     Run in Background:

Start Channel Override:

Effects Library		Type
12 Days		FSEQ
BabyShark		FSEQ
Boise Mini expo		ESEQ
Donde esta Santa Clause		FSEQ
Feliz Navidad		FSEQ
Hallelujah_Military		FSEQ
Heroes in Blue		FSEQ
Hippo		FSEQ
Jingle Bell Rock		FSEQ
Let it Snow		FSEQ
Little Drummer Boy		FSEQ
Mary Did You Know		FSEQ
Men_In_Blue_intro		FSEQ
Military_Intro		FSEQ
Mr Grinch		FSEQ
Rockin Around The Christmas Tree		FSEQ
StaticLights		FSEQ
Text Me Merry Christmas		FSEQ
That Time of Year		FSEQ
The Greatest Show		FSEQ
santa tell me		FSEQ

#### Running Effects

ID

The Effects page is used to manually start or stop effects. You can run multiple effects on two models that have the same attributes. In order to do so, you will need to enter the channel offset from the model that the effect was created on. For example, you have two mini tree models and you created an effect on one of the trees and this tree has a start channel of 1326. To apply the same effect to another mini tree of the same size that has a start channel of 1842 you would select the effect from the Effects Library and enter 516 in the Start Channel Override and then click on the Play Effect. If the second model had a start channel that was lower than the one the effect was created on, then you would enter a negative Start Channel Override.

## Display Testing

The Display Testing screen can be used to test the channel outputs as well as to quickly test sequences without having to define playlists etc. This is a useful tool for troubleshooting!

## Channel Testing

Channel Output Testing

---

Enable Test Mode:

---

**Channel Range to Test**  
 Start Channel:  (1-8388608)    Model Name:    
 End Channel:  (1-8388608)

Update Interval:  1000ms

---

**Test Patterns:**  
 Note: RGB patterns have NO knowledge of output setups, models, etc... "R" is the first channel, "G" is the second, etc... If channels do not line up, the colors displayed on pixels may not match.

**RGB Patterns:**  
 Color Order:    
 Chase: R-G-B  
 Chase: R-G-B-All  
 Chase: R-G-B-None  
 Chase: R-G-B-All-None  
 Chase: Custom Pattern:  (6 hex digits per RGB triplet)  
 Cycle: R-G-B  
 Cycle: R-G-B-All  
 Cycle: R-G-B-None  
 Cycle: R-G-B-All-None  
 Cycle: Custom Pattern:  (6 hex digits per RGB triplet)  
 Fill:

R:  255  
 G:  255  
 B:  255

---

**Single Channel Patterns:**  
 Channel Data Value:  255  
 Chase:  
     Chase Size:   
 Fill

Enable Test mode-When this is selected, (a checkmark in the box) then the test mode is active. **Make sure you deselect this when you are done testing or you will get unexpected results.**

Channel Range to Test-This section is used to select a range of channels that you want to test. You do not need to change anything here unless you want to select specific channel ranges. You can also select testing by individual models if you have your models setup in the Pixel Overlay Models. This setting will apply to the settings selected in the other options

Update Interval-You can change how quickly the pattern changes with this slider.



## Test Patterns

There are two different test patterns you can run. You can run them by channel pattern or by RGB Pattern. The RGB Patterns is used for testing the lights. The Single Channel Pattern is used to test items like servos, relays, DMX channels, etc.

RGB Patterns-This setting will test the lights based on specified colors. The color order can be changed to match the color order of the lights you are testing.

- Chase R-G-B This pattern will set every 3 lights in a red, green, blue pattern and then shift this pattern up the string of lights.\*
- Chase R-G-B-All > This pattern will set every 4 lights in a red, green, blue, white pattern and then shift this pattern up the string of lights.\*
- Chase R-G-B-None> This pattern will set every 4 lights in a red, green, blue, off pattern and then shift this pattern up the string of lights.\*
- Chase R-G-B-All-None> This pattern will set every 5 lights in a red, green, blue, white, off pattern and then shift this pattern up the string of lights.\*
- Chase Custom Pattern-You can create a custom pattern for your chase. The numbers for the colors are the standard hexadecimal RGB color notation where there are 6 total digits and the first 2 are the intensity of red (00-FF), the second 2 are the intensity of green (00-FF), and the third set is the intensity of blue (00-FF). You can enter up to 9 colors.\*
- Cycle R-G-B > This pattern will cycle all the lights in a red, green, blue pattern.\*
- Cycle R-G-B-All > This pattern will cycle the lights in a red, green, blue, white pattern.\*
- Cycle R-G-B-None> This pattern will cycle the lights in a red, green, blue, off pattern.\*
- Cycle R-G-B-All-None> This pattern will cycle the lights in a red, green, blue, white, off pattern.\*
- Cycle Custom Pattern-You can create a custom pattern for your cycle. The numbers for the colors are the standard hexadecimal RGB color notation where there are 6 total digits and the first 2 are the intensity of red (00-FF), the second 2 are the intensity of green (00-FF), and the third set is the intensity of blue (00-FF). You can enter up to 9 colors.\*
- Fill- If you select this option, then all of the lights will be illuminated with the color selected in the sliders. There is a graphical representation of the color in the box next to the Fill option.\*



You can also click on the color indicator box to choose from a color picker tool.



Append Color to Custom Pattern- This will add the color selected by the color sliders to the Chase: Custom Pattern text box.

Single Channel Patterns-This setting will test your prop based on channel value. Test Value is the value sent. The fill option will send the Test value to all the channels. There are several Chase Sizes options.\*

When you select a Chase Size, it will send out a packet the size of the selected chase size with the first channel being the Test Value selected and the remainder of the packet channels set to 0, and then the packet will repeat.

**\*Note: The RGB Patterns do not take into account output setups so depending on your configuration the colors might not display in a true Red/Green/Blue pattern.**

## Sequence

The Sequence testing tab will allow you to test a stored sequence.

The screenshot shows a software interface with two tabs: "Channel Testing" and "Sequence". The "Sequence" tab is active. Inside the "Sequence" tab, there is a sub-tab labeled "Sequence Testing". The "Sequence Testing" sub-tab contains the following controls:

- Sequence:** A dropdown menu showing "12 Days.fseq".
- Start Time:** A text input field containing "0" with the label "(Seconds from beginning of sequence)".
- Play/Stop:** Two buttons labeled "Play" and "Stop" with the description "Play/stop the selected sequence".
- Pause/UnPause:** A button labeled "Pause/UnPause" with the description "Pause a running sequence or UnPause a paused sequence".
- Step:** A button labeled "Step" with the description "Single-step a paused sequence one frame".
- Step Back:** A button labeled "Step Back" with the description "Single-step a paused sequence backwards one frame".

Below the controls, there is a section titled "Sequence Testing Limitations:" with two numbered points:

1. This page is for testing sequences, it does not test audio or video or synchronization of a sequence with any media file. It does test Master/Remote sequence synchronization.
2. The Sequence Testing functionality currently only works when FPP is in an idle state and no playlists are playing. If a playlist starts while testing a sequence, the sequence being tested will be stopped automatically.

Select the sequence that you wish to test from the drop down list. You can specify the start time (offset) if you wish to start from any point other than the beginning of the sequence. Use the Control buttons (Play, Stop) to play through the sequence if you are using a Master/Remote configuration. If you are using the Stand Alone mode, then all of the player functions will work.

**Note:** Only the sequence data is output on the local system. Audio or video is not played. Network and channel configuration definitions must have been defined prior to Display Testing.

Ensure that Enable Test Mode on the Channel testing tab is not enabled.

# Content Setup

This section is to manage the contents that you can customize for this FPP

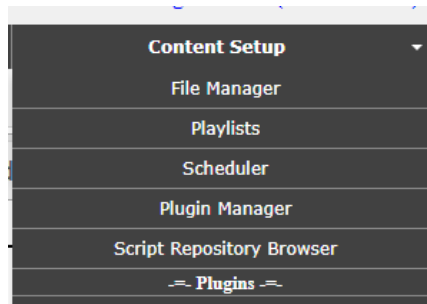

## File Manager

The file manager is where you can manage your personalized files on your FPP. From this screen, you can upload, download, and in some cases, modify the files that are on the FPP. Some of the personalized files are: sequence files, effect sequences, music files, video files, scripts, system logs and miscellaneous files.

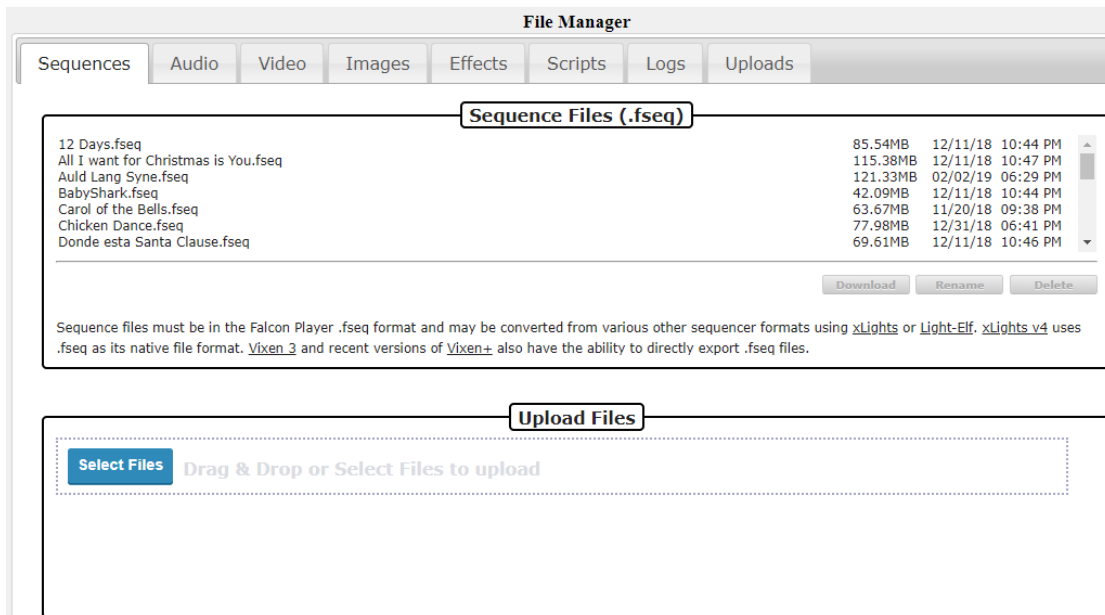

You can upload files to your FPP by dragging them from your computer's file manager onto the Upload Files section of the FPP File Manager. You have to drag it into the small box that has the dotted lines surrounding it.

The FPP will display the files in the tab that is appropriate for the file type. If you have uploaded a file that doesn't match one of the standard file types, they will be displayed in the upload tab.

Some tabs will have some additional options besides download, rename and delete.

Audio-This tab will also have the option to listen to the audio.

Video-This tab will also have the option to view the video properties such as encoding, video length, bitrate, resolution, frames per second, and various other properties.

Images- This tab will also have the option to view the file.

Scripts-This tab will have several options.

- View-You can view the script code
- Run-You can run the script code. This is helpful for testing purposes.

- Edit-You can edit the script code from within the browser.
- Copy-You can copy an existing script and save it with a different name. This is useful if you have similar scripts with different options.

Logs-This tab displays a list of several system logs that can be used for troubleshooting. You can view or download an individual log or you can select the Zip option which will bundle all of the system logs into a Zip file and download than onto your computer. (The location it is downloaded to depends on your computer's configuration but is usually in the downloads section)

Uploads-This tab will contain any files that do not fit the standard FPP formats.

## Playlists

FPP is mainly designed to play playlists, but a playlist is far more than a list of songs. The playlist is a very versatile function of the FPP. A playlist is an organized group of sequences, events, scripts, videos, etc. that are to be played in a particular order. The playlist is where you combine your sequences, videos, events etc. to create your light show. You can have several playlists so that you can have a different show for certain timeframes or days of the week or any other combination of playlists. You can even have a playlist within a playlist.

The screenshot shows the 'Playlists' tab in the FPP interface. At the top, there is a 'New Playlist' section with a text input field for 'Enter Playlist Name' and an 'Add' button. Below this is a list of existing playlists: 1. 2019Christmas, 2. 2020\_Christmas, 3. Countdown\_Test, and 4. StaticLights. A button 'Convert FPP v1.x CSV Playlists to JSON' is also present.

The 'Playlist Details' section for '2020\_Christmas' is shown below. It includes 'Save', 'Delete', 'Copy Playlist', and 'Randomize' buttons. Playlist info shows 'Total Duration: 12m:52s' and 'Total Items: 3 (In Main)'. The 'New Playlist Entry' section has a 'Type' dropdown set to 'Media and Sequence', a checked 'Auto-Select Matching Media/Sequence' option, a 'Sequence' dropdown set to '12 Days.fseq', and a 'Media' dropdown set to '01 - Feliz Navidad.mp3'. There are 'Add' and 'Remove' buttons.

Below the entry form is a table of playlist entries:

#	Type	Media File / Script / Event / Pause	Sequence / Delay / Data
-- Lead In --			
1.	Seq/Med	military_intro.mp3	Military_Intro.fseq
-- Main Playlist --			
2.	Seq/Med	01 - Jingle Bell Rock.mp3	Jingle Bell Rock.fseq
3.	Seq/Med	06 - Mary Did You Know_.mp3	Mary Did You Know.fseq
4.	Seq/Med	01 - Rockin' Around The Christmas Tree (Single Version).mp3	Rockin Around The Christmas Tree.fseq
-- Lead Out --			
5.	Sequence	---	StaticLights.fseq

At the bottom, there is a note: '(Drag entry to reposition)'.

For example, during the week, you might only want a small portion of your sequences to play and on the weekend, all of your sequences to play. Then you would create 2 playlists with the order of the sequences/events to play for each playlist.

The Playlist tab has two sections for managing your playlists.

Playlists- This section shows a list of all of your saved playlists and the option to add additional playlists to your FPP.

- If you want to edit one of your existing playlists, then you can select the playlist that you want to edit in this section and the details will populate in the Playlist Details section below.

- If you want to add a new playlist then you would type in the name of the playlist you want to create in the New Playlist textbox and then click on the Add button. The playlist will be in the Playlist Details section below so that you can add your Sequences, events, etc. to your playlist.

Playlist Details- This section is used to manage your individual playlists. The playlist that is being edited will be displayed in the textbox at the top of the Playlist Details section.

- Save-This will save the changes that you have made to your playlist
- Delete-This will delete the playlist that has been selected
- Copy Playlist-This will copy the current playlist and give you an option to create a name for the new playlist.

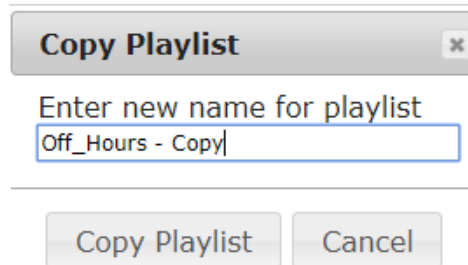

- Randomize-This will reorder the items in your Main Playlist in a random order.

New Playlist Entry-This section is used to add/edit the details of your playlist.

- Type-Select the type of playlist entry that you want to add to your playlist, there are several options.
  - Media and Sequence- This option is for playing an entry has both a .FSEQ file and associated media file (music and/or video)
  - Media Only- This option is for playing media only when there are not any lights being controlled.
  - Sequence Only- This option is for playing sequence data only when there is not any media associated with the sequence, like an animated sequence
  - Branch- This option allows you to modify the playlist while it is actually running by branching to other areas of the playlist depending on certain test criteria. This can be used for things like reducing the volume of your output depending on the time of day.
  - Channel Remap- This option will remap channels to another channel range. This is helpful if you move a prop(s) to a different port on a controller and you can't rebuild the sequence.
  - Dynamic- This entry is for playlist items that are created from an outside script/plugin or process and allows for items to be played "on the fly".
  - Event- You can trigger an event from within a sequence. This could be used for things like starting a fan for a blow up prop or any other predefined event.
  - FPP Command- You can select one of the available FPP commands as a playlist item.
    - All Lights Off- This will turn all of the lights off;
    - Effect Start- This will start an effect that has been previously saved on the FPP device.
    - Effect Stop- This will start an effect that has been previously saved on the FPP device.
    - Extend Schedule- You can extend (or shorten) the playlist that is currently playing if it was started through your scheduler. Negative numbers will shorten the playlist.

- FSEQ Effect Start- You can start any of your stored .FSEQ files. You can select it to loop so it will play until you manually stop it. You also have the option to run it in the Background (running in the background will play an effect until a playlist is played and when the playlist ends, the background effect will resume)
- FSEQ Effect Stop- You can stop any of your stored .FSEQ files that are currently playing through an Event.
- GPIO- You can set the state of the GPIO pins to on or off.
- Insert Playlist After Current-You can insert a saved playlist to start after the currently playing playlist completes.
- Next Playlist Item- This will start the next playlist item in a currently playing playlist. If you are on the last item in your playlist, it will start the first item in your playlist.
- Prev Playlist Item- This will start the previous playlist item in a currently playing playlist. If you are on the first item in your playlist, it will start the last item in your playlist.
- Remote Effect Start- This will start an effect that is stored on one of your remote devices. You will have to enter the effect name exactly as it is stored on the remote.
- Remote Effect Stop- This will stop an effect that is currently playing on one of your remote devices. You will have to enter the effect name exactly as it is stored on the remote.
- Remote FSEQ Effect Start- You can start any of your stored .FSEQ files on a remote FPP device. You can select it to loop so it will play until you manually stop it. You also have the option to run it in the Background (running in the background will play an effect until a playlist is played and when the playlist ends, the background effect will resume)
- Remote Run Script- This will start a script that is stored on one of your remote devices. You will have to enter the script name exactly as it is stored on the remote.
- Remote Trigger Event- This will start an event that is stored on one of your remote devices. You will have to enter the Major and Minor Event ID for the event you want to trigger.
- Restart Playlist Item- This will restart a currently playing playlist item.
- Run Script- This will start a script that is stored on this FPP device. You will select the script and enter any Arguments or Variables if needed
- Start Playlist- This will start a playlist that is stored on this FPP Device. You will need to select the Playlist and if you want it to repeat.
- Start Playlist at Item- This will start a playlist at a specific item in that Playlist. You will need to select the Playlist and if you want it to repeat.
- Start Playlist at Random Item- This will start a playlist at a random item in that Playlist. You will need to select the Playlist and if you want it to repeat.
- Stop Gracefully-This will stop the currently playing playlist Gracefully (complete the currently playing item and then stop)
- Stop Now--This will stop the currently playing playlist immediately
- Trigger Event- This will start an event that is stored on this FPP device. You will have to enter the Major and Minor Event ID for the event you want to trigger.
- Trigger Multiple Events- This will start up to 4 events that are stored on this FPP device. You will have to enter the Major and Minor Event ID for each event you want to trigger.
- URL- You can use URL GET or POST actions to control/communicate with your PFF Device. Enter the URL, Method and any data required.

- Volume Adjust- You can adjust the volume either up or down in steps.
- Volume Decrease- You can adjust the volume down in steps.
- Volume Increase- You can adjust the volume either up in steps.
- Volume Set. - You can set the volume to a set level from 0 to 100%.
- Images- You can select the image folder to display your images on a device that has been configured. You will select the transition type that you want in between images. In the Playlist, you will need to put a pause after the Image item for how long you want the image to display before it transitions to the next one.
- MQTT-You can send and receive a few limited home automation commands from FPP to integrate FPP with your home automation system.
- Pause-You can add a pause to your playlist. This can sometimes be useful if you have other actions going on that you want to pause the sequences being played.
- Playlist-You can embed a playlist within a playlist. One example, you have three different shows you play during the week, but each show has a Lead In playlist of a few songs. You could put the Lead In songs in one playlist and then for the Lead In on each of your three daily playlists, you could just enter the one Lead In playlist instead of recreating the Lead In songs in each playlist.
- Plugin-There are several plugins that are available that you can include in your playlist. (see the [Plugin Manager](#) section for more detail)
- Volume-You can adjust the volume from within the playlist. This can also be used with the Branch item and adjust the volume depending on the time of day.
- Script-You can run a script from within the playlist, there are several pre-written scripts available or you could write your own. (see the [Script Repository Browser](#) section for more detail)
- URL-This entry will allow you to send URL commands to outside programs or processes. This can be used for things like turning on/off smart power strips or if you have a website, you could send what song is currently playing.

## Scheduler

The Scheduler page is where you can setup predefined playlists to play on a preset schedule. You must have previously created a playlist in order to schedule one.

Note: For the schedule to start on the correct time, you must have your time settings configured properly. (refer to the [Config/Set Time](#) page in the Status/Control section of FPP.)

#	Enable	Start Date	End Date	Playlist	Day(s)	Start Time	End Time	Repeat	Stop Type
1	<input checked="" type="checkbox"/>	2019-01-01	2020-01-13	2019Christmas	Everyday	09:23:00	11:00:00	<input checked="" type="checkbox"/>	Graceful
2	<input type="checkbox"/>	2019-01-01	2020-01-01	2019Christmas	Everyday	09:01:00	09:10:00	<input checked="" type="checkbox"/>	Hard Stop
3	<input type="checkbox"/>	2019-01-01	2099-12-31	StaticLights	Everyday	22:01:00	01:00:00	<input checked="" type="checkbox"/>	Graceful
4	<input type="checkbox"/>	2020-01-21	2099-12-31	StaticLights	Everyday	23:45:00	02:00:00	<input checked="" type="checkbox"/>	Graceful

You can have multiple playlist for different days of the week or even different holidays. If you have a playlist that is scheduled to play while another one is playing, the one with the highest priority will play. The Playlist at the top of the list has a higher priority than the one below it. You can drag a playlist in this screen to reorder it.

The Save button must be clicked after any additions/modifications in order for them to be saved.

The Delete button will temporarily delete the selected schedule; to make it permanent, click on the Save button after it is deleted.

The Reload button will reload the saved Schedule, so if you make changes but have not saved them, this will load what is currently saved to take you back to the beginning.

To create a schedule, click on the Add button and then fill in the items pertaining to the playlist (to edit an existing playlist, just modify the sections as needed)

Enabled-This will allow you to select whether you want the playlist to be active or not. You might have playlists that you want to manually change that are scheduled for the same time frame and you can select which one is enabled.

Start Date-This is the date that you want the chosen playlist to start playing. This can be a date way in the past and the playlist will play when the next start Time/Day is reached. If you configured your Locale in the [FPP Settings](#) selection, you can select holidays by name instead of entering the dates manually.

End Date-This is the last day that you want to playlist to play. It can be far into the future if you desire. The playlist will stop playing after the selected end date. If you configured your Locale in the [FPP Settings](#) selection, you can select holidays by name instead of entering the dates manually.

Playlist-This is the playlist that you want to play during the selected timeframe.

Days(s)-You can select any combination of days for your playlist to play. Several of the more common day combinations are listed in the drop down. If the combination you want is not listed, then select the Day Mask and place a check next to the days that you want the playlist to play.

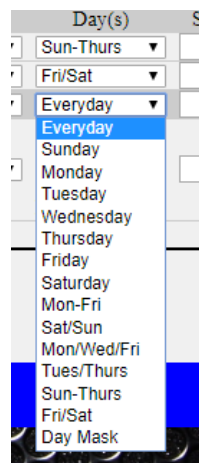

Start Time-This is the time that you want your playlist to begin. The time has to be entered in the 24 hour format. When you click on the Start Time box, there will be listed start times for every half hour. You do not need to select one of those times; you can enter any time that you want. There is also a Sunrise and Sunset option that you can select which will adjust the start time to coordinate with your local Sunrise/Sunset time. In order for this to work properly, you will need to have your Time configurations set up correctly to include your Latitude and Longitude coordinates (see the [Config/Set Time](#) section.)



End Time-This is the time that you want your playlist to end. If there is a sequence playing when it reaches this time, the sequence will end according to the Stop Type you have selected. The time has to be entered in the 24 hour format. When you click on the End Time box, there will be listed end times for every half hour. You do not need to select one of those times; you can enter any time that you want. There is also a Sunrise and Sunset option that you can select which will adjust the end time to coordinate with your local Sunrise/Sunset time. In order for this to work properly, you will need to have your Time configurations set up correctly to include your Latitude and Longitude coordinates (see the [Config/Set Time](#) section.) If your schedule is to go beyond midnight, select the end time that you want your schedule to end. FPP will understand that the end time is actually on the next day and stop accordingly.

Repeat-If this box is selected, then the playlist will continue from the beginning when it is finished and keep repeating the playlist until the scheduled end date/time is reached. If it is not selected, then the playlist will only play once. This also needs to be checked if there is a possibility that a previously scheduled playlist might still be playing when this playlist is scheduled to start (like in a Graceful Stop situation.)

Stop Type- There are three Stop Types that you can select from.

- Graceful- This will play the song that is currently playing and then stop, if you have a Lead Out section, that will also play so it is possible that your schedule will not end on the exact time selected.
- Graceful Loop- This will complete the current playlist (including Lead Out section) and then stop.
- Hard Stop- This will end the playlist at the time scheduled. If a song is playing, it will stop in the middle of the song.

**Note: If a playlist does not have the Repeat option selected**

- It will only start if there is no other sequence playing at the scheduled start time.
- It will play all of the sequences in the list and then stop. If the schedule for this playlist ends before all of the sequences have played, then when the end time is reached, the currently playing sequence in the list will complete and then stop playing. The rest of the items in the playlist will not get played. It is probable that the playlist will not end exactly on the scheduled end time.

**Note: If a playlist does have the Repeat option selected**

- Then it will start at the scheduled start time if there is no other sequence currently playing, or start when the currently playing sequence ends as long as it is within the scheduled timeframe.
- It will play all of the sequences in the list and then start over at the beginning and continue until the end time of the schedule has been reached. When the end time is reached, the currently playing sequence in the list will complete and then stop playing. It is probable that the playlist will not end exactly on the scheduled end time.

Updating a Playlist/Schedule- If you update a Playlist/Schedule during a time period that it was scheduled to play then there are a few things to consider.

- If you upload new sequences and add them to a playlist that is currently playing, they will not play in the current cycle and if the Playlist is scheduled to repeat, it will play in the next cycle.
- If you updated existing sequences or events that are already in a playlist, then the updated sequences/events will be played the next time that particular sequence or event is played.

Repeating Schedules- You can create a schedule in FPP that is a continuously repeating schedule based on a certain criteria that will span every month or every year. This is helpful for people that use FPP for more than holiday lighting or more specialized schedules (like landscape or other type of lighting). FPP will ignore any specific field comparisons if there is a 0 entry in a particular field, i.e. 00 for Month and 0000 for year.

For example, here are a couple schedules:

Start Date	End Date	Result
0000-02-14	0000-02-14	Plays every February 14th (Valentine's Day)
0000-00-01	0000-00-07	Plays the first week of every month

You can also have a 24 hour schedule by entering a date in the Past and a date way in the future and set the start time to be 00:00:00 and end time of 24:00:00.

## Script Repository Browser

Scripts are small program codes to perform specific functions that have a wide range of functionality. There are several scripts available from FPP or you could write your own.

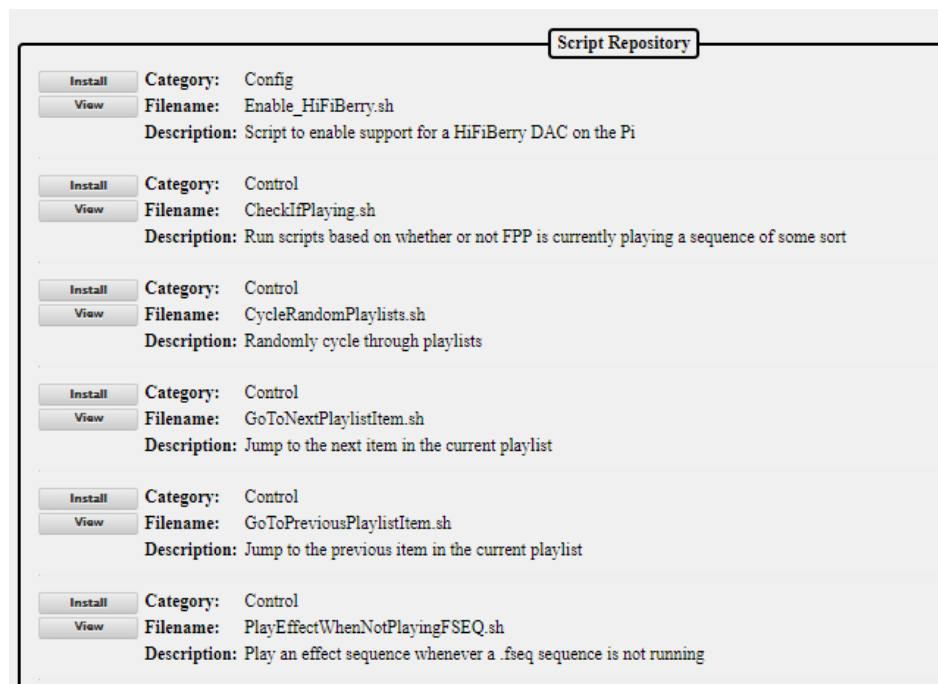

The Script Repository lists the scripts by category based on the functionality of the script. Scripts can be used as a part of a playlist or as part of a plugin. You can install the script or view the actual script code from this screen. Once the script is installed, it can be managed from the File Manager section of the FPP. You may be required to edit some scripts to make them functional. For example, the Remote Control example scripts need to be modified to include the IP address of the remote FPP instance that you wish to control.

## Plugin Manager

Plugins are additional components that have been developed by the developers or individuals to provide functionality that can then be used from within the FPP. You can develop your own Plugin or install a Plugin from a third party if you wish. These are used to perform more complex operations than scripts.

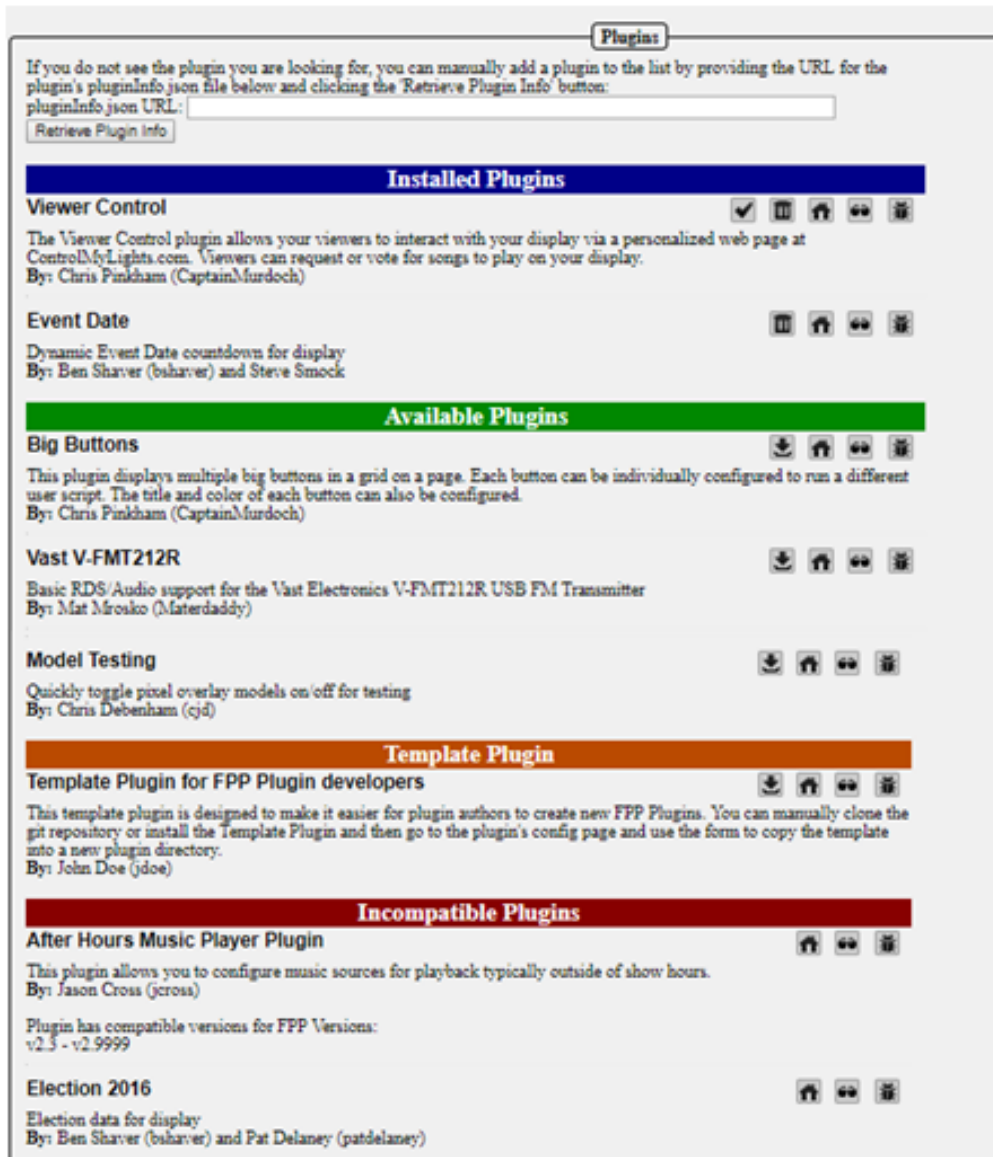

The Plugin page has 5 sections in order to ease navigation.

## Retrieve Plugin Info

This section is where you can enter the URL for a Plugin that has not been incorporated into the official release of FPP and FPP will download the relevant information from the plugin. The URL needs to point to the location that the pluginInfo.json file for the plugin is located. If there isn't a valid pluginInfo.json file, the plugin will not be installed.

If you do not see the plugin you are looking for, you can manually add a plugin to the list by providing the URL for the plugin's pluginInfo.json file below and clicking the 'Retrieve Plugin Info' button:

pluginInfo.json URL:

Retrieve Plugin Info

## Installed Plugins

This section contains plugins that have been installed and next to the plugin there are several options.





is used to check for updates to the selected plugin.



is used to delete the selected plugin.



is used to go to the home page for the plugin and can be useful for installation information.



is used to view the source code page for the plugin.



is used to go to the bug reporting page for the plugin.

## Available Plugins

This section contains plugins that are directly available through the FPP interface but haven't been installed. To install the plugin, click on the install icon.



Note: Most plugins will require some sort of configuration or setup before they will operate correctly. The plugin author will determine which menu heading the plugin should fall under. The plugin's configuration and other relevant pages will be located at the bottom of the menu dropdown. There might be more than one plugin page for the plugin.

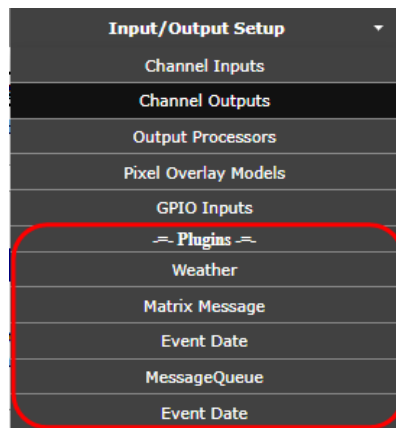

Refer to the plugin's home page or help page for more information on the configuration and usage of the plugin. Some of the more common plugins have setup instructions in the [Common Plugins](#) section of this manual.

## Template Plugin

This section is to assist plugin authors in creating a plugin for FPP and the structure required for a FPP Plugin. See the [Plugin Development](#) section in the Advanced Settings section for more details on creating a Plugin.

## Incompatible Plugins

This section will list available plugins that have compatibility issues with the installed version of FPP. You can go to the developer's website and view the code and possibly fix the code to make it work for your application.

# Input/Output Setup

The Input/Output section is used to primarily define the channel/universe configurations of the controller connected to the FPP. It is also used to configure the GPIO pins for input triggers or to trigger output signals as well.

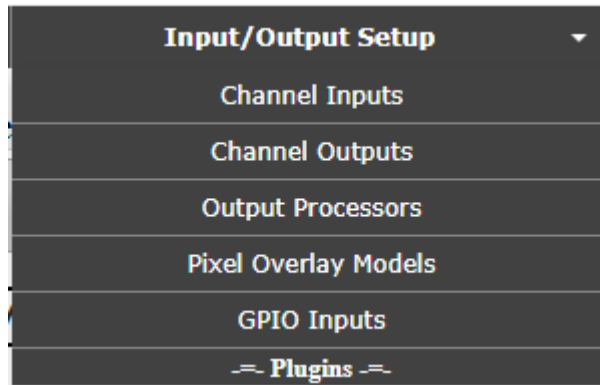

## Channel Inputs

The Channel Inputs section is to identify the E1.31 Universes that this instance of FPP is going to be receiving in Bridge Mode (do not enter E1.31 Universes that other FPPs are using.)

Bridge Mode is where the FPP will accept the E1.31 data coming in and pass it through the selected network port to a controller or other E1.31 device. If you have events or other output processes that are triggered by channel data, they will be processed.

**Note: If you are using xLights and your FPP device is connected to a Hat/Cape type controller, you can export the E1.31 Bridge configuration into your FPP by using the Upload to Controller Function in the xLights setup section.**

E1.31/ArtNet Bridge

E1.31/ArtNet Bridge Mode Universes

Inputs Count:

Line #	Active	Description	FPP Channel		Universe			
			Start	End	#	Count	Size	Type
1	<input checked="" type="checkbox"/>	F16V3 Yard	1	7680	1	15	512	E1.31 - Unicast

(Drag entry to reposition)

**(Note: if you are using DDP, then you do not need to setup E1.31 Bridge Mode Universes. FPP will automatically receive and recognize DDP packets with no configuration needed)**

Line #- This is just a reference for the line.

Active- You can make the Universes defined on a line active by selecting this box, if you don't want it active, remove the checkmark.

Description- Enter a description to help you identify the controller that these Universes are assigned.

FPP Channel (Start)- Enter the Start Channel that you want these Universes to start, if this is the only controller in your network, then it is typically 1 but if you have more than one controller, you will have to determine what the start channel should be. This can usually be determined from your xLights Setup screen.

FPP Channel (End)- This will be calculated based on the information entered.

Universe (#)- This is the first Universe number that you are assigning. It can be any number and doesn't need to begin at 1.

Universe (Count)- Enter the number of Universes you are going to assign to this FPP device. You can define several Universes on one line (it is the recommended method) Universes do not have a direct correlation to ports, it is recommended to define Universes based on controllers. In the screenshot above, there are 15 Universes of 512 channels defined (1-15).

Universe (Size)- Enter the number of channels that you want each Universe to have. The common Universe size is either 512 or 510 channels and they both work equally well. Just make sure that you use the same Universe numbers and sizes in all areas related to this FPP device (xLights, etc.)

Universe (Type)- There are 3 Universe types.

- E1.31-Unicast- This is the recommended method.
- E1.31-Multicast- This method is for older controllers that don't perform well under Unicast.
- ArtNet- This is for ArtNet type controllers (fairly rare these days.)

E1.31 Bridge mode is useful if you want to control your lights/props directly from xLights, xSchedule or other software and is useful in testing from xLights as well. If you are not going to use Bridge Mode, then you don't need to setup any Universes in the Input page but it could be helpful in testing.

Your E1.31 Bridge Universes/FPP Start channels/Universe size needs to match what you setup in your show player (e.g. xLights/xSchedule) and the controller. If you need additional information on Universes, refer to the Resources section about [Universes and Channels](#).

**Important! If you change the FPP Start Channel numbers, Universe #, Universe Count or Universe size after you have configured your Universes, make sure that you adjust any of the other Universe Lines because FPP will not "auto correct" your Universe #s or FPP Start Channel numbers.**

## Adding E1.31 Bridge Mode Input

The screenshot shows a software interface for configuring E1.31/ArtNet Bridge Mode Universes. At the top, there is a header bar labeled "E1.31/ArtNet Bridge". Below it, a sub-header reads "E1.31/ArtNet Bridge Mode Universes". The main configuration area contains an "Inputs Count:" label followed by a text input field containing the number "1" and a "Set" button. Below this are three buttons: "Save", "Clone", and "Delete". At the bottom of the configuration area, there is a small instruction: "(Drag entry to reposition)".

If you choose to enter E1.31 Universes manually, you would normally enter 1 for the Inputs count and click on Set. Then enter all of the relevant information in the fields that get displayed.

The Clone button will copy the settings of the selected Line # (Universe #, Universe Count, Universe Size and Universe Type) to the lines below. FPP will then ask how many Universe lines you want to clone. This is not normally needed with the ability to define several Universes on one line.

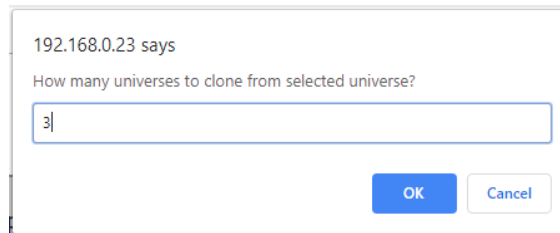

192.168.0.23 says  
How many universes to clone from selected universe?  
3  
OK Cancel

When you click OK, FPP will paste the settings into the number of Universe lines that you entered below the selected Universe line and increment the Universe # on each cloned line.

Note: You have to enter a valid number of Universes to clone. If you select more Universes to clone than there are Universe lines below the selected Universe, then the clone process will not be completed.

You can also delete a Universe line by selecting it and clicking on the Delete button.

**Important! You have to click on the Save button after you make any changes in order for them to be saved. After you save the configuration, you will get a message at the top of your screen indicating that you have to restart FPP for the change to take effect.**



## Channel Outputs

The Channel Outputs page is where you configure FPP to output the channel data it receives to the various controllers/hats/capes that are connected to the FPP. There are several types of output configurations and you will have to configure the output that is appropriate for your application. Depending on the SBC (Pi or BeagleBone) that you have connected, the Channel Output tabs will be different.

### Pi Channel Outputs

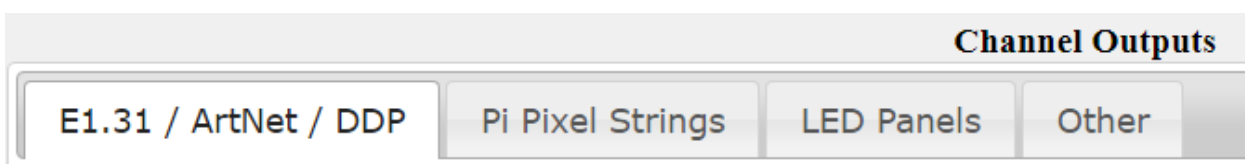

## BeagleBone Channel Outputs

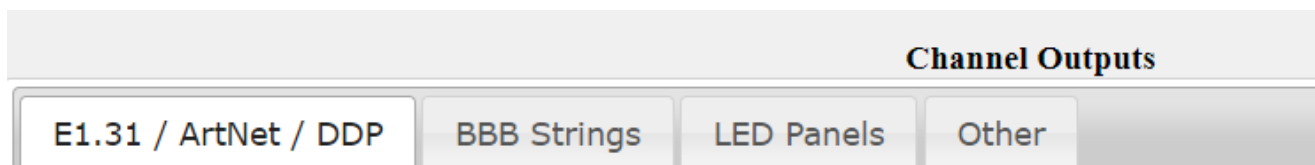

You will need to setup your channel outputs to match the controller that is connected to your FPP device.

Here are the Channel output types and typical usage.

- E1.31/ ArtNet/ DDP- Any device that receives E1.31 data (like Falcon Controllers, Advatek PixLite controllers, and SanDevices controllers) and output the signal to the pixels. This is also where you would setup Channel output for devices that receive ArtNet or DDP data. (There are not many ArtNet devices and DDP is a newer technology.) DDP is the preferred protocol if you have a controller that supports DDP (e.g. KulpLights.com controllers)
- Falcon Pixelnet/DMX- Lynx and older Falcon Controllers used the Pixelnet protocol. This is where you will also setup your connections to any DMX controllers you might be using.
- Pi Pixel Strings- There is a Pi Hat for the Raspberry Pis with 2 string ports.
- LED Panels- This is for setting up P10/P5 panels that are connected to either a BB OctoScroller type controller or a Pi Matrix hat type controller.
- BBB Strings- There are several capes that you can add to the BeagleBone series SBC to control up to 40 strings of pixels.
- Other-There are several other output types that are not commonly used but available, such as DMX Pro, LOR, Renard, Triks-C to name a few.

### E1.31/ ArtNet/ DDP

Your E1.31 Universes/FPP Start channels/Universe size needs to match what you setup in your show sequencer (e.g. xLights) and the controller. If you need additional information on Universes, refer to the Resources section about [Universes and Channels](#)

You only need to Enable and Configure E1.31/Artnet/DDP outputs if you need this FPP device to send out E1.31 data through one of its interfaces. If you have an attached Cape/Hat or running in a Master/Remote mode, you do not need to Enable/Create E1.31 outputs

If you are using xLights, you can export the E1.31 Channel Output settings into your FPP by using the FPP Connect feature in the Tools section of xLights by selecting the UDP option.

**Warning: If you are not going to use FPP to send E1.31 data and select the UDP option in FPP Connect, FPP Connect will configure AND ACTIVATE your E1.31 outputs this could cause lagging and unexpected results if you don't need to output E1.31 data.**



## E1.31 / ArtNet / DDP

Enable E1.31 / ArtNet / DDP Output: Source Interface: Outputs Count:    

Line #	Active	Description	FPP Channel		Universe				Unicast Address	Priority	Monitor	DeDup	Ping
			Start	End	#	Count	Size	Type					
1	<input checked="" type="checkbox"/>	F16V3 Front Yard	1	6144	100	12	512	DDP Raw Channel	192.168.0.10	0	<input checked="" type="checkbox"/>	<input checked="" type="checkbox"/>	Ping
2	<input checked="" type="checkbox"/>	F8PB Yard props	6145	11776	200	11	512	E1.31 - Unicast	192.168.0.10	0	<input checked="" type="checkbox"/>	<input type="checkbox"/>	Ping
3	<input checked="" type="checkbox"/>	F48 House	11777	15872	300	8	512	E1.31 - Unicast	192.168.0.10	0	<input checked="" type="checkbox"/>	<input type="checkbox"/>	Ping
4	<input checked="" type="checkbox"/>	PocketScroller	15873	29696	401	27	512	E1.31 - Unicast	192.168.0.10	0	<input checked="" type="checkbox"/>	<input type="checkbox"/>	Ping

(Drag entry to reposition)

- Enable E1.31/Artnet/DDP output- If you need your FPP to output this type of data, then make sure you check the box to enable E1.31/Artnet/DDP output.
- Source Interface- Select the interface that you want the data to be sent out.
- Outputs Count- You can enter a Count here. This will set the number of lines to the number you selected.
- Line #- This is used to Identify each line of Universe(s) saved on your FPP. You can set multiple universes on each line if you want.
- Active- A Universe line can be Active or not. If it is not active, then data will not be transmitted to all the universe(s) on that Line #.
- Description-This can be used to provide information on how each Universe Line # is assigned. This is usually one line per controller.
- FPP Start Channel-This normally reflects the Absolute Channel that is reflected in your Sequencing Program (xLights, Vixen, etc.)
- Universe #- This shows the starting universe number for the Universe Line #.
- Universe Count-This will indicate how many Universes are defined for that line. You can define multiple Universes on a line and is the recommended method.
- Universe Size- This is how many channels the Universe is designated. All Universes on that line will have the same number of channels. It is more common to use either 512 or 510 you need to make sure you use the same numbering system for all devices in your network.
- Universe Type- Is used to identify how the Universe Data is going to be transmitted. This is normally DDP, Multicast or Unicast with DDP being the recommended method, but for specialty configurations it can be set for Artnet.
- Unicast Address- If you are using Unicast, then the IP address of the device you are sending the data to needs to have it entered in this box.
- Priority- You can select a priority for the E1.31 packages. If a device receives E1.31 data from 2 sources, then the device will use the one with the highest priority. This is only valid for controllers that support the E1.31 priority function and not very common.
- Monitor- If you select this option, FPP will monitor the device that is receiving the E1.31 data and if it becomes unavailable it will stop sending the data until the device starts to respond again.
- DeDup- By selecting this option, FPP will use an algorithm for sending data packages and if a package is a duplicate of the previously sent package, it will not send it out. This could reduce the bandwidth used on your network.
- Ping- You can click this button to verify that your network configurations are set correctly

**Important! If you change the FPP Start Channel numbers, Universe #, Universe Count or Universe size after you have configured your Universes, make sure that you adjust any of the other Universe Lines because FPP will not “auto correct” your Universe #s or FPP Start Channel numbers.**

## Adding E1.31 Output Channels

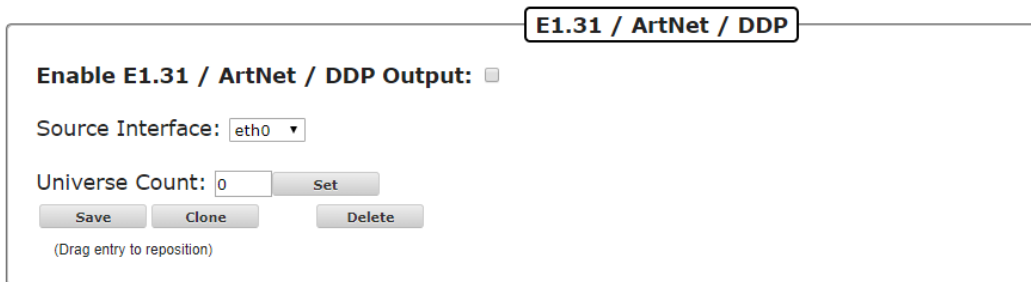

The screenshot shows a configuration window titled "E1.31 / ArtNet / DDP". It contains the following elements: a checkbox for "Enable E1.31 / ArtNet / DDP Output:" which is currently unchecked; a "Source Interface:" dropdown menu set to "eth0"; a "Universe Count:" input field with the value "0" and a "Set" button; and three buttons: "Save", "Clone", and "Delete". Below these buttons is the text "(Drag entry to reposition)".

The Source Interface specifies which network interface the FPP is going to output the channel data to the controller. This is most commonly done through the eth0.

If you choose to enter E1.31 Universes manually, you would normally enter 1 for the Outputs count and click on Set. Then enter all of the relevant information in the fields that get displayed.

The Clone button will copy the settings of the selected Line # (Universe #, Universe Count, Universe Size and Universe Type) to the lines below. FPP will then ask how many Universe lines you want to clone. This is not normally needed with the ability to define several Universes on one line.

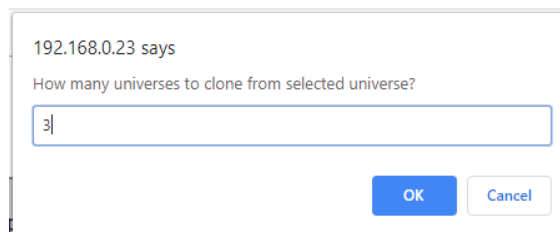

The dialog box shows a message from "192.168.0.23" asking "How many universes to clone from selected universe?". There is an input field containing the number "3". At the bottom right are "OK" and "Cancel" buttons.

When you click OK, FPP will paste the settings into the number of Universe lines that you entered below the selected Universe line and increment the Universe # on each cloned line.

Note: You have to enter a valid number of Universes to clone. If you select more Universes to clone than there are Universe lines below the selected Universe, then the clone process will not be completed.

You can also delete a Universe line by selecting it and clicking on the Delete button.

**Important! You have to click on the Save button after you make any changes in order for them to be saved. After you save the configuration, you will get a message at the top of your screen indicating that you have to restart FPP for the change to take effect.**



# Pi Pixel Strings

**Channel Outputs**

E1.31 / ArtNet / DDP
Falcon Pixelnet/DMX
Pi Pixel Strings
LED Panels
Other

**New Type:** RPIWS281X Add Output

Clone String
Save
Revert
Press F2 to auto set the start channel on the next row.

---

Output Enabled:

**RPIWS281X Output**

Port	Protocol	Description	Start Channel	Pixel Count	Group Count	End Channel	Direction	Color Order	Null Nodes	Zig Zag	Brightness	Gamma
1)	WS281X		1	1200	1	3600	Forward	RGB	0	0	100%	1.0
2)	WS281X		1	0	1	0	Forward	RGB	0	0	100%	1.0

If you are using a PiHat type of controller, you will setup your channel outputs here.

- **New Type-** Select the type of pixels that you are going to be connecting to your Pi. You can choose between RPIWS281X or spixels. RPIWS281X is used for most pixels such as WS2811, WS2812, etc. protocol.
- **Add Output-** Selecting this will allow you to add spixel type strings to your Pi hat. Spixels can drive 16 independent strings of APA102, LPD6803, or LPD8806 pixels directly off the Raspberry Pi's GPIO ports by emulating SPI outputs in software. The data and ground lines attach directly to the Pi while power for the pixels is injected from another source.
- **Clone String-** Selecting this will copy the settings of the selected string to the number of strings selected below. It will update the Start Channel to follow after the previous string.
- **Save-** Selecting this will save your configuration.
- **Revert-** Selecting this will revert the screen to the currently saved configuration
- **Output Enabled-** Check this box to enable the Pi Pixel String output.
- **Port-** Indicates the number of the output port on the hat.
- **Protocol-** Indicates the protocol for the pixels attached to the port of the hat.
- **Description-** You can enter a description for the pixels attached to the port.
- **Start Channel-** Enter the start channel that corresponds to the start channel in your sequencing software (xLights, Vixen, etc.)
- **Pixel Count-** Enter the number of pixels connected to that port of the hat.
- **Group Count-** If you have groups of pixels that are going to be illuminated exactly the same all of the time, you can put them in groups.
- **End Channel-** This indicates the ending channel for the string.
- **Direction-** Selecting reverse will reverse the data sent to the pixels so that it will act like the data is coming in from the end of the string.
- **Color Order-** You can select a color order to match the color order for the pixels you are using.
- **Null Nodes-** If you are using Null Nodes in the beginning of your string to help boost the transmission distance, then enter the number of Null Nodes you have in the string.
- **Zig Zag-** This setting is useful for items like a Mega Tree where one string is used for more than one strand of the tree. This is more commonly setup in the sequencing software (xLights, Vixen, etc.) Enter the number of times the string changes direction. **Do not use Zig Zag if you used the Strands/String setting in your sequencing software.**
- **Brightness-** You can set the brightness for your pixel string. Many dense props are very bright and a lower brightness might look better. This also reduces the power required to light the pixels.

- Gamma- This is a correction factor that can be entered due to the way that our eyes perceive colors in the dark. It can also be used to correct color variations on pixel strings from different vendors.

## BBB Strings

The BeagleBone series of SBCs has several capes and configurations and is very versatile. There are several capes available from <http://kulplights.com>.

BeagleBone String Capes

Enable BBB String Cape:

Cape Type:

Press F2 to auto set the start channel on the next row.

Port	Description	Start Channel	Pixel Count	Group Count	End Channel	Direction	Color Order	Null Nodes	Zig Zag	Brightness	Gamma
1) ●		1	0	0	0	Forward ▼	RGB ▼	0	0	100% ▼	1.0
2) ●		1	0	1	0	Forward ▼	RGB ▼	0	0	100% ▼	1.0
3) ●		1	0	1	0	Forward ▼	RGB ▼	0	0	100% ▼	1.0
4) ●		1	0	1	0	Forward ▼	RGB ▼	0	0	100% ▼	1.0
5) ●		1	0	1	0	Forward ▼	RGB ▼	0	0	100% ▼	1.0
6) ●		1	0	1	0	Forward ▼	RGB ▼	0	0	100% ▼	1.0
7) ●		1	0	1	0	Forward ▼	RGB ▼	0	0	100% ▼	1.0
8) ●		1	0	1	0	Forward ▼	RGB ▼	0	0	100% ▼	1.0
Differential Receiver: <input type="text" value="Standard"/>											
9) ●		1	0	1	0	Forward ▼	RGB ▼	0	0	100% ▼	1.0
10) ●		1	0	1	0	Forward ▼	RGB ▼	0	0	100% ▼	1.0
11) ●		1	0	1	0	Forward ▼	RGB ▼	0	0	100% ▼	1.0
12) ●		1	0	1	0	Forward ▼	RGB ▼	0	0	100% ▼	1.0
Expansion Type: <input type="text" value="Standard"/>											
13) ●		1	0	1	0	Forward ▼	RGB ▼	0	0	100% ▼	1.0
14) ●		1	0	1	0	Forward ▼	RGB ▼	0	0	100% ▼	1.0
15) ●		1	0	1	0	Forward ▼	RGB ▼	0	0	100% ▼	1.0
16) ●		1	0	1	0	Forward ▼	RGB ▼	0	0	100% ▼	1.0
17) ●		1	0	1	0	Forward ▼	RGB ▼	0	0	100% ▼	1.0
18) ●		1	0	1	0	Forward ▼	RGB ▼	0	0	100% ▼	1.0
19) ●		1	0	1	0	Forward ▼	RGB ▼	0	0	100% ▼	1.0
20) ●		1	0	1	0	Forward ▼	RGB ▼	0	0	100% ▼	1.0
21) ●		1	0	1	0	Forward ▼	RGB ▼	0	0	100% ▼	1.0
22) ●		1	0	1	0	Forward ▼	RGB ▼	0	0	100% ▼	1.0
23) ●		1	0	1	0	Forward ▼	RGB ▼	0	0	100% ▼	1.0
24) ●		1	0	1	0	Forward ▼	RGB ▼	0	0	100% ▼	1.0
25) ●		1	0	1	0	Forward ▼	RGB ▼	0	0	100% ▼	1.0
26) ●		1	0	1	0	Forward ▼	RGB ▼	0	0	100% ▼	1.0
27) ●		1	0	1	0	Forward ▼	RGB ▼	0	0	100% ▼	1.0
28) ●		1	0	1	0	Forward ▼	RGB ▼	0	0	100% ▼	1.0

Serial Mode:

The capes from KulPlights.com can drive 700 pixels per port at 40 fps (roughly 1450 per port at 20 fps). They F8 can also drive other components to control additional pixels like an Expansion Board, Differential Expansion Board, Differential Receiver, or Smart Differential Receivers from <http://pixelcontroller.com>.

The capes also have RJ45 ports and depending on the cape, some can be used to drive 4 channels of serial data each. If you do not send any serial data then you will have all the ports available to connect Differential Receivers. Each RJ45 port can connect to one Differential Receiver or up to 3 daisy-chained Smart Differential Receivers with an Ethernet cable up to 250 feet to the furthest Receiver. The Differential Receivers and Smart Differential Receivers each have 4 ports for pixel string connections.

At the top of the page, you have the following options:

- Enable BBB String Cape- If you are using a BBB Cape then this box needs to be checked

- Cape Type- You will need to select the type of Cape that you are using and the type of output you are going to use. If you are using one of the Expansion Boards the select one of the options with the Expansion Board Setting. If you are going to use any of the RJ45 ports for outputting serial data, then select one of the options that corresponds to the number of serial channels you are going to output (Each RJ45 port outputs 4 serial channels). If you are not going to output any serial data from the F8, then select the (No Serial) option.
- Clone String- If you select a string port, you can clone the data to the string ports below. Once you select a string port, click on the Clone String button and you will be asked how many copies of the string you want to clone below the selected string.
- Save- This will save your settings
- Revert- This will revert to the last saved settings.
- Press F2 to auto set- When you complete a row of the configuration, you can press F2 and it will fill in the start channel on the next row. This is helpful if you have several ports that are running contiguous channels.

You can add only one Expansion Board or one Differential Expansion Board to the F8.

- Expansion Board- This will add 16 more ports to be connected locally.
- Differential Expansion Board- This will add the ability to add up to 4 Differential Receivers. Each Differential Receiver has 4 ports and each Differential Receiver can be located up to 250 feet from the F8 with an Ethernet cable connecting them. If you use Smart Differential Receiver boards, then you can add up to 3 Differential Receiver boards to each port of the Differential Expansion board by connecting them in a daisy chain.

Each port on all of the controllers/receivers have the following options:

- Description- You can enter a description for the pixels attached to the port.
- Start Channel- Enter the start channel that corresponds to the start channel in your sequencing software (xLights, Vixen, etc.)
- Pixel Count- Enter the number of pixels connected to that port of the hat.
- Group Count- If you have groups of pixels that are going to be illuminated exactly the same all of the time, you can put them in groups.
- End Channel- This indicates the ending channel for the string.
- Direction- Selecting reverse will reverse the data sent to the pixels so that it will act like the data is coming in from the end of the string.
- Color Order- You can select a color order to match the color order for the pixels you are using.
- Null Nodes- If you are using Null Nodes in the beginning of your string to help boost the transmission distance, then enter the number of Null Nodes you have in the string.
- Zig Zag- This setting is useful for items like a Mega Tree where one string is used for more than one strand of the tree. This is more commonly setup in the sequencing software (xLights, Vixen, etc.) Enter the number of times the string changes direction. **Do not use Zig Zag if you used the Strands/String setting in your sequencing software.**
- Brightness- You can set the brightness for your pixel string. Many dense props are very bright and a lower brightness might look better. This also reduces the power required to light the pixels.
- Gamma- This is a correction factor that can be entered due to the way that our eyes perceive colors in the dark. . It can also be used to correct color variations on pixel strings from different vendors

# LED Panels

This tab is for configuring P10 or P5 Panels that are going to be controlled by a Hat or Cape connected to the FPP device. Due to P10 and P5 panels not having a standard design standard, there are many settings that might need to be configured to get them to work correctly. The settings available are different depending if the FPP device is on a Raspberry Pi or BeagleBone SBC.

## Pi LED Panels Screen

LED Panels

**Enable LED Panel Output:**

**Panel Layout (WxH):**

**Single Panel Size (WxH):**

**Model Start Corner:**

**Brightness:**

**Panel Gamma:**

**Color Depth:**

**Connection:**

**Start Channel:**

**Channel Count:**

**Default Panel Color Order:**

**Wiring Pinout:**

**GPIO Slowdown:**

**LED Panel Layout:**  
Advanced Layout?   
View Config from front?

**Front View**

O-1	O-1	O-1
P-1	P-1	P-1
C-Def	C-Def	C-Def
O-1	O-1	O-1
P-1	P-1	P-1
C-Def	C-Def	C-Def
O-1	O-1	O-1
P-1	P-1	P-1
C-Def	C-Def	C-Def

- O-# is physical output number.
- P-# is panel number on physical output.
- C-(color) is color order if panel has different color order than default (C-Def).
- Arrow indicates panel orientation, click arrow to rotate.

## BB LED Panels Screen

LED Panels

**Enable LED Panel Output:**

**Panel Layout (WxH):**

**Single Panel Size (WxH):**

**Model Start Corner:**

**Brightness:**

**Panel Gamma:**

**Panel Interleave:**

**Color Depth:**

**Connection:**

**Start Channel:**

**Channel Count:**

**Default Panel Color Order:**

**Wiring Pinout:**

**Output By Row:**

(this will save changes to BBB tab & LED Panels tab)

**LED Panel Layout:**  
Advanced Layout?   
View Config from front?

**Front View**

O-1
P-1
C-Def

- O-# is physical output number.
- P-# is panel number on physical output.
- C-(color) is color order if panel has different color order than default (C-Def).
- Arrow indicates panel orientation, click arrow to rotate.

- Enable LED Panel Output- If you are using a P10 or P5 panel, this needs to be checked.
- Panel Layout (WxH)- enter the number of panels you are using in Width by Height.
- Single Panel Size (WxH)- Enter the size in pixels of each individual panel and the scan rate. (P10 panels are 32x16 and P5 panels are 64x32)\*
- Model Start Corner- This should typically be upper left if you are using xLights and bottom left if you are using Vixen. For other Sequencing software, you should match the setting in that software.
- Brightness- You can adjust the overall brightness with this setting.
- Panel Gamma- You can apply a Gamma correction to help correct the way our eyes process colors in dim situations.
- Panel Interleave- some outdoor panels (possibly others) use a non-standard transmission of the data. If they do, then this setting will need to be modified to match the transmission method of your panels. This setting is not available on the Raspberry Pi devices.
- Color Depth- Is used to set the number of possible colors. The color depth can be reduced to reduce flicker on larger sets of panels if needed.
- Connection- This is to identify the type of LED Panel controller you are using and will usually auto-populate to the correct connection type.
- Start Channel- This is the start channel for your LED Panel and is usually the Absolute address identified in your sequencing software.
- Channel Count- This is the total number of channels that your panel array will require.
- Default Panel Color Order- Panels can have a different color order. You can set the color order for your panel with this option.
- Wiring Pinout- This setting is to identify which SBC the LED panel controller is being used. It will normally auto-populate with the correct selection if it can be detected.
- GPIO Slowdown- Some panels have a slower refresh rate than the standard ones and might show some ghosting; this can be remedied by adding some slowdown to the refresh rate that is being sent to the panels. This setting is not available on the BeagleBone devices.
- Output by Row- Some panels will output the data by rows instead of sequentially, if that is the case, you can select this option. This setting is not available on the Raspberry Pi devices.
- Save- this will save your configuration.

\*- Some 1/4 scan and 1/2 scan panels use a non-conventional addressing mode and you might have to use one of the A, AB or ABCD addressing mode panel types. There usually is no indication on the panels so it might be trial and error to select the correct one. These options are only available on the BeagleBone systems.

## LED Panel Layout

Panels can be configured in several ways and it is important that the configuration matches the actual assembly/connection of your panels. The panels should be connected to as many outputs as possible so that you have a higher refresh rate. Each panel has to be identified how it is connected to the controller and the order that the panels are connected together. This is configured by setting the Output Number and Panel Order numbers in the Layout screen. The FPP device need to know the exact way that you assembled your LED panels together and the way they are connected to both the controller and each other. There are 2 views in order to configure your LED Panel layout.

## Standard LED Panel Layout

### LED Panel Layout:

Advanced Layout?

View Config from front?

Front View		
O-1 ▾ ↕	O-1 ▾ ↕	O-1 ▾ ↕
P-1 ▾	P-1 ▾	P-1 ▾
C-Def ▾	C-Def ▾	C-Def ▾
O-1 ▾ ↕	O-1 ▾ ↕	O-1 ▾ ↕
P-1 ▾	P-1 ▾	P-1 ▾
C-Def ▾	C-Def ▾	C-Def ▾
O-1 ▾ ↕	O-1 ▾ ↕	O-1 ▾ ↕
P-1 ▾	P-1 ▾	P-1 ▾
C-Def ▾	C-Def ▾	C-Def ▾

- O-# is physical output number.
- P-# is panel number on physical output.
- C-(color) is color order if panel has different color order than default (C-Def).
- Arrow ↕ indicates panel orientation, click arrow to rotate.

Make sure that you are referencing the panels correctly. You can configure the panels as if you are looking at the panels from the front or from the rear, more commonly referred to as a “wiring view.” To change the view, toggle the “View Config from front” checkbox. Make sure you save any changes made before you change the view.

The panel arrows can go in any direction you like to make wiring easier when you assemble the panels but they have to match in FPP. To change the arrow orientation, click on the arrow in the corresponding LED panel and it will rotate each time you click it.

The Output Number is the Setting that looks like O-1, O-2, etc. A panel is considered to be connected to an output if the data ribbon is wired directly to the controller or the data ribbon is wired to another panel that is connected to that port.

The Panel Order number is the Setting that looks like P-1, P-2, etc. This is the order that panels are connected to a particular port. The first panel connected to a port would be P-1, the next panel in the chain would be P-2, etc.

The Color Order is the setting that looks like C-Def. This is the color order of the RGB pixels and it is common for them to be in different orders depending on the manufacturer. If the colors are not displaying correctly, then you can change the order here or in xLights (**don't change it in both.**)

### Advanced Layout View

You can change the layout to the advanced view by selecting the Advanced Layout button. This view is for more complex layouts. You can define panels in any orientation, the panels don't have to be in the same orientation and they can be separated and the effects will display correctly. You can only use the front view in the Advanced layout.



**LED Panel Layout:**  
 Advanced Layout?   
 View Config from front?

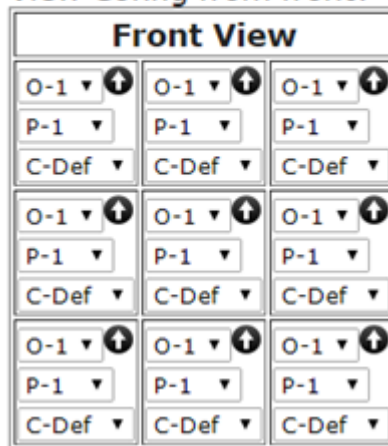

You will get a screen similar to this:

**Enable LED Panel Output:**

**Matrix Size (WxH):** 96x48

**Single Panel Size (WxH):** 32x16

**Model Start Corner:** Top Left

**Brightness:** 100%

**Panel Gamma:** 2.2

**Color Depth:** 8 Bit

**Connection:** Hat/Cap/Cape

**Start Channel:** 1

**Channel Count:** 13824 (4608 Pixels)

**Default Panel Color Order:** RGB

**Wiring Pinout:** Standard

**GPIO Slowdown:** 1 (multi-core Pi's)

**LED Panel Layout:**  
 Advanced Layout?   
 Front View

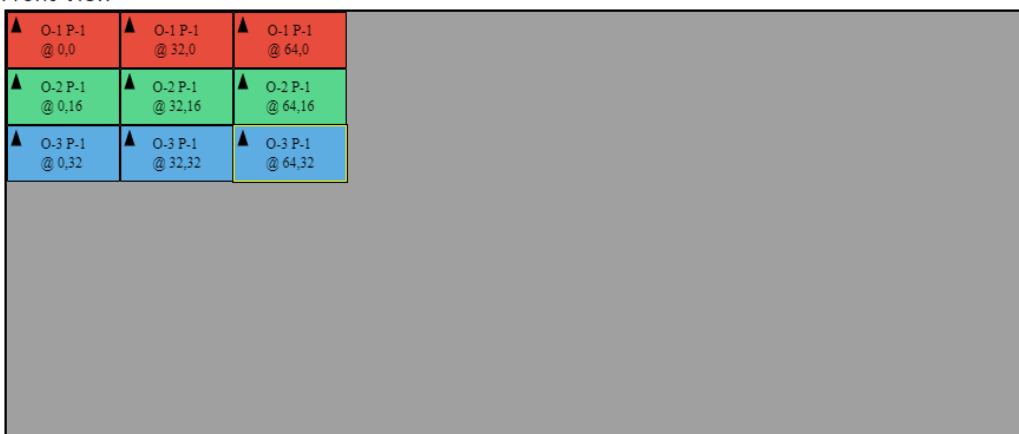

**Selected Panel:**

Output: 3

Panel: 1

Color: Def

X Pos: 64

Y Pos: 32

**UI Layout Size:** Pixels Wide: 288    Pixels High: 120

The Advanced Layout has the following sections/features:

**Matrix Size-** This is in the upper left section of the top window, this indicates the minimum matrix size that is needed to represent the matrix configuration you have configured.

**Channel Count-** This will indicate the number of channels needed to represent your matrix. These numbers will change based on the configuration but are not used for the configuration in your sequencing software and don't impact network traffic.

**Advanced Layout Configuration screen-** If you have assembled your panels in a "non-standard" configuration, then you can mimic your configuration in this panel so that it will display properly. You can drag the individual panels to the position you need and by using the Selected Panel section you can configure the Output Port, the Panel

Order, the Color order and rotate the panel so that the arrows are aligned correctly. For easy identification, the panels are color coded base on the Output Port connection.

UI Layout Size- This will configure the “window” (the grey box) that you have to move the panels around.

An example of how to use this would be that you have a 6x2 P10 panel and have 3 windows that are side by side but the windows have a gap between them and you are going to put 4 panels in each window. If you configure it in the “normal” way then scrolling items will not look correct because the scrolling items will be “pushed together” at the gap instead of a pause/space where the scrolling item should have. This is how that configuration might look:

**LED Panel Layout:**

Advanced Layout?   
 Front View

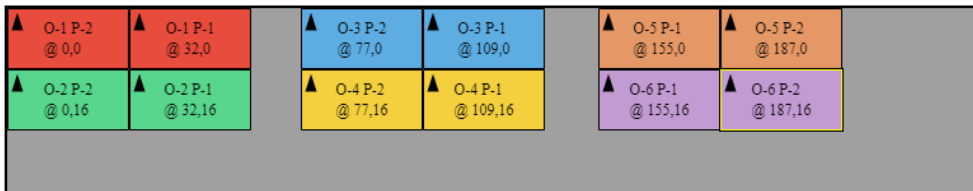

**Selected Panel:**

Output: 6 ▾  
 Panel: 2 ▾  
 Color: Def ▾  
 X Pos: 187  
 Y Pos: 16  
 Rotate

UI Layout Size: Pixels Wide: 256 Pixels High: 48

## Other

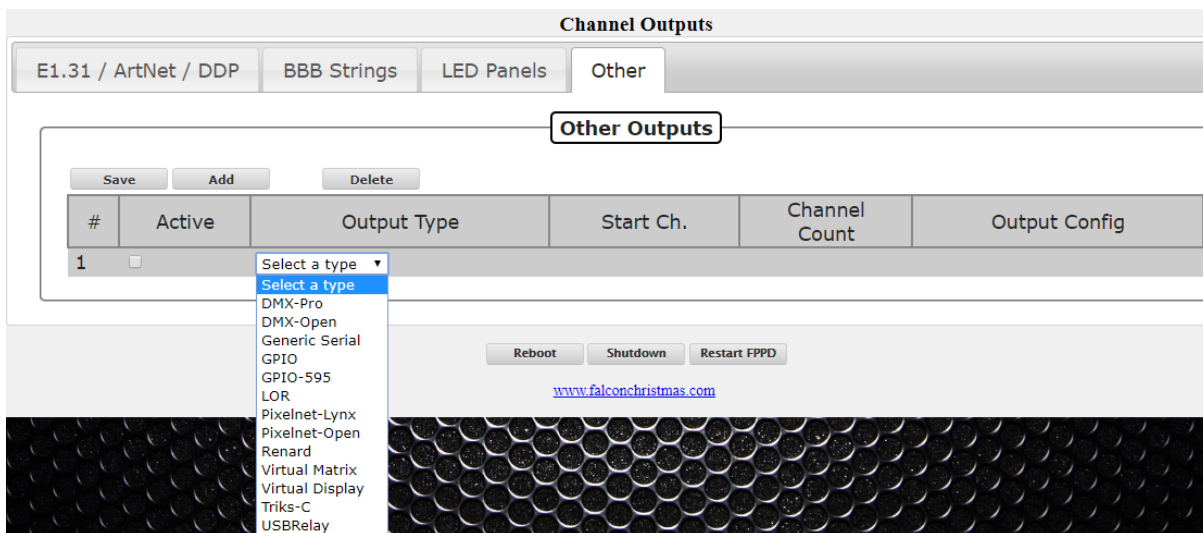

The other Output tab is to define other less common output types and if you are using these types, you probably already know how to configure them.

If you are using a Pi Cap and need to send out DMX data, then the Output type would be DMX-Open and the Output Config Port will be ttyAMA0.

## Output Processors

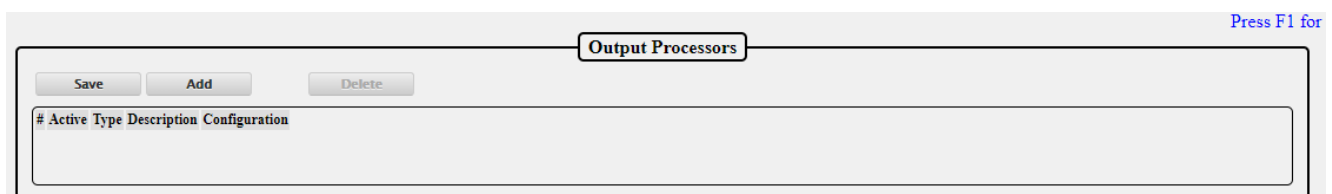

The output processors page is utilized to modify the outgoing data. This can be useful for several things such as moving a prop after the .fseq file has been save to the FPP, or adjusting the brightness if your controller does not support dimming.

The Output Processors are:

- Remap-

#	Active	Type	Description	Configuration				
1	<input checked="" type="checkbox"/>	Remap		Source Channel: 1	Destination: 1	Count: 1	Loops: 1	Reverse: <span style="border: 1px solid black; padding: 2px;">None</span>
<input type="button" value="Reboot"/> <input type="button" value="Shutdown"/> <input type="button" value="Restart FPPD"/>								

The remap processor is beneficial for several things such as when a prop has been moved because a port on the controller isn't working or you have to replace a "dumb" string with a pixel string.

- Description-This can be used to identify the reason for the remapping for future reference.
- Source Channel- Enter the first channel you want to remap to another location.
- Destination- Enter the first channel that you want the data remapped to.
- Count- Enter the total number of channels that you want remapped.
- Loops- Enter the number of times that you want this remapping to occur, this can be helpful if you need to replace a dumb string with a pixel string. Enter the Source Channel and the Destination Channel and enter 3 for the Count. Then enter the number of pixels that are in the replacement string in the Loops box.
- Reverse- This can be useful if you wired a prop in reverse or changed a controller connection to the opposite end of a string. The reverse can be by channel or by pixel type.

- Brightness-

#	Active	Type	Description	Configuration			
1	<input checked="" type="checkbox"/>	Brightness		Start Channel: 1	Channel Count: 1	Brightness: 100	Gamma: 1.0

You can modify the brightness or Gamma correction on a range of channels. This can be useful if your controller doesn't support the brightness/gamma correction or if you can't reach your controller via the web interface.

- Set Value-

#	Active	Type	Description	Configuration		
1	<input checked="" type="checkbox"/>	Set Value		Start Channel: 1	Channel Count: 1	Value: 255

You can set the value for range of channels.

- Reorder Colors-

#	Active	Type	Description	Configuration		
1	<input checked="" type="checkbox"/>	Reorder Colors		Start Channel: 1	Nodes: 1	Color Order: 132

You can change the color order. This is helpful if you have to replace a string or part of a string and it has a different color order than the section replaced.

# Pixel Overlay Models

The Pixel Overlay Models feature of the Falcon Player allows the user to manually manipulate a particular model in real-time via Plugins or scripts before it is sent out to the controllers based on each model. This can be done while the rest of your display and channels are playing sequenced data. Pixel Overlay Models are typically used for Matrices or Mega Trees (or other dense props) but can be used for any model that you want to take manual control.

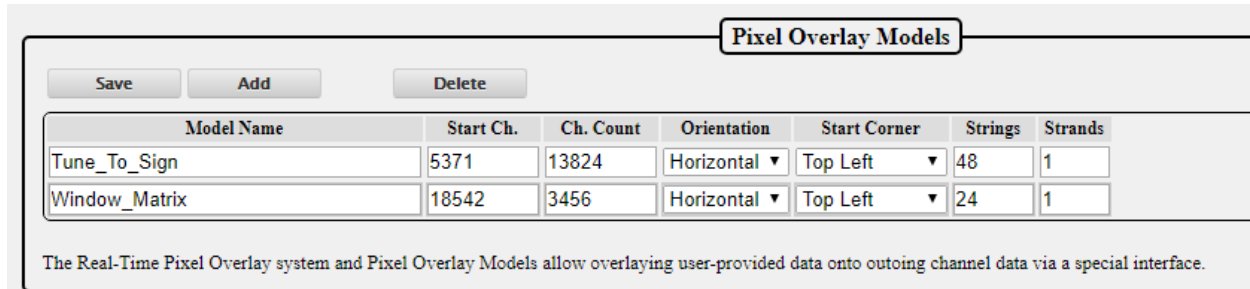

The Pixel Overlay Model has to match the settings configured in your sequencing software and string ports in your controller.

The Pixel Overlay Models can be exported from xLights to your FPP using FPP Connect and selecting the Models option.

If you want to manually enter the Pixel Overlay Models, these are the settings:

**Model Name-** This is a name to use to reference the Pixel Overlay Model in other areas of FPP such as Plugins, Scripts, etc. **The Model Name cannot have spaces.**

**Start Ch.-** The Start Channel needs to match the start channel in your sequencing software and your String Ports.

**Ch. Count-** This is the number of channels (not pixels) that this model is using.

**Orientation-** This will be the orientation that you configured the matrix in your sequencing software.

**Start Corner-** This will normally be Top Left if you are using xLights and Bottom Left if you are using Vixen for P10/P5 type panels. For other items like Pixel Matrices or Mega Trees, this will be the settings that you used in your sequencing software.

**Strings-** This will typically be the number of rows in your matrix for P10/P5 type panels. For other items like Pixel Matrices or Mega Trees, this will be the settings that you used in your sequencing software.

**Strands-** This will be 1 for P10/ P5 type panels. For other items like Pixel Matrices or Mega Trees, this will be the settings that you used in your sequencing software.

This can be used for examples such as the following:

- Displaying real-time dynamic text on a matrix or Mega Tree
- Displaying the current time or a Christmas countdown timer on a matrix
- Turning on/off individual channels for items such as a Tune-To sign, or inflatables without having to sequence the channels for these items in every one of your sequence files.

The Matrix Tools plugin available via the Plugin install page uses the Pixel Overlay feature to allow display and scrolling of dynamic text on a Pixel Overlay Model using a web interface. As an example of the power and flexibility of the Real-Time Pixel Overlay feature, you can

also use the Matrix Tools plugin to draw in Real-Time on your matrix using your mouse and web browser.

## GPIO Inputs

GPIO Input Triggers							
Built-in GPIO Inputs							
En.	GPIO #	wiring #	Events		Pull Up/Down	Hdr - Pin	
<input type="checkbox"/>	gpio2_23	87	Rising: -- No Event --	Falling: -- No Event --	None/External	P1-02	
<input type="checkbox"/>	gpio2_25	89	Rising: -- No Event --	Falling: -- No Event --	None/External	P1-04	
<input type="checkbox"/>	gpio0_5	5	Rising: -- No Event --	Falling: -- No Event --	None/External	P1-06	
<input type="checkbox"/>	gpio0_2	2	Rising: -- No Event --	Falling: -- No Event --	None/External	P1-08	
<input type="checkbox"/>	gpio0_3	3	Rising: -- No Event --	Falling: -- No Event --	None/External	P1-10	

GPIO Inputs allow the triggering of internal FPP Events via external input. Each GPIO Input is connected to a pin on the FPP's GPIO header or attached to an add-on I/O board such as the PiFace. GPIO Inputs allow two events to be attached to each pin, one rising event and one falling event. In FPP, you can set the GPIO resting state to either high (pull up) or low (pull down) using the internal resistors or you can set the resting state using external pull up or pull down resistors. If you select the None/External option, make sure your circuitry connected to the pin establishes either a high or low state or else the pin will be floating which can cause false triggers. See the [GPIO Button Input](#) section for more detailed wiring information.

- En- If you are going to use the GPIO input function, then the pin you are using needs to be enabled by placing a check in this box.
- GPIO#- This is the Pin Label as identified by the manufacturer and for reference only.
- Wiring#- This is the WiringPi library number in case you are using WiringPi functions.
- Events- In this section, you can select a previously saved event for the rising and or falling events. Refer to the [Events](#) section for more details.
- Pull up/Down- You can set the internal pull up or pull down resistor in this box.
- Hdr-Pin- This is for reference to locate the pin on the headers

Input triggers can be useful for various things such as a button to start or stop a sequence, a motion sensor to activate a sequence or another external device just to name a few.

# Help

This section is for information on troubleshooting, references and updates.

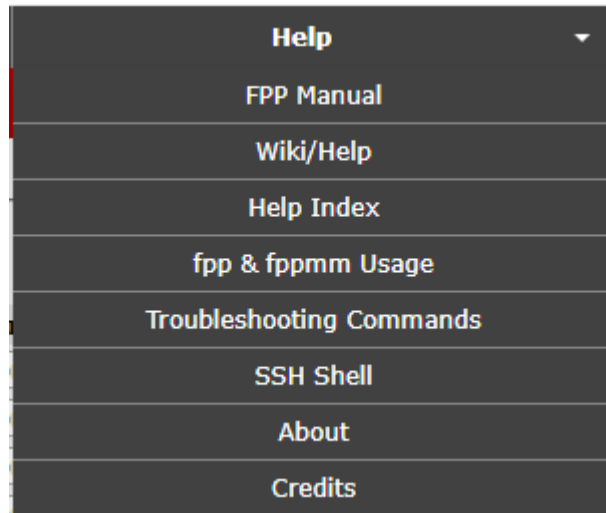

## FPP Manual

This will show the most current FPP Manual if your FPP Device has internet access. If your FPP device does not have an internet connection, you can access the current FPP Manual at:

[https://falconchristmas.github.io/FPP\\_Manual.pdf](https://falconchristmas.github.io/FPP_Manual.pdf)

## Wiki/Help

If your computer has an internet connection, clicking this link will take you to the FPP Wiki site. The Wiki site might not have the most current information.

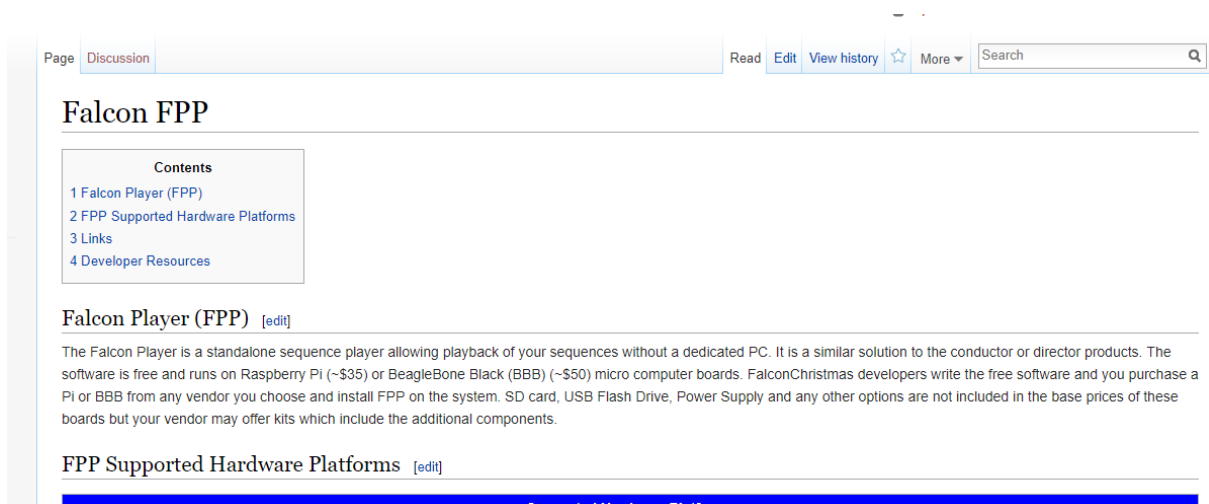

## Help Index

The Help Index has links to various topics and information regarding those topics as a quick reference. The user manual has more detailed information on these subjects.

- [Backup & Restore](#)
- [Channel Outputs](#)
- [GPIO Input Triggers](#)
- [Network Config](#)
- [Output Processors](#)
- [Scheduler](#)
- [Script Repository Browser](#)
- [Settings](#)

## fpp & fppmm

This page provides information on some of the fpp and fppmm commands that can be used in the shell or in scripts.

### fpp -h

Usage: /opt/fpp/src/fpp [OPTION...]

fpp is the Falcon Player CLI helper utility. It can be used to query certain information and send commands to a running fppd daemon.

#### Options:

- V - Print version information
- s - Get fppd status
- v VOLUME - Set volume to 'VOLUME'
- p PLAYLISTNAME [STARTITEM] - Play Playlist PLAYLISTNAME in repeat mode
- P PLAYLISTNAME [STARTITEM] - Play Playlist PLAYLISTNAME once, optionally starting on item STARTITEM in the playlist
- c PLAYLIST\_ACTION - Perform a playlist action. Actions include:
  - next - skip to next item in the playlist
  - prev - jump back to previous item
  - stop - stop the playlist immediately
  - graceful - stop the playlist gracefully
  - pause - pause a sequence (not media)
  - step - single-step a paused sequence
  - stepback - step a paused sequence backwards
- S - Stop Playlist gracefully
- d - Stop Playlist immediately
- q - Shutdown fppd daemon
- R - Reload schedule config file
- e EFFECTNAME[,CH[,LOOP]] - Start Effect EFFECTNAME with optional start channel set to CH and optional looping if LOOP is set to 1
- E EFFECTNAME - Stop Effect EFFECTNAME
- t EVENTNAME - Trigger Event EVENTNAME
- G GPIO,MODE - Configure the given GPIO to MODE. MODEs include:
  - Input - Set to Input. For PiFace inputs this only enables the pull-up
  - Output - Set to Output. (This is not needed for PiFace outputs)
  - SoftPWM - Set to Software PWM.
- g GPIO,MODE,VALUE - Set the given GPIO to VALUE applicable to the given MODEs defined above VALUE is ignored for Input mode

## fppmm -h

```
Usage: /opt/fpp/src/fppmm [OPTIONS]

Options:
  -V                - Print version information
  -t on             - Turn channel test mode On
  -t off           - Turn channel test mode Off
  -t status        - Check current status of test mode
  -c CHANNEL -s VALUE - Set channel number CHANNEL to VALUE
  -m MODEL         - List info about Pixel Overlay MODEL
  -m MODEL -o MODE - Set Pixel Overlay mode, Mode is one of:
                    off, on, transparent, transparentrgb
  -m MODEL -f FILENAME - Copy raw FILENAME data to MODEL
  -m MODEL -s VALUE - Fill MODEL with VALUE for all channels
  -h              - This help output
```

## Troubleshooting Commands

When you click on this link, the FPP will run several troubleshooting commands that can be useful to diagnose problems.

### Interfaces: `ifconfig -a`

```
eth0: flags=-28605 mtu 1500
    inet 192.168.1.100 netmask 255.255.255.0 broadcast 192.168.1.255
    inet6 fe80::ba27:ebff:fe61:fe1e prefixlen 64 scopeid 0x20
    ether b8:27:eb:61:fe:1e txqueuelen 1000 (Ethernet)
    RX packets 234133 bytes 24596895 (23.4 MiB)
    RX errors 0 dropped 0 overruns 0 frame 0
    TX packets 70466 bytes 24816845 (23.6 MiB)
    TX errors 0 dropped 0 overruns 0 carrier 0 collisions 0

lo: flags=73 mtu 65536
    inet 127.0.0.1 netmask 255.0.0.0
    loop txqueuelen 1000 (Local Loopback)
    RX packets 241858 bytes 27636023 (26.3 MiB)
    RX errors 0 dropped 0 overruns 0 frame 0
    TX packets 241858 bytes 27636023 (26.3 MiB)
    TX errors 0 dropped 0 overruns 0 carrier 0 collisions 0

wlan0: flags=-28669 mtu 1500
    ether b8:27:eb:34:ab:4b txqueuelen 1000 (Ethernet)
    RX packets 0 bytes 0 (0.0 B)
    RX errors 0 dropped 0 overruns 0 frame 0
    TX packets 0 bytes 0 (0.0 B)
    TX errors 0 dropped 0 overruns 0 carrier 0 collisions 0
```

### Wired: `ethtool eth0`

```
Cannot get wake-on-lan settings: Operation not permitted
Settings for eth0:
    Supported ports: [ TP MII ]
    Supported link modes:   10baseT/Half 10baseT/Full
                           100baseT/Half 100baseT/Full
    Supported pause frame use: No
    Supports auto-negotiation: Yes
```



The commands that it runs are:

- `ifconfig -a`  
This displays the configuration of all network interfaces on the FPP device.
- `ethtool eth0`  
This displays the current parameters of the eth0 interface.
- `iwconfig`  
This displays the current parameters of the wireless interface
- `netstat -rn`  
This displays the routing tables
- `ping -c 1 $(netstat -rn | grep '^0.0.0.0' | awk '{print $2}')`  
This will ping the default gateway and display the results.
- `ping -c 1 github.com`  
This will ping github.com to check for a network connection and display the results.
- `sudo lsblk -l`  
This lists all of the storage devices.
- `sudo fdisk -l`  
This will list all of the partitions on your storage devices.
- `df -k`  
This displays the file system information.
- `mount | grep -v password`  
This displays the details of all of the mounted devices.
- `date`  
This displays the current FPP system date and time and also the time zone.
- `pgrep ntpd > /dev/null && ntpq -c peers`  
This will check to see if the Network Time Protocol Daemon is running and then list the peers that the program is getting its time from.
- `sudo hwclock -r -f /dev/rtc0`  
This will determine if a real time clock is installed and display the time if there is one.
- `free`  
This displays the amount of used and free physical and swap memory.
- `uptime`  
This displays how long the FPP daemon has been running.
- `top -bn1 | head -20`  
This displays the CPU Utilization.
- `cat /proc/cpuinfo`  
This displays the CPI information.
- `sudo lsusb -t`  
This displays the USB information in a tree format.
- `sudo lsusb -v`  
This displays detailed information on the USB devices.
- `sudo aplay -l`  
This displays all of the audio playback devices
- `(bin/ls -1d /proc/asound/card[0-9] | sed -e "s/.*\vcard//" ...`  
This displays all of the mixer devices
- `uname -a`  
This displays the kernel information
- `lsmod`  
This displays all of the kernel modules that are installed.
- `sudo i2cdetect -y -r 2`

This displays if you have any devices connected to the i2c bus such as an oled display.

- `ps -edaf -forest`  
This displays a list of the currently running processes
- `sudo journalctl -u fppinit`  
This will display the FPP Initialization Log
- `sudo journalctl -u fppcapedetect`  
This will display the results of the Cape Detect Log.
- `sudo journalctl -u fpp_postnetwork`  
This will get the Post Network Logs
- `sudo journalctl -u fppoled`  
This will display the OLED Logs

## SSH Shell

You can use the SSH Shell for advanced operations or troubleshooting using Linux commands. The user is fpp and the password is falcon.

Normally users do not need to use the SSH Shell for operations or configuring the FPP. The SSH Shell is typically used by advanced users that want to customize the FPP.

## About

The About page provides information about the current FPP version and statistics relevant to the running FPP. This is also the page that you will navigate to in order to perform a manual update.

The screenshot shows the 'About FPP' page with the following information:

Version Info		Player Stats	
FPP Version:	v3.6	Playlists:	1
FPP OS Build:	v3.4	Sequences:	19
OS Version:	Debian GNU/Linux 10 (buster)	Audio Files:	0
Hardware Serial Number:	1749GPB41448	Videos:	0
Kernel Version:	4.19.50-bone35	Events:	1
Local Git Version:	3282b09 (Update is available) <a href="#">ChangeLog</a>	Effects:	0
Remote Git Version:	1566f20 <a href="#">Preview Changes</a>	Scripts:	4
Disable Auto Update:	<input checked="" type="checkbox"/> <a href="#">Manual Update</a>		

System Utilization		Disk Utilization	
CPU Usage:	0.00%	Root Free Space:	10.83 GiB (74%)
Memory Usage:	22.24%	Media Free Space:	10.83 GiB (74%)

**Uptime**  
14:13:51 up 1 day, 20:02, load average: 0.05, 0.07, 0.02

This page has information that can be useful for troubleshooting or updating your FPP system.

## Version Info

- FPP Version- This is your current FPP Version.
- FPP OS Build- This is the current operating system build.
- OS Version- This lists the SBC base operating system version.

- Hardware Serial Number- This will list the serial number for this FPP device.
- Kernel Version- This lists the Kernel Version.
- Git Branch- This lists the Git branch for the installed system
- Local Git Version- This lists the current Git version that is installed. The ChangeLog link will show a summary of changes that have occurred since the initial release.
- Remote Git Version- This lists the most current Git version available. If this shows “Unknown” then your FPP does not have access to the internet. Possibly due to network configuration errors. If there is an update available, then a Preview Changes link will be available so you can view what changes the update will provide.
- Disable Auto Update- This allows you the option to have FPP automatically update the software. It is recommended to have this option selected during the time that you are displaying your show as the update could interrupt your show.
- Manual Update- If there is an update available, FPP will indicate this and you can manually update the software by clicking on this button

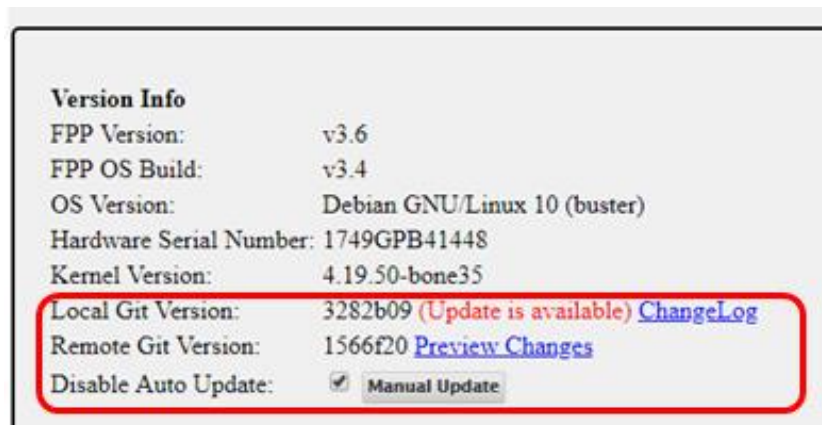

## System Utilization

This will show your system stats and performance

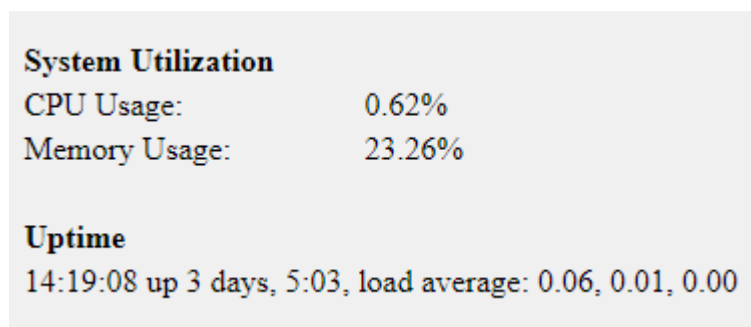

- CPU Usage- This will show the utilization of the CPU at the time the page loads, it does not update until the page is refreshed.
- Memory Usage- This will show how much of the RAM is being used at the time the page loads, it does not update until the page is refreshed.
- Uptime- This shows the current system time and how long the FPP has been running.

## Player Stats

This shows an overview of the files saved on your system. If you click on the number next to the item, it will take you to the appropriate page where these are stored.

Player Stats	
Playlists:	4
Sequences:	21
Audio Files:	19
Videos:	0
Events:	5
Effects:	1
Scripts:	5

## Disk Utilization

This shows the free space on your storage devices.

Disk Utilization	
Root Free Space:	24.82 GiB (85%)
Media Free Space:	24.82 GiB (85%)

## Credits

The Credits gives credit to the major developers and contributors to the FPP software.

Credits

**FPP Developed By:**

David Pitts  
 Tony Mace (MyKroFt)  
 Mathew Mrosko (Materdaddy)  
 Chris Pinkham (CaptainMurdoch)  
 Dan Kulp (dkulp)  
 Stephane Legargeant (ihbar)

---

**Video Tutorials by:**

Alan Dahl (bajadah)

---

**3rd Party Libraries used by FPP for some Channel Outputs:**

[rpi\\_ws281x](#) by Jeremy Garff. Used for driving WS281x pixels directly off the Pi's GPIO header.  
[rpi-rgb-led-matrix](#) by Henner Zeller. Used for driving HUB75 panels directly off the Pi's GPIO header.  
[RF24](#) Used for driving nRF24L01 output for Komby.  
[OLA](#) by the Open Lighting Project (not currently in FPP UI).

# Glossary

**Absolute Channel-** A numbering system to uniquely identify each channel in each pixel and/or DMX device. It is simply 1 to the last channel needed. In xLights, you can have gaps in the numbering sequence. Due to the number of pixels utilized in most displays, the total number of channels can become quite large and difficult to manage.

**BBB-** A single board computer used to play sequences or act as a controller interface for animated holiday lighting. BBB is an acronym for BeagleBone Black. This acronym is commonly used for all of the BeagleBone series Single Board Computers.

**Broadcast-** A method of transmitting network data where the same data is sent to every device on the network.

**btrfs-** A filesystem for Linux that implements advanced features including compression.

**Channel-** An identifier for a component in a lighting display. This is commonly used for pixels to set the color and brightness, but it can also be used for other items such as DMX channels for other components.

**DHCP-** Dynamic Host Configuration Protocol is a network management protocol where IP addresses can be dynamically assigned to devices on a network. This allows devices the ability to automatically communicate within a network. The IP addresses assigned to a device is not a permanent assignment and a device can get a different IP address the next time it connects to the network. To utilize DHCP, you have to have a DHCP server in your network. Most routers have a DHCP server on them.

**DNS-** Domain Name System is a naming system for devices or domains in a network. All devices in a network are identified by an IP address, such as 192.168.0.1. The DNS allows users to use more human friendly Host Names to access devices on the network. That way you can type something like google.com to access their website. But in reality Google's website is actually 172.217.11.238 (that is one of several devices on Google's domain.) This will also allow you to type something like fpp or whatever other host name you have saved on your FPP or other devices in your local network. To utilize DNS, you have to have a DNS server in your network and it has to be identified in the network settings. Most routers have a DNS server on them.

**E1.31-** A network protocol that is used to transmit DMX data. This is the most commonly used protocol in the animated holiday lighting hobby.

**Effect-** is a small sequence usually for just one model and can be used to overwrite the data that is being played by a sequence. It is commonly used with an event or via a manual trigger.

**eMMC-** Is a flash memory on the BeagleBone Black and BeagleBone Green computers. You can store the FPP operating system on the eMMC if you want.

**eth0-** The wired network portion of the FPP.

**Event-** An event can be a sequence or a script to run when a trigger is activated or it can be activated manually through the FPP interface.

**ext4-** The standard file system for Linux operating systems.

FPP- Falcon Player is a widely used player and operating system used in animated holiday lighting.

fseq file- The standard format for the raw data files used to inform controllers how to illuminate each light or which DMX channel to be activated.

Gateway- The IP address that a device will send network data to that it doesn't know how to properly route. This is usually your router or a FPP device where it is connected to two different subnets.

Git- A distributed version control system for coordinating work among developers and the core of the Github software hosting system.

Host Name- A human friendly name that you can assign a device to access through a web interface instead of typing the IP Address.

IP address- A numerical label to address devices in a network. This number is four parts separated by a decimal point. Each part can be between 0 and 255.

Master/Remote- An FPP method to synchronize several FPP devices by sending small sync signals to all of the remotes. This can be useful for very large displays or displays that are widespread and running Ethernet cables could be problematic.

Multicast- A method of transmitting network data where the same data is sent to all the devices that requested it but not to the devices that did not request it..

MultiSync- A way to identify relevant FPP instances in a Master/Remote configuration and to keep them synchronized with each other

Netmask- A numerical mask to identify the size the size of a subnet. This is typically 255.255.255.0 in the holiday animated lighting networks.

Network- A group of devices connected through a digital telecommunications network to provide a method for these devices to share data.

NTP- Network Time Protocol is a networking protocol used to keep network system's clock(s) synchronized with the accurate time.

P10/P5 panel- Display panels that are typically 6 inches in height by 12 inches in width. These panels have pixels that are spaced according to the panel type, i.e. P5 panels have pixels that are spaced 5 millimeters apart. These panels can be combined to make larger panels and are commonly used as a "Tune To" sign to display informational text and/or more detailed graphics.

Pixel- This usually refers to an LED light with individually addressable channels so that each pixel in a string/strand can be identified and lighted in a color that is independent from the other pixels in the string.

Playlist- A playlist is an ordered list of various items to display and is used by FPP to control the lights and other props used in the animated lighting hobby.

Plugin- A component developed to provide more functionality to the FPP.

Port- The physical connection point on a controller for pixel strings.

Raspberry Pi- A single board computer used to play sequences or act as a controller interface for animated holiday lighting.

Real Time Clock- A component that contains a highly accurate timing crystal used to keep accurate time in certain devices.

SBC- Single Board Computer is a small complete computer built on a single circuit board. The Raspberry Pi and BeagleBone series computers are the most commonly used single board computers in the holiday lighting community.

Script- A small program code used to perform a specific function in the FPP interface.

SSH- Secure Shell is a network protocol that gives users a secure way to access devices through a command line interface. This is usually for advanced users.

Subnet- A portion of a network usually comprised of devices within a range of IP addresses defined by the first 3 segments of a 4 segment IP address, i.e. 192.168.0.xxx where xxx is the identifying address for each device.

Tethering- A method of connecting two network devices directly to communicate between them. This can be done through an Ethernet cable, USB cable or through Wi-Fi.

UI- User Interface the method in how a user interacts with a device and/or program. FPP's User Interface is through a web page based interface.

Unicast- A method of transmitting network data where only the data for each device is sent to that device. This is usually more efficient than Multicast or Broadcast unless you want or need to send the same data to multiple devices.

Universe/Channel notation- A numbering system to uniquely identify each channel in each pixel and/or DMX device. It breaks the channels down into user defined groups called Universes. The user can define each Universe to be up to 512 channels in size. This is usually easier to manage than Absolute Numbering. You can have gaps in the Universes and they don't have to start at the number one.

uSD card- A Micro SD card that is used to store computer data. In FPP this is usually the FPP operating system and related files.

wlan0- The Wi-Fi or wireless network portion of the FPP.

WPA Pre Shared Key- The password to gain access to a Wi-Fi network.

WPA SSID- The technical name for a wireless network.

# Advanced Options

This section is for information that is beyond the basic Setup and configuration settings.

## Network Configuration

In order for all of your devices to communicate with each other, the network has to be configured properly and this has been the source of many people's problems, especially when you are just beginning in this hobby.

In order to communicate with your devices and setup your show network, you need to know what your home router IP address is and what subnet it is using. It is usually 192.168.0.1 or 192.168.1.1. These are the most common, but other addresses may be used. If you don't know what your home network's router IP address is, sometimes it is on a label on the router or you can use the command ipconfig in a command prompt on your PC (ifconfig on Macs). Depending on how your computer is connected to your home network (wireless or wired) the default gateway will be listed in different sections of the report.

IP addresses are in the format of 4 groups of numbers separated by a "." And the numbers will range from 0 to 255. So an IP address will look something like 192.168.0.1. The first 3 groups of numbers are called the subnet; in this case the subnet is 192.168.0 (192.168.0.1). The device number is the last group of numbers; in this case it is 1 (192.168.0.1). It is important that you know what subnet your home network is using because devices can only communicate directly with devices that are in the same subnet. In order for devices to communicate with devices on a different subnet, you have to tell the systems how to communicate with each other, (more on that later.)

## Common Network Setups

There are four methods of show networking that are the most common; Standalone, Wired on Home Network, Wired on Separate Show Network, and Master/Remote. Each method has advantages/limitations and you will need to decide what works best for you.

Below are some examples and in the chart below the FPP(s) and controller(s) are the typical settings to create your network. You will need to know what the IP address is for your home network's main router. When numbering your devices, it is suggested to go on the higher end of the range because your router will usually assign DHCP addresses at the bottom end of the range.

The following examples will assume that your home network's router's IP address is 192.168.0.1. If that is not the case, then make the appropriate changes as explained above.

### Standalone

This method has the light show totally separate from the home network without any interaction between the two networks. This has a few advantages/drawbacks.

- There is no connection to the internet so you will have to manage updates and other administrative functions by some manual process.
- There is no Network Time Protocol available so you will need some method to keep accurate time if you are going to use a schedule.
- You will need either a dedicated computer on the show network to make changes to your FPP and/or controller settings or a computer that you can change connections from your home network to your show network.
- If you only have only one controller, then connect FPP directly to the controller with an Ethernet cable connected to the appropriate ports.
- You will need Ethernet cables run from the switch to the FPP and each controller.
- Make sure you have the Channel Outputs for each FPP set correctly.



- FPP mode needs to be set to Player (Standalone.)

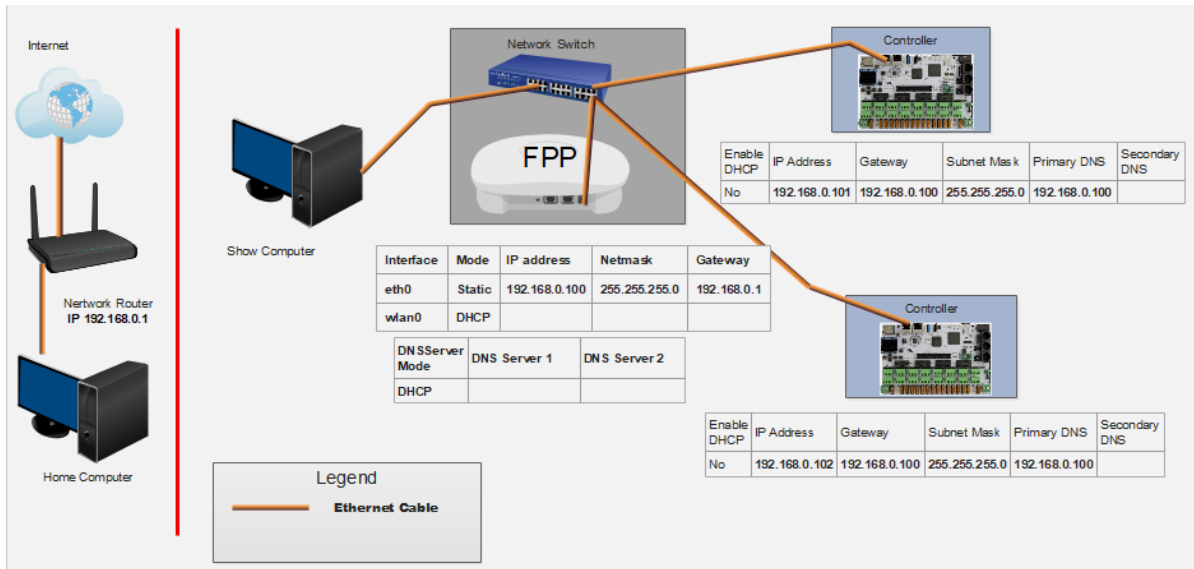

Note: In this case, you can make your FPP IP address any valid IP address. All of your controllers will have an IP address that have the same first 3 sets of numbers as the FPP, and the last set of numbers must be unique.

### Wired on Home Network

This method will use your home network for the E.131 data transmission. This is not used very often.

- All of your FPPs and controllers will have connection to the internet so updates can be performed from your home computer.
- Your FPP will have access to a Network Time Protocol so it will keep time for scheduling if you set up the NTP.
- If you only have one controller, then you can connect FPP directly to the controller with an Ethernet cable connected to the appropriate ports.
- You will need Ethernet cables run from the home network router to the FPP and each controller.
- Your show data will be transmitted using your home network which might cause a slowdown or lag on your overall network.
- Make sure you have the Channel Outputs for each FPP set correctly.
- FPP mode should be set to Player (Standalone)

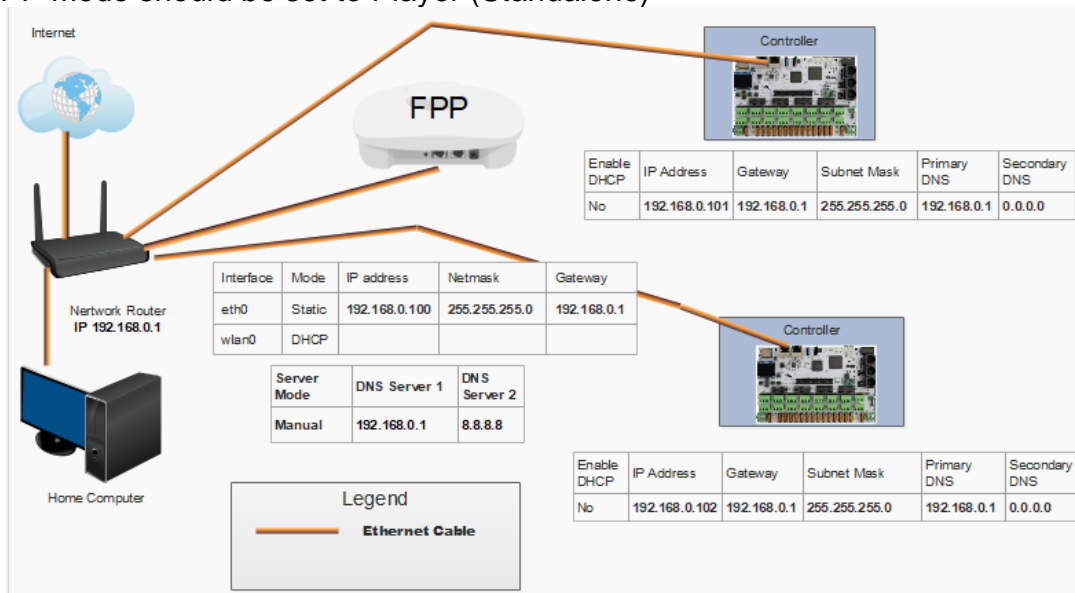

Note: All of the IP addresses have the same subnet (first 3 sets of numbers) as the home network router, in this case, 192.168.0 and the last set of numbers is unique. All of the gateways are the same as the IP address of the home network router, in this case, 192.168.0.1. Your network might be different depending on your home network router's address.

## Wired with Separate Show Network

This method will provide a separation of the network traffic from your home network traffic and still allow internet access for FPP/Controller updates. This is one of the more common methods that are used. In order to access the controllers that are on the show network, you have to provide a method for the two networks to communicate with each other. There are two methods, adding a static route in your router or creating a route path in your computer. If you create a static route in your router, then all computers on your home network can access your controllers, but not all routers have a static route function. When adding a route path in a Windows computer, you can make it persistent so that if you turn off the computer, you can still access the controllers when you turn it back on. Macs don't have the persistent attribute to their route function so you will have to re-enter the route if you reboot your computer.

- All of your FPPs and controllers will have connection to the internet so updates can be performed from your home computer.
- Your FPP will have access to a Network Time Protocol so it will keep time for scheduling.
- If you have more than one controller then you will need a switch. If you only have one controller, then connect FPP to the controller with an Ethernet cable connected to the appropriate ports.
- You will need Ethernet cables run from the switch to the FPP and each controller.
- Make sure you have the Channel Outputs for each FPP set correctly.
- Make sure you have the Enable Routing between network interfaces checked in the Network settings of the FPP
- FPP mode should be set to Player (Standalone)

## One Controller

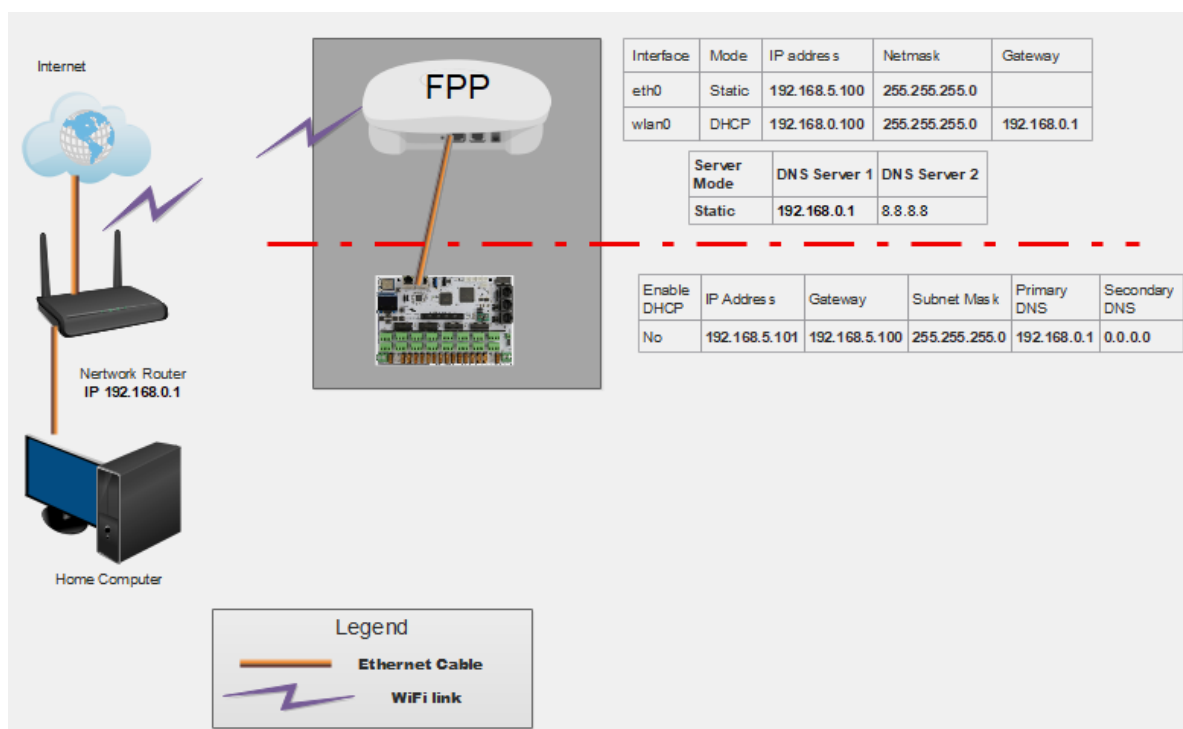

## Multiple Controllers

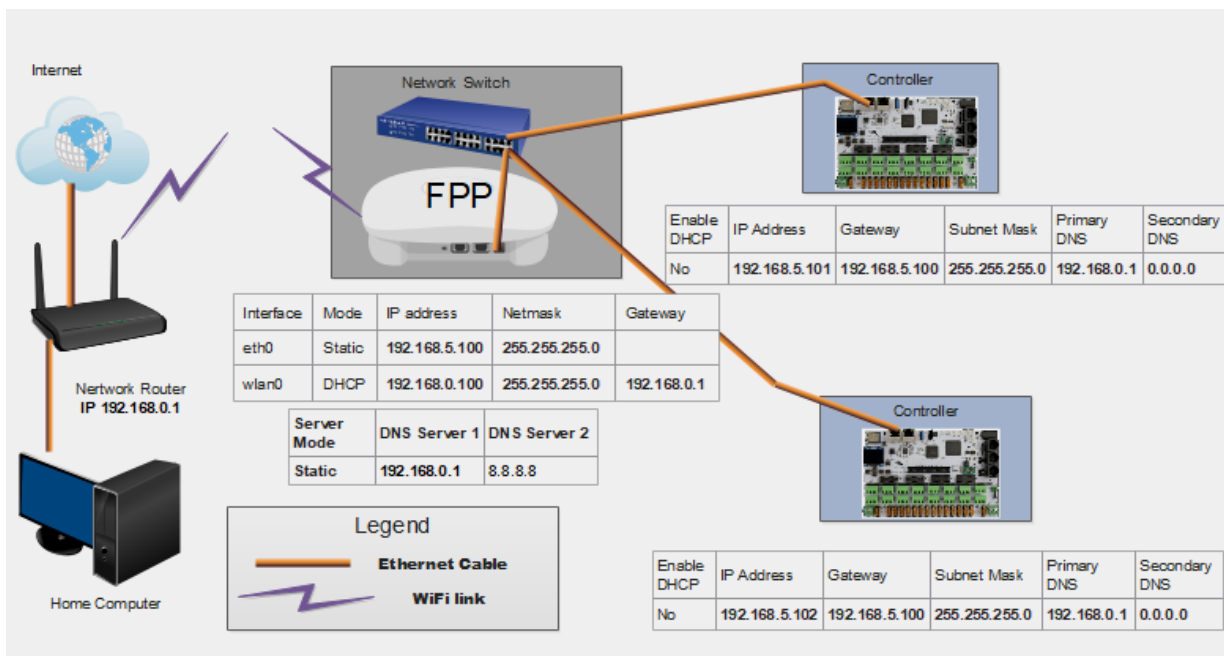

Note: The FPP wlan0 IP address will be on the same subnet (first 3 sets of numbers) as the home network router, in this case, 192.168.0. The eth0 on the FPP and the controllers will be on a different subnet, in this case, 192.168.5 (you pick the subnet). Do not put a gateway address for the eth0 on the FPP. The gateway on the FPP wlan0 should be the same as your home router IP address. The gateway(s) on all of the controllers should be the same as the eth0 IP for your FPP. You will need to set up routing to your controllers (see [Configuring a Static Route](#) for more information). Your network might be different depending on your home network router's address.

## Master/Remote

This method eliminates the need for Ethernet cables connecting your FPPs and controllers even though you could use a wired network if you want. You will need an FPP device at each remote location. This is one of the more common methods that are used especially in larger shows or ones that are spread across a large area. The Master FPP will send a very small sync package over your wireless network. Each FPP will need a copy of the .fseq files to play (or the video if you are using the remote FPP to play a video through a projector). In order to access the controllers that are on the show network, you have to provide a method for the two networks to communicate with each other. There are three methods; you can set the FPP device to be a Proxy Host (see [Proxy Settings](#) in the Status/Control section), adding a static route in your router or creating a route path in your computer. If you create a static route in your router, then all computers on your home network can access your controllers, but not all routers have a static route function. When adding a route path in a Windows computer, you can make it persistent so that if you turn off the computer, you can still access the controllers when you turn it back on. Macs don't have the persistent attribute to their route function so you will have to re-enter the route if you reboot your computer.

- All of your FPPs and controllers will have connection to the internet so updates can be performed from your home computer.
- Your FPP will have access to a Network Time Protocol so it will keep time for scheduling if you set up the NTP.
- You do not need a network switch.
- You will need an FPP device at each remote location.
- You will not need any Ethernet cables.

- You will need a good Wi-Fi connection at all of your remote FPP devices.
- The Master FPP will need all media and sequence files stored on it.
- Each Remote will need all the sequence files and any videos, etc that it will be playing directly stored on it.
- Make sure you have the Channel Outputs for each FPP set correctly.

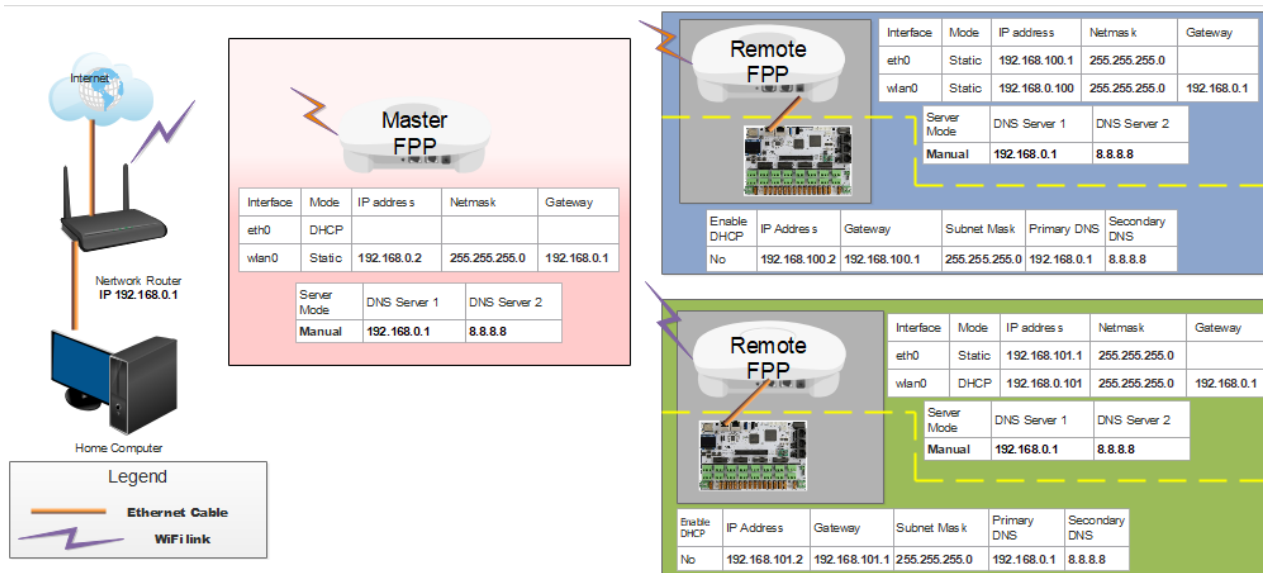

Note: The all of the FPPs wlan0 IP addresses will be on the same subnet (first 3 sets of numbers) as the home network router, in this case, 192.168.0. The eth0 on the Remote FPPs will each be on a separate subnet and the attached controller will have an IP address in the same subnet as the eth0 subnet of the attached FPP. Do not put a gateway address for the eth0 on the FPPs. All of the FPP wlan0 gateways are the same as the IP address of the home network router, in this case, 192.168.0.1. Your controller's gateway will be the eth0 IP of the attached FPP. You will need to set up routing to each your controllers (see [Configuring a Static Route](#) for more information). If you have 3 controllers, then you will have 3 routes. (If your controller is a hat or cape attached to a Pi/BB, then you don't need to create a route for those) Your network might be different depending on your home network router's address.

For an in depth discussion, refer to this post:

<https://falconchristmas.com/forum/index.php/topic,4231.0.html>

## Virtual Matrix

The Virtual Matrix function in the Channel Outputs section of FPP enables you to use the HDMI port to output sequence data to a projector or TV/Monitor. In order to use the Virtual Matrix output, you will need to create a Matrix model in your sequencing software and associated DDP or E1.31 Universes (DDP is recommended). Like all models, the Model configuration in your sequencing software needs to match your Virtual Matrix configuration. The resolution of your display will be dependent on the resolution of your matrix, but be careful the number of channels can become quite large.

## Creating a Virtual Matrix

The higher resolution of your Virtual Matrix will create a larger .fseq file and render times. It will also add to your network traffic (Unless you are running a Master/Remote mode) The maximum size Virtual Matrix that can be used is:

672 x 496 (4:3 Aspect Ratio.)  
768 x 432 (16:9 Aspect Ratio.)

And the width and height need to be divisible by 16.

If you want a higher resolution you might try outputting video directly from the FPP (see next section)

For this example we will use a Virtual Matrix of 192 x 112.

- Create the Network channels in the Controllers section of your sequencing software, DDP is recommended. In xLights you would select the Add Ethernet option. Because we are using a 192 x 112 Virtual Matrix, we will need to create 64,512 channels using the following settings:
  - Name- Create a name for your controller.
  - Description- Create a Description that identifies this FPP device if you want. (this is optional)
  - Id- You can normally leave this at the default.
  - Auto Size- Leave this unchecked.
  - Active- Make sure this is checked.
  - Vendor- Select FPP
  - Model- Leave this blank.
  - Suppress duplicate frames- Leave this unchecked.
  - IP Address- Set this to the IP address of the FPP Device that will be displaying your effects.
  - Protocol- Select DDP
  - Channels per packet- Leave at the default of 1440.
  - Keep Channel Numbers- Leave this checked.
  - FPP Proxy Host/IP- Leave this blank.
  - Channels- Set to the number that you need for your Virtual Matrix (in this case, 64,512 which is 192 x 112 x 3.)

Name	Protocol	Address	Universes/Id	Channels	Description
F48	E131	192.168.101.2	1-6	3072 [1-3072]	
FPPVirtual Matrix	DDP	192.168.1.250	7	64512 [3073-67584]	

Name	FPPVirtual Matrix
Description	
Id	7
Auto Size	<input type="checkbox"/>
Active	<input checked="" type="checkbox"/>
Vendor	FPP
Model	
Suppress Duplicate Frames	<input type="checkbox"/>
IP Address	192.168.1.250
Protocol	DDP
Channels Per Packet	1440
Keep Channel Numbers	<input checked="" type="checkbox"/>
FPP Proxy IP/Hostname	
Channels	64512
Models	Matrix

- Click On Save
- Note the beginning channel number for your Matrix, in this case it is 3073.



- Create a matrix in your sequencing software with the resolution you want. (For this example we are using 192 x112) Using the following settings:
  - Name- Create a meaningful name for your matrix (for this example we are using Virtual Matrix)
  - Direction- Horizontal
  - # Strings- Enter the resolution height (for this example we will use 112.)
  - Nodes/String- Enter the resolution width (for this example we will use 736.)
  - Starting Location- Top Left
  - Start Channel- Select the DDP network you created for your matrix.

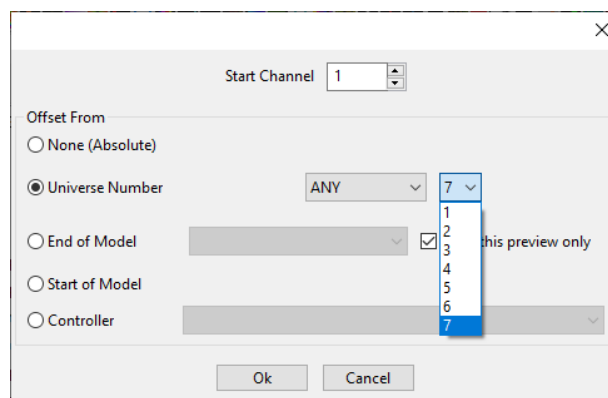

- Click on OK
- Click on Save
- Create the Virtual Matrix in FPP.
  - Go to your Channel Outputs and the Other tab and select the Add button.

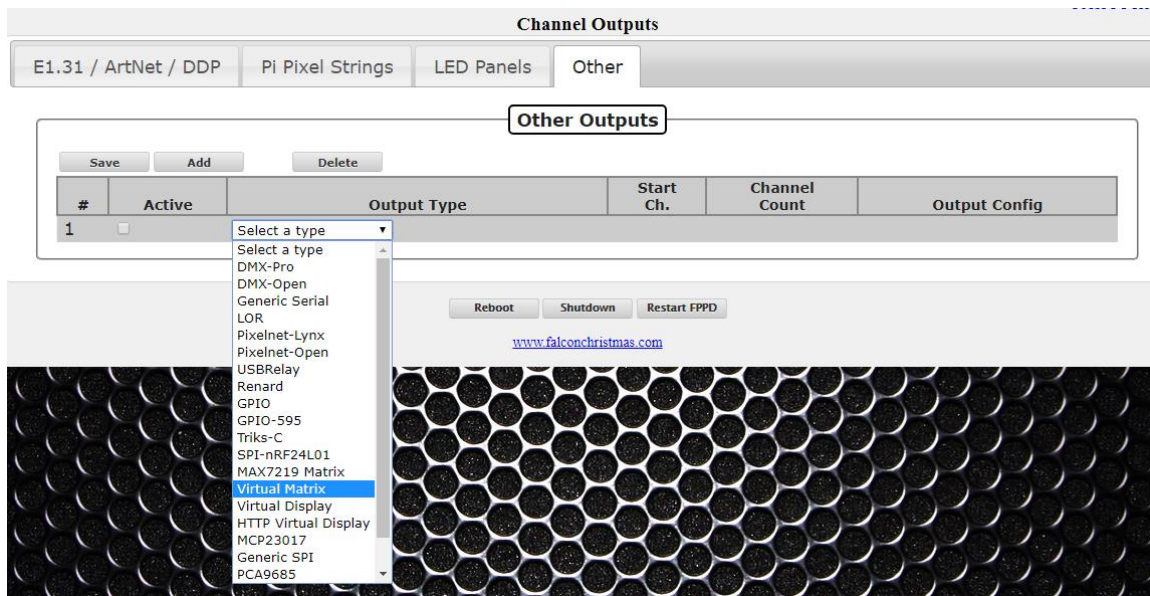

- Select the Virtual Matrix type and enter the following options:
  - Active box- Make sure this is checked
  - Start Channel- Enter the channel you noted in xLights that your matrix starts at (in this example it is 3073.)
  - Width- Enter the width of the matrix you created in xLights (for this example we are using 192.)
  - Height- Enter the height of the matrix you created in xLights (for this example we are using 112.)
  - Color Order- Leave it at the default RGB.
  - Port- Leave this at the default of fb0.
  - Click on Save
  - Click on the Restart FPPD in the red banner.



- Configure FPP to output your HDMI.
  - Go to the Status/Control>Settings page. Make sure the Default Video Output device is set to HDMI.

You can now create sequences in your scheduling software and it will play on the HDMI port on your Raspberry Pi to your TV/Monitor or through a projector.

## Playing Video

Besides playing video as part of a sequence file there are two basic ways of directly playing a video through the HDMI port on your Raspberry Pi. In either case you have to configure FPP to output your HDMI. The advantage of playing a video directly is that you can get a higher resolution. The biggest disadvantage is that the video might not be synched exactly with your audio file.

Go to the Status/Control>Settings page. Make sure the Default Video Output device is set to HDMI.

- Syncing the video to the Sequence being played.
  - On a Raspberry Pi running in Master or Standalone Mode
    - Create your playlist in FPP using the video file as the audio source.-If you didn't use the same video file as the audio source in your sequencing software then there is a possibility that the video timing won't match the sequence.
    - **When the video first starts, it might be slightly out of sync but will get in sync in usually less than a second or two.**
- Starting Video Manually
  - You can start a video manually through several different methods, the video will not be synced to the sequence so the timing might drift a little especially on longer videos. This can be useful if you are playing short video clips but want the higher resolution. If syncing is important and manually triggering the video does not give you the desired results, then you should consider using the video as part of the actual sequence. Here are the different methods of manually starting a video.
    - As a Playlist entry.
    - As an event in a sequence or other event trigger.
    - Through the activation of scripts

## Virtual Display

You can have a TV/monitor display a “live” representation of your show by creating a Virtual Display. This will require a TV/Monitor to be connected to one of your Pi FPP devices via the HDMI port.

- Use FPP Connect in xLights to upload your models and full V2 sequence to the FPP device that you are going to use for your Virtual display.
- Go to the Status/Control>Settings page. Make sure the Default Video Output device is set to HDMI.
- Go to your Channel Outputs and the Other tab and select the Add button.

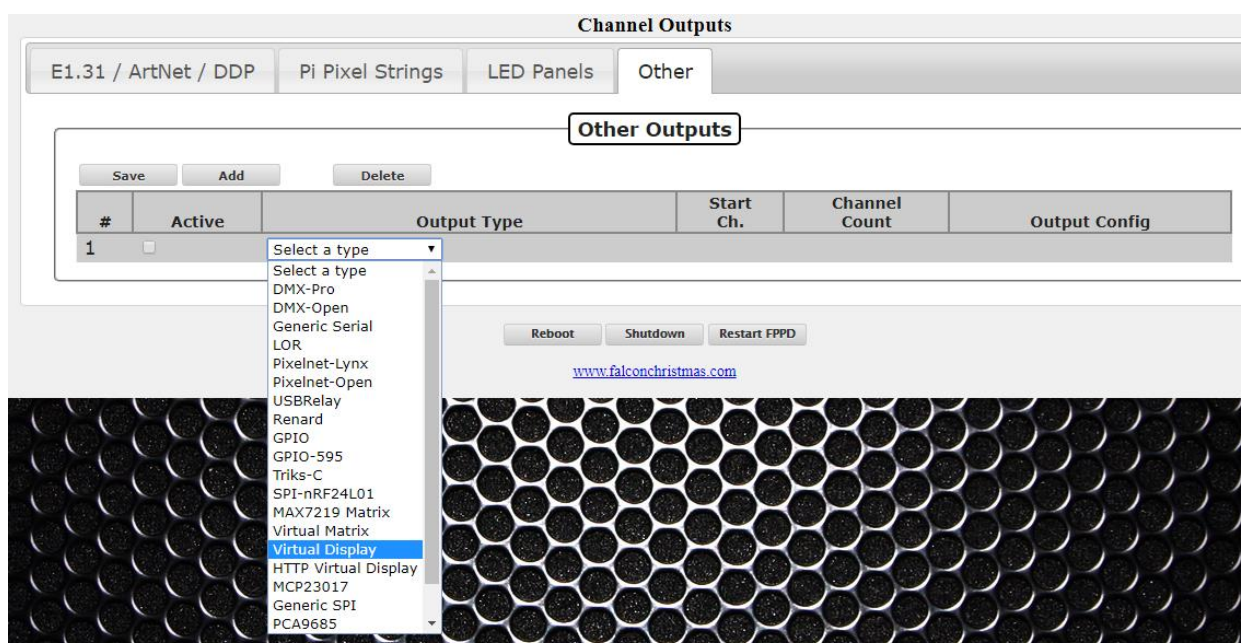



- Select the Virtual Display type and enter the following options:
  - Active box- Make sure this is checked
  - Start Channel- Leave this at the default of 1
  - Width- Leave this at the default of 1280
  - Height- Leave this at the default of 1024
  - Color Order- Leave it at the default BGR.
  - Pixel Size- Leave this at the default of 2
  - Port- Leave this at the default of fb0.
  - Click on Save

Now when your show is running you will get a “live” visual representation on your monitor of your show.

## Booting from eMMC on BeagleBone

Normally, FPP is set up to boot from the uSD card. You should keep the default setting of booting from the uSD Card. If you have special requirements, you can have FPP boot from the internal storage on the BeagleBone **but is not recommended**.

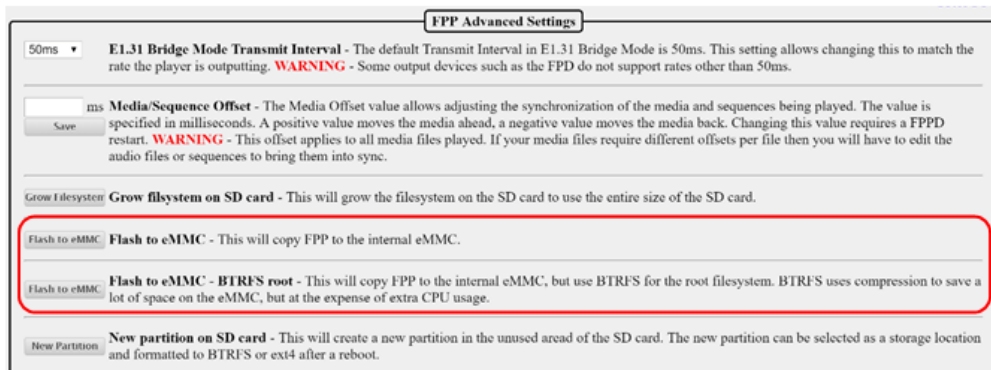

There are two options on the file format that you want the boot system to boot from. You can choose the normal version or the BTRFS. The BTRFS version is a compressed version and will save space, but will impact the CPU performance slightly.

## Using USB for Media Storage

You can use a USB Drive to store your media and sequences. **But this is strongly discouraged as it has been known to cause lagging and other issues.** This isn't really necessary with the price of uSD drives dropping and the better speed that uSD cards provide, but you can use a USB drive to store your media files if you would like but do so at your own risk. The developers will not provide support for problems when using a USB for storing sequences and media.

Go to the Status/Control tab and click on the FPP Settings link then go to the Advanced Settings.

On the Storage Device drop down menu, select your USB device. Once that is selected, you will get this option:

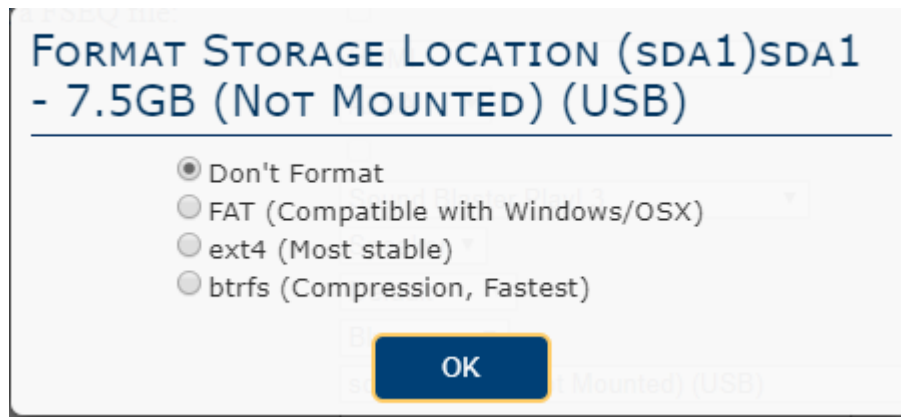

- Don't Format- This will leave any files that are on the USB drive and will not change the USB Partition type.
- FAT (Compatible with Windows/OSX)- This will erase all of the files on the USB drive and then format the partition to be FAT. FAT formatted drives can be read by both Windows and Mac computers.
- ext4- This will erase all of the files on the USB drive and then format the partition to be ext4. ext4 formatted drives can be read by Linux operating systems (FPP is Linux based) Windows and Mac computers cannot natively read ext4 formatted drives.
- btrfs- This will erase all of the files on the USB drive and then format the partition to be btrfs. btrfs formatted drives can be read by Linux operating systems (FPP is Linux based) Windows and Mac computers cannot natively read btrfs formatted drives.

Once the formatting option is selected, FPP will give you the option to copy your FPP files/settings to the USB drive.

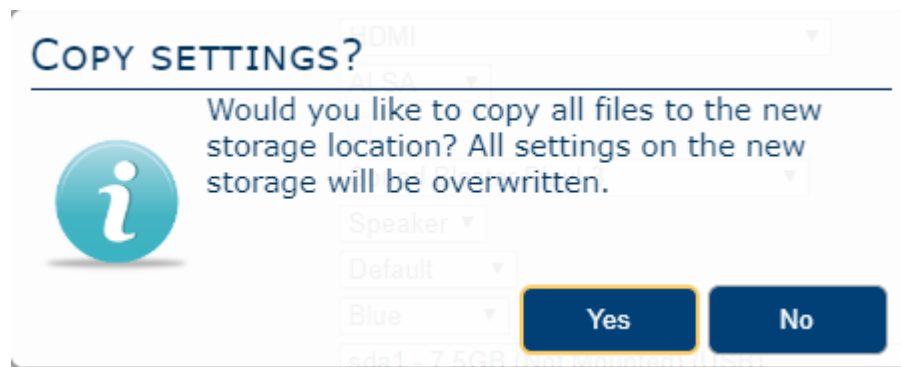

The typical files/settings that are saved on the USB device are your configuration settings, network settings, sequence files, playlists, and media files. This is useful if you need to make a copy of your existing settings and media files onto your USB drive.

## Common Plugins

There are several Plugins available from the FPP install, but you are not limited to those. You can install Plugins from a third party or create your own. Plugins should have installation information on the developer's web page. Some of the more commonly used Plugins are:

- Big Buttons- This Plugin will create a web interface within FPP so that a user can click on one of several buttons that will start a predefined script.
- Matrix Tools- This plugin allows you to control a matrix to add text or a drawing in real time.

- Event Date- This will allow you to generate a dynamic countdown to a specific date and display the results on a matrix. This plugin requires a few other plugins to be installed in order to function properly
  - Message Queue Aggregator for Plugins- This is a repository to store and manage messages so that other plugins can send messages to this plugin for processing at a later time.
  - Message Queue to Matrix Overlay- This plugin will coordinate with the Message Queue Aggregator for Plugins to output the accumulated data.
  - Matrix Tools
- Plugin to download Weather information for Message Queue- This will allow you to get the current weather data for a certain location and display it on a matrix. (This is not functioning on FPP >2.5 and when fixed, the manual will be updated.)

## Big Buttons

The Big Buttons Plugin will create a web page with several buttons so that a user can click on one of the buttons which will activate a predefined script such as starting a playlist or a particular song to name a few of the common scripts. To install the Big Buttons Plugin, go to the Plugin Manager in the Content Setup section of FPP and click the download button.

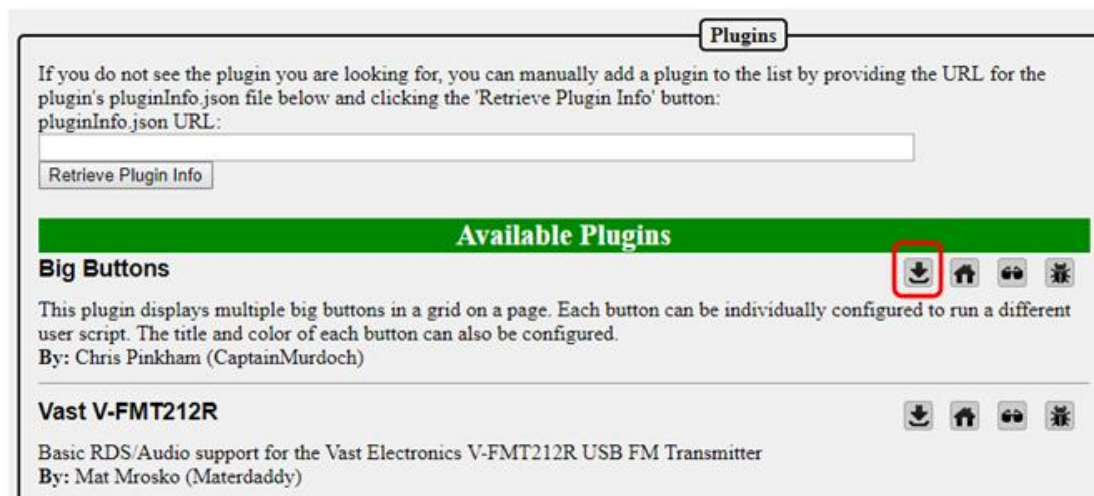

Once the Big Buttons Plugin is installed it will need to be configured. Go to the Content Setup tab and click on the Configure Big Buttons.



By default, you can have up to 20 buttons and each one can start a different script. You can write your own script or download one from the Script Repository. You can set a title for your

Big Button page, select the color for each button, select the text size, and the text for each button.

This will demonstrate creating a four button page where three buttons will play a particular song and the fourth button will play the master playlist. You will need to create three one song playlists for the songs that they can select and you have to create a master playlist. You will need to create four scripts for the actions for each button. I used the pre-installed script from the Script Repository.

Here is the script to start the playlist I created for Mary Did You Know.

```
#!/bin/sh
#####
# StartPlaylist.sh - Start a playlist on the local system #
#
# The Playlist will play once and then stop. #
#####
# Edit this line to hold the playlist name in quotes
PLAYLISTNAME="Mary_Did_You_Know"
# If you want to start on a specific numbered entry in the playlist
# then put the entry number inside the quotes on the line below
STARTITEM=""
fpp -P "${PLAYLISTNAME}" ${STARTITEM}.
```

Note: This is a simple script and will immediately start the selected playlist, if you want the playlist that is playing to end gracefully, then you will have to modify the script accordingly.

1. Add a page title.
2. Select the font size.
3. Enter the description for the first button.
4. Select the predefined script to start the selected song.
5. Select the color for the button.
6. Repeat for the other 2 buttons
7. Enter the description for the fourth button.
8. Select the predefined script to play the master playlist.
9. Select the color for the button.

Note: There is no Save button, once you enter the information, it is saved.

Big Buttons Config

Button Page Title:

Text Font Size:

Button #01	Description: <input type="text" value="Play Mary Did You Know"/>
	Script: <input type="text" value="StartMaryDidYouKnow.sh"/>
	Color: <input type="text" value="blue"/>
Button #02	Description: <input type="text" value="Play Let It Snow"/>
	Script: <input type="text" value="StartLetItSnow.sh"/>
	Color: <input type="text" value="coral"/>
Button #03	Description: <input type="text" value="Play Christmas Sharks"/>
	Script: <input type="text" value="StartChristmasSharks.sh"/>
	Color: <input type="text" value="darkcyan"/>
Button #04	Description: <input type="text" value="Play Master Playlist"/>
	Script: <input type="text" value="StartMasterPlaylist.sh"/>
	Color: <input type="text" value="green"/>
Button #05	Description: <input type="text"/>
	Script: <input type="text" value="-- Choose a Script --"/>
	Color: <input type="text" value="-- Choose a Color --"/>

To load the page, go to the Status/Control section and select the Big Buttons Plugin

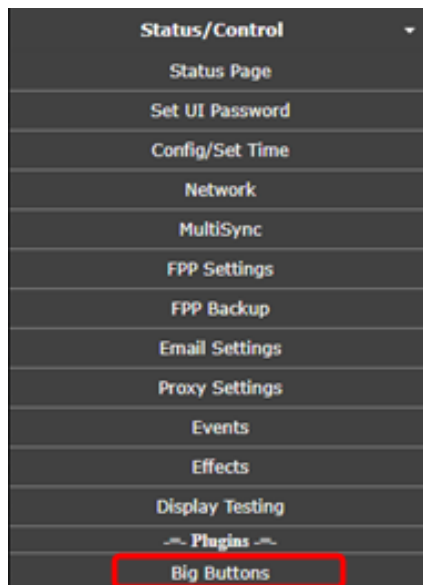

You will get a screen similar to this:



Clicking on the button will start the selected playlist. The button will momentarily change color when clicked to indicate it was pressed. The buttons can control just about anything in FPP as long as you can write a script for it.

## Matrix Tools

The Matrix Tools Plugin will allow a user to display text and or draw on a matrix in real time. Other Plugins can use the Matrix Tools as well to draw on the matrix. To install the Matrix Tools Plugin, go to the Plugin Manager in the Content Setup section of FPP and click the download button.

The screenshot shows the 'Available Plugins' section of the FPP interface. It lists three plugins: 'Vast V-FMT212R', 'Big Green Button', and 'Matrix Tools'. The 'Matrix Tools' plugin is highlighted with a red box around its download button. The download button is a small icon of a downward arrow.

In order to use the Matrix Tools, you need to create a Pixel Overlay Model for your matrix. You can manually enter this in the Input/Output Setup section of FPP or export your models from xLights. Make sure that the channel numbers are correct in the Channel Outputs>LED Panels and the Pixel Overlay model.

The screenshot shows the 'LED Panels' configuration section in FPP. The 'Start Channel' and 'Channel Count' fields are highlighted with a red box. The 'Start Channel' is set to 11265 and the 'Channel Count' is set to 13824. Other settings include 'Enable LED Panel Output' (checked), 'Panel Layout' (3x3), 'Single Panel Size' (32x16 1/8 Scan), 'Model Start Corner' (Top Left), 'Brightness' (5), 'Panel Gamma' (2.2), 'Panel Interleave' (Off), 'Color Depth' (8 Bit), and 'Connection' (Hat/Cap/Cape).

The screenshot shows the 'Pixel Overlay Models' section in FPP. The 'Start Ch.' and 'Ch. Count' columns are highlighted with a red box. The table below shows the configuration for a model named 'Tune\_to\_sign'.

Model Name	Start Ch.	Ch. Count	Orientation	Start Corner	Strings	Strands
Tune_to_sign	11265	13824	Horizontal	Top Left	48	1

Once the Matrix tools are installed and you have the Pixel Overlay Model configured, you can open the Matrix Tools from the Status/Control section of FPP.

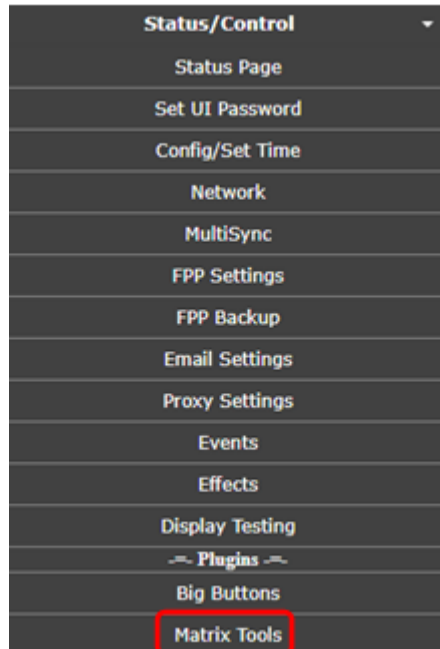

You will get a screen similar to this:

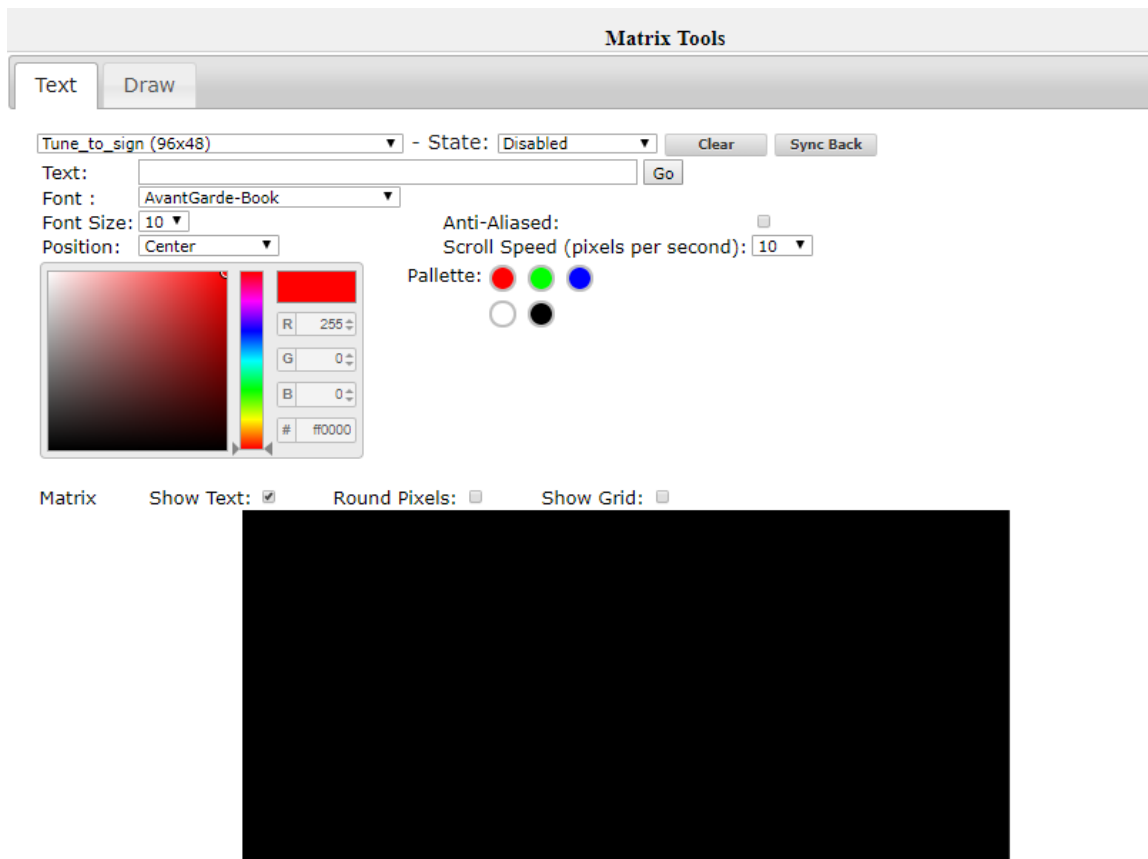

If you have more than one Pixel Overlay Model configured on this FPP then you will have to select the Pixel Overlay Model for your matrix in the first box. There are two tabs to use for the Matrix Tools, Text and Draw. Text allows you to type text and show that on the matrix

with several options to display the text. The Draw tab allows you to directly draw on the matrix. You can have text displayed and draw on the Pixel Overlay Model.

Both tabs share:

- Pixel Overlay Model- This will list all of your Pixel Overlay models; choose the model that you want to display the live data.
- State- There are four different states
  - Disabled- This is the inactive state for the Matrix tools
  - Enabled- This will stop all other data going to your Pixel Overlay Model and display only the data from the Matrix Tools.
  - Transparent- This will not stop other data coming into the Pixel Overlay Model and will display the Matrix Tools data at the same time. This will combine the channel data so will not display RGB colors correctly. This is only recommended for single color matrices.
  - Transparent RGB- This will not stop the other data coming into the Pixel Overlay model and any Matrix Tools data will override the other data being displayed and this is the recommended setting if you want to display the Matrix Tools data over the other incoming data.
- Clear- This will clear any Matrix Tools data that is displaying on the Pixel Overlay Model.
- Sync Back- This will synchronize the data that is displaying on your Pixel Overlay model, not just the Matrix Tools data. **This is not recommended as it very CPU and web interface intensive and will slow everything down.**
- Color Picker- You can select the color using various methods in the color picker. You can click in the Hue slider to get the approximate color and then select the exact shade in the main window, enter the RGB value or enter the hexadecimal value for the color.
- Palette- You can select some of the basic colors which will in turn update the color picker to the palette color you selected.
- Preview screen- This will show you an approximation of how your text is displaying. You can change the appearance on the Preview Screen to be round or square pixels and you can show a grid to indicate the positions of all the pixels

The Text tab displays:

- Text- Type the text that you want to display.
- Go- After you have entered all of the attributes for the text to display, press the go button to display the text.
- Font- Select the type of font that you want the text to display.
- Font Size- Select the size of the font for the text to display.
- Position- You can select where you want the text to display, either centered, or scroll from left to right, right to left, bottom to top or top to bottom.
- Anti-Aliased- This will add shading to help eliminate the sharp edges.
- Scroll Speed- Sets the speed at what the text will scroll if you select one of the scrolling options.

The draw tab displays an auto fill and block fill option to fill the entire Pixel Overlay Model. To draw on the Preview screen, left click and hold down the mouse button and draw your desired design.



# Message Queue Aggregator for Plugins

The Message Queue Aggregator for Plugins is a helper plugin used to store and manage messages from other Plugins. To install the Message Queue Aggregator for Plugins, go to the Plugin Manager in the Content Setup section of FPP and click the download button.

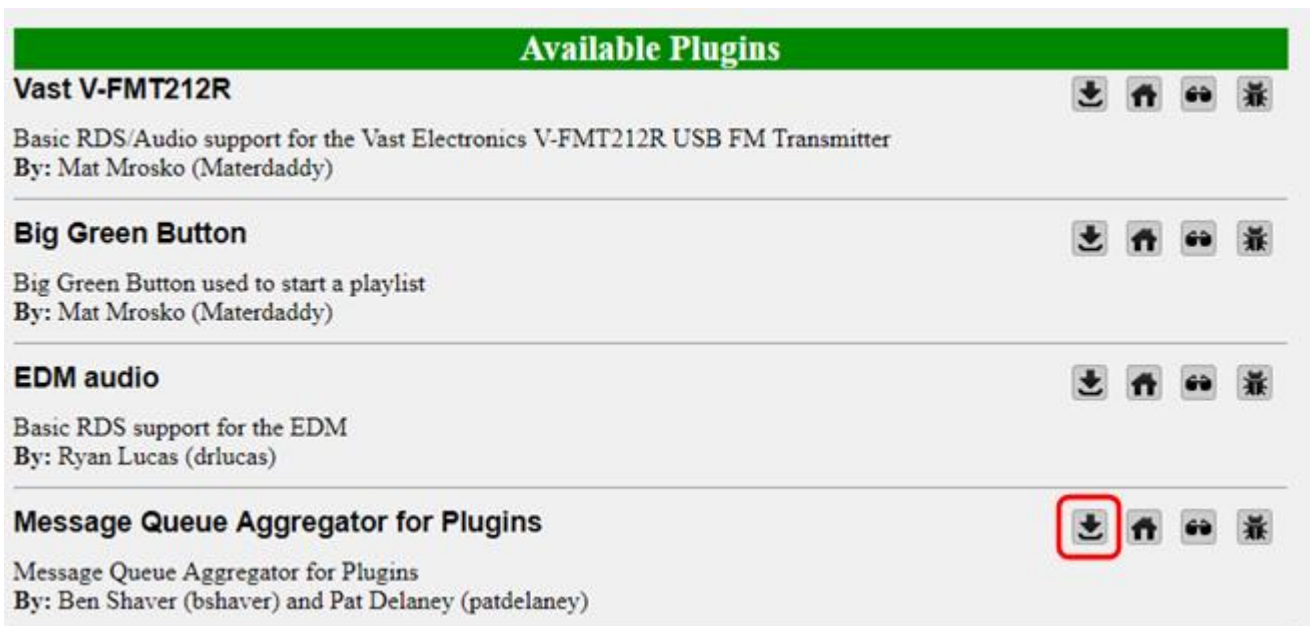

The screenshot shows a list of available plugins under the heading "Available Plugins". The list includes:

- Vast V-FMT212R**: Basic RDS/Audio support for the Vast Electronics V-FMT212R USB FM Transmitter. By: Mat Mrosko (Materdaddy).
- Big Green Button**: Big Green Button used to start a playlist. By: Mat Mrosko (Materdaddy).
- EDM audio**: Basic RDS support for the EDM. By: Ryan Lucas (drlucas).
- Message Queue Aggregator for Plugins**: Message Queue Aggregator for Plugins. By: Ben Shaver (bshaver) and Pat Delaney (patdelaney).

The download icon for the "Message Queue Aggregator for Plugins" is circled in red.

Once it is installed, you will have to go to the MessageQueue Plugin page from the Input/Output Setup section in FPP.

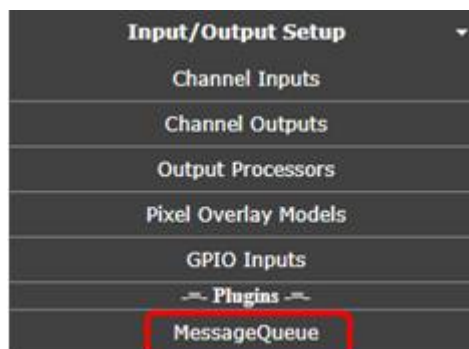

The screenshot shows the "Input/Output Setup" menu with the following options:

- Channel Inputs
- Channel Outputs
- Output Processors
- Pixel Overlay Models
- GPIO Inputs
- Plugins —
- MessageQueue

The "MessageQueue" option is highlighted with a red box.

On this page you have to enable the plugin to activate it. You can manually delete any messages that are stored in the database from this page if you want. You can change the message database file path but it is not recommended to do so.

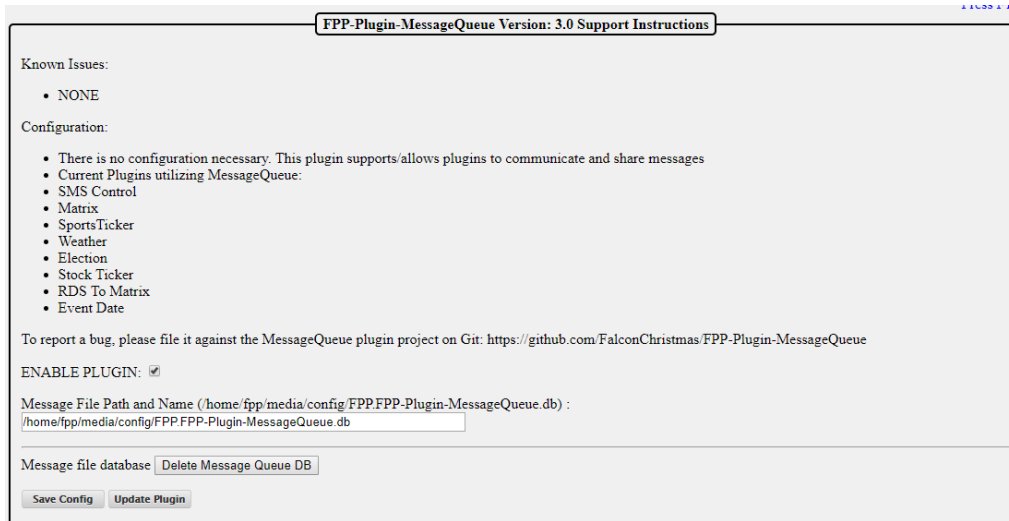

## Message Queue to Matrix Overlay

The Message Queue to Matrix Overlay Plugin is another helper plugin and it is used to read the messages in the Message Queue Aggregator Plugin and display the data when it is requested from another Plugin. To install the Message Queue to Matrix Overlay, go to the Plugin Manager in the Content Setup section of FPP and click the download button.

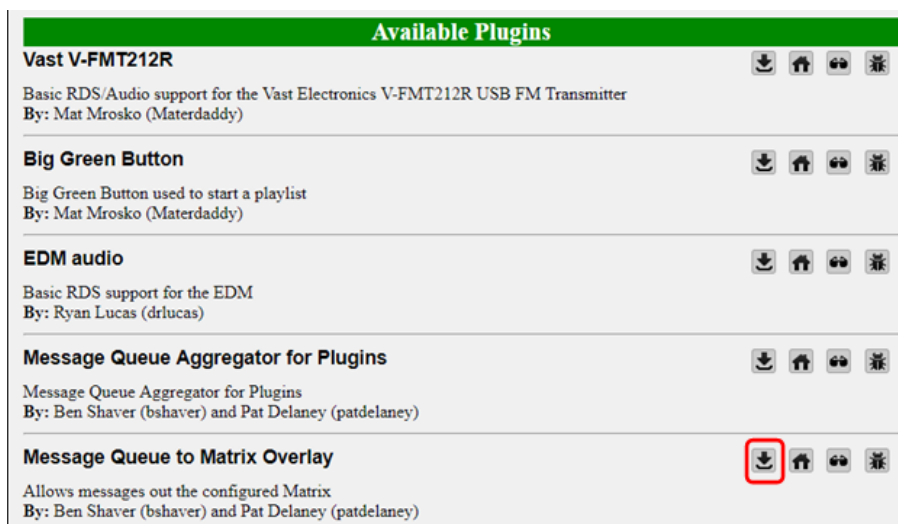

Once it is installed, you will have to go to the MatrixMessage Plugin page from the Input/Output Setup section in FPP.

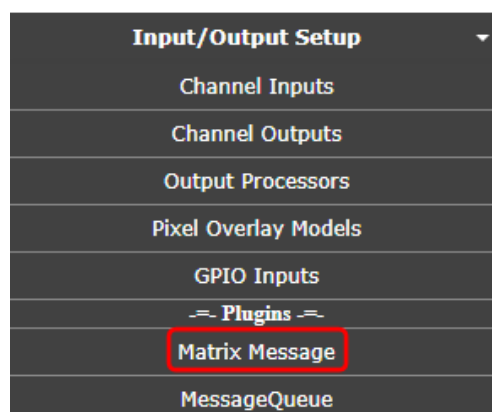

From this page, there are several configurations

FPP-Plugin-Matrix-Message Version: 2.5 Support Instructions

Known Issues:

- NONE

Configuration:

- This plugin allows you to use the fpp-matrixtools plugin to output messages from the MessageQueue system
- Select your plugins to output to your matrix below and click SAVE
- Configure your Matrix first before selecting here

ENABLE PLUGIN:

Matrix Name:

Overlay Mode: 1 = FULL OVERLAY, 2 = TRANSPARENT, 3 = Transparent RGB |

Include Time:  Time Format:  Hour Format:

Include Plugins in Matrix output:

Font:

Font Size:   Anti-Aliased

Pixels per second:

Color: (#RRGGBB or common name 'red' or for a random color type 'random')

To report a bug, please file it against <https://github.com/LightsOnHudson/FPP-Plugin-Matrix-Message> git

You need to configure the following settings:

- Enable Plugin- This needs to be checked to make the plugin active.
- Matrix Name- This is the Pixel Overlay Model that is your matrix.
- Overlay Mode- This is the setting from the Matrix tools on how to display the message. Select the number that corresponds to the effect you want. Full Overlay is the most common.
  - Full Overlay will block all other data being sent to the matrix.
  - Transparent will not stop other data coming into the Pixel Overlay Model and will display the Matrix Tools data at the same time. This will combine the channel data so will not display RGB colors correctly. This is only recommended for single color matrices.
  - Transparent RGB will not stop the other data coming into the Pixel Overlay model and any Matrix Tools data will override the other data being displayed and this is the recommended setting if you want to display the Matrix Tools data over the other incoming data.
- Include Time- If this box is checked, the when the messages are displayed, it will include the current system time so make sure you have an NTP or Real Time Clock configured.
- Include Plugins in Matrix Output- Select the plugins that are sending information to the Message Queue and that you want to display on your matrix. To select more than one plugin, hold down the Ctrl key and click each additional plugin that you want to manage.
- Font- Sets the font style that you want to display.
- Font Size- Sets the font size that you want to display.
- Anti-aliased- Will try to eliminate the jaggy edges on some fonts by applying shading.
- Pixels per Second- The speed that the message will scroll across the matrix.
- Color- The color for the displayed text. You can use the hexadecimal color notation or the common color name.
- Save Config- Will save the current configuration.
- Update Plugin- You can update the plugin if there is one available.
- Font Management- You can install other fonts if you need to from this function.

## Event Date

The Event Date Plugin will allow your matrix to display a dynamic countdown to a particular event. You can have other text included with the countdown if you desire. The Event Date Plugin needs 3 other plugins installed and configured in order to work correctly.

- Message Queue to Matrix Overlay
- Message Queue Aggregator for Plugins
- Matrix Tools

To install the Event Date Plugin, go to the Plugin Manager in the Content Setup section of FPP and click the download button.

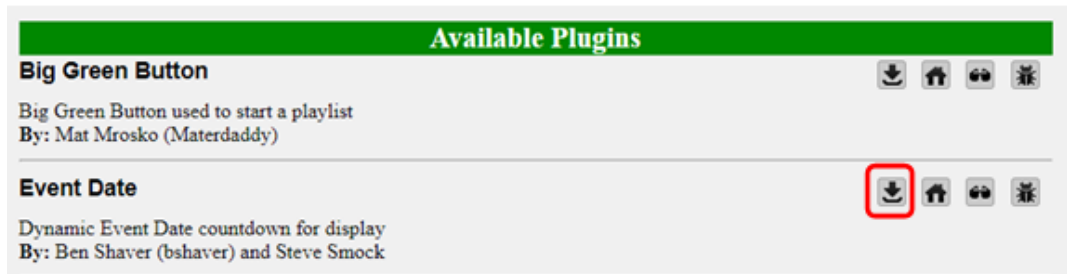

Once it is installed, you will have to go to the Event Date Plugin page from the Input/Output Setup section in FPP.

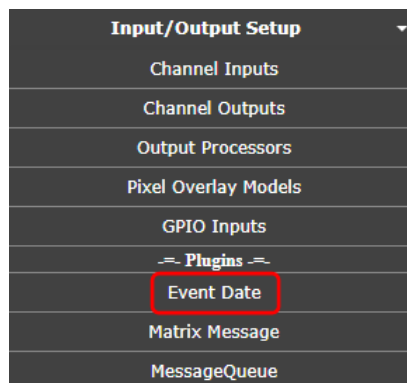

You need to configure the following settings:

FPP-Plugin-EventDate Version: 3.0 Support Instructions

Known Issues:

- None

Configuration:

- Configure the date and time of your event
- Enter in the PRE TEXT that will appear before your countdown
- Configure 12 or 24 hour countdown mode
- Schedule the event in your Playlist to send the countdown out your Matrix

**This plugin requires ACCURATE time for its calculation. Please ensure RTC is working properly**

ENABLE PLUGIN:

Pre Text: (It is):

EVENT DATE:    Hour:  Min:

Post Text: (Until):

Event Name: (Christmas, Halloween, Labor day):

If Remaining time >= 1 day, include:

Include Hours:

Include Minutes:

Will appear as:

It is 139 days until THE EVENT!

---

Immediately output to Matrix (Run MATRIX plugin):

MATRIX Message Plugin Location: (IP Address. default 127.0.0.1):

To report a bug, please file it against the sms Control plugin project on Git:<https://github.com/FalconChristmas/FPP-Plugin-EventDate.git>

You need to configure the following settings:

- Enable Plugin- This needs to be checked to enable the plugin.
- Pre Text- Enter the text that you want to display before the countdown date.
- Event Date- Enter the date of the event.
- Post Text- Enter the text that you want to display after the countdown date.
- Event Name- Enter the name of the event that you are counting down.
- If Remaining time >= 1 day include.
  - Include Hours-
  - Include Minutes-

On the last day, the countdown will display the hours and minutes to the event, you can include the hours and minutes for the entire countdown by checking this box.

- Will appear as- This shows how the display will look.
- Immediately output to Matrix- If this box is checked, anytime the EventDate plugin is triggered, the message will be displayed on the matrix. If it is not checked, then the EventDate data will be stored until it is displayed using the RUN-MATRIX.sh script.
- Matrix Message Plugin Location- By default the IP address is 127.0.0.1 which is the loopback address of the Pi and should not be changed unless you are using some advanced configurations.
- Save Config- This will save the changes that you have made to the Plugin.
- Update Plugin- This will check for updates to the Plugin and install them.

To use the EventDate Plugin you have to run the RUN-COUNTDOWN-SCRIPT.sh script that is in the Script section of the File Manager (you will need to have the “Immediately Output to Matrix” checked). This is usually accomplished by incorporating the RUN-COUNTDOWN-SCRIPT.sh in a playlist but it can be triggered manually, through events or any other method that can trigger a script.

**Playlist Details**

Event\_Date\_Test Save Delete  
Copy Playlist Randomize Playlist Info:  
Total Duration: 06m:06s  
Total Items: 2 (In Main)

(To rename edit name and click 'Save')

---

**New Playlist Entry**

Type: Media and Sequence  Auto-Select Matching Media/Sequence  
 Media: 15 - The 12 Days of Christmas.mp3 Video Output: Default  
 Sequence: 12 Days.fseq

#	Type	Media File / Script / Event / Pause	Sequence / Delay / Data
-- Lead In --			
-- Main Playlist --			
1.	Seq/Med	06 - Mary Did You Know_.mp3	Mary Did You Know.fseq --Default--
2.	Script	RUN-COUNTDOWN-SCRIPT.sh	Wait
3.	Seq/Med	15 - The 12 Days of Christmas.mp3	12 Days.fseq --Default--
-- Lead Out --			

A script does not act like a sequence, it is just a trigger so if you have a sequence playing after running the script, then you will need to indicate in the playlist to wait for the script to complete before starting the next item in the playlist.

**New Playlist Entry**

Type: Script  
 Script: RUN-COUNTDOWN-SCRIPT.sh  Wait For Completion  
 Arguments:

#	Type	Media File / Script / Event / Pause
-- Lead In --		
-- Main Playlist --		
1.	Seq/Med	06 - Mary Did You Know_.mp3
2.	Script	RUN-COUNTDOWN-SCRIPT.sh

## Projector Control

If you use a Projector in your display and it supports controlling remotely through a serial or Ethernet port. If your projector uses a serial port for remote control, then you will need a USB to Serial adapter.

**Projector control Support Instructions**

Known Issues:

- NONE

Configuration:

- Configure your connection type, IP/PJLINK, Serial

VER: 1.0  
 ENABLE PLUGIN:

Connection type: SERIAL  
 SERIAL DEVICE:  
 Projector: PJLINK  
 Baud Rate:  
 CHAR BITS:  
 STOP BITS:  
 Parity (none, even, odd):  
 PJLINK IP:  
 PJLINK PASSWORD:

To report a bug, please file it against the Projector Control plug-in project on Git: <https://github.com/FalconChristmas/FPP-Plugin-Projector-Control>

You will need to configure the plugin for the projector you are using; this information is usually available in the user manual for your projector.

- Enable Plugin- check this box to enable the plugin.
- Connection type- Select the connection type that you are going use for your communication.
- Serial Device- If your connection type is Serial, you will have to select the Serial device that you are going to use. (normally you will only have one Serial device to select from)
- Projector- Many projectors support the PJLINK protocol, if your projector supports PJLINK you can select that, if not then select your projector from the drop down list.
- Baud Rate- Enter the Baud Rate that your projector utilizes. (9600 and 19200 are the most common.)
- CHAR BITS- Enter the CHAR BITS (the most common is 8).
- STOP BITS- Enter the STOP BITS (the most common is 1).
- Parity- Enter the Parity value (the most common is none).
- PJLINK IP- Enter the PJLINK IP address for your projector.
- PJLINK Password- Enter the PJLINK Password for your projector (if there is one).

After entering your information, click on the Save button.

The Projector Control plugin will generate several Events and Scripts that you can use to control your projector.

## Plugin Development

If you want to develop a plugin, then you can go to the Plugin Manager in the Content Setup section of FPP.

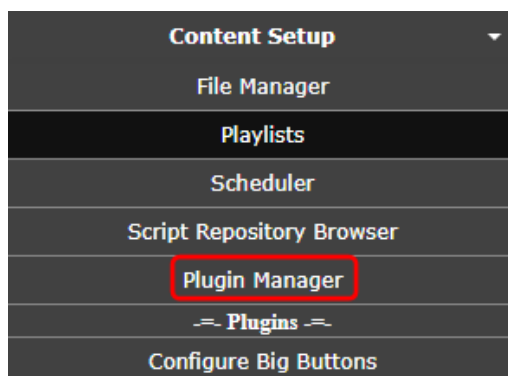

On this page is a Plugin template that has a shell for all the components that you will need to incorporate a plugin into FPP.

### Template Plugin

#### Template Plugin for FPP Plugin developers

This template plugin is designed to make it easier for plugin authors to create new FPP Plugins. You can manually clone the git repository or install the Template Plugin and then go to the plugin's config page and use the form to copy the template into a new plugin directory.

By: John Doe (jdoe)

The best method is to go to the website for the template and clone the files into a GitHub repository of your own. Clicking on the Source Code or Home buttons will take you to the GitHub repository for the Template Plugin.

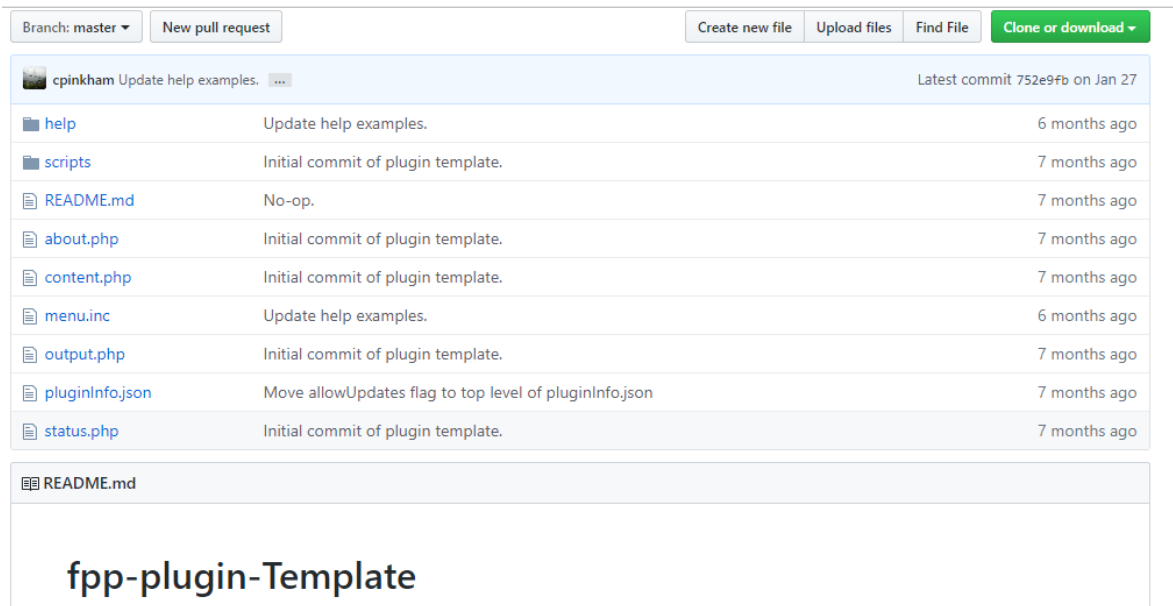

The screenshot shows a GitHub repository page for 'cpinkham Update help examples.' The repository is on the 'master' branch. The file list includes:

File Name	Description	Last Commit
help	Update help examples.	6 months ago
scripts	Initial commit of plugin template.	7 months ago
README.md	No-op.	7 months ago
about.php	Initial commit of plugin template.	7 months ago
content.php	Initial commit of plugin template.	7 months ago
menu.inc	Update help examples.	6 months ago
output.php	Initial commit of plugin template.	7 months ago
pluginInfo.json	Move allowUpdates flag to top level of pluginInfo.json	7 months ago
status.php	Initial commit of plugin template.	7 months ago

The README.md file is open, showing the title 'fpp-plugin-Template'.

The template has the following files and it is recommended to follow this file structure:

- Help- This is a folder to hold the relevant help files for your plugin and it is highly recommended to document the installation, configuration and operation of your plugin. The Help files will be available to the user when they hit the F1 key or click the “Press F1 for Help” link at the top of your page. The file name for your Help file needs to match the file name for the page it is related to, but you are not limited to the suggested files. You can have pages with a different file name, you will need to include a matching help file with the same file name The Help folder has the following files and if you don’t have a page with a matching name, then you can (not mandatory) delete the file.
  - content.php- This will have the help information, formatted in html, for your content.php file in the main directory.
  - help.php- This will have the help information, formatted in html, for your help.php file in the main directory.
  - output.php- This will have the help information, formatted in html, for your output.php file in the main directory.
  - status.php- This will have the help information, formatted in html, for your status.php file in the main directory.
- Scripts- This is a folder to hold scripts needed for your Plugin. There are some scripts that will run automatically at the appropriate time. These do not get saved in the Script folder in FPP. If there are scripts that the user will need to use, the Plugin author will need to copy those scripts into the FPP scripts folder, usually this can be accomplished by adding the copy routine in the fpp\_install.sh file. The Scripts that run automatically are:
  - fpp\_install.sh- This script will run when the user installs the plugin. If there are any special requirements for your plugin such as scripts or other files to be copied in the correct place, this might be the place to perform those functions.
  - fpp\_uninstall.sh- This script will run when the user uninstalls the plugin. If you created any special files and they are not needed for any other application, then you can delete these and perform any other cleanup functions in this script.



- postStart.sh- This script will run after fppd starts. If your plugin needs any processes to run prior to the user accessing your plugin, this is where you should put these functions.
- postStop.sh- This script will run after fppd stops and can be used for any cleanup processes.
- preStart.sh- This script will run right before fppd starts.
- preStop.sh- This script will run right before fppd stops.
- README.md- This file is used to display relevant information in regards to your plugin and will be displayed in the GitHub main page for your plugin. If your plugin requires another plugin to function, you might want to include it here as well.
- about.php- If you want to have an about informational page for your plugin, then you can use this template to display your about webpage. You will need to provide a link to it.
- content.php- This is a placeholder file for demonstration purposes. You can name your plugin file(s) anything you want, just make sure you link them properly in the menu.inc file.
- menu.inc- This file is required to provide navigation for your plugin.
- output.php- This is a placeholder file for demonstration purposes. You can name your plugin file(s) anything you want, just make sure you link them properly in the menu.inc file.
- pluginInfo.json- This is a required file.
- status.php- This is a placeholder file for demonstration purposes. You can name your plugin file(s) anything you want, just make sure you link them properly in the menu.inc file.

Once your plugin has been created, you can load your plugin by following the instructions for Retrieving Plugin Info in the Plugin page. If you would like to have your plugin available to other users, post the information in the Plugin section of the Falcon Christmas forum and if approved, a link will be added to the Available Plugins section.

# Resources

## Help

There are several resources available for help, here are a few of the more popular help resources are:

<http://falconchristmas.com/forum/> -This forum is very active and you can usually get a response fairly quickly.

<http://auschristmaslighting.com/forums/> -This forum is also very active and you can usually get a response fairly quickly. You don't have to be from Australia to post here.

<https://auschristmaslighting.com/> - This is the parent site for the auschristmaslightingforums and there are several resources there, one that is a must have is the AUSManual101.pdf. You need to register it in order to download the manual.

<http://www.xLights.org> This website has links to several resources including a forum. The information is geared towards xLights users but it is not exclusively xLights.

<http://videos.xLights.org/> -This website has several videos on all aspects of the Holiday Lighting hobby.

<https://www.youtube.com/channel/UCby1v6Kbi8AHMkV2yMyF1MQ/featured> - This is the Canispater Christmas YouTube channel and there are many very informational videos.

<https://zoom.us/j/175801909> - This website will take you to a live video conference site. They have xEssential training classes every Wednesday at 8:00 PM Eastern time, but there is usually someone there most of the time and is a good way to get instant help. You will have to install the software the first time you go to the website.

## Configuring a Static Route

If your network configuration is utilizing more than one subnet, then you will probably need to configure a Static Route. This can be accomplished in a few different methods and depends on the operating system you are using.

The examples below assume that your home/show router has an IP address of 192.168.0.1 and you are connecting your FPP to your home/show network via Wi-Fi and to your controller via Ethernet. Your controller needs to have an IP on a different subnet than your home/show network, for this example we will use 192.168.101.2. The FPP will need an IP address on the wlan0 interface in the same network as the home/show router, we will use 192.168.0.101 and it will need an IP address on the eth0 interface in the same subnet as the controller, we will use 192.168.101.1

Static Routing in router- Not all routers support static routing but most of them do and this is the preferred method. By adding a static route in your router, all devices connected to your network will have access to your controllers. Due to the large number of router manufacturers and the interfaces they use, the method could be different. The Static Routing is usually in an advanced section of the router and called Routing, Advanced Routing, Static Routing, etc. They will be similar to this:

+ Add - Delete

<input type="checkbox"/>	ID	Network Destination	Subnet Mask	Default Gateway	Interface	Description	Status	Modify
--	--	--	--	--	--	--	--	--

Network Destination:

Subnet Mask:

Default Gateway:

Interface: LAN ▼

Description:

Enable This Entry

Cancel
Save

- Network Destination- Enter the subnet of your controller, in this case it will be 192.168.101.0 (note the last number is 0 and NOT the address of the controller.)
- Subnet Mask- Enter 255.255.255.0
- Default Gateway- Enter the IP address of the wlan0 interface on the connected FPP, in this case it will be 192.168.0.101.
- Interface- This option might not be available, use LAN if it is an option.
- Description- This option might not be available, if it is enter a description about this route.

Static Routing in Computer - You can enter a static route into your computer. By adding a static route in your computer, only that computer will have access to your controllers. You can add a static route to more than one computer if needed. Window and Mac computers have different methods.

- Windows- Open a command prompt window (as an administrator) and based on the example given enter:  
`route -p add 192.168.101.0 mask 255.255.255.0 192.168.0.101`
- Mac- Open a Terminal window and based on the example given enter:  
`sudo route add 192.168.101.0/24 192.168.0.101`  
 (Note: The route add function in Macs are not persistent so if the computer is turned off or rebooted, the route will need to be added again)

Creating a Proxy Host- You can use an FPP device to route network traffic between subnets by setting the FPP as a Proxy Host. This can be useful if you are unable to create a static route in your router and using a Mac computer (since the Mac doesn't support persistent routes.) You can use a Proxy Host with Windows computers as well. See [Proxy Settings](#) for more information.

# GPIO Button Input

You can use one of the available GPIO buttons to trigger an event. In order to do so, you will need to identify which pins are actually GPIO pins. Here are the pinout diagrams of the more common SBCs used. Make sure you confirm the GPIO pins of the SBC you are using before making your connections and always make connections with the power disconnected.

Raspberry Pi 3 GPIO Header

Pin#	NAME	NAME	Pin#
01	3.3v DC Power	DC Power 5v	02
03	GPIO02 (SDA1 , I <sup>2</sup> C)	DC Power 5v	04
05	GPIO03 (SCL1 , I <sup>2</sup> C)	Ground	06
07	GPIO04 (GPIO_GCLK)	(TXD0) GPIO14	08
09	Ground	(RXD0) GPIO15	10
11	GPIO17 (GPIO_GEN0)	(GPIO_GEN1) GPIO18	12
13	GPIO27 (GPIO_GEN2)	Ground	14
15	GPIO22 (GPIO_GEN3)	(GPIO_GEN4) GPIO23	16
17	3.3v DC Power	(GPIO_GEN5) GPIO24	18
19	GPIO10 (SPI_MOSI)	Ground	20
21	GPIO09 (SPI_MISO)	(GPIO_GEN6) GPIO25	22
23	GPIO11 (SPI_CLK)	(SPI_CE0_N) GPIO08	24
25	Ground	(SPI_CE1_N) GPIO07	26
27	ID_SD (I <sup>2</sup> C ID EEPROM)	(I <sup>2</sup> C ID EEPROM) ID_SC	28
29	GPIO05	Ground	30
31	GPIO06	GPIO12	32
33	GPIO13	Ground	34
35	GPIO19	GPIO16	36
37	GPIO26	GPIO20	38
39	Ground	GPIO21	40

Beaglebone Black Pinout Diagram

P9			P8		
Function	Physical Pins	Function	Function	Physical Pins	Function
DGND	1 2	DGND	DGND	1 2	DGND
VDD 3.3 V	3 4	VDD 3.3 V	MMMC1_DAT6	3 4	MMMC1_DAT7
VDD 5V	5 6	VDD 5V	MMMC1_DAT2	5 6	MMMC1_DAT3
SYS 5V	7 8	SYS 5V	GPIO_66	7 8	GPIO_67
PWR_BTN	9 10	SYS_RESET	GPIO_69	9 10	GPIO_68
UART4_RXD	11 12	GPIO_60	GPIO_45	11 12	GPIO_44
UART4_TXD	13 14	EHRPWM1A	EHRPWM2B	13 14	GPIO_26
GPIO_48	15 16	EHRPWM1B	GPIO_47	15 16	GPIO_46
SPI0_CS0	17 18	SPI0_D1	GPIO_27	17 18	GPIO_65
I2C2_SCL	19 20	I2C_SDA	EHRPWM2A	19 20	MMMC1_CMD
SPI0_DO	21 22	SPI0_SCLK	MMMC1_CLK	21 22	MMMC1_DAT5
GPIO_49	23 24	UART1_TXD	MMMC1_DAT4	23 24	MMMC1_DAT1
GPIO_117	25 26	UART1_RXD	MMMC1_DAT0	25 26	GPIO_61
GPIO_115	27 28	SPI1_CS0	LCD_VSYNC	27 28	LCD_PCLK
SPI1_DO	29 30	GPIO_112	LCD_HSYNC	29 30	LCD_AC_BIAS
SPI1_SCLK	31 32	VDD_ADC	LCD_DATA14	31 32	LCD_DATA15
AIH4	33 34	GND_ADC	LCD_DATA13	33 34	LCD_DATA11
AIH6	35 36	AIH5	LCD_DATA12	35 36	LCD_DATA10
AIH2	37 38	AIH3	LCD_DATA8	37 38	LCD_DATA9
AIH0	39 40	AIH1	LCD_DATA6	39 40	LCD_DATA7
GPIO_39	41 42	ECAPWMO	LCD_DATA4	41 42	LCD_DATA5
DGND	43 44	DGND	LCD_DATA2	43 44	LCD_DATA3
DGND	45 46	DGND	LCD_DATA0	45 46	LCD_DATA1

The GPIO pins are in a floating state and you will have to “force” it high (a positive voltage) or low (ground). This is done by connecting a resistor from the GPIO pin to either 3.3V (pulling high) or to ground (pulling low). This can be accomplished through a setting in the FPP GPIO Inputs page or by wiring a resistor in your circuit (**it is not recommended to do both**).

Here are some examples of using an external resistor to pull high or low. If you are using the internal pull up/down configuration then eliminate the resistor in the diagram.

Schematic of external Resistor pulling the GPIO pin high

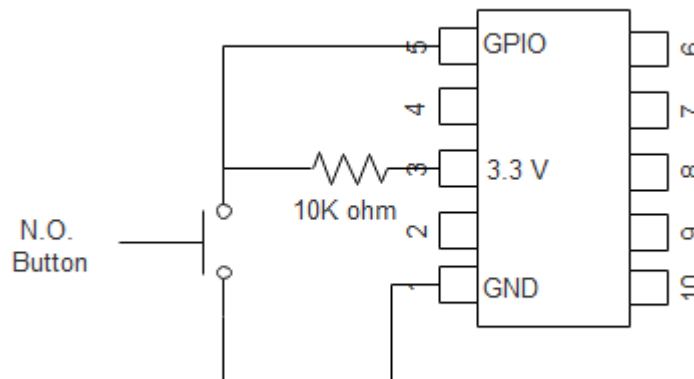

## Schematic of external Resistor pulling the GPIO pin low

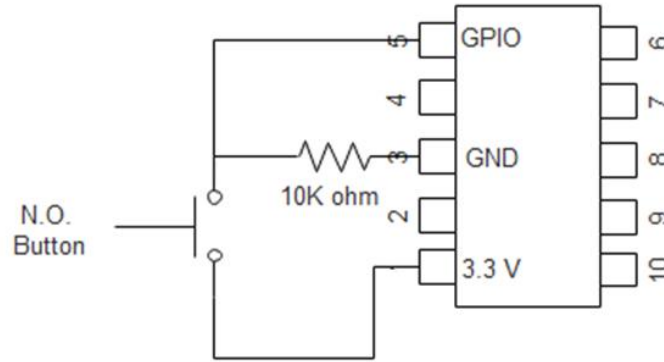

## Graphical example of external Resistor pulling the GPIO 02 pin high.

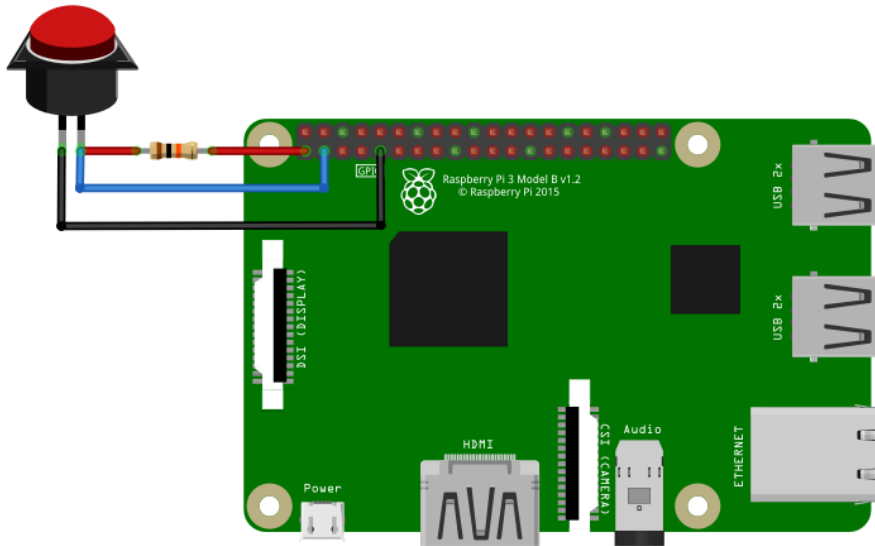

## Graphical example of external Resistor pulling the GPIO 02 pin low.

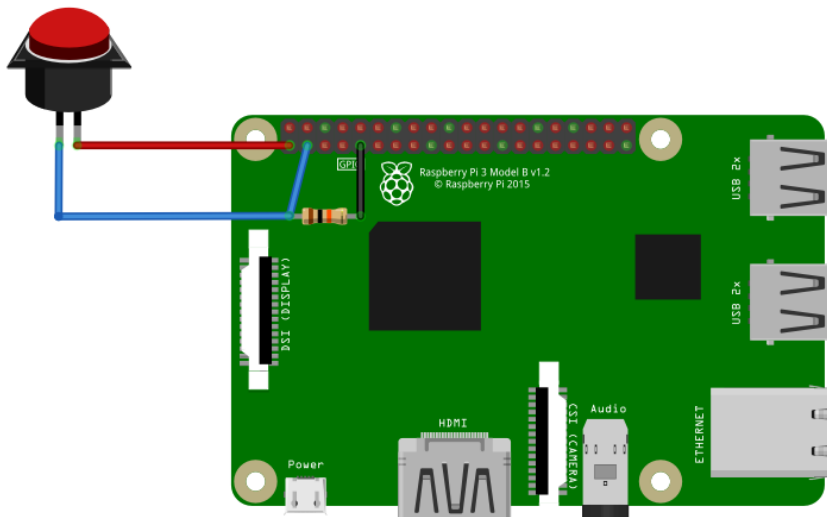

There are 2 basic types of switches, Normally Open (designated NO) and Normally Closed (designated NC) and you need to know which kind of switch you will be using.

Normally Open- These switches will only let electricity flow through it when it is pressed.

Normally Closed- These switches let electricity flow through it until it is pressed and then the flow is stopped.

The GPIO triggers have two trigger types.

Rising Trigger-This is when the voltage on the GPIO pin transitions from ground to a positive voltage (the exact voltage varies but is around 1.3 v.)

Falling Trigger- This is when the voltage on the GPIO pin transitions from a positive voltage towards ground.

The Event Trigger type (falling or rising) will depend on a few factors such as GPIO pulled high or pulled low, switch is normally open or normally closed, and if you want the trigger to be when the button is pressed or released (you can use both triggers, you just need to identify the actions to take for each trigger)

To clarify this, if you have the GPIO pulled high and have a Normally Open button, then pushing the button will trigger a Falling Event and releasing it will trigger a Rising Event.

## Networks

Networks have been troublesome for most of the people getting started in the animated holiday lighting hobby. This is a **very basic overview** and should give you enough information to understand networks and troubleshoot them.

A network is a group of computer devices identified by an IP address. Networks are broken down into groups, typically called subnets. Think of an IP address as a telephone number. In order for devices to be able to communicate with each other, every device needs a “telephone number” (from now on called IP address) and they need to be a unique number. All IP addresses are formatted with 4 groups of numbers, each one separated with a “.” The numbers can only be 0-255. So they would look something like 192.168.110.23 or something similar. The first 3 sets of numbers are like an area code (192.168.110 in 192.168.110.23) and is called a subnet and the last set of numbers is like the “phone” number and is the device number (23 in 192.168.110.23). Only devices on the same subnet (having the same numbers in the first 3 groups) can communicate directly with each other. Any device in your network can communicate **directly** to any other device in your network that is in the same subnet, “area code” just like you can call someone directly by only dialing the 7 digit phone number.

If one device needs to communicate with another device that is on a different subnet, then that is similar to you trying to call someone in a different area/country code. You have to enter some additional “routing” information so the call can be routed to the correct number. When a device on a network receives a request to “call” a device in a different subnet, it does not know how to process the request so it will send the request to a Gateway. A Gateway is similar to an old fashioned operator. The Gateway can be any device that has an IP address but on the same subnet as the device sending the request and the Gateway needs to be able to process the routing of the data. The Gateway is usually your home network router or FPP device that is between a controller and the show network. The Gateway only has a small “phonebook” to know how to route the traffic. If the Gateway receives an IP address that it doesn’t know how to process, it will forward that request to the Gateway it has designated in its settings. Sometimes special instructions need to be given to the Gateway in order for the

signals to get where they need to go and this is commonly done by establishing what is called a Static Route.

You can set up a Static Route in your computer. When you have set up a static route in your computer and your computer is told to send information to an IP address that is in the Static Route table, it will attach the routing information to the data package and route it directly to the IP address. If the IP address isn't in within the computer's subnet, then it will send this routing information and data to its Gateway for processing. By having a Static Route set up in your computer, then only that computer will be able to communicate with the device that you are trying to communicate with unless you set up Static Routes on every computer in your network. Most routers will let you set up Static Routes and that way all computers in the local network will have access to the routing information. In Windows, you can set up the route to be persistent, meaning that it will be permanently stored on the computer. Mac computers do not have the persistent ability, so if you turn off or reboot your computer, you will need to add the Static Route again.

## Universes, Channels and Ports, oh my!

Many people have problems understanding the terminology and usage of channel addressing and ports. The developers are working on a few methods to eliminate the need to understand this but until it gets implemented this should help. A port is just a place to connect your string of pixels. The controller will usually have several ports and the controller needs to know what data to send to each port. Our lighting networks usually have tens of thousands of channels and there needs to be a way to identify where each pixel is located. In other words, all of your devices (and you) need to know where every pixel is, what model it is on, what controller is sending the data for that model and what port(s) are being used to send the data to the pixel strings.

The animated holiday lighting evolved from DMX data and incorporates its protocol to send data and that protocol is Universes and Channels. By definition a Universe can have any number of Channels in it up to a maximum of 512 channels (you are the one who decides how many channels you want your Universes to address).

You can use Absolute Addressing where each pixel is assigned 3 channels and it is basically just a numbering from 1 to however many channels you need but this can sometimes get confusing and difficult to manage. You can break it down into Universes and Channels to help make it easier to manage.

Think of it this way, your lights are a long string of pixels. Let's correlate the pixels to people. The people have families, some are bigger than others. The families are equivalent to the models in your show. All the families are going to go on a train ride. The train cars only have single file seating so it is one person in front of the other. All the passengers will get a drink while on the train. The drink represents the data sent to your pixels to know what color to create. The travel agent (equivalent to the sequencing software) will create a list of all the passengers and the drink they ordered. The travel agent does not know what size the train cars are going to be so it will just assign the passengers' seating from front to back and assign their drink order to the position in the list. The train Terminal (equivalent to the controller) will coordinate the passenger seating and drink order with the attendants (the attendants are similar to the ports on your controller). The attendants, for whatever reason (union issues maybe? LOL), do not deliver drinks to the same number of people. The Terminal will know what size each train car is going to be for this trip and how many drinks each attendant will serve. The train car comes in different sizes but the biggest one can hold 512 people. The cars correspond to Universes. So to deliver the correct drink to the correct person, the

Terminal will give each attendant the drinks they need in the order of the passengers in their section and tell them where to start serving.

For example, a particular trip will have 1578 people. This particular trip will use cars that hold 512 people, but the cars don't always have to be the same size. The Terminal will assign 4 cars for this trip to hold everyone. Attendant 1 can serve 490 drinks, attendant 2 can serve 560 drinks, attendant 3 can serve 520 drinks and attendant 4 can serve 580 drinks. The Terminal will give attendant 1 490 drinks in order and tell him to start at car 1 seat 1. The terminal will give attendant 2 560 drinks in order and tell him to start at car 1 seat 491 (he will have enough drinks to serve the last section of the first car, the entire second car and 26 people in the third car). Then give attendant 3 520 drinks in order and tell them to start at car 3 seat 27 and give attendant 4 8 drinks in order and tell him to start at car 4 seat 35 (you should be able to do the math to see how this worked).

This is very similar in many ways to how Universe/Channel addressing works. When you are setting up your show, YOU decide how big your Universes are as long as they are no bigger than 512 channels. You can have Universes of different sizes (be careful with this as it might cause confusion).

A few things to note:

- There is no direct correlation between ports on a controller and the Universe/Channel addressing. The port just needs to know which Universe and channel to start on and how many pixels it is sending data to just like the attendant doesn't care how many cars are on the train or how many passengers are on the train. They just need to know which car to get on and which seat to start serving drinks to and when he runs out of drinks, he is done.
- The cars can have an arbitrary number assigned to them, the Terminal can have a number printed on the car and call the first car 100 the second car could be number 215 and as long as the attendants know the car number and what seat to start with, it works. Just like your universes don't have to start at number 1 and don't need to go up sequentially.
- The cars can be any size (up to 512) and not all cars have to be the same size. Again, the ports (attendants) only need to know which car to get on and what seat to start serving drinks.
- A port can supply data to part of a Universe or more than one Universe.
- A port doesn't need to start at the beginning of a Universe or even at the beginning of a model, just like an attendant doesn't need to start at the beginning of a car or beginning of a family. But for management purposes there are some times that you might want to start at the beginning of a Universe or a model. The choice is yours.

## Troubleshooting

Here are a few of the more common problems and their solution.

Symptom	Possible Causes	Remedy
You can't access the FPP device during the USB Tether installation process.	1. The FPP device doesn't have power.	Make sure that the FPP Device is connected via a USB cable to the computer and the power indicator on the FPP device is illuminated.
	2. (Pi Zeros only) The USB	The Pi Zero has two USB ports,



	cable is plugged into the wrong port.	one is for power only. The correct one is closer to the center of the board and labeled USB and not PWR
	3. The USB cable is faulty.	There are some USB cables that are for charging only. Use another cable that is known to be working.
	4. Incorrect IP Address for USB Tethering	When using the USB Tethering method to access your FPP device, you can't use the HostName of the device, you have to use the tethering IP address. If you are using a Windows computer, the IP address is 192.168.7.2 If you are using a Mac or Linux computer, the IP address is 192.168.6.2
	5. The image on the uSD card is corrupt.	Format and Re-image the uSD card following the procedures in the <a href="#">Installing Software section</a>
	6. The uSD card is faulty.	Format and Re-image a known good uSD card following the procedures in the <a href="#">Installing Software section</a>
	7. The FPP device does not support USB Tethering.	USB Tethering is only supported by Raspberry Pi Zeros and BeagleBone devices.
You can't access the FPP device during the Networked installation process.	1. The FPP device doesn't have power	Check that the power is connected and the power LED is lit on the FPP Device.
	2. The Ethernet cable is faulty.	Test your Ethernet cable or use a known good one.
	3. The Ethernet cable is not fully inserted into the RJ45 jacks	Check that the cables are fully inserted at both ends.
	4. The Ethernet cable is plugged into the wrong port on the router.	Make sure that the cable is inserted into a LAN port and not a WAN port on your router.
	5. The pins in the RJ45 connector are damaged.	Conduct a visual inspection to make sure the pins are not bent or missing.
	6. You are trying to access the FPP device directly.	You do not access the FPP interface directly; you have to connect through a web browser like Google Chrome.
	7. You are using the wrong Host Name.	The correct Host Name for accessing a fresh install is <a href="http://fpp/">http://fpp/</a> or <a href="http://fpp.local/">http://fpp.local/</a> If you have other FPP devices on your network then the Host Name

		access might not work. Refer to the next item, DNS not resolving local names.
	8. DNS not resolving local names.	<p>Sometimes a router will not resolve DNS host names (like <a href="http://fpp">http://fpp</a>) so you have to enter the IP address for the FPP Device. This entails accessing your router and might be a little technical for some.</p> <p>Log in to your router's administration page (many times the log in information will be on a sticker on the router, if not, look up the default log in for your brand router)</p> <p>Once you log in, there should be a device table or a connected devices section (What it is called depends on the router.)</p> <p>You should see a device labeled FPP, enter the IP address associated with the FPP device.</p>
	9. The FPP device doesn't have a good network connection.	<p>Look in your available networks on your computer and see if there is an entry for FPP, if so, then the FPP device could not communicate with your network. Check all cables. Another issue is that the network you are connecting to is on a 192.168.7.xxx subnet.</p>
	8. The image on the uSD card is corrupt.	<p>Format and Re-image the uSD card following the procedures in the <a href="#">Installing Software section</a></p>
	9. The uSD card is faulty.	<p>Format and Re-image a known good uSD card following the procedures in the <a href="#">Installing Software section</a></p>
You can't access the FPP device during the Wi-Fi Tether installation process.	1. The FPP device doesn't have power	<p>Check that the power is connected and the power LED is lit on the FPP Device.</p>
	2. The FPP device doesn't broadcast the FPP network.	<ol style="list-style-type: none"> <li>1. The FPP device is connected to a network of some kind. Make sure that you do not have the FPP device connected via Ethernet to any device or USB cable to your computer.</li> <li>2. The FPP Device doesn't have a Wi-Fi adapter. Make sure that your FPP device has a Wi-Fi Adapter</li> <li>3. Your Wi-Fi adapter does not</li> </ol>

		support Wi-Fi tethering. Many USB based Wi-Fi adapters do not support Wi-Fi tethering. (on board Wi-Fi adapters on the Raspberry Pi and BB wireless versions supports Wi-Fi tethering)
	3. The FPP device broadcasts the FPP network but you cannot connect to the FPP network.	Your Wi-Fi adapter does not support Wi-Fi tethering. Many USB based Wi-Fi adapters do not support Wi-Fi tethering. (on board Wi-Fi adapters on the Raspberry Pi and BB wireless versions supports Wi-Fi tethering)
	4. The image on the uSD card is corrupt.	Format and Re-image the uSD card following the procedures in the <a href="#">Installing Software section</a>
	5. The uSD card is faulty.	Format and Re-image a known good uSD card following the procedures in the <a href="#">Installing Software section</a>