

**MANUAL – INSTALLATION**

---

# Fan Powered Variable Volume Terminal Units

FPV, FEV, FDV Series

**Revision #: 01 – Issue Date: 11/12/14**

© 2014 Price Industries Limited. All rights reserved.

**PRICE**<sup>®</sup>

# FAN POWERED VARIABLE VOLUME TERMINAL UNITS

## TABLE OF CONTENTS

### Product Overview

General.....	1
Caution To Contractors.....	1
Receiving Inspection.....	1
Control Assembly Label.....	2

### Installation & Mounting Instructions

Mounting The Unit .....	3
Duct Connection.....	4
Electrical Connection .....	4
Control Connections.....	4
Fan and Motor Maintenance .....	5
Filter(s).....	5
Operating Guidelines .....	5
Air Balancing Procedure .....	6
ECM Motor Adjustment .....	6
ECM Speed Controller - Deluxe, Standard.....	7
Fan Performance Curves - FPV, FEV, FDV - PSC Motor.....	8
Fan Performance Curves - ECM Motor .....	9

### Pneumatic Calibration Procedures

CP100 / CP200.....	12
CP101 .....	13
Direct Acting Cooling or Reverse Acting Heating.....	13
Reverse Acting Cooling or Direct Acting Heating.....	14
DDC Calibration Procedures .....	14
Electronic Air Flow Adjustment Procedure for Analog Controls.....	14
Electronic Air Flow Adjustment Procedure for Digital Controls.....	14
FPV, FEV, FDV Calibration Curves .....	15

### Maintenance

Troubleshooting Guide.....	16
Replacement Parts .....	17

# FAN POWERED VARIABLE VOLUME TERMINAL UNITS

## PRODUCT OVERVIEW

### General

Price fan powered terminals are available with pneumatic, electronic or direct digital (DDC) controls. In most cases pneumatic and electronic controls are factory supplied and mounted. In the case of DDC controls, the terminal unit controls are often supplied by the controls contractor and either factory or field mounted. For information concerning controls, components, sequence of operations, etc. for DDC controls supplied by the controls contractor, please refer to the documentation provided by the controls contractor.

Damper rotation is always clockwise to the open position. An identification mark on the end of the shaft indicates the damper position. Capped tees are provided in sensing lines from the amplifying sensor. These allow field connection of a differential pressure gauge for accurate air flow measurement. (Not applicable with electronic controls.)

An optional metal control cover may be provided to protect the terminal unit control components. The protective cover is removable with two sheet metal screws.

The velocity sensor is normally supplied as standard with the terminal unit. However, in some cases a flow sensing device supplied by the controls contractor may be field or factory mounted. Refer to the submittal drawing for illustration.

### Caution To Contractors

1. Fan powered terminal units are not intended for use as temporary heat or ventilation sources during building construction. The terminal units are not designed nor equipped to operate in a dusty construction environment. Recirculating fan wheels can become coated in construction dust, resulting in an unbalanced wheel. This in turn can contribute to reduced motor life. Inlet air filters, if supplied, would provide little protection as they would quickly become plugged with construction dust.
2. A fan powered terminal unit should never be operated if the downstream duct work has not been installed. A minimum of 0.10 inches W.G. downstream static pressure resistance is required for safe operation of the motor, minimum of 0.20 inches W.G. is required for stable operation of electric heater.

Please note that Price cannot warrant against unauthorized operating conditions as outlined above.

### Receiving Inspection

All Price fan powered terminal units are inspected before shipment. After unpacking the assembly, check it for damage. If any damage to the products is found, report it immediately to the delivery carrier. During unpacking and installation, **do not handle the unit by the inlet velocity sensor**. Caution is required when unpacking the fan powered units with electric coils as not to damage the elements.

**Ensure that all packing material is removed from the inside of the unit, especially around the blower wheel and coil section.**

**WARNING:** Do not adjust the control components.

FDV ▼

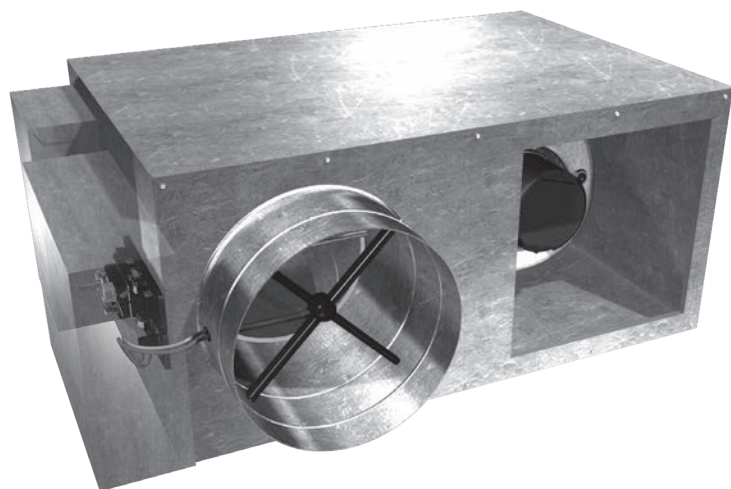

# FAN POWERED VARIABLE VOLUME TERMINAL UNITS

## PRODUCT OVERVIEW

### Control Assembly Label

All Price fan powered terminal units are tagged with a control assembly label as shown on the left. This label identifies the model number, location tag #, controller type, actuator type, thermostat action, damper action, application and controller set points. Options, accessories and appropriate control diagrams are also identified. If field adjustment of the controller set points should become necessary, follow the appropriate procedure outlined in this manual. Note that all pneumatic controls must be calibrated in the position they are mounted.

All factory supplied controllers are tagged with a controller label as shown below. This label identifies the required sensor velocity pressure for both the minimum and maximum controller set points.

### CONTROL ASSEMBLY LABEL ▼



#### VAV SPECIFICATIONS / SPÉCIFICATIONS VAV

Price Order No / No Comm de Price:	54399
Branch PO / BC de la Succ:	T100200J
Customer PO / BC du Client:	3429
Job Name / Nom du Projet:	Commerce Trust
Package Tag / Étiquette du Colis:	
Unit Location / Localisation de l'Unité:	VAV-59



AIR DISTRIBUTION PRODUCTS /  
PRODUITS DE DISTRIBUTION D'AIR  
Manufactured By / Fabriqué Par  
Price

Special Instructions / Instructions Spéciales: SCHEM #CXY49210

Fan Flow = 250 cfm

Item	Model / Modèle	Size / Grandeur	Controller / Régulateur	Motor / Moteur			
1	FPV8000	208	CP101 Controller	EHP			
Air Volume (cfm / l/s) / Volume d'Air (pcm / l/s)		Reset Span / Plage d'Opération		Damper / Volet	Thermostat	Coil Serpentin	Application
0	500 cfm	8-13 psi	Norm. Open	Direct Acting			Cooling
0	236 L/s						

031600

Price Order No. / No. de Comm. de Price	Item	Model / Modèle	Size / Grandeur	Unit Location / Localisation de l'Unité
54399	1	FPV8000	208	VAV-59

Price Order No. / No. de Comm. de Price	Item	Model / Modèle	Size / Grandeur	Unit Location / Localisation de l'Unité		
54399	1	FPV8000	208	VAV-59		
Damper / Volet		Air Volume (cfm / l/s) / Volume d'air (pcm / l/s)		Settings / Réglages		Reset Span / Plage d'Opération
Norm. Open		0 cfm 500 cfm 0 L/s 236 L/s		0.000 0.286" 0 71 Pa		8-13 psi

# FAN POWERED VARIABLE VOLUME TERMINAL UNITS

## INSTALLATION & MOUNTING INSTRUCTIONS

### Mounting The Unit

1. Use trapeze hangers or optional hanger brackets (shipped loose) as illustrated. Hanging rods should be securely attached to joists or to mounting anchors which are properly secured to slab construction with lugs or poured in place anchors. Trapeze bars should be positioned within 3 inches (76 mm) of the discharge end and 2.5 inches (63 mm) of the inlet end to allow for access panel removal.
2. Price Fan Powered Terminal Units are designed to be mounted in the direction indicated by the Control Assembly Label found on the protective shroud.
3. Do not block the bottom access panel, maintain clearance for blower service. Correct installation of the trapeze bars will not block access panel removal.
4. Do not install tight to slab, avoid contact with other obstacles such as rigid conduit and sprinkler piping. This can cause excessive vibration and noise transmission.
5. Install the unit in a location that allows free access to the unit as well as all control components.
6. Ensure main power to the terminal and electric coil has been disconnected prior to performing any electrical work or inspection of the circuitry.
7. When mounting hanger brackets to an electric coil, do not use screws longer than  $\frac{3}{4}$ " (19).

**WARNING:** Do not tamper with control components.

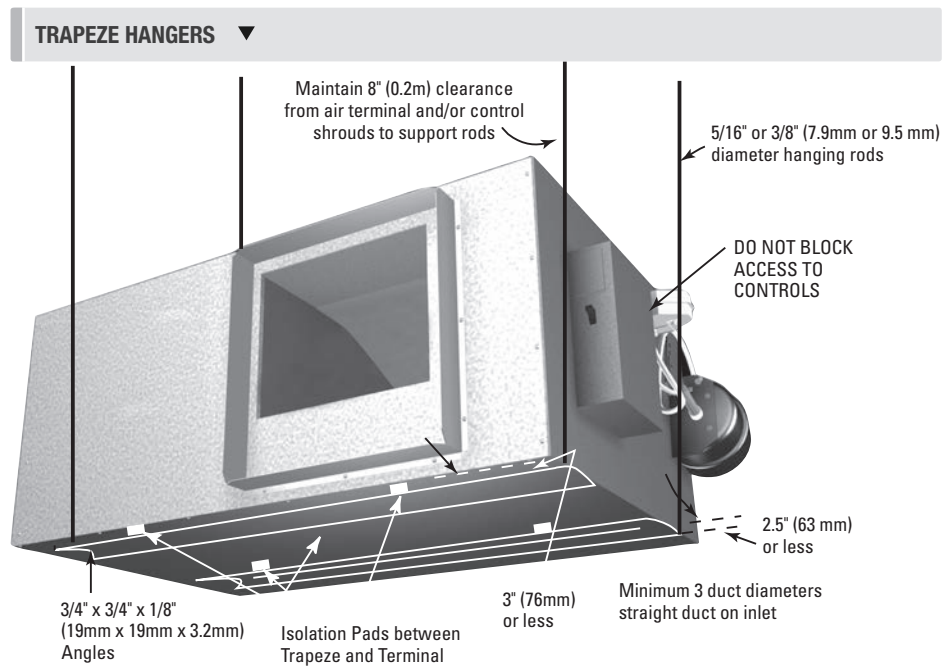
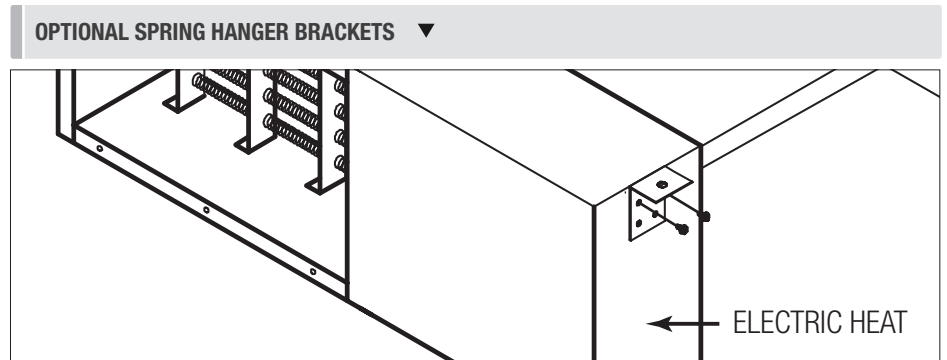
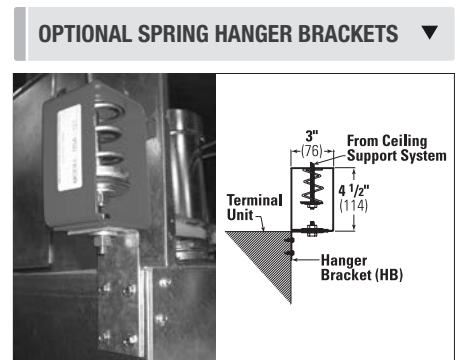
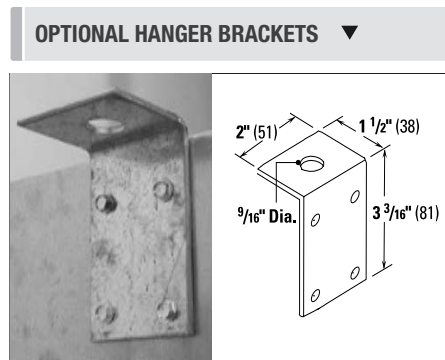

DO NOT BLOCK  
BOTTOM ACCESS PANEL

NOTE: INSTALL AIR TERMINALS LEVEL WHEN EQUIPPED WITH VELOCITY PRESSURE CONTROLLERS.

# FAN POWERED VARIABLE VOLUME TERMINAL UNITS

## INSTALLATION & MOUNTING INSTRUCTIONS

### Duct Connection

1. Recommend a minimum of 3 duct diameters of straight inlet duct, either sheet metal or flexible, same size as the inlet, between the unit inlet and any transition, take-offs or fittings. Use of transitions or elbows at the unit inlet to be avoided. Where flexible duct is used it should be pulled tight to eliminate sags or folds.
2. To control radiated noise in critical applications it is recommended that the inlet ducts be fabricated of minimum 24 gauge sheet metal in place of flexible duct.
3. To prevent excessive air leakage, all cleat joints should be sealed with an approved duct sealer. This applies to all accessory connections as well as the basic fan powered terminal unit.
4. Holes that are drilled in the duct for testing or balancing purposes are to be sealed with duct tape or duct sealer.

### Electrical Connection

**CAUTION:** Disconnect all incoming power before any electrical installation or service is performed on the unit(s).

1. All field wiring is to be in accordance with the National Electrical Code ANSI/NFPA No. 70 or the Canadian Electrical Code, Part 1, CSA Standard C 22.1.
2. Refer to the product identification label on each unit for information to determine the field wire size.
3. Check voltage requirements prior to power supply connection. Refer to the electrical label located near the electrical control box and also refer to the schematic drawing provided on the underside of the electrical control box cover.
4. If upon energizing the electric motor excessive noise is apparent, shut down the unit. Determine the cause by checking for packing materials, etc. and re-energize after corrective action has been taken.
5. If an Electric Reheat Coil has been supplied, refer to the electrical schematic which is permanently affixed to the underside of the electrical control cabinet door, prior to hook-up. Check the voltage requirements to ensure proper voltage supply is used.

**CAUTION:** For three phase power connections, be sure to account for fan motor load. Phases must be balanced accordingly.

### Control Connections

#### Pneumatic

1. External control air connections are provided for main air and thermostat hook up. These are to be piped according to the label on the inlet panel.
2. Main air supply must be clean and dry, delivered at 15 to 25 psi (maximum 25 psi).
3. Ensure that lines are not crimped or cut when installed.

#### Electronic

A wiring diagram is provided with each assembly. Follow the diagram for wiring of the thermostat and other accessories.

#### Digital

If controls have been factory mounted, a wiring diagram will be included with the unit indicating the factory mounted components. For field wiring of room sensors and other accessories, refer to the controls contractor's documentation for all wiring information.

# FAN POWERED VARIABLE VOLUME TERMINAL UNITS

## INSTALLATION & MOUNTING INSTRUCTIONS

### Fan and Motor Maintenance

1. Disconnect all incoming power before servicing the unit.
2. Price fan powered terminal units are supplied with permanently lubricated motors.
3. The blower and motor should be inspected annually for accumulation of dust and dirt. Clean as necessary.
4. To access blower and motor for servicing, remove the bottom access panel or alternate access panels if equipped (see sketch on **page 7**).

**CAUTION:** Motor may be very hot. Ensure motor has cooled before service.

5. Motors are provided with thermal overload protection. If the motor overheats and trips the thermal overload, it will automatically reset after cooling down to a proper operating temperature.
6. If the fan motor is turned off while the primary air system is operational the following start-up procedure should be employed for constant volume units.
  - i. Override the primary air damper to the closed position as follows:

**Pneumatic** - Apply main air to the damper actuator for normally open units or disconnect main air for normally closed units.

**Electronic** - Disengage gears of the electric actuator with the clutch button and manually close damper.

**DDC** - Use DDC software to override damper.
  - ii. Wait at least 2 minutes to allow the fan wheel to stop rotation.
  - iii. Turn power on to the terminal unit
  - iv. Restore damper to normal position. The above procedure will prevent backward rotation of the fan motor on start-up.
7. If field amperage draw readings of the fan motor are required, measurements should be taken with a true RMS meter. Non-true RMS meters will not provide accurate reading due to alteration of the sine wave by the fan speed control. Refer to Page 8 for maximum motor operating amps.

### Filter(s)

1. Filters, if supplied, should be replaced or removed after system start-up.
2. If filters are used beyond system start-up they should be changed regularly to avoid excessive restriction of air flow. Frequency would depend on environment.
3. Refer to the “Replacement Parts” section of this manual for list of replacement filter media.

### Operating Guidelines

4. Downstream duct static pressure is a minimum 0.1” W.G. 0.2” W.G. required for units with electric heater for stable control operations.
5. If electric duct heaters are supplied, 70 CFM/kW minimum air flows across the heater must be maintained.
6. If electric duct heaters are supplied, the discharge air temperature must not exceed 120°F.
7. If electric duct heaters are supplied the primary valve damper should be closed or in a closed position. During a heating cycle if the damper is wide open airflow produced by the unit’s fan is allowed to travel upstream of the unit. Insufficient air velocities passing through the coil elements could cause the elements to overheat which could trigger safety alarms. Price recommends having the primary valve damper closed when no primary air is sensed.

# FAN POWERED VARIABLE VOLUME TERMINAL UNITS

## INSTALLATION & MOUNTING INSTRUCTIONS

### Air Balancing Procedure

Before Air Balancing the terminal unit, the following general items should be verified.

1. The primary fan system is operating at the specified volume, static pressure, RPM and current.
2. Return filters (if supplied) are clean.
3. All balancing dampers are adjusted and locked. Dampers downstream of the terminal unit should be proportionally balanced.
4. Thermostats are calibrated and operational.
5. All duct work and connections are free from leaks.
6. Sufficient duct static pressure is available at the terminal primary air inlet.
7. All diffusers are installed and adjusted for the proper air pattern.
8. Downstream duct static pressure is a minimum 0.1" W.G. 0.2" W.G. required for units with electric heater for stable control operations.
9. The primary air volume (both minimum and maximum set points) are factory calibrated for pneumatic or electronic controls supplied by Price. If field adjustment should be necessary, follow the appropriate calibration procedures for the controller type supplied with the unit. If DDC controls are supplied, refer to the control contractor's documentation for calibration instructions.
10. Set the thermostat to full cooling. The fan should be off and the primary air valve at maximum air flow. Verify the air flow with the sensor tube or pitot tube traverse. Adjust if necessary.
11. Set the thermostat to full heating. The fan should be on and the primary air valve at minimum flow. Verify the primary air volume with sensor taps or pitot tube traverse. Adjust if necessary.
12. The fan volume must be field adjusted with the fan speed controller. Fan curves on page 8 indicate the volume range of each size unit. Adjust the speed control until the desired air flow is measured at the outlets. Note that if the primary air valve has a minimum setting, the outlet volume will be the summation of fan and primary air flow.

### ECM Motor Adjustment

1. Remove the electrical control cover and connect the leads from a DC voltmeter to the terminals indicated.
2. Determine test point voltage from the formula based on the desired air flow.
3. Adjust the manual speed control dial on the outside of the box with a screwdriver until the test point voltage is achieved.
4. Wait a few seconds for the ECM motor to adjust its speed and then verify fan flow with measurements at the supply outlets.
5. If necessary, fine tune the speed control in accordance with the measured outlet flow.

#### CONTROL ASSEMBLY LABEL ▼

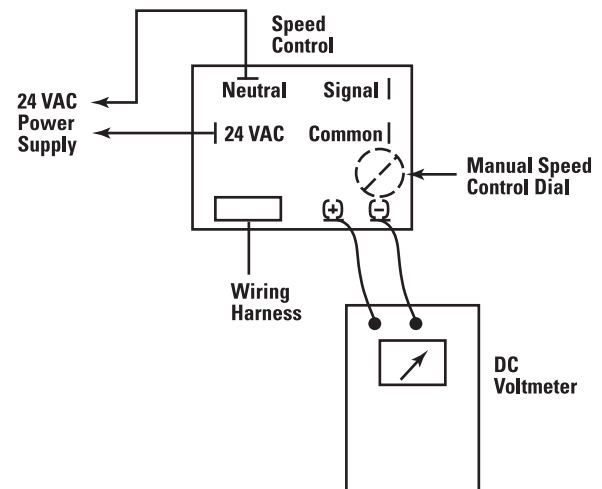

### FDV Series

Size	Motor Volts	Equation
20	115, 240, 277	CFM = (178 x VDC) - 45
30	115, 240, 277	CFM = (474.21 x VDC) - 480.07
40	115	CFM = (540.9 x VDC) - 562.1
40	240	CFM = (552.2 x VDC) - 582.6
40	277	CFM = (536.1 x VDC) - 533.6
50	115, 240, 277	CFM = (634.84 x VDC) - 453.38
60	115, 240, 277	CFM = (479 x VDC) + 410



# FAN POWERED VARIABLE VOLUME TERMINAL UNITS

## INSTALLATION & MOUNTING INSTRUCTIONS

### ECM Speed Controller - Deluxe, Standard

#### Price DELUXE ECM Speed Controller

The Price Deluxe ECM speed controller works with a high efficiency ECM motor. This low voltage (24VAC) speed control allows full manual (push button adjust) or BAS (2-10VDC signal) control of the ECM motor.

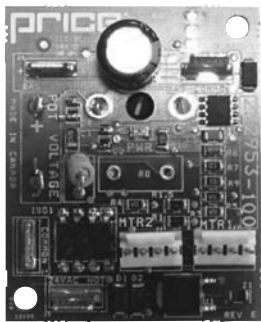

#### Features:

- Dual outputs for controlling 2 ECM motors (Note: Both motors will receive the same signal.)
- Red three-digit digital display for reading out:
  - Speed 0-100%
  - Motor RPM (for motor number one only)
  - BAS input voltage (Digital readout of incoming BAS voltage signal.)
- Building Automation System input (2-10VDC) for remote control
- 0-10 VDC output corresponding to motor RPM.

#### LED Digital Display

The Digital Display shows the user several modes of operation. This allows for easier and more precise field adjustment and troubleshooting.

By pressing both the UP and DOWN push buttons at the same time the user can cycle between the following modes:

1. Speed Adjustment – is easier and more precise with the digital display and push buttons than with a standard dial.
2. Motor RPM – displays the real time motor speed to aid in troubleshooting.
3. BAS input voltage – displays the input voltage signal from the building automation system (BAS). Note: Any BAS voltage signal above 1 VDC overrides local speed control.

#### Important Information regarding the ECM motor.

Do not switch 120/208/240/277 VAC power to turn ECM motor on and off. Instead control the 24VAC signal or BAS signal to turn the ECM motor on and off. The ECM motor has large capacitors that charge quickly on mains power up. Switching on several motors frequently could reduce building power quality and is not recommended.

#### BAS Operation

Input Voltage	Mode of Operation
0-1 vdc	ManualControl
1-2 vdc	Fan Off
2-10 vdc	Remote Control 0-100%

#### Standard ECM Speed Controller

The Price standard speed controller allows manual adjustment of the fan flow using the adjustment dial on the control board and a voltmeter. Remote control of the fan speed is also possible with the BAS input. The following chart describes the controller response to a 0-10 VDC input.

Input Voltage	Mode of Operation
0-1 vdc	ManualControl
1-2 vdc	Fan Off
2-10 vdc	Remote Control 0-100%

# FAN POWERED VARIABLE VOLUME TERMINAL UNITS

## INSTALLATION & MOUNTING INSTRUCTIONS

### Fan Performance Curves - FPV, FEV, FDV - PSC Motor

**NOTE:** Data obtained in accordance with ARI Standard 880-98.

#### Caution to Contractors

Fan powered terminal units are not intended for use as temporary heat or ventilation during building construction. The terminal units are not designed nor equipped to operate in a dusty construction environment. Recirculating fan wheels can become coated with construction dust, resulting in an unbalanced wheel. This in turn can contribute to reduced motor life. Inlet air filters would provide little protection as they would quickly become plugged with construction dust.

A fan powered terminal unit should never be operated if the downstream ductwork has not been installed.

A minimum of 0.10 inches W.G. downstream static pressure resistance is required for safe operation of the recirculating fan motor. 0.2" W.G. required for stable operation of electric heater controls.

**NOTE:** Price cannot warrant against unauthorized operation under conditions as outlined on this page.

#### Maximum Flow

- No Coil or Electric Coil
- 1 Row Water Coil
- 2 Row Water Coil
- - 1 Row High Capacity
- - - 2 Row High Capacity

UNIT SIZE 20 ▼

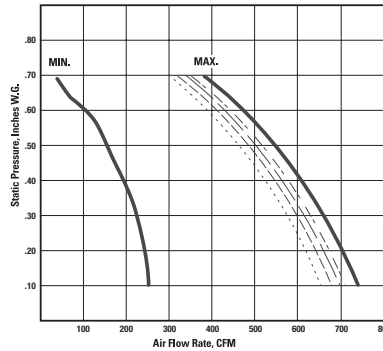

UNIT SIZE 30 ▼

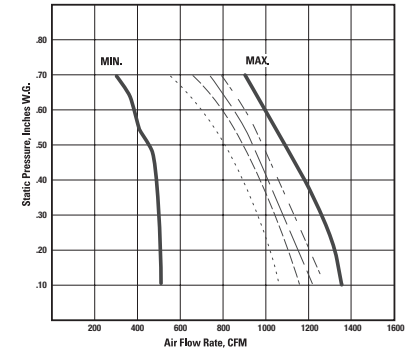

UNIT SIZE 40 ▼

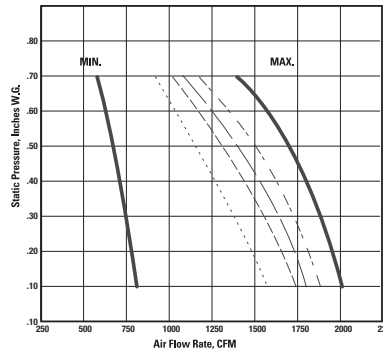

UNIT SIZE 50 ▼

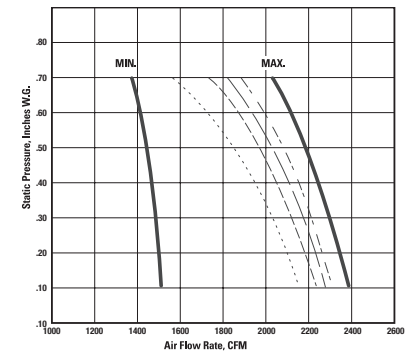

UNIT SIZE 60 ▼

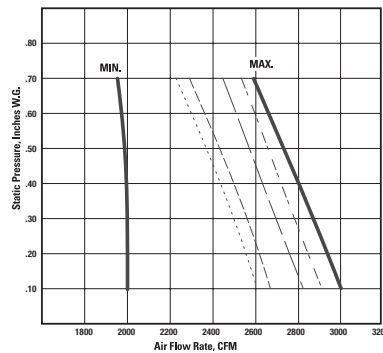

#### Standard Motor Data

Unit Size	Motor H.P.	Full Load Amps			
		115V	208V	240V	277V
20	1/8	2.9	0.9	0.8	1.1
30	1/4	4.7	0.8	0.7	1.7
40	1/2	9.8	3.8	3.8	3.2
50	3/4	12.3	5.4	5.2	4.4
60	1	—	6.5	7.8	7.8

# FAN POWERED VARIABLE VOLUME TERMINAL UNITS

## INSTALLATION & MOUNTING INSTRUCTIONS

### Fan Performance Curves - ECM Motor

#### Selection Guideline

To properly select a Price fan powered terminal unit with ECM motor, refer to the fan performance curves below. The fan curves give the range of external static pressure available at the discharge versus the range of air volumes. Fan selection must be within the bolded fan curve lines.

The shaded area shown on the fan curves gives the range of constant fan flow operation for each size unit for external static pressures from 0.1 to 0.5 in. w.g. In this shaded area fan flow can be factory set to design conditions. Selection outside the shaded area is allowable. However, fan flow will vary according to the external static pressure applied to the fan.

The solid state speed controller allows selection anywhere within the minimum and maximum fan flows. Selections in the mid-volume range are recommended to reduce noise level and provide flexibility for future changes. The speed controller can be factory set but can also be easily field adjusted if changes are required.

When selecting a fan size from the performance curves, the static pressure loss of any accessories must be taken into account. The effect of the resistance of hot water heating coils on the fan performance is indicated on separate fan curves. For electric heating coils, the range for no coil can be used.

If a fan selection is made near the maximum rated fan capacity and actual downstream system pressure is higher than anticipated, design volume will not be achieved.

Note that in all cases a downstream resistance to the fan of at least 0.10 in. w.g. must be maintained to avoid overloading of the fan motor. For terminal units with electric reheat a minimum discharge static of 0.2" w.g. is recommended for stable operation of heater controls.



UNIT SIZE 10 - NO COIL, 1 & 2 ROW COIL ▼

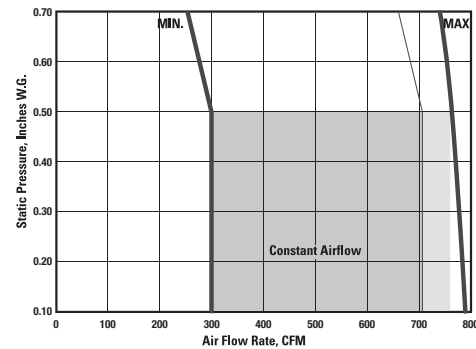

UNIT SIZE 30 - NO COIL ▼

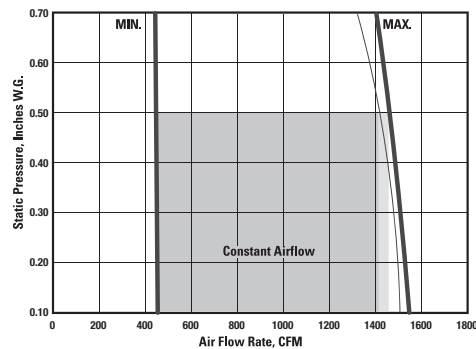

UNIT SIZE 30 - 1 ROW COIL ▼

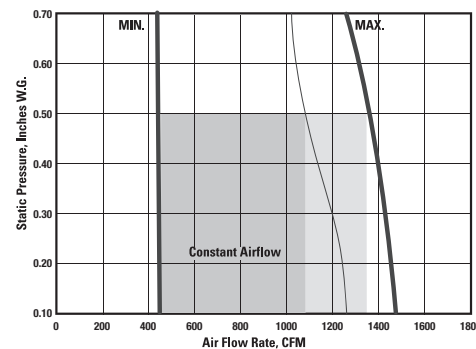

UNIT SIZE 30 - 2 ROW COIL ▼

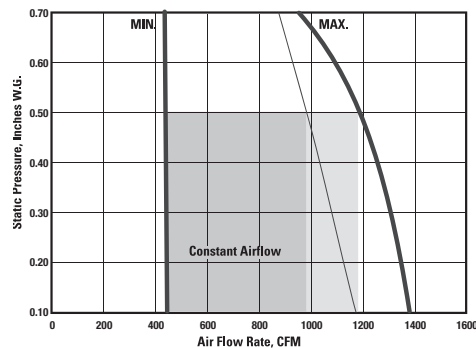

# FAN POWERED VARIABLE VOLUME TERMINAL UNITS

## INSTALLATION & MOUNTING INSTRUCTIONS

### Fan Performance Curves - ECM Motor

#### Caution to Contractors

Fan powered terminal units are not intended for use as temporary heat or ventilation during building construction. The terminal units are not designed nor equipped to operate in a dusty construction environment. Recirculating fan wheels can become coated with construction dust, resulting in an unbalanced wheel. This in turn can contribute to reduced motor life. Inlet air filters would provide little protection as they would quickly become plugged with construction dust.

A fan powered terminal unit should never be operated if the downstream ductwork has not been installed. A minimum of 0.10 in. w.g. downstream static pressure resistance is required for safe operation of the recirculating fan motor. For terminal units with electric reheat a minimum discharge static of 0.2" w.g. is recommended for stable operation of heater controls.

**NOTE:** Price cannot warrant against unauthorized operation under conditions as outlined on this page.

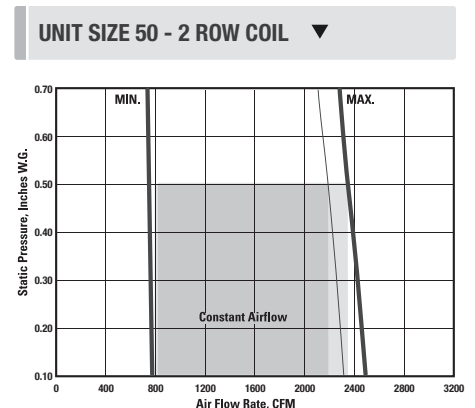
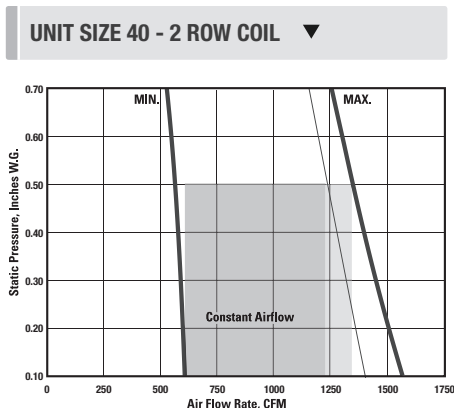
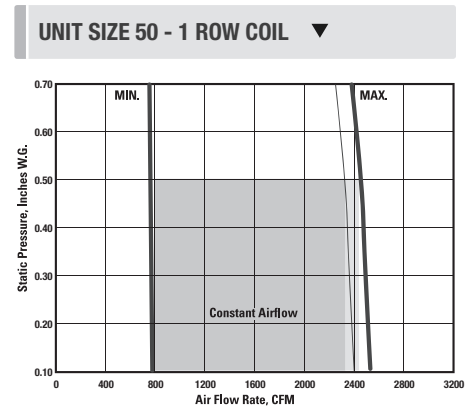
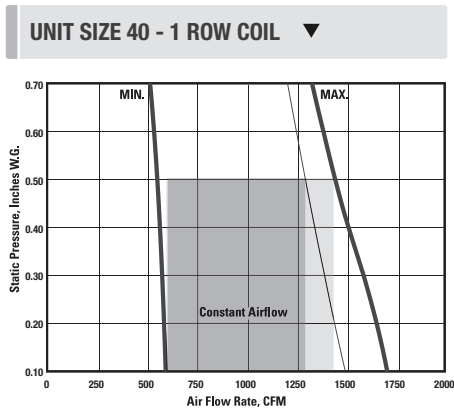
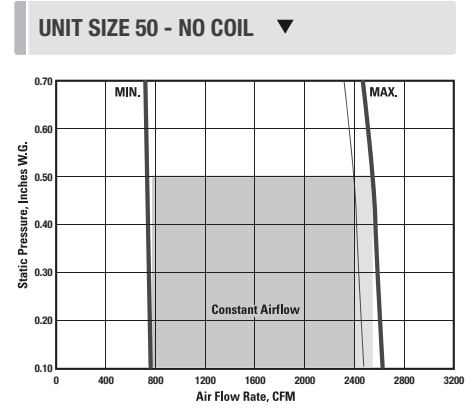
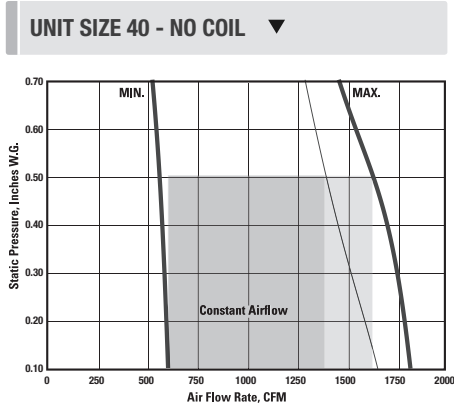

# FAN POWERED VARIABLE VOLUME TERMINAL UNITS

## INSTALLATION & MOUNTING INSTRUCTIONS

### Fan Performance Curves - ECM Motor

**NOTE:** Data obtained in accordance with ARI Standard 880-98.

#### Caution to Contractors

Fan powered terminal units are not intended for use as temporary heat or ventilation during building construction. The terminal units are not designed nor equipped to operate in a dusty construction environment. Recirculating fan wheels can become coated with construction dust, resulting in an unbalanced wheel. This in turn can contribute to reduced motor life. Inlet air filters would provide little protection as they would quickly become plugged with construction dust.

A fan powered terminal unit should never be operated if the downstream ductwork has not been installed.

A minimum of 0.10 inches W.G. downstream static pressure resistance is required for safe operation of the recirculating fan motor. 0.2" W.G. required for stable operation of electric heater controls.

**NOTE:** Price cannot warrant against unauthorized operation under conditions as outlined on this page.

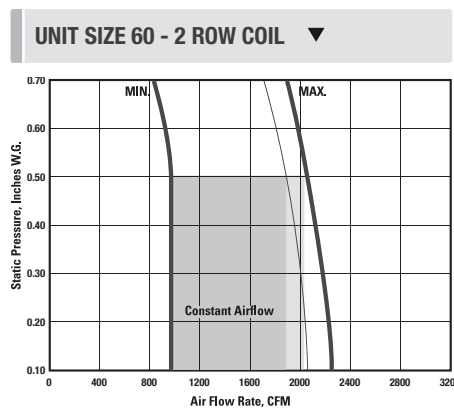
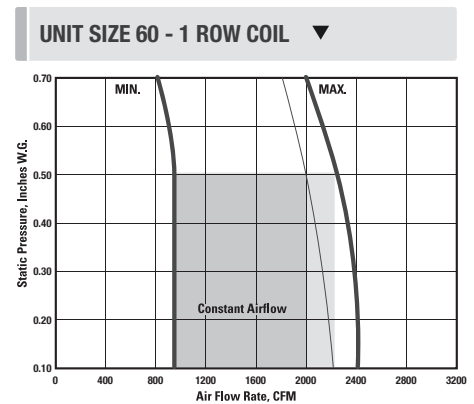
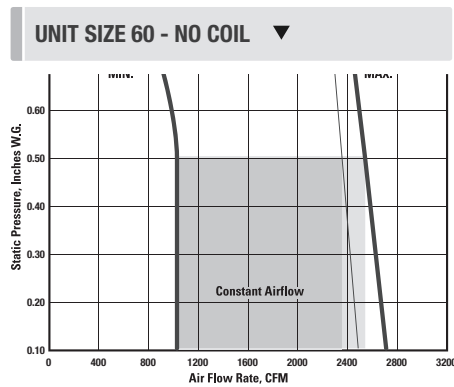

#### Legend

- No Filter
- With Filter (MERV8 or 13)

### ECM Motor Data

Unit Size	Motor H.P.	Full Load Amps		
		115V	240V	277V
20	1/3	3.9	1.9	1.6
30	1/2	7.0	3.5	3.0
40	1/2	7.2	3.8	3.3
50	1	12.6	6.1	5.4
60	1	12.6	6.1	5.4

# FAN POWERED VARIABLE VOLUME TERMINAL UNITS

## PNEUMATIC CALIBRATION PROCEDURES

### CP100 / CP200

#### General

1. Remove the protective metal cover.
2. Aligned markings on the face and dials of the controller indicate that the factory settings are intact.
3. Remove the caps from the tees in the HI (red) and LO (green) tubes leading from the air flow sensor in the assembly inlet. Connect a differential pressure gauge to the tees. A gauge with a 0 to 1 inch w.g. scale is recommended.
4. Refer to the calibration curve for the size assembly being serviced. From the curve on page 13, read the differential pressure across the sensor for the required air flow.
5. Alternately, calculate the differential pressure from the equations on **page 13**.

#### CP100 (If Supplied)

1. Adjust the minimum (LO) air flow limit first.
2. Set the thermostat signal to 0 psi, or disconnect the thermostat tube to the controller.
3. Turn the minimum (LO) dial on the controller (center knob) until the gauge reads the required differential pressure. Turn the dial slowly, allowing time for the damper actuator to complete its travel in response to the adjustments. (Verify the minimum set point by cycling the thermostat pressures).
4. Apply 15 psi minimum air pressure to the thermostat connection at the controller.
5. Turn the maximum (HI) dial on the controller (outer knob) until the gauge reads the required differential pressure. Turn the dial slowly, allowing time for the damper actuator to complete its travel in response to the adjustments. (Verify the maximum set point by cycling the thermostat pressure).

#### CP200 (If Supplied)

1. Adjust the minimum (HI) air flow limit first.
2. Set the thermostat signal to 0 psi, or disconnect the thermostat tube to the controller.
3. Turn the minimum (HI) dial on the controller (center knob) until the gauge reads the required differential pressure. Turn the dial slowly, allowing time for the damper actuator to complete its travel in response to the adjustments. (Verify the minimum set point by cycling the thermostat pressure).
4. Adjust the minimum (LO) air flow limit.
5. Apply 15 psi minimum air pressure to the thermostat connection at the controller.
6. Turn the minimum (LO) dial on the controller (outer knob) until the gauge reads the required differential pressure. Turn the dial slowly, allowing time for the damper actuator to complete its travel in response to the adjustments. (Verify the maximum set point by cycling the thermostat pressure).

# FAN POWERED VARIABLE VOLUME TERMINAL UNITS

## PNEUMATIC CALIBRATION PROCEDURES

### CP101

#### General

1. Reconnect the thermostat tube to the controller if it has been removed during the calibration procedure.
2. Disconnect the gauge and replace the caps on the tees.
3. Replace the protective cover.

### CP101

#### 1. Damper Action

- i. Damper action is factory set. To reset action, loosen damper selection switch screw and align desired action with the damper position. Retighten screw.
- ii. Actuator must be repositioned to provide appropriate fail safe position.

#### 2. Reset Start Point

- i. Reset start point is factory calibrated to the specified setting on the control assembly label.
- ii. To field adjust, remove the gauge tap cap at “G” and attach a 0 - 30 psi pressure gauge.
- iii. Adjust the thermostat pressure at “T” port to the desired start point value with a gradual switch or pressure regulator. (Start point is lowest span pressure).
- iv. Adjust reset start knob until the gauge pressure begins to increase slightly (greater than zero but less than 0.3).
- v. Replace gauge tap cap.

#### 3. Reset Span

- i. Reset span is factory calibrated to the specified setting on the control assembly label.
- ii. To field adjust, remove the gauge tap cap at “G” and attach a 0 - 30 psi pressure gauge.
- iii. Adjust the thermostat pressure at “T” port to above 15 psi.
- iv. Adjust reset span knob until the gauge pressure is equal to the desired reset span (total span pressure, not end span pressure).
- v. Replace gauge tap cap.

#### 4. Air Volume Limits

- i. Remove the caps from the tees in the HI (red) and LO (green) tubes leading from the air flow sensor in the assembly inlet. Connect a differential pressure gauge to the tees. A gauge with a 0 to 1 inch w.g. scale is recommended.
- ii. Refer to the calibration curve for the size assembly being serviced. From the curve read the differential pressure across the sensor for the required air flow.
- iii. Alternately, calculate the differential pressure from the equations on **page 13**.

### Direct Acting Cooling or Reverse Acting Heating

1. Adjust the minimum air flow limit first.
2. Set the thermostat signal to 0 psi or disconnect the thermostat tube from the controller.
3. Adjust the “LO STAT” dial on the controller (center knob) until the gauge reads the required differential pressure for minimum air volume. Turn the dial slowly, allowing time for the damper actuator to complete its travel in response to the adjustments.
4. Adjust the maximum air flow limit, after verifying the minimum air flow limit is set correctly.
5. Apply 15 psi minimum air pressure to the thermostat connection at the controller.
6. Adjust the “HI STAT” dial on the controller (outer knob) until the gauge reads the required differential pressure for maximum air volume. Turn the dial slowly, allowing time for the damper actuator to complete its travel in response to the adjustments.
7. Cycle the thermostat several times. This can be quickly accomplished by removing the cap from the gauge tap (Port G) and varying the bleed rate with finger pressure. Replace cap and check the air flow limits. If set points have changed, repeat steps 1 to 7.

# FAN POWERED VARIABLE VOLUME TERMINAL UNITS

## PNEUMATIC CALIBRATION PROCEDURES

### Reverse Acting Cooling or Direct Acting Heating

1. Adjust the maximum air flow limit first.
2. Set the thermostat signal to 0 psi or disconnect the thermostat tube from the controller.
3. Adjust the “LO STAT” dial on the controller (center knob) until the gauge reads the required differential pressure for maximum air volume. Turn the dial slowly, allowing time for the damper actuator to complete its travel in response to the adjustments.
4. Adjust the minimum air flow limit, after verifying the maximum air flow limit is set correctly.
5. Apply 15 psi minimum air pressure to the thermostat connection at the controller.
6. Adjust the “HI STAT” dial on the controller (outer knob) until the gauge reads the required differential pressure for minimum air volume. Turn the dial slowly, allowing time for the damper actuator to complete its travel in response to the adjustment.
7. Cycle the thermostat several times. This can be quickly accomplished by removing the cap from the gauge tap (Port G) and varying the bleed rate with finger pressure. Replace cap and check the air flow limits. If set points have changed, repeat steps 1 to 7.

### General

8. Always adjust the “LO STAT” dial first.
9. After calibration is complete, reconnect the thermostat tube to the controller if it has been removed during the calibration procedure.
10. Disconnect the gauge and replace the caps on the tees.
11. Replace the protective metal cover.

### DDC Calibration Procedures

Refer to control contractor documentation for details.

### Electronic Air Flow Adjustment Procedure for Analog Controls

Refer to Price Analog Controller (PAC) Manual.

### Electronic Air Flow Adjustment Procedure for Digital Controls

Refer to Price Intelligent Controller (PIC) Manual.



# FAN POWERED VARIABLE VOLUME TERMINAL UNITS

## PNEUMATIC CALIBRATION PROCEDURES

### FPV, FEV, FDV Calibration Curves

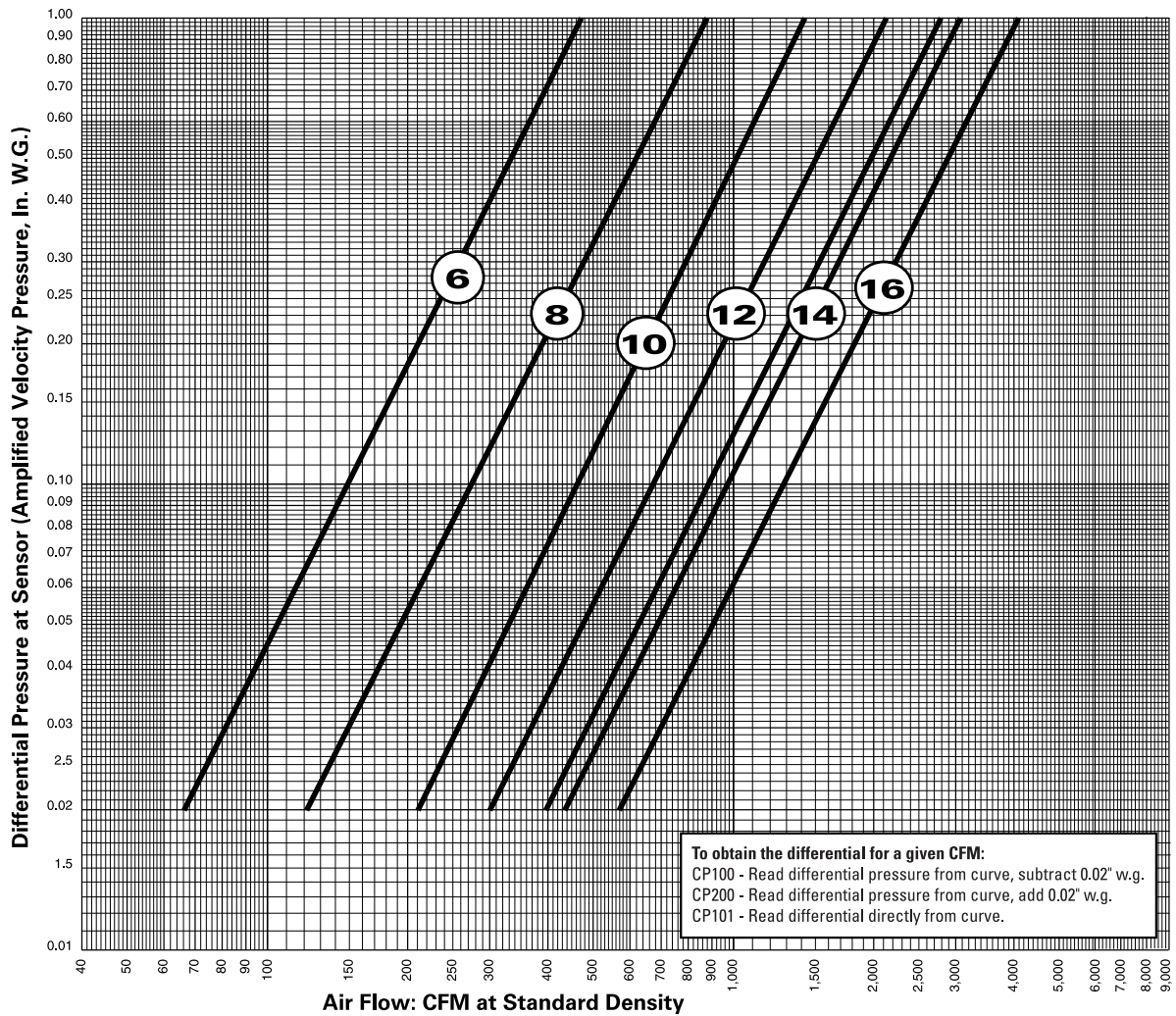

1. Gauge taps are normally supplied with the pneumatic controls to allow field measurement of the differential pressure at the sensor with a manometer, magnahelic or other measuring device.

If the terminal velocity controls utilize a flow-through transducer, a proper velocity pressure reading will NOT be read at the gauge taps and the calibration curves CANNOT be used for field measurement. The flow-through transducer operates on the principle of mass flow rather than pressure differential.

Controls utilizing a dead-ended pressure transducer will allow field measurement with the gauge taps and calibration curves provided.

2. Setting flow limits for a differential pressure of less than 0.02 inches in NOT recommended. Stability and accuracy of flow limits may not be acceptable due to low velocity pressure signal. Performance will vary depending on the terminal unit controls provided.
3. For field calibration of air flow limits refer to the control contractor's documentation.

### Calibration Equation

$$VP = \left(\frac{Q}{K}\right)^2$$

**VP** - differential pressure at sensor, inches w.g.

**Q** - air flow rate, cfm at standard density.

**K** - calibration constant

Unit Size	K
6	468
8	890
10	1487
12	2141
14	3045
16	4074

# FAN POWERED VARIABLE VOLUME TERMINAL UNITS

## MAINTENANCE

### Troubleshooting Guide

<p><b>General</b></p>	<ol style="list-style-type: none"> <li>1. Confirm fan box size and rating with blueprint and box schedule (check Control Assembly label on terminal unit).</li> <li>2. Visually check pneumatic and electrical connections with the Control Wiring diagram(s) located inside the electrical enclosure or in the applicable controls brochure.</li> <li>3. Verify that the supply voltage is the same as specified on the control diagram(s) or Voltage Information label.</li> <li>4. Confirm main air pressure (15 psi min., 25 psi max.)</li> </ol>
<p><b>Noise</b></p>	<ol style="list-style-type: none"> <li>1. Foreign material in fan.</li> <li>2. Relay chatter.</li> <li>3. Fan or duct size selection too small for application causing high air velocity.</li> <li>4. Vibrating duct work.</li> <li>5. Unbalanced fan wheel causing it to hit the housing.</li> </ol>
<p><b>Primary Air Volume not as Specified</b></p>	<ol style="list-style-type: none"> <li>1. Check controller operation, adjust if necessary.</li> <li>2. Check for proper control signal from thermostat. Cycle thermostat and monitor.</li> <li>3. Check operation of damper actuator and leakage.</li> <li>4. Confirm sufficient inlet duct static pressure is available at the terminal unit.</li> <li>5. There should be a minimum of 3 duct diameters of straight inlet duct, either sheet metal or flexible. It is to be the same size as the inlet, between the unit inlet and any transition, take-offs or fittings. Poor inlet conditions may necessitate controller re-calibration.</li> <li>6. Check the flow sensor for blockage.</li> </ol>
<p><b>Air Volume Not As Specified</b></p>	<ol style="list-style-type: none"> <li>1. Check filter for excessive dust build-up.</li> <li>2. Check fan for particle blockage.</li> <li>3. Check coils for particle blockage.</li> <li>4. Measure downstream static pressure, it must be no less than 0.10 inches W.G. in order to keep the fan from overheating.</li> <li>5. Verify that the supply voltage is the same as specified on the wiring diagram. <b>See wiring diagram pasted on the inside of the electrical enclosure or in the applicable controls brochure.</b></li> <li>6. Insulating duct liner loose.</li> <li>7. Unit was not air balanced. See Air Balancing Procedure on <b>page 7</b>.</li> <li>8. Leaks in duct work.</li> <li>9. Obstruction in duct work.</li> <li>10. Sharp elbows near fan outlet.</li> <li>11. Improperly designed turning vanes.</li> </ol>
<p><b>Fan Does Not Operate</b></p>	<ol style="list-style-type: none"> <li>1. Check the unit wiring against the provided Control and Wiring diagrams. <b>See inside cover of the electrical enclosure for diagrams.</b></li> <li>2. Verify that the disconnect switch or breaker is not opened.</li> <li>3. Check for proper control signal from thermostat. See thermostat for full heating and monitor output.</li> <li>4. If fan cycles on and off, check the downstream static pressure. It must be no less than 0.10 inches W.G. in order to keep the fan from overheating.</li> <li>5. Fan wheel may be touching the housing.</li> </ol>

# FAN POWERED VARIABLE VOLUME TERMINAL UNITS

## MAINTENANCE

### Replacement Parts

Component	Part#	Description
<b>PSC Fan Motors</b>	019 150-001	115V - 1/8 HP (Size 20)
	019 152-001	115V - 1/4 HP (Size 30)
	019 154-003	115V - 1/2 HP (Size 40) (Q2 size 10,12, 14)
	019 156-002	115V - 3/4 HP (Size 50 & 70)
	019 588-001	208-240V 1/8 HP (Size 20)
	019 589-001	208-240V - 1/4 HP (Size 30)
	019 590-001	208-240V - 1/2 HP (Size 40)
	019 591-001	208-240V - 3/4 HP (Size 50 & 70)
	019 592-001	208-240V - 1 HP (Size 60)
	019 151-001	277V - 1/8 HP (Size 20)
	019 153-001	277V - 1/4 HP (Size 30)
	019 155-003	277V - 1/2 HP (Size 40) (Q2 size 10,12, 14)
	019 157-003	277V - 3/4 HP (Size 50 & 70)
	019 167-001	277V - 1 HP (Size 60)
<b>PSC Fan Speed Controllers</b>	233 563-100	8A / 115V (Size 20, 30)
	233 563-400	15A / 115V (Size 40, 50, 70) & (Q2 Size 10, 12, 14)
	233 563-200	8A / 208/240/277V (Size 20-70) (Q2 Size 10, 12, 14)
	233 563-500	10A / 240/277V (Size 60)
<b>ECM Motors</b>	019 173-001	115/240V - 1/3 HP (Size 10, 20)
	019 173-002	277V - 1/3HP (Size 10, 20)
	019 171-001	115/240V - 1/2 HP (Size 30, 40, 40, 60)
	019 172-001	115/240V - 1 HP (Size 50, 60, Q2)
	019 171-002	277V - 1/2 HP (Size 30, 40)
	019 172-002	277V - 1HP (Size 50, 60, Q2)
<b>EON Fan Motors</b>	019 178-002	120/240V - 1/3 HP (Size 20)
	019 179-002	277V - 1/3HP (Size 20)
	019 178-001	120/240V - 1/2 HP (Size 30, 40)
	019 179-001	277V - 1/2 HP (Size 30, 40)
	019 178-004	120V/240V - 1 HP (Size 50, 60)
	019 179-004	277V - 1HP (Size 50, 60)
<b>ECM Speed Controller</b>	232 953-100	ECM Standard Fan Speed Controller
	232-953-200	ECM Deluxe Fan Speed Controller
<b>Disconnect Switch</b>	019 903-001	115/277V - 15A
	019 903-003	208/240V - 30A
<b>Capacitors</b>	019 874-001	5 mfd
	019 874-006	7.5 mfd
	019 874-002	10 mfd
	019 874-003	15 mfd
	019 874-007	20 mfd

# FAN POWERED VARIABLE VOLUME TERMINAL UNITS

## MAINTENANCE

Component	Part#	Description
<b>Blowers</b>	100 185-001	Size 10
	100 186-001	Size 20
	100 186-002	Size 30
	100 091-001 + 100 092-001	Size 40 (Q2 size 10, 12, 14)
	100 091-001 + 100 186-003	Size 50
	100 092-002	Size 40 (Morrison)
	100 091-001 +100 186-005	Size 60
	100 092-001	Size 70 (Qty = 2)
<b>Controllers</b>	For controls information please reference PIC & PAC manual	
	076 730-002	Pneumatic CP100 Controller
	076 824-001	Pneumatic CP200 Controller
	076 823-001	Pneumatic CP101 Controller
<b>Actuators</b>	For actuators information please reference PIC & PAC manual	
	076 857-001	Pneumatic MCP-8031 Actuator
<b>Thermostats</b>	For thermostat information please reference PIC & PAC manual	
<b>Control Components</b>	076 813-001	Pressure Diverting Relay
	076 811-001	Lo Pressure Selector
	076 817-001	Hi Pressure Selector
	019 873-001	P-E Switch
	019 436-004	115/24V - 20VA Transformer
	019 436-001	115/24V - 50VA Transformer
	019 436-005	277/24V - 50VA Transformer

# FAN POWERED VARIABLE VOLUME TERMINAL UNITS

## MAINTENANCE

Filter Size		1" MERV 3 Filters	Part #	
Height	Width		Base #	Dash #
9.875	17.375	FDC 10	042297	038
11.875	13.875	FDCG 20		029
12.000	17.375	FPC 20, 30, 40(FAI)		005
13.500	9.875	FPVLP 20(w.c.), FPCLP 50		018
14.875	17.375	FPC/FPV 20, 30 & FPV 30(w.c.)		003
15.500	12.375	FPCU 40, FPCLP 40, FPV 20, 30 (w.c.)		019
15.750	19.875	FPC 70, FDC 50(FAI), FDCG 70		015
15.875	17.875	FDCG 30		030
17.875	17.375	FDV 40(w.c.)		039
17.875	17.875	FDCG 40		031
17.875	19.875	FPCQ2 10,12,14		009
18.000	10.375	FPCLP 20(IAS)		026
19.875	17.375	FPC 60(FAI) & FPC 40 & FPV 40(HC) & FPV 50(w.c.)		006
20.000	10.375	FPVLP 20, 30		023
20.500	13.875	FPV 20, 30		020
20.875	9.750	FPCU 10, 20, 30 & FPBU 20, 30, 50 & FPCLP 20, 30		021
20.875	12.250	FPBU 40, 60 & FPVLP 40		022
22.000	10.375	FPCLP 30(IAS) & FPVLP 30(w.c.)		025
22.000	12.375	FPVLP 40(w.c.)		027
23.000	19.875	FPC 50, 60 & FPV 50, 60 & FDCG 50		014
25.500	17.875	FPV 60(w.c.)		017
29.875	17.375	FPV 50 (HC), 60(HC)		024

Filter Size		2" MERV 3 Filters	Part #	
Height	Width		Base #	Dash #
9.500	19.500	FDC 10	042314	007
11.375	23.375	FDC/FAI 20, 30 & FDCG 10, 20		008
11.500	29.500	FDC/FAI 40		009
13.500	24.500	FDV 20, 30(w.c.) & FDCGQ 10, 20		010
14.500	24.500	FDC 20, 30 & FDV 20, 30		011
14.500	34.500	FDC/FAI 50		012
15.500	24.500	FDC 70 & FDCG 30, 60, 70 & FDV 40(w.c.) & FDCGQ 30, 60, 70		013
16.500	34.500	FDC/FAI 60		014
17.500	24.500	FDCG 40 & FDV 40 & FDV 20, 30(HC w.c.) & FDCGQ 40		015
19.500	24.500	FDC 40 & FDV 50(w.c.) & FDV 40(HC w.c.)		016
23.375	23.375	FDC 50, 60 & FDCG 50 & FDV 50, 60 & FDV 60(w.c.) & FDCGQ 50		017
27.500	24.500	FDV 50, 60 (HC w.c.)		018

Filter Size		2" MERV 8 Filters	Part #	
Height	Width		Base #	Dash #
9.500	19.500	FDC 10	042313	007
11.375	23.375	FDC/FAI 20,30 & FDCG 10, 20		008
11.500	29.500	FDC/FAI 40		009
13.500	24.500	FDV(W.C.) 20, 30 & FDCGQ 10, 20		010
14.500	24.500	FDC 20, 30 & FDV 20, 30		011
14.500	34.500	FDC/FAI 50		012
15.500	24.500	FDC 70, FDCG 30, 60, 70 & FDV 40(w.c.) & FDCGQ 30, 60, 70		013
16.500	34.500	FDC/FAI 60		014
17.500	24.500	FDCG 40, FDV 40 & FDV 20, 30(HC w.c.) & FDCGQ 40		015
19.500	24.500	FDC 40 & FDV 50(w.c.) & FDV 40(HC w.c.)		016
23.375	23.375	FDC 50, 60 & FDCG 50 & FDV 50, 60 & FDV 60(w.c.) & FDCGQ 50		017
27.500	24.500	FDV 50, 60(HC w.c.)		018





---

This document contains the most current product information as of this printing.  
For the most up-to-date product information, please go to [priceindustries.com](http://priceindustries.com)

© 2014 Price Industries Limited. All rights reserved.

**PRICE<sup>®</sup>**