



Chapter 2

Basic Pattern Development

2.1 PATTERN MAKING

2.1.1 Introduction:

Pattern Development & its origin

Pattern Designing is an extensive subject that covers principles of constructions and techniques in a wider perspective rather than style details. It opens opportunities for creating infinite styles. Pattern construction can be divided in two parts:

- i) Measuring correctly
- ii) Knowledge of technique with which they are applied.

Learning pattern-making by trial and error is like learning to play music by ear. The earlier methods of pattern making generally used shapes by copying and reconstructing them.

Several systems of pattern constructions were devised in the early days of tailoring, long before clothing industry came in existence. They served the needs of a busy tailor who generally required a guide for drafting garments directly on to the cloth. As each garment was cut individually to varying measurements, pattern drafting had to be simple and speedy in operation. Since speed was an important factor, systems were devised to include necessary seam allowances. The system now used for pattern development is called Block Method where seam allowances are calculated at the time of cutting the final pattern.

The human form comprises complex geometric shapes and presents problems in pattern construction. The accuracy of any cutting system depends largely on relevant and correct measurements. On the other hand, Proportionate Systems seem to offer a ready solution to the problem of unreliable or incorrect measurements. The Proportionate Systems work on the principles that the whole body is divided into eight heads and the girth measurements are in proportion to each other. Pattern makers generally tried to find an ideal system and did not realize that a system laid down by one method may not fully satisfy the needs of another human figure since no two human forms can be identical.

Pattern construction systems are largely dependent and influenced by the particular fashion of their period. Seam placement and suppression are an integral part of a draft wherein design cannot be altered without disturbing the garment balance. However experienced pattern makers invariably took the precaution of adding sufficient inlays or allowance in the main seam of garment as a safeguard against error of judgment.



Lack of reliable data on body measurements has, to a large extent, has been responsible for the continued used of systems based on theoretical proportional measurements. W. H. Hulme wrote in his book "The Practice of Garment Pattern Making wrote:

"The clothing industry has been prolific in systematic methods of applying descriptive data and it is fair to say that in many of these pattern systems the principles involved have not been too obvious, or even clearly stated. Several years of study of English. American and European pattern systems suggest that method may be unrelated to, or divorced from, principles. The widest variations exist in that large group of systems which not only do not state the principles applied, but which seem to proceed on the assumption that none exists, and that the whole operation is empirical".

"At the beginning let it be said that the word 'system' connotes something soundly based and rooted in reason, capable of being demonstrated and the results applied. If a point is fixed, or a part located for a sound reason, that reason can and should be given. If the working of a law is detected in a number of similar instances, that law should be capable of statement and proof".

Philip Kunick in his book 'Modern Sizing and Pattern Making for Womens and Childrens Garments' writes that it is still a common practice to teach pattern construction for the wholesale trade by means of a drafting scale based on a girth measurement, not only for fixing points or locating parts, but also for drafting a garment of any size. This is rarely done in the wholesale trade, where it is the general practice to cut a pattern in a standard size, indication that the exact dimensions are not known and proportionate measurements must be used as substitutes; with the result that extreme sizes, drafted to a hypothetical scale, rarely give a satisfactory fit.

Due to unreliability of cutting systems, many pattern designers started draping their patterns on a dress form. A skillful designer can achieve good results but this method is inefficient and time-consuming for the ready to wear market. The modern methods base their foundations on principles of draping in the two-dimension form balance. Balance is the underlying objective while manipulating pattern balance is a vertical relationship between the front and back. If the balance of a pattern is faulty it means that accuracy of all vertical measurements is lost.

There were just 18 pattern cutting books including that of Alcega published from the 16th century to the 19th century in Europe. This can be attributed largely to lack of literacy and numeracy prevalent amongst pattern makers, tailors and dress makers at that time. Traditionally the skills were passed to the apprentices through demonstration and verbal instructions.

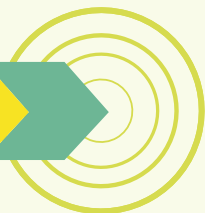



2.1.2 Pattern Making

Pattern making is *the process of transforming a design into its constituent flat pattern pieces and then drafting them out*. The job of a pattern-maker is to interpret the designs into sample pattern pieces and then drafting them. Pattern making covers principles of constructions and techniques in a wider sense rather than style details in a narrow sense (Armstrong, 2000). It opens scope for infinite variety of styles both for regular designs and innovative patterns. Pattern making can be divided in two parts namely measuring correctly & knowledge of technique devised to include necessary seam allowances. Measuring the human body is the precursor to developing garments to fit the body. Measuring scales range from simple measuring tape to complex body scanners and low to high tech.

Pattern for a garment is the blue print on the basis of which the fabric is cut and the same is achieved by two methods:

- + Flat Pattern Method
- + Draping Method

Flat Pattern Method is a method where in body or dress form measurements are taken for developing a pattern. Following a logical stepwise procedure, the measurements are then converted into a pattern. In other words this system depends on accurate measurements to complete the paper pattern. There are limitless designs, which can be achieved for workable garments. Flat pattern making should be done in conjunction with a dress form so that as the design evolves, proportion and balance in the garment can be checked side by side. It is important to transfer the pattern on to a muslin (toile pronounced as 'twall') to test the fit, on a dress form or a human figure.

Flat Pattern cutting is now widely used because of its accuracy of sizing and the speed with which complicated designs are made. It is a system of creating patterns by manipulating a basic block. It is widely used for the following reasons:

1. The basic block includes ease allowance which allows the body to perform a variety of normal body functions requiring movement of various body parts.
2. The method is logical and easy to understand.
3. It brings consistency and accuracy of both size and fit of mass-produced garments
4. It is also the fastest and most efficient pattern design method even for complicated designs.

Draping method is the oldest pattern making method and is generally regarded as a creative approach. In this method a piece of two-dimensional fabric is draped directly on a dress form or figure and made to fit on the dress form to achieve the desired look or shape. The fabric may conform to the basic shape of the form or be arranged artistically



in folds for a specific design. This muslin pattern is then transferred on the paper, and corrections are made, if any, and then the same are converted into a final pattern.

2.1.3 Terminology

I. Block/sloper

Sloper is a term given to a very basic set of pattern pieces used to make additional patterns of any style. It refers to paper cutting of basic bodice, skirt, sleeve or any such basic pattern from which all the other designs are developed. The Block normally represents the dimensions of a specific form or figure. It has darts to fit to the contours of the body but has neither any design features nor seam allowances. It is the foundation used to make the pattern of a design.

It is important that the correct block is chosen for the design; this not only saves time during adaptation but can affect the final shape. The basic blocks can be drafted to fit individual figures by using personal measurements instead of the standard measurements listed in the size chart.

Name of the block e.g. skirts front, bodice back etc.

- + Grain line
- + Size e.g. 32, 34, 36 or S, M, L

The block should carry the following information:-

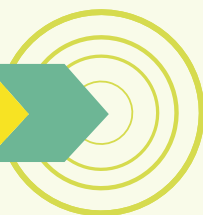
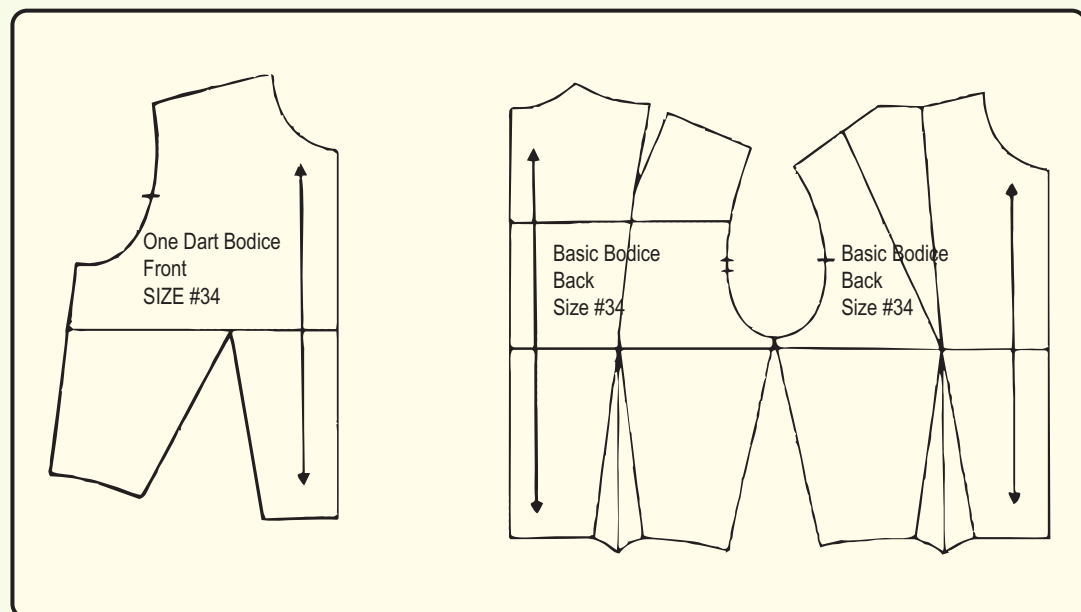

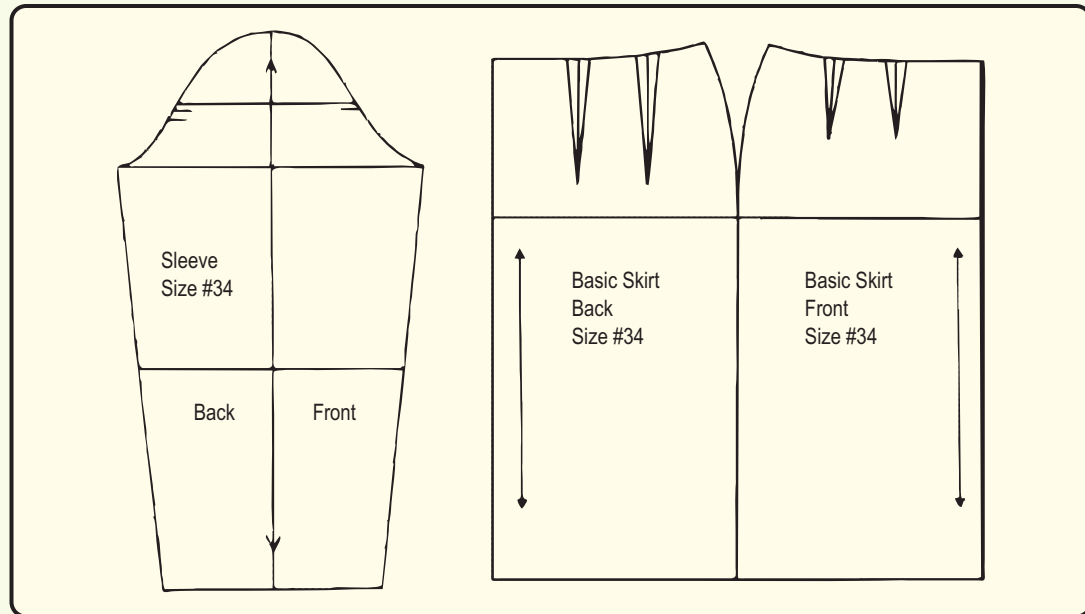

ii) Pattern

Pattern is developed from the block that includes all the information needed for cutting and production of the garment including seam allowance.

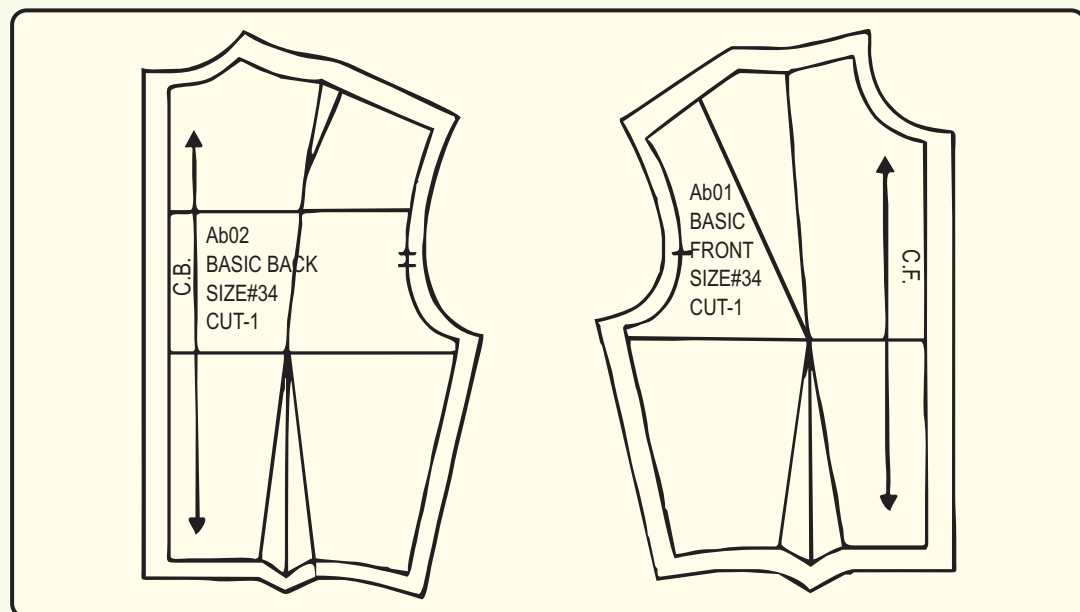

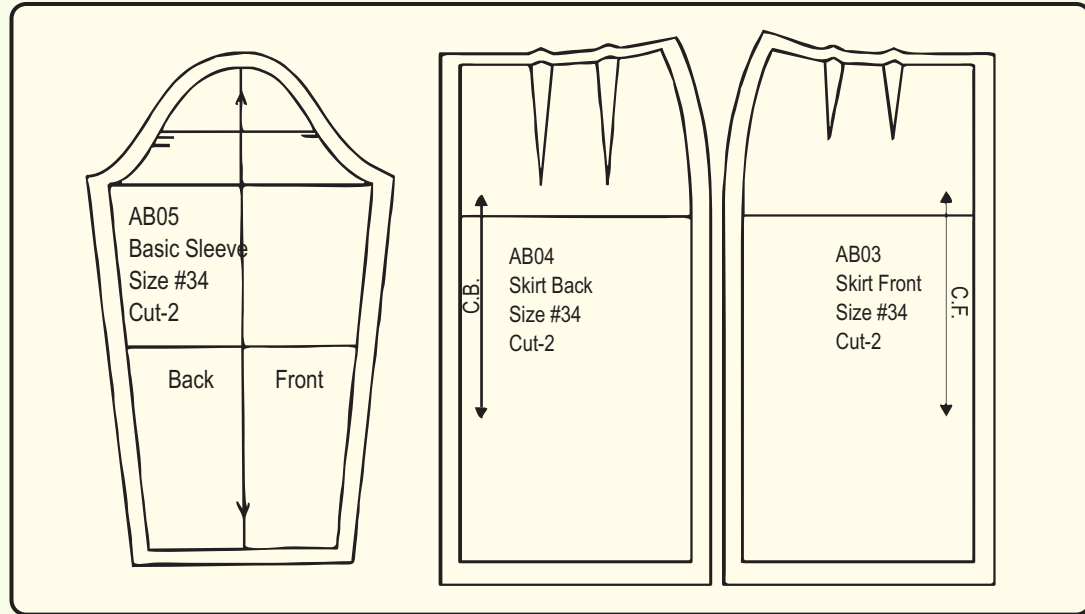

The following should be included on a pattern:

- + **Grain line**
- + **Centre Front or Centre Back**
- + **Style number or Code number** of the pattern set may which be evolved e.g. **AB 01** here AB identifies type of the garment and 01 identifies the piece number of complete set. If there are 5 pattern pieces in a garment, the pieces will be numbered as AB 01, AB 02, AB 03, AB 04 and AB 05.
- + **Pattern piece** e.g. skirt front, skirt back, side front etc.
- + **Size** as 32, 34, 36, or S, M, L etc.
- + **Cutting information** - It should be clearly mentioned as to how many pieces are to be cut e.g. Cut 1, Cut 2, Cut on fold.
- + **Notches** - Marks that are needed to help assemble garment sections correctly.
- + **Directional Fabrics** - For fabrics which have designs in one direction such as floral print, stripes, plaid, velvet, fur etc. A symbol "cut one way" or (?) is indicated on the pattern.
- + **Date** - Indicated as a reference point.
- + **Seam Allowances**

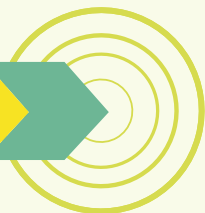



iii) Seam Allowances

The amount of seam allowance required for each seam line may vary depending on the location and end purpose. Generally these are the measurements followed:

- ¼" for sharp curves
- ½" for neckline, armhole, waistline, style line.
- 1" for side seam, centre line, shoulder, plackets.
- 2" for straight hem line.

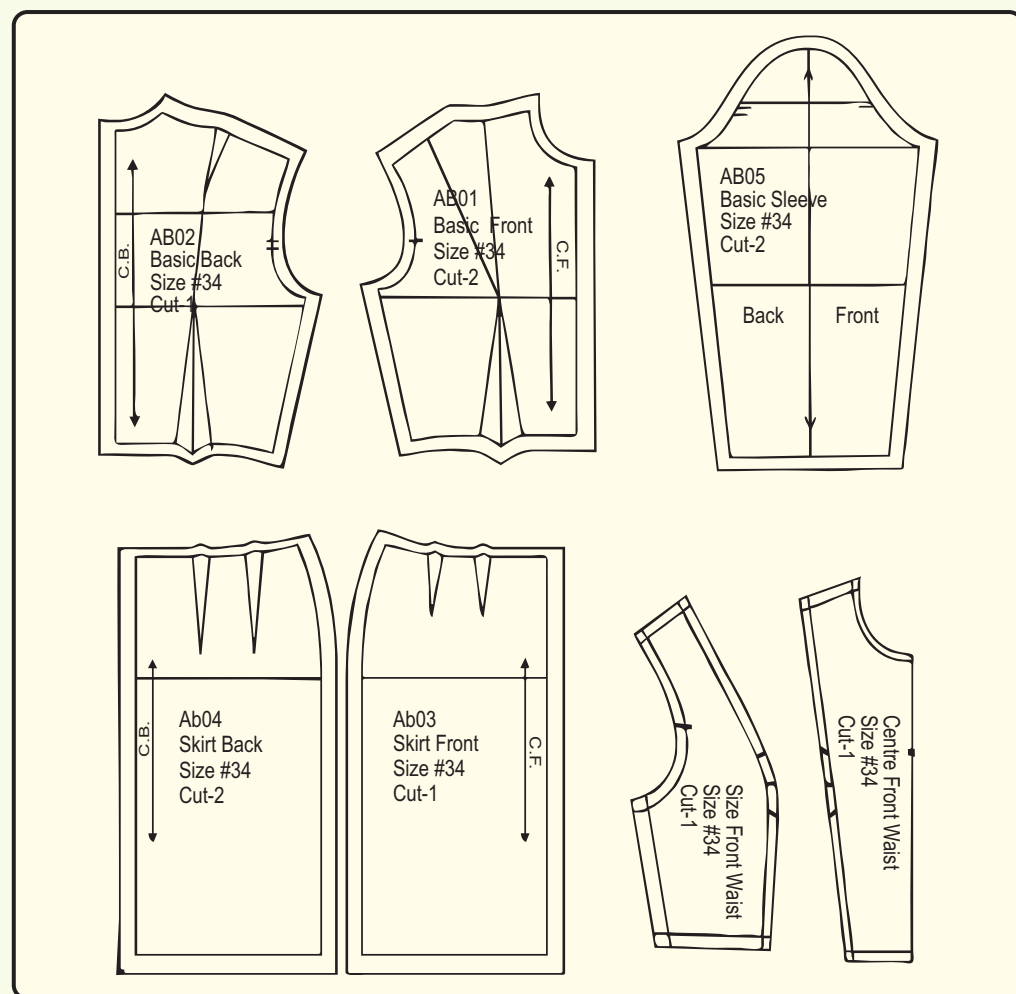

iv. Muslin

Muslin is used for making test fits. This is basically an unbleached plain woven cotton fabric available in light, medium and heavy weight. Medium quality muslin is generally used for test fitting and draping.



v. Grain line

Grain line is a line drawn from end to end on each pattern piece to indicate how the pattern should align with the lengthwise grain of the fabric. Whichever be the direction in which the grain line is drawn on the pattern, it will always be placed parallel to the selvedge on the fabric.

vi. Balance

Refers to hang and also proportions in garments. Fashion dictates balance to a certain extent, for example long tops over short skirts. Where flat pattern cutting is concerned it is often difficult to judge correct balance until the garment is actually made in fabric.

vii. Balance Marks

These are marks made on edges of pattern pieces that show where they are to be matched. They are a useful construction guide on all seams but where edges of different shapes are to be joined or where one edge is fuller than another, balance marks are vital. In pattern cutting make short pencil marks at the edge of the paper, copying them through all stages to the final pattern. On bought paper patterns balance marks are indicated by indicated by triangles and are referred to as notches

viii. Dart

Dart is a wedge-shape or triangular shape marked on the pattern that controls the fit of the garment.

Dart legs-The two sides of the triangular shape & should be of the same length.

Dart point - The point at which the dart ends.

Dart intake - The amount of suppression taken between the dart legs.

Apex - The highest point on the bust.

Darts radiate from the highest point of a mount on a body, these mounts are generally rounded. If the darts on front bodice are stitched till the apex they would create a point on the apex and strain the garment. The body is rounded and not pointed hence to avoid these strains or pulls on the garment the darts need to be finished away from apex.

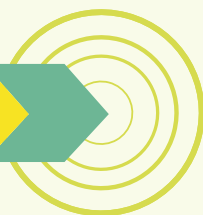

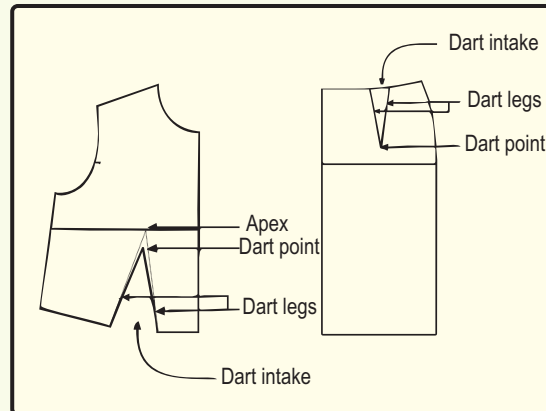

Single Dart Pattern

In this a single dart is there for entire suppression required. Dart ends $\frac{1}{2}$ " away from the bust point.

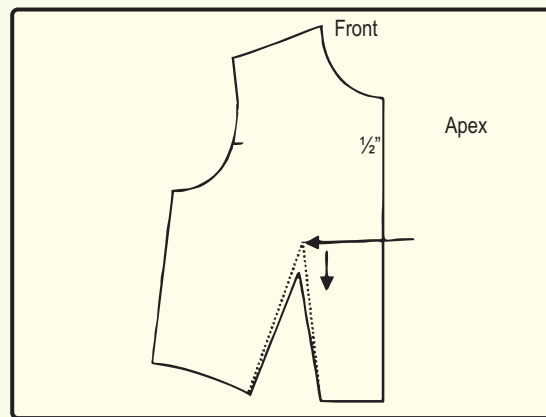

Two Dart Pattern

Waist dart is $\frac{3}{4}$ " to 1" away from the bust point.

Other dart is $\frac{3}{4}$ " to 1 $\frac{1}{2}$ " away from the bust point.

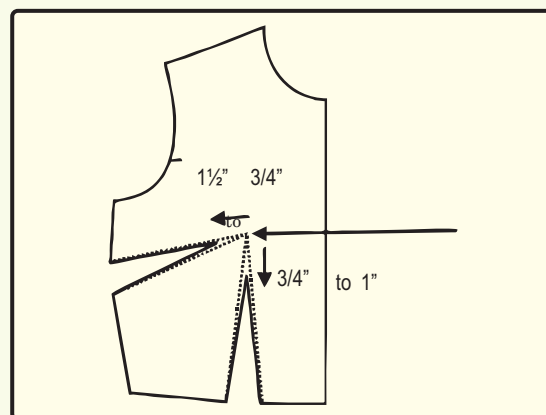



2.1.4 Symbols and Abbreviations

Centre Front	-	CF
Centre Back	-	CB
Grain line	-	
Notches	-	< ı
Buttons	-	⊖
Button hole	-	┌┐
Front	-	F
Back	-	B
Waist line	-	Wl
Arm hole	-	Ah
Side Seam	-	SS
Neck line	-	NI
Shoulder	-	Sh
Grain line on fold	-	
Gathering	-	
Pleat (arrows indicates direction of fold)	-	↔
Box pleat	-	
Two way grainline	-	↕
One way grainline	-	

Activity

Collect pictures of womenswear garments and create a folder/ style file.

Identify the type of darts and seams used in the garments.

Fill in the blanks

- A pattern can be cut by _____ method and _____ method.
- Pattern is a _____ of a garment.
- The author of the book 'Modern Sizing and Pattern Making for Womens and Childrens Garments' is _____.
- The dart is a _____ wedge that gives _____ to the flat piece of _____.
- Waist dart is _____ inch away from the bust and side seam dart is _____ away.

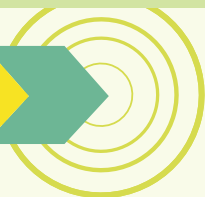



- f. Balance refers to _____ and _____ in a garment.
- g. Muslin is used for _____ a pattern and is also called a _____.
- h. Pattern is placed _____ on the _____ of the fabric.
- i. _____ is a term given to _____ set of pattern piece used to make patterns of _____ style.
- j. _____ method is the oldest patter making method and is regarded as a _____ approach.

Review Questions

1. What is Pattern Making?
2. Describe two methods of Pattern making
3. Why is it important to choose a correct block for design development?

2.2 Measurements

2.2.1 How to take Measurements

Care should be taken to take accurate measurements in order to achieve a good fit. It is extremely important to understand the dress form before starting to take dress form measurements. One should carefully observe the shape of the body, where it is hollow, how shoulder slopes etc.

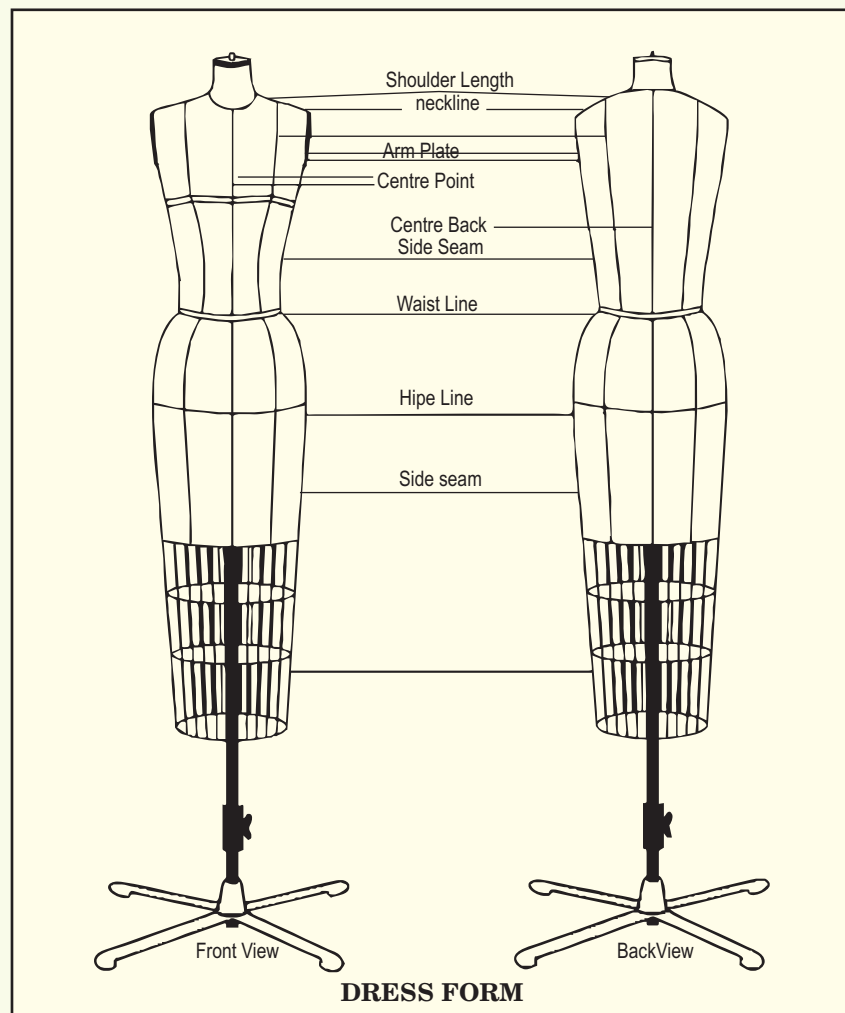



Measurements

1. **Front length** - Shoulder neck intersection to waistline over the bust, take care to measure with a hand under the bust.
2. **Centre front length** - Centre front neck intersection to centre front waist intersection.
3. **Shoulder to waistline** - Shoulder tip to side seam waistline intersection (over the sides)
4. **Underarm seam** - From a point X, 1" below the armhole to waistline intersection at the side seam.
5. **Shoulder length** - From shoulder neck intersection to princess line and from princess line to shoulder tip.
6. **Width of bust** - Width of bust measurement is from centre front over the bust to point X on side seam.
7. **Front waistline** - From center front waistline intersection to side seam waist line intersection.
8. **Front hipline** - Place a pin at 7" below the waistline on centre front line.

Using this measurement as a guide, from the floor, mark horizontally on the dress form, starting at center front and continue to side seam (keeping it uniform throughout). Put a style tape for reference and this is the hip line. On this line marked by style tape, take measurement from center front intersection to side seam intersection.

9. **Apex measurement** - From the centre front to the high bust point keeping the tape parallel to the floor.
10. **Centre Front to the Princess line** - From centre front intersection to princess line intersection at waistline.

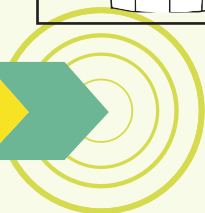
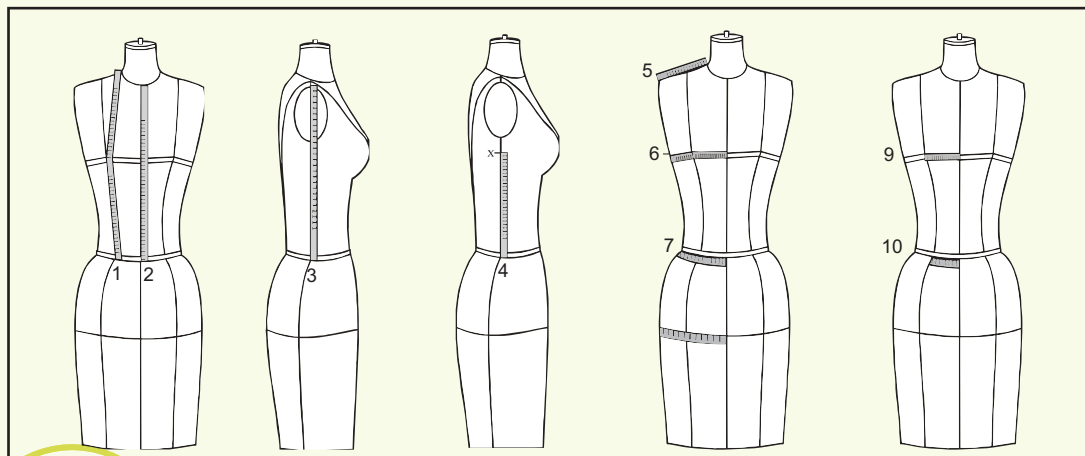



11. **Shoulder blade** - Mark a point Y on centre back such that, centre back neck intersection to point Y is equal to 1/4th of centre back length. Shoulder blade measurement is taken from point Y to armhole ridge keeping the tape parallel to the floor.
12. **Width of back** - From point X to centre back keeping the tape parallel to the floor.
13. **Back waistline** - From centre back waistline intersection to side seam waistline intersection.
14. **Back hip line** - From centre back intersection to side seam intersection on hip line marked by style tape.
15. **Centre Back length** - From centre back neck intersection to centre back waistline intersection.
16. **Centre back to princess** - From centre back intersection to princess line intersection at the Princess Line waistline.

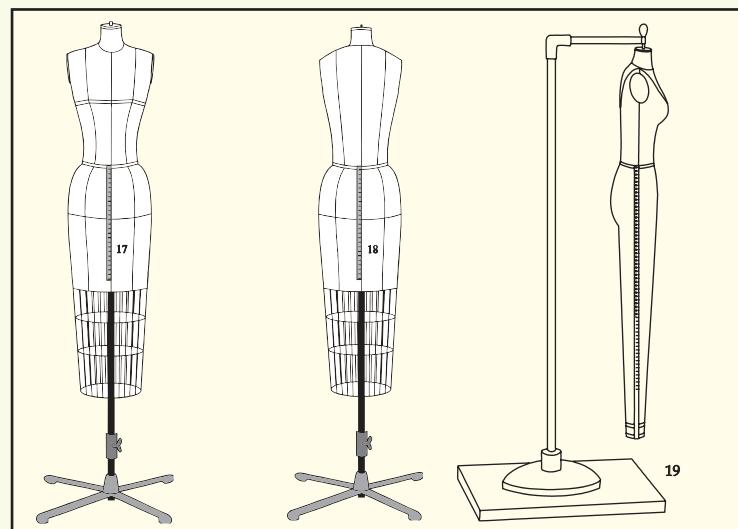
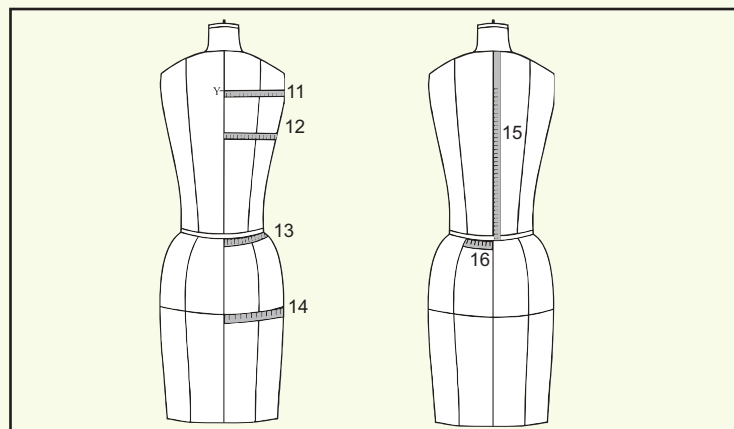

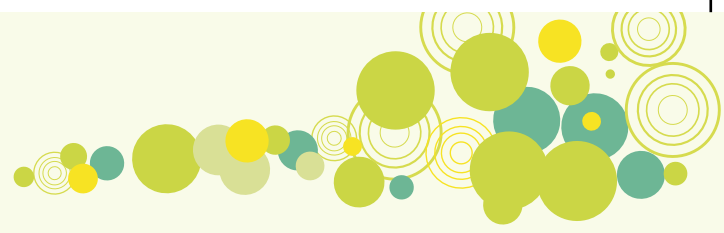

17. **Centre Front length for lower garment** - From centre front waistline intersection at centre front down to the desired length.
18. **Centre Back length for lower garment** - From centre back waistline intersection at centre back down to the desired length.
19. **Side Seam Length** - From waistline intersection at side seam over the hip to ankle.
20. **Crotch depth**
 - (a) On dress form - Place an L-square between legs of form and note the measurement at waistline. This measurement includes $1\frac{1}{4}$ " ease as the L-square is generally $1\frac{1}{4}$ " wide.
 - (b) On body - In seated position, measure from waistline intersection at side seam over the figure to the seat of the chair. (One needs to add ease here.)
21. **Knee Circumference** - Round measurement over the knee bone.
22. **Ankle Circumference** - Round measurement over the ankle bone.

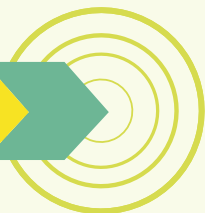
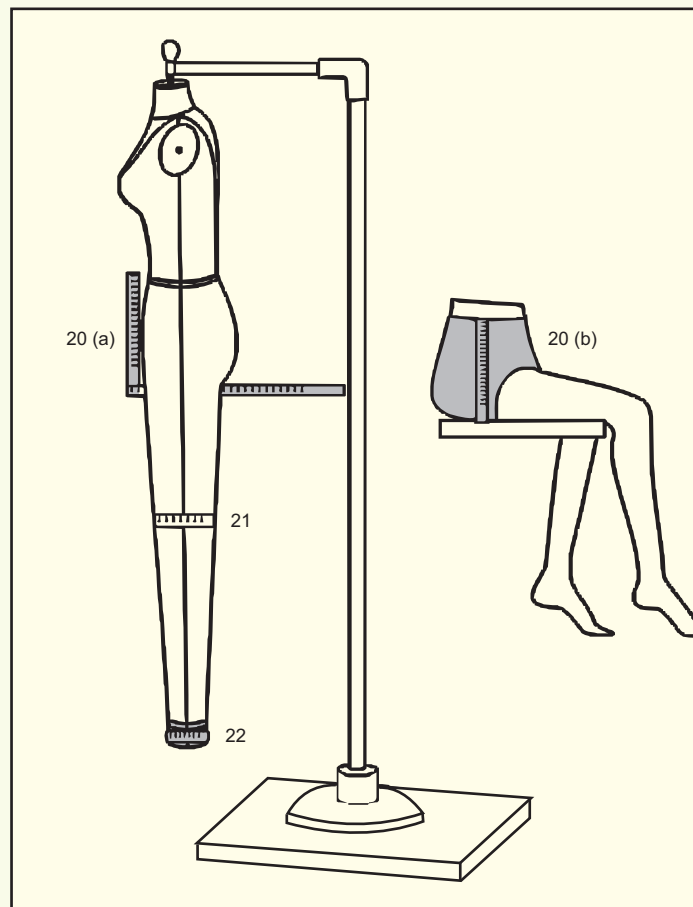



23. Cap height - Tie a tape around the biceps of arm close to the armpit. Cap height is from shoulder intersection to the top of the tape.
24. Sleeve length-From shoulder intersection over the bent elbow to the wrist.
25. Bicep Circumference - Round measurement to be taken over the fullest part of the arm.
26. Elbow Circumference - Round measurement over the elbow.
27. Wrist Circumference - Round measurement over the wrist bone.

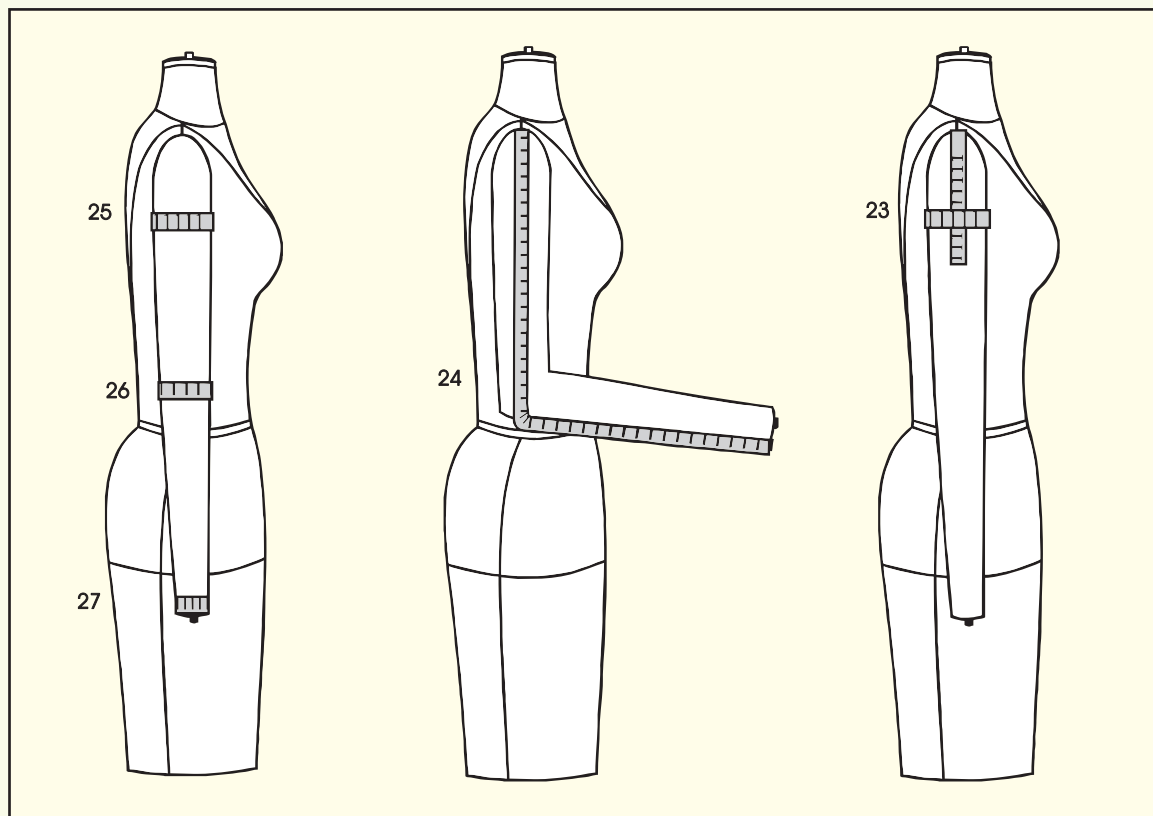

Activity

- Measure a dress form in the class.
- Measure your classmate whose body proportions resembles the dress form.
- What are the differences in the two measuring methods you use?

Fill in the blanks

- a. Center Front is the line that divides the front _____ in two _____.
- b. Ankle should be measured around the _____.



- c. Correct sleeve length is taken by measuring over a _____.
- d. Bodice length is measured by measuring from neck ____ to apex and waist by placing a _____.
- e. Crotch depth on a body is measured by making the _____ sit on a _____ surface and it is measured from _____ to _____.
- f. Apex is measured by taking the measurement from shoulder _____ to the apex point.
- g. Distance between the apex and center _____ is measured by _____ the distance between _____ points in _____.
- h. Shoulder blade level is measured at _____ of _____.

Review Questions

1. What are the 2 ways of measuring the Crotch Length?
2. How do you measure bust and shoulder length on the dress?

2.2.2 Standard Dress Form Measurement Chart For Bodice & Skirt (in inches)

SIZES	32	34	36	38	40	42	44
FRONT LENGTH	17 ^{1/4}	17 ^{1/2}	17 ^{3/4}	18	18 ^{1/4}	18 ^{1/2}	18 ^{3/4}
WIDTH OF BUST (1" below arm plate includes an ease of 1/2")	9 ^{1/2}	10	10 ^{1/2}	11	11 ^{1/2}	12	12 ^{1/2}
CENTRE FRONT LENGTH	14 ^{3/8}	14 ^{1/2}	14 ^{5/8}	14 ^{3/4}	14 ^{7/8}	15	15 ^{1/8}
APEX	3 ^{5/8}	3 ^{3/4}	3 ^{7/8}	4	4 ^{1/8}	4 ^{1/4}	4 ^{3/8}
UNDER ARM SEAM	7 ^{7/8}	8	8 ^{1/8}	7 ^{1/2}	8 ^{3/8}	8 ^{1/2}	8 ^{5/8}
FRONT WAISTLINE (includes an ease of 1/4")	6 ^{3/8}	6 ^{3/4}	7 ^{1/8}	8 ^{1/4}	7 ^{7/8}	8 ^{1/4}	8 ^{5/8}
WAISTLINE TO SHOULDER (includes an ease of 3/4")	14 ^{3/4}	14 ^{7/8}	15	15 ^{1/8}	15 ^{1/4}	15 ^{3/8}	15 ^{1/2}
SHOULDER LENGTH	4 ^{7/8}	2 ^{3/4}	5 ^{1/8}	5 ^{1/4}	5 ^{3/8}	5 ^{1/2}	5 ^{5/8}
CENTRE FRONT TO PRINCESS LINE	2 ^{5/8}	9	2 ^{7/8}	3	3 ^{1/8}	3 ^{1/4}	3 ^{3/8}
WIDTH OF BACK (1" below arm plate includes an ease of 1/2")	8 ^{1/2}	5	9 ^{1/2}	10	10 ^{1/2}	11	11 ^{1/2}
CENTRE BACK LENGTH	16 ^{1/2}	16 ^{3/4}	17	17 ^{1/4}	17 ^{1/2}	17 ^{3/4}	18
BACK WAIST LINE (includes an ease of 1/4")	5 ^{5/8}	6	6 ^{3/8}	6 ^{3/4}	7 ^{1/8}	7 ^{1/2}	7 ^{7/8}
SHOULDER BLADE	6 ^{7/8}	7	7 ^{1/8}	7 ^{1/4}	7 ^{3/8}	7 ^{1/2}	7 ^{5/8}
CENTRE BACK TO PRINCESS LINE	2 ^{1/2}	2 ^{5/8}	2 ^{3/4}	2 ^{7/8}	3	3 ^{1/8}	3 ^{1/4}

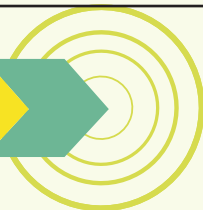



FRONT HIPLINE (7" below waistline)(includes an ease of 1/4")	9 ^{1/8}	9 ^{3/8}	9 ^{5/8}	9 ^{7/8}	10 ^{1/8}	10 ^{3/8}	10 ^{5/8}
BACK HIPLINE (7" below waistline) (includes an ease of 1/4")	9 ^{1/8}	9 ^{3/8}	9 ^{5/8}	9 ^{7/8}	10 ^{1/8}	10 ^{3/8}	10 ^{5/8}
CAP HEIGHT	6	6	6	6	6 ^{1/8}	6 ^{1/8}	6 ^{1/8}
SHORT SLEEVE LENGTH	9	9 ^{1/4}	9 ^{1/2}	9 ^{3/4}	10	10 ^{1/2}	10 ^{3/4}
SLEEVE LENGTH	23	23 ^{1/2}	24	24 ^{1/2}	24 ^{1/2}	25	25

2.2.3 Sizes and Measurement

After learning how to measure a body and dress form, the next question that comes to mind is what is the size of an individual or dress form based on the measurements and secondly what size of the garment should be made that would fit the person properly.

A general sizing system for clothing production for a region or country is based ideally on the body measurements taken on a cross section of the population.

In earlier times everyone went to a tailor to get clothes made to ones own measurements. It is in modern times due to changing economy, society and the world, that there is growing demand for 'ready to wear apparel or RTW, which has made sizes and sizing systems very important.

Sizing systems are generally developed by the Government or standardization organizations that need to work out the standard sizes for the country. A large cross section of the population is measured to establish the standardized sizing system for the country. For example it is British standards with BS3666, which has established the sizing system for the British clothing Industry. All the shops selling garments or manufacturers for clothes for the UK market adhere to the BS3666. The size is suffixed with S or T denotes whether for a short or tall person. The buyer in UK can easily buy clothes of their size if one is sure of which size would fit, as generally all the garments in that particular size would fit the person.

Women have different sizes and shapes and the sizes are so varied that the extent of two women with equal hip girth can have a difference of as much as 12" in their bust measurement. On the other hand, two women of equal bust girth can be completely shaped differently. Most of the sizing systems are based on bust measurements for women.

A good sizing system incorporates the variation in figure shapes to be able to meet the requirement of the population of the country.

Apart from the bust and hip girth variation another factor that influences sizes is height. Most small manufacturers tend to ignore the difference in height and produce garments



for above average height women so that most of the shorter women can reduce the length as desired.

The country that has maximum size variation available in the market is United States. The number of the sizes in a sizing system depends on the body structure of the population. In country like India and US the body types of people in various parts (in India) and different ethnic groups (in US) is so varied that the number of sized in sizing system need to be much more than three usual ones - small (S), Medium (M) and Large (L). Some countries work with Extra Small (XS) and Extra Large (XL) and sometimes even XXL. In United States the womenswear sizes are numerical like 2, 4, 6, 8,10,12,14,16,18, 20, 22, 24, 26 etc. Apart from these sizes being available in the market there is 'Misses' and 'Petite' which cater to the medium and shorter women while 'Tall and Big' cater to taller and bigger sizes.

In India currently there is no single standard measurement chart available. Several organizations have been trying to work out the sizing and measurements. Individual companies or businesses work out their own set of measurement charts based on their customers or on the demand of the stores where they sell their products. This sometimes leads to confusion among customers as to what size to buy.

EASE

Ease or tolerance in a pattern means acceptable margin but there is a difference of 'ease of pattern' and 'ease of comfort'. Each garment is made for a purpose, an outerwear needs more allowance as it is to be worn over other garments where as a foundation or inner garment like a bra needs to be fitted like a second skin over the body. Ease added in a pattern for both these garments would vary greatly.

The size that one belongs to depends on the bust and hip measurement. Someone with abnormally large hip or bust in comparison to the other would need to pick up a size that accommodates larger measurement and would have to alter the garment in the other part. For example a women with 36" bust and 48" hip would need to buy either a size which fits 48" hip or may select A-line, flared or tent silhouettes which accommodate the girth of the hip.

Activity

Visit the market and check various womenswear brands what are the different sizes you can identify. Try out garments in different styles and brands do you fit into same size of different brands or is there a difference.

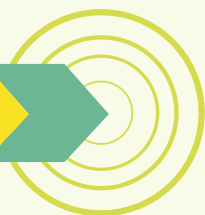



Visit the market and check various womens wear brands. Check the following:

- i. What are the different sizes you can identify.
- ii. Try out garments in different styles and brands. Does the same size of different brands/labels fit the same way or is there a difference?

Fill in the blanks

- a. Standard measurements are _____ in a _____ chart.
- b. Country that has the most elaborate _____ is _____.
- c. Sizing systems are _____ by the _____ or standardization organization for a country.
- d. The standard sizes for the country are established by _____ a _____ cross section of the _____.
- e. In UK sizing system was established by _____ for the _____ Industry.
- f. All garments manufacturers in UK market adhere to the _____.
- g. The size is suffixed with S to denote _____ and T for a _____ person.
- h. Countries have different sizes and _____.
- I. Two women with _____ hip girth can have a difference of _____ in their bust measurement.
- j. Generally _____ systems are based on _____ measurements for women.

Review Questions

1. What is a General Sizing System?
2. Who is responsible for developing the Sizing System?

2.3 TOOLS

2.3.1 Basic Equipment Required



All pines to pine fabric pieces together

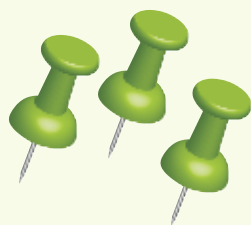

Pin Cushion or Pin holder to keep needles and pins in place.

Push pins to hold paper in place.

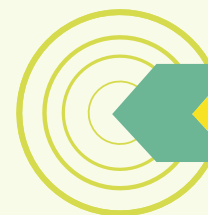



FASHION STUDIES

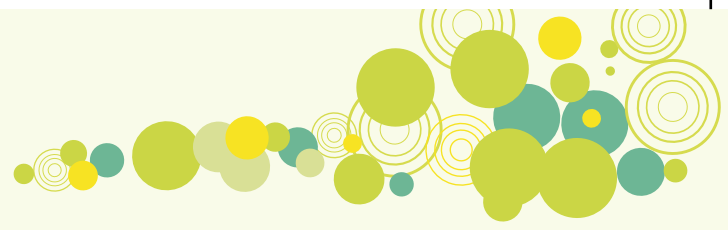

Scissors - large for fabric, another for paper and a small for clipping threads.



Seam ripper for opening any seams or stitches.



Grating scale to mark lines.

Measuring Tape for taking measurements



Pencil, eraser, pencil sharpener, plastic ruler

Pinking shears for finishing the raw edges of fabric.



Papers - plain paper, tracing paper, brown paper, graph paper.

Masking tape to keep fabric in place.

Plastic sheet for making templates.

Permanent pen to write on the templates



Coloured pencils to make rough layouts

Bot to keep things

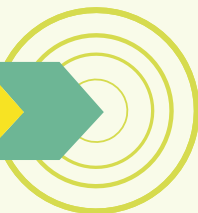



Steam iron to iron out wrinkles.



Awl to make holes in paper

Cutter for cutting paper



Tailors chalk for marking on fabric

Tracing paper for tracing

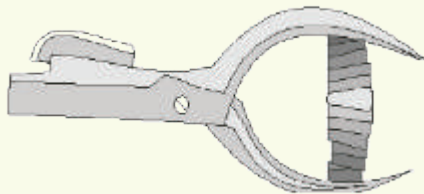

Tracing wheel for transferring the markings

Notcher to mark a paper



Styling tape for marking on dress form

Activity

Visit the school library and refer to books on pattern making.

- + See the different kinds of pattern making tools you can identify.
- + Try to find the tools on internet also.
- + In your scrap book state uses of various tools

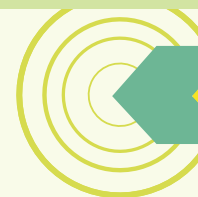

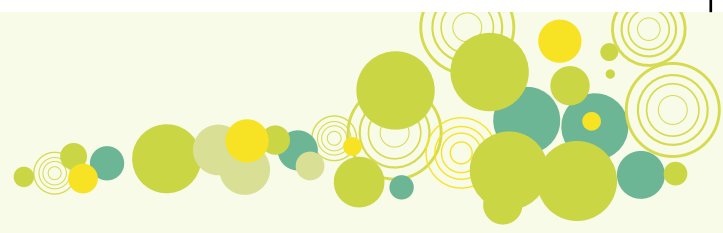

Fill in the blanks

- Grading ruler is used for drawing _____ & _____ in making a pattern.
- The _____ curve is used for drawing the _____ seam in a pattern.
- _____ is used for marking a seam line on a pattern.
- The pattern is made on _____ paper and test fitted on _____.
- _____ is used for marking notches on _____.

Review Questions

- Explain the use of French Curve as a Patternmaking tool
- Explain the use of Tracing Wheel as a Patternmaking tool

2.4 Fit

2.4.1 Garment Fitting

Apparel fit is the relationship between the size and contour of garment and those of the human body. A well fitted garment is a garment that hangs smoothly and evenly on the body, with no pulls or distortion of the fabric, straight seams, pleasing proportions, no gaping, no constriction of the body and adequate ease for movement. Hems are parallel to the floor unless otherwise intended, and the garment armhole and crotch seam do not constrict the body. It can be defined as a simple matter of length and width in each part of the pattern is correct for the human figure.

Fit refers to how well a garment conforms to the three-dimensional human body. Good fit is crucial to customer satisfaction. However, it is often easier to find clothes in the right colours, prices and style that one likes, than a well-fitted garment. The effect of a stunning design, gorgeous fabric and exquisite workmanship are minimized if the finished garment does not fit well on the intended wearer. Fit problems may be caused due to careless design, construction or may be the result of characteristics of an individual's body. No two bodies are alike, and sometimes even the left and right halves of the same body are not mirror images of each other.

New technology promises to overcome these problems; a new computer system can optically measure an individual's body in three dimensions. This data is then converted to a computerized, individual pattern, a man's suit designed by this method is ready to be cut out and ready to sew within 7 minutes of receipt of the measurement data. The resultant garments fit accurately as the computerized scanner detects subtle nuances in the shape of the body that normal measurement systems are unable to read. These

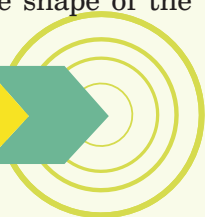



systems are on the stage of trial; but they would be costly and would take a long time to be readily available.

There are varying opinions on what comprises a good fit. Personal preferences regarding fit are governed by current fashion trends, cultural influences, age, sex, figure type, and lifestyle. The intended end use of the garment also affects the desired fit. For example, a person needs more ease for active sportswear than for spectator sportswear like in a tracksuit.

The relation between the size charts and body dimensions is not constant because of the changes that occur in the human population. Recent body surveys in UK, US, China, Germany and other countries proved that a garment sizing system for a certain body type does not cover more than the 25 per cent of the population for which it is addressed. Correct sizing is a prerequisite to good fit and customer satisfaction. Fit is a function of sizing and it affects comfort, durability of a garment. Sizing is often over looked as an important issue

Elements of Fit: The evaluation of Fit is based on five classical elements:

Grain: For a good fit the garment should be cut on the right grain or in other words on grain. An on grain garment hangs evenly and appears symmetrical. If the garment is off-grain, it will not hang straight. The garment and seam lines may twist or hang crooked because the fabric on each half of the garment behaves differently. Deviation in the grain line is a result of wrong cutting or stitching or even due to a poor posture of the wearer or figure irregularities that may interfere with the grain of the garment as it hangs on the body.

Set: This refers to a smooth fit without any undesirable wrinkles. Wrinkles caused by poor set cannot be ironed out, but result from the way the garment fits the wearer. Set wrinkles usually occur because the garment is too large or too small for the wearer and the garment hangs or sags when worn.

Line: This refers to the alignment of the structural lines of the garment with the natural lines of the body. Side seams of the garment should hang like a plumb line down the centre of the side of the body. It should be perpendicular to the floor. Centre front and centre back likewise should fall centre of the front and back of the body and be perpendicular to the floor. Darts and seams such as shoulder seams should visually appear to be straight lines that follow the body part they are intended to fit. Other seam lines should be gradually curving lines like necklines, waistlines, hiplines and armholes. Poor design or construction can result in an out of line garment. Even figure irregularities can distort the lines of the garment.

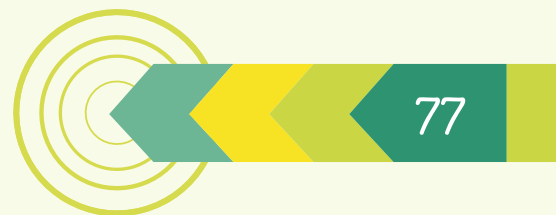



Balance: This occurs when the garment is in equilibrium. The right and left side of the garment appear evenly balanced or symmetrical, when viewed from front, back or side of the garment. A skirt is balanced if the legs of the wearer are in the centre and are not touching the front or back of the skirt. Balance relates to grain and line in the garment. A garment is out of balance when it is cut off grain, causing it to hang unevenly. Also if the line of the garment does not follow the line of the body, it will hang out of balance. Poor posture or lack of symmetry in the wearer's body is another likely cause of it.

Ease: This refers to the amount of roominess in a garment. Ease is the difference between the measurements of the body of the intended wearer and the measurements of the garment. There are two kinds of ease:

- + Fitting ease
- + Design ease

Fit ease is in direct contact with the body and is responsible for the comfort factor and design ease of the garment is for aesthetic appearance. A garment must contain adequate ease beyond the actual measurements of the wearer, to allow room for ordinary movements like walking, sitting, reaching out and even breathing. Ease in this context is called Fitting ease. Design ease is the extra style fullness added to the fitting ease. All the garments have fitting ease but design ease is optional as it is added purely for the sake of appearance and giving the garment its style.

2.4.2 Evaluating fit

In evaluating the fit of the garment, all the sides of the garment must be examined. The fitting should start from the top and move downwards. The analysis of fit is a complex process and remains a challenge, for both industry and customers. Apparel fit is a complex issue but of great importance for judging perfect clothing appearance, and the various technologies used, such as a 3D simulated form, may lead to more efficient decision making in the process of product development and quality control.

The following body parts should appear as:

Shoulders: The shoulders should appear smooth and feel comfortable. Seam should lie on top of the shoulder. In regular styles the arm-scye seam should fall on edge of the wearers shoulder. The shoulders of the garment should be wide enough so that the sleeves hang smoothly. If the shoulders are too narrow, the sleeves will pull across the upper arm and cause wrinkles. If fashion trends require the shoulders to be narrow or wider the pattern still should allow sufficient movement. The shoulder slope of the garment should match the shoulder slope of the wearer.

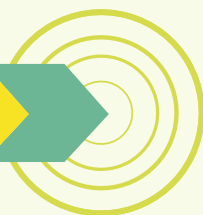



Bust/Chest: If the garment is too small, the seams or closures that are at the centre front or back are going to pull and gape open. A larger bust or highly developed chest often causes the button closure to gape open at centre front or back, also the garment may ride up because the larger bust curves takes up more length. A well-fitted dart always points towards the fullest part of the of the body curve it is intended to fit. The tip of the dart should end about an inch before the fullest part of the curve. Darts that are too short or darts that extend beyond the fullest part of the curve result in a bubble at the dart tip. Darts occurring anywhere in the garment follow the same principle. The practice of eliminating darts to speed construction creates diagonal wrinkles on the bodice front.

Neckline: Necklines should be large enough to fit without pulling or chafing but not so large that it doesn't lie flat against the body in front and back. The front of the basic neckline should always be lower than that of the back.

Collar: The most important factor in the fit of the collar is the neck circumference. The circumference of the collar should be at least 1/4th of an inch bigger than that of the neckline or just large enough for one to insert two fingers between the neck and collar. A properly fitted collar should be smooth and stays in place when the wearer moves. It should not be so tight that it pulls. A tight collar is uncomfortable and makes the neck look large. But neither should it be so loose that it gapes.

Armseye: The arm-scye must fit well for the garment to be comfortable and attractive. The circumference of the (arm-scye) should be large enough so they do not pull at the front and back of the garment, but not so large that it gapes. In a well-fitted arm-scye, the base of the (arm-scye) is cut close to the armpit, but not so close that it bites into the armpit. It should be cut about an inch below the armpit. This provides adequate comfort, room for movement, and close fit without wrinkles in the - area. If the arm-scyears too tight they are usually denote comfort and uncomfortable. Arm-scye in the front should be more deeply cut than at the back as most of the movements are in the front.

Sleeves: Well-fitting sleeves are attractive and comfortable. The circumference of the basic sleeve should be loose enough so that it does not bind nor has wrinkles horizontally around the arm. A tight sleeve apart from being uncomfortable makes normal arm movements impossible. Sleeves can be as loose as one wants but the only problem would be to wear the garment under a fitted jacket. A well-set jacket sleeve hangs with a slight angle towards the front. The crosswise grain at the bicep should lie parallel to the floor.

Waistline: Fit is essential for comfort. The waistline of the garment should not be so tight that it binds and rolls. It should have plenty of room for breathing and eating and it should return to its position after the arms are raised or lowered. It should not be so loose



that it stands away from the body, droops, or adds bulk when a top or shirt is tucked in or worn under another garment. The narrowest part of the garment should fall at the wearer's waist. If there are buttons at the waist the garment should not pull or strain at the closure. A jacket should be big enough at the waist so that a person can sit even when it is buttoned.

Hips: The fit of the hip area is critical when fitting skirts or trousers. If there is adequate room in the hip area other parts of the garment can easily be altered to fit. Garments with enough room in the hip, thigh and abdomen area fit smoothly without pulling, wrinkling or riding up. Pocket, pleats or vents that open up indicate that garment is tight in the hip or abdomen area. If the garment has excess ease in hip or thigh area it will result in vertical folds.

Crotch/seat: Trousers and other bifurcated garments require a well-fitted crotch for comfort or durability. A properly fitted crotch does not cut or bind the wearer between the legs and conforms to the shape of the buttocks. There should be slight but not excessive ease in the crotch area. Crotch length generally has one inch of ease in the crotch area. The back of the crotch seam should be longer and more deeply curved than the front as the backside of the buttocks are more curved than the front. Bigger sizes require longer and deeper curved crotch lengths at the back. Diagonal wrinkles radiating from the crotch area are the result of, crotch curve not long enough to accommodate the size of the buttocks. Diagonal wrinkles in the front may also be due to the wearer's big abdomen. Wrinkles emanating upward from the crotch area indicate a too tight and high crotch, resulting in chafing and discomfort. Wrinkles emanating downwards from the crotch area indicate a low and loose crotch; it bags and sags, restricts walking and has increased probability of ripping from strain of movement. If the rise needs to be lengthened or shortened, the waistband should also be raised or lowered. Rise should not be lengthened or shortened in the crotch length as the same may lead to problems where none existed.

Another important **rule** of the fitting apart from knowing how to fit, is when not to fit. Clothes must not only fit but need to flatter as well. There is absolutely no need to fit a garment so close to the body that it looks too tight. The real expertise lies in the fact that one is able to strike a balance between the lines of the design and the lines of the figure. The ability to do this is a skill that one learns by training the eye to see and judge as to what flatters the body.

Fitting is like sculpturing it creates a three dimension form. Another question that is frequently asked is how many times one should fit. The answer to this is as many times as it takes to fit well.

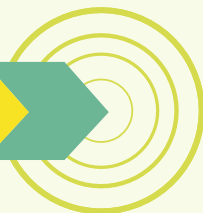



2.4.3 Need to fit

Mathematical calculations and pattern corrections alone cannot guarantee the fine fit of the garment. They can only provide an approximation of the needs of the figure. The other points to be considered are:

- + The style of the garment whether it suits oneself or not.
- + The necessary and sufficient ease in the garment.
- + The posture and the individual shape of the wearer.

These can truly be evaluated only on a fabric test fit, since only minor changes can be made once the garment has been cut on the fabric. Hence a test fit can save lot of wastage. There are times when test fit is not necessary, those are when one is sure of the style, knows from experience how to adjust the pattern, has sufficient material to re-cut if necessary and has sufficient seam allowances to borrow in emergencies. But if one has any doubts whatsoever, then test fitting is a must.

Commonly used test material is muslin, bleached or unbleached should be used in a similar weight to that of the final fabric. Any other solid coloured, plain weave fabric like poplin in a similar weight to final fabric would do. A plain surface is recommended as this clearly shows all seams, darts and other style details. Layout the pattern cut and mark your test fit fabric with equal amount of care as you would your final garment fabric.

Put the trial muslin together. The quickest way to get the effect of the finished garment without actual stitching is to overlap and pin all the seams lines. Pinning gives the same result and information, that one wants without going to the machine. It is so much faster and easier to unpin and then re-pin than to rip stitching and re-stitching.

Pins should be placed at right angle to the seam line, as in this method there is least amount of strain or pull on the seam, and it does not gape. While test-fitting trousers remember to baste stitch the crotch seam instead of pinning.

Check the test fit muslin and make corrections till completely satisfied. Mark all the corrections and the same should be transferred on the pattern for it is the paper pattern that one should use to cut the final fabric and not the test fit muslin. Mark new notches as the old ones may not hold good after the alterations. Check the lengths of two matching seams to ensure that the alterations have not created more problems, e.g. if you have corrected the dart intake of side seam dart in the front, check to ensure that both the side seams are still equal and if required make the necessary changes.



2.4.4 Methods of fit

There are two kinds of fitting:

One is the first **test fit** that is done on muslin at the time when the pattern is made. A basic test fit is done to check the pattern fitting; the pattern is cut with relevant seam allowances and pinned in place for test fitting. Make sure that seams and darts are in place. This fitting is always done from the right side of the garment, as it is easier to make changes and corrections. These corrections become the new seam lines for the garment. Check the garment for ease and fullness. It is important to mark buttons and buttonholes at right places in this fit.

The second is after the garment has been stitched **before final finishing**. Stitch the garment with relevant interfacing/ or underlining in place. Press it well and test fit to check the position of darts, seams, puckers if any and locate the position of outer seams. This type of fitting refines and perfects the fit of the garment.

Other times when **refitting** becomes necessary are if the garment has been purchased readymade from the market. Some alterations may be required for it to be fitted to an individual's size. If there are changes in the body size, for instance if some one has grown thin or has put on weight or if a child has gained height, refitting may become necessary. The methods by which each pattern seam or area is to be corrected and altered depends on the type of problems and nature of the fitting defect.

Activity - 1

Check your own wardrobe. What are the various fit issues you can identify? Try out garments and see if you can identify methods of correcting fit.

Activity - 2

Fill in the blanks

- Fitting is like _____ it creates a _____ form.
- Five elements of fit are _____, _____, _____, _____ & _____.
- Ease is of _____ kinds, i.e. _____ & _____ ease.
- _____ occurs when _____ is in equilibrium.
- The garment is called _____ grain if it is not cut on the _____ grain of the fabric and it would not _____ well.
- The side seam of the garment should _____ straight on the _____ of the _____.

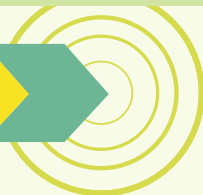



- g. There are _____ methods of evaluating the ____ of the garment.
- h. Pins should be placed _____ to the ____ line, as there is _____ of strain or pull on the _____.
- I. Check the _____ muslin and make corrections till _____ satisfied, _____ all the _____ corrections and _____ on the pattern.
- j. _____ pulls in a garment indicate that the garment is _____ and _____ folds indicate that it is _____.

Review Questions

1. Define Fit and identify elements of Fit
2. Differentiate between Test Fit and Garment Fit.

2.5 Pattern Development

2.5.1 Basic Bodice

To develop pattern for basic Bodice for women wear use measurements from the given chart or measure a dress form or a body. Take a paper, whose length is centre front length plus 3" and width is half of the bust width plus 4". Fold the paper lengthwise and with fold on the left hand side (away from you) mark a guideline 1" down from the top edge, mark A as illustrated.

A to B = front length

A to C = B to D = front width (+1/2" ease to be added if measured on dress form/body)

Join C to D

Mark D to E = centre front length

CE is front neck depth.

For neck width mark

CF = CE-1/8"

Square out lines from E & F.

Draw the neckline curves illustrated, using a French curve.

G = mid point of DE

GH = apex measurement



FASHION STUDIES



Square a line from H to I

- Mark DJ = Centre front to princess line measurement
- I K = I J, Join J and K to H
- KL = Front waist line measurement minus DJ
(+1/8"ease to be added if measured on dress form/body)
- LM = under arm seam length where M is on the fold line. Join as illustrated
- M to M1 = M1 to M2 = 2 1/2" square out for guideline, as illustrated
- B to N = Shoulder to waistline measurement
(+3/4"ease to be added if measured on dress form/body) where N is on the fold line.
- N to N1 = 1/2"

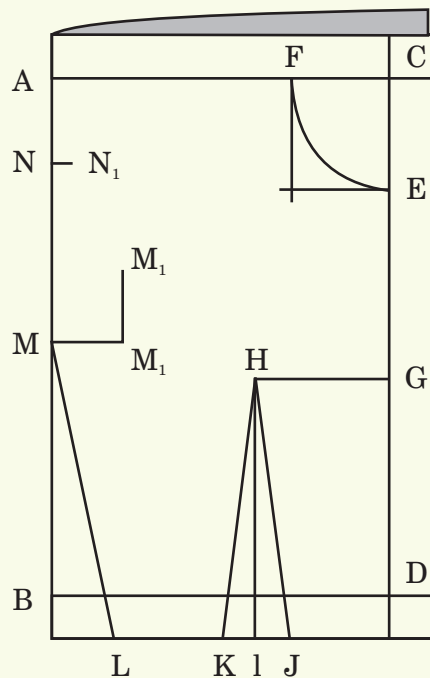

Draw the front armhole curve as illustrated

Join F to N1

Mark F to F1 and N1 to O = 1/2 shoulder measurement



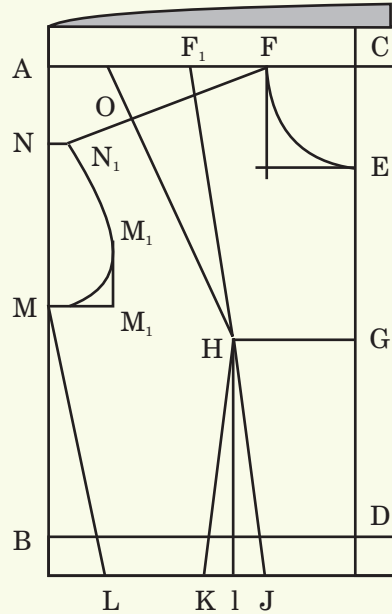

Join F₁ to H and O to H.

Trace BD line, L M line and M M₁ line on the other half of the paper.

Extend M M₁ line on the second half of the paper.

Mark B to Z = Back width (+1/2"ease to be added if measured on dress form/body)

Z to Y = Centre Back Length

Y to X = C F

X to W = 7/8", draw the back neck line curve as illustrated.

Measures Z to L₁ and from this measurement subtract back waistline measurement (+1/8"ease to be added if measured on dress form/body).The difference is dart intake at U.

Z to U = Centre back to princess line measurement.

Mark U to V = Dart intake, T is mid point of U and V

Square out from T to S, Join S to U and V.

Mark Y R = 1/4 Centre back length

R Q = Back shoulder blade measurement.

QQ₁ = Draw 1" guideline, as illustrated.

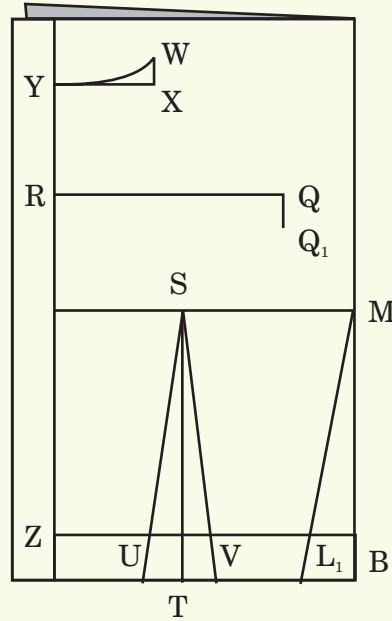

Join W to N1 in front

W to P = $\frac{1}{2}$ shoulder + $\frac{1}{8}$ "

P to P1 = $\frac{3}{4}$ "

P1 to P2 = W to P ($\frac{1}{2}$ shoulder + $\frac{1}{8}$ ")

Joint P to S.

Join P1 to P3 such that P3 is 1" above the shoulder blade line (RQ).

Draw the armhole as illustrated.

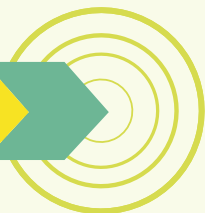
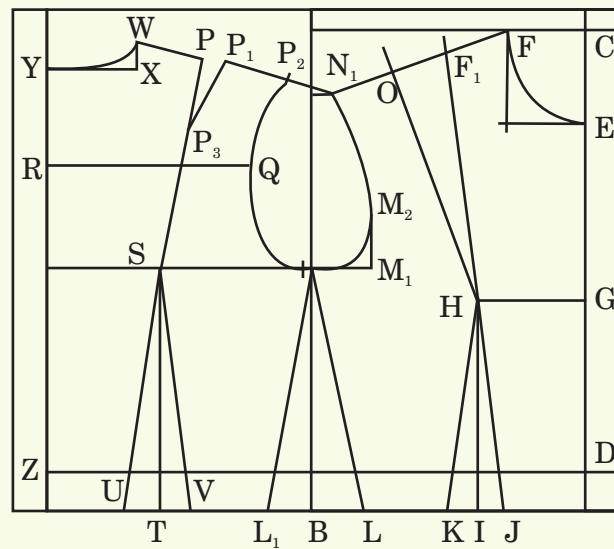



Truing or correcting the lines or darts to conform to body shape or aligning the dart legs and seams.

Front shoulder

Fold the shoulder dart at the apex, matching the two dart legs keeping the folded edge towards the neckline. Join the neck edge with the armhole edge with the straight line at the dart ends. Use a tracing wheel to trace out the folded edge.

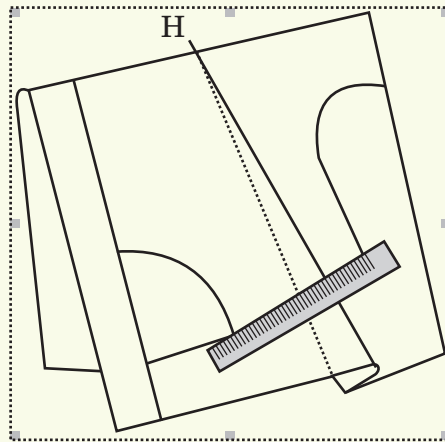

Back shoulder

Fold the shoulder dart matching the two dart legs keeping the folded edge towards the neckline. Draw the shoulder line with the help of the French curve as illustrated, dropping 1/8" on the armhole edge.

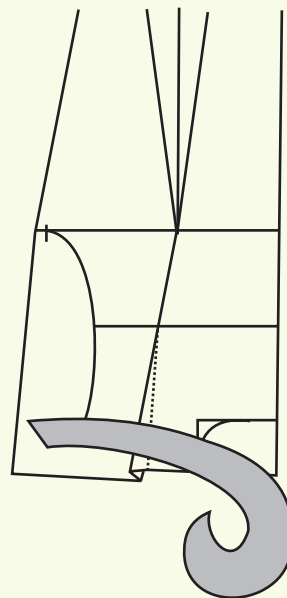



Waist line

Fold both the waist line darts (by matching the dart legs) and also close the side seam, keeping the pattern folded at the apex line. True the waist with help of a french curve, blending the waist line darts and side seam. The side seam should be dropped $\frac{1}{4}$ " at the side seam, as illustrated.

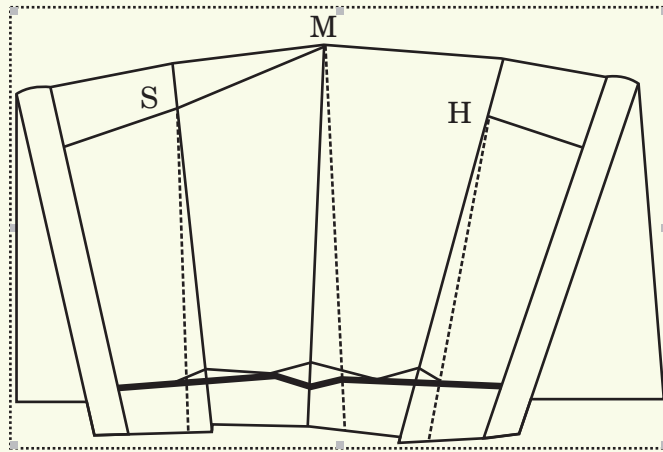

2.5.2 Sleeveless bodice

For a sleeveless bodice trace the basic bodice block is used. Change the armhole as follows:

Go up $\frac{1}{2}$ " on the armhole level i.e. E and F and redraw the curves, as illustrated.

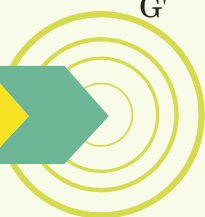
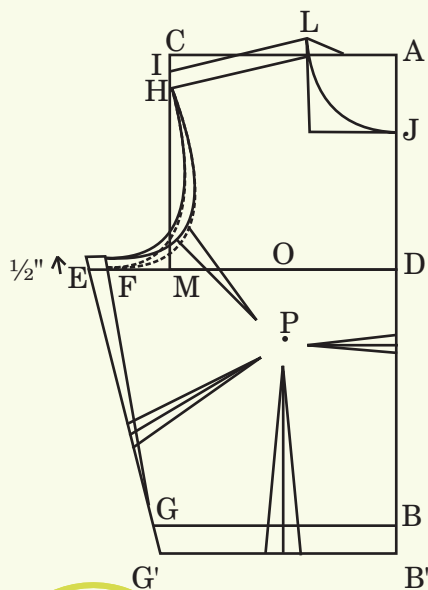



Activity

Collect pictures of garments which have been made using a basic bodice block. How many have two darts and how many are without any dart? Maintain this information in your scrap book.

Fill in the blanks

- The waist of the bodice is _____ by closing _____ darts and then a _____ is drawn using a French curve.
- The back shoulder line is drawn with help of _____ _____ by dropping _____ on the _____ line.
- The apex is marked at _____ of _____.
- Waist dart at the back is calculated by _____ the _____ measurement from _____.
- Front waist dart is obtained by _____ out a line from _____ to _____ and the distance between this point and center front to _____ is half of the dart.
- For sleeveless garment go $\frac{1}{2}$ " _____ on the _____ level.

2.6 Neckline

2.6.1 Neckline & its variations

There are number of variation in necklines that are possible to make once the basic block has been drafted.

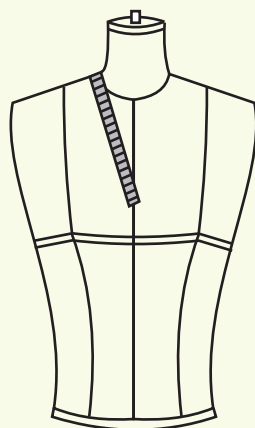

Neckline measurement A

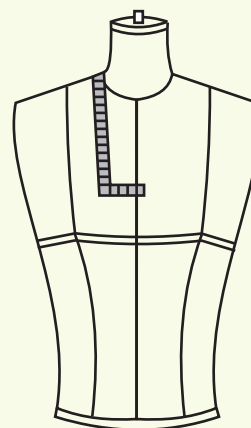

Neckline measurement B

The **measurement** required for any neckline is the depth of the neck measured from the nape of the neck point to the center front diagonally. (Neckline measurement A)



In case of necklines like square, glass neck, sweet heart measure in a straight line on the body for the length and for the width of the neckline at that point to the center front is also measured. (Neckline measurement B)

Points to be kept in mind for Necklines

1. If a neckline is made wider in the front, the same needs to be done for the back.
2. Try avoiding deeper neckline for both front and back at the same time. In case one decides to keep the neckline deeper in both front and back then an ease of about $\frac{1}{2}$ " needs to be taken out on the centre front neck.
3. The measurement which is taken diagonally should be marked diagonally on the pattern and a measurement taken straight should be marked straight.
4. For curved neckline, always square out $\frac{1}{4}$ " either side at center back and center front and on shoulder level.



V-Neck



Broad V



Round



U



Square



Glass



Sweet Heart



Sweet Heart Variation

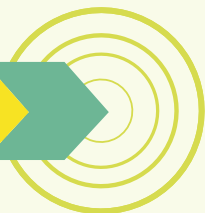



V-Neckline

Trace the neckline of bodice block with dotted line as illustrated.

Extend the centre front line up to A.

From point A square out lines so that they touch the shoulder and neckline intersection at B.

From B, mark BC = 7" down or as required diagonally.

BC is the new V neckline join with a slight curve.

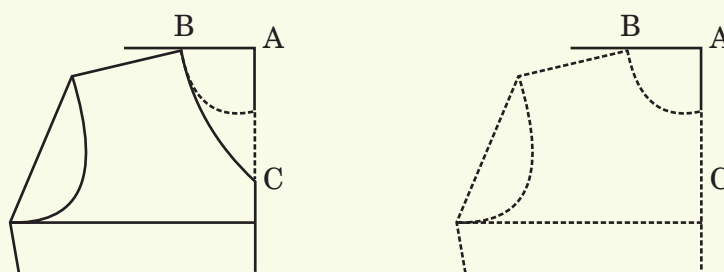

Broad V-Neckline

In case, one needs a wider neckline mark $BB' = 1"$ or as desired and join B'C for front neck with a slight curve.

If you want a deeper neck at the back mark $BB' = 1$ or as desired and draw B'C' as the new back neck.

The neckline can be finished with either piping or facing.

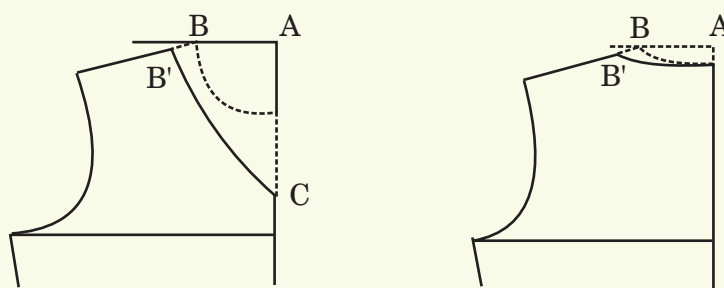

U-Neckline

Trace the neckline of bodice block with dotted line as illustrated.

Mark the points AB as for V neckline.

From B measure diagonally down for the neck depth at centre front as required and mark it as C.

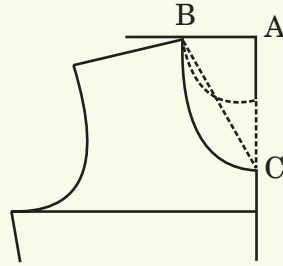

From point C square out $\frac{1}{4}$ ".

From point B square down $\frac{1}{4}$ ". Join BC for a U neck as illustrated.

Finish the neckline as desired.

Round Neckline

Round neck is a variation of U neck. It is cut wider at the shoulder and deeper at the back.

Trace the front or back neck of the bodice as illustrated.

Mark the points AB as for V neckline.

For the front neckline, from B measure the neck depth as required and mark it as C.

From point B go out 2" or as desired to B'.

For the back neckline, from A mark C as desired for the neck depth. B B' is same as front.

Square $\frac{1}{4}$ " down from B' and square $\frac{1}{4}$ " in from C.

Join B'C for the round back and front neckline as illustrated. Finish the neckline as desired.

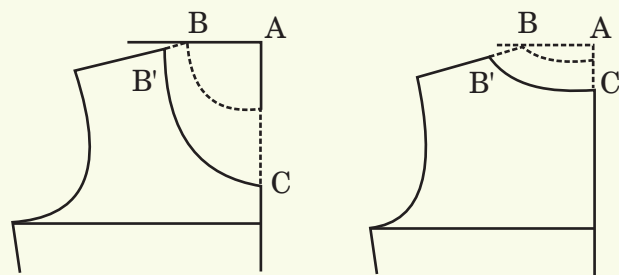

Square Neckline

Trace the neckline of bodice block with dotted line as illustrated.

Mark the points AB as for V neckline.

Square down from B to D as the side depth of the neck required or $5\frac{1}{2}$ ". Square out from D to C on the center front.

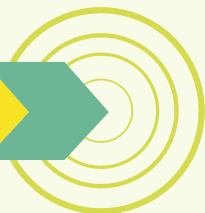



This is a basic square neck.

Finish the neckline as desired.

The neck can be widened as in the round neck.

If one feels that neckline is too wide, reduce CD as shown.

CD should be taken as $\frac{1}{2}$ of the neckline width desired.

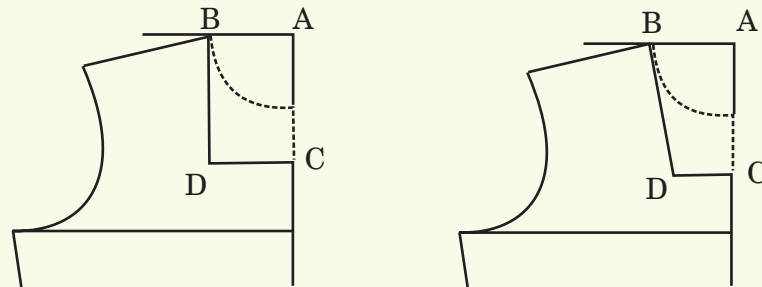

Glass Neckline

Trace the neckline of bodice block with dotted line as illustrated.

Mark the points AB as for V neckline.

Square out 1" or as desired from C to D.

Join BD and DC with a straight line for the Glass neckline.

Finish the neckline as desired.

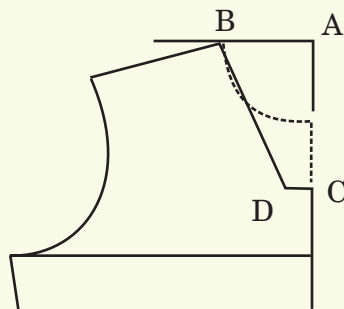

Sweet Heart Neckline

Trace the neckline of bodice block with dotted line as illustrated.

Mark the points AB as for V neckline.

From point B square down to D for the side depth of the neck required or 5".

Mark E on centre front, where CE = $3\frac{1}{2}$ " or as desired.

Join BD and DE with straight lines, for basic sweet heart neck.



Variation of Sweet Heart Neckline

Square a line at D about 1" on either side as shown.

Join BD' and D'E with curved lines for a curved variation.

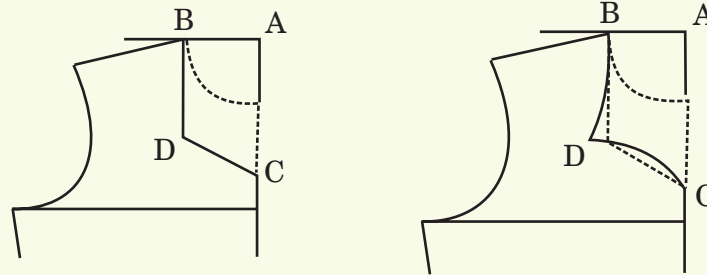

2.6.2 Finishing of neckline

Piping is a bias strip of fabric $1\frac{1}{4}$ " wide and is attached to the neckline on the seam line after stretching. The piping is finished either by hemming or machine stitch. It is finished to about $\frac{1}{8}$ " - $\frac{1}{4}$ " wide ready on the right side of the garment. It is a popular finish for blouses and other Indian garments.

Facings are of two kinds - bias facing and shaped facing.

Bias facing is a similar strip of fabric like piping but is attached to the neckline without stretching. The same is finished completely on the wrong side.

Shaped facing - A shaped facing is cut following the shape of the neckline and is attached on the right side and then is completely turned in. The width of this facing varies for each design but is generally $1\frac{1}{2}$ " wide.

Activity

Collect pictures of various necklines and maintain this information in your scrap book. Try making patterns of these necklines.

Activity

Draft a Sweetheart Neckline

Fill in the blanks

- To ensure that the neckline doesn't end in a point go out _____ on _____ of the bodice.
- While making a neckline deep in front it is _____ not to make the neckline _____ and _____ at back.

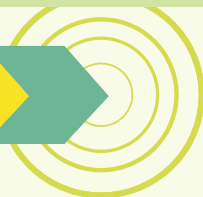



- c. A _____ neckline is drawn using a French curve.
- d. The _____ facing is cut keeping the pattern of the _____ of the desired piece.
- e. The measurement required for any neckline is the depth of the neck measured from the _____ of the _____ point to the center front of the _____.

Review Questions

- 1. What are the measurements required to draft a neckline?
- 2. What are the different necklines that can be finished with Bias Facing?

2.7 Dart Manipulation

2.7.1 Introduction

Dart manipulation is a useful and interesting tool for pattern maker for creating interesting, innovative dart placements and style lines. The change in the position of the darts creates interest in the garments in different dart positions. The same can be magnified by using similar technology on striped fabric where a dart gives a new dimension to the striped pattern. The darts can be stitched as new darts, as style lines, can be converted into tucks, pleats, gathers, yokes, etc. The basic fit of the garment is not altered by these manipulations.

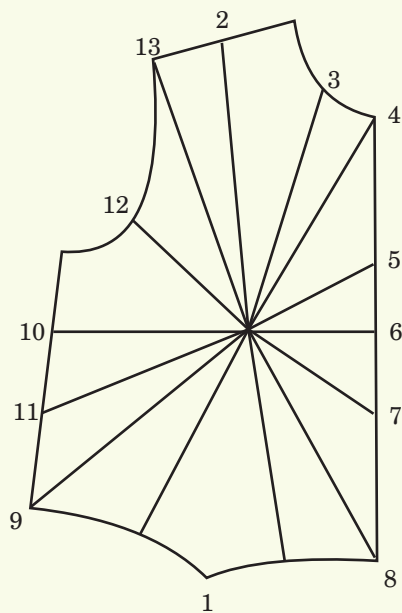

- 1. Waistline Dart
- 2. Shoulder Dart
- 3. Neck Dart
- 4. Neckline and C.F. Intersection C
- 5. C.F. Dart
- 6. C.F. Dart
- 7. C.F. Dart
- 8. C.F. Waistline intersection Dart
- 9. French Dart
- 10. Side Seam Dart
- 11. Side Seam Dart
- 12. Armhole Dart
- 13. Flange



There are two methods of dart manipulation

1. Pivot Method
2. Slash and spread method

Pivot Method

In the pivot method, the dart is pivoted on apex and dart is closed and pattern/sloper opens on new desired line, the pattern itself spreads on the new position, to create the new design.

2.7.2 Slash and Spread Method

In the slash and spread method, as the name implies the pattern/sloper is slashed or cut on the desired line and as the old dart or excess is closed, the pattern itself spreads on the new position, to create the new design. Some of the new dart positions are illustrated here.

Shoulder dart to waist

Take two dart basic block, slash the new dart position i.e. the waist dart. Fold and close the shoulder dart. Trace the new pattern on separate sheet.

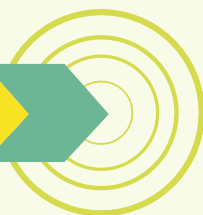
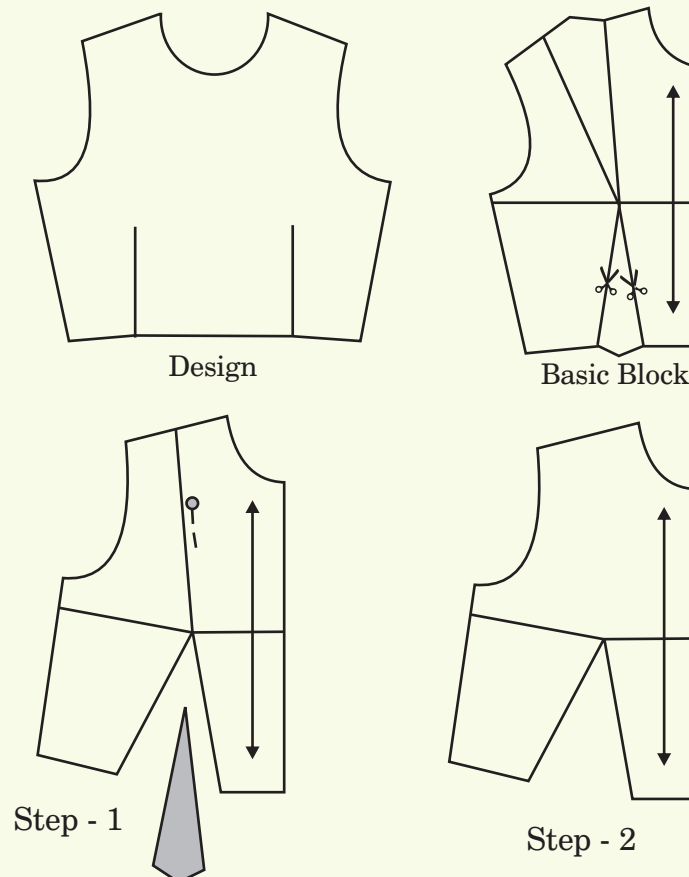



Waist dart to centre front

Take one dart bodice block. Slash the new dart position, close the old dart. Trace the pattern on separate sheet.

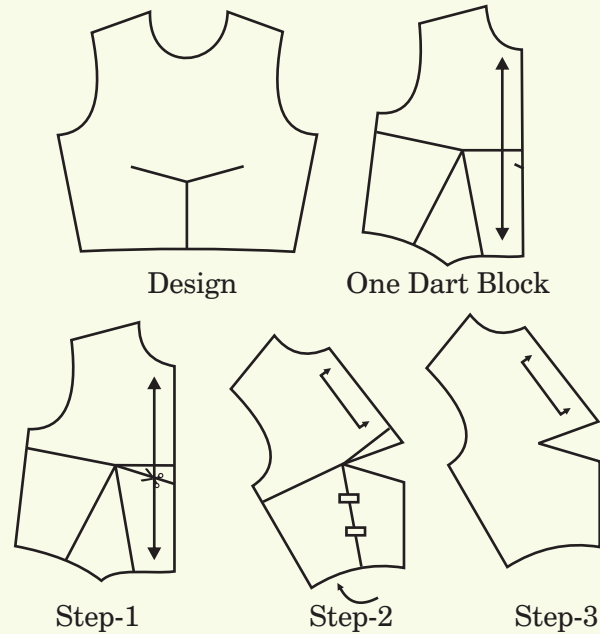

Shoulder dart to armhole side seam intersection

Take two darted basic bodice block. Slash the new dart position, close the old dart.

Trace the pattern on separate sheet. Shoulder dart to armhole side seam intersection?

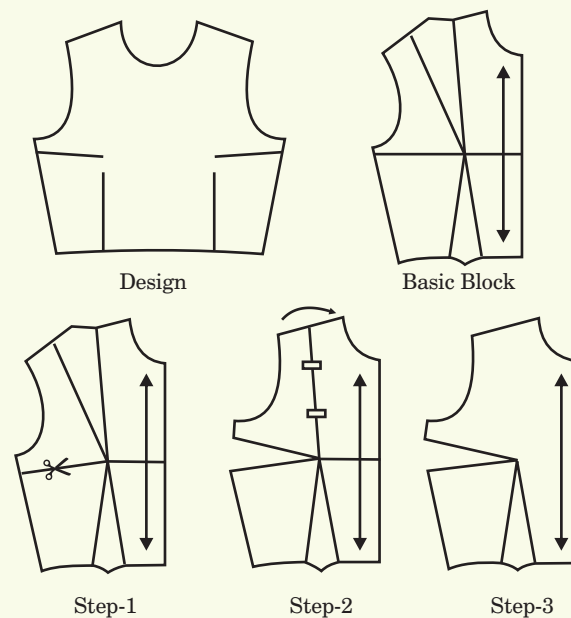



Darts into a Princess line

Take a one dart sloper. Shift the dart away from the princess line desired. Draw the princess line as required. Mark the notches and grainline on both the pieces as illustrated. Slash on the princess line and close the dart. Trace the patterns on another sheet of paper. Ensure that the notches are transferred on the final pattern.

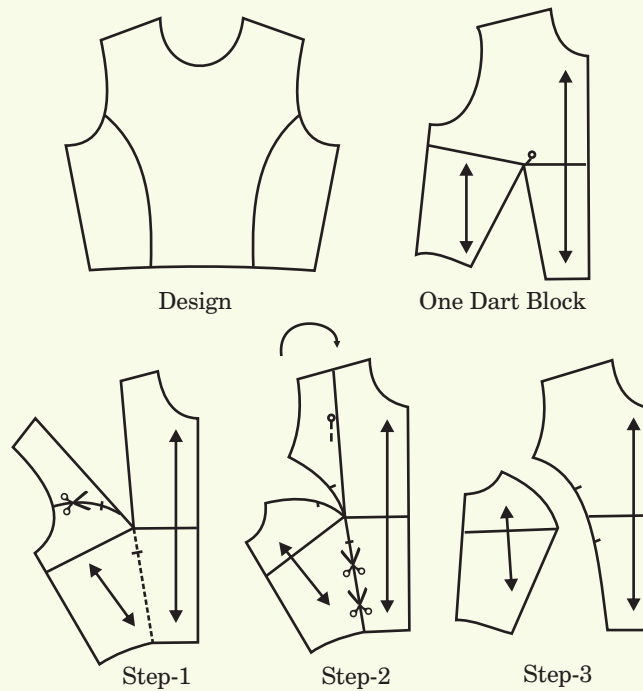

Activity

Fill in the blanks

- Dart manipulation is _____ for pattern maker to create _____ and _____ designs for _____.
- A Dart is named after the _____ it _____.
- A waist dart is a dart that starts from _____.
- Two methods of dart manipulation are _____ & _____.
- In this method the old dart is _____ and its suppression folded and the new dart position is _____ and opened.

Review Questions

- What is Dart Manipulation? Why is it important?
- What are the different methods of Dart Manipulation?

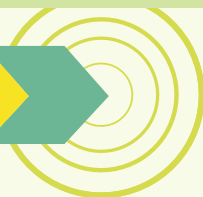



2.8 Skirt

2.8.1 Basic Skirt

To develop patterns for the basic skirt for women wear, use measurements from the given chart or measure a dress form or a body. Take a paper, whose length is the desired length of the skirt plus 3" and width is half of the hip plus 4".

Make a block A B C D E F, where

A to B = back hip (+1/4"ease to be added if measured on dress form/body)

B to C = front hip (+1/4"ease to be added if measured on dress form/body)

A to D and C to F = Desired length, e.g. 21".

A to G = C to H = 7", hip level

Joint G to H. Mark I at side seam

B to B1 and B to B2 = $\frac{3}{4}$ "

Mark I1, 2" above I.

Passing through B2 and B1, join I1 J and I1 K extending it $\frac{3}{8}$ " above the waistline, as illustrated using hip curve.

A to A1 = $\frac{1}{4}$ "

Join J to C, K to A1 as illustrated, using the hip curve ruler.

Measure J to C, K to A1 and note the measurement on paper, from this measurement subtract the front and back waistline measurement respectively. The difference is the dart intake for both front and back.

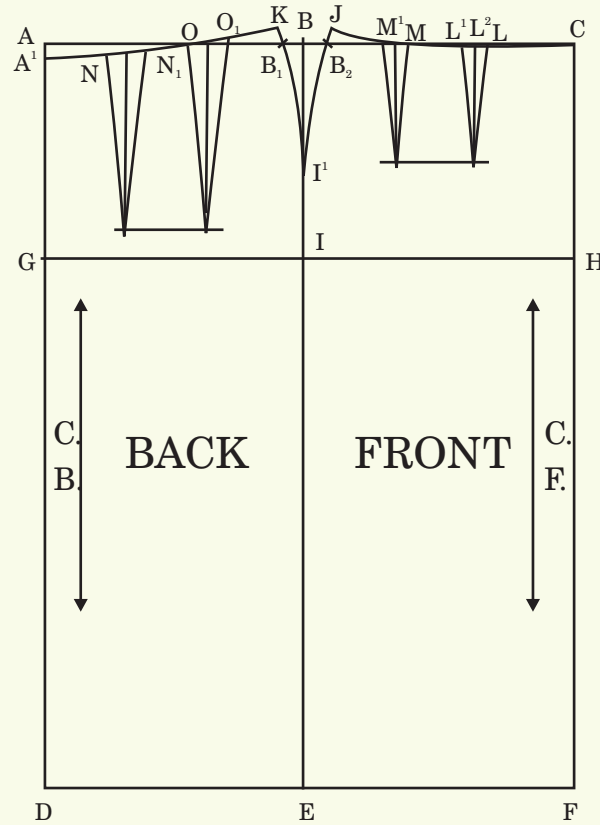

Divide this excess into two darts for both front and back.

Draw a guide line parallel to the waist line at a distance of $3\frac{1}{2}$ " for front and $5\frac{1}{2}$ " for the back,

Mark C to L = Centre front to princessline measurement

L to L1 = 1st dart ($\frac{1}{2}$ of the total dart intake for front)

L2 is midpoint of L, L1.

L1 to M = $1\frac{1}{2}$ "

MM1, = 2nd dart ($\frac{1}{2}$ of the total dart intake)

Mark A1 N = Centre back to princessline measurement

N to N1 = 1st dart ($\frac{1}{2}$ of the total dart intake for the back)

N1 O = $1\frac{1}{2}$ "

O to O1 = 2nd dart ($\frac{1}{2}$ of the total dart intake)

)Find the midpoint of all the darts and draw a perpendicular line till the guideline. Join these points to the dart point to form the dart legs.

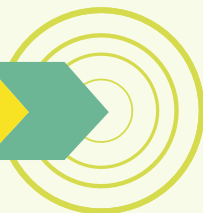



Trueing

Fold the dart at vanishing point and true the waistline as illustrated raising the waistline by $\frac{1}{4}$ " - $\frac{1}{2}$ " (when you true the waistline with the help of French curve it automatically goes up) at the side seams. Drop back waist line by $\frac{1}{8}$ " at centre back.

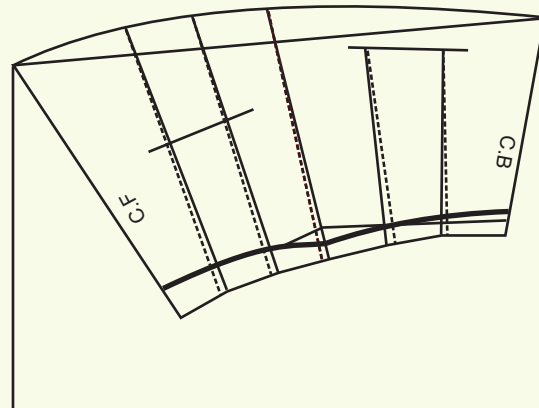

2.8.2 One dart basic skirt

Use a basic skirt sloper that has two darts. Measure the dart towards the side seam and add the measurement to the 1st dart i.e. towards the centre front or back and eliminate the 2nd dart. Note that the length of new waistline dart in the front is $5\frac{1}{2}$ " same as the back dart length. Find the mid point of the new dart and mark the centre and true the waistline. This method is called measurement method and can only be used in skirts/trousers, as there is no apex in lower half of the body.

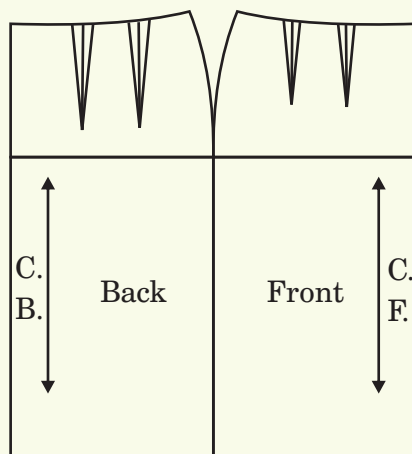

Fig.1

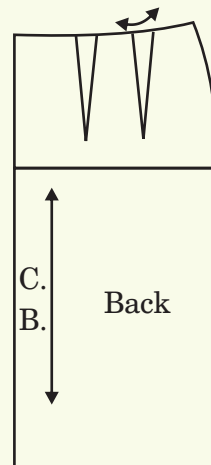

Fig.2 (a)

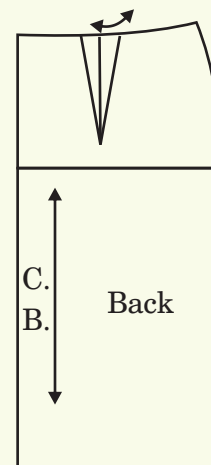

Fig.3 (a)

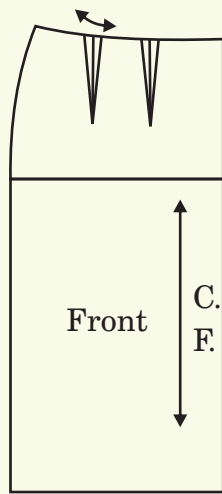

Fig. 2(b)

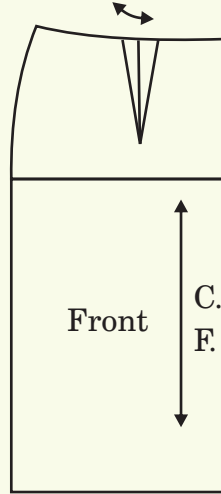

Fig. 3(b)

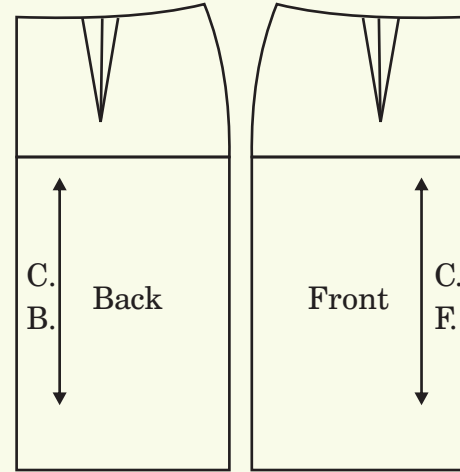

Fig. 4

One Dart Basic Skirt

2.8.3 A-Line skirt

Take a one dart skirt sloper, draw a slash line as illustrated (fig.2). Slash the line and close a part of the waist dart, so that the ease is shifted to the hem. Add 1" - 1 1/2" on the side seam at hem line for A-line shape in the skirt as illustrated. Blend till the hip level for both front and back and also blend the hem line.

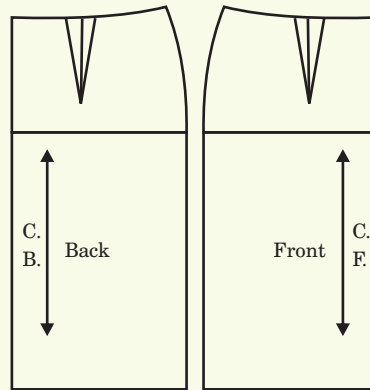

Fig. 1

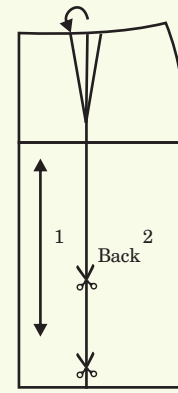

Fig. 2

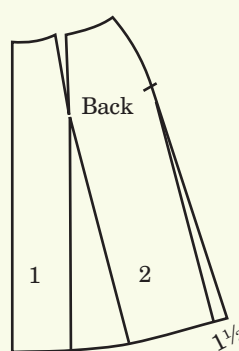

Fig. 3

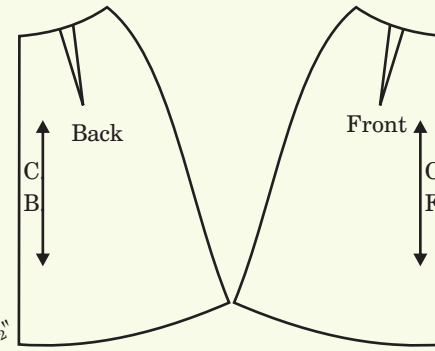
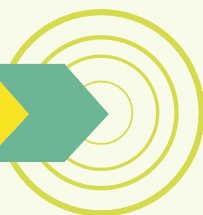

Fig. 4

A-Line Skirt





2.8.4 Flared skirt

Take a two dart basic skirt sloper, draw the slash lines as illustrated (fig. 2). Slash on the line and close the darts. Add 1½" -2" on the side seam blending the same at the hip level (fig. 3)

Balancing the hem

As the lengths and width of the front and back dart are different, the hem of the front and back skirt after closing the darts would also be different. Measure the difference between the two at the hem. Subtract half of the difference from the larger side and add half of the difference to the smaller side to match the hemlines, as an unbalanced hemline would make the skirt swing forward or backwards, towards the side that is smaller. This method is necessary for a professional pattern.

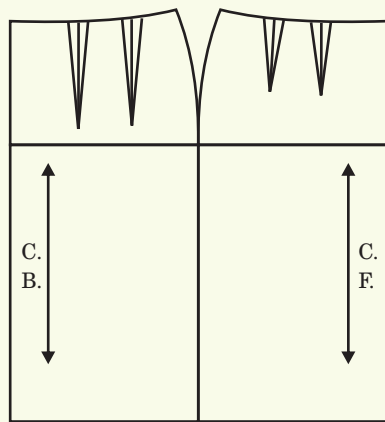

Fig. 1

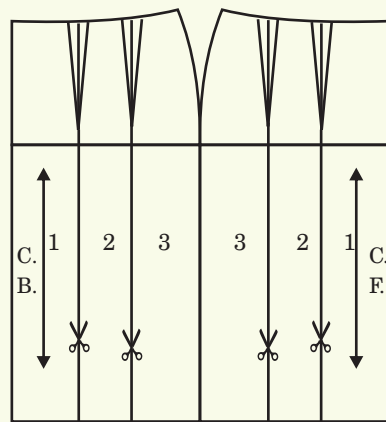

Fig. 2

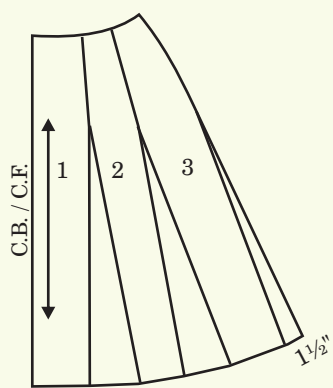

Fig. 3

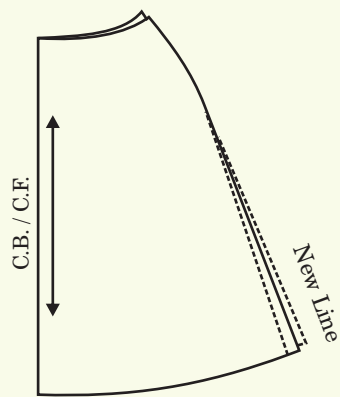

Fig. 4

Flared Skirt



Activity

Collect pictures of skirts with different hemlines and maintain this information in your scrap book.

Fill in the blanks

- Balancing the hem of a flared skirt is required due to _____ and _____ in the pattern.
- A-line skirt has _____ fullness added to the _____ of the skirt.
- A single dart skirt is made by combining the _____ of the _____ dart skirt.
- The length of the dart in the front in a single dart skirt pattern _____ is in a two dart skirt pattern is _____
- The difference in _____ of dart in a single and two dart skirts is because if a dart is _____ and bigger it will result in a _____ at the dart point.

Review Questions

- What is Balancing?
- How do you balance a skirt hemline?

2.9 Sleeve

2.9.1 Sleeve Block

To develop a pattern for a basic sleeve for women wear, use measurements from the given chart. Take a paper, whose length is the desired length of the sleeve plus 3" and width is half of the bicep plus 2" Fold it lengthwise and place there paper with its fold towards you.

Mark a guide line 1" away from the edge and label A.

A to B	=	Cap height
A to C	=	Full length
B to D	=	$\frac{1}{2}$ bicep circumference
B to E	=	$\frac{1}{2}$ BC - 1 $\frac{1}{2}$ "
E to F	=	$\frac{1}{2}$ elbow circumference (that includes ease of $\frac{1}{2}$ " minimum)

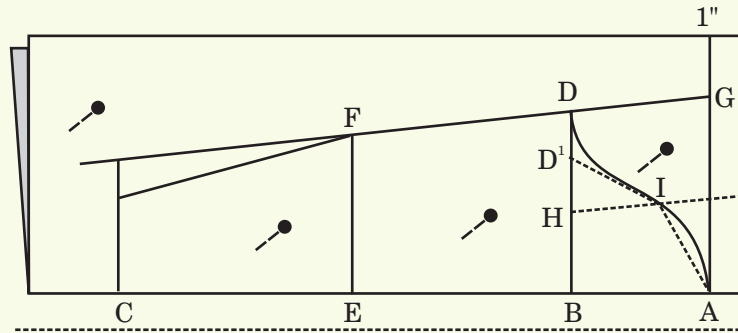

Join D to F extending to a line squared from C.

Extend D to G

Find mid point of B D line and A G by folding the paper lengthwise.

On this line mark H to I = $\frac{1}{2}$ cap height + $\frac{3}{4}$ "

Mark A to A₁ = $\frac{1}{4}$ " and D to D₁ = 1"

Join A₁ to I and I to D₁ with dotted lines.

Draw the armhole curve with the help of French curve keeping the guide line in perspective as illustrated in the diagram.

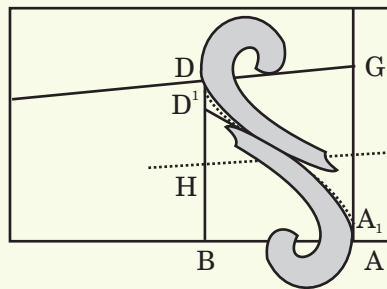

Trace all the lines for front sleeves on the other side of paper. Open the paper.

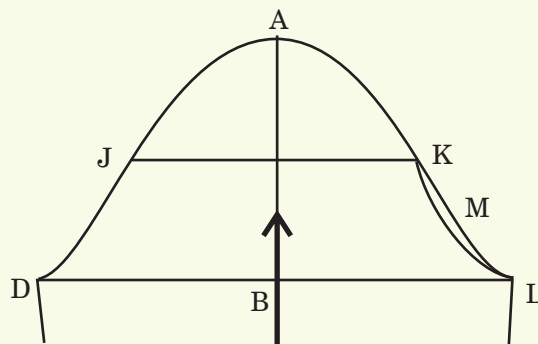



Find the mid point of A to B by folding the paper and draw the line JK.

Find the mid point M of KL line and on M go in $\frac{1}{4}$ ". Redraw the front curve as illustrated.

Mark the notches

For front mark one notch = $\frac{1}{2}$ " below point K.

For back mark two notches, one at $\frac{1}{2}$ " below J and next $\frac{1}{2}$ " away from the first notch.

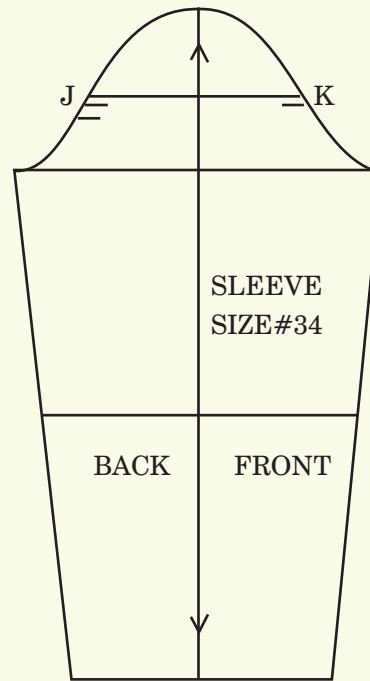

FINISHED PATTERN

Activity

Exercise

1. Collect pictures of sleeves and its variations and maintain this information in your scrap book. Try naming these sleeves.

2.10 Collar

2.10.1 Principles of Collar Development

The Collar is an added feature onto the neckline and it frames the face. It is one of the most important details of the garment as it draws maximum attention. There are three kinds of collars

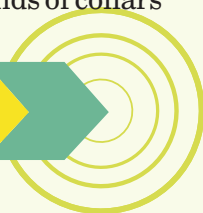



- + Stand collar
- + Flat collar
- + Roll collar

Stand collar

Stand collar stands around the neck, like Chinese or mandarin. These are cut after measuring the neck edge of the pattern.

Flat collar

Flat collar lies nearly flat on the shoulder, like Peter Pan and is cut by tracing around the neck edge of the basic bodice.

Roll collar

Roll collar is the variation of stand and fall collars where the collar stands around the neck and then rolls over to frame the face, like a turtle neck.

Collars are always cut double. The collar that comes on the top is called Top collar and the collar that comes under it is called Under collar. The Under collar is always cut smaller, instructions are given later in the chapter.

Terminology for collars

- + Neckline Edge - the edge of the collar that is stitched to the neckline.
- + Collar Edge - the outer edge of the collar also called leaf edge.
- + Collar Stand - the part of the collar that stands especially at the center back.
- + Roll Line - the line of the collar on which the collar folds or rolls.

2.10.2 Mandarin collar

Measurements needed:

Back neck - measure center back to shoulder at the neck edge.

Front neck - measure center front to shoulder at the neck edge.

A-B = 1½" is the collar stand

B-C = back neck

C-D = front neck

D-E = ½".





Draw a curved line from E to C

Square $1\frac{1}{2}$ " line at right angles to the curved line at E. Mark it as F.

Draw a line from A to F parallel to neck edge.

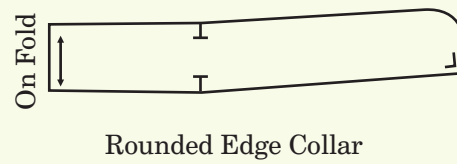
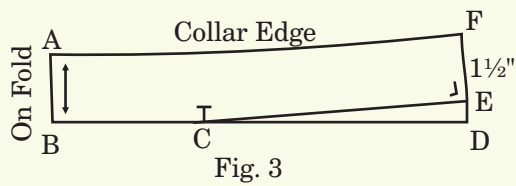
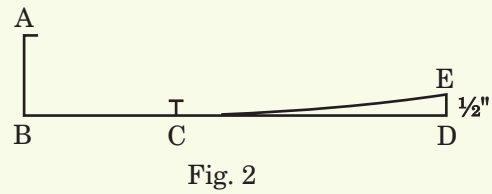
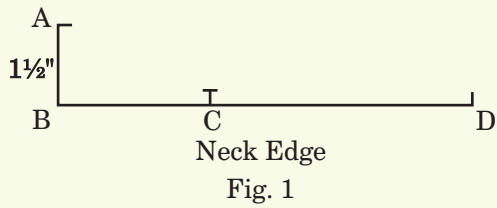

2.10.3 Peter Pan collar

Trace back pattern. Place front pattern on traced copy touching the neckline and overlapping the shoulder tips 2 inch for a roll of $\frac{1}{4}$ ".

This overlap can vary depending upon the roll desired. Lower the back and front neck by desired amount as illustrated

Redraw the neckline and copy again along with part of the center lines. A-B = desired collar width,

Draw a line starting from the centre back till centre front as shown in diagram. Shape the front as desired.

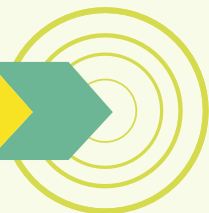
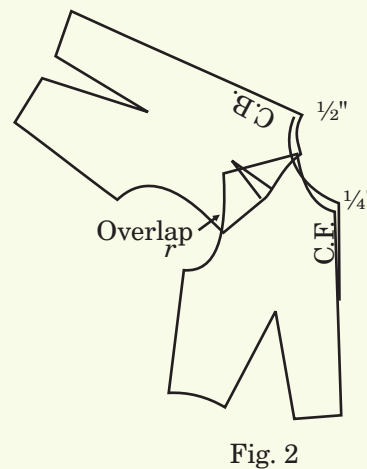
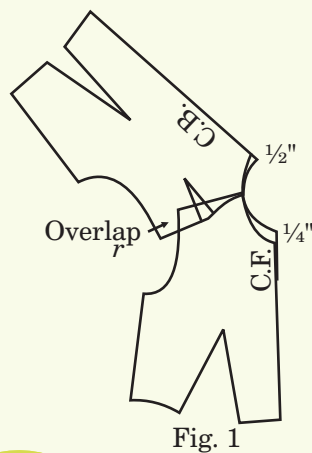

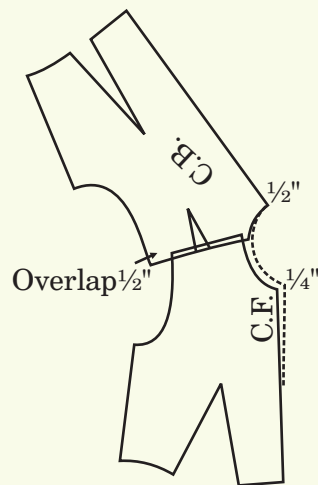

Fig. 1

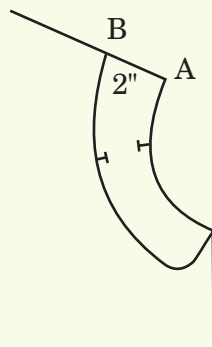

Fig.4

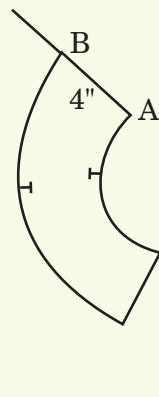

Fig.5

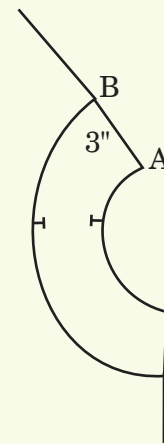

Fig.6

The above diagrams show various collar width and edges at centre front

Activity

Exercise:

1. Collect pictures of blouses and dresses with different collars and necklines and maintain this information in your scrap book. Try making patterns of at least five designs collars.

Fill in the blanks

- a. The cap height in a sleeve is required to draw the _____ of the sleeve.
- b. A Chinese collar _____ the neckline of the garment and usual width of the collar is _____.

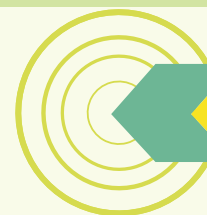



- c. Peter Pan collar _____ at the shoulder. This is achieved by overlapping _____ & _____ shoulder by at least _____.
- d. Outer edge of the collar is called _____ edge or _____ edge.

Review Questions

1. How is the Neckline Edge different from a Collar Edge?
2. Give an example each of Flat and Stand Collar.

