

## FaxFinder® Fax Server

---

FF240, FF440, FF840 Administrator Guide



## FaxFinder Administrator Guide

Models: FF240, FF440, FF840, and FFE8

Part Number: S000522, Version 4.7

### Copyright

This publication may not be reproduced, in whole or in part, without the specific and express prior written permission signed by an executive officer of Multi-Tech Systems, Inc. All rights reserved. **Copyright © 2018 by Multi-Tech Systems, Inc.**

Multi-Tech Systems, Inc. makes no representations or warranties, whether express, implied or by estoppels, with respect to the content, information, material and recommendations herein and specifically disclaims any implied warranties of merchantability, fitness for any particular purpose and non-infringement.

Multi-Tech Systems, Inc. reserves the right to revise this publication and to make changes from time to time in the content hereof without obligation of Multi-Tech Systems, Inc. to notify any person or organization of such revisions or changes.

### Trademarks

FaxFinder, Multi-Tech, and the Multi-Tech logo are registered trademarks of Multi-Tech Systems, Inc. Windows is a registered trademark of Microsoft in the U.S. and other countries. All other products and technologies are the trademarks or registered trademarks of their respective holders.

### Patents

This device covered by the following patents: 6,031,867; 6,012,113; 6,009,082; 5,905,794; 5,864,560; 5,815,567; 5,815,503; 5,812,534; 5,809,068; 5,790,532; 5,764,628; 5,764,627; 5,754,589; D394,250; 5,724,356; 5,673,268; 5,673,257; 5,644,594; 5,628,030; 5,619,508; 5,617,423; 5,600,649; 5,592,586; 5,577,041; 5,574,725; D374,222; 5,559,793; 5,546,448; 5,546,395; 5,535,204; 5,500,859; 5,471,470; 5,463,616; 5,453,986; 5,452,289; 5,450,425; D361,764; D355,658; D355,653; D353,598; D353,144; 5,355,365; 5,309,562; 5,301,274, 6,219,708. Other patents pending.

### Legal Notices

The MultiTech products are not designed, manufactured or intended for use, and should not be used, or sold or re-sold for use, in connection with applications requiring fail-safe performance or in applications where the failure of the products would reasonably be expected to result in personal injury or death, significant property damage, or serious physical or environmental damage. Examples of such use include life support machines or other life preserving medical devices or systems, air traffic control or aircraft navigation or communications systems, control equipment for nuclear facilities, or missile, nuclear, biological or chemical weapons or other military applications ("Restricted Applications"). Use of the products in such Restricted Applications is at the user's sole risk and liability.

### Contacting MultiTech

#### Knowledge Base

The Knowledge Base provides immediate access to support information and resolutions for all MultiTech products. Visit <http://www.multitech.com/kb.go>.

#### Support Portal

To create an account and submit a support case directly to our technical support team, visit: <https://support.multitech.com>.

#### Support

Business Hours: M-F, 8am to 5pm CT

Country	By Email	By Phone
Europe, Middle East, Africa:	<a href="mailto:support@multitech.co.uk">support@multitech.co.uk</a>	+(44) 118 959 7774
U.S., Canada, all others:	<a href="mailto:support@multitech.com">support@multitech.com</a>	(800) 972-2439 or (763) 717-5863

#### Warranty

To read the warranty statement for your product, visit [www.multitech.com/warranty.go](http://www.multitech.com/warranty.go). For other warranty options, visit [www.multitech.com/es.go](http://www.multitech.com/es.go).

#### World Headquarters

Multi-Tech Systems, Inc.  
 2205 Woodale Drive, Mounds View, MN 55112  
 Phone: (800) 328-9717 or (763) 785-3500  
 Fax (763) 785-9874

# Contents

<b>Chapter 1 – Product Overview .....</b>	<b>9</b>
Product Overview.....	9
Package Contents.....	9
FaxFinder Expansion Module .....	9
Safety Warnings .....	10
Analog Telecom Safety Warnings .....	10
Lithium Battery .....	10
Ethernet Ports.....	11
FF240, FF440, and FF840 Specifications .....	11
FaxFinder Expansion Module Specifications.....	12
FaxFinder x40 Power Draw .....	13
FF240 .....	13
FF440.....	13
FF840.....	13
FaxFinder Expansion Modules Power Draw.....	13
FFEX8.....	14
FFEX16.....	14
Fax File Types .....	14
Requirements.....	14
Fax Routing Overview .....	15
Inbound Routing .....	15
Outbound Routing .....	16
Static or Dynamic Delivery .....	16
PBX Call Routing.....	16
<b>Chapter 2 – Hardware and Installation.....</b>	<b>18</b>
Connectors and LEDs by Model .....	18
FaxFinder FF240 .....	18
FaxFinder FF440 .....	18
FaxFinder FF840 .....	18
Connector Descriptions.....	19
LED Descriptions .....	19
FaxFinder Expansion Module Connectors and LEDs .....	19
FaxFinder FFEX8 .....	19
FaxFinder FFEX16 .....	20
Connector Descriptions.....	20
LED Descriptions .....	20
Before Installing FaxFinder .....	20
Mounting FaxFinder (Optional).....	21

Mounting FaxFinder on a Wall.....	21
Mounting a FaxFinder Expansion Module on a Wall .....	23
Mounting FaxFinder in a Rack.....	23
Cabling FaxFinder .....	27
Cabling a FaxFinder Expansion Module to FaxFinder .....	27
<b>Chapter 3 – Basic FaxFinder Configuration .....</b>	<b>28</b>
Configuring FaxFinder's IP Address and Network Settings .....	28
Network Configuration Fields .....	29
Updating the Admin Account .....	30
Setting Time .....	30
Time Fields .....	30
Configuring SMTP.....	31
SMTP Parameters.....	31
Sending a Test Fax from Fax Machine to FaxFinder .....	31
Adding a Printer (Optional).....	32
Printer Fields .....	32
Adding a Network Share (Optional).....	32
Network Share Fields .....	33
Using a Server Certificate .....	33
Upload a Server Certificate .....	33
Generating a Server Certificate.....	34
Server Certificate Fields .....	34
Adding Individual Users .....	34
User Fields.....	35
Adding Global Contacts Individually .....	36
Routing Inbound Faxes.....	37
Configuring Inbound Options .....	38
Inbound Routing Destinations .....	40
Configuring Modems.....	40
Modem Fields .....	41
Creating a Restore File .....	44
<b>Chapter 4 – Fax Management .....</b>	<b>45</b>
Logging into the Web Management Interface.....	45
Requesting a Password .....	45
Navigating the Web Management Interface .....	45
Checking System, Printer, and Share Status .....	45
Checking Modem/Channel and Fax Status .....	46
Sending Now .....	48
Canceling Outbound Faxes.....	48
Resetting a Busy Modem .....	48
Blocking a Modem's Inbound and Outbound Faxes .....	48

Checking the Mail Queue.....	49
Resending Queued Mails .....	49
Viewing Logs.....	49
Log Fields.....	50
Rebooting FaxFinder .....	51
Restoring Factory Defaults.....	51
Restoring Configuration .....	51
<b>Chapter 5 – Managing Users, Contacts, and Recipients .....</b>	<b>52</b>
Users .....	52
Importing Users.....	52
Creating a CSV File .....	55
Importing a User CSV File .....	55
Exporting a User List .....	56
Deleting Users.....	56
Editing Users .....	56
Adding Active Directory Users .....	56
Contacts .....	57
Allowing Users to Add Global Contacts .....	57
Importing Global or Personal Contacts.....	57
Exporting a Contact List .....	59
Deleting Global or Personal Contacts .....	59
Editing Contacts .....	59
Groups.....	59
Using Groups to Organize Contacts.....	59
Adding a Global or Personal Group .....	59
Deleting Global or Personal Group .....	60
Editing Groups.....	60
Recipients.....	60
Viewing Recipients .....	60
Creating a CSV File .....	60
Importing Recipient Lists .....	61
Importing a Recipient List.....	62
Exporting a Recipient List.....	62
Deleting Recipients .....	63
<b>Chapter 6 – Advanced Configuration.....</b>	<b>64</b>
Using SFTP.....	64
SFTP Fields.....	64
Adding an SFTP Server .....	64
Downloading an SFTP Key.....	64
Editing SFTP Server Settings.....	64
Deleting an SFTP Server .....	65

Configuring Fax Log Purging.....	65
Fax Log Purge Parameters .....	65
Purging Fax Logs Immediately .....	66
Emailing or Saving Logs Immediately.....	66
Using the Common UNIX Printing System .....	66
Updating Software .....	66
Updating FaxFinder Software .....	66
Updating Modem Software .....	67
Setting the Debug Level .....	67
Downloading System Logs for Troubleshooting .....	68
Configuring Outbound Fax, Archive and Purge Options.....	68
Allowing Simultaneous Faxing .....	68
Setting Fax Storage Options.....	68
Archiving Outbound Faxes .....	68
Purging Outbound Faxes.....	69
Enabling Outbound Fax Approval .....	69
Removing Approvers.....	69
Enabling the Outbound Approval Report .....	70
Configuring Store & Forward Fax (T.37) .....	70
Store & Forward (T.37) Parameters.....	70
Adding Additional Hosts.....	71
Configuring SNMP .....	72
Viewing Available MIBs.....	72
Configuring SNMP Version 1 and 2C .....	72
Configuring SNMP Version 3 .....	72
SNMP Settings.....	72
Configuring SNMP Allowed Addresses .....	73
Setting SNMP Traps .....	73
<b>Chapter 7 – Dialing Rules .....</b>	<b>75</b>
Dialing Rules Lists.....	75
Components .....	75
Dialing Rule Patterns.....	75
Dialing Rule Actions and Arguments.....	76
Blacklist Numbers.....	76
Go to List and Return from List Actions.....	77
Examples .....	78
Creating New Dialing Rules.....	80
Adding a Rule .....	80
Applying New Dialing Rules .....	80
Editing Dialing Rules.....	80
Deleting a Dialing Rule or Dialing Rule List .....	81

<b>Chapter 8 – Using Active Directory with FaxFinder</b> .....	<b>82</b>
Enabling Active Directory .....	82
Active Directory Settings.....	82
Adding Active Directory Users .....	83
Syncing FaxFinder with Active Directory .....	83
Deleting Active Directory Users .....	83
<b>Chapter 9 – Cover Pages</b> .....	<b>84</b>
Custom Cover Pages .....	84
Tips.....	84
Text Field Names and Descriptions .....	84
Creating Cover Pages .....	85
Adding Cover Pages to FaxFinder .....	86
Providing Default Opt-Out Information for Cover Pages .....	86
Adding Date and/or Time to Cover Pages .....	86
Truncating Phone Numbers on Cover Pages .....	86
Cover Page Troubleshooting.....	86
<b>Chapter 10 – FaxFinder Fax Client Software for Windows and Mac</b> .....	<b>88</b>
FaxFinder Client for Windows.....	88
Installing FaxFinder Client Software on Windows .....	88
FaxFinder Printer Usage Rights .....	90
FaxFinder Client for Mac.....	90
Installing FaxFinder Client Software on a Mac .....	90
Associate or Disassociate FaxFinder Fax Servers from the Client.....	92
Associating FaxFinder Fax Servers with the Client .....	92
Disassociating a FaxFinder Unit from the Client .....	93
<b>Chapter 11 – Troubleshooting</b> .....	<b>94</b>
What if I can't see my FaxFinder's web page?.....	94
What if I don't get an email when I click Send Test Email? .....	94
Name server address could not be resolved .....	94
Mail Server Not Running.....	95
Client PC can't Connect to Mail Server .....	95
Incorrect Administrator Address.....	95
Mail Server Does Not Support SMTP .....	95
Discrepancy between FaxFinder's SMTP settings and Mail Server's User ID and Password Requirements .....	95
What if FaxFinder doesn't answer a fax call? .....	95
Where can I Find the SMTP Error Code List? .....	96
Dealing with a Failed Fax Report .....	96
<b>Chapter 12 – T.37 Advanced Usage</b> .....	<b>97</b>
Options.....	97
Multiple Options Example .....	98

<b>Chapter 13 – Regulatory Information .....</b>	<b>100</b>
47 CFR Part 68 Telecom .....	100
47 CFR Part 15 Regulation Class A Devices .....	101
Fax Branding Statement.....	102
Canadian Limitations.....	102
Industry Canada Class A Notice .....	102
EMC, Safety, and R&TTE Directive Compliance .....	102
Restriction of the Use of Hazardous Substances (RoHS) .....	103
REACH Statement .....	103
Registration of Substances.....	103
Substances of Very High Concern (SVHC) .....	103
Waste Electrical and Electronic Equipment Statement .....	104
WEEE Directive.....	104
Instructions for Disposal of WEEE by Users in the European Union .....	104
Information on HS/TS Substances According to Chinese Standards .....	105
Information on HS/TS Substances According to Chinese Standards (in Chinese) .....	106
<b>Chapter 14 – Configuring Active Directory for Use with FaxFinder .....</b>	<b>107</b>
FaxFinder Server Settings.....	107
Registering Schema Snap-in.....	109
Creating Custom Attributes .....	109
Custom Attribute Settings.....	111
Creating a Custom Class .....	112
Adding Custom Class to User Class.....	115
User Attributes Management .....	116
Active Directory User Attributes.....	116
Editing User Attributes.....	117
Create a User Group .....	117
Add Users for FaxFinder.....	117
Add Users to FaxFinder User Groups.....	117
Active Directory Troubleshooting .....	118
Verify Connection .....	118
<b>Add Group Fails with Error: The Specified Group Name Cannot be Found .....</b>	<b>118</b>
Add Group or Sync Fails with Error: Synchronization Failed .....	118
Group Successfully Added, But No Users are Added.....	118
Group Successfully Added, But Not All Users are Added .....	119
Not Able to Edit a User's mtff Attributes on the Windows Server.....	119
Some User's mtff Attributes are Not Shown in Windows Server Editor .....	119
Attributes can be Edited on Windows Server, Changes aren't Shown in FaxFinder Users .....	120
Unable connect using SSL on port 636 .....	120
<b>Index.....</b>	<b>121</b>



# Chapter 1 – Product Overview

## Product Overview

FaxFinder is an all-in-one fax server that provides faxing capabilities over a WAN from a corporate office to remote offices as well as to field sales people.

FaxFinder devices convert inbound faxes to PDF or TIFF files and delivers them to a recipient's inbox, a network folder, or a network printer. Users can send outbound faxes through a fax client, web browser, or the print function of other applications.

The FaxFinder includes the following models:

- FF240-IP
- FF240 2-modems
- FF440 4-modems
- FF840 8-modems

Multi-Tech provides the following manuals for use with FaxFinder:

- **Administrator Guide** provides details on installing, configuring, and managing FaxFinder.
- **Specifications and Regulatory Information** provides product specifications, installation instructions, and regulatory information.
- **User Guide** provides details on sending faxes and using the client software.
- **Developer Guide** provides information and examples for the FaxFinder Web Services API.

## Package Contents

The package contents include:

- FaxFinder with factory installed software
- Universal power supply with power cord
- One serial cable
- Adhesive plastic feet
- Safety notice card
- Two mounting brackets and screws; the same bracket is used for wall and rack mounting

FaxFinder x40 devices only:

- One phone cable for each port with RJ-11 at both ends
- One serial debug cable

## FaxFinder Expansion Module

FaxFinder Expansion Modules are optional hardware that allow you to add eight or sixteen additional modems to your FaxFinder.

- FFEX8 8-modems
- FFEX16 16-modems

## Safety Warnings

### Analog Telecom Safety Warnings

Before servicing, disconnect this product from its power source and telephone network. Also:

- Never install telephone wiring during a lightning storm.
- Never install a telephone jack in wet locations unless the jack is specifically designed for wet locations.
- Use this product with UL and cUL listed computers only.
- Never touch uninsulated telephone wires or terminals unless the telephone line has been disconnected at the network interface.
- Use caution when installing or modifying telephone lines.
- Avoid using a telephone during an electrical storm. There is a remote risk of electrical shock from lightning.
- Do not use a telephone in the vicinity of a gas leak.

**CAUTION:** To reduce the risk of fire, use only 26 AWG or larger UL Listed or CSA Certified telecommunication Line cord.

### Avertissements de sécurité relatifs aux télécommunications analogiques

Avant l'entretien, débranchez ce produit de sa source d'alimentation et du réseau téléphonique. Aussi:

- N'installez jamais le câblage d'un téléphone pendant un orage.
- N'installez jamais la prise d'un téléphone dans un endroit mouillé sauf si la prise est spécifiquement conçue pour y résister.
- Utilisez ce produit uniquement avec les ordinateurs listés UL et cUL.
- Ne touchez jamais les fils dénudés ou les bornes d'un téléphone sauf si la ligne téléphonique a été débranchée au niveau de l'interface réseau.
- Procédez avec prudence en installant ou en modifiant les lignes téléphoniques.
- Évitez d'utiliser un téléphone pendant un orage. Il existe un léger risque d'électrocution par la foudre.
- N'utilisez pas un téléphone à proximité d'une fuite de gaz.

**CAUTION:** Pour réduire le risque d'incendie, utilisez uniquement des cordons de raccordement de télécommunication listés UL ou certifiés CSA de calibre 26 AWG ou supérieur.

### Lithium Battery

- A lithium battery (3V, coin cell, CR1632) located within the product provides backup power for the timekeeping. This battery has an estimated life expectancy of ten years.
- When this battery starts to weaken, the date and time may be incorrect.
- Battery is not user replaceable. If the battery fails, the device must be sent back to MultiTech Systems for battery replacement.
- Lithium cells and batteries are subject to the Provisions for International Transportation. Multi-Tech Systems, Inc. confirms that the Lithium batteries used in the MultiTech product(s) referenced in this manual comply with Special Provision 188 of the UN Model Regulations, Special Provision A45 of the ICAO-TI/IATA-DGR (Air), Special Provision 310 of the IMDG Code, and Special Provision 188 of the ADR and RID (Road and Rail Europe).

**CAUTION:** Risk of explosion if this battery is replaced by an incorrect type. Dispose of batteries according to instructions.

**Attention:** Risque d'explosion si vous remplacez la batterie par un modèle incompatible. Jetez les piles usagées selon les instructions.

## Ethernet Ports

**CAUTION:** Ethernet ports and command ports are not designed to be connected to a public telecommunication network.

### Ports Ethernet

**CAUTION:** Les ports Ethernet et de commande ne sont pas conçus pour être raccordés à un réseau de télécommunications public.

## FF240, FF440, and FF840 Specifications

Category	Description		
<b>Physical Description</b>			
Dimensions	W 15.335 in x H 1.717 in x D 6.033 in <b>Note:</b> Adding the plastic feet increases the height to 1.877 in. For dimensions with mounting brackets, refer to the Mounting FaxFinder topic.		
Weight	<b>FF240</b>	<b>FF440</b>	<b>FF840</b>
	4.1 lbs (1.9 kg)	4.2 lbs (2.0 kg)	4.5 lbs (2.1 kg)
<b>Connectors</b>			
Connectors	1 RJ-45 console serial port		
	1 RJ-45 Ethernet port		
	2 USB ports		
	RJ-11 line jacks		
<b>Power Requirements</b>			
Input Voltage	12 Volts		
	See FaxFinder Power Draw for additional power information.		
<b>Environment</b>			
Operating Environment	-40° to 167° F (-40° to +75° C) <sup>1</sup>		
Storage Environment	-40° to 185° F (-40° to +85° C)		
Relative Humidity	20 to 90% noncondensing		
<b>Fax Specifications</b>			
Fax Specs	(MT5634SMI modem) Group 3 Fax (T.30 and T.4) Modulations: ITU V.34, ITU V.17, V.29, V.27 and V.21		
Web Connections	50		
File Upload Size <sup>2</sup>	48MB max for the Send Fax Web page 36MB max for T.37, Client software and API		

Category	Description
<b>Certifications</b>	
EMC Approvals	FCC Part 15 Class A, EN 55022 Class A, EN 55024
Safety Approvals	UL\cUL 60950-1 ed.2, IEC 60950-1 ed.2 & EN (2006 +am.11)
Telecom Approvals	47CFR Part 68, CS03, TBR21; Other countries also included

<sup>1</sup>UL Listed @ 40°C. Limited by power supply. UL Certification does not apply or extend to an ambient above 40°C and has not been evaluated by UL for ambient greater than 40°C.

Listé UL à 40° C, limité par l'alimentation. La certification UL ne s'applique pas ou ne s'étend pas à des températures dépassant 40° C, et le produit n'a pas été évalué par UL pour une température ambiante dépassant 40° C.

**Note:** This product is intended to be supplied by a Listed Power Unit marked L.P.S. or Class 2 and rated 12 VDC 5A.

<sup>2</sup>The difference in maximum size allowed is due to the data encoding for T.37, the client software, and API attachments.

## FaxFinder Expansion Module Specifications

Category	Description
<b>Dimensions</b>	
Dimensions	W 15.335 in x H 1.717 in x D 6.033 in. <b>Note:</b> For dimensions with mounting brackets, refer to the Mounting a FaxFinder Expansion Unit topics.
Weight	7.77 pounds
<b>Connectors</b>	
Connectors	USB 2.0 High speed Mini B connector
	8 or 16 RJ-11 line jacks
<b>Power Requirements</b>	
Input Voltage	9 Volts
	Refer to FaxFinder Expansion Modules Power Draw for additional power information.
<b>Environment</b>	
Operating Environment	-40° to 152° F (-40° to +67° C)
Storage Environment	-40° to 185° F (-40° to +85° C)
Relative Humidity	20 to 90% noncondensing
<b>Certifications</b>	
EMC Approvals	FCC Part 15 Class A, EN 55022 Class A, EN 55024
Safety Approvals	UL\cUL 60950-1 ed.2, IEC 60950-1 ed.2 & EN (2006 +am.11)

Category	Description
Telecom Approvals	47CFR Part 68, CS03, TBR21; Other countries also included

**Note:** This product is intended to be supplied a listed power Module marked L.P.S. or Class 2 and rates from 9Vdc 2A.

Multi-Tech Systems, Inc. recommends that the customer incorporate a 10% buffer into their power source when determining product load.

<sup>1</sup>Typical is the current while the unit is powered up, but not sending or receiving faxes.

<sup>2</sup>Maximum is the current while sending or receiving faxes.

<sup>3</sup>Peak is the current while sending or receiving faxes.

## FaxFinder x40 Power Draw

FaxFinder power draw at 12 volts.

**Note:** The following applies to .R1 and .R2 models only. For earlier models, please contact MultiTech.

### FF240

	Sleep Mode	Typical <sup>1</sup>	Maximum <sup>2</sup>	Peak <sup>3</sup>
Current (AMPS)	0.665	0.711	0.837	0.959

### FF440

	Sleep Mode	Typical <sup>1</sup>	Maximum <sup>2</sup>	Peak <sup>3</sup>
Current (AMPS)	0.801	0.890	0.930	1.07

### FF840

	Sleep Mode	Typical <sup>1</sup>	Maximum <sup>2</sup>	Peak <sup>3</sup>
Current (AMPS)	0.965	1.100	1.210	1.38

Multi-Tech Systems, Inc. recommends that the customer incorporate a 10% buffer into their power source when determining product load.

<sup>1</sup>Typical is the current while the unit is powered up, but not sending or receiving faxes.

<sup>2</sup>Maximum is the current while sending or receiving faxes.

<sup>3</sup>Peak is the peak current while sending or receiving faxes.

## FaxFinder Expansion Modules Power Draw

FaxFinder Expansion Module power draw at 9 volts.

## FFEX8

	Typical <sup>1</sup>	Maximum <sup>2</sup>	Peak <sup>3</sup>
Current (AMPS)	0.837	0.895	0.940
Watts	7.59	8.11	--

## FFEX16

	Typical <sup>1</sup>	Maximum <sup>2</sup>	Peak <sup>3</sup>
Current (AMPS)	1.430	1.560	1.630
Watts	12.81	13.95	--

Multi-Tech Systems, Inc. recommends that the customer incorporate a 10% buffer into their power source when determining product load.

<sup>1</sup>Typical is the current while the module is powered up, but not sending or receiving faxes.

<sup>2</sup>Maximum is the current while sending or receiving faxes.

<sup>3</sup>Peak is the current while sending or receiving faxes.

## Fax File Types

Users can fax the following document types through the web management interface. Additional options are available through the FaxFinder Client.

- PDF
- PS
- TIF or TIFF
- TXT
- BMP
- JPG

**Note:** When printing from another application, FaxFinder sends the file as TIF images.

## Requirements

The FaxFinder Fax Server is an IP enabled fax server that works with other devices and services on your communication network to send and receive faxes and to perform administrative functions. FaxFinder requires:

### SMTP server access

Used to distribute FaxFinder emails that contain faxes, administrative notices, and log files.

- Multi-Tech recommends that you create a DNS A record for FaxFinder.
- Depending on the location of email recipients and IP resources, FaxFinder may also require WAN access through your network's Internet gateway.

### Analog phone lines that provide dial tone and ring voltage at traditional levels and cadence

To fully use FaxFinder's inbound fax routing, communication lines (PBX ports) need to pass direct inward dial (DID) information in DTMF format to FaxFinder when the FaxFinder port goes off hook to answer a call.

### A workstation for initial FaxFinder configuration

Depending on your network, you may need to connect FaxFinder directly to the workstation to complete initial network setup. You will need to identify and possibly change the workstation's current IP. If using a laptop, note that an active WiFi connection may interfere with the Ethernet connection to FaxFinder.

### Internet Browser

Use a current version of your Internet browser. Some FaxFinder Web Management pages do not render correctly on outdated browsers.

### Static IP address

FaxFinder does not support automatically assigned IP addresses via DHCP. FaxFinder is set from the factory with an IP address of 192.168.2.1 (netmask 255.255.255.000).

### Ethernet and RJ-45 Cable

You need to know if your Ethernet equipment has a simple traditional switch or hub, a managed V-LAN switch that is IP address aware (and will block traffic that is not from its configured subnet), or a port on a network enabled device (such as a PBX or router) with controls that are similar to a managed switch.

- FaxFinder's Ethernet interface is full duplex, auto negotiating 10/100/1000 Mb and auto polarity sensing. Auto polarity allows you to use a traditional straight through or cross-over, Ethernet RJ-45 cable.
- FaxFinder does not support POE (Power over Ethernet). You may need to disable POE features on the Ethernet port that you connect to the FaxFinder.

## Fax Routing Overview

### Inbound Routing

Depending on your network configuration, FaxFinder can route incoming faxes to a network printer, network share, and through your mail server to any individual user. FaxFinder can deliver incoming faxes as email attachments to any user on your mail system, whether local, remote, or mobile.

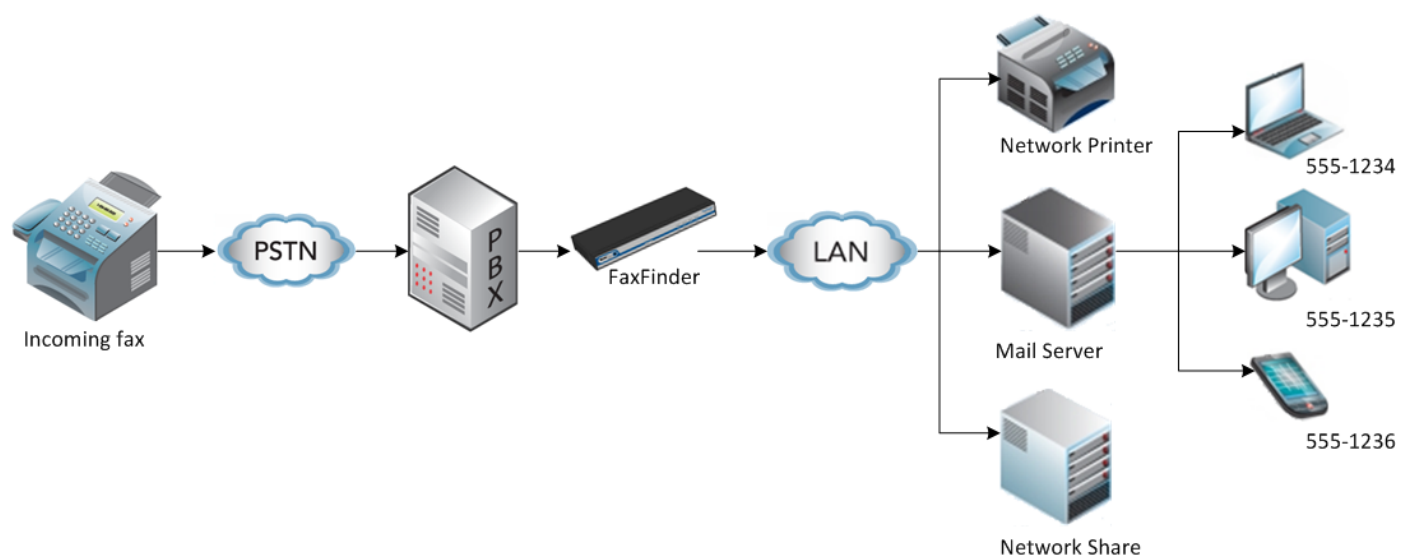

## Outbound Routing

You can configure FaxFinder so that users can send faxes through a T.37 email, the FaxFinder Fax Client, a web browser, or a Web API. Fax Client Software, installed on a user's Windows computer, also allows the user to send faxes through the print function of any software.

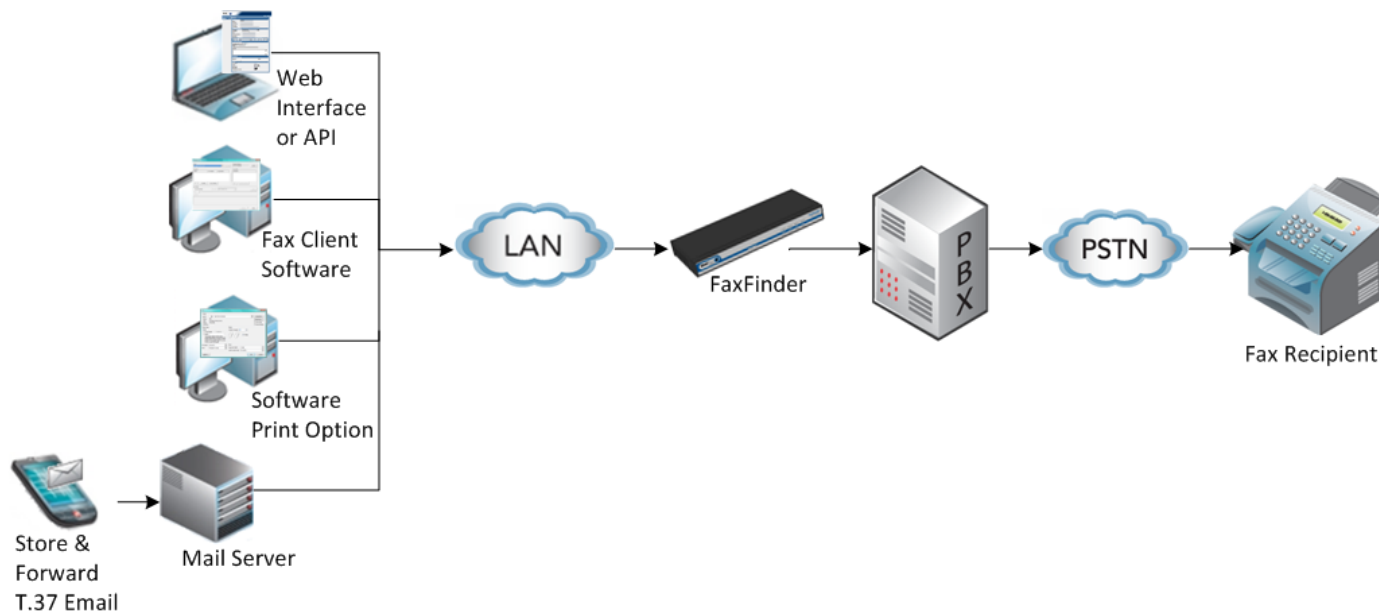

## Static or Dynamic Delivery

The source and type of communication lines that connect to FaxFinder dictate if the inbound fax routing method is set for dynamic or static delivery. Dynamic delivery is based on the number dialed by the party sending the fax. Static delivery is based on which communication line/FaxFinder port the inbound fax uses.

Although FaxFinder ports can be connected to an ordinary phone line (POTS line), they are often connected to a PBX extension/station port. FaxFinder can deliver incoming faxes as email messages to any user on your network. Use this feature when your PBX can route multiple receiving numbers to a single station port. A PBX may determine which number was dialed by the originator, for example, through an IP enabled PBX communicating directly with an IP based PSTN service or other IP enabled communication equipment.

## PBX Call Routing

1. PBX sends a call to the FaxFinder by ringing the extension connected to the FaxFinder port.
2. FaxFinder picks up (goes off hook).
3. The PBX transmits a string of DTMF digits to the extension. Usually this is the last x number of digits dialed by the calling side.
4. FaxFinder port answers as a fax machine and receives the incoming fax.
5. When the fax transmission completes, FaxFinder uses the DID information to determine delivery options. FaxFinder does this by reading the recipient inbound routing table in the FaxFinder.

When the PBX provides call routing information, it does not matter which FaxFinder port (line) receives the call. The fax will be routed to all the delivery options associated with the DID number (recipient extension) defined in the Recipient routing table.



If the PBX/analog line cannot provide DID call routing, incoming faxes will be routed solely on the delivery options associated with specific FaxFinder port (line) that the call was received on. You can define multiple delivery options for each physical line/port.

# Chapter 2 – Hardware and Installation

## Connectors and LEDs by Model

### FaxFinder FF240

FaxFinder FF240 Connectors

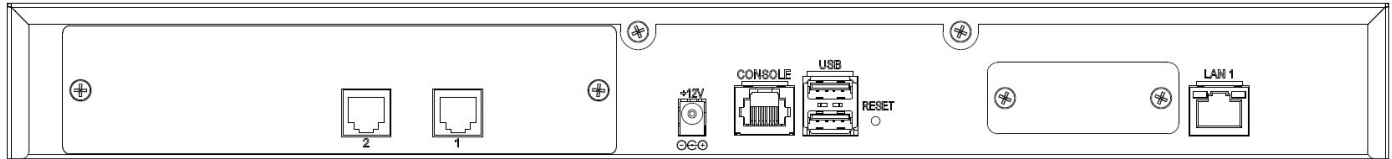

FaxFinder FF240 LEDs

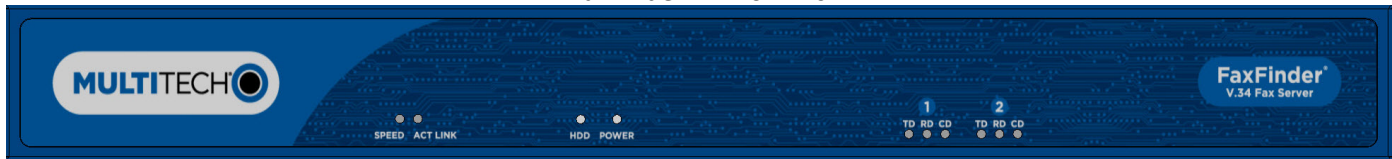

### FaxFinder FF440

FaxFinder 440 Connectors

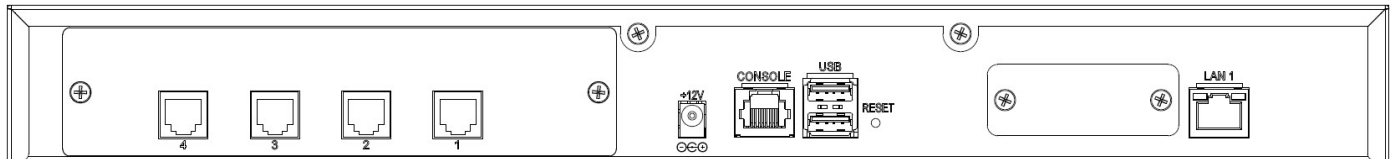

FaxFinder FF440 LEDs

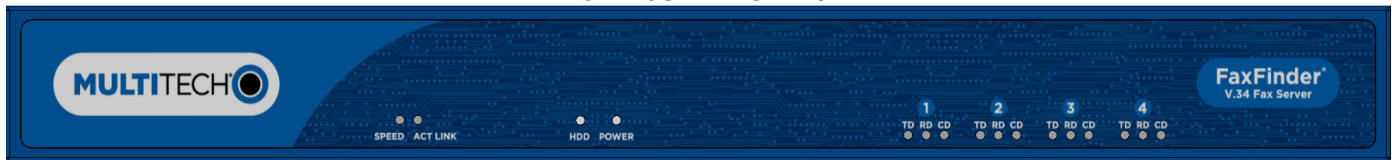

### FaxFinder FF840

FaxFinder FF840 Connectors

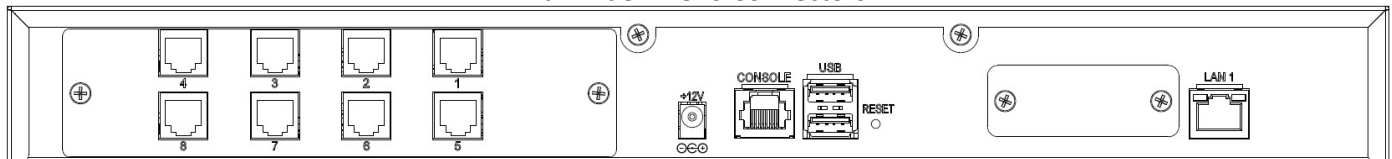

FaxFinder FF840 LEDs

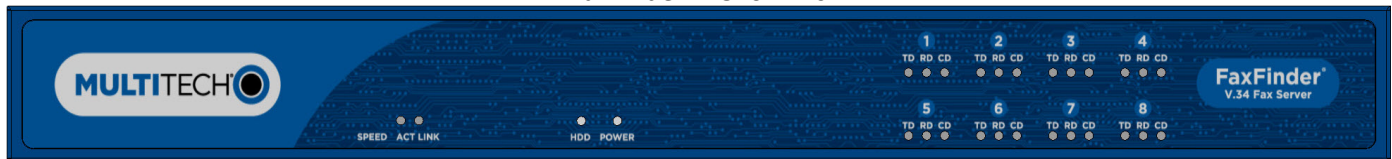

## Connector Descriptions

Label	Description
1-8	PSTN/POTS RJ 11 phone line ports. The FaxFinder 240 has ports 1-2, the FaxFinder 440 has ports 1-4, and the FaxFinder 840 has ports 1-8. Ports on the back line up with the modem LEDs on the front.
+12V	Power receptacle for provided power cord.
CONSOLE	DE-9 connection for serial access and control of the FaxFinder.
USB	Used to connect a FaxFinder Expansion Unit.
RESET	Use to reboot the FaxFinder.
LAN 1	RJ-45 receptacle for network connection.

## LED Descriptions

Label	Name	Description
Speed	Speed	When lit, if the color is:  <b>Green:</b> Ethernet rate is 1000 Mbps  <b>Yellow:</b> Ethernet rate is 100 Mbps  <b>Unlit:</b> Ethernet rate is 10 Mbps
Link/Act	Link / Activity	Lit when a physical link has been established with the Ethernet network. Blinks when there is activity.
HDD	High Density Drive	When the internal hard drive is accessed, this LED is yellow. When unlit, HDD is not being accessed.
Power	Power	Solid (constant) green if unit is on.
One set of the following for each modem/port:		
TD	Transmit Data	TD LED flashes when the modem transmits data to another modem.
RD	Receive Data	RD LED flashes when the modem receives data from another modem.
CD	Carrier Detect	Carrier of remote modem is detected.

## FaxFinder Expansion Module Connectors and LEDs

This topic applies to optional FaxFinder Expansion Modules.

### FaxFinder FFEX8

FaxFinder FFEX8 Connectors

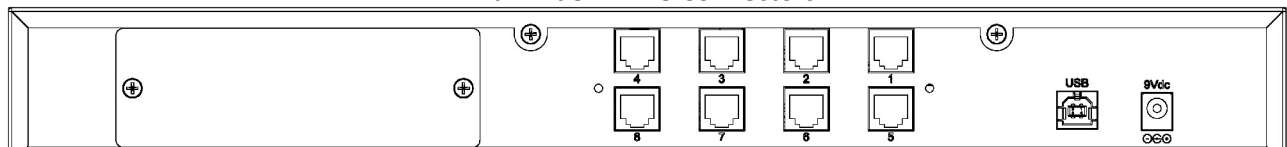

FaxFinder FFE8 LEDs



## FaxFinder FFE16

FaxFinder FFE16 Connectors

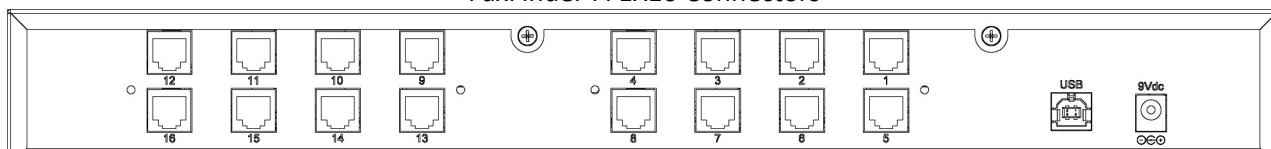

FaxFinder FFE16 LEDs



## Connector Descriptions

Label	Description
1-8 or 1-16	PSTN/POTS RJ 11 phone line ports. The FaxFinder Expansion Module comes with either 8 ports or 16 ports. Ports on the back line up with the modem LEDs on the front.
9V	Power receptacle for provided power cord.
USB	Used to connect to FaxFinder.

## LED Descriptions

Label	Name	Description
Power	Power	Solid (constant) green if module is on.
One set of the following for each modem/port:		
TD	Transmit Data	TD LED flashes when the modem transmits data to another modem.
RD	Receive Data	RD LED flashes when the modem receives data from another modem.
CD	Carrier Detect	Remote modem carrier is detected.

## Before Installing FaxFinder

**Disable Call Waiting on lines or PBX ports to be used with FaxFinder.** FaxFinder does not support Call Waiting. The Call Waiting beep causes fax communication errors.

## Mounting FaxFinder (Optional)

FaxFinder x40 models are table-top units that can be wall- or rack-mounted. Mounting kits can be purchased separately.

### Mounting FaxFinder on a Wall

Use these steps to mount FaxFinder on a wall.

Dimensions with brackets attached for wall mounting (top view)

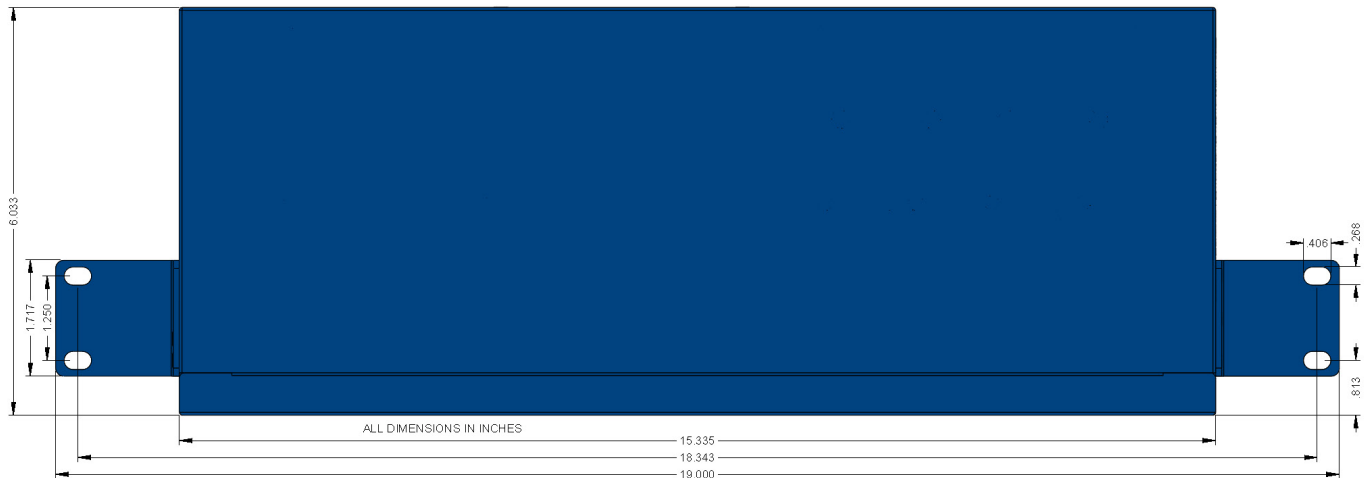

Dimensions with brackets attached for wall mounting (front view)

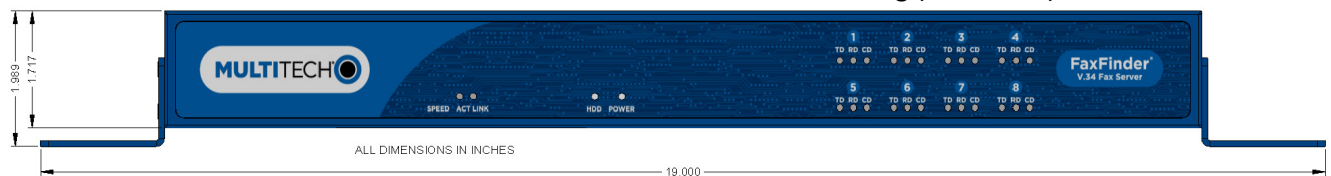

1. Position a mounting bracket on the right side using two mounting screw holes.

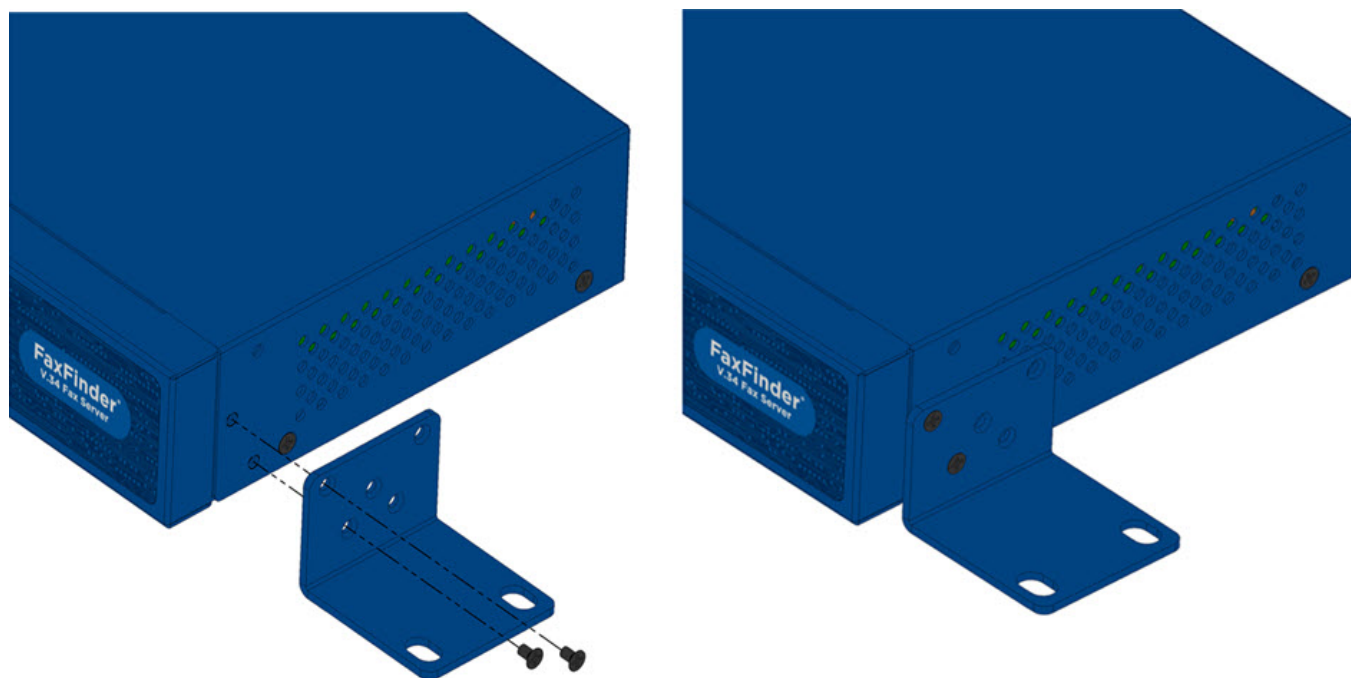

2. Secure the bracket to the device using two provided screws.
3. Position a mounting bracket on the left side using two mounting screw holes.
4. Secure the bracket to the device using two provided screws.

## Mounting a FaxFinder Expansion Module on a Wall

Images below show the dimensions for both the 8-port and 16-port FaxFinder Expansion Modules. To mount an Expansion Module on a wall, follow the steps for wall mounting a Fax Server.

Dimensions with brackets attached for wall mounting (top view)

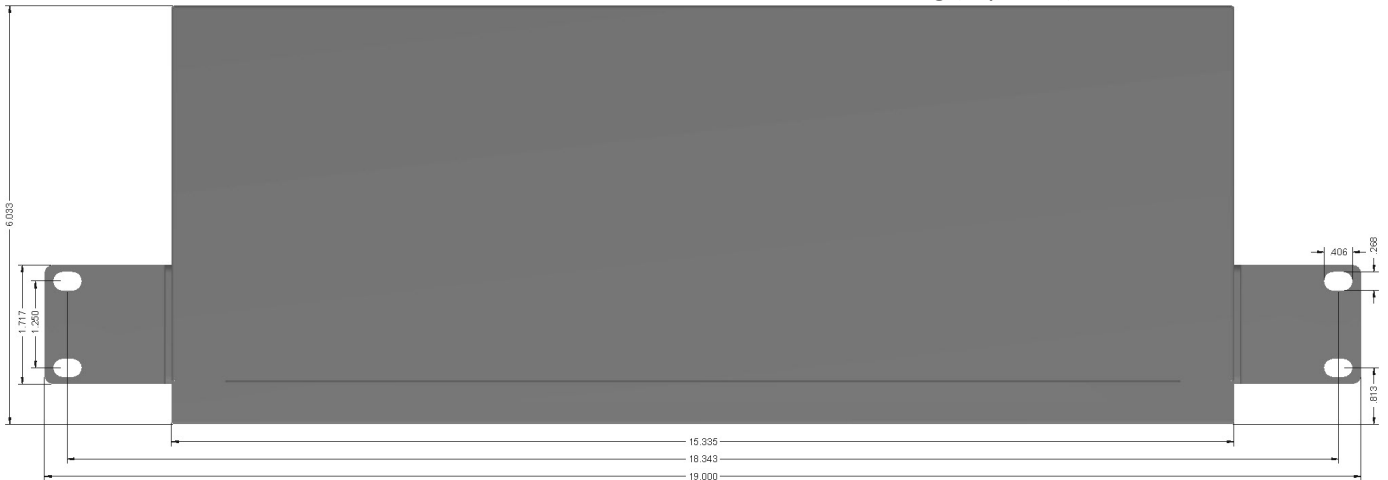

Dimensions with brackets attached for wall mounting (front view)

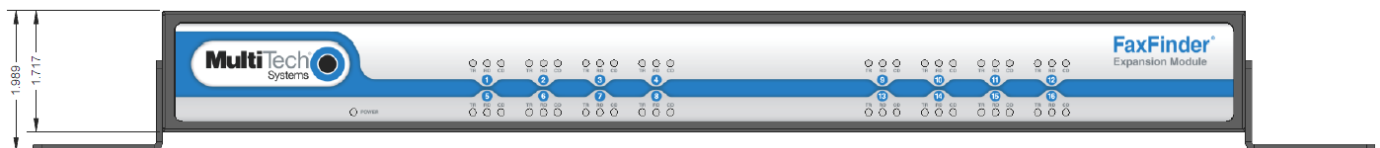

## Mounting FaxFinder in a Rack

### Rack Safety

When installing the unit in a closed or multi-unit enclosure, follow the recommended installation defined by the enclosure manufacturer.

**Note:** The ambient temperature of the rack interior must not exceed 40° Celsius.

- Do not place the unit directly on top of other equipment or place other equipment directly on top of the unit.
- If installing the unit in a closed or multi-unit enclosure, ensure adequate airflow within the rack so that the maximum recommended ambient temperature (40° C) is not exceeded.
- Ensure that the unit is properly connected to earth ground by verifying that it is reliably grounded when mounted within a rack.
- If a power strip is used, ensure that the power strip provides adequate grounding of the attached apparatus.
- When mounting the equipment in the rack, make sure mechanical loading is even to avoid a hazardous condition. The rack should safely support the combined weight of all the equipment it supports.
- Ensure that the main supply circuit is capable of handling the load of the equipment. See the power label on the equipment for load requirements.
- Only properly qualified service personnel should install this equipment. Only connect like circuits - connect SELV (Secondary Extra Low Voltage) circuits to SELV circuits and TN (Telecommunications Network) circuits to TN circuits.

## Sécurité relative au bâti

Lors de l'installation de l'unité dans une enceinte pouvant en héberger plusieurs, suivez la procédure d'installation du fabricant de l'enceinte.

**Note:** La température ambiante à l'intérieur du bâti ne doit pas dépasser 40° Celsius.

- Ne placez pas l'unité directement sur le dessus ou en dessous d'un autre équipement.
- Si l'unité est installée dans une enceinte pouvant en héberger plusieurs, veillez à ce que l'air circule correctement dans le bâti afin que la température ambiante maximale recommandée (40° C) ne soit pas dépassée.
- Veillez à ce que l'unité soit correctement mise à la terre en vérifiant la fiabilité du raccordement de terre lorsque l'unité est installée dans un bâti.
- Si une multiprise est utilisée, veillez à ce qu'elle fournisse une mise à la terre appropriée à l'appareil qui y est branché.
- Lors de l'installation de l'équipement dans un bâti, veillez à ce que la charge mécanique soit homogène de sorte à éviter toute situation potentiellement dangereuse. Le bâti doit supporter le poids de l'ensemble des équipements qu'il contient.
- Assurez-vous que le circuit d'alimentation principale est capable de gérer la charge de l'équipement. Consultez l'étiquette d'alimentation sur l'équipement pour connaître les spécifications relatives aux charges.
- Cet équipement ne doit être installé que par un technicien de maintenance dûment qualifié. Ne raccordez des circuits que s'ils sont du même type: raccordez un circuit STBT (Secondaire Très Basse Tension) à un autre circuit STBT et un circuit RT (Réseau de télécommunications) à un autre circuit RT.

## Mounting FaxFinder in a 19-inch Rack

Use these steps to mount FaxFinder in a 19-inch rack enclosure.

Dimensions with brackets attached for rack mounting (top view)



Dimensions with brackets attached for rack mounting (front view)

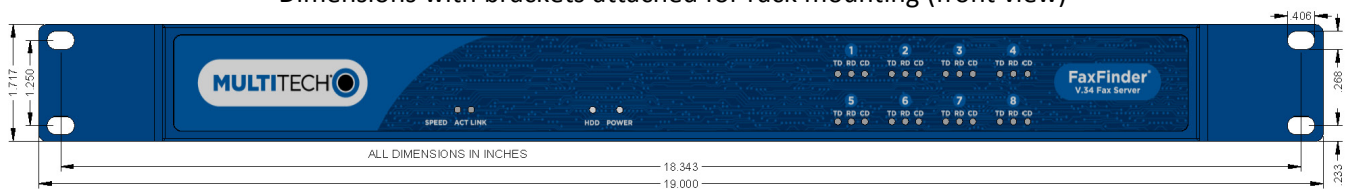

**Note:**



Attaching the device to the rail of an EIA 19-inch rack enclosure may require two people.

1. Position a mounting bracket on the right side as shown.

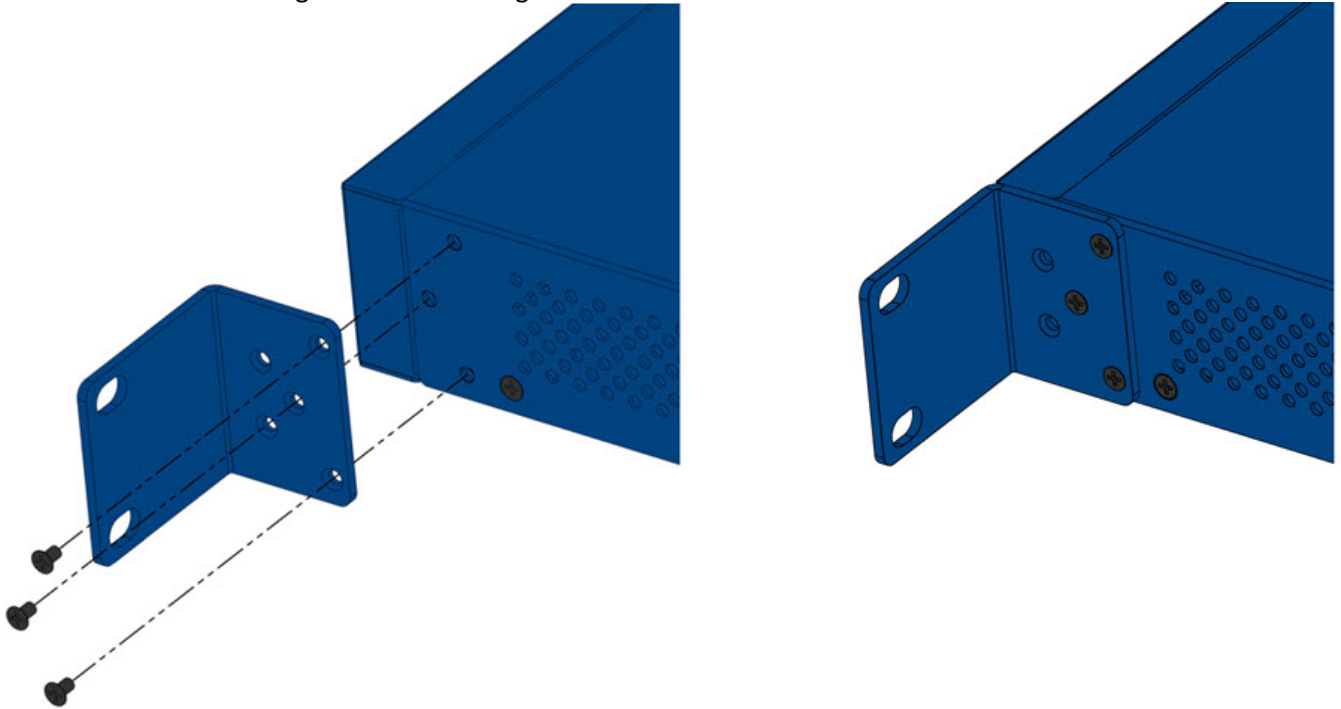

2. Secure the bracket to right side using three provided screws as shown.
3. Position a mounting bracket on the left side.
4. Secure the bracket to left side using three provided screws.
5. Remove feet (4) from the unit.
6. Secure the unit to rack rails by the brackets and mount the FaxFinder in the rack enclosure per the rack manufacturer's mounting procedure. Because equipment racks vary, screws for rack-rail mounting are not provided. Follow the instructions of the rack manufacturer and use screws that fit.

### Mounting a FaxFinder Expansion Module in a 19-inch Rack

Images below show the dimensions for both the 8-port and 16-port FaxFinder Expansion Modules. To rack mount an Expansion Unit, follow the steps for rack mounting the FaxFinder Fax Server.

Dimensions with brackets attached for rack mounting (top view)



Dimensions with brackets attached for rack mounting (front view)

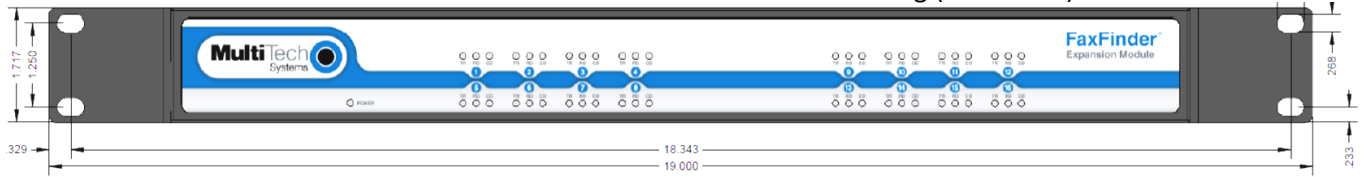

## Cabling FaxFinder

To cable FaxFinder:

1. Connect the power cord to an outlet or power strip and to the power adapter.
2. Connect the power adaptor to the 12V connector on the FaxFinder.

Use only the power supply provided with the FaxFinder. Using any other power supply voids the warranty and can damage the FaxFinder.

3. Verify power.
  - The Power LED comes on immediately after power is applied.
  - FaxFinder takes a short time to boot up when you apply power.
4. Connect FaxFinder to Ethernet Network. Plug one end of your RJ-45 Ethernet cable into the FaxFinder's Ethernet port (labeled LAN1) and the other end into your network Ethernet hub. This Ethernet cable is not included with your FaxFinder unit.

### Warning:

Before connecting to the Ethernet Network, determine if the network is a 192.168.2.x subnet. FaxFinder's factory default IP address is 192.168.2.1. Connecting the FaxFinder to a network that has a different device at the same IP address will cause data interference.

If your existing Ethernet network uses a 192.168.2.x subnet, connect from the Administrative PC to the FaxFinder using an RJ-45 Ethernet cable and configure the FaxFinder's IP address to an IP address currently available on the Ethernet network. (Refer to Configuring FaxFinder's IP address and Network Settings.) When the FaxFinder's IP address has been configured, you can connect the FaxFinder into the network.

5. Use the RJ-11 cables to connect individual ports to either a PBX or POTS lines.

## Cabling a FaxFinder Expansion Module to FaxFinder

To cable FaxFinder Expansion Module to Faxfinder:

1. Connect the Expansion Module power cord to an outlet or power strip and to the power adapter.
2. Connect the power adaptor to the 12V connector on the Expansion Module.

**Caution:** Use only the power supply provided with the Expansion Module. Using any other power supply voids the warranty and can damage the unit.

3. Verify power. The Power LED lights up immediately after power is applied.
4. Power down the FaxFinder.
5. Use the USB cable to connect the USB port on the Expansion Module to the USB port on the FaxFinder.
6. Power up the FaxFinder.
7. Use the RJ-11 cables to connect individual ports to either a PBX or POTS lines.

## Chapter 3 – Basic FaxFinder Configuration

### Configuring FaxFinder's IP Address and Network Settings

To configure the FaxFinder's IP address:

1. Set the admin computer to startup IP address.

If FaxFinder is already connected to a network, the client software can auto-discover the IP address. You can also use the console port and a terminal program to learn its IP address; enter "ifconfig eth0" in the terminal program.

Connect the FaxFinder directly to a compatible computer so you can change the FaxFinder's IP address to one that will operate on your network. To connect a FaxFinder directly to a compatible computer:

  - a. Use an RJ-45 network cable to connect a PC directly to your FaxFinder (this may require you to disconnect the PC from its current network).
  - b. Set the IP address through the PC connected to the FaxFinder. In the Windows Control Panel, open the Network option. Open Properties for the Local Area Connection. Record the original IP address so you may re-enter it when finished. Select **Use the following IP address** and set the IP address to **http://192.168.2.x** where x can be from **2** to **254** (use any address except 192.168.2.1). Close the Properties forms.
2. Log in to FaxFinder Web Management.
  - a. Open a web browser and enter the FaxFinder IP address, **192.168.2.1**. The Login screen appears, showing that the FaxFinder is connected to the network.

**Note:** FaxFinder uses a Secure WEB interface via TLS (HTTPS browsing) with a self-signed certificate. Your browser will display a warning message about expired or invalid certificates. Ignore the warning or add an exception. Refer to [Generating a Server Certificate](#) for details.
  - b. Enter **admin** (all lower case) in both the Username and Password fields.
  - c. Click **Login**. The Web Management home page appears. Use this page to access all the FaxFinder Server software screens.
3. Set FaxFinder's IP Addresses.
  - a. Click **System Configuration**. The Network Configuration page appears.
  - b. Enter the IP Address and other network information for your FaxFinder. Refer to [Network Configuration Fields](#) for field details.
  - c. Click **Save**.
    - If you have not changed a DNS setting, changes take effect within a few seconds.
    - If you have changed a DNS setting, the system prompts you to reboot the unit and changes take effect when the reboot completes. Change will not take effect if you cancel the reboot. You can wait to reboot until you complete configuration.

**Note:** At this stage, your computer and the FaxFinder will no longer communicate with each other.
4. Reset the admin computer's IP Address.
  - a. Reset the computer's IP address to the original value that you recorded in Step 1 or any other IP address that allows you to communicate with the FaxFinder at its new IP address.

- b. Disconnect the computer from the FaxFinder.
  - c. Re-connect your computer to its normal LAN connection.
5. Log in after reset. After resetting admin computer's IP address, you must log into the FaxFinder Server software again.
- a. Enter the new IP address of the FaxFinder into your browser.
  - b. Enter **admin** (all lower case) in both the Username and Password fields.

Again, your browser may show a warning about the certificate. Ignore it and continue.

## Network Configuration Fields

FaxFinder's factory default IP address is 192.168.2.1 and 24 bit network mask is 255.255.255.0.

Field	Description
Hostname	<b>Required.</b> Enter an alphanumeric hostname to associate with this FaxFinder. Hostnames can contain periods (.) and dashes (-). Multi-Tech recommends that the hostname be resolvable by DNS or otherwise. FaxFinder uses this hostname to identify itself when connecting to an SMTP server. This hostname is also used in the recipient's address for T.37 emails.
Description	Enter a description up to 64 characters. This appears on the Web Management home page.
IP Address	<b>Required.</b> Enter a static IP address for the FaxFinder to use. FaxFinder does not support automatic assignment (DHCP). If you are setting up this FaxFinder for the first time, once you change the IP address, you will need to be on the same network to make changes.
Subnet Mask	<b>Required.</b> Enter the subnet mask to be used by this FaxFinder. A typical subnet mask is 255.255.255.0, but your network may be different.
Default Gateway	<b>Required.</b> Enter the network's default gateway IP address. This allows FaxFinder to contact network addresses outside the local network, such as an internet time server or SMTP server.
Primary DNS	Enter the primary domain name server, if any, that this FaxFinder will use for IP address name resolution. If you change this value, reboot the system when you save your changes.
Secondary DNS	Enter the secondary domain name server, if any, for this FaxFinder. If you change this value, reboot the system when you save your changes.

## Updating the Admin Account

By default, FaxFinder includes an admin user account. Update the factory-default settings with a secure password and an email address.

1. Click **Users**.
2. Click **Edit** in the administrator's Action column.
3. Enter an email address for the administrator account.
4. Change the password from the default to something secure. Enter and confirm a new password. Passwords are case sensitive and can contain A-Z, 0-9 and underscores ( \_ ).
5. Click **Save** to save changes to the administrator account.

## Setting Time

Correct time settings are important for fax verification and logging purposes. Use Time Configuration to select a time server, time zone, and date and time formats.

1. Click **System Configuration > Time**.
2. Enter time parameters. See [Time Fields](#).
3. Click **Save**.

### Time Fields

Field	Description
<b>Time Configuration</b>	
Time Server	Select time.nist.gov, clock.via.net, pool.ntp.org, Custom, or None from the drop-down list. <ul style="list-style-type: none"> <li>■ Select Custom to enter a custom time server in field below.</li> <li>■ If you select None, enter the current time and date and click <b>Save</b> in the Set Current Time section.</li> </ul>
Custom Time Server	If you do not want to use time.nist.gov, clock.via.net, or pool.ntp.org, set the Time Server to Custom and use this field to enter the address of another time server.
Synchronize Every	Enter a time interval for how often you want FaxFinder to synchronize with the time server. This is only valid if you select a time server.
Time Zone	Select the time zone for the FaxFinder's location. After a time zone change, you will be prompted to reboot the FaxFinder. Cancel if you do not want to reboot at this time. The time zone change will not be saved unless you click OK and reboot the FaxFinder.
Date Format	Select a date format from the drop-down list.
Time Format	Select a time format of either 12 or 24 hours.
<b>Set Current Time</b>	
Time (24hr) hh:mm:ss	If you set Time Server to None, enter the current time in an hour:minutes:seconds format.
Date MM/DD/YYYY	If you set Time Server to None, enter the current date in a month/day/year format.

## Configuring SMTP

Enter SMTP information for your mail server so that FaxFinder can work with your company's email.

**Note:** Incoming faxes that are to be routed by email to fax recipients will not be delivered unless this section and your email server are configured correctly.

1. Click **System Configuration > SMTP**.
2. Enter SMTP parameters as required by your email system. Refer to [SMTP Parameters](#) for field details.
3. Click **Save**.
4. Enter an email address to receive a test email. Then, click **Send Test Email**. Check to see it was delivered. If it was delivered successfully, your SMTP server is relaying emails generated by the FaxFinder to local email recipients. If it was not delivered, check your settings and refer to [Troubleshooting](#).

### SMTP Parameters

Fields	Description
SMTP Server Address	Enter the IP address or hostname of the SMTP server where FaxFinder will send emails. If you enter a hostname, configure FaxFinder with an appropriate DNS server address.
SMTP Port	Enter the SMTP port to be used. The default value for SMTP is 25.
FaxFinder Email Address	Enter an email address to define the FaxFinder's Sender Envelope address. If left blank, the Sender Envelope will be <i>ffmailer-noreply@theFaxFinder'shostname</i> . Depending on whether the FaxFinder email is administrative or fax delivery, the From address displayed with the email will be either the address defined here or a combination of it and the FaxID provided by the remote fax machine.
SMTP Username	If necessary for authentication, enter the username that FaxFinder will use for validation on the email server.
SMTP Password	If necessary for authentication, enter the password associated with the above username.
Confirm SMTP Password	Re-enter the password to verify the password.

## Sending a Test Fax from Fax Machine to FaxFinder

To send a test fax:

1. If you are using a PBX, confirm the modem settings. Click **Fax Configuration > Modem** to view or edit Modem Configuration settings.
2. Click **Inbound Routing** and confirm where the fax will be routed. If you do not change the default settings, the admin email address will receive any incoming faxes.
3. Use a conventional fax machine to send a fax to the FaxFinder's fax number.
4. Verify that the FaxFinder received the fax message and then check the administrator's email inbox to see if it was delivered. To verify that FaxFinder received the fax, click **Status & Logs** and then click:
  - **Fax Status** to see faxes currently in progress.

- **Inbound Fax Log** to see Faxes that have been delivered. Click the Details link to view a pop-up window showing Delivery and Modem Details.

If the email is not delivered within five minutes, refer to [Troubleshooting](#).

Verify the fax opens in a PDF viewer, such as Adobe Reader. If you configured FaxFinder to deliver faxes as TIFF files, use the Multi-Tech TIFF viewer or a graphic file viewer to view the fax. In your email program, double-click the file attached to the email to open it in either a PDF or TIFF viewer.

## Adding a Printer (Optional)

To route faxes directly to a printer, add a network printer to FaxFinder. Using a printer is not required.

1. Click **System Configuration > Printer**.
2. Click **Add** and enter your printer information. Refer to [Printer Fields](#) for details.
3. Click **Save**.
4. Click **Print Test Page**, , to verify that the printer was setup correctly.

### Printer Fields

Field	Description
Printer Make	Select your printer's manufacturer from the drop-down list. If the manufacturer is not listed, select Generic.
Printer Model	Select your printer model from the drop-down list. If your printer make is Generic, the options here will be generic.
Printer Name	Enter a name for this printer that users will understand. Printer names can contain upper- and lowercase letters, numbers, hyphens, and underscores. They cannot have spaces.
Description	Enter a description that will help users select the correct printer, for example, 2nd floor copy room.
Device URI	Enter this printer's Uniform Resource Identifier. The URI identifies a printer's location on the network. To find a valid syntax for your printer, click the Help link next to this field.

## Adding a Network Share (Optional)

To send faxes to a network folder, set up a network share. Anyone with network rights to the shared folder can view the faxes sent there. Creating a shared location can help ensure that faxes are responded to in a timely manner and provides a location for archiving faxes.

For information on using SFTP to access, transfer, and manage files securely, refer to [Using SFTP](#).

**Note:** When using a Microsoft Windows network, you may need to enable Simple File Sharing.

Network shares are not required.

1. Click **System Configuration > Shares**.
2. Enter the **Domain/Workgroup** where the FaxFinder will operate and click **Save**. The default value is Workgroup.



3. Click **Add** and enter your network folder information. Refer to [Network Share Fields](#) for details.
4. Click **Save**. Network Share updated appears at the top of the page.

## Network Share Fields

FaxFinder's factory default IP address is 192.168.2.1 and 24 bit network mask is 255.255.255.0.

Field	Description
UNC/Location	Enter the Universal Naming Convention identifier or network location of up to 50 characters, for example, //server/service or \\server\service.
Username	Enter a username that has write access to the shared location. This can be a general account or one specific to the shared folder.
Password	Enter the password associated with the above username.
Confirm Password	Re-enter the password in order to avoid possible errors.

## Using a Server Certificate

FaxFinder allows you to upload or generate a server certificate.

### Upload a Server Certificate

The server certificate file must be named server\_cert.pem. FaxFinder requires a certificate that is a combined private key and certificate file with the following sections:

```
-----BEGIN PRIVATE KEY-----
.
.
-----END PRIVATE KEY-----
-
-----BEGIN CERTIFICATE-----
.
.
-----END CERTIFICATE-----
```

If the certificate file includes an intermediate certificate, the intermediate certificate should be at the end of the file:

```
-----BEGIN PRIVATE KEY-----
.
.
-----END PRIVATE KEY-----
-
-----BEGIN CERTIFICATE-----
.
.
-----END CERTIFICATE-----
.
-----BEGIN INTERMEDIATE CERTIFICATE-----
.
.
```

-----END INTERMEDIATE CERTIFICATE-----

To upload a certificate:

1. Click **System Configuration > Certificates**.
2. Click **Upload**.
3. **Browse** to your certificate.
4. Enter certificate information. Refer to [Server Certificate Parameters](#) for details. The values you enter are for identification purposes only.
5. Click **Save**. You will be prompted to reboot FaxFinder.
6. Reboot FaxFinder.

## Generating a Server Certificate

Because FaxFinder uses a self-signed website certificate, your browser will show a certificate error and warning. Ignore the warning or, depending on your browser, add an exception or add your FaxFinder IP address to your trusted sites.

To generate a certificate:

1. Click **System Configuration > Certificates**.
2. Click **Create**.
3. Enter certificate information. Refer to [Server Certificate Fields](#) for details. The values you enter are for identification purposes only.
4. Click **Generate**. You will be prompted to reboot FaxFinder.
5. Reboot FaxFinder.

## Server Certificate Fields

Unless otherwise specified in the table below, you can enter up to 64 characters in these fields.

Field	Description
Common Name	Enter the hostname or IP address, depending on which you use to connect to FaxFinder. The web browser uses this field to check for a valid certificate.
Days	Enter up to three digits for number of days that the certificate is valid.
Country	Enter the two letter code for the country the certificate is valid for. US is the code for the United States. To find other country codes, search the web for "ISO country codes."
State/Province	Enter the state or province for which the certificate is valid.
Locality/City	Enter the city or locality for which the certificate is valid.
Organization	Enter the organization name for which the certificate is valid.
Email Address	Enter the email address of the person responsible for the FaxFinder. Typically this is the administrator. This field may be left blank.

## Adding Individual Users

Users are those who send faxes through FaxFinder. Multi-Tech recommends adding users into FaxFinder before installing the FaxFinder Client software on a user's workstation.

If you have several users to add, you can import a Comma Separated Value (CSV) file with user information. Refer to [Importing Users](#) for details.

**Note:** The Admin user cannot be deleted. To change the password or other Admin account information, click **Edit** for the Admin.

To add users individually:

1. Click **Users** to create user accounts.
2. Click **Add**.
3. Enter user information. Refer to [User Fields](#) below for details.
4. Click **Save** to save the entry.
5. Repeat Steps 2-4 for each user you want to add.

## User Fields

Field	Description
Username	Enter a user name. This is used to login to a FaxFinder.
Full Name	Enter the user's name. FaxFinder uses this name as the fax sender's name.
Password	Enter a password. Passwords are case sensitive and can contain A-Z, 0-9 and underscores ( _ ).
Confirm Password	Re-enter the password to confirm it.
Email	Enter the user's email address.
Include Cover Page	Check to include a cover page by default when this user sends a fax.
Default Cover Page	Select a cover page template from the drop-down list. For information on setting up default cover pages refer to <a href="#">Adding Cover Pages to FaxFinder</a> .
Phone Number	Enter a voice number for the user.
Fax Number	Enter a fax number for the user.
Organization	Enter the user's organization
<b>Default Send Fax Options</b>	
Max Attempts	Enter the default maximum number of times you want FaxFinder to try to send the fax to a recipient. Default is 3.
Fax Priority	Select a default Fax Priority for this user account. When multiple faxes are scheduled for the same time, FaxFinder sends those with a high priority before those with a low priority. Options, from highest to lowest priority, are: <ul style="list-style-type: none"> <li>■ 1st Priority</li> <li>■ High</li> <li>■ Medium/High</li> <li>■ Medium (Default.)</li> <li>■ Medium/Low</li> <li>■ Low</li> </ul>

Field	Description
Retry Interval	Enter the default Retry Interval for this user account. This is the time between retry attempts when the fax does not complete. The default retry time is 300 seconds.
Fax Page Size	Enter the fax page size to use when this user sends a fax. Options are: <ul style="list-style-type: none"> <li>■ Auto</li> <li>■ Letter</li> <li>■ Legal</li> <li>■ A4</li> </ul>
Email Fax Receipt	Select when you want a receipt sent to the email address in your user account. Options are: <ul style="list-style-type: none"> <li>■ Never</li> <li>■ Always, which sends a receipt with every fax attempt</li> <li>■ Failure, which sends a receipt only when a fax is not successful</li> <li>■ Never</li> </ul>
Fax Attachment with Receipt	If you want fax receipts to include an attachment of the original fax by default, select the attachment option. Options are: <ul style="list-style-type: none"> <li>■ None</li> <li>■ PDF</li> <li>■ TIFF</li> </ul>
Print Fax Receipt	Select when you want a receipt to be printed. Options are: <ul style="list-style-type: none"> <li>■ Never</li> <li>■ Always, which prints a receipt with every fax attempt</li> <li>■ Failure, which prints a receipt only when a fax is not successful</li> </ul>
Select Printer	Select a printer for printing fax receipts.
Print with First Page	If you want the fax receipt to include the first page of the original fax, click the check box.
<b>User Permissions</b>	
View All Inbound Fax Logs	Check this to allow this user to view inbound fax logs.
View All Outbound Fax Logs	Check this to allow this user to view outbound fax logs.
<b>Create Inbound Routing Recipient</b>	
Add Route	Check this to add the user as a Recipient on the Inbound Routing page for the fax extension entered below. The fax destination will be this user's email address. You could use this to route incoming sales faxes to this specific user.
Fax Extension	Enter the fax extension number that you want to route to this user.

## Adding Global Contacts Individually

Multi-Tech recommends adding global contacts into FaxFinder before installing the FaxFinder Client software on a user's workstation. The FaxFinder Client software automatically downloads fax contacts from the FaxFinder server.

Users can have their own personal contacts in addition to the Global Contact Database. The FaxFinder Client keeps a copy of the contact information locally and checks for changes when the software is used.

If you have several contacts to add, you can import a Comma Separated Value (CSV) file with contact information. Refer to [Importing Global or Personal Contacts](#) for details. Users can also add personal contacts. Refer to the FaxFinder Fax Server User Guide for details.

To add contacts individually:



1. Click **Contacts > Global** to create fax contact entries available to all users.
2. Click **Add**.
3. Enter the contact's name, fax number, phone number, and organization.
4. Click **Save** to save the entry.
5. Repeat Steps 2-4 for each global contact.

## Routing Inbound Faxes

Select how you want inbound faxes routed:

- **Global Routing** sends a copy of every incoming fax to the defined fax destination as well as to destinations in the Lines or Recipients table.
- **Line Routing** routes faxes for POTS lines/modems. Also defines a default fax destination when the incoming fax does not include a valid recipient's extension.
- **Recipient Routing** is based on the extension number. It requires that the Fax Configuration routing parameter be set to DTMF Digits or a PBX Mode Code. This routing type requires the PBX/phone line to provide DID extension information in the form of DTMF digits. FaxFinder matches the DID extension from the PBX with the Recipients table to determine delivery options

You can define multiple fax destinations. Faxes can be delivered via email, sent to a printer, or written to a network or SFTP share. You can also send incoming faxes directly to Trash. To configure inbound routing:

1. Click **Fax Configuration > Inbound Routing**.
2. Click **Global Routing** to add global fax destinations.
  - a. Click **Edit**, .
  - b. Click **Add**.
  - c. Select **Destination Type** from the drop down list and enter information required for that destination type. Refer to [Inbound Routing Destinations](#) for details.
  - d. Click **Save**.
  - e. Repeat Steps b-d for each global destination. Click **Done** to return to the Inbound Routing page.
3. Click **Lines** to set the destination for POTS lines or incoming faxes that don't provide a valid extension. You can enter multiple destinations for each line. By default, this is set to Email Fax to User: admin.
  - a. Click **Edit**, , for the line you want to configure.
  - b. Enter a Name, for example Sales Faxes, and click **Save**.
  - c. Click **Add** in the Destinations section.
  - d. Select **Destination Type** from the drop down list and enter information required for that destination type. If you select Trash, you cannot define other destinations for this line. Refer to [Inbound Routing Destinations](#) for destination details.

- e. Click **Save**.
  - f. Repeat Steps c-e for each destination. Click **Done** to return to the Inbound Routing page.
4. Add **Recipients** for inbound routing. If you have several recipients to add, refer to [Importing Recipients](#) for details on importing recipient information.
- a. Click **Add**.
  - b. Enter the recipient's DID number in the **Extension** field. This number is dictated by your PBX and/or Telco line.
  - c. Enter the recipient's **Name**.
  - d. Click **Save**.
  - e. Click **Add** to add a destination.
  - f. Select **Destination Type** from the drop down list and enter information required for that destination type. If you select Trash, you cannot define other destinations for this recipient. Refer to [Inbound Routing Destinations](#) for destination details.
  - g. Click **Save**.
  - h. To add additional destinations for this recipient, repeat Steps e-g. Click **Done** to return to Inbound Routing.
  - i. To add recipients, repeat Steps a-h.
5. Click **Save** to save the entry.

## Configuring Inbound Options

Use this page to configure inbound options and set filename format and email fields for all inbound faxes.

1. Go to **Fax Configuration > Inbound**.
2. Select the inbound fax options and click **Save**. Refer to [Inbound Options Fields](#) for field descriptions.
3. To set a filename for incoming faxes, enter the filename in the **Share/SFTP Filename Format** field. Refer to Inbound Options Examples.
4. Enter an **Email Attachment Format**. Refer to Inbound Options Examples.
5. Click **Save**.

### Inbound Options

Field	Description
<b>Inbound Options</b>	
Email Fax Details	Check to include fax details in the email body.
Email Empty Faxes	Check to email to users faxes that fail and contain no pages.
Enable Archive	Check to save copies of incoming faxes copy to an archive directory.
Archive Directory	Click Browse and select a directory for archived faxes. The directory must be set up as a Network Share. See <a href="#">Adding a Network Share (Optional)</a> .

Field	Description
Email Size Limit	Enter the maximum email size in kilobytes that your SMTP server can accept from FaxFinder. FaxFinder automatically splits larger incoming faxes into multiple faxes that are below this limit and emails each separately. The email subject line will show, "Fax Received (x of n) From" where n is the total number of emails for the complete fax and x is which section is attached to the email.
Fax Output Format	Select PDF , TIFF G3, or TIFF G4 as the delivery format for inbound faxes.
Fax Page Size	Select the desired fax page size for receiving a fax. Auto keeps the size of the original fax. The other settings resize the fax to a fixed size. <ul style="list-style-type: none"> <li>■ Auto</li> <li>■ Letter</li> <li>■ Legal</li> <li>■ A4</li> </ul>
<b>Filename Configuration</b>	
Share/SFTP Filename Format	Enter the filename format for inbound faxes. Acceptable characters are: A-Z, a-z, 0-9, _(),.,~!@#\$%^&=+{}[]' -. To add % character to the filename type %%. The file extension (PDF or TIFF) is added automatically. Filename mask must include Date (%D) and Time (%T), and/or Counter (%X) variable. For more information, refer to Variables and Examples.
Email Attachment Format	Enter the format for the fax email attachment. For more information, refer to Variables and Examples.
<b>Email Configuration</b>	
From	Enter what you want in the <b>From</b> field for inbound faxes. You can use a combination of variables and text.
Subject	Enter what you want in the <b>Subject</b> field for fax emails. You can use a combination of variables and text.

## Variables

This table shows which variables are for configuring the inbound fax filename and email. Variables are case-sensitive.

Variable	Represents	Filename	Email
%C	Caller ID name	X	X
%D	Date	X	X
%E	Fax extension	X	X
%I	Remote ID	X	X
%L	Line number	X	X
%N	Caller ID number	X	X
%P	Number of pages	X	X

Variable	Represents	Filename	Email
%R	Recipient number	X	X
%T	Time	X	X
%X	Counter	X	--

## Examples

To configure filename to display Recipient Name, Date and Time "*Michael\_20140525\_193045.pdf*" enter the following mask:

- - %R\_%D\_%T

To configure From to display Caller ID Name and Caller ID Number, *Caller: Terry Smith (2501)* enter the following mask:

- Caller: %C (%N)

To configure Subject of *Fax received on 5/25/2014 at 19:30:45, total pages - 5*, enter the following mask:

- Fax received on %D at %T, total pages - %P

## Inbound Routing Destinations

Destination	Required Additional Information	Destination Type
Email Fax to User	Select a user.	Global, Line, Recipient
Email Notification to User	Select a user.	Global, Line, Recipient
Email Fax	Enter an email address.	Global, Line, Recipient
Email Notification	Enter an email address.	Global, Line, Recipient
Share	Click Browse and select a network folder. Add network folders through the Shares page. See <a href="#">Adding a Network Share (Optional)</a> .	Global, Line, Recipient
Sftp	Select the SFTP server.	Global, Line, Recipient
Print	Select a printer.	Global, Line, Recipient
Trash	None. <b>Note:</b> If you select Trash, you cannot define other destinations.	Line, Recipient

## Configuring Modems

FaxFinder modems can be configured individually, which allows you to dedicate fax resources to match your needs. You can set individual modems to receive faxes only, send faxes only, or both.

**Note:** To ensure that your faxes comply with federal regulations, refer to the [Fax Branding Statement](#) in Regulatory Information

1. Click **Fax Configuration**.



2. Select the check boxes for the modem or modems you want to configure. Click the check box in the header bar to select all modems. Selecting multiple modems applies the same configuration except Fax ID to all selected modems.

**Note:** FaxFinder lists modems sequentially under # and by unit under Port. For Port, the first number indicates if the modem is in the fax server or expansion module. The second number indicates which modem in the server or expansion module. If you only have a fax server, the first number is always 1.

3. Select modem settings. Refer to [Modem Fields](#).
4. Click **Save** to save the entry.

**Note:** If you change any modem parameters, that modem initializes immediately after you click Save. If the modem is currently in use, initialization begins when the current call is completed.

## Modem Fields

Use the following fields to configure the modem:

Field	Description
Modem	The internal modem number, which is based on the FaxFinder model (1-2 for the FF240, 1-4 for the FF440 and 1-8 for the FF840) or Expansion Module (8 or 16 additional modems).
Country Code	Use this to set the modem's Country Profile Code. For correct operation, use the country code for country where you are using the FaxFinder.
Answer On	If you set Routing to POTS Line, enter how many times the line should ring before the modem answers it. If this is 2, the modem will pick up the line after it detects two ring sequences. If you set Routing to DTMF Digits or a PBX mode code, the modem ignores this value. PBX mode code and DTMF Digits routing always pick up after one ring sequence.

Field	Description						
Routing	<p>For inbound fax calls from the PSTN, this setting determines whether the modem checks the line for DID routing information in the form of DTMF digits. This setting directly effects how other Inbound Routing fields should be configured.</p> <p><b>Note:</b> For DTMF Digits or PBX Mode Code routing, the modem listens up to 15 seconds for all expected DID routing information. If it detects only a portion or none of the expected digits after 15 seconds the modem will declare a timeout and proceed to make fax answer tones. After a fax is received, it will be delivered as if POTS Line is the selected routing technique.</p> <p>Select from the following options:</p> <table border="1" data-bbox="391 569 1534 1201"> <tr> <td data-bbox="391 569 591 722">POTS Line</td> <td data-bbox="591 569 1534 722">With this option, the modem does not look for DID routing information from the line/PBX. When the modem receives a fax, FaxFinder delivers it based on options defined for this line number in the Lines section of the Inbound Routing page.</td> </tr> <tr> <td data-bbox="391 722 591 947">DTMF Digits</td> <td data-bbox="591 722 1534 947">With this option, the modem listens for DID routing information from the PBX line. DID information must be a string of DTMF digits. FaxFinder makes fax answer tones after it hears the expected number of DID digits (Max Extension Digits). After the modem receives a fax, FaxFinder tries to match the DID number it heard with entries in the Recipients table to determine delivery options.</td> </tr> <tr> <td data-bbox="391 947 591 1201">___ Mode Code</td> <td data-bbox="591 947 1534 1201">___ represents the specific PBX equipment that you have. PBX Mode Code is similar to DTMF Digits, except the DTMF digits from the PBX also contain information that FaxFinder doesn't use. FaxFinder needs to know the incoming mode code format to identify and extract the DID extension number imbedded within. FaxFinder includes PBX Mode Codes for some device manufacturers. If the codes for your device are not included, select User Defined and add the code to the Routing Definition field.</td> </tr> </table>	POTS Line	With this option, the modem does not look for DID routing information from the line/PBX. When the modem receives a fax, FaxFinder delivers it based on options defined for this line number in the Lines section of the Inbound Routing page.	DTMF Digits	With this option, the modem listens for DID routing information from the PBX line. DID information must be a string of DTMF digits. FaxFinder makes fax answer tones after it hears the expected number of DID digits (Max Extension Digits). After the modem receives a fax, FaxFinder tries to match the DID number it heard with entries in the Recipients table to determine delivery options.	___ Mode Code	___ represents the specific PBX equipment that you have. PBX Mode Code is similar to DTMF Digits, except the DTMF digits from the PBX also contain information that FaxFinder doesn't use. FaxFinder needs to know the incoming mode code format to identify and extract the DID extension number imbedded within. FaxFinder includes PBX Mode Codes for some device manufacturers. If the codes for your device are not included, select User Defined and add the code to the Routing Definition field.
POTS Line	With this option, the modem does not look for DID routing information from the line/PBX. When the modem receives a fax, FaxFinder delivers it based on options defined for this line number in the Lines section of the Inbound Routing page.						
DTMF Digits	With this option, the modem listens for DID routing information from the PBX line. DID information must be a string of DTMF digits. FaxFinder makes fax answer tones after it hears the expected number of DID digits (Max Extension Digits). After the modem receives a fax, FaxFinder tries to match the DID number it heard with entries in the Recipients table to determine delivery options.						
___ Mode Code	___ represents the specific PBX equipment that you have. PBX Mode Code is similar to DTMF Digits, except the DTMF digits from the PBX also contain information that FaxFinder doesn't use. FaxFinder needs to know the incoming mode code format to identify and extract the DID extension number imbedded within. FaxFinder includes PBX Mode Codes for some device manufacturers. If the codes for your device are not included, select User Defined and add the code to the Routing Definition field.						

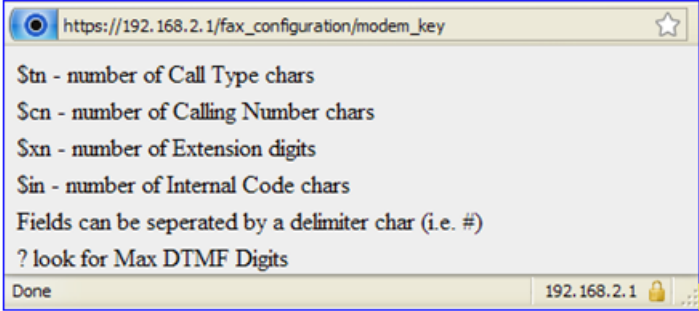
Field	Description
Routing Definition	<p>If you selected a vendor pre-defined routing code, it displays in this field. If you selected User Defined for Routing, enter your own formula/definition in this field. Routing Definition identifies code elements sent by the PBX so that FaxFinder can mask information it doesn't need and identify the extension number it does need.</p>
Key	 <ul style="list-style-type: none"> <li>■ n is the variable number for each definition</li> <li>■ For Call Type, Calling Number, and Internal Code, replace n with the number of digits that you want masked or ignored.</li> <li>■ For Extension digits, replace n with the number of extension digits used to route inbound faxes to recipients. If you are using a predefined mode code that uses \$x? as the Extension Digits variable, use the Max DTMF Digits field to define the number of DID extension digits.</li> </ul>
Description	Explains the current mode code, if any, in the Routing Definition field.
Max Baud Rate	Select the maximum connection (baud) rate that allowed on the modem. Default is 14400.
Dialing Rules	To apply dialing rules, select the rules from the drop down list. Refer to Configuring Dialing Rules for information on setting up dialing rules.
Init String	Use this field to define additional AT modem commends needed for your faxing environment. AT commands entered here will be issued to this modem before every call on this port, inbound or outbound.
Fax ID	This value appears in the fax page header. Typically, it is the fax number or the company name, so that recipients can identify each page with the sender's name or number. For Fax ID regulations, consult the FCC website.
Max Extension Digits	Used when Routing is set to DTMF Digits or a PBX mode code. Enter a value that matches the number of digits to be passed by the line/PBX to the FaxFinder modem port. The supported range length of a DTMF string is from 1 to 15 digits.
Fax Direction	Specify if this modem is for inbound faxes only, outbound faxes only, or both. This setting should match the setting of the analog line/equipment connected to this port. If the modem is set to outbound, but the PBX/Telco line connected to it is set to inbound, FaxFinder will not answer inbound calls.
Error Correction	Select On to use T.30 error correction with this modem or Off to disable it. Default is On.
Smart Dial	Select On to enable Smart Dial or Off to disable it. When Smart Dial is enabled, the modem waits to detect a dial tone before dialing.
Tone Dial	Select On for tone dialing or Off for pulse dialing. Default is On.

Field	Description
Fax Debugging	<p>If a communication error occurs when FaxFinder attempts to send or receive a fax, FaxFinder creates a modem log file. This is available through the FaxFinder Web Management Log menu. When you enable Fax Debugging, the log file provides more details about the fax call. Select On if you want to log fax debugging information or Off if you do not.</p> <p><b>Note:</b> Multi-Tech recommends that you turn this on as needed to collect data for troubleshooting and turn it off when you have the more detailed log file.</p>

## Creating a Restore File

After you configure FaxFinder to work in your environment, create a restore point to save your settings. A restore file allows you to restore your configuration settings if the FaxFinder is reset to factory defaults or if you make a change you want to undo. To create a restore point:

1. Click **System Configuration > Save/Restore**.
2. Click **Save Config**. A file download window opens.

**Note:** Some browsers automatically save the file to a default location when you click Save Config. To save to another location so you can find it, right-click **Save Config** and click **Save as**.

3. Click **Save** or **OK** depending on your browser.

The configuration restore file name is formatted as config\_model\_version\_date.bin. For details on restoring a configuration file, refer to [Restoring Configuration](#).

## Chapter 4 – Fax Management

### Logging into the Web Management Interface

To login to the Web Management Interface:

1. Enter the FaxFinder IP address or hostname in your browser and press **Enter**. If you see the certificate warning, bypass the warning to display the Login page.
2. Type your **Username** and **Password** and click **Login**.

The default username is **admin** and the default password is **admin**.

### Requesting a Password

To request a forgotten password:

1. Click **Forgot Password**.
2. Enter your username and click **Send**. FaxFinder emails instructions for resetting the password to the email address for the user account.

### Navigating the Web Management Interface

To navigate the Web Management Interface:

- Click a category on the left to open a submenu. The highlight indicates the current selection.

To open a hidden section of a page:

- Click .

To hide a section of a page:

- Click .

Some functions are available through buttons or icons on the page.

### Checking System, Printer, and Share Status

System status provides information you can use to confirm correct settings or help with diagnostics.

To check status, click **Status & Logs**.

Field	Description
<b>Current Status</b>	
Current Time	The FaxFinder's current time and date. To change the date and time format go to <b>System Configuration &gt; Time</b> . Refer to <a href="#">Setting Time</a> for details.
Up Time	The total time the FaxFinder has been operating since the last reboot/reset.

Field	Description										
Time Server Status	This is the status of the time server currently in use. It also shows error messages.										
	<table border="1"> <thead> <tr> <th>Status</th> <th>Description</th> </tr> </thead> <tbody> <tr> <td>Disabled</td> <td>Time server likely set to None.</td> </tr> <tr> <td>Synchronizing</td> <td>FaxFinder is currently synchronizing with the time server.</td> </tr> <tr> <td>Synchronized at [date/time], offset ±nn seconds</td> <td>FaxFinder last synchronized with the time server at the specified date and time. The offset, if any, indicates how much FaxFinder adjusted its time.</td> </tr> <tr> <td>Failed to synchronize: [error]</td> <td>Time synchronization failed due to the error shown.</td> </tr> </tbody> </table>	Status	Description	Disabled	Time server likely set to None.	Synchronizing	FaxFinder is currently synchronizing with the time server.	Synchronized at [date/time], offset ±nn seconds	FaxFinder last synchronized with the time server at the specified date and time. The offset, if any, indicates how much FaxFinder adjusted its time.	Failed to synchronize: [error]	Time synchronization failed due to the error shown.
Status	Description										
Disabled	Time server likely set to None.										
Synchronizing	FaxFinder is currently synchronizing with the time server.										
Synchronized at [date/time], offset ±nn seconds	FaxFinder last synchronized with the time server at the specified date and time. The offset, if any, indicates how much FaxFinder adjusted its time.										
Failed to synchronize: [error]	Time synchronization failed due to the error shown.										
<b>Printer Status</b>											
Printer Status	Current status of each printer set up in System Configuration > Printers.										
<b>Network Share Status</b>											
Network Share Status	Current status of any network shares set up in System Configuration > Shares.										

## Checking Modem/Channel and Fax Status

Use the Fax Status page to view the current state for each modem or channel. It includes the status of any inbound or outbound faxes. Users can immediately send or abort outbound faxes. Administrators can also reset busy modems and block inbound or outbound faxes from a modem or channels.

To view a status, click **Status & Logs > Fax Status**.

Field	Description
<b>Modem Status</b>	
#	A sequential number associated with each internal modem based on the FaxFinder model: 1-2 for the FF240, 1-4, for the FF440, and 1-8 for the FF840. If using an Expansion Module 8 or 16 additional modems are listed.
Port	Shows the modem number by unit. The first number indicates if the modem is in the fax server or expansion module. The second number indicates which modem in the server or expansion module. If you only have a fax server, the first number is always 1.
State	Current modem state: Idle, Waiting for Ring, Initializing, Waiting for Connect, Processing, Dialing, Negotiating, Connected, Sending, Receiving, or Busied Out.
Page	Page that a modem is currently transmitting, if any.
Connect Time	When the current connection was made.
Fax	When sending, this the dialed fax number. When receiving, this is the DID number detected.
Resolution	Appears when you point to an active modem. Resolution used to transmit the page. Vertical scan line types include fine and standard.
Baud Rate	Appears when you point to an active modem. Modem's current baud rate.

Field	Description
Width	Appears when you point to an active modem. Current width setting for faxes sent through the listed modem.
Length	Appears when you point to an active modem. Current length setting for faxes sent through the listed modem.
Elapsed	Appears when you point to an active modem. How much time has passed since the current connection was made.
Remote ID	Appears when you point to an active modem. Identification received from the remote connection.
<b>Inbound Fax Status</b>	
State	If a fax is still transmitting, this will show receiving or delivering.
Start Time	The time that the inbound fax was initiated.
Fax	The DID routing number provided by the PBX, when applicable.
Recipient	Either the recipient Username associated with the DID extension number or the Line Name.
Remote ID	Fax ID information sent from the fax originator.
Caller ID Name	Name provided with sender's fax number.
Caller ID Number	Sender's fax number.
<b>Outbound Fax Status</b>	
Check box	Use the check box to select one or more outbound faxes to be sent immediately or aborted. After selecting faxes, click <b>Send Now</b> or <b>Abort</b> .
State	The state of a fax that either has not been sent or is still in progress. Outbound fax state may be new, approval pending, preprocessing, pending, or sending.
Created At	When the outbound fax was initially queued.
Scheduled For	The following factors determine the time shown here: pre-processing work load (documents submitted for faxing are converted one at a time), the setting for Allow Simultaneous Dialing to the Same Number, and user specified scheduling time. If a previous attempt did not complete, this time shows when the next attempt will occur.
Sender	FaxFinder pulls the Username from the account used to log into the server and from the User Information.
Fax Details	Number of outbound fax pages.
<input checked="" type="checkbox"/>	Send fax now.
<input type="checkbox"/>	Abort fax.
Recipient	Person the fax is addressed to. Point to Outbound Fax Status to view information about individual recipients.
Attempt	Indicates how many times FaxFinder has attempted to send the fax and the maximum number of attempts for this fax. For example, if this shows 2/3, FaxFinder has attempted to send the fax two times and, if the second attempt fails, will attempt one more time.
Fax	Recipient's fax number.

Field	Description
State	Indicates if the fax is pending or in progress.
Organization	Recipient's business or organization.
<b>General</b>	
Auto Refresh	Check this field to automatically refresh status information. Default setting is enabled.

## Sending Now

To send outbound faxes immediately:

1. Click **Status & Logs > Fax Status**.
2. Find the fax that you want to send in the Outbound Fax Status table.
3. Click **Send Now**, , for that fax.
  - To send multiple faxes, click the check boxes for each fax and click **Send Now**.
  - To send all outbound faxes, click the check box in the header row and click **Send Now**.

## Canceling Outbound Faxes

To cancel outbound faxes:

1. Click **Status & Logs > Fax Status**.
2. Find the fax that you want to cancel in the Outbound Fax Status table.
3. Click **Abort**, , for that fax.
  - To cancel multiple faxes, click the check boxes for each fax and click Abort.
  - To cancel all outbound faxes, click the check box in the header row and click Abort.

## Resetting a Busy Modem

Administrators can reset a busy modem. To do this:

1. Click **Status & Logs > Fax Status**.
2. Click **Initialize**, , for the modem you want to reset.

FaxFinder sends an initialization command to the modem. When initialization completes, "Modem x initialized" appears in color at the top of the page. If you click this while a fax is in progress, it will interrupt the fax and cause it to fail.

## Blocking a Modem's Inbound and Outbound Faxes

Administrators can temporarily set a modem to busy so that it cannot send or receive faxes. To do this:

1. Click **Status & Logs > Fax Status**.
2. Click **Busy**, , for the modem you want to block.

Any incoming calls to this modem will receive the busy tone. To allow the modem to send faxes, click **Initialize**, , for the modem.



## Checking the Mail Queue

To view information about emails waiting to be sent, click **Status & Logs > Mail Queue**.

Field	Description
Date	Date the email was created.
Size	Email message size in bytes.
Sender	User who sent the email.
Recipient	Email address of the recipient.
Type	Delivery type of the file to be sent, for example, local or remote.
Delivery Message	The result of the delivery attempt.

## Resending Queued Mails

To resend queued mail:



1. Click **Status & Logs > Mail Queue**.
2. Click **Resend Queued Mails** to resend all mail items in the queue immediately.

## Viewing Logs

FaxFinder creates separate logs for email, inbound faxes, outbound faxes, and calls. To view a log:

1. Click **Status & Logs**.
2. Click log you want. Options are:
  - **Mail Log** - Shows recent delivery attempts with the most recent appearing at the top.
  - **Inbound Fax Log** - Lists all inbound faxes detected by FaxFinder. Inbound faxes in progress do not appear in the log until the call ends. Faxes are listed in chronological order with the most recent at the top.
  - **Outbound Fax Log** - Lists all submitted faxes that have completed. Outbound faxes in progress or scheduled to be sent later do not appear in this list until they have been transmitted successfully or the fax failed the specified number of attempts. Faxes are listed in chronological order with the most recent at the top.
  - **Call Log Details** - Data from all individual calls in and out of FaxFinder. Calls are listed in chronological order with the most recent at the top. This information can help troubleshoot the connection or related issues.

## Log Fields

Field	Description
<b>Mail Log</b>	
Date	Date and time this mail entry was attempted.
Sender	User who sent the email.
Recipient	Email address of the recipient.
Delivery Message	Mail delivery attempt result. If the message was not sent successfully, error messages appear here. For example, deferral: Sorry, I wasn't able to establish an SMTP connection.
<b>Inbound Fax Log</b>	
State	Final state of the incoming fax listed. States include: Complete, Error – no page received, Error – partial fax, and delivery failure.
Completed	Date and time at which the incoming fax was successfully received. The format displayed depends on settings chosen in System Configuration > Time.
Remote ID	Fax ID sent from the fax originator.
Extension	The DID routing number provided by the PBX, when applicable.
Recipient	Fax recipient identification.
Pages	The number of pages received with this fax.
Caller ID Name	Name provided with sender's fax number.
Caller ID Number	Sender's fax number.
Details	Click  to display Inbound Fax Log Details in a new window.
<b>Outbound Fax Log</b>	
Check box	To resend faxes, select the check box for each fax you want to resend or select the check box in the header row and click <b>Resend</b> .
Status	Final state of the outgoing fax listed. States include: Sent, Aborted, and Failed.
Start Time	Date and time the transmission started.
End Time	Date and time the transmission completed.
Sender	Username of the person sending the fax.
Recipient	Name entered as the intended fax recipient.
Fax	Appears when you point to a Recipient. The number where the fax was sent.
Phone	If available, appears when you point to a Recipient. The recipient's phone number.
Organization	If available, appears when you point to a Recipient. Name entered as the fax recipient's organization.
Pages	The number of pages sent with this fax.
Details	Click  to display Outbound Fax Log Details in a new window.
<b>Call Log</b>	

Field	Description
#	A sequential number associated with each internal modem based on the FaxFinder model: 1-2 for the FF240, 1-4, for the FF440, and 1-8 for the FF840. If using an Expansion Module, 8 or 16 additional modems are listed.
Port	Shows the modem number by unit. The first number indicates the server or expansion module. The second number indicates which modem in that unit. If you only have one fax server, the first number is always 1.
Status	Modem or channel status for this log entry, pass or fail. If the fax failed, point to the log entry to display the failure's cause.
Direction	Indicates if the fax was inbound or outbound.
Fax Number	Destination fax number.
Dialed Fax Number	Number dialed after dialing rules, if any, have been applied.
Time	Date and time the log entry was created.
Size	Size of the entire fax transmission.
Pages	Number of pages faxed for this log entry.
Details	Click  to display Call Log Details in a new window.

## Rebooting FaxFinder

Reboot stops any faxes in process. FaxFinder cannot send or receive faxes during the reboot process.

To immediately reboot FaxFinder:

1. Click **System Configuration > Reboot**.
2. Click **Reboot** to log off the current user and restart the FaxFinder.

## Restoring Factory Defaults

To restore the factory default settings:

1. Click **System Configuration > Save/Restore**.
2. Click **Restore Factory Defaults** to reset all FaxFinder settings. FaxFinder asks you confirm the restore and reboot FaxFinder. Click **OK** to confirm or click Cancel.

## Restoring Configuration

If you created a restore file, use Restore Config to reset FaxFinder using the .BIN file. This overwrites current settings with the settings in place at the time the restore file was created. You will lose any configuration changes, including user information, entered after the restore file was created.

To create restore points, refer to [Creating a Restore File](#).

1. Click **System Configuration > Save/Restore**.
2. Click **Browse** and select a configuration .BIN file.
3. Click **Restore**. FaxFinder prompts you to reboot.

# Chapter 5 – Managing Users, Contacts, and Recipients

Basic Configuration provides steps for adding [users](#), [recipients](#), and [global contacts](#) individually. This section details importing and managing multiple users, recipients, and both global and personal contacts. It includes using global and personal contact groups.

**Note:** If using Active Directory for user information, refer to the Active Directory section for help adding users.

## Users

### Importing Users

#### User CSV Import Format Notes

On the Users page, you can use a CSV file to import just users, just contacts, or a combined file with both user and contact records. The first comma-delimited value of each row indicates if the line is a user record or contact record, so both user and contact types can be in the same CSV file.

- Your file must conform to the order and format for each record type.
- If any of your data has apostrophes, commas, or quote marks, enclose the data in double quotes.
- Header rows are optional. A header row is any row that starts with **Type**. If you export data from a FaxFinder, the CSV file will include header information in the first row.

**Note:** Only Administrators can import through the User page.

**Warning:** If you import a record that matches the name of existing record, FaxFinder overwrites the existing information.

#### User Record Fields

FaxFinder accepts a user record formatted as:

Field	Notes
Type	Must be <b>User</b> .
Username	User's username, an alpha numeric string without spaces.
Password	User's password, an alpha numeric string without spaces.
Full Name	User's full name, can include spaces. Used in the cover page Sender field.
Email	User's email address.
Phone Number	User's phone number, any format accepted, for example, (###) ###-#### or ###-###-####.
Fax Number	User's fax number, any format accepted, for example, (###) ###-#### or ###-###-####.
Organization	User's company name, if not available, use "" to skip.
Include Cover Page	Indicates whether this user wants a default cover page for sending faxes, t for true or f for false.
Default Cover Page	PDF file name of the default cover page
Max Attempts	Maximum number of times FaxFinder attempts to send a fax before treating that fax as failed.

Field	Notes
Fax Priority	Options are 1st, High, Medium/High, Medium, Medium/Low, and Low. Medium is the default.
Retry Interval	The default Retry Interval for this user account. The default is 300 seconds.
Email Fax Receipt	Options are Always, Failure, and Never
Fax Attachment with Receipt	Options are None, PDF, and TIFF.
PasswordHash	Encrypted password.
View Fax Log Inbound	Options are True or False.
View Fax Log Outbound	Options are True or False.
Print Fax Receipt	Options are Always, Failure, and Never
Printer	Options are none and the name of all configured printers.
Print with First Page	Options are True or False.

### User Only Records Example

The following example shows an optional header row. This example is split for legibility. Data in your CSV file must be in the same order listed in the User Record Fields.

Type	Username	Password	Full Name	Email	Phone	Fax	Organization	Include Cover Page	Default Cover Page
User	Sean	A1b2C3	Sean K	sean@example.com	555-555-1234	555-555-4321	Example Co	TRUE	ob_mc1.pdf
User	Ritchie	D4e576	Ritchie W	ritchie@example.com	555-555-1253	555-555-3521	Example Co	FALSE	
User	Josh	fG32tR	Josh D	josh@example.com	555-555-1235	555-555-1532	Example Co	TRUE	ob_mc1.pdf

Second section of User Record Fields. These columns go to the right of Default Cover Page.

Max Attempt	Fax Priority	Retry Interval	Email Fax Receipt	Fax Attachment with Receipt	PasswordHash
1	3	300	failure	pdf	a302acdeb968847e
1	3	300	failure	pdf	b698b4d7286202f4
3	3	300	failure	pdf	3ae434bfbeefe4596c

Third section of User Record Fields. These columns go to the right of PasswordHash.

View Fax Log Inbound	View Fax Log Outbound	Print Fax Receipt	Printer	Print First Page
FALSE	FALSE	always	pctest	TRUE
FALSE	FALSE	never		TRUE

FALSE	FALSE	never		TRUE
-------	-------	-------	--	------

### Contact Record Fields (User page)

The Type field only applies to contacts imported through the User page. Do not use this format when importing contact records through the Contact page. Refer to Contact Record Fields.

Field	Notes
Type	Must be "Contact".
Username	The username for user who the contact belongs to; an alpha numeric string without spaces
Name	Contact's name, can include spaces.
Fax Number	Contact's fax number, any format accepted, for example, (###) ###-#### or ###-###-####.
Organization	Contact's company name, if not available, use "" to skip.
Phone Number	Contact's phone number, any format accepted, for example, (###) ###-#### or ###-###-####.

### Contact Only Records (Entered through User page) Example

This example applies only to contacts imported through the User page. To import contact records through the Contact page, refer to Creating a Contact CSV File.

Type	Username	Contact Name	Fax Number	Organization	Phone Number
Contact	Josh	Tony Rogers	555-123-4567	"A company"	555-123-4560
Contact	Ritchie	Steve Stark	555-547-3652	Company 2	555-547-3601
Contact	Ritchie	Anna Fury	555-540-3960	Company	555-540-3900
Contact	Sean	Nick Raven	555-573-2457	"Company 3"	555-573-2400

### Combined User and Contact Records Example

The following example shows an optional header row. Data in your CSV file must be in the same order. Due to the number fields in the user record, this section has been split into two tables.

Type	Username	Password	Full Name	Email	Phone	Fax	Organization	Include Cover Page	Default Cover Page
User	Sean	A1b2C3	Sean K	sean@example.com	555-555-1234	555-555-4321	Example Co	T	ob_mc1.pdf
User	Ritchie	D4e576	Ritchie W	ritchie@example.com	555-555-1253	555-555-3521	Example Co	F	
User	Josh	fG32tR	Josh D	josh@example.com	555-555-1235	555-555-1532	Example Co	T	ob_mc1.pdf
Type	Username	Name	Fax	Organization	Phone				

Contact	Josh	Tony Rogers	555-123-4567	"A company"	555-123-456				
Contact	Ritchie	Anna Fury	555-540-3960	Company	555-540-3900				
Contact	Ritchie	Anna Fury	555-540-3960	Company	555-540-3900				
Contact	Sean	Nick Raven	555-573-2457	"Company 3"	555-573-2400				

Second section of User Record columns. These columns go to the right of the Default Cover Page column.

Max Attempts	Fax Priority	Retry Interval	Email Fax Receipt	Fax Attachment with Receipt	PasswordHash
1	3	300	failure	pdf	a302acdeb968847e
1	3	300	failure	pdf	b698b4d7286202f4
3	3	300	failure	pdf	3ae434bfbeefe4596c

Third section of User Record columns. These columns go to the right of the PasswordHash column.

View Fax Log Inbound	View Fax Log Outbound	Print Fax Receipt	Printer	Print First Page
FALSE	FALSE	always	ptest	TRUE
FALSE	FALSE	never		TRUE
FALSE	FALSE	never		TRUE

## Creating a CSV File

To create a CSV file:

1. Open a spreadsheet program such as Microsoft Excel.
2. Create a table as shown in the example for the type of data you are importing. Your fields should be identical to and in the same order as shown in the example.
3. Create a row for each user, contact, or recipient you want to add.
4. Save the file as a .CSV Comma Separated Value file. If using Microsoft Excel, select **Save As** and select the CSV (MS-DOS) format.

## Importing a User CSV File

To import a user only, contact only or user and contact CSV file:

1. Click **Users**.
2. Click **Import**.
3. Click **Browse** and select the file you want to import.

4. Select an option for Existing Users. Merge is the default.
  - **merge** appends the file to the existing list.
  - **replace** exchanges the existing list with the list you import.
5. Click **Import**.

## Exporting a User List

If you are moving from one FaxFinder to another, you can export the user list in the correct format from the old unit and import it into the new one. Otherwise, you need a properly formatted CSV file.

**Note:** Only the Administrator can export through the User page.

1. Click **Users**.
2. Click **Export** and then click **Save**.
3. Browse to a destination and enter a file name. Leave the default Save as file type set to **.csv Document**.
4. Click **Save** or **OK** depending on your browser.

## Deleting Users

To delete users:

1. Click **Users**.
2. Click **Delete All** to permanently delete all entries in the users list, except the Administrator account. Click **Delete**, , for an individual user to permanently delete that entry.
3. Confirm the deletion when prompted.

## Editing Users

You can edit user account as well as a user's contacts or groups. To edit a user account:

**Note:** User details and fax options for Active Directory users are read-only in FaxFinder. To change these users' details and fax options, make the changes in Active Directory and then sync FaxFinder.

1. Click **Users**.
2. Click **Edit**, , for the user account you want to edit.
3. Make changes and click **Update**.
  - You can edit every user field except Username.
  - From the Edit user page, click Edit Contacts for username to add, edit, delete or import contacts associated with that user. You can also export this users contact list as a CSV file. You can edit or delete each contact record. If you are importing contacts through this page, use the [Contact Record](#) format.
  - From the Edit user page, click Edit Groups for username to add, edit, or delete a group from a user account. Refer to [Using Groups to Organize Contacts](#) for details about using groups.
4. Click **Save**.

## Adding Active Directory Users

After configuring FaxFinder to use LDAP authentication, add the Active Directory users who log into FaxFinder to send faxes.



**Note:** User details and fax options for Active Directory users are read-only in FaxFinder. To change these users' details and fax options, make the changes in Active Directory and then sync FaxFinder.

1. Go to **Users > Active Directory Users**.
2. Click **Add**.
3. Enter an Active Directory Folder name to the **AD Group Name** field. Folder name must match the Active Directory group name. This field is case sensitive.
4. Click **Save**.

Wait until FaxFinder adds Active Directory Users to the users list. When FaxFinder completes this function, Active Directory users become available in the Active Directory Users list.

**Note:** If an error message appears, the Active Directory Server is not configured correctly, cannot be accessed, or the group name was entered incorrectly.

### Syncing FaxFinder with Active Directory

Sync the Active Directory user database with FaxFinder to ensure FaxFinder has all current Active Directory users. To do this:

1. Go to **Users > Active Directory Users**.
2. Click **Sync**.

FaxFinder indicates when synchronization is complete.

### Deleting Active Directory Users

To delete Active Directory users:

1. Go to **Users > Active Directory Users**.
2. Click **Delete**.
3. Confirm the deletion.

A message indicates when the deletion is completed. The Active Directory user list is emptied.

## Contacts

### Allowing Users to Add Global Contacts

By default, only the administrator can add global contacts. If you want to allow any user to add contacts to the Global Address book:

1. Click **Users > User Options**.
2. Check **Users can add to global contacts** and click **Save**.

### Importing Global or Personal Contacts

These steps apply to importing contacts through the Contacts page. If you are importing contacts through the User page, refer to [Importing Users](#) for the correct CSV format.

#### Contact CSV Import Format

Global and Personal Contacts have the same CSV format.

- Your file must conform to the order and format

- If any of your data has apostrophes, commas, or quote marks, enclose the data in double quotes.
- Header rows are optional. CSV files created through the Export function include header information in the first row.

### Example Contact Records

The following example shows an optional header row. Data in your CSV file must be in the same order.

Name	Fax	Organization	Phone
Tony Rogers	555-123-4567	"A company"	555-123-4560
Steve Stark	555-547-3652	Company 2	555-547-3601
Anna Fury	555-540-3960	Company	555-540-3900
Nick Raven	555-573-2457	"Company 3"	555-573-2400

### Contact Record Fields

Field	Notes
Name	Contact's name, can include spaces.
Fax Number	Contact's fax number, any format accepted, for example, (###) ###-#### or ###-###-####.
Organization	Contact's company name, if not available, use "" to skip.
Phone Number	Contact's phone number, any format accepted, for example, (###) ###-#### or ###-###-####.

### Creating a CSV File

To create a CSV file:

1. Open a spreadsheet program such as Microsoft Excel.
2. Create a table as shown in the example for the type of data you are importing. Your fields should be identical to and in the same order as shown in the example.
3. Create a row for each user, contact, or recipient you want to add.
4. Save the file as a .CSV Comma Separated Value file. If using Microsoft Excel, select **Save As** and select the CSV (MS-DOS) format.

### Importing a Global or Personal Contact CSV File

To import a global or personal contact CSV file:

1. Click **Contacts**. The Personal contact page appears. To import global contacts, click Global.
2. Click **Import**.
3. Click **Browse** and select the file you want to import.
4. Select an option for Existing Contacts. Merge is the default.  
**merge** appends the file to the existing list.  
**replace** exchanges the existing list with the list you import.
5. Click **Import**.

### Adding Personal Contacts Individually

For help adding global contacts individually, refer to [Adding Global Contacts Individually](#).

To add a personal contact:

1. Click **Contacts**.
2. Click **Add**.
3. Enter the contact's name, fax number, phone number, and organization.
4. Click **Save**.

## Exporting a Contact List

If you are moving from one FaxFinder to another, you can export the contact list in the correct format from the old unit and import it into the new one. Otherwise, you need a properly formatted CSV file.

1. Click **Contact**. To export global contacts, click **Global**.
2. Click **Export** and then click **Save**.
3. Browse to a destination and enter a file name. Leave the default Save as file type set to **.csv Document**.
4. Click **Save** or **OK** depending on your browser.

## Deleting Global or Personal Contacts

To delete contacts:

1. Click **Contacts**. The Personal contact page appears. To delete global contacts, click **Global**.
2. Click **Delete All** to permanently delete all entries in the contacts list. Click **Delete**, , for an individual contact to permanently delete that entry.
3. Confirm the deletion when prompted.

## Editing Contacts

To edit a contact record:

1. Click **Contacts**.
2. Click **Edit**, , for the contact you want to edit.
3. Make changes and click **Save**.

## Groups

### Using Groups to Organize Contacts

Groups are collections of multiple contacts that you can use for mass faxing. When you send a fax to a group, it is sent to every contact in the group.

To view groups:

- Click **Contacts > Personal Groups** to view the current user's groups.
- Click **Contacts > Global Groups** to view the groups available to all users.

### Adding a Global or Personal Group

To add a group and then add contacts to it:

**Note:** To add contacts to an existing group, start with Step 5.

1. Click **Contacts** and then click either **Personal Groups** or **Global Groups**.
2. Click **Add**.
3. Enter a group **Name** and **Description**.
4. Click **Save** to create the new group. Skip to Step 7 to add contacts to the new group.
5. Click **Edit**, , for an existing group.
6. Click **Add** under Contacts in Personal or Global Group.
7. For Personal Groups only, select **Personal** or **Global** to select contacts from your personal contact list or the global contact list.
8. Check the boxes for each contact you want to add.
9. Click **Add**.
10. Click **Done** to return the Group page.

## Deleting Global or Personal Group

To delete groups:

1. Click **Contacts**. The Personal contact page appears.
2. Click **Personal Groups** or **Global Groups**.
3. Click **Delete All** to permanently delete all listed groups. Click **Delete**, , for an individual group to permanently delete just that group.
4. Confirm the deletion when prompted.

## Editing Groups

To edit a group record:

1. Click **Contacts**.
2. Click either **Personal Groups** or **Global Groups**.
3. Click **Edit** for the group you want to edit.
4. Make changes and click **Save**.

## Recipients

### Viewing Recipients

Use the Inbound Routing Recipients section to link one or more fax delivery options to an extension number. Each recipient entry includes an extension number, name, and fax destinations.

A fax destination (intended recipient) can be a FaxFinder user account, printer, network or SFTP share, an external email address, or the trash bin.

To view recipients:

- Click **Fax Configuration > Inbound Routing**.

### Creating a CSV File

To create a CSV file:

1. Open a spreadsheet program such as Microsoft Excel.

2. Create a table as shown in the example for the type of data you are importing. Your fields should be identical to and in the same order as shown in the example.
3. Create a row for each user, contact, or recipient you want to add.
4. Save the file as a .CSV Comma Separated Value file. If using Microsoft Excel, select **Save As** and select the CSV (MS-DOS) format.

## Importing Recipient Lists

### Recipient CSV Import Format Notes

You can import recipient records from a CSV file, if the file is formatted correctly. To enter recipients individually, refer to [Routing Inbound Faxes](#).

If you are moving from one FaxFinder to another, you can export the recipient list in the correct format from the old unit and import it into the new one. Otherwise, you need a properly formatted CSV file.

- Your file must conform to the order and format.
- If any of your data has apostrophes, commas, or quote marks, enclose the data in double quotes.
- Header rows are optional. CSV files created through the Export function include header information in the first row.

### Recipient CSV Format Example

The following example shows an optional header row. Data in your CSV file must be in the same order.

The example links six fax destinations to four extensions. This would add four entries to the Recipients table, with the last entry having three fax destinations.

Extension	Caller Name	Caller Number	Name	Destination	Destination Value
1001			John Doe	Email	jdoe@example.com
1002			Jane Doe	User	Jane
2000	Sales	651-555-1212	Sales Department	Notify	sales@example.com
2000			Sales Department	Printer	HPLJ3035
2000			Sales Department	Share	//sales_server_name/share_name/folder_name
2002	Support	651-555-1111	Support	Sftp	support@support_server_name

In this example, any fax sent to extension 2000 will be sent to both the printer and share folder, and a fax notification will be sent to the sales@company.com email address.

### Recipient Record Fields

FaxFinder accepts recipient records formatted as:

Field	Notes
Extension	Must be a numeric string.
Caller Name	Can be an alpha numeric string and can contain spaces.
Caller Number	Must be a numeric string.

Field	Notes	
Name	Can be an alpha numeric string and can contain spaces.	
Destination Type	Must be one of the following:	
	<b>Use this in the CSV file</b>	<b>To correspond with this in FaxFinder</b>
	User	Email Fax to User
	Notify User	Email Notification to User
	Email	Email Fax
	Notify	Email Notification
	Share	Share
	Sftp	Sftp
	Print	Print
Trash	Trash	
Destination Value	<p>Is based on the destination type.</p> <ul style="list-style-type: none"> <li>■ Email and notification destinations require a valid email address: 1003,Mr. Smith,Email,smith@gmail.com</li> <li>■ Users must already exist in the FaxFinder User list if the destination is to email a fax or notification to a user: 1004,Bob Rogers,User,brogers</li> <li>■ Printers must already exist under System Configuration &gt; Printer: 2001,Engineering Department,Printer,Eng_HPLJ4000</li> <li>■ Network shares must already be configured under System Configuration &gt;Shares: 2000,Sales Department,Share,//sales_server_name/share_name/folder_name</li> <li>■ Sftp shares must already be configured under System Configuration &gt; SFTP: 2002, Support, Sftp, support@support_server_name</li> <li>■ Trash is indicated by two quote marks: 3000,wrong number,Trash,""</li> </ul>	

## Importing a Recipient List

To import a recipient CSV file:

1. Click **Fax Configuration > Inbound Routing**.
2. Click **Import**.
3. Click **Browse** and select the file you want to import.
4. Select an option for Existing Recipients. Merge is the default.
  - **merge** appends the file to the existing list.
  - **replace** exchanges the existing list with the list you import.
5. Click **Import**.

## Exporting a Recipient List

To export a recipient list:

1. Click **Fax Configuration > Inbound Routing**.

2. Click **Export**.
3. Browse to a destination and enter a file name. Leave the default Save as file type set to **.csv Document**.
4. Click **Save** or **OK** depending on your browser.

## Deleting Recipients

To delete recipients:

1. Click **Recipients**.
2. Click **Delete All** to permanently delete all recipients. Click **Delete**, , for a recipient to permanently delete that entry.
3. Confirm the deletion when prompted.

## Chapter 6 – Advanced Configuration

### Using SFTP

SFTP (Secure File Transfer Protocol) allows you to access, transfer, and manage files securely. SFTP connects to a host, logs in using a key, uses the `cd` command to change directories, and transfers the fax to the host. Once you configure an SFTP server, you can select it as an Inbound Routing Destination.

#### SFTP Fields

Field	Description
SFTP Server	SFTP server's IP address or DNS name.
Username	Displays the SFTP server's username.
Directory	Displays the directory where FaxFinder stores faxes on the SFTP server.

#### Adding an SFTP Server

Use the SFTP page to set up an SFTP server for FaxFinder to use. To add an SFTP server:

1. Go to **System Configuration > SFTP**.
2. Click **Add**.
3. Enter the **SFTP Server IP address** or **DNS name**.
4. Enter a **Username** that has write access to that SFTP server. It can be a general account or one specific to the folder to be shared.
5. Enter the SFTP server directory where the FaxFinder writes the fax.
6. Click **Save** to save settings or **Cancel** to cancel without saving.

When you save a new SFTP server, SFTP Server updated appears at the top of the screen. To route faxes to the SFTP server, select SFTP as the Destination when configuring Inbound Routing for individual lines, recipients, or globally.

#### Downloading an SFTP Key

Download the SFTP key and put it on the SFTP server. Typically, you should copy the key file to the `/home/username/.ssh` directory on the server, then `cat keyfile >> authorized_keys`.

To download the SFTP key from FaxFinder:

1. Go to **System Configuration > SFTP**.
2. Click **Download Key**, , for the server needing the key.
3. Click **Save** to save the key file.

#### Editing SFTP Server Settings

To edit the SFTP server settings:

1. Go to **System Configuration > SFTP**.
2. Click **Edit**, .
3. Make the desired changes and click **Save**.



## Deleting an SFTP Server

To delete an SFTP server:

1. Go to **System Configuration > SFTP**.
2. Click **Delete**.
3. Confirm the deletion.

## Configuring Fax Log Purging

Set the interval when the fax log files are deleted. By default, the logs are removed each Sunday at midnight and one day's logs are kept.

1. Click **Fax Configuration > Fax Logs**.
2. Set log purge parameters and click **Save**.

### Fax Log Purge Parameters

Field	Description	
Email Expired Entries to Administrator	Check to send fax logs to the administrator as an email attachment before FaxFinder deletes them.	
Print Expired Entries	Check to print sent and receive logs.	
Select Printer	Select the printer you want to use from the drop-down list. Printers in this list have already been configured to use with FaxFinder.	
Save Expired Entries to a Share	Check to send fax logs to a share.	
Select Share	If you select to send to a share, click Browse to select a share that has already been configured.	
Only purge log entries older than	Select an option from the drop-down list so that FaxFinder does not purge more recent logs. To purge everything, set this to 0 days.	
Purge Logs at	Select the Hour and Minutes when you want FaxFinder to purge logs.	
Purge Logs on	Select the month and days when you want logs to be purged.	
	Day of Month	Select Every Day of Month or a specific date. To delete all fax logs on the 5th of every month, set this to 5.
	Month	Select Every Month or specific months.
	Day of Week	Select Every Day of Week or select specific days.

### Example Settings

Run report every Sunday at 7:00 pm:	Run report at 11:15 pm on the first day of every month:
Minutes is set to 00	Minutes is set to 15
Hours is set to 7pm	Hours is set to 11pm
Day of Month is set to Every day of month	Day of Month is set to 1
Month is set to Every month	Month is set to Every month

Day of Week is set to Sunday

Day of Week is set to Every day of week

## Purging Fax Logs Immediately

To immediately delete log entries older than the current setting of the **Only purge log entries older than field**:

1. Click **Fax Configuration > Fax Logs**.
2. Click **Purge Logs Now**.

## Emailing or Saving Logs Immediately

To immediately send logs to the administrator without deleting anything and, if a network share is configured, copy logs to a shared folder:

1. Click **Fax Configuration > Fax Logs**.
2. Click **Email/Save Logs Now**.

## Using the Common UNIX Printing System

You can configure FaxFinder to use the Common UNIX Printing System (CUPS).

1. Click **System Configuration > Printer**.
2. Click **Advanced Setup** to open the Common UNIX Printing System (CUPS) page. Use this link for advanced printing configuration and job control.

## Updating Software

### Updating FaxFinder Software

To administer FaxFinder, the browser accesses the FaxFinder server through HTTPS (default port is TCP 443). When you press Update to update firmware, the browser switches to HTTP port 80 to upload the new firmware file. The browser then switches back to HTTPS.

**Important:** The update process takes at least six minutes. Do not power off the FaxFinder during the update.

- While the software is uploading, the browser shows Updating Please Wait and the FaxFinder's Status LED flashes on/off normally.
- When the browser switches back to HTTPS, the browser shows Rebooting Please Wait and the Status LED is solid for about minute and then flashes normally.
- When the process completes, the browser shows the login page.

To check for updates:

1. Click **System Configuration > Software Update**.
2. Click **Default** to ensure the Update Source field is set for the factory URL.
3. Click **Check for Updates**. FaxFinder checks the designated site for a newer software version. If an update is available, an Upgrade button and README link appear.  
Click **Upgrade** to download and install the update.  
Click **Yes** to upgrade and reboot automatically.  
Click **Cancel** if you do not want to update at this time. The update process takes several minutes.
4. Click **README** to view information about the new version.

The upgrade occasionally takes longer than expected. This may cause the browser to show a timeout when the process tries to display the login screen. If this occurs, wait approximately one minute and then refresh your browser.

**Current Version** displays the software version currently installed.

- **Note:** During the upgrade, the HTTPS port (TCP 443 by default) and TCP port 80 needs to be open to the FaxFinder if there is a firewall or other security software blocking these ports.

## Updating Modem Software

This section is for updating the FaxFinder's internal modems. Your model will determine how many internal modems are available.

**Warning:** Do not power off FaxFinder during the update process.

**Note:** Multi-Tech recommends you save the current configuration before updating firmware.

1. Go to [www.multitech.com/support](http://www.multitech.com/support), select your product and scroll down to **Firmware**.
2. Download the firmware file, open the zip file, and extract the zip file contents to a folder on your computer.
3. Go to **System Configuration > Software Update**.
4. Verify that the firmware version currently installed on the modem(s) is older than the firmware you downloaded. Generally, older versions have a lower number.

**Warning:** Do not install an older firmware version unless Multi-Tech Support tells you to.

5. Check the modems that you want to update. Modems are listed in a #:# format. The first number indicates either fax server or an extension box. The second number indicates which modem in that box. If you only have a fax server, the first number is always 1. You can update multiple modems at one time. Before starting the update, verify that modems are not sending or receiving a fax.
6. Click **Browse** and select the **.HEX** file downloaded.
7. Click **Update**.

## Setting the Debug Level

When standard troubleshooting does not resolve an issue, collect debugging information for Multi-Tech Technical Support for more in-depth analysis.

1. Click **System Configuration > Debug**.
2. Select the logging level that Multi-Tech requests from the drop down list. Options are:
  - Emergency
  - Alert
  - Critical
  - Error (default)
  - Warning
  - Notice
  - Info
  - Debug

**Note:** Logging levels are listed in order of least information to most information. Info usually provides enough information for troubleshooting. Because of log size, only use Debug if requested by Multi-Tech Support.

3. Click **Save**.

**Note:** After troubleshooting, reset the level to **Error**. Continuously collecting detailed logs may affect FaxFinder performance.

## Downloading System Logs for Troubleshooting

To download the log file for Multi-Tech Support:

1. Click **Download Logs** and click **Save** when prompted.
2. Send the zipped file to Multi-Tech Support as directed by the support representative.

## Configuring Outbound Fax, Archive and Purge Options

Use this page to set outbound fax and storage options.

### Allowing Simultaneous Faxing

To allow faxing to the same number simultaneously:

1. Click **Fax Configuration > Outbound**.
2. Check **Allow simultaneous faxing to the same number**.
3. Click **Save**.

### Setting Fax Storage Options

To store a copy of outbound faxes:

1. Go to **Fax Configuration > Outbound**.
2. Select which faxes you want to keep. Options are:
  - Keep All
  - Keep Failed, Rejected, and Aborted
  - Keep None
3. Click **Save**.

### Archiving Outbound Faxes

To enable outbound fax archiving:

1. Click **Fax Configuration > Outbound**.
2. Check **Enable Outbound Archive**.
3. Select **PDF** or **TIFF** as the format for the fax archive file. Default is PDF. TIFF is an image file; if you select this, you will not be able to search for a particular word in a fax.
4. Click **Browse** and select a shared folder for storing archive files. This shared folder must be configured in System Configuration > Shares.
5. Click **Save**.

FaxFinder names archive files in the following format: fax\_outbound\_#dialed\_date\_time\_faxID#

## Purging Outbound Faxes

To purge stored faxes:

1. Go to **Fax Configuration > Outbound**.
2. Click **Purge Faxes**.
3. Select a purge option:
  - Purge All
  - Purge Sent
  - Purge Failed and Aborted
4. Click **OK**.

## Enabling Outbound Fax Approval

Use Outbound Approval to restrict outgoing faxes through several categories.

To enable outbound fax approval:

1. Click **Fax Configuration > Outbound Approval**.
2. Check **Enable Outbound Approval** to use some or all outbound fax approval options.
3. Add **Approvers**, which are users who can approve outgoing faxes. By default the Admin account is selected. To add other approvers:
  - a. Click **Add**, ⊕.
  - b. Select a user from the drop down list.
4. Add **Approved Fax** numbers, which are any phone numbers or partial numbers that do not need approval for sending faxes.
  - a. Click **Add**, ⊕.
  - b. Enter a number or partial number and wildcard (\*) to allow for variants, for example, 555-555-5\*\*\*.
5. Add **Approved Users**, which are users who can send faxes without approval. By default the Admin account is selected.
  - a. Click **Add**, ⊕.
  - b. Select a user from the drop down list.
6. **Schedule Reminders** to send email reminders to all approvers when faxes are waiting approval. By default, there are three time intervals: 30 minutes, 60 minutes, and 1440 minutes.
  - a. Click **Add**, ⊕.
  - b. Enter a time in minutes.
7. Click **Save**.

## Removing Approvers

To remove approvers or a reminder time:

1. Click **Fax Configuration > Outbound Approvals**.
2. Click **Delete**,  for the approver or reminder time that you want to delete.

## Enabling the Outbound Approval Report

To generate and schedule fax approval reports that are sent to the Approvers:

1. Click **Fax Configuration > Outbound Approval**.
2. Check **Enabled** under Outbound Approval Report.
3. Select either **CSV** or **XML** for the report format. CSV is the default.
4. Set the report frequency.

Hours	Select an hour for the report to run.
Minutes	Select minutes to set intervals that are not on the hour.
Day of Month	Select Every Day of Month or a specific date.
Month	Select Every Month or specific months.
Day of Week	Select Every Day of Week or select specific days.

5. Click **Save**.

### Example Report Frequency Settings

Run report every Sunday at 7:25 pm:	Run report at 11:00 am on the first every month:
Minutes is set to 25	Minutes is set to 0
Hours is set to 7pm	Hours is set to 11am
Day of Month is set to Every day of month	Day of Month is set to 1
Month is set to Every month	Month is set to Every month
Day of Week is set to Sunday	Day of Week is set to Every day of week

## Configuring Store & Forward Fax (T.37)

Store & Forward Fax allows users to send emails as faxes using the T.37 format. This section describes T.37 parameters. For more information on using T.37, refer to [T.37 Advanced Usage](#)

**Note:** Click **Defaults** to restore the factory default settings.

1. Click **Fax Configuration > Store & Forward Fax (T.37)**.
2. Check **Enable T.37**.
3. Set parameters and click **Save**.

### Store & Forward (T.37) Parameters

Field	Description
Enable T.37	Check to enable T.37 faxing.
Require Authentication	Check to require a valid username and password to use with Store & Forward faxing.

Field	Description	
Secure Authentication Only	Check to allow only secure authentication.	
Set User from Envelope Sender	Check to link faxes sent via T.37 emails with user accounts found in the FaxFinder Users menu. When FaxFinder matches a sender's email address with a FaxFinder user, it logs the fax as sent by that user. Also, if you enable Include Cover Page, FaxFinder populates the cover page's sender information with the user's information.	
Fax Priority	Set the default priority for store and forward faxing. This setting is used when there are more faxes in the queue than there are available modems. Options are: <ul style="list-style-type: none"> <li>■ Low</li> <li>■ Medium/Low</li> <li>■ Medium</li> <li>■ Medium/High</li> <li>■ High</li> <li>■ 1st Priority</li> </ul>	
Max Attempts	Enter the maximum number of times you want FaxFinder to fail sending an email fax before treating that fax as failed.	
Retry Interval	Enter the amount of time in seconds for FaxFinder to wait between unsuccessful transmission attempts.	
Email Fax Receipt	Set the condition that will trigger an email to the sender. Options are:	
	Failure	Receipt sent only if the fax fails.
	Always	Receipt sent on completion, success or failure.
	Never	Receipts are never sent.
Print Fax Receipt	Set the condition that will trigger the fax receipt to be printed. Options are the same as Email Fax Receipt. Never is the default.	
Select Printer	If you select Failure or Always as an Print Fax Receipt option, select which printer you want to use from the drop down list. None is the default.	
Print with First Page	Check this option if you want the fax receipt to print with the fax's first page.	
Fax Attachment with Receipt	Attaches a copy of the sent fax with the email fax receipt. Use this drop down list to select the attachment format. Options are. PDF, TIFF, or None. Default is PDF.	
Include Cover Page	Check this to include a cover page with Store & Forward faxes.	
Default Cover Page	Select the cover page to use by default with Store & Forward faxes.	
Use Email Body as Comments	Check this if you want the body of the email inserted as fax comments.	

## Adding Additional Hosts

You can add additional hostnames and IP addresses that FaxFinder will accept email faxes from. For example, your hostname is example.com, but you also want to allow T.37 faxing from mycompany.example.com.

1. If you are not on the Store & Forward Fax page, click **Fax Configuration > Store & Forward Fax (T.37)**.

2. Click **Add**.
3. Enter the **hostname** or **IP address** and click **Save**.

## Configuring SNMP

Enable Simple Network Management Protocol (SNMP) on FaxFinder so that your SNMP manager will be able to get MIB (Management Information Base) values. FaxFinder Server supports SNMP version 1, 2C and 3 read-only requests.

### Viewing Available MIBs

To view available MIBs:

1. Go to **System Configuration > SNMP**.
2. Click **Download MIB**.

### Configuring SNMP Version 1 and 2C

To configure for SNMP Version 1 and 2C:

1. Go to **System Configuration > SNMP**.
2. Check **Enable SNMP V1/V2C**.
3. Enter **Community Name**. The default value is public.
4. Click **Save**.

### Configuring SNMP Version 3

To configure for SNMP Version 3:

1. Go to **System Configuration > SNMP**.
2. Check **Enable SNMP 3**.
3. Enter **Username**, **Password**, and **Confirm Password**.
4. Click **Save**.

**Note:** For SNMP Version 3, the security level is **Authentication - No Privacy** and the Authentication Protocol is **MD5**. These settings are not configurable.

### SNMP Settings

Field	Description
Community Name	Enter read-only community name. May contain a-z, A-Z, 0-9, - and _. Max length is 32 characters. Required for SNMP V1/V2C. Default is public.
Username	Enter the username required for SNMP V3. Must be between 5-32 characters long. <ay contain a-z, A-Z, 0-9, - and _.
Password	Enter authentication password required for SNMP V3. Must be between 8-32 characters long.
Confirm Password	Re-enter the authentication password.



## Configuring SNMP Allowed Addresses

For SNMP versions 1 and 2C, configure allowed IP addresses to specify which networks are allowed to communicate with FaxFinder. By default, all IP addresses are allowed. As soon as you add one IP address, access through SNMP V1/V2C will be limited by the IP address list.

**Note:** Does not apply to SNMP version 3

1. Go to **System Configuration > SNMP**.
2. Click  to open **Allowed IP Addresses**, then click **Add**.
3. Enter **Network IP address** and netmask in the format of **###.###.###./XX**, where the **###.###.###.###** represents the IP address and the **XX** represents the netmask. For example, 192.168.0.0/16.
4. Click **Save**.
5. Repeat steps 1-3 for each IP address or range that you want to add.

## Deleting IP Addresses

To delete IP addresses

1. On the **System Configuration > SNMP** page, click **Delete**, under **Allowed IP Addresses**.
2. Confirm the deletion when prompted.

## Setting SNMP Traps

Use SNMP traps to send the SNMP notifications available in FaxFinder. To configure SNMP traps:

1. Check **Enable Traps**.
2. Enter **Destination IP address**, in the format **###.###.###.###**.
3. Select SNMP version options are:
  - SNMP V1
  - SNMP V2C
  - SNMP V3
4. Enter additional trap settings as required for the selected SNMP version. Refer to [SNMP Trap Settings](#) for details.
5. Click **Save**.
6. Click **Send Test Trap** to verify that SNMP Trap Settings are configured properly and Trap Destination is able to receive notifications from FaxFinder.
7. All traps are selected by default. Uncheck any trap that you do not want to use. Refer to [SNMP Traps](#) for details.
8. Click **Save**.

## SNMP Trap Settings

Field	Description
Community Name	Enter read-only community name. May contain a-z, A-Z, 0-9, - and _. Max length is 32 characters. Required for SNMP V1/V2C. Default is public.
Username	Enter the username required for SNMP V3. Must be 5-32 characters long. May contain a-z, A-Z, 0-9, - and _.

Field	Description
Password	Enter authentication password required for SNMP V3. Must be 8-32 characters long.
Confirm Password	Re-enter the authentication password.
Engine ID	Engine ID is a unique identifier for the SNMP agent that receives SNMP traps. Engine ID must include the 0x prefix and be a hexadecimal string of 5-32 octets long. For example, 0x0102030405. Use the default Engine ID value generated automatically by FaxFinder.

### SNMP Traps

Trap	Description
FaxFinder server is up	Issued after the system completes a reboot.
The disk is nearing full (reached 90% threshold value)	Issued if empty space on the FaxFinder hard drive is less than 10%.
The modem is stuck (multiple timeouts on initialization)	Issued for FFX40 modems only. If the modem occasionally gets stuck and do not respond on the AT commands, the trap is issued.
The network share could not be reached (network failure)	Issued when FaxFinder cannot access a network share to save files.
The SMTP server is not reachable	Issued when an email fails when sent.
Error while archiving the faxes (the archive log is full)	Issued when FaxFinder cannot archive file because there is no space left on device.
The SFTP server access failed	Issued when FaxFinder cannot access SFTP server while archiving the faxes.
Cannot access the SNTP server for time synchronization	Issued when FaxFinder cannot access SNTP server for time synchronization.
The expander module has been unplugged	Issued when the expansion module is disconnected from FaxFinder.
The expander module has been plugged in	Issued when the expansion module is connected to FaxFinder.
The recent fax took a long time	Issued when the time between when the fax is supposed to be scheduled and when the scheduling actually starts exceeds four hours.

## Chapter 7 – Dialing Rules

Use dialing rules to modify or block outbound fax numbers before sending a fax. This feature allows you to add prefixes or suffixes to an outbound number, set up local or long distance dialing codes, set different rules for different modems, and create a blacklist.

### Dialing Rules Lists

A list is a set of dialing patterns and actions that are performed when a number matches the pattern. Lists can be linked to other lists and assigned to a modem. The default setting is none, meaning all numbers are accepted as is.

### Components

Dialing rules consist of:

- Order
- Pattern
- Action
- Argument (the list name used for Go to or Return from List actions)

All outbound fax numbers are compared to rule patterns according to the list order. The rule action is applied when the fax number matches the pattern.

### Dialing Rule Patterns

Use patterns to specify number formats or ranges or to transform numbers. Patterns may contain the following characters only: 0-9 X \* # , . ! @ \$ - [ ] < > { }

Character	Description	Example
0-9 * # , ! @ \$	Valid fax number characters.	0123456789*#,!@\$
X	Any one valid fax number character.	0 * 9 #
.	Any fax number; any number of valid fax number characters. Can be used as a separate fax number mask or can be added to the end of a pattern and it means any number of any valid characters.	0 9100324657897*94
[-]	Character range.	[0-5] meaning any one of these characters: 0 1 2 3 4 5 [5-6*!] meaning any one of these characters: 5 6 * !

Character	Description	Example
< >	Exclude character from fax number.	<1>XXX - excludes the first character from 4-digit number, if the first number is "1". XX<123> - excludes "123" from 5-digit number, if the last digits are "123"
{ }	Adds characters to fax number.	{912}XXXXXXX – adds "912" to all 7-digit numbers

## Dialing Rule Actions and Arguments

Action	Description
Accept Number	If the fax number matches the pattern, FaxFinder transforms the number according to the pattern and sends the fax to that fax number.
Reject Number	Used for black listed numbers. If a fax number matches the pattern, FaxFinder does not send the fax.
Go to list	If a fax number matches the pattern, FaxFinder transforms that number according to the pattern and compares with the patterns from another list. Select the list from the <b>Argument</b> drop down when applying this action.
Return from list	Returns a fax number to the previous list if there are no matching patterns. If it is present in the list that is directly applied to the modem or channel, this action works as Accept Number.
Ignore Rule	The rule is ignored. Use to temporarily disable a rule.

## Blacklist Numbers

Use "Reject number" action to block sending faxes to the number that matches the pattern.

Description	Order	Pattern	Action	Input Number	Dialed Number
Reject all numbers that start with 911	1	911	Reject Number	9110 9110123456 789	Rejected Rejected
Reject number if it matches the value in the pattern	2	0573331100 99134442200	Reject Number	057 333 11 00 99 13 444 22 00	Rejected Rejected
Reject all 5-digit numbers	3	XXXXX	Reject Number	99*#9 00000	Rejected Rejected

Description	Order	Pattern	Action	Input Number	Dialed Number
If no matching numbers in the current black list, return to the previous list.		.	Return from list	Any Number	Any Number
If "Go to list" command was absent, and this list is assigned directly to the modem or channel, the rule works as "Accept number".					
Accept all fax numbers		.	Accept Number	Any Number	Any Number
Reject all fax numbers		.	Reject Number	Any Number	Any Number

## Go to List and Return from List Actions

We recommend that you manage fax numbers that must be rejected in a separate list. For this example, we call it Black\_List. Below is an example of using Go to list / Return from list actions and black list.

### List: Main\_Rules

Order	Pattern	Action	Argument
1	.	Go to list	Black_List
2	{913}XXXXXXX	Go to list	Black_List
3	<00>{913777}XXXX	Go to list	Black_List
4	.	Accept Number	

### List: Black\_List

Order	Pattern	Action	Argument
1	9135550055	Reject	
2	9137771111	Reject	
3	1234567890	Reject	
4	XXXXX	Reject	
5	.	Return from List	

Assign Main\_Rules list as the dialing rules in the FaxFinder.

When a fax is sent, the Rule #1 from the Main\_Rules list is applied and the fax number is compared with Black List patterns. If there are no matching patterns, the Rule #5 is applied and fax number returns to the Main\_Rules list.

For example:

Fax is sent to fax number **12345**:

- Rule #1 sends 12345 to Black\_List.
- 12345 is compared with rules one by one. It matches to the Rule #4 pattern. The reject number action is applied.
- Result: The fax sent to 12345 fails because it is a blacklisted number.

Fax is sent to fax number **5550055**:

- Rule #1 sends 5550055 to Black\_List.
- 5550055 is compared with all the numbers in the Black\_List.
- There is no matching pattern, so Black\_List Rule #5 sends the number back to the next rule in the Mail\_Rules list, Rule #2.
- Main\_Rules #2 modifies the number 5550055 to 9135550055 and sends it to the Black\_List.
- Number 9135550055 is in the Black\_List and the reject number action is applied to it.
- Result: Fax sent to 5550055 is failed because it is the blacklisted number.

Fax is sent to fax numbers **001111** and **001112**:

- Rule #1 sends 001111 and 001112 to Black\_List.
- 001111 and 001112 are compared with all the numbers in the Black\_List.
- There are no matching patterns, so Black\_List Rule #5 sends the numbers back to the next rule on the Main\_Rules list, Rule #2.
- Main\_Rules #3 modifies number 001111 and 001112 to 9137771111 and 9137771112 and sends them to Black\_List.
- Number 9137771111 is in the Black\_List and the reject number action is applied to it.
- Number 9137771112 is not in the Black\_List and it returns to the next rule in the Main\_Rules list, Rule #4 which accepts the number.
- Actual result: Fax sent to 001111 is failed because it is the blacklisted number. Fax sent to 001112 is sent to 9137771112.

## Examples

It is important to add rules in the proper order. A fax number is compared with patterns one at a time in the set order. In the example below, the rule with order 5 is applied to all 10-digit numbers, except those fax numbers that match patterns with order 3 and 4.

Description	Order	Pattern	Action	Input Number	Dialed Number
Replace fax number "112" with "9713 284 12 12".	1	<112>{97139991212}	Accept Number	112	9 713 999 12 12
Add prefix "9713 999 12 20 #" to all 4-digit numbers	2	{97139991220#}XXXX	Accept Number	4455	9 713 999 1220 # 4455
Add prefix "9" to all 10-digit fax numbers that start with 713.	3	{9}713XXXXXXXX	Accept Number	713 255 18 16	9 713 255 18 16

Description	Order	Pattern	Action	Input Number	Dialed Number
Add prefix "9" to all 10-digits fax numbers that start with 101, 102 or 103.	4	{9}10[1-3]XXXXXXX	Accept Number	101 925 00 00  102 925 11 11 103 925 22 33	9 101 925 00 00 9 102 925 11 11 9 103 925 22 33
Add prefix "91" to all 10 digits fax numbers. <b>Note:</b> This pattern will be applied to all 10-digit numbers except those that match previous patterns with order 3 and 4.	5	{91}XXXXXXXXXX	Accept Number	105 925 44 55	91 105 925 44 55
16-digit number that starts with 00 should be modified: "111#5555" should be added after "00" and suffix "*99" should be added at the end of the number.	6	00 {111#5555} 1866 918 744 13 11 {*99}	Accept Number	00 1866 918 744 13 11	00 111#5555 1866 918 744 13 11 *99
Accept all fax numbers. This mask is added by default to all lists. So it means that all fax numbers that do not match the patterns in the list will be sent as is.	7	.	Accept Number	Any number	Any number
Reject all fax numbers.	8	.	Reject Number	Any number	Any number

## Creating New Dialing Rules

To create new dialing rules:

**Note:** Add Dialing Rules in the particular order that you want to apply them.

1. Go to **Fax Configuration > Dialing Rules**.
2. Click **Add**.
3. Enter **Name**.
4. Click **Save**. The Edit Dialing Rules page appears.
5. Click **Add** to add rule. For details, see [Adding a Rule](#).
6. After adding the rule, use the arrow icons, , to set the order for that rule.
7. Click **Done**.

## Adding a Rule

To add a rule:

1. Enter a **Pattern**. For help with patterns, refer to [Dialing Rule Patterns](#).
2. Select an **Action** from the drop-down list. For details, refer to [Dialing Rule Actions](#).
3. Some actions require an Argument. If a drop-down list appears for Argument, select an argument from the list.
4. Click **Save**. The Edit Dialing Rules page appears.

On the Editing Dialing Rules page, set the rule order and click **Done**. For more information, refer to [Editing Dialing Rules](#) or [Create a New Dialing Rule](#).

## Applying New Dialing Rules



By default, Dialing Rules are set to **none** for all modems. To apply Dialing Rules:

**Note:** In Analog Modem Dialing Rules list should be configured for every modem separately.

1. Go to **Fax Configuration > Modem**.
2. Click **Edit** modem.
3. Select a list from the Dialing Rules drop down.
4. Click **Save**.

## Editing Dialing Rules

To edit dialing rules:



1. Click Fax Configuration > Dialing Rules.
2. Click the Edit icon, , for the rule that you want to edit.
3. To change the Name, type the new name and click **Save**.
4. To add a rule, click **Add**. For details, see [Adding a Rule](#).
5. After adding the rule, use the up and down arrows, , to set the order for that rule.
6. Click **Done**.



---

## Deleting a Dialing Rule or Dialing Rule List

To delete a Dialing Rule or Dialing Rule List:

1. Click **Fax Configuration > Dialing Rules**.
2. To delete an entire list, click **Delete**, . Click **OK** to confirm.
3. To delete a rule, click **Edit**, , for the rule. Then, click **Delete**,  for the rule you want to delete. Click **OK** to confirm.

## Chapter 8 – Using Active Directory with FaxFinder

### Enabling Active Directory

If your organization uses Active Directory to authenticate and authorize users, configure FaxFinder to allow Active Directory users to log in and send faxes.

**Important:** Before you enable Active Directory in FaxFinder, configure your Active Directory schema to work with FaxFinder. For details, refer to [Configuring Active Directory for Use with FaxFinder](#).

1. Go to **System Configuration > Active Directory**.
2. Check **Allow LDAP authentication**.
3. Enter **Active Directory User Settings** and **Active Directory Server Settings**. Refer to [Active Directory Server Settings](#) for details.
4. Click **Save**.
5. Click **Test Connection** to verify that the Active Directory Server is configured correctly.
6. Add **Active Directory Users**. Refer to [Adding Active Directory Users](#) for details.

### Active Directory Settings

Field	Description	
Inbound Routing rule for existing fax extension	Add to the existing destination.	
	Replace the existing destination.	
	Skip adding to the Inbound Routing.	
Auto synchronize with AD FF Users group	Check to allow FaxFinder to automatically synchronize with the Active Directory database. When enabled, use <b>Sync at</b> and <b>Sync on</b> to schedule automatic synchronization.	
Sync at	If you enabled auto synchronize, select the time you want FaxFinder to synchronize with Active Directory. Select Hour and Minute from the drop-down listed.	
Sync on	If you enabled auto synchronize, select when you want FaxFinder to synchronize with Active Directory.	
	<b>Option</b>	<b>Description</b>
	Day of Month	Select Every Day of Month or a specific date. To synchronize FaxFinder with Active Directory on the 5th day of every month, set this to 5.
	Month	Select Every Month or specific month.
	Day of Week	Select Every Day of Week or select specific day.
Hostname	Enter the Active Directory Server IP address.	
Port	Enter the port number you want FaxFinder to use to connect to the Active Directory server. The default port number is 389 when SSL is disabled and 636 when SSL is enabled.	
Use SSL	Check this if you want to use a secure connection to communicate with Active Directory. Enabling this feature automatically changes the port number used to connect to the Active Directory server.	

Field	Description
Domain Name	Enter the complete Active Directory server domain name, for example myserver.mts.com.
Username	Enter an Active Directory username that has read access to Active Directory.
Password	Enter the password associated with the username used to authenticate to the Active Directory.

## Adding Active Directory Users

After configuring FaxFinder to use LDAP authentication, add the Active Directory users who log into FaxFinder to send faxes.

**Note:** User details and fax options for Active Directory users are read-only in FaxFinder. To change these users' details and fax options, make the changes in Active Directory and then sync FaxFinder.

1. Go to **Users > Active Directory Users**.
2. Click **Add**.
3. Enter an Active Directory Folder name to the **AD Group Name** field. Folder name must match the Active Directory group name. This field is case sensitive.
4. Click **Save**.

Wait until FaxFinder adds Active Directory Users to the users list. When FaxFinder completes this function, Active Directory users become available in the Active Directory Users list.

**Note:** If an error message appears, the Active Directory Server is not configured correctly, cannot be accessed, or the group name was entered incorrectly.

## Syncing FaxFinder with Active Directory

Sync the Active Directory user database with FaxFinder to ensure FaxFinder has all current Active Directory users. To do this:

1. Go to **Users > Active Directory Users**.
2. Click **Sync**.

FaxFinder indicates when synchronization is complete.

## Deleting Active Directory Users

To delete Active Directory users:

1. Go to **Users > Active Directory Users**.
2. Click **Delete**.
3. Confirm the deletion.

A message indicates when the deletion is completed. The Active Directory user list is emptied.

## Chapter 9 – Cover Pages

### Custom Cover Pages

FaxFinder uses PDF forms for cover pages. You can create PDF forms with Microsoft Word and Adobe Acrobat Pro. FaxFinder completes the form with information specific to the fax and inserts the cover page as the first fax page. To do this, cover page field names must match the field names FaxFinder uses.

FaxFinder fills in text fields and ignores most formatting. For best results, make your form as simple as possible. Send test faxes to verify that the formatting is correct. FaxFinder includes examples that you can use as a starting point for designing new cover pages.

#### Tips

- Verify that text fields are large enough to fit the information that you want to display. If text is too long for the field, it will be truncated.
- Choose a standard font and keep the font size in the 10-12 pt range.

### Text Field Names and Descriptions

FaxFinder recognizes the following field names. Your document should match the field titles exactly.

Field	Description
date	Current date and time
rcpt_name	Recipient's name
rcpt_fax	Recipient's fax number
rcpt_phone	Recipient's phone number
rcpt_org	Recipient's organization
sender_name	Sender's name
sender_org	Sender's organization
sender_fax	Sender's fax number
sender_phone	Sender's phone number
sender_email	Sender's email address
pages	Number of pages without cover page
pages_with_cover	Number of pages with cover page
pages_without_cover	Number of pages without cover page
subject	Fax subject
comments	Extra comments
optout_fax	Opt-out notice fax number
optout_phone	Opt-out notice phone number
optout_costfree	Opt-out notice email or toll free number or website

## Creating Cover Pages

To create custom cover pages:

1. Design a fax cover page in Microsoft Word, then save the document as a .DOC file. Do not use the .DOCX format. This example is a modified a Microsoft Word fax template.



2. In Adobe Acrobat Pro, use the Form Wizard to open the Word file you created.
3. Use Add New Field to map each field and configure field properties. Note the following:
  - The Field Name you entered in Acrobat must match the Text Field Name that FaxFinder uses, so the form works with FaxFinder.
  - On Properties window, General tab, the Tooltip should match the Name.
  - For Appearance, use a font size of 10-12 pts.
  - For Options, uncheck Scroll long text.
  - If your cover page includes a comments field, check Multi-line on the Options tab. Do not check this for other fields.

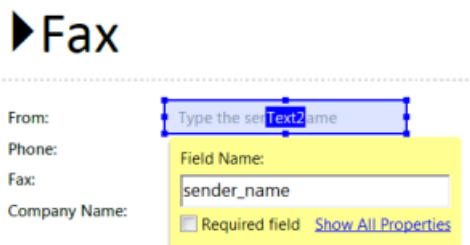

4. Preview the form. To test field lengths, type typical data in each field. If your fields are too small, make the field larger or use a smaller font size.
5. When you are satisfied with the form design, save the file as **Adobe PDF files, Optimized**. If you are using an older version of Acrobat Pro, verify that the file is saved as compatible for Acrobat 5.0 or higher.

## Adding Cover Pages to FaxFinder

To make a cover page available to FaxFinder users:

1. Click **Fax Configuration > Cover Pages**.
2. Click **Add** under Pages.
3. Click **Browse** and select a cover page PDF file.
4. Click **Add**.

## Providing Default Opt-Out Information for Cover Pages

If you use FaxFinder for advertising, use the Opt-Out section to provide fax recipients with information they can use to opt-out of faxes. Where the Opt-Out information appears on the cover page depends on which cover page template you use.

1. Click **Fax Configuration > Cover Pages**.
2. Enter a phone number that recipients can call to opt-out of faxes.
3. Enter a fax number that will accept opt-out faxes.
4. Enter a cost-free method (email address, toll-free phone or fax number or website) that recipients can use to be removed from your fax list.
5. Click **Save**.

## Adding Date and/or Time to Cover Pages

To add date and/or time to cover pages:

1. Click **Fax Configuration > Cover Pages**.
2. Check **Include Date** to add the date to cover pages.
3. Check **Include Time** to add the time to cover pages.
4. Click **Save**.

## Truncating Phone Numbers on Cover Pages

If you require users to enter an access code when dialing out, use this option so the access code doesn't appear on the cover page.

1. Click **Fax Configuration > Cover Pages**.
2. Select **ON** from the Truncate Dialed Phone number.
3. Click **Save**.

## Cover Page Troubleshooting

If the cover page does not work properly with FaxFinder:

- Verify that the original Word document was saved using a .DOC format.
- Verify that the form was saved as Adobe PDF Optimized.
- Verify all form fields are named correctly for FaxFinder. See [Text Fields and Descriptions](#).
- Verify Check Spelling is disabled for each field.

If the received fax has empty form fields:

- Try a different font.
- Verify that FaxFinder's sender and contact fields include this information. For example, if the From Fax field is blank, confirm the user account has a Fax # listed.

# Chapter 10 – FaxFinder Fax Client Software for Windows and Mac

---

## FaxFinder Client for Windows

### Installing FaxFinder Client Software on Windows

FaxFinder Fax Client software allows users to send faxes through the Client or any application with a print option. Install the FaxFinder client software on each user's computer and then associate it with a FaxFinder unit. You can push the client software out to user computers or install it on one computer at a time.

**Note:** You must log in with administrator rights to install the software.

**Attention:** If you have an old version of FaxFinder client software installed, uninstall that software before installing a new version. Use the Add or Remove Programs utility in the Windows Control Panel to uninstall or use mass uninstall.

### Using FaxFinder Client Mass Uninstall

Download the mass uninstall MSI package available from the Multi-Tech System web site to mass un-install the previous version of FaxFinder Client.

[ftp://ftp.multitech.com/faxfinder/Client/Remove%20Installshield/Remove\\_Installshield\\_FFClient.msi](ftp://ftp.multitech.com/faxfinder/Client/Remove%20Installshield/Remove_Installshield_FFClient.msi)

- Example command to uninstall the Install Shield FaxFinder Client in silent mode:

```
msiexec /i remove_installshield_faxclient.msi /q Text of first paragraph.
```

### Pushing Software to Client Computers

The FaxFinder Client installer is available as an MSI package. This allows remote installation using Microsoft Group Policy, SMS, and other third party tools. Use the Windows Installer command msiexec to run this installer from the command line.

**Warning:** Uninstall any older versions of FaxFinder before you install the current version.

**Note:** If you use Windows Vista or Windows Server 2008, turn off the User Account Control (UAC) feature to successfully push the installation.

The installer supports the following options when used from the command line or remote installation:

- Set a different install directory:

```
TARGETDIR=PATH (default is Program Files/Multi-Tech Systems/FaxFinder Client Software)
```

- Add file associations for Multi-Tech TIFF Viewer and Cover Page Editor:

```
ADDFILEEXT=1 (default is 0)
```

- Start the FaxFinder client after installation:

```
LAUNCHPRODUCT=1 (default is 0)
```

- Automatically Start the FaxFinder Client

```
LAUNCHPRODUCTONBOOT=1 (default is 0)
```

- Example command to install in silent mode with options:



```
msiexec /i FFClient-x_x_x.msi /q TARGETDIR="C:\FaxFinder Client" ADDFILEEXT=1 LAUNCHPRODUCT=1 LAUNCHPRODUCTONBOOT=1
```

- Example command to uninstall in silent mode:

```
msiexec /x FFClient-x_x_x.msi /q
```

For an example of remote software installation using Microsoft Group Policy, visit [microsoft.com](http://microsoft.com) and search for Knowledge Base article number 816102.

## Installing the Software on a Single Computer

**Warning:** If you have old versions of any FaxFinder client software installed, uninstall that software before installing a new version. Use the Add or Remove Programs utility in the Windows Control Panel to uninstall.

To download the FaxFinder client software:

1. Go to [www.multitech.com/setup/product.go](http://www.multitech.com/setup/product.go) and select your FaxFinder model.
2. Click **Software**.
3. Double-click the link for the version you want to install and select **Run** or **Open**, depending on your system. If you get a message about the publisher not being verified, click **Run**. If you get a message about the file not being commonly downloaded, click **Actions > Run Anyway**. Some browsers may require you to save the file before running it.
4. Click **Next**.
5. Check to accept the license agreement and click **Next**.
6. **Browse** to the location where you want install the FaxFinder client. The default file location is recommended.
7. To begin installation, click **Install**.
8. To launch FaxFinder when installation completes, check **Start the FaxFinder Client when the install is finished** and click **Finish**.

If you chose to start FaxFinder after installation, the FaxFinder application icon, , appears in your System Tray and the client launches automatically.

**Note:** To send faxes, you need to associate FaxFinder Fax Servers with your client. Refer to [Associating FaxFinder Fax Servers with the Client](#).

## FaxFinder Printer Usage Rights

If your users have a problem printing faxes, verify usage rights for the printer.

1. In Windows, open the printer's Properties.
2. On the Security tab, verify the following checked under Allow:
  - Print
  - Manage Printers

## FaxFinder Client for Mac

### Installing FaxFinder Client Software on a Mac

You need Mac OS X 10.7 or newer to install the FaxFinder Client for Mac.

To install the client on a Mac

1. Mount the disk image (.dmg) by double-clicking the FaxFinder Client .dmg file. When the disk image mounts, a FaxFinder window opens showing the disk image contents, the InstallFaxFinderClient.pkg and this Readme file.

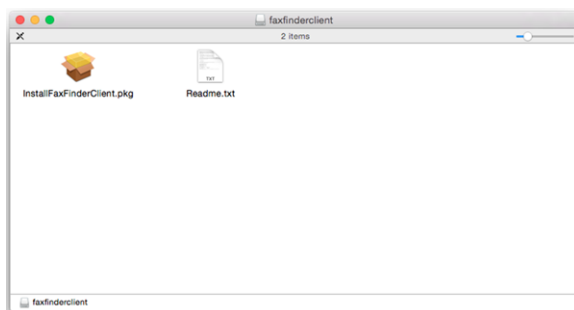

2. Double-click on **InstallFaxFinderClient.pkg**. If you get a warning that "InstallFaxFinderClient.pkg" can't be opened because it is from an unidentified developer, click **OK**.

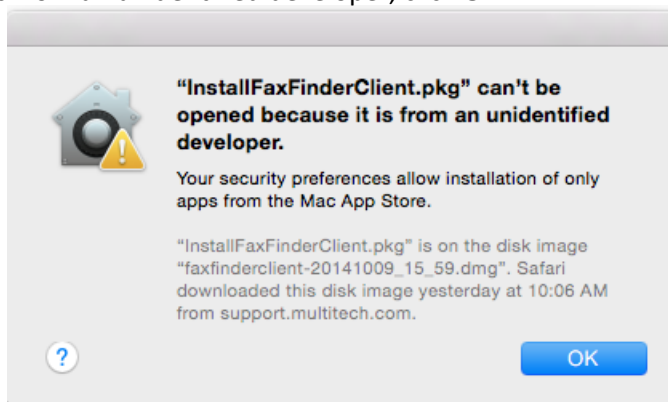

This warning means your Security & Privacy System Preferences setting is safeguarding you against automatic download and installation.

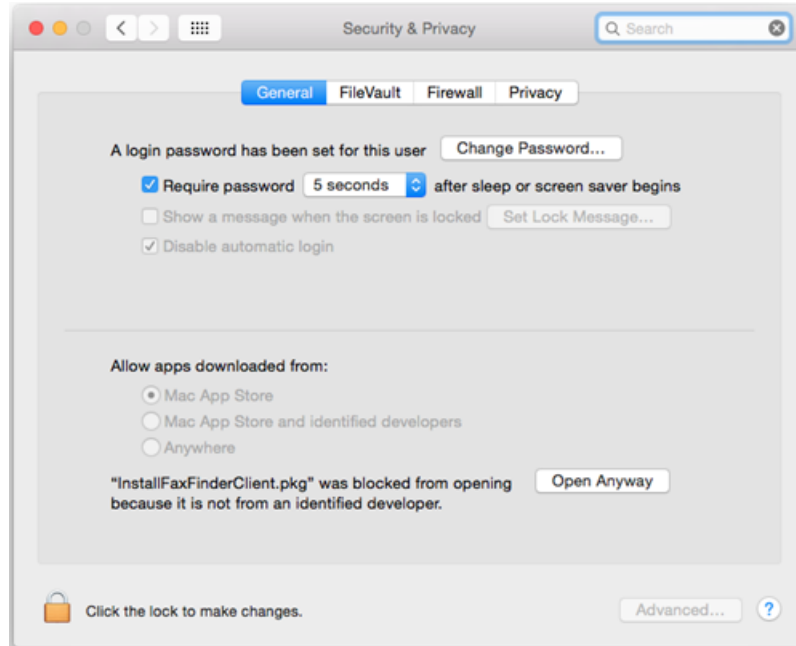

3. To override the warning, right-click or control-click on **InstallFaxFinderClient.pkg** and select **Open** from the pop-up menu.

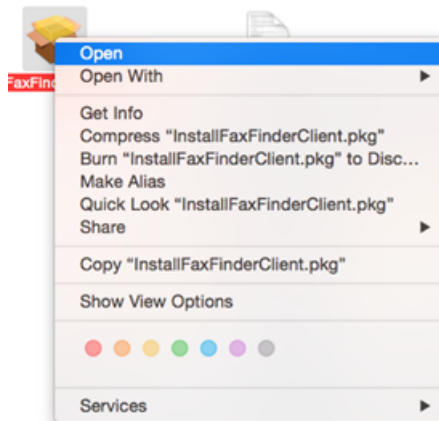

4. If you get another warning that InstallFaxFinderClient.pkg is from an unidentified developer. Click **Open** to continue.

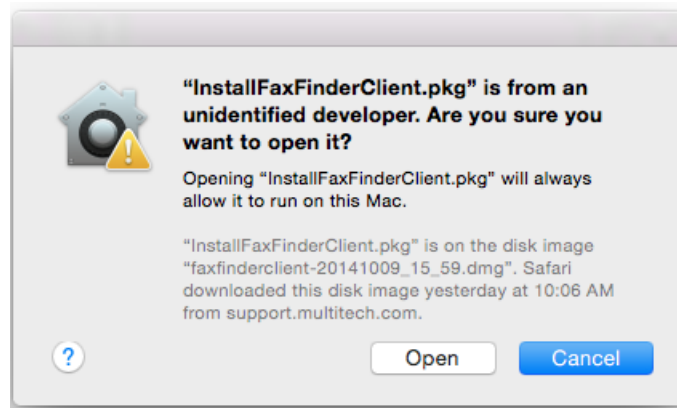

The installer launches in the background. If other application windows are open, you may need select the Installer app in the Dock or use Command-Tab to scroll through active applications to select the Installer so that Installer window displays in the foreground.

5. Follow on-screen instructions to install the FaxFinder Client. Close the Installer when complete.

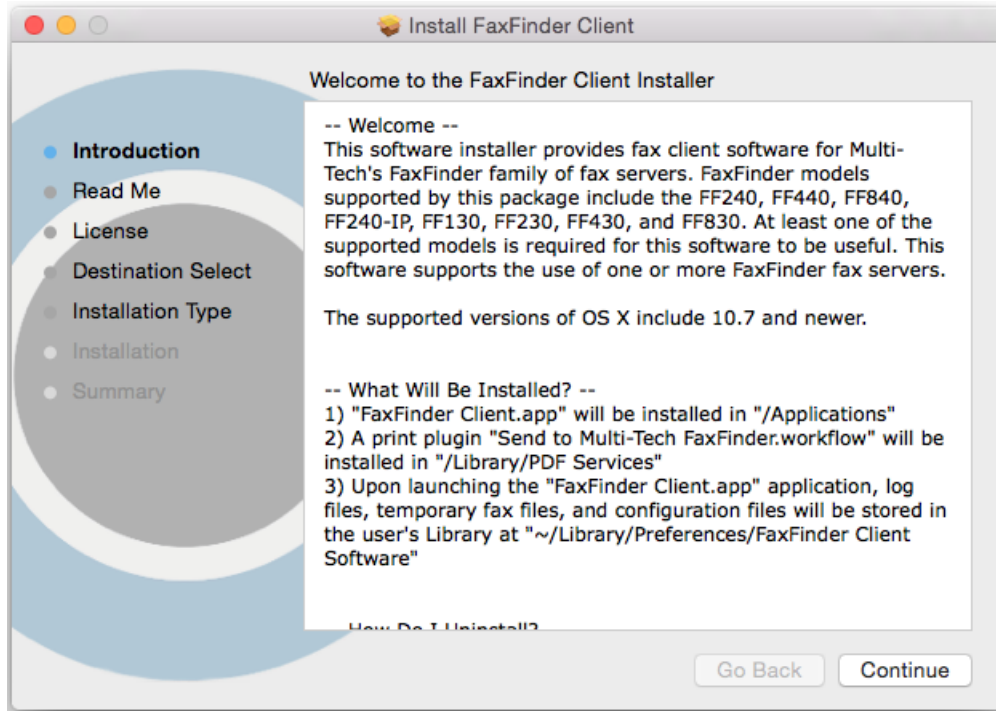

6. Unmount the disk image after closing the Installer.

## Associate or Disassociate FaxFinder Fax Servers from the Client

### Associating FaxFinder Fax Servers with the Client

After installing the FaxFinder Client software, associate it with one or more FaxFinder servers so users can send faxes through the server.

You need the following information for each FaxFinder server:

- IP address, if you do not have the IP address, use Auto Discover.
  - Username
  - Password
1. Start the fax client, if it is not running.
  2. Click **Fax Servers**.
  3. Add a FaxFinder manually or Auto Discover your servers.
    - If you have the IP address, click **Add** to add the unit manually and go to Step 4.
    - If you do not have the IP address, continue with Step 3a.

**Note:** Your firewall may require you to select Allow Access to search.

    - a. Click **Auto-Discover**.
    - b. Click the **Add Server** icon for the server you want to add.

4. Enter Device information. If using Auto-Discover Device, skip to Step 4c.
  - a. Enter the **IP address** in the **Server Address** field.
  - b. If a secure login is required, check **Use SSL**.
  - c. Enter the **Username** and **Password** required by the device.  
Check Show Password to display the password instead.

**Note:** Username and password are case-sensitive.
5. Click **OK. Close** the Auto Discover Device window, if using that option.



If Authentication Failure appears for that fax server, either:

- The IP address is wrong. If so, delete the server (click the **Delete** icon) and add the server again; OR
- The username and password combination is wrong. Click the **Edit Server** icon and enter the correct username and password.

## Disassociating a FaxFinder Unit from the Client

Use this procedure if you need to remove a specific FaxFinder unit from the client. This procedure severs the tie between your PC and a specific FaxFinder unit so that you cannot use it to send faxes. However, you can receive faxes in email form from the FaxFinder server.

If you have multiple FaxFinders set up in the client software and only want to remove one, you will need to know the IP address of the FaxFinder you want to disconnect.

1. If the FaxFinder Client is not running, click the FaxFinder Client icon, .
2. Click Fax Servers
3. Click  for the server you want to disassociate.

## Chapter 11 – Troubleshooting

Additional troubleshooting information is available through the Multi-Tech Knowledge Base at [www.multitech.com/kb.go](http://www.multitech.com/kb.go). If you need help troubleshooting, you can create an account and submit a support case directly to our technical support team. Go to [support.multitech.com](http://support.multitech.com).

### What if I can't see my FaxFinder's web page?

Verify that the admin computer is on the same subnet as the FaxFinder and that it can be pinged.

1. Launch a Command Prompt. In Windows, this is usually found through Start > All Programs > Accessories.
2. Type **ipconfig** and press **Enter** to verify that the admin computer's IP address is in the same network as the FaxFinder's IP address.
3. Type ping **192.168.2.1** (or server's current IP address) and press **Enter**.
  - If FaxFinder replies to the ping and you are still unable to view the FaxFinder web page, contact Multi-Tech Support through the portal at <https://support.multitech.com>.
  - To check the IP address of the FaxFinder, plug a serial cable into the Console/Command port, open communication software (like HyperTerminal) set to a serial speed of 115,200 baud 8N1 and type **ifconfig**.

**Note:** If the FaxFinder is not booting up correctly, the command port can provide direct access to the hardware to view the bootup output. The command port can also be used to change the IP address (especially if the IP is not known.)

### What if I don't get an email when I click Send Test Email?

This pertains to the SMTP settings (System Configuration | SMTP) and may be caused by any of the following.

#### Name server address could not be resolved

FaxFinder could not contact your name server during transmission. Contact FaxFinder using secure shell and try to ping the name server.

```
ssh user@ip
user: admin
password: admin
# ping yyy.yyy.y.y (where y is the name server address)
```

If the name server ping fails, determine why it failed:

- The name server may be on a different subnet.
- The default gateway may be set incorrectly.

If the name server ping succeeds, try to ping the mail server using its domain name.

```
# ping mail.ourcompany.com
■ If you can successfully ping the mail server by its IP address, but cannot ping it via its domain name, then the name server is not functioning correctly.
■ If the mail server cannot be pinged by either its domain name or its IP address, the mail server may not be running or contacted by FaxFinder. See Mail Server Not Running.
```

## Mail Server Not Running

The mail server is not running or cannot be contacted from the FaxFinder unit. To verify that the mail server is running, use your email software to send an email to yourself.

- If you cannot send an email to yourself, the mail server is not running. Troubleshoot the mail server.
- If you can send an email to yourself, the problem is between your mail server and the FaxFinder unit. Contact Multi-Tech Technical Support.

## Client PC can't Connect to Mail Server

If the client PC running the mail software cannot connect to the mail server, troubleshoot the mail server.

## Incorrect Administrator Address

The administrator's email address may be missing or incorrect. Check the administrator's email address through the User page.

## Mail Server Does Not Support SMTP

FaxFinder requires SMTP support. To verify if the mail server supports SMTP:

1. Use secure shell to contact the FaxFinder either at its IP address or name (if a name server is present).
2. Specify the SMTP Port Number. The standard port number is 25, but you can configure this number through System Configuration > SMTP.
3. Use Telnet (IP address: port) to get to the SMTP server. The mail server should return a Welcome message.
4. Enter EHLO. The mail server should list supported protocols and other information.

If the mail server does not respond to the welcome message or the EHLO, either it does not support SMTP or the port number is wrong. The port number specified in the System Configuration > SMTP must match the port number used in Telnet.

## Discrepancy between FaxFinder's SMTP settings and Mail Server's User ID and Password Requirements

Some mail servers reject authentication if a user ID and password are not provided. Other mail servers reject authentication if a User ID and password are provided.

1. Confirm your mail server's user ID and password requirements.
2. Verify that FaxFinder's System Configuration > SMTP settings are correct for your mail server. Either enter the SMTP user ID and password or leave these fields blank.

## What if FaxFinder doesn't answer a fax call?

During a test call, check the Status & Logs > Fax Status page. If you do not see the Waiting for Ring state change to the Waiting for Connect State and you do not hear modem dialup/negotiation tones:

1. Situate yourself where you can see the FaxFinder while using a phone on a regular POTS line.
2. Use the POTS phone to dial one of the FaxFinder phone numbers.
3. As the call completes, listen for fax tones and look for the Waiting for Connect message in Status & Logs > Fax Status.

Sometimes it is possible to see activity in the LED indicators, but the flash is often too brief to notice. Listening for the fax tones is the best method for troubleshooting.

## Where can I Find the SMTP Error Code List?

You can look up these SMTP error codes on the Internet Engineering Task Force RFC repository at [ietf.org](http://ietf.org).

## Dealing with a Failed Fax Report

Occasionally, FaxFinder sends emails about faxes that failed partially or entirely. Some or all of the faxed pages may not be readable. FaxFinder-generated emails of failed faxes include a modem log file with a name like `modem0modem1_date-time.txt`.

The modem log file contains information about the communication between the sending modem and the FaxFinder's receiving modem. This information may help prevent future errors.

When analyzing the modem log files from failed faxes, consider:

- Is this failure is a one-time event or is it part of a larger pattern?
- If it is a one-time event, it is probably unimportant. If it is part of a larger pattern, modem log files help determine what kind of a pattern is involved.
- Are many failures coming from a particular fax machine or from a particular brand or model of fax machine? If so, then check the Multi-Tech web site for applicable modem firmware updates to the FaxFinder.
- Have there been recent changes to the phone system or the room where the equipment is located? Verify that phone lines are connected securely.
- Have phone lines recently been changed or re-routed? Damaged or noisy phone lines can cause fax failures.

### Possible Solutions

- Lower the incoming baud rate for received faxes.
- Check Multi-Tech web site for newer modem firmware for FaxFinder and, if necessary, upgrade the FaxFinder.
- Contact Multi-Tech Technical Support.



## Chapter 12 – T.37 Advanced Usage

For individual faxes, use these commands to override settings entered in the administrator or user web interface. Many options for using email to fax (T.37) follow the Request For Comment (RFC) standards provided by the IETF. Some of these options are briefly described here. For more in-depth descriptions, refer to the IETF website ([www.ietf.org](http://www.ietf.org)). To use T.37 to send faxes, enter one or more options in the format option=value. To use multiple options, divide them with a forward slash (/). Enter options text exactly as shown to trigger the event. Values are the variables allowed by the command. .

### Options

#### **FAX=number**

- Number is the fax number to dial.
- Required. All other settings are optional.

Example:

```
FAX=555-1234@example.test
```

#### **COVER-PAGE-ENABLED=true|false**

Example:

```
FAX=5551234/COVER-PAGE-ENABLED=false@example.test
```

#### **COVER-PAGE-NAME=name**

Name is the FaxFinder cover page filename.

Example:

```
FAX=5551234/COVER-PAGE-NAME=mts_template2.pdf@example.test
```

#### **ATTN=name**

Name is the fax recipient's name; it appears on the cover page.

Example:

```
FAX=5551234/ATTN=John Smith/COVER-PAGE-ENABLED=true@example.test
```

#### **ORG=name**

Name is the organization the fax is being sent to; it appears on the cover page.

Example:

```
FAX=5551234/ORG=Multitech Systems@example.test
```

#### **INLINE-COMMENTS=true|false**

If inline comments are true, the first part of the message body is used as cover page comments. If false, it is not. By default, this is true. Change this by setting /INLINE-COMMENTS=false.

Example:

```
FAX=5551234/INLINE-COMMENTS=false@example.test
```

### **FAX-PRIORITY=0-5**

The fax priority specifies the order of scheduling (0 is highest and 5 is lowest).

Example:

```
FAX=5551234/FAX-PRIORITY=5@example.test
```

### **RECEIPT=always|failure|never**

Controls when an email receipt for the fax is sent to the sender:

- Always means send an email receipt for successful and failed faxes.
- Failure means only send a receipt if the fax failed to send.
- Never means don't send any receipt.

Example:

```
FAX=5551234/RECEIPT=failure@example.test
```

### **RECEIPT-ATTACHMENT=pdf|tiff|none**

Determines the receipt format and if FaxFinder sends email receipts to the sender.

- PDF attaches the sent fax in PDF format to any email receipts.
- Tiff attaches the sent fax in TIFF format.
- None does not attach the sent fax.

Example:

```
RECEIPT-ATTACHMENT=pdf
```

## **Multiple Options Example**

The following example shows the format to use when combining multiple variants for sending a fax. Using these commands overrides the settings on the T.37 configuration page.

### **Parameters**

Send a fax to the phone number 111-555-1234 with a cover page noting the recipient as "John Smith" at the company "Multi-Tech".

String of T.37 options:

```
FAX=111-555-1234/COVER-PAGE-ENABLED=true/ATTN=John_Smith/ORG=Multi-Tech@example.test
```

### **Relaying**

To send faxes through an MTA such as mail.multitech.com, then mail.multitech.com needs to be configured to forward mail to the FaxFinder for a domain that FaxFinder will accept mail for.

For most mail servers, if the email's domain can be successfully resolved, the mail server will forward mail to that destination without any extra configuration.

## Chapter 13 – Regulatory Information

### 47 CFR Part 68 Telecom

1. This equipment complies with Part 68 of the 47 CFR rules and the requirements adopted by the ACTA. Located on this equipment is a label that contains, among other information, the registration number and Ringer Equivalence Number (REN) for this equipment or a product identifier in the format:  
For current products: US:AAAEQ##Txxxx.  
For legacy products: AU7USA-xxxxx-xx-x  
If requested, this number must be provided to the telephone company.
2. A plug and jack used to connect this equipment to the premises wiring and telephone network must comply with the applicable 47 CFR Part 68 rules and requirements adopted by the ACTA. It's designed to be connected to a compatible modular jack that is also compliant.
3. The Ringer Equivalence Number (REN) is used to determine the number of devices that may be connected to a telephone line. Excessive RENs on a telephone line may result in the devices not ringing in response to an incoming call. In most but not all areas, the sum of RENs should not exceed five (5.0). To be certain of the number of devices that may be connected to a line, as determined by the total RENs, contact the local telephone company. For products approved after July 23, 2001, the REN for this product is part of the product identifier that has the format US:AAAEQ##Txxxx. The digits represented by ## are the REN without a decimal point (e.g., 03 is a REN of 0.3). For earlier products, the REN is separately shown on the label.
4. If this equipment causes harm to the telephone network, the telephone company will notify you in advance that temporary discontinuance of service may be required. But if advance notice isn't practical, the telephone company will notify the customer as soon as possible. Also, you will be advised of your right to file a complaint with the FCC if you believe it is necessary.
5. The telephone company may make changes in its facilities, equipment, operations or procedures that could affect the operation of the equipment. If this happens, the telephone company will provide advance notice in order for you to make necessary modifications to maintain uninterrupted service.
6. If trouble is experienced with this equipment, please contact Multi-Tech Systems, Inc. at the address shown below for details of how to have the repairs made. If the equipment is causing harm to the telephone network, the telephone company may request that you disconnect the equipment until the problem is resolved.
7. Connection to party line service is subject to state tariffs. Contact the state public utility commission, public service commission or corporation commission for information.
8. No repairs are to be made by you. Repairs are to be made only by Multi-Tech Systems or its licensees. Unauthorized repairs void registration and warranty.
9. If your home has specially wired alarm equipment connected to the telephone line, ensure the installation of this equipment does not disable your alarm equipment. If you have questions about what will disable alarm equipment, consult your telephone company or a qualified installer.
10. Connection to party line service is subject to state tariffs. Contact the state public utility commission, public service commission or corporation commission for information.
11. This equipment is hearing aid compatible.
12. Manufacturing Information on telecommunications device (modem):

(Modem embedded in FaxFinder)

Manufacturer:	Multi-Tech Systems
Trade Name:	SocketModem
Model Number:	MT5634SMI
Registration Number:	AU7USA-25814-M5-E
Ringer Equivalence:	0.3B
Modular Jack (USOC):	RJ11C or RJ11W (single line)
Service Center in USA:	Multi-Tech Systems, Inc. 2205 Woodale Drive Mounds View, MN 55112 USA (763)785-3500 (763) 785-9874 (Fax)

## 47 CFR Part 15 Regulation Class A Devices

This equipment has been tested and found to comply with the limits for a Class A digital device, pursuant to part 15 of the FCC Rules. These limits are designed to provide reasonable protection against harmful interference when the equipment is operated in a commercial environment. This equipment generates, uses, and can radiate radio frequency energy and, if not installed and used in accordance with the instruction manual, may cause harmful interference to radio communications. Operation of this equipment in a residential area is likely to cause harmful interference in which case the user will be required to correct the interference at his own expense. If this equipment does cause harmful interference to radio or television reception, which can be determined by turning the equipment off and on, the user is encouraged to try to correct the interference by one or more of the following measures:

- Reorient or relocate the receiving antenna.
- Increase the separation between the equipment and receiver.
- Plug the equipment into an outlet on a circuit different from that to which the receiver is connected.
- Consult the dealer or an experienced radio/TV technician for help.

This device complies with Part 15 of the 47 CFR rules. Operation of this device is subject to the following conditions: (1) This device may not cause harmful interference, and (2) this device must accept any interference that may cause undesired operation.

**Warning:** Changes or modifications to this unit not expressly approved by the party responsible for compliance could void the user's authority to operate the equipment.

## Fax Branding Statement

The Telephone Consumer Protection Act of 1991 makes it unlawful for any person to use a computer or other electronic device, including fax machines, to send any message unless such message clearly contains the following information:

- Date and time the message is sent.
- Identification of the business, other entity, or other individual sending the message.
- Telephone number of the sending machine or such business, other entity, or individual.

This information is to appear in a margin at the top or bottom of each transmitted page or on the first page of the transmission. This information in the margin is referred to as fax branding.

Any number of fax software packages can be used with this product. Refer to the fax software manual for setup details. Typically, the fax branding information must be entered via the configuration menu of the software.

## Canadian Limitations

**Notice:** This equipment meets the applicable Industry Canada Terminal Equipment Technical Specifications. This is confirmed by the registration number. The abbreviation, IC, before the registration number signifies that registration was performed based on a Declaration of Conformity indicating that Industry Canada technical specifications were met. It does not imply that Industry Canada approved the equipment.

**Notice:** The REN assigned to each terminal equipment provides an indication of the maximum number of terminals allowed to be connected to a telephone interface. The termination on an interface may consist of any combination of devices subject only to the requirement that the sum of the Ringer Equivalence Numbers of all the devices does not exceed five.

## Industry Canada Class A Notice

This Class A digital apparatus meets all requirements of the Canadian Interference-Causing Equipment Regulations.

Cet appareil numérique de la classe A respecte toutes les exigences du Règlement Canadien sur le matériel brouilleur.

## EMC, Safety, and R&TTE Directive Compliance



The CE mark is affixed to this product to confirm compliance with the following European Community Directives:

Council Directive 2014/30/EU on the approximation of the laws of Member States relating to electromagnetic compatibility;

and

Council Directive 2014/35/EU on the harmonization of the laws of Member States relating to electrical equipment designed for use within certain voltage limits;

and

Council Directive 2011/65/EU on the restriction of the use of certain hazardous substances in electrical and electronic equipment;

and

Council Directive 1999/5/EC on radio equipment and telecommunications terminal equipment and the mutual recognition of their conformity.

## Restriction of the Use of Hazardous Substances (RoHS)



**Multi-Tech Systems, Inc.**

### Certificate of Compliance

#### 2011/65/EU

Multi-Tech Systems, Inc. confirms that its embedded products comply with the chemical concentration limitations set forth in the directive 2011/65/EU of the European Parliament (Restriction of the use of certain Hazardous Substances in electrical and electronic equipment - RoHS).

These MultiTech products do not contain the following banned chemicals<sup>1</sup>:

- Lead, [Pb] < 1000 PPM
- Mercury, [Hg] < 1000 PPM
- Hexavalent Chromium, [Cr+6] < 1000 PPM
- Cadmium, [Cd] < 100 PPM
- Polybrominated Biphenyl, [PBB] < 1000 PPM
- Polybrominated Diphenyl Ether, [PBDE] < 1000 PPM

Environmental considerations:

- Moisture Sensitivity Level (MSL) =1
- Maximum Soldering temperature = 260C (in SMT reflow oven)

<sup>1</sup>Lead usage in some components is exempted by the following RoHS annex, therefore higher lead concentration would be found in some modules (>1000 PPM);

- Resistors containing lead in a glass or ceramic matrix compound.

## REACH Statement

### Registration of Substances

After careful review of the legislation and specifically the definition of an “article” as defined in EC Regulation 1907/2006, Title II, Chapter 1, Article 7.1(a)(b), it is our current view that Multi-Tech Systems, Inc. products would be considered as “articles.” In light of the definition in § 7.1(b) which requires registration of an article only if it contains a regulated substance that “is intended to be released under normal or reasonably foreseeable conditions of use,” our analysis is that Multi-Tech Systems, Inc. products constitute nonregisterable articles for their intended and anticipated use.

### Substances of Very High Concern (SVHC)

Per the candidate list of Substances of Very High Concern (SVHC) published October 28, 2008 we have reviewed these substances and certify the Multi-Tech Systems, Inc. products are compliant per the EU “REACH”

requirements of less than 0.1% (w/w) for each substance. If new SVHC candidates are published by the European Chemicals Agency, and relevant substances have been confirmed to be greater than 0.1% (w/w), Multi-Tech Systems, Inc. will provide updated compliance status.

Multi-Tech Systems, Inc. also declares it has been duly diligent in ensuring that the products supplied are compliant through a formalized process which includes collection and validation of materials declarations and selective materials analysis where appropriate. This data is controlled as part of a formal quality system and will be made available upon request.

## Waste Electrical and Electronic Equipment Statement

### WEEE Directive

The WEEE Directive places an obligation on EU-based manufacturers, distributors, retailers, and importers to take-back electronics products at the end of their useful life. A sister directive, ROHS (Restriction of Hazardous Substances) complements the WEEE Directive by banning the presence of specific hazardous substances in the products at the design phase. The WEEE Directive covers all MultiTech products imported into the EU as of August 13, 2005. EU-based manufacturers, distributors, retailers and importers are obliged to finance the costs of recovery from municipal collection points, reuse, and recycling of specified percentages per the WEEE requirements.

### Instructions for Disposal of WEEE by Users in the European Union

The symbol shown below is on the product or on its packaging, which indicates that this product must not be disposed of with other waste. Instead, it is the user's responsibility to dispose of their waste equipment by handing it over to a designated collection point for the recycling of waste electrical and electronic equipment. The separate collection and recycling of your waste equipment at the time of disposal will help to conserve natural resources and ensure that it is recycled in a manner that protects human health and the environment. For more information about where you can drop off your waste equipment for recycling, please contact your local city office, your household waste disposal service or where you purchased the product.

July, 2005





## Information on HS/TS Substances According to Chinese Standards

In accordance with China's Administrative Measures on the Control of Pollution Caused by Electronic Information Products (EIP) # 39, also known as China RoHS, the following information is provided regarding the names and concentration levels of Toxic Substances (TS) or Hazardous Substances (HS) which may be contained in Multi-Tech Systems Inc. products relative to the EIP standards set by China's Ministry of Information Industry (MII).

### Hazardous/Toxic Substance/Elements

Name of the Component	Lead (PB)	Mercury (Hg)	Cadmium (CD)	Hexavalent Chromium (CR6+)	Polybrominated Biphenyl (PBB)	Polybrominated Diphenyl Ether (PBDE)
Printed Circuit Boards	O	O	O	O	O	O
Resistors	X	O	O	O	O	O
Capacitors	X	O	O	O	O	O
Ferrite Beads	O	O	O	O	O	O
Relays/Opticals	O	O	O	O	O	O
ICs	O	O	O	O	O	O
Diodes/ Transistors	O	O	O	O	O	O
Oscillators and Crystals	X	O	O	O	O	O
Regulator	O	O	O	O	O	O
Voltage Sensor	O	O	O	O	O	O
Transformer	O	O	O	O	O	O
Speaker	O	O	O	O	O	O
Connectors	O	O	O	O	O	O
LEDs	O	O	O	O	O	O
Screws, Nuts, and other Hardware	X	O	O	O	O	O
AC-DC Power Supplies	O	O	O	O	O	O
Software /Documentation CDs	O	O	O	O	O	O
Booklets and Paperwork	O	O	O	O	O	O
Chassis	O	O	O	O	O	O

**X** Represents that the concentration of such hazardous/toxic substance in all the units of homogeneous material of such component is higher than the SJ/Txxx-2006 Requirements for Concentration Limits.

**O** Represents that no such substances are used or that the concentration is within the aforementioned limits.

## Information on HS/TS Substances According to Chinese Standards (in Chinese)

### 依照中国标准的有毒有害物质信息

根据中华人民共和国信息产业部 (MII) 制定的电子信息产品 (EIP) 标准—中华人民共和国《电子信息产品污染控制管理办法》(第 39 号), 也称作中国 RoHS, 下表列出了 Multi-Tech Systems, Inc. 产品中可能含有的有毒物质 (TS) 或有害物质 (HS) 的名称及含量水平方面的信息。

### 有害/有毒物质/元素

成分名称	铅 (PB)	汞 (Hg)	镉 (CD)	六价铬 (CR6+)	多溴联苯 (PBB)	多溴二苯醚 (PBDE)
印刷电路板	O	O	O	O	O	O
电阻器	X	O	O	O	O	O
电容器	X	O	O	O	O	O
铁氧体磁环	O	O	O	O	O	O
继电器/光学部件	O	O	O	O	O	O
ICs	O	O	O	O	O	O
二极管/晶体管	O	O	O	O	O	O
振荡器和晶振	X	O	O	O	O	O
调节器	O	O	O	O	O	O
电压传感器	O	O	O	O	O	O
变压器	O	O	O	O	O	O
扬声器	O	O	O	O	O	O
连接器	O	O	O	O	O	O
LEDs	O	O	O	O	O	O
螺丝、螺母以及其它五金件	X	O	O	O	O	O
交流-直流电源	O	O	O	O	O	O
软件/文档 CD	O	O	O	O	O	O
手册和纸页	O	O	O	O	O	O
底盘	O	O	O	O	O	O

X 表示所有使用类似材料的设备中有害/有毒物质的含量水平高于 SJ/Txxx-2006 限量要求。

O 表示不含该物质或者该物质的含量水平在上述限量要求之内。

## Chapter 14 – Configuring Active Directory for Use with FaxFinder

This section explains how to configure the Multi-Tech FaxFinder in Microsoft Active Directory, a third party application. Microsoft may change their screens and steps without notice. For the latest information pertaining to Active Directory, consult Microsoft's documentation. Contact Multi-Tech Product Support for questions about FaxFinder.

When you enable Active Directory, FaxFinder retrieves user details and configuration settings from your Microsoft Active Directory server. Manage data and settings for FaxFinder users through your Active Directory server.

To modify the Active Directory schema, the Active Directory Administrator must be a member of Schema Administrator and Enterprise Administrators groups. By default, the Administrator belongs to both groups.

To add custom attributes to the Active Directory, you need to:

1. Register schema snap-in
2. Create custom attributes
3. Create custom class and add custom attributes to custom class
4. Add custom class to user class
5. Restart the active directory domain services

**Note:** Make sure that configuring Active Directory did not remove hyphens from any attribute names. For example: Make sure that mtff-FaxPriority did not revert to mtffFaxPriority.

### FaxFinder Server Settings

FaxFinder user details and settings are mapped to the Active Directory attributes as follows. For FaxFinder specific settings add the custom attributes to the AD Schema.

User Details in FaxFinder Server	AD Class	Attribute Name	Type
Login Name	User	sAMAccountName	Default
Name	User	displayName	Default
Email	User	mail	Default
Organization	User	company	Default
Phone Number	User	telephoneNumber	Default
Fax Number	User	facsimileTelephoneNumber	Default
Include Cover Page	mtff-User	mtff-IncludeCoverPage	Custom
Default Cover Page	mtff-User	mtff-DefaultCoverPage	Custom
Max Attempts	mtff-User	mtff-MaxAttempts	Custom
Fax Priority	mtff-User	mtff-FaxPriority	Custom
Retry Interval	mtff-User	mtff-RetryInterval	Custom

User Details in FaxFinder Server	AD Class	Attribute Name	Type
Email Fax Receipt	mtff-User	mtff-EmailFaxReceipt	Custom
Fax Attachment with Receipt	mtff-User	mtff-FaxAttachmentWithReceipt	Custom
Enable Routing	mtff-User	mtff-InboundRouteByFaxExtension	Custom
Fax Extension	mtff-User	mtff-FaxExtension	Custom
mtff-ViewInboundFaxLog	mtff-User	View All Inbound Fax Log	Custom
mtff-ViewOutboundFaxLog	mtff-User	View All Outbound Fax Log	Custom
mtff-PrintFaxReceipt	mtff-User	Print Fax Receipt	Custom
mtff-SelectPrinter	mtff-User	Select Printer	Custom
mtff-PrintWithFirstPage	mtff-User	Print with First Page	Custom

## Registering Schema Snap-in

For more information, refer to *Install the Active Directory Schema Snap-in* on <http://technet.microsoft.com>.

To register schema snap-in:

1. Run  
`cmd.exe`
2. Enter `regsvr32 schmmgmt.dll`

If registration is successful, DllRegisterServer in schmmgmt.dll succeeded appears.

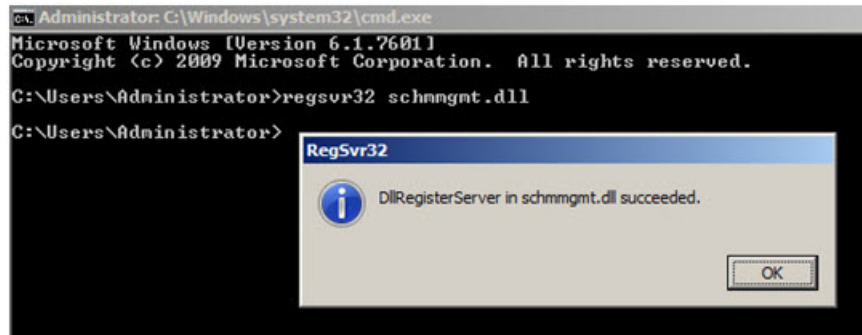

## Creating Custom Attributes

To create customer attributes:

1. Open the console by running  
`mmc.exe`
2. Open **File** and select **Add/Remove Snap-in**.
3. Select **Active Directory Schema** in Available snap-ins.

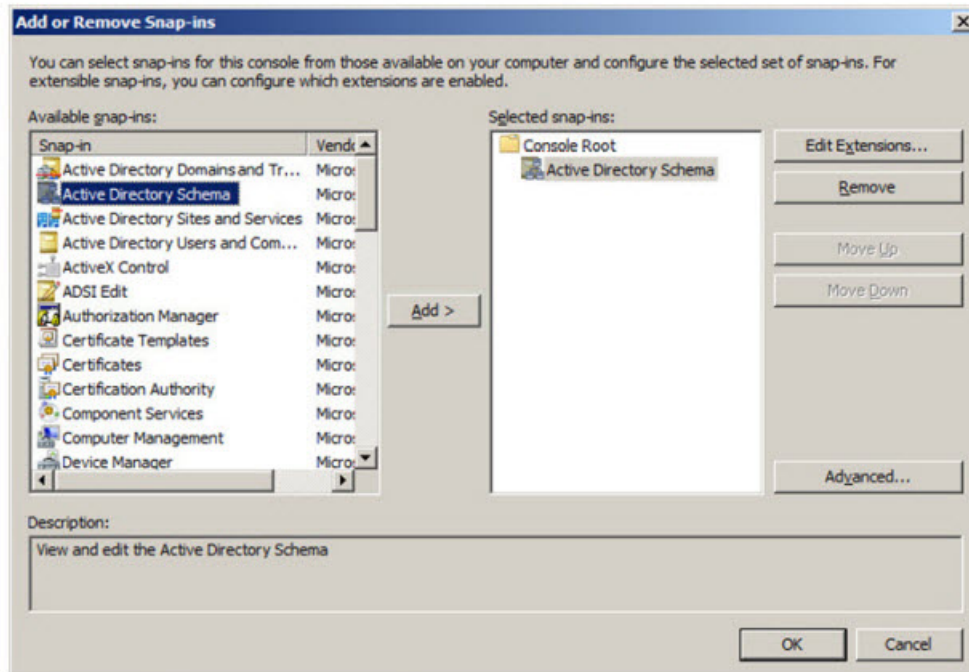

4. Click **Add >** and then click **OK**. The console displays the Active Directory Schema.
5. Right-click on **Attributes** and select **Create Attribute**.

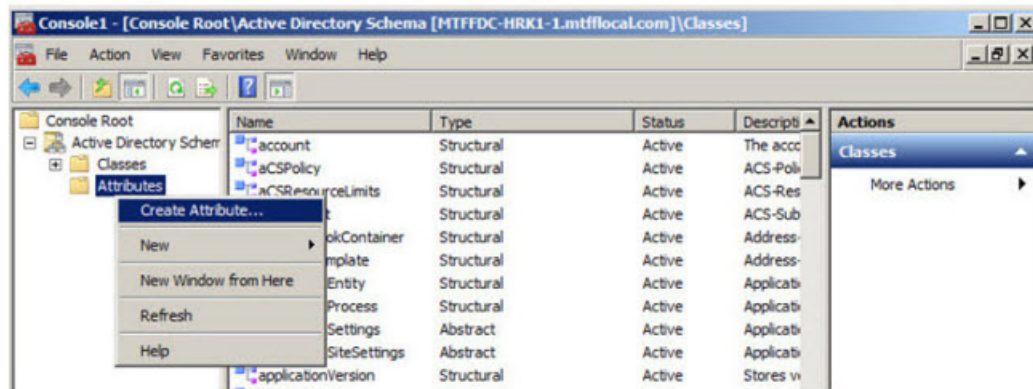

6. When the Schema Object Creation warning appears, click **Continue**.
7. Enter custom attribute settings and click **OK**. For details, refer to Custom Attribute Settings.

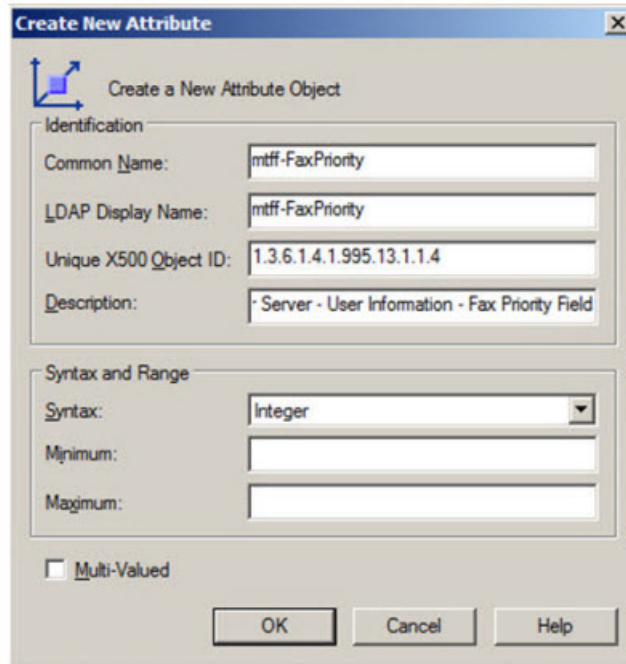

- Repeat Steps 5-7 for each custom attribute.

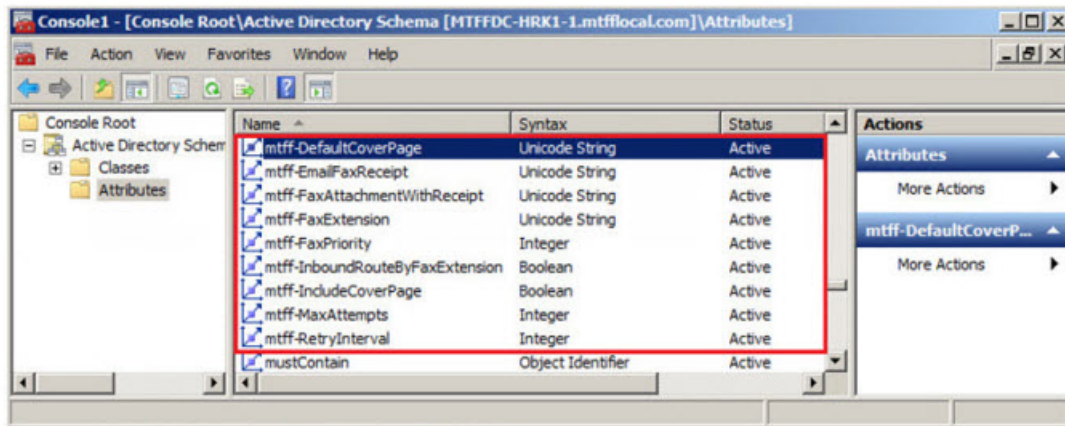

### Custom Attribute Settings

For all custom attributes leave Minimum and Maximum fields empty, and the Multi-Valued checkbox unchecked. Common Name and LDAP Display Name are the same.

**Tip:** To avoid entering typos, copy and paste settings from the following table.

Common Name and LDAP Display Name	Unique X500 Object ID	FaxFinder Field Description	Syntax
mtff-IncludeCoverPage	1.3.6.1.4.1.995.13.1.1.1	User Information - Include Cover Page	Boolean
mtff-DefaultCoverPage	1.3.6.1.4.1.995.13.1.1.2	User Information - Default Cover Page	Unicode String
mtff-MaxAttempts	1.3.6.1.4.1.995.13.1.1.3	User Information - Max Attempts	Integer

Common Name and LDAP Display Name	Unique X500 Object ID	FaxFinder Field Description	Syntax
mtff-FaxPriority	1.3.6.1.4.1.995.13.1.1.4	User Information - Fax Priority	Integer
mtff-RetryInterval	1.3.6.1.4.1.995.13.1.1.5	User Information - Retry Interval	Integer
mtff-EmailFaxReceipt	1.3.6.1.4.1.995.13.1.1.6	User Information - Email Fax Receipt	Unicode String
mtff-FaxAttachmentWithReceipt	1.3.6.1.4.1.995.13.1.1.7	User Information - Fax Attachment with Receipt	Unicode String
mtff-InboundRouteByFaxExtension	1.3.6.1.4.1.995.13.1.1.8	Enable Routing by Extension	Boolean
mtff-FaxExtension	1.3.6.1.4.1.995.13.1.1.9	Fax Extension	Unicode String
mtff-ViewInboundFaxLog	1.3.6.1.4.1.995.13.1.1.10	View All Inbound Fax Log	Boolean
mtff-ViewOutboundFaxLog	1.3.6.1.4.1.995.13.1.1.11	View All Outbound Fax Log	Boolean
mtff-PrintFaxReceipt	1.3.6.1.4.1.995.13.1.1.12	Print Fax Receipt	Unicode String
mtff-SelectPrinter	1.3.6.1.4.1.995.13.1.1.13	Select Printer	Unicode String
mtff-PrintWithFirstPage	1.3.6.1.4.1.995.13.1.1.14	Print with First Page	Boolean

## Creating a Custom Class

In the console:

1. Right-click on **Classes** under Console Root > Active Directory Schema and select **Create Class**.
2. When the Schema Object Creation warning appears, click **Continue**.
3. Enter the following data in the **Create New Schema Class** form.

Common Name:	mtff-User
LADP Display Name:	mtff-User
Unique X500 Object ID:	1.3.6.1.4.1.995.13.1.2.1
Description:	Multi-Tech FaxFinder Server – User
Class Type:	Auxiliary



**Create New Schema Class**

Identification

Common Name: mtff-User

LDAP Display Name: mtff-User

Unique X500 Object ID: 1.3.6.1.4.1.995.13.1.2.1

Description: Multi-Tech FaxFinder Server - User

Inheritance and Type

Parent Class:

Class Type: Auxiliary

< Back   Next >   Cancel   Help

4. Click **Next**.
5. Add the following attributes to the Optional list:
  - mtff-IncludeCoverPage
  - mtff-DefaultCoverPage
  - mtff-MaxAttempts
  - mtff-FaxPriority
  - mtff-RetryInterval
  - mtff-EmailFaxReceipt
  - mtff-FaxAttachmentWithReceipt
  - mtff-InboundRouteByFaxExtension
  - mtff-FaxExtension
  - sAMAccountName
  - displayName
  - mail
  - company
  - telephoneNumber
  - facsimileTelephoneNumber

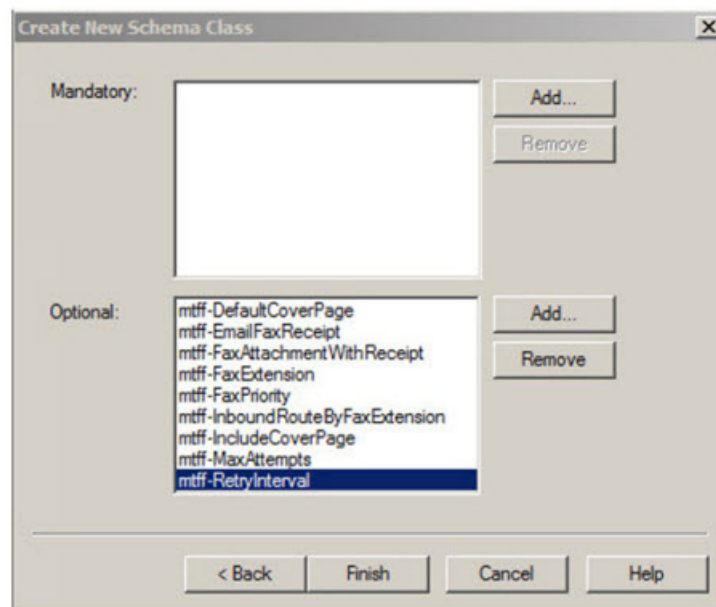
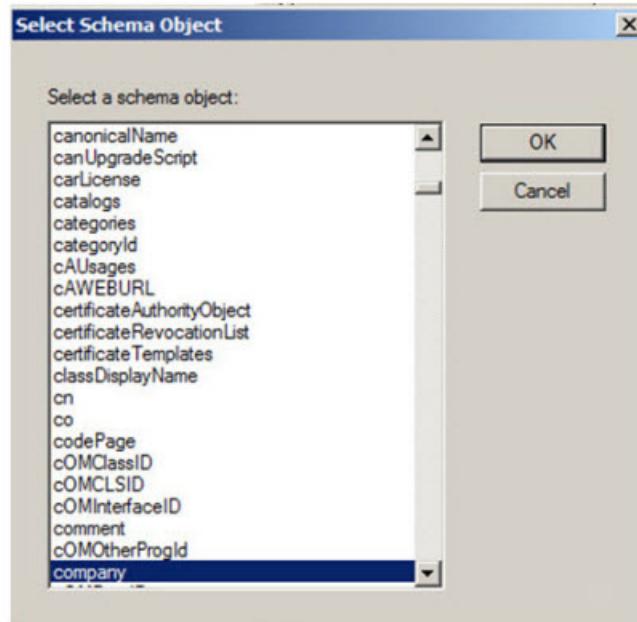

6. Click **Finish**.
7. Verify that **mtff-User** class appears in the Classes list.

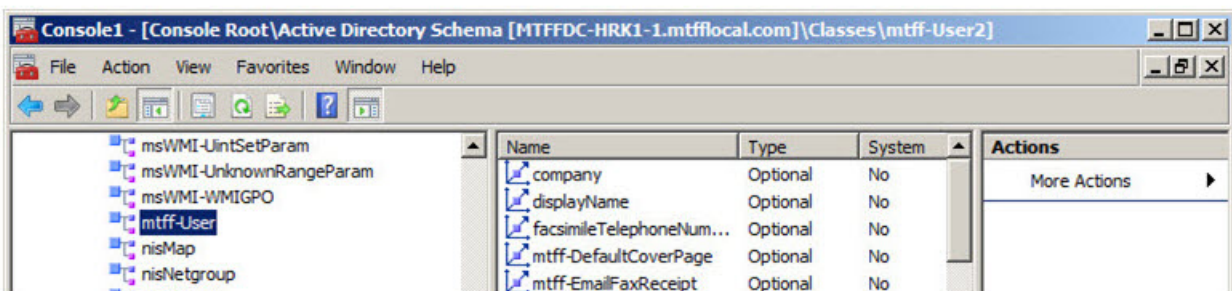

## Adding Custom Class to User Class

To add the custom class to the Active Directory user class:

1. Right-click on the **User** class and select **Properties**.
2. Click **Relationship** and then click **Add Class**. Click **OK**.

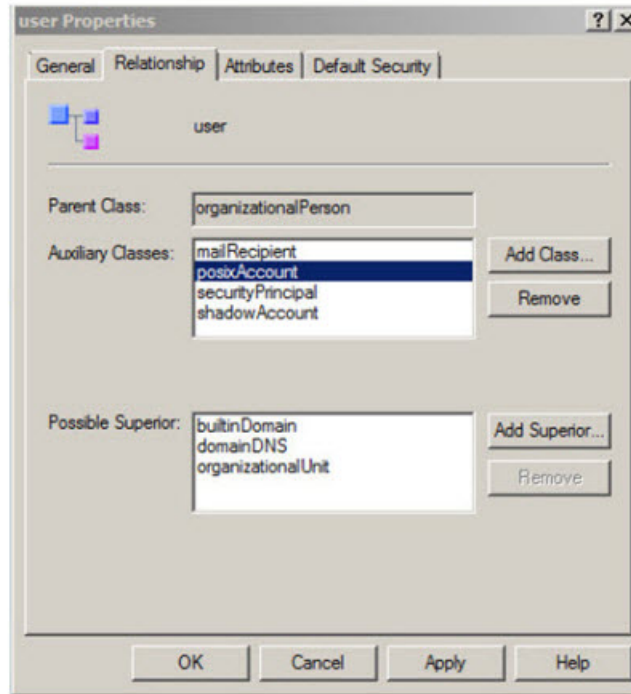

3. Select **mtff-User** from the Select Schema Object list and click **OK**.

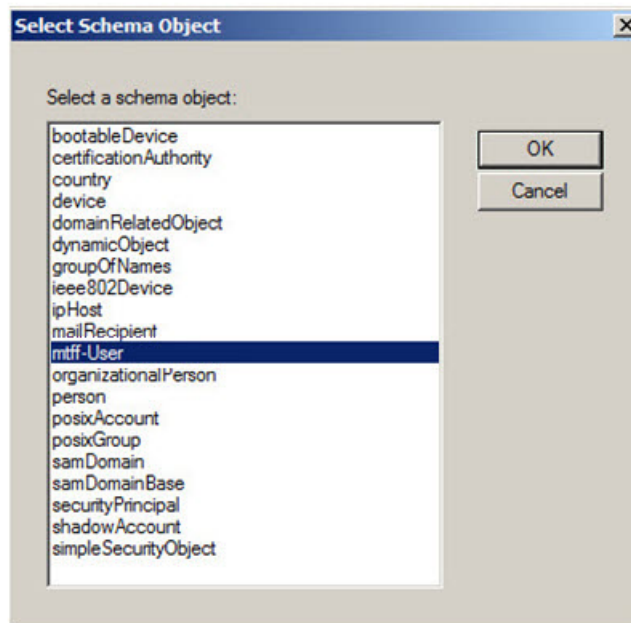

4. Verify that **mtff-User** appears in the Auxiliary Classes list and click **OK**.

**Note:** Active Directory Scheme changes and custom attributes many not be immediately available in the users' attributes list. This depends on your Active Directory settings, configuration, and size.

## User Attributes Management

To modify user attributes, the Active Directory Administrator must be in the Domain Administrators groups.

Use the ADSI Edit management console to manage user attributes in Active Directory. For more information, refer to *ADSI Edit (adsiedit.msc)* on <http://technet.microsoft.com>.

The mtff attributes become available for editing in the user's attributes list when the custom class and attributes are configured and added to the Users class.

### Active Directory User Attributes

Use the following to configure FaxFinder specific user attributes.

If an attribute value is **<not set>**, FaxFinder will use the default value.

Attribute Name	Valid Values	Description
mtff-IncludeCoverPage	TRUE	Enabled – TRUE;
	FALSE	Disabled – FALSE. Default.
mtff-DefaultCoverPage	<cover_page_filename.pdf>	If mtff-IncludeCoverPage is TRUE, enter the default cover page filename. FaxFinder includes three sample cover pages. The default cover page is <b>mts_template1.pdf</b> . <b>Note:</b> Attribute value is case sensitive. The filename you enter here must match your cover page filename on FaxFinder
mtff-MaxAttempts	1-99	Default is 3.
mtff-FaxPriority	0-5	0 - 1st Priority
		1 - High
		2 - Medium/High
		3 - Medium (Default)
		4 - Medium/Low
	5 - Low	
mtff-RetryInterval	1-999999999	Retry interval in seconds. Default is 300 seconds.
mtff-EmailFaxReceipt	failure	Default is failure <b>Note:</b> Attribute value must be lower case.
	always	
	never	

Attribute Name	Valid Values	Description
mtff-FaxAttachmentWithReceipt	pdf	Default is <b>none</b> . <b>Note:</b> Attribute value must be lower case.
	tiff	
	none	
mtff-InboundRouteByFaxExtension	TRUE	Default is <b>FALSE</b> .
	FALSE	
mtff-FaxExtension	0123456789(-)	Max length is 50 characters. Valid characters are: 0123456789(-)

## Editing User Attributes

To edit a user attributes:

1. Go to **Administrative Tools > ADSI Edit**.
2. Expand domain and go to folder with users. Typically this CN=Users.
3. Right-click on the user and select **Properties**.
4. In the Attribute Editor, scroll to the attributes with the mtff prefix and click **Edit** to set values.
5. When finished editing the user's attributes, click **Apply** and then **OK**.

## Create a User Group

To create a user group for FaxFinder users:

1. Go to **Administrative Tools > Active Directory Users and Computers**.
2. Expand Domain, right-click users, and select **New > Group**.
3. Enter Group Name, set Group Scope and Type (any scope or type should work).

## Add Users for FaxFinder

To add FaxFinder users:

1. In **Active Directory Users and Computers**, right-click **Users** and select **New > User**.
2. Enter user name, login name, and click **Next**.  
**Note:** Login names cannot have spaces.
3. Enter a password, check **Password never expires**, and click **Next**.
4. Click **Finish**.

## Add Users to FaxFinder User Groups

To add users to user groups:

1. In **Active Directory Users and Computers**, click on **Users**, right-click on the user you created, and select **Properties**.
2. Click **Member Of**.
3. Click **Add**.
4. Click **Advance**. Search options appear.

5. In the **Starts with** field, enter the FaxFinder group name and click **Find Now**.
6. Select the group from the list and click **OK**.
7. Click **OK** again in the Select Groups menu.
8. Click **Apply** and then **OK** in the User Properties menu.

**Note:** You can also add users to a group through the Members tab.

## Active Directory Troubleshooting

### Verify Connection

To verify the connection:

- Go to **System Configuration > Active Directory**, and click **Test Connection**

This verifies that the hostname, username, password, port, etc. are correct and that the FaxFinder can login into Active Directory on the Server. It doesn't verify that attributes, classes, users, or groups are correct.

### Add Group Fails with Error: The Specified Group Name Cannot be Found

**Symptom:** Test Connection is successful, but when adding a group in **Users >Active Directory Users**, an error message appears: The specified group name cannot be found.

**Use Domain's Full Name:** Make sure you are using the full domain in the **System Configuration > Active Directory** menu, such as support.mts.com. If you use the domain short name the group can't be found.

#### Verify that Group Names Match

1. On Windows Server, go to **Administrative Tools > Active Directory Users and Computers**.
2. Expand Domain and click **Users**.
3. Right-click on the group in the users list and click properties. Take a screen shot of the General tab.
4. Compare group name entered in FaxFinder's **Active Directory Users** menu and the Windows Server's Group Properties.

If names match, is there anything unusual in the group's settings?

### Add Group or Sync Fails with Error: Synchronization Failed

**Symptom:** Test Connection is successful, but when adding a group or syncing in **Users >Active Directory Users**, an error message appears: Synchronization failed.

**Verify that Group Doesn't Have Contacts:** If a contact is added as the group's member on the Active Directory server, FaxFinder generates an error when the contact is encountered and stops adding/syncing additional users.

### Group Successfully Added, But No Users are Added

**Symptom:** When adding a group in **Users > Active Directory Users**, it shows *AD users have been added*, but the Active Directory Users list shows *There are no AD users*.

#### Verify that the Active Directory Group has Users:

1. Take a screen shot of **Users > Active Directory Users** menu.
2. Expand Domain and click **Users**.
3. On Windows Server, go to **Administrative Tools > Active Directory Users and Computers**.

4. Expand Domain and click **Users**.
5. Right-click on the group in the users list and click properties. Take a screen shot of the Members tab.
6. Verify there are users in the Members list.
7. Verify there are no spaces in user names.
8. Verify that user names don't contain special characters.

**Note:** Adding the default *Domain Users* group keeps users from being imported.

## Group Successfully Added, But Not All Users are Added

**Symptom:** When adding a group in **Users > Active Directory Users**, it shows *AD users have been added*, but the Active Directory Users list shows only some of the users created on the Active Directory Server.

**Verify that the Active Directory Group Users Doesn't Already Exist in FaxFinder Users:**

1. Get screen shot of **Users > FaxFinder Users** menu and the Active Directory Group Users.  
**Note:** If Users with the same username were already manually added to FaxFinder **Users > FaxFinder Users**, FaxFinder won't import those users when syncing Active Directory Users
2. Verify there are no spaces in user names.
3. Verify that all users are in the Active Directory Group's members on the AD server.
4. Verify that no contacts are in the Active Directory Group on the AD server.

## Not Able to Edit a User's mtff Attributes on the Windows Server

**Symptoms:** The mtff attributes don't show in **ADSI Edit**. Note that no error message is given if a group is added on the FaxFinder that doesn't have mtff-User class.

You may need to reboot the server for the new attributes to show up in **ADSI Edit**.

**Verify that Users in Active Directory have the mtff-User Class:**

1. On Windows Server, enter **mmc.exe** in a command window to run the **Active Directory Schema Console**.
2. Click **File > Add/Remove Snap-In** and select **Active Directory Schema**.
3. Click **Add** and then **OK**.
4. Expand **Active Directory Schema** and click **Classes**.
5. Right-click on the **user** and select **Properties**.
6. On the **Relationship** tab, look in the **Auxiliary** list for mtff User.

If mtff-User Class is included in the users classes, verify that the mtff attributes are correct and are included in the mtff-User Class (see next section).

## Some User's mtff Attributes are Not Shown in Windows Server Editor

**Symptoms:** Some of the mtff attributes don't show in **ADSI Edit**, but other attributes do.

**Verify mtff-User has All Attributes:**

1. On Windows Server, enter **mmc.exe** in a command window to run the **Active Directory Schema Console**.
2. Click **File > Add/Remove Snap-In** and select **Active Directory Schema**.
3. Click **Add** and then **OK**.

4. Expand **Active Directory Schema** and click **Classes**.
5. Right-click on **mtff-User** in the list and select **Properties**.
6. On the **Attributes** tab, check the **Optional** list for all nine mtff attributes.

If all mtff attributes appear, verify that the attributes are setup correctly (see next topic).

If there were recent changes or additions to the mtff-User attribute list, rebooting the Windows Server may resolve the problem.

### Attributes can be Edited on Windows Server, Changes aren't Shown in FaxFinder Users

**Symptom:** The mtff attributes for the user can be edited on Windows Server with **ADSI Edit**, but these values don't show up in FaxFinder's **Active Directory Users** settings.

**Verify that mtff attributes are setup correctly:** For the attributes that don't update, make sure **LDAP Display Name** and **Unique X500 Object ID** match the values listed in [Custom Attribute Settings](#).

**Note:** mtff DefaultCoverPage is not the same as mtff-DefaultCoverPage. The former LDAP Display Name will not work properly.

### Unable connect using SSL on port 636

**Symptom:** Unable to successfully perform a test connection with Use SSL enabled on port 636, but it works with Use SSL disabled on port 389.

**Verify SSL LDAPS is Enabled on the Windows Server:** Verify SSL LDAPS is enabled on the Windows server. Also verify that a LDAPS certificate was installed on the Windows server.



# Index

- A**
- access code .....86
  - actions for dialing rules.....76
  - Active Directory .....82
    - add custom class to user class.....115
    - add users.....56 83
    - configuring AD to work with FaxFinder .....107
    - create custom attributes .....109
    - creating custom classes .....112
    - custom attribute settings .....111
    - delete users .....57 83
    - mapping .....107
    - register schema snap-in.....109
    - sync users.....57 83
    - user attributes .....116
  - add
    - users.....56 83
  - admin account .....30
  - approvals.....69 70
  - authentication T.37 .....70
  - authentication.....82
  - auto synchronize.....82
- B**
- baud rate.....41
  - blacklist numbers .....76
  - block fax .....48
  - BMP .....14
- C**
- cabling
    - expansion module.....27
  - call
    - log .....49 50
    - routing .....16
    - routing overview .....15
  - cancel fax .....48
  - certificate .....34
  - Chinese hazardous substances
    - Chinese version.....106
    - English version .....105
  - Class A .....101
    - Industry Canada .....102
  - client software
    - associate with FaxFinder unit .....92
    - disassociate FaxFinder unit.....93
    - install.....88 89
    - install on Mac.....90
    - install on Windows .....88
    - mass uninstall .....88
  - configuration
    - create restore file .....44
    - restore.....51
  - configure
    - FaxFinder.....28
    - Store & Forward .....70
  - connectors
    - expansion module.....19
  - contacts.....57
    - allow users to add.....57
    - delete .....59
    - edit .....59
    - export.....59
    - global .....57
      - add individual.....36
    - groups .....59
    - individual.....58
    - personal .....57
    - recipient list .....62
  - country code .....41
  - cover page
    - date and time.....86
  - cover pages .....84
    - add to FaxFinder .....86
    - create .....85
    - opt-out .....86
    - text fields .....84
    - troubleshooting .....86
    - truncated phone number .....86
  - create .....55 58 60
    - cover pages .....85
  - CSV
    - import
      - contact.....58
      - user.....55
  - CSV files.....55 58 60
  - CUPS .....66
  - CVS
    - import
      - recipient .....62
    - recipient.....61

user .....	52	contact .....	59
		recipient .....	62
		user list .....	56
<b>D</b>		<b>F</b>	
date .....	86	factory defaults .....	51
date format .....	30	fax	
debug .....	67	block .....	48
default gateway .....	29	cancel .....	48
delete		client .....	88 89 92 93
contacts .....	59	client on Mac .....	90
groups .....	60	client on Windows .....	88
recipients .....	63	debugging .....	41
user .....	56	ID .....	41
users .....	57 83	log .....	49 50
dialing rules		logs	
actions .....	76	email .....	66
applying .....	80	purge .....	65 66
blacklist .....	76	save .....	66
creating .....	80	management .....	45
deleting .....	81	outbound archive .....	68
editing .....	80	output format .....	38
overview .....	75	purging .....	69
patterns .....	75	regulations .....	102
DNS .....	29	routing overview .....	15
documentation .....	9	send now .....	48
download system logs .....	68	specifications .....	11
dynamic fax delivery .....	16	status .....	46
		storing outbound .....	68
		FCC Notice	
<b>E</b>		Class A .....	101
edit		file	
contacts .....	59	types .....	14
groups .....	60	upload size .....	11
users .....	56	format .....	30
email .....	31	recipient CVS file .....	61 62
admin .....	30	user CVS file .....	52
fax .....	40	<b>G</b>	
fax details .....	38	global	
notifications .....	40	contact .....	36
queue .....	49	contacts .....	57
resend .....	49	group .....	59
size limit .....	38	groups .....	59
engine ID .....	73	delete .....	60
environment .....	11	edit .....	60
Ethernet ports .....	11		
expansion module			
cabling .....	27		
connectors .....	19		
LEDs .....	19		
export			

<b>H</b>	
hazardous substances .....	103
hostname .....	29
hosts .....	71
<b>I</b>	
import .....	57
contacts.....	58
recipient.....	61 62
users.....	52 55
inbound fax	
block.....	48
log .....	49 50
overview .....	15
Industry Canada .....	102
Class A .....	102
input voltage .....	11
install	
client software .....	88 89
client software on Mac.....	90
client software on Windows.....	88
IP address.....	28 29
IP addresses	
SNMP .....	73
<b>J</b>	
JPG.....	14
<b>L</b>	
LDAP .....	82
LEDs	
expansion module.....	19
lithium battery .....	10
log	
purge.....	65
login.....	45
logs.....	50
email .....	66
purge.....	65 66
save.....	66
system.....	68
viewing.....	49
<b>M</b>	
mail	
log .....	49
mail log.....	50
mail queue .....	49
resend .....	49
modem	
configure.....	40 41
reset.....	48
status .....	46
<b>N</b>	
navigation.....	45
network	
settings.....	28
share .....	32 33
<b>O</b>	
operating temperatures.....	11
opt-out .....	86
outbound	
options .....	68
outbound fax	
approval report.....	70
approvals.....	69
archive.....	68
block.....	48
log .....	49 50
overview .....	15
output format .....	38
<b>P</b>	
package contents .....	9
password.....	34 35
forgot .....	45
patterns for dialing rules.....	75
PBX call routing .....	16
PDF .....	14
personal	
contacts.....	57
group.....	59
Ports Ethernet.....	11
power draw	
expansion module.....	13
FaxFinder.....	13
primary DNS .....	29
print.....	40
printer	
adding .....	32

CUPS.....66  
 setup .....32  
 status .....45  
 usage rights.....90  
 PS.....14  
 purge .....65 66

**R**

rack mounting .....24 25  
 reboot .....51  
 recipient .....60  
 delete .....63  
 export.....62  
 import .....61 62  
 reset modem.....48  
 restore  
 configuration.....51  
 factory defaults.....51  
 restore file.....44  
 RoHS.....103  
 routing .....41  
 global .....37  
 inbound.....37 60  
 overview .....15

**S**

safety.....10 11  
 secondary DNS .....29  
 send now.....48  
 server  
 certificate .....34  
 setup .....28  
 SFTP.....64  
 adding server .....64  
 deleting server .....65  
 download key.....64  
 editing server .....64  
 share.....40  
 status .....45  
 simultaneous faxing .....68  
 smart dial .....41  
 SMTP .....31  
 SNMP  
 configure .....72  
 IP addresses .....73  
 traps .....73 74  
 software  
 modem update .....67

software update.....66  
 specifications.....11  
 SSL .....82  
 static fax delivery .....16  
 status.....31 45  
 fax .....46  
 modem.....46  
 Store & Forward  
 configure .....70  
 parameters.....70  
 subnet mask.....29  
 sécurité.....10 11  
 synchronize time .....30  
 sync users.....57 83  
 system .....68  
 status .....45

**T**

T.37 .....97  
 configure .....70  
 parameters.....70  
 Telecom  
 safety notice .....10  
 temperature .....11  
 test  
 email .....31  
 fax .....31  
 TIF or TIFF.....14  
 time .....30 86  
 time format .....30  
 traps  
 SNMP setup .....73  
 trash .....40  
 troubleshooting.....94  
 cover pages.....86  
 truncating numbers on cover page.....86  
 Télécom  
 avis de sécurité .....10  
 TXT.....14

**U**

uninstall client software .....88  
 UNIX .....66  
 update  
 modem software .....67  
 update FaxFinder software .....66  
 user  
 add individual.....34 35

associate with FaxFinder unit .....92  
delete .....56  
edit .....56  
import .....52  
user authentication .....82  
users  
    adding .....56 83  
    deleting .....57 83  
    syncing .....57 83

**V**

view logs.....49

**W**

web management interface.....45