

FIBERGLASS UNLIMITED

"Serving Churches since 1987"

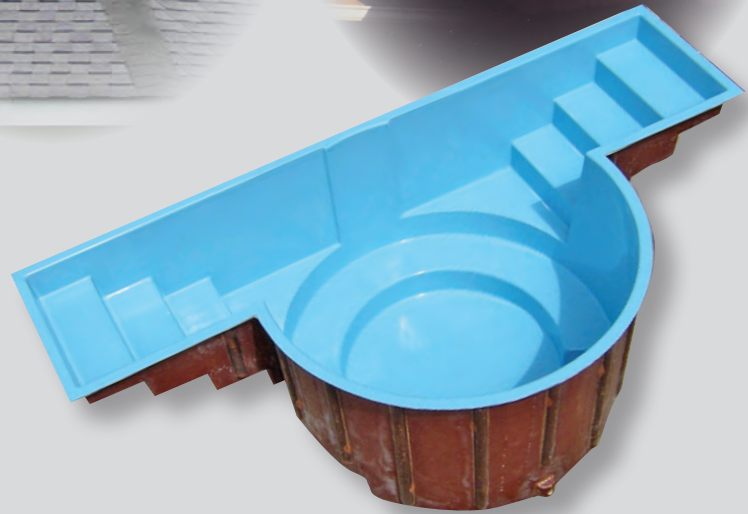
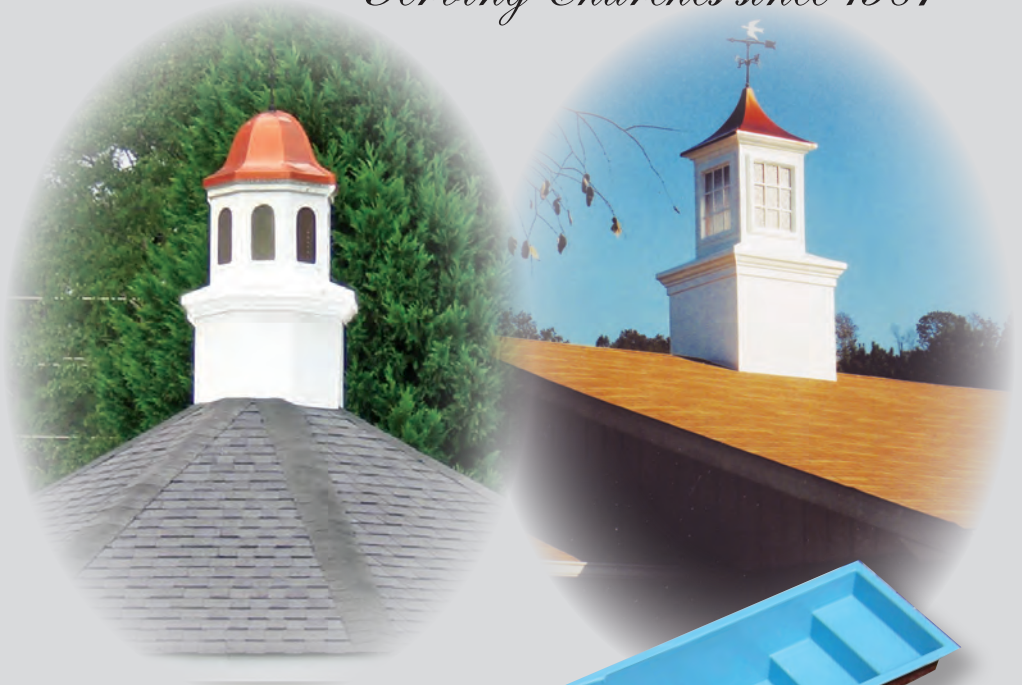

Fiberglass Steeples Offer:

FIBERGLASS UNLIMITED

Molded-in Polyester Gelcoat finish specially designed for severe weathering conditions.

Molded Fiberglass up to ¼" thick. Laminated and reinforced for strength and durability.

FIBERGLASS UNLIMITED has adapted the many superior qualities of molded fiberglass into **QUALITY DESIGNED** and **RIGIDLY CONSTRUCTED** steeples which will add distinction to any church. The beautiful porcelain-like finishes are not affected by extreme temperatures and are fully weatherproof.

FIBERGLASS UNLIMITED steeples can be mounted directly to the roof or can be adapted to fit an existing tower. All colors are molded in during the manufacturing process and provide a beautiful maintenance-free finish which will not stain the roof or tower even after years of weathering.

FIBERGLASS UNLIMITED steeples are shipped on our specially built trucks and trailers ready to be mounted on your roof or tower.

OUTSTANDING VALUE ... more economical than other types of construction.

Whatever your needs in fiberglass products for the church, FIBERGLASS UNLIMITED has the experience, personnel, and facilities to fill those requirements to your complete satisfaction.

EASY MOUNTING ... with anchor plates molded in and pre-cut to fit your roof pitch.

LIGHT WEIGHT ... so that no special reinforcing is needed in most applications.

BEAUTY ... in a porcelain-like finish and a wide variety of designs.

PROMPT SHIPMENT ... to most areas on our special trucks, within four to six weeks of order.

CHOICE OF COLORS ... White (standard), other colors optional. (See price list.)

CUSTOM DESIGNS:

This brochure illustrates some of the most popular combinations of the component parts we build. However, these components can be combined in other arrangements to produce dif-

ferent effects. Call or write and let us know your requirements. We will be glad to submit a combination tailored to your needs.

TO AID IN YOUR SELECTION...

A steeple should enhance and compliment the overall appearance of your church building. Therefore we ask that you contact us with your building measurements or send us a couple of pictures so we can offer suggestions as to size, style, options, etc. This is offered at no cost or obligation to you.

OPERATING HOURS:

The office is open Monday through Friday from 8:00 A.M. to 5:00 P.M. Plant hours are from 6:00 A.M. to 3:00 P.M. Pickups **MUST** be made before 3:00 P.M.

TERMS:

A 30% deposit required with order. The balance is due upon delivery or pickup. (See price list for price of delivery).

LIGHTNING PROTECTION: Lightning protection can be added to steeple upon request. (See price list). The aluminum wire will run from the top of the steeple to the bottom. The church is responsible for taking it to the outside and grounding it. Extra ground wire can also be purchased. It is not installed or grounded by Fiberglass Unlimited.

KRINKGLAS:

Krinkglas can be added where louvers are shown in the brochure. (See price list). All steeples with Krinkglas windows can have interior lighting for illumination.

BALL/CROSSES:

Balls and/or crosses can be added to any steeple. (See price list).

PLEASE HAVE THE FOLLOWING INFORMATION READY WHEN PLACING STEEPLE ORDERS.

1. Roof pitch on all steeple orders. Signed approval form if pitch is cut.
2. Material roof is made of. Is there a loft?
3. Picture or sketch of church; front and side view.
4. At least two contacts with day & evening phone numbers.





Model 240



Model 465-S



Model C-110



Model 360

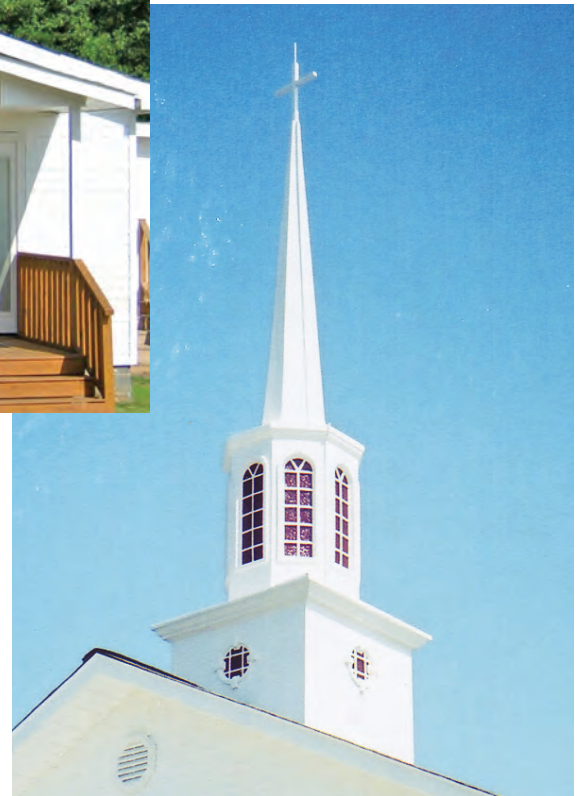

Model #390 steeple with decorative options:
1. 3' cross
2. Krinkglas windows with muntins
3. Round keyblock Krinkglas windows

Steeple

Cross, Ball and Lightning Protection Options Are Available On Any Steeple. Please See Price List.

Steeple Dimensions

Width: At roof

Height: Overall of stock unit without cross

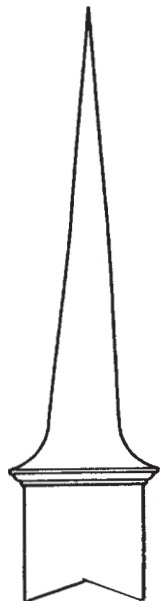

Model # 210
14' High
36" Base

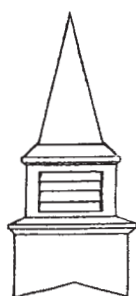

Model # C110
9'5" High
3' Base



Model # C118
10' High
3' Base

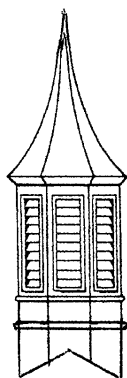

Model # 200
14' High
33" Base

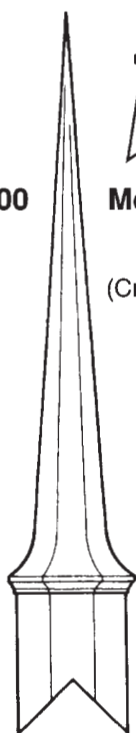

Model # 260
19' High
40" Base
(Cross optional)

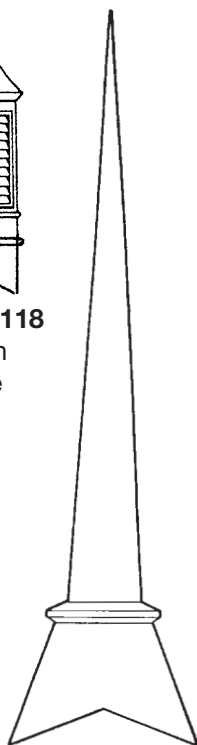

Model # 280
20' High
60" Base

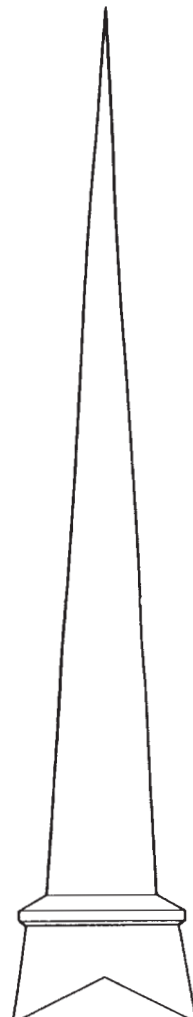

Model # 290
28' High
5' Base

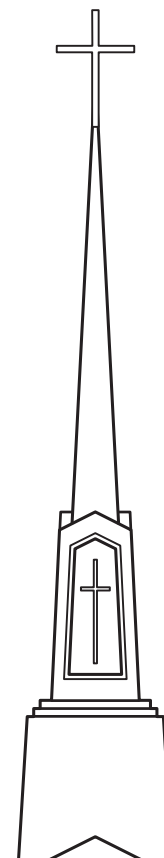

Model # 255
26' High
60" Base
Krinklglas Optional
Cross Optional



Model # 175
21'6" High
3" Base
Cross Optional

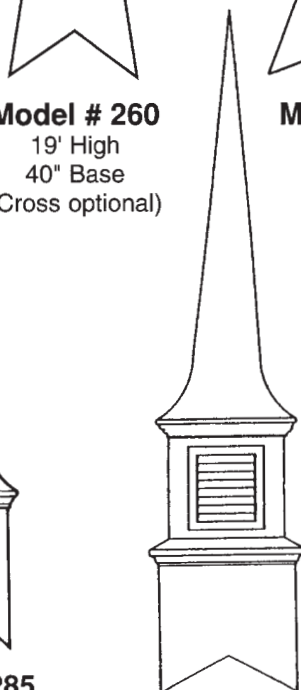

Model # 285
20' High
3' Base

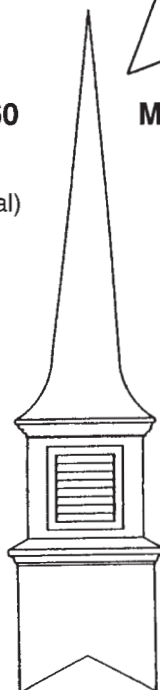

Model # 215
19' High
3'9" Base

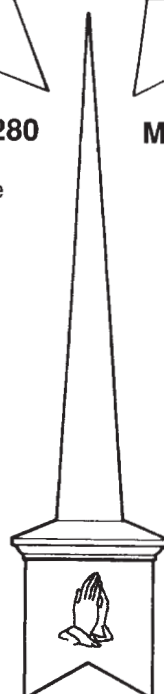

Model # 270
19' High
3'6" Base

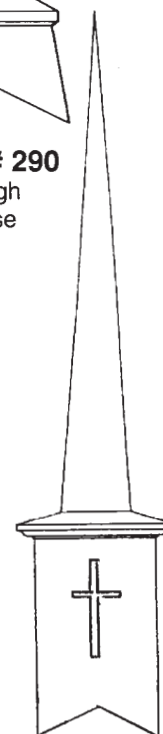

Model # 276
21' High
3'6" Base

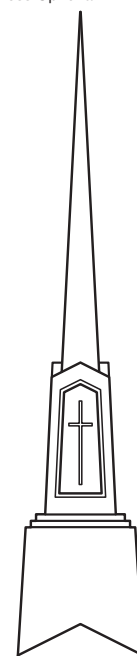

Model # 250
20' 6" High
4" Base
Krinklglas Optional

Cross, Ball and Lightning Protection Options Are Available On Any Steeple. Please See Price List.

Steeple

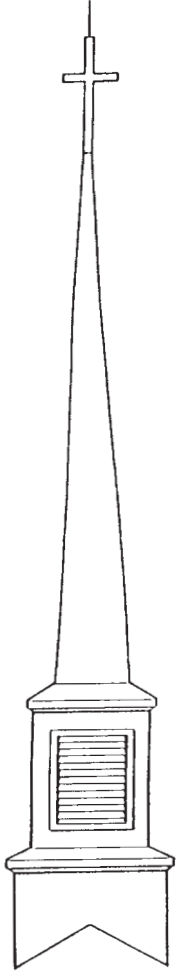

Model # 275
24'10" High
4'0" Base
(Shown with 3'
optional cross)

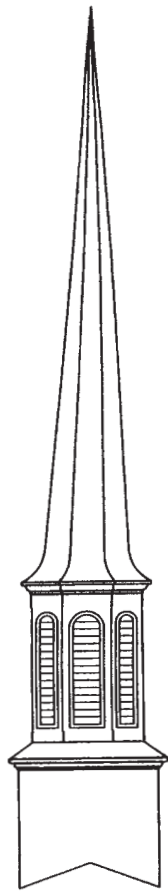

Model # 295
24' High
3'9" Base

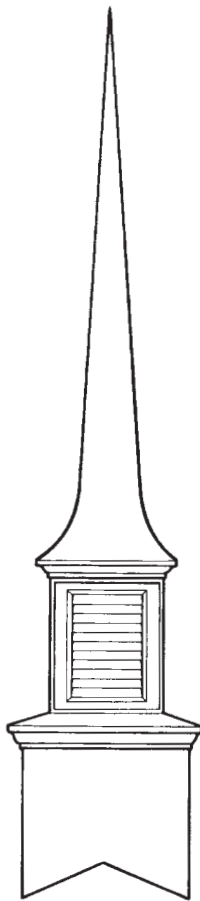

Model # 330
24' High
4'6" Base

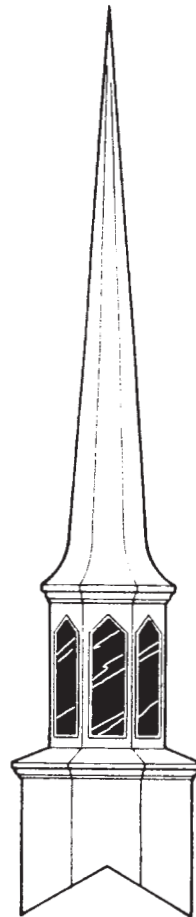

Model # 350
24'8" High
4'6" Base
(Krinklglas window
optional)

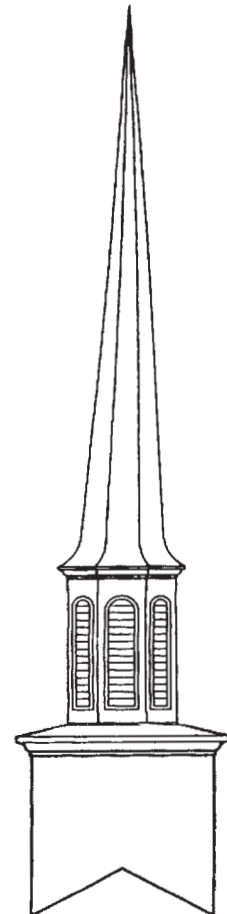

Model # 376
26' High
60" Base

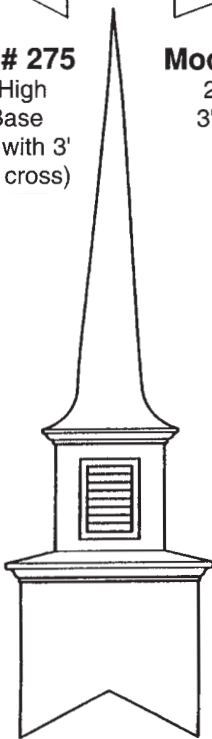

Model # 220
19' High
60" Base

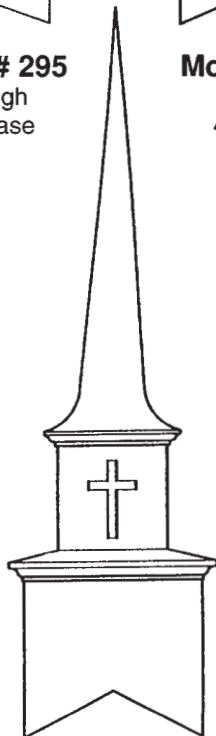

Model # 240
19' High
60" Base

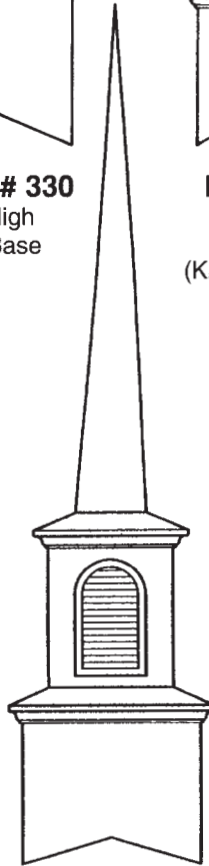

Model # 360
24'5" High
60" Base

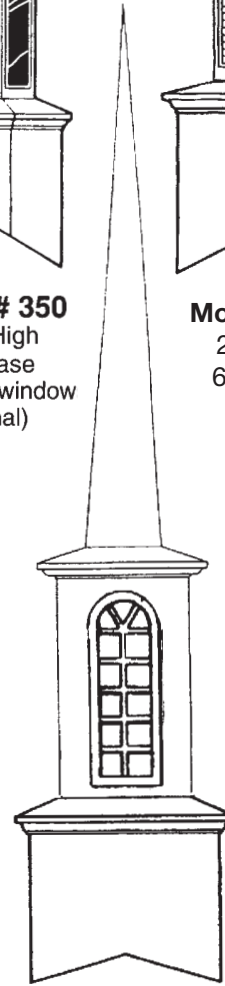

Model # 366
26' High
60" Base
Krinklglas Optional

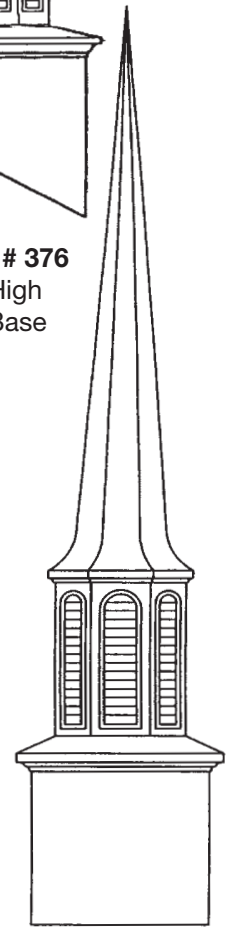

Model # 370
26' High
60" Base

Steeple

Cross, Ball and Lightning Protection Options Are Available On Any Steeple. Please See Price List.

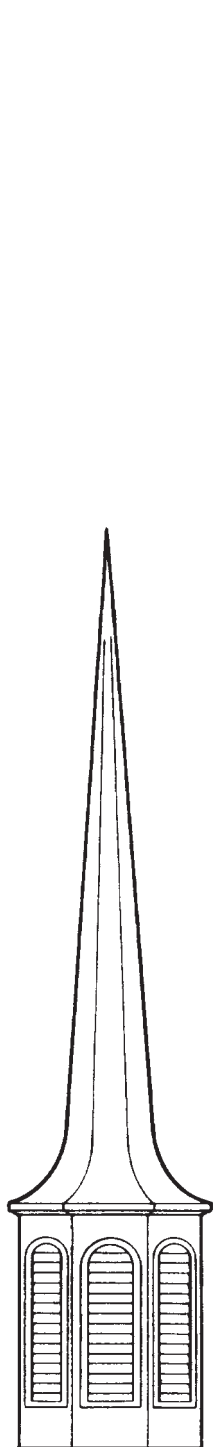

Model # 300
21'0" High
48" Base

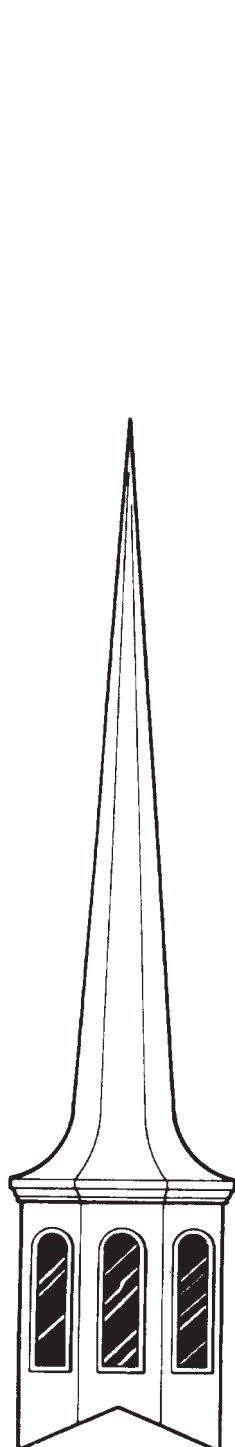

Model # 320
23'6" High
4'6" Base
(Krinklglass windows optional)

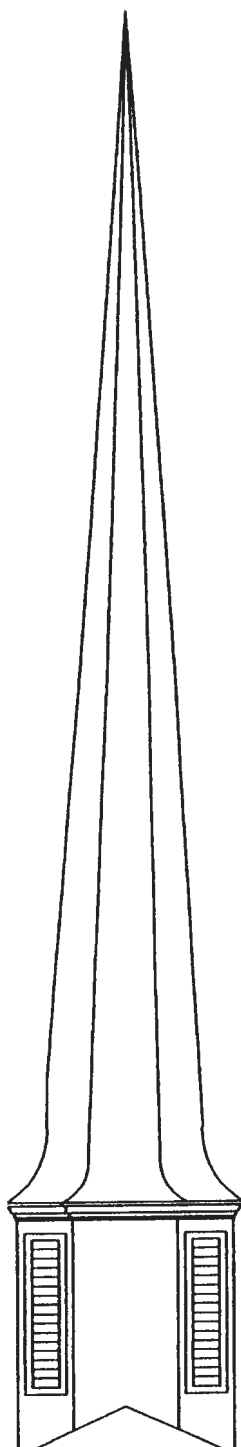

Model # 325
32'5" High
5'0" Base
(Windows & louvers available, cross optional)

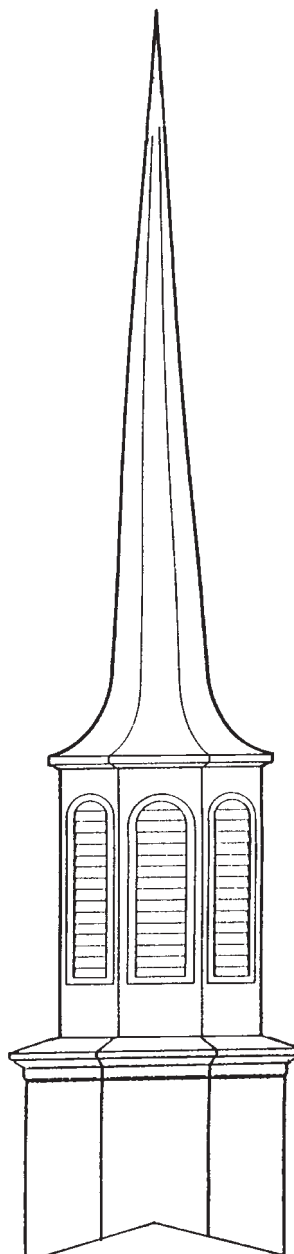

Model # 328
28'6" High
72" Base

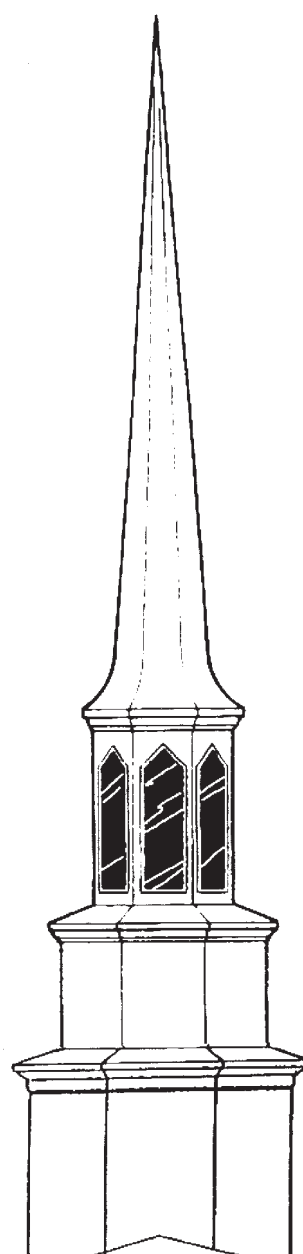

Model # 338
28'6" High
72" Base
Krinklglass Optional

Cross, Ball and Lightning Protection Options Are Available On Any Steeple. Please See Price List.

Steeple

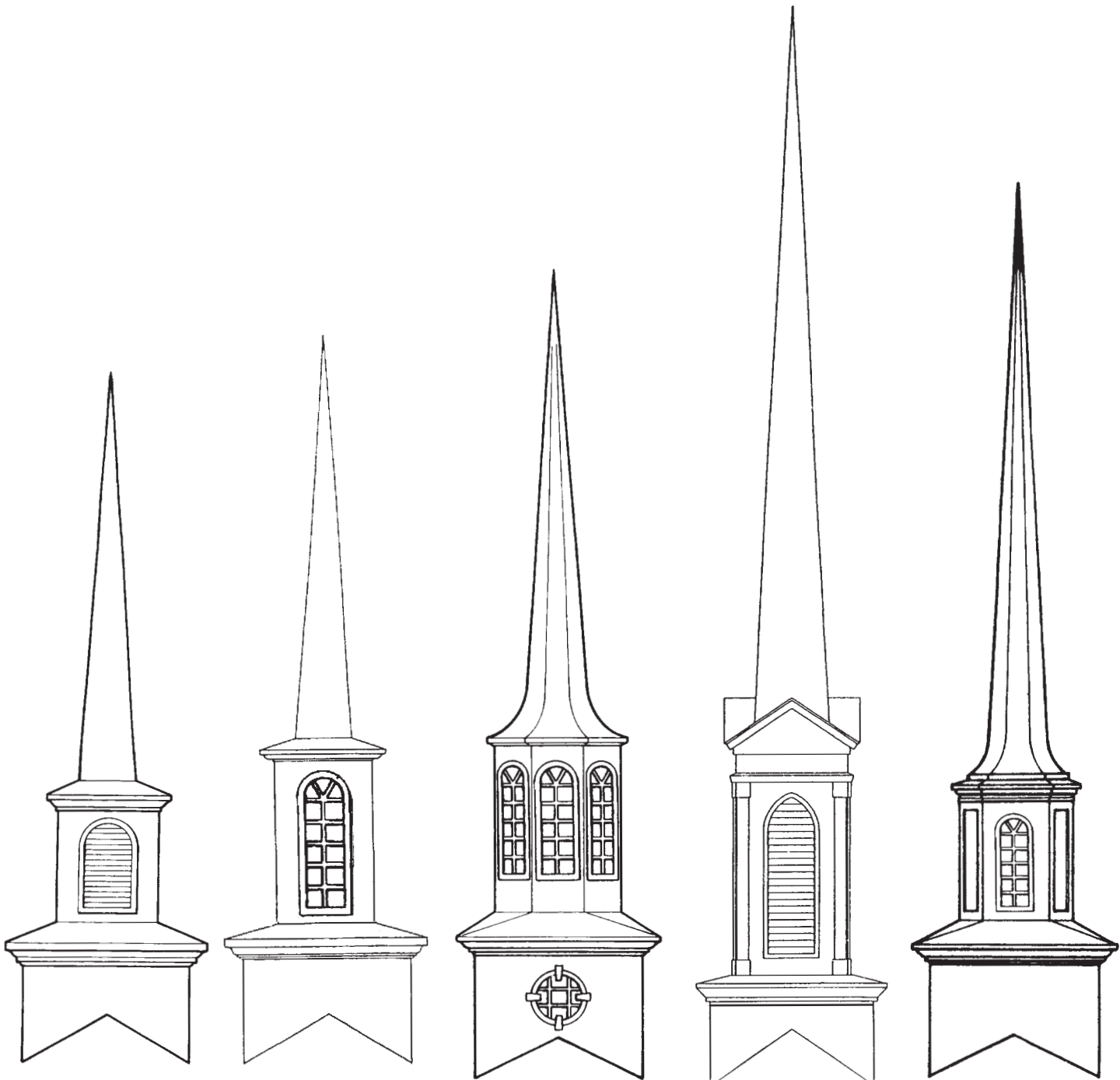

Model # 340
24' High
72" Base

Model # 346
26' High
72" Base
Krinklglass Optional

Model # 390
28'6" High
72" Base
(Round key-block window optional
(Krinklglass windows optional)

Model # 465
39' High
72" Base

Model # 455
31'6" High
72" Base

Steeple

Cross, Ball and Lightning Protection Options Are Available On Any Steeple. Please See Price List.

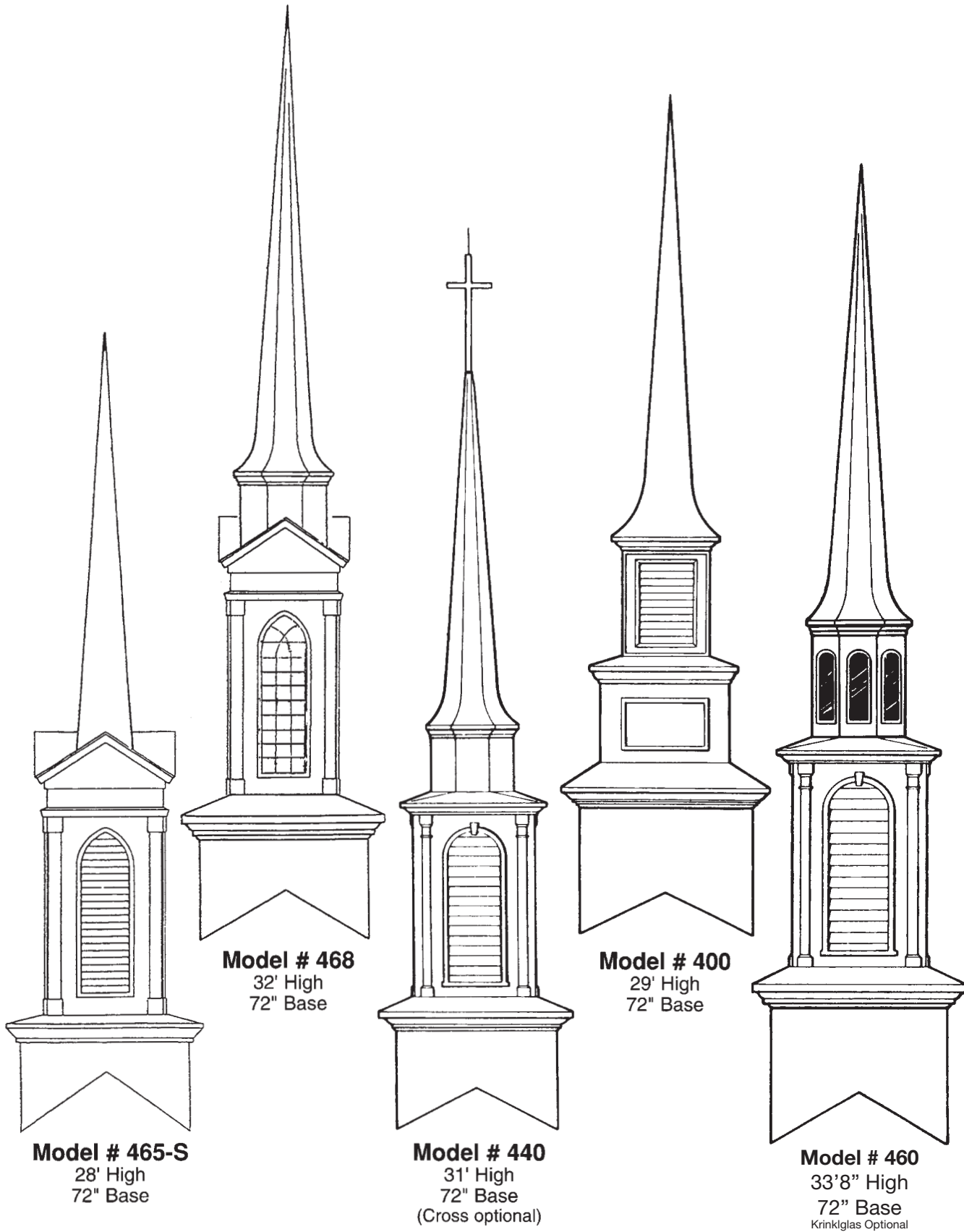

Cross, Ball and Lightning Protection Options Are Available On Any Steeple. Please See Price List.

Steeple

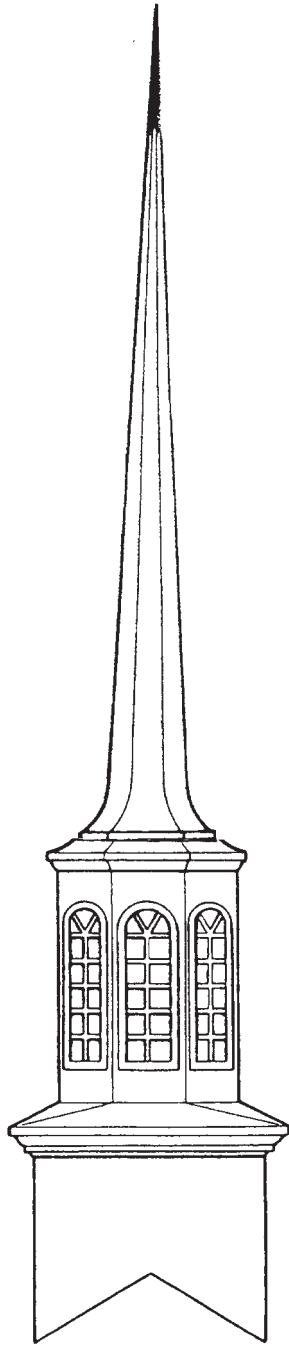

Model # 470
32' High
72" Base
Krinklglass Optional

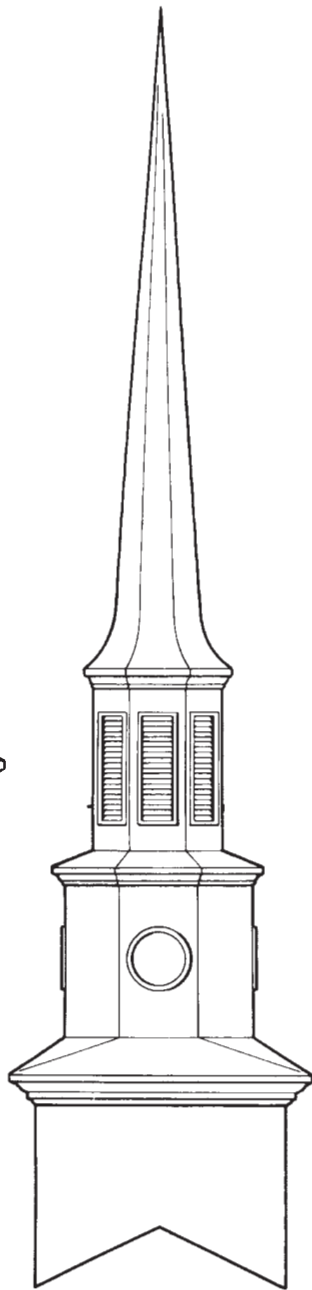

Model # 420
30'6" High
72" Base

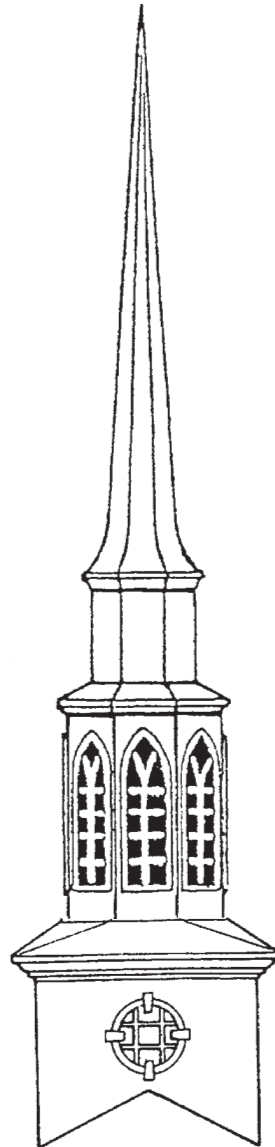

Model # 420-G
31' High
72" Base
Round key-block window optional
Krinklglass optional

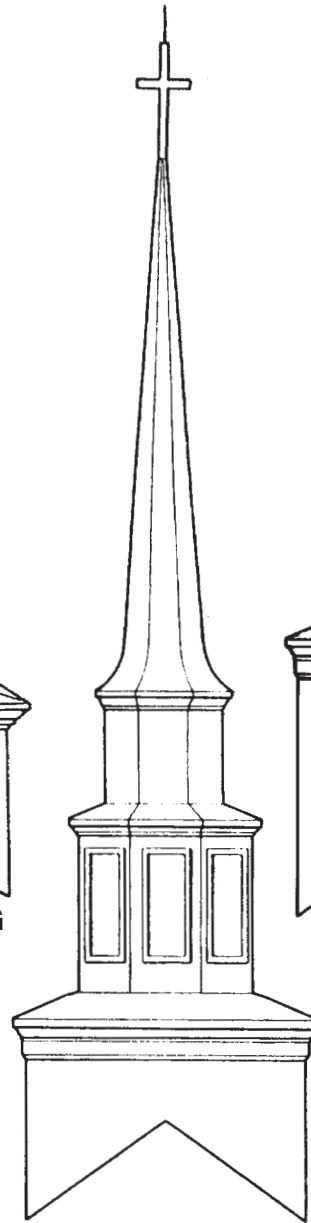

Model # 410
29' High
88" Base
(Cross optional)

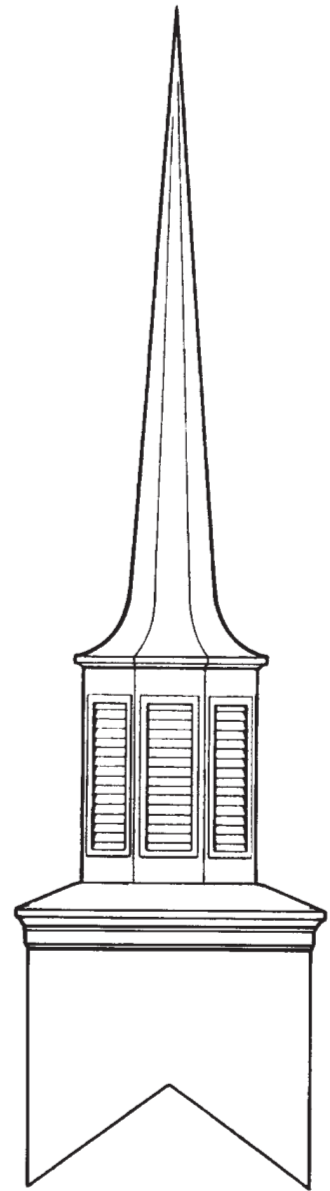

Model # 450
31' High
88" Base

Steeple

Cross, Ball and Lightning Protection Options Are Available On Any Steeple. Please See Price List.

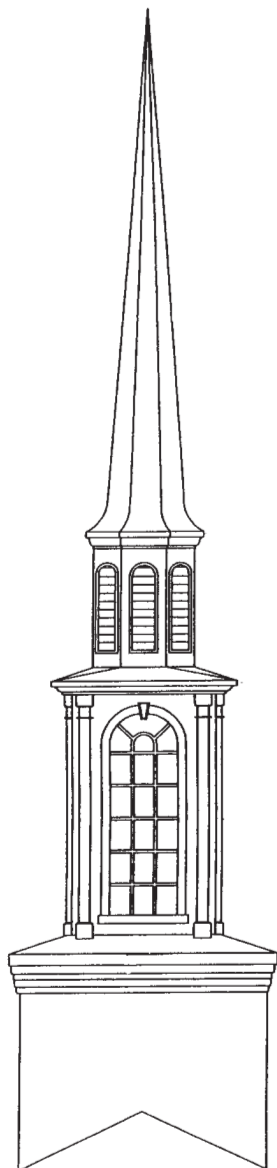

Model # 500
34'8" High
88" Base
Krinklglas Optional

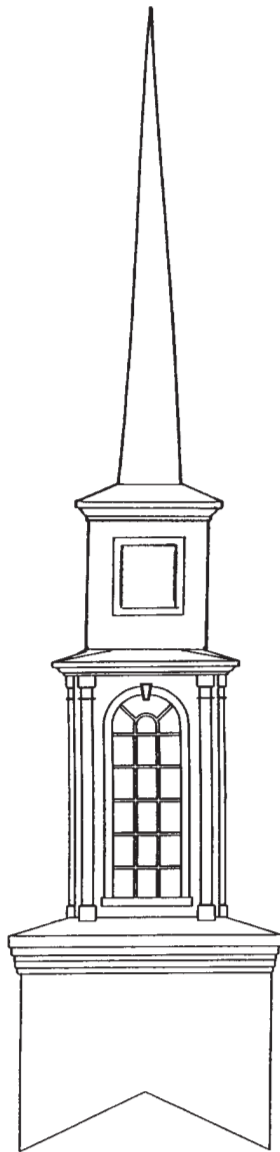

Model # 525
34' High
88" Base
Krinklglas Optional

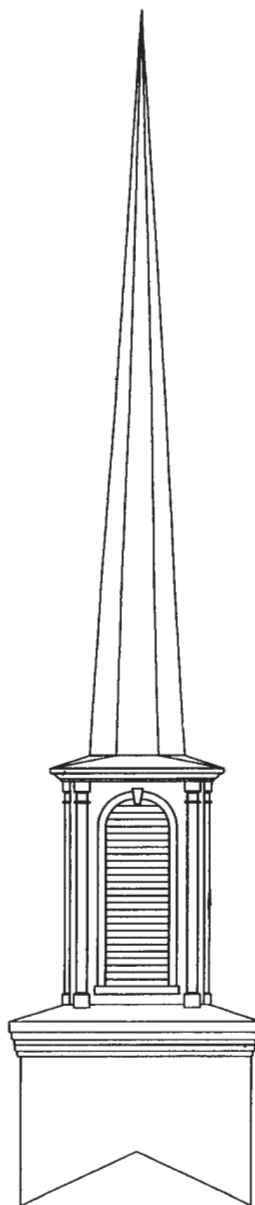

Model # 540
38'6" High
88" Base
Windows available with or without Muntins.

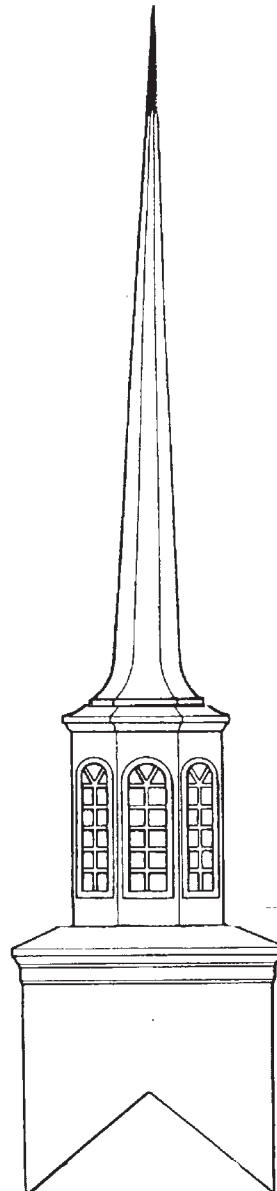

Model # 478
34' High
88" Base
Krinklglas Optional

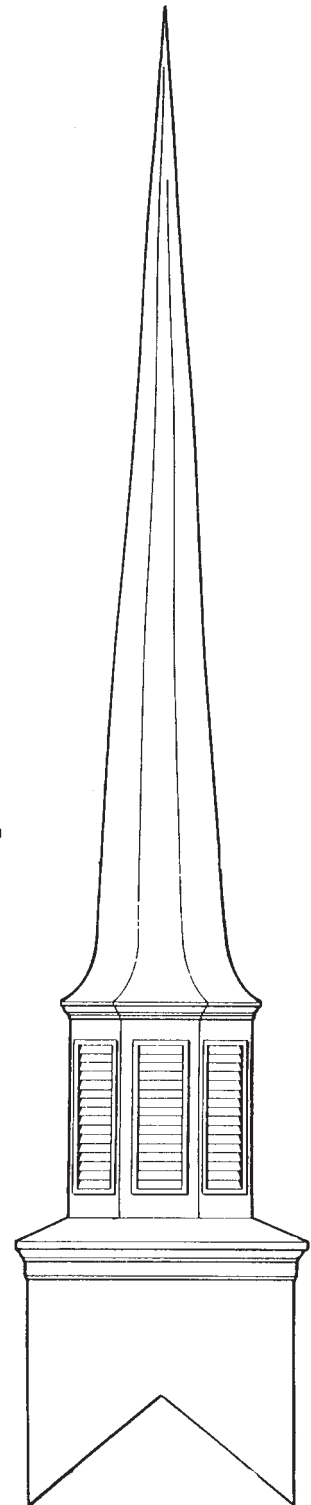

Model # 480
40' High
88" Base

Cross, Ball and Lightning Protection Options Are Available On Any Steeple. Please See Price List.

Steeple

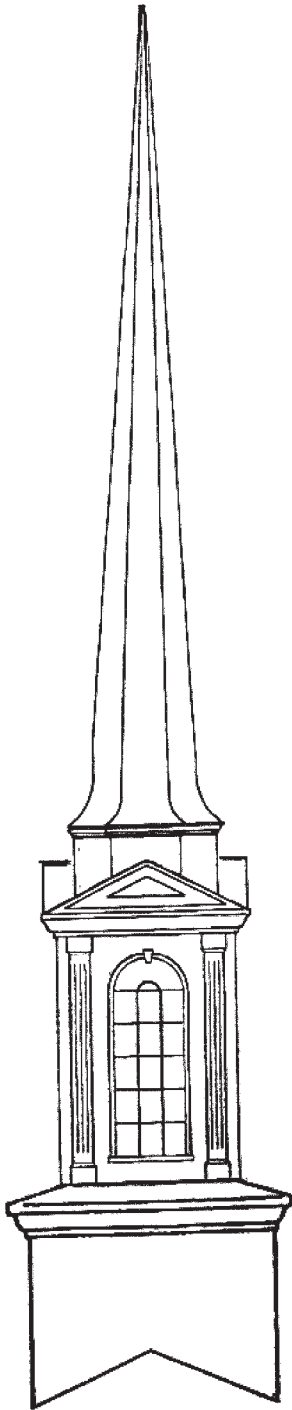

Model # 615
48' High
96" Base

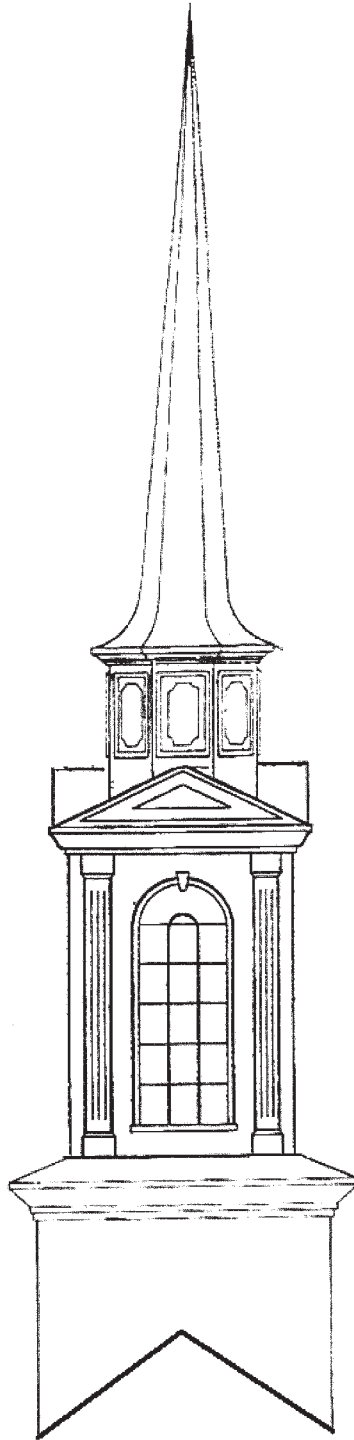

Model # 600
40' High
96" Base

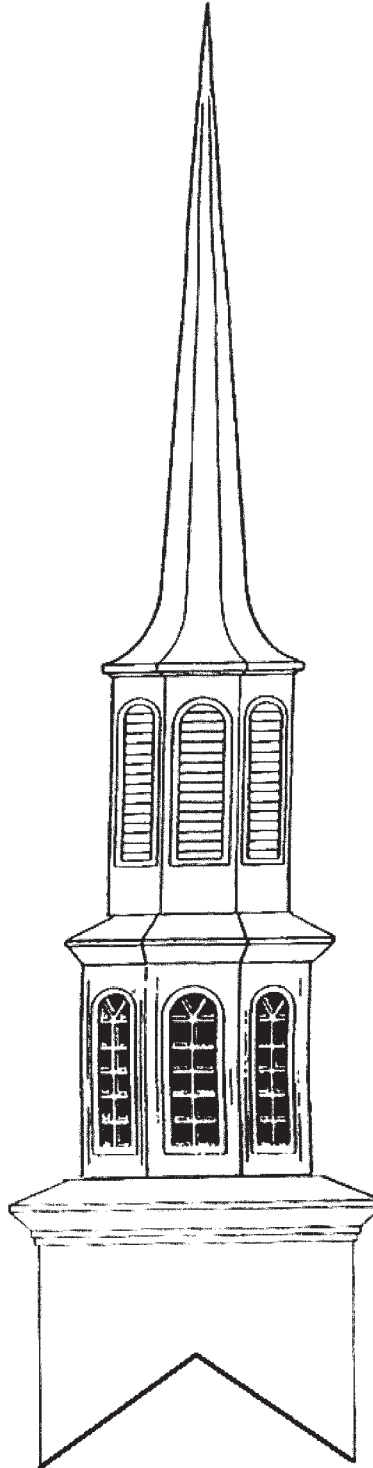

Model # 640
36' High
96" Base
Krinklglas Optional

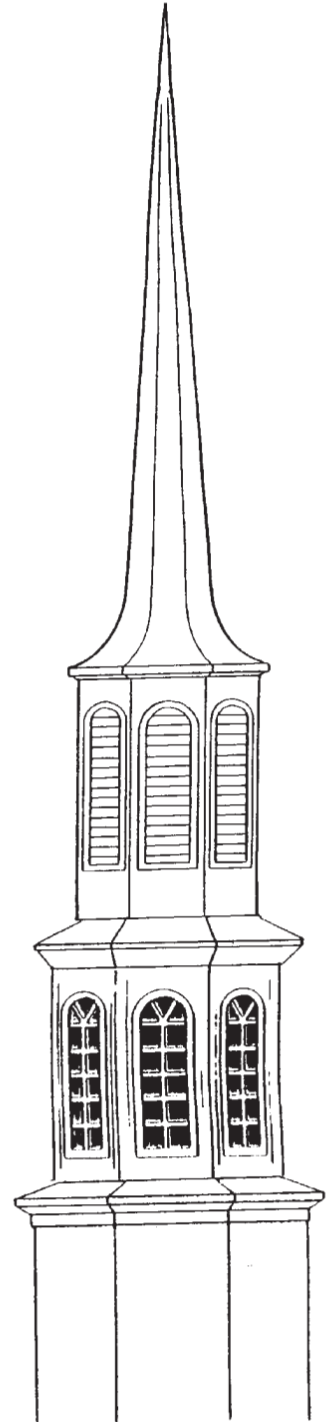

Model # 628
35' High
7'9" Octagon Base
Krinklglas Optional

Steeple

Cross, Ball and Lightning Protection Options Are Available On Any Steeple. Please See Price List.

New Models

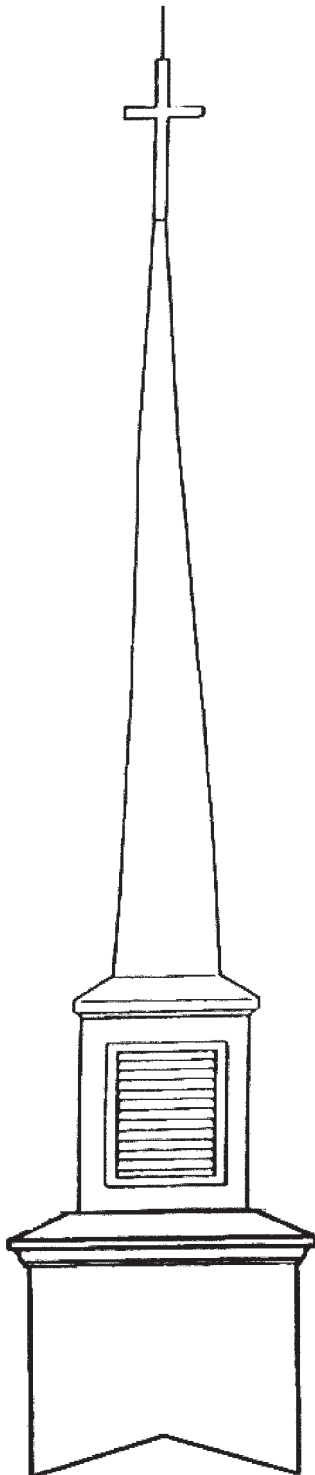

Model # 368L

26' High
60" Base
Cross Optional

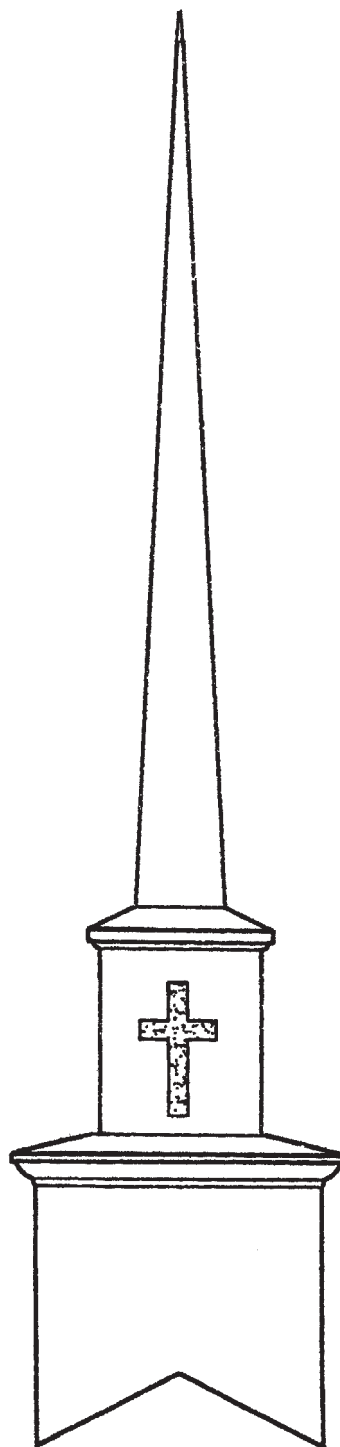

Model # 368K

26' High
60" Base
Cross Optional

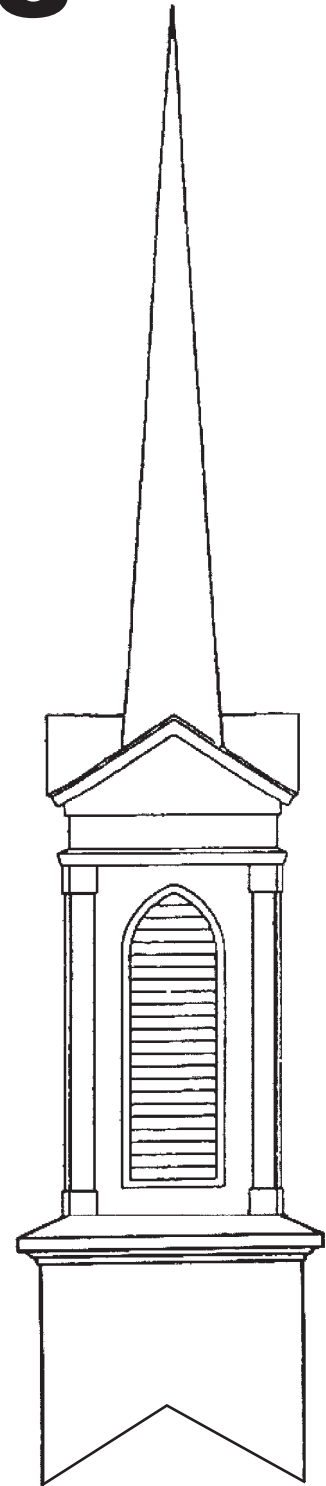

Model # 364

28' High
60" Base

Accessories

STEEPLE ACCESSORIES

- Simulated louvers
- Kringle glass window

- Venting louvers
- Decorative panels

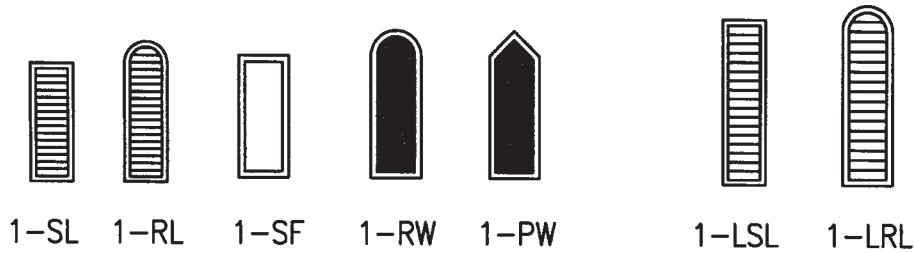

Available on Models
 295
 350
 370
 300
 320
 325
 410
 420
 460
 500

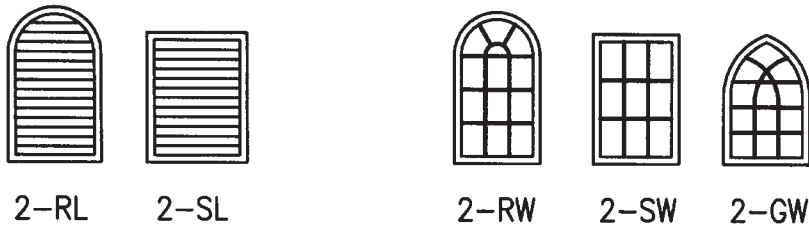

270
 275
 330
 360
 340
 400

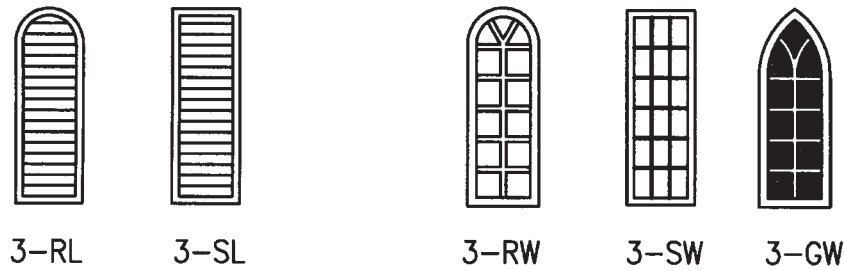

328
 390
 420
 450
 470
 480
 628



5', 6', 7', & 8'
 Base sections
 and some
 mid-section cupolas

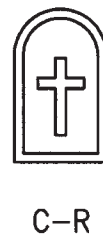
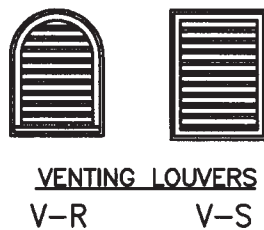
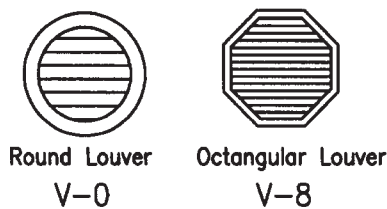

Cross or Praying Hands
 applied to "K" glass

Cupolas

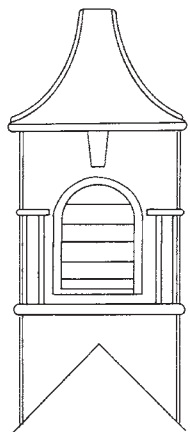

Model # C250
4' 10" High
22" Base

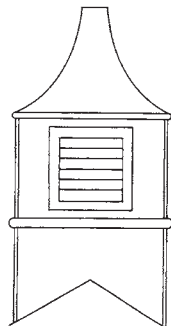

Model # C120
3' 8" High
22" Base

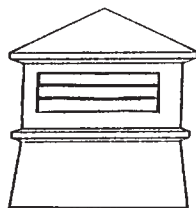

Model # C101
3' High
32" Base

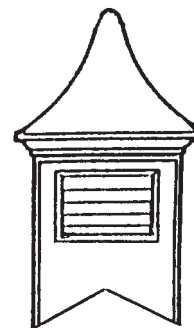

Model # C210
5' High
36" Base

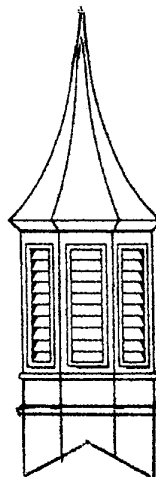

Model # C118
10' High
3' Base

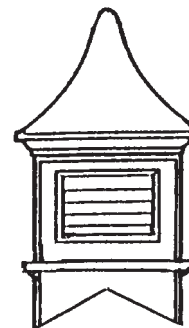

Model # C211
5' High
36" Base

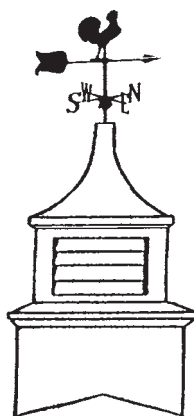

Model # C100
5' High
3' Base
Weather vane optional

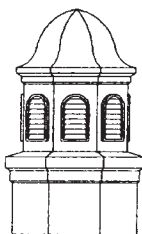

Model # C108
6' 2" High
3' Base

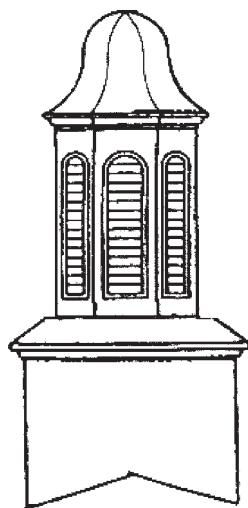

Model # C295
11' High
3'9" Base

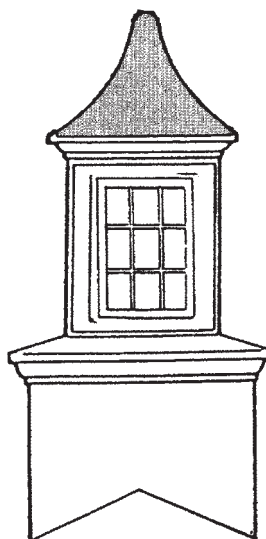

Model # C330
12' High
4'6" Base
Krinkglas Optional
Colortop Optional

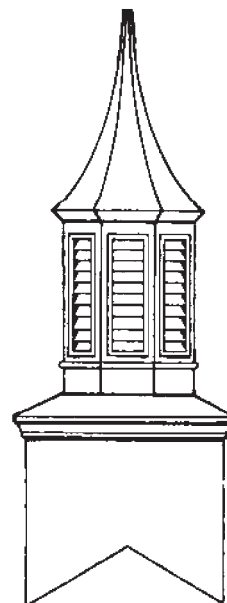

Model # C298
12' High
3'9" Base

Cupolas

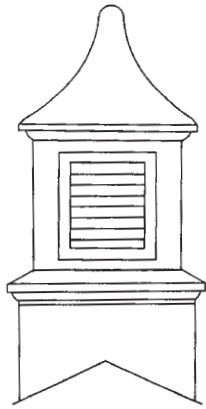

Model # C215
8'6" High
3'9" Base

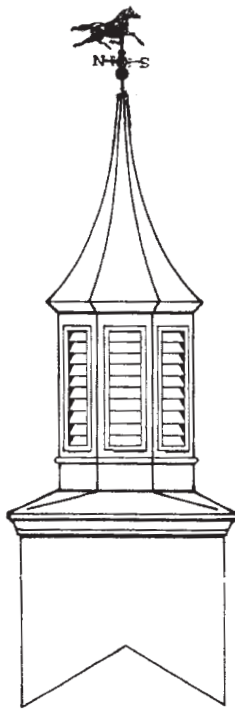

Model # C216
13' High
5' Base
Weather vane optional

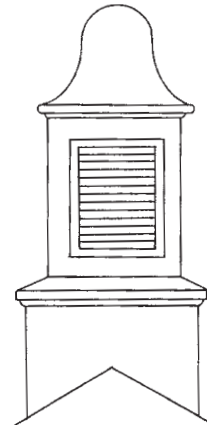

Model # C275
9'6" High
4' Base

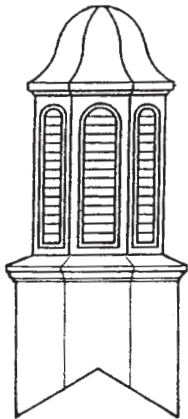

Model # C378
12' High
4'6" Base

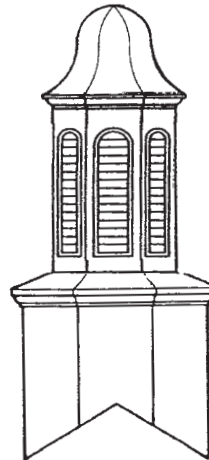

Model # C350
11' High
4'6" Base

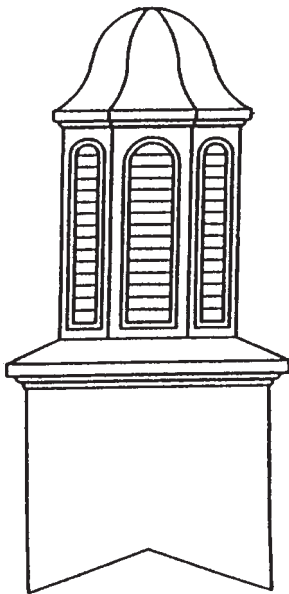

Model # C370
13' High
60" Base

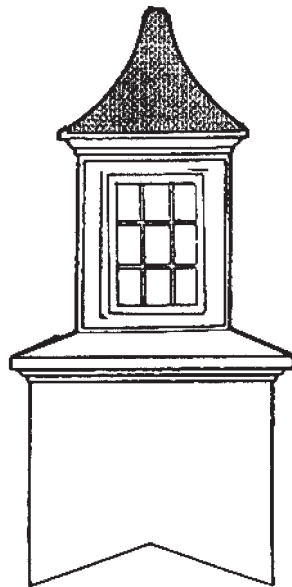

Model # C374
11' High
60" Base
Krinklglas Optional
Colortop Optional

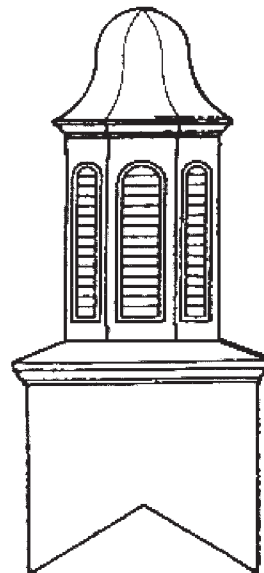

Model # C376
12' High
60" Base

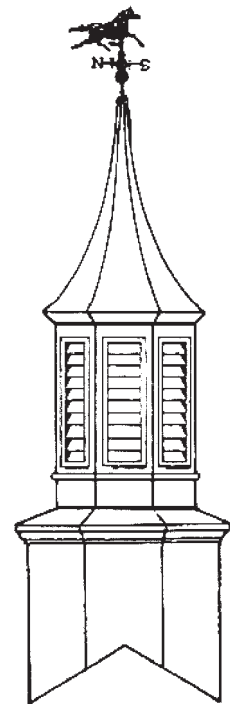

Model # C218
12' High
4'6" Base
Weather vane optional

Cupolas

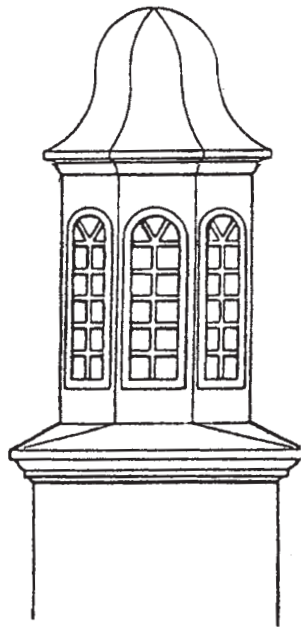

Model # C390

15' High
6' Base
Krinklglas Optional



Model # C418

Krinklglas Optional

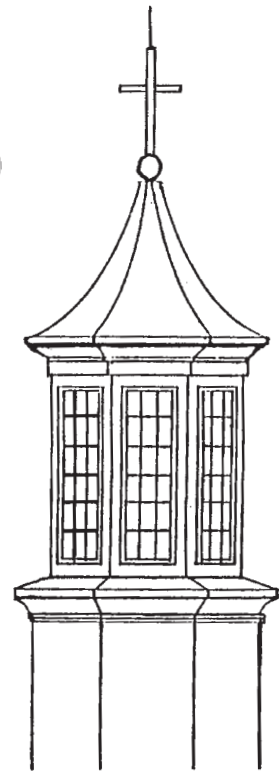

Model # C400

22'2" High
6' Base
Krinklglas Optional

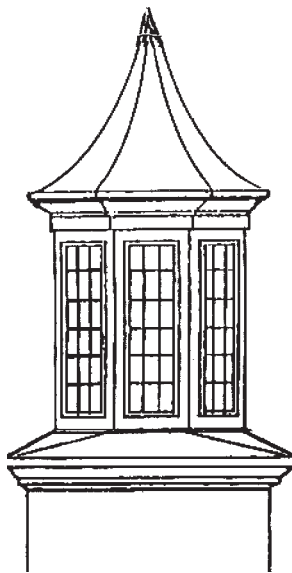

Model # C420

15' High
6' Base
Krinklglas Optional

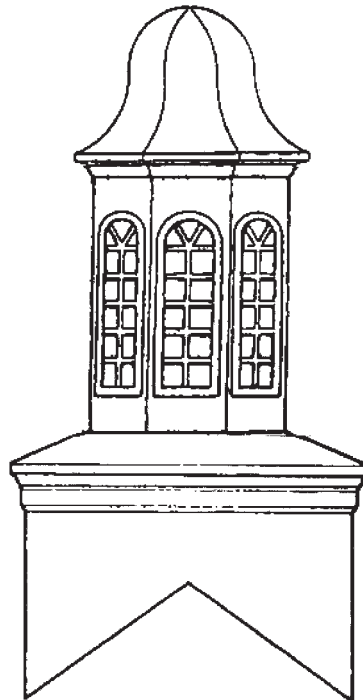

Model # C418

13' High
88" Base
Krinklglas Optional

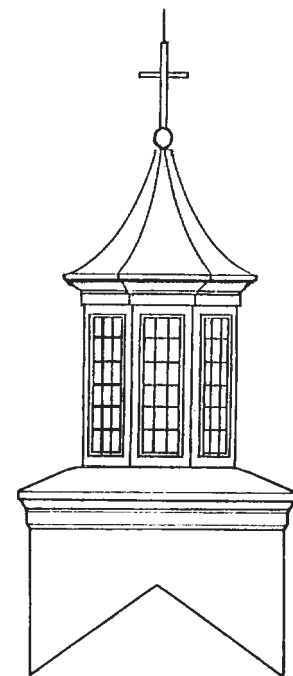

Model # C410

16' High
88" Base
Krinklglas Optional

Cross, Ball and Lightning Protection Options Are Available On Any Steeple. Please See Price List.

Steeple Options

(SEE PRICE LIST FOR ADDITIONAL OPTIONS)

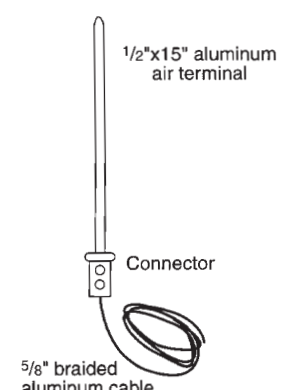
<p>OPTIONAL LIGHTNING CABLE & AIR TERMINAL</p>  <p>1/2"x15" aluminum air terminal</p> <p>Connector</p> <p>5/8" braided aluminum cable</p> <p>LIGHTNING PROTECTION KIT</p>	<p>OPTIONAL STEEPLE CROSSES</p> <table border="0"> <tr> <td data-bbox="618 459 709 619"></td> <td data-bbox="782 459 873 619"></td> </tr> <tr> <td>MODEL 2 2'x18"</td> <td>MODEL 3 3'x24"</td> </tr> <tr> <td data-bbox="618 711 709 872"></td> <td data-bbox="782 711 873 941"></td> </tr> <tr> <td>MODEL 4 4'x30"</td> <td>3' or 4' with 8" BALL</td> </tr> </table>			MODEL 2 2'x18"	MODEL 3 3'x24"			MODEL 4 4'x30"	3' or 4' with 8" BALL
MODEL 2 2'x18"	MODEL 3 3'x24"								
MODEL 4 4'x30"	3' or 4' with 8" BALL								

CROSSES

COLORS: White is standard. Crosses can be added to the top of any model steeple. The overall height of the steeple will be shortened approximately 12 to 18 inches when a cross is added. The tip of the steeple must be cut off in order to match the body width of the cross.

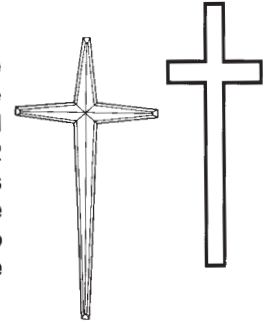

FIBERGLASS WALL-MOUNTED CROSSES: Prices include mounting brackets on all crosses which will hold the cross off the wall. If back lighting is ordered, the price includes rope lighting the full circumference of the cross.

Model B	Model SQ
4' x 2'6"	4 x 2'6"
5' x 2'6"	6 x 3'5"
6' x 3'	8 x 4'6"
8' x 4'	12 x 6'
10' x 5'	

THE SHINGLE PROTECTOR:

The shingle protector provides a layer of protection between the base of the steeple and your shingle roof. It is a 3/16" layer of fiberglass custom cut to fit your steeple.

- Allows weight of steeple to be dispersed over a larger area
- Will eliminate the possibility of the shingles being cut due to normal wind loads and settling
- Can be reused when it is time for your roof replacement



Baptistries

Model 7-A
with or without
window

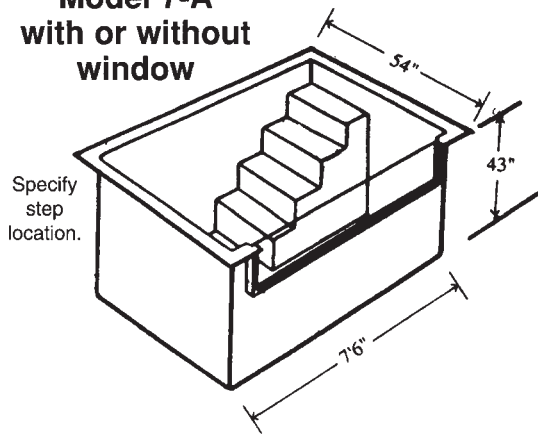

Model 8-A Dry Minister
with window only Series

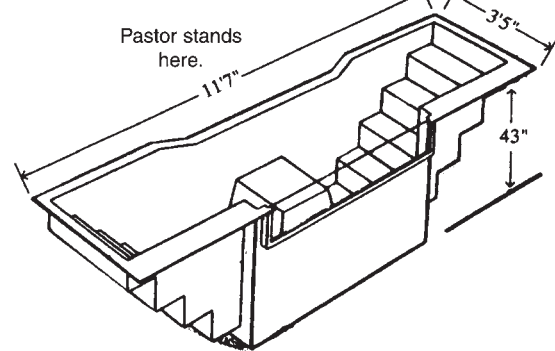

Model 9-A
with or without
window

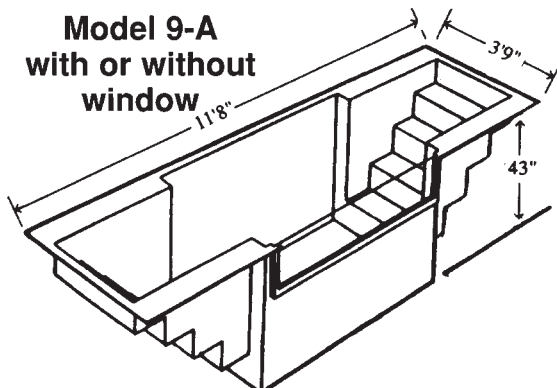

Model 10-A
with or without
window

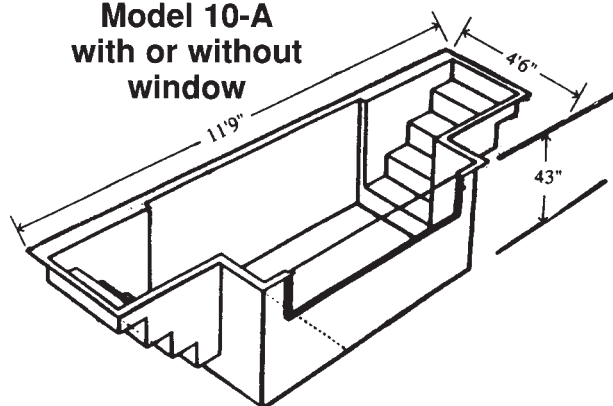

Model 11-A
with or without
window

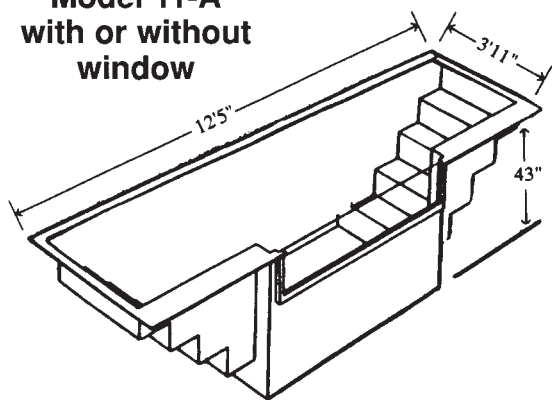

Model 11-B
with or without
window

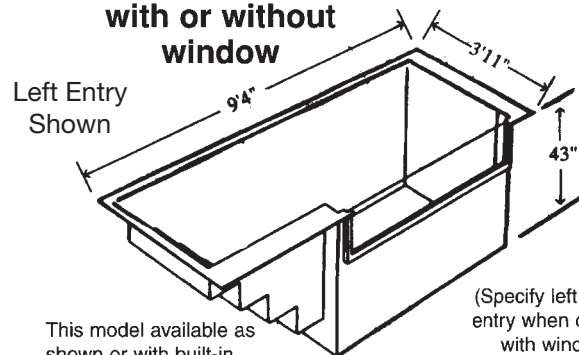

This model available as shown or with built-in seat for minister to stand behind.

(Specify left or right entry when ordering with window.)

Model 12-B
with or without
window

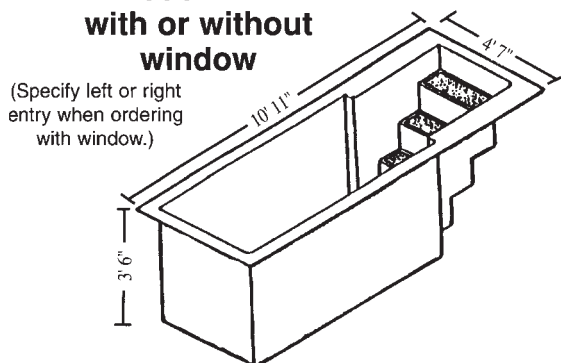

Model 13-A
with or without
window

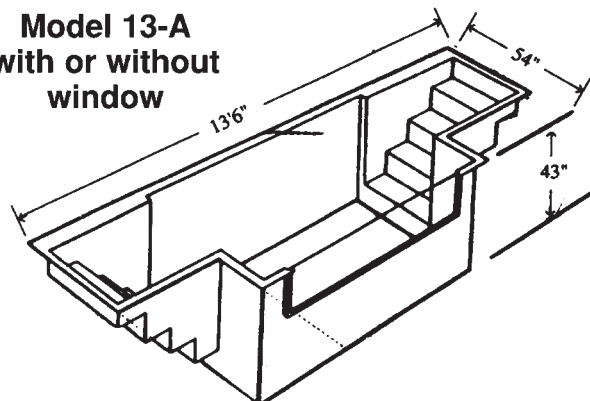

Baptistries

MODEL 14

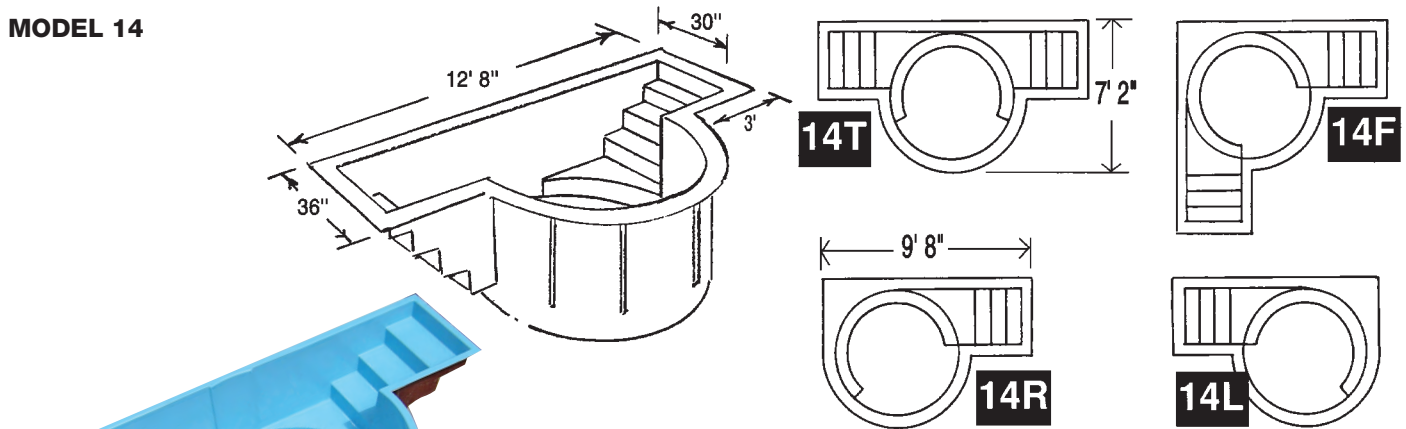

51-Inch Deck Mounted Commercial Stair Rail

MODEL 15

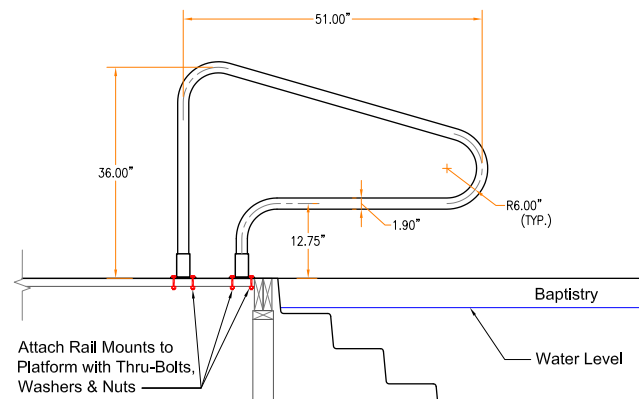
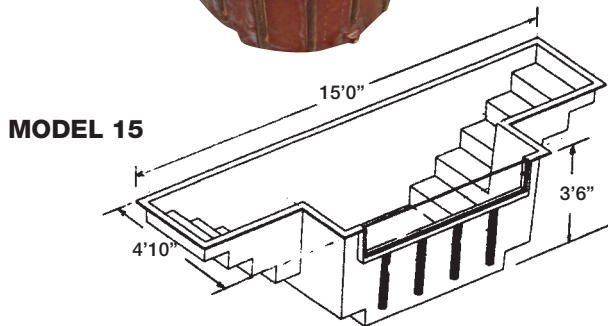

Accessories

Combination Seat/Child's Step*

*Places a child at proper height. Nonskid surface. Seat permits baptism of large adults from seated position. Complete with toe hold and easily removable when not desired.

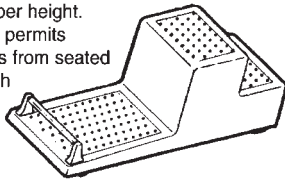

Factory Baptistry Heater Installation:

Saves you time and money
*Call for more details

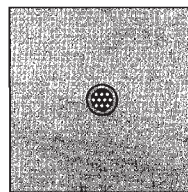
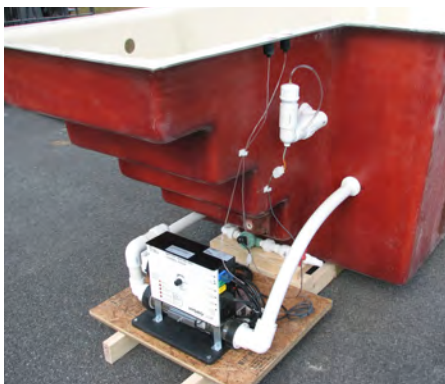

Drip Landing Model DL-90

Designed to mount at ends of baptismal pool steps for robe drainage. Sloped skid resistant floor in matching color. 40" Square

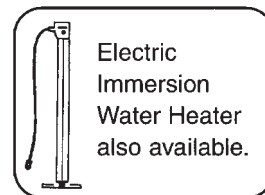

Electric Immersion Water Heater also available.

Drain, Overflow, & Release Unit

A sturdy, economical drain unit with chrome-plated fittings and an easy-access trip lever located in the overflow. Just flip the lever to drain. For 1 1/2" connections

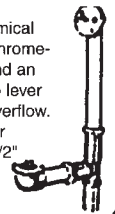

Electric Baptistry Heating Systems



Standard:

- 5.5 or 11KW Heater in 304SS Housing
- 3/4HP, 120V Pump
- Full Range Thermostat
- 50A High Current GFCI
- High Limit Protected
- Pressure Switch Activated
- Base Mounted

Exclusive:

- "VDS" Visual Diagnostics
- Heater "ON" Indicator Light
- Detailed Installation Manual
- Detailed Owners Manual
- Detailed Wiring Diagram

6P Portable "Frame only"

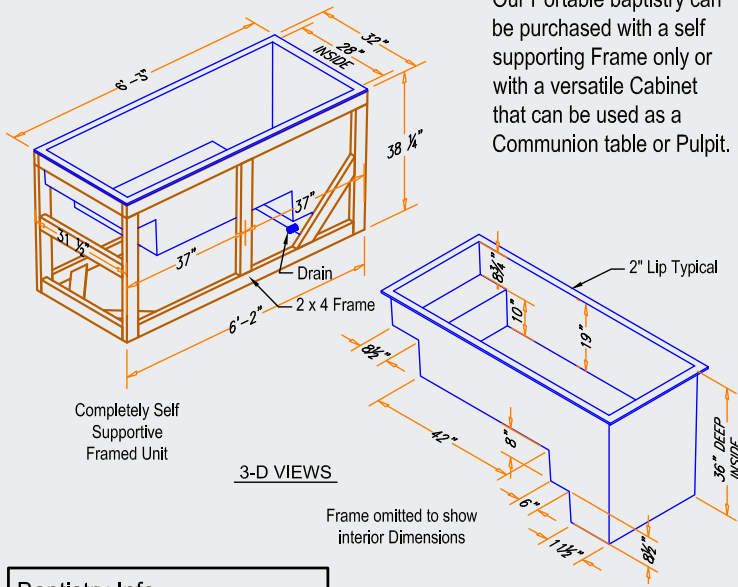

Our Portable baptistry can be purchased with a self supporting Frame only or with a versatile Cabinet that can be used as a Communion table or Pulpit.

6P Portable w/ Cabinet and Options

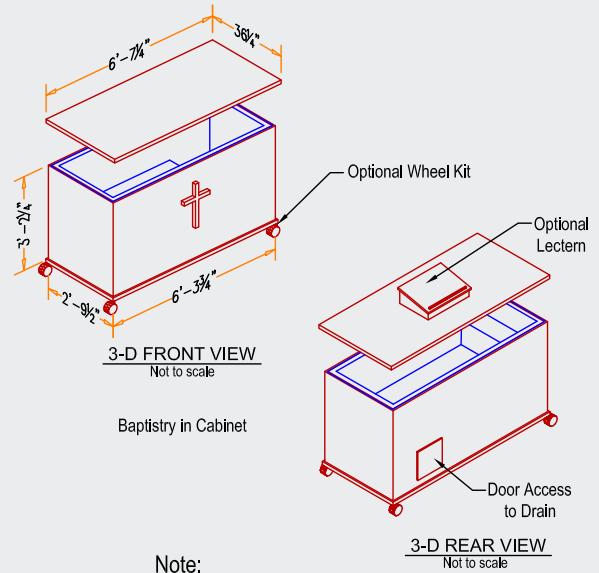

Note:
All interior corners are rounded for safety.

Baptistry Info.

Width: 32"
Length: 6'-3"
Depth: 36" inside
Water Capacity: 100 gal.
Recommended Heater: BPH10 - 110 volt.

Items included with Cabinet:

- Lid
- Cross
- Steps
- Drain

Available in Birch or Oak

Optional Finish:

2 coats of Min Wax stain
2 coats of clear polyurethane

Optional Accessories

Lectern

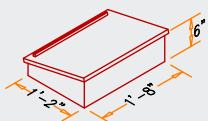

Optional Communion Front

This Do In Remembrance of Me

Wheel Kit

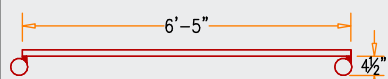

Wood Steps to Match Cabinet

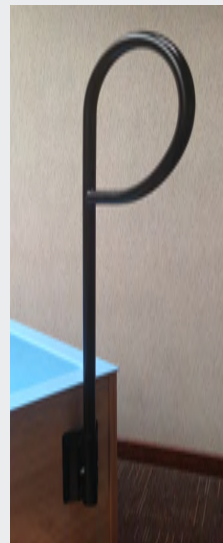
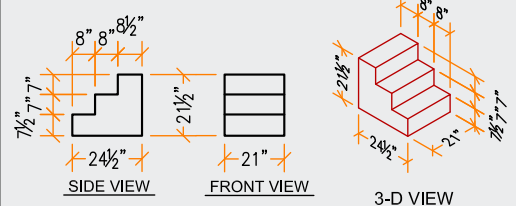

Optional Hand Rail

Portable Baptistry Heater

UL Approved
GFCI Plug

Just place in pool 24hrs prior to ceremony.
Remove during church baptismal ceremony

1000 watts, 120v, 8.3A

33" long x 2-3/4" Dia

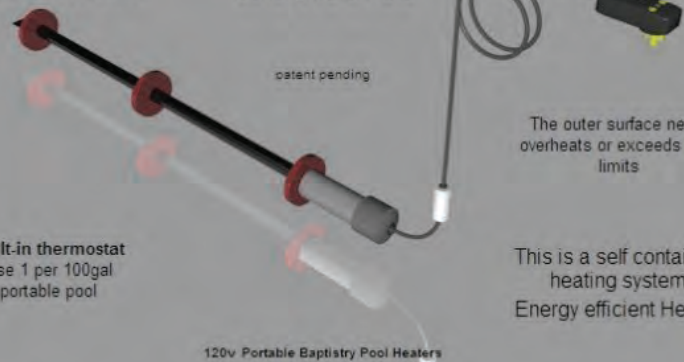

Built-in thermostat
Use 1 per 100gal
portable pool

120v Portable Baptistry Pool Heaters

Part # BPH10

