

FIELD OPS WATCH

A man in tactical gear, including a black 5.11 cap and safety glasses, is aiming a rifle with a green-tinted scope. The background is a blurred outdoor setting with warm lights.

SURESHOT[®]

BALLISTIC CALCULATOR BY 5.11

5.11 

TACTICAL SERIES[®]



- 2. INTRO
- 4. OVERVIEW
- 7. WATCH AND HOURLY
CHIME SETUP
- 10. ALARM
- 11. CHRONO AND TIMER
- 13. SURESHOT® INTRO
- 14. BALLISTICS BASICS
- 16. SURESHOT® ENVIRONMENT
AND TARGET SETTINGS
- 17. SURESHOT® RIFLE DATA
- 18. COMPASS CALIBRATION
- 20. WATCH BAND
- 22. WARRANTY AND SERVICE
- 25. WARRANTY SERVICE FORM



SET
(A)



+/EL
(D)



COMPASS
(E)



SELECT
(C)



-
(B)



Hourly Chime Icon



Alarm ON Icon



Sniper Mode Icon

Watch Features:

3 Time Zones - Home, T2, T3

Calendar

Chronograph/Alarm/Timer

SureShot® Ballistic Calculator

Field Ops Compass

Bezel Face



Basic Display Modes:

Press A to toggle between watch and SureShot® mode

Press and hold A to enter Setup modes

Press C to scroll through menus

Press E to enter Compass mode

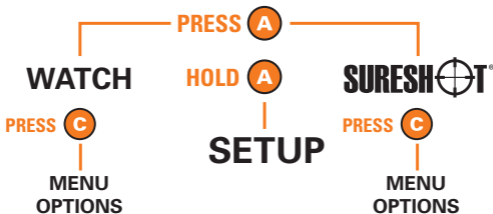

PRESS E GO TO COMPASS

HOLD = DEPRESS BUTTON FOR 2 SECONDS.

EL Back-Light:

Press D and watch will illuminate for 10 seconds.

Press D again to immediately switch off the light.

(It is advisable to turn off the light whenever possible to conserve battery life.)

WATCH OVERVIEW

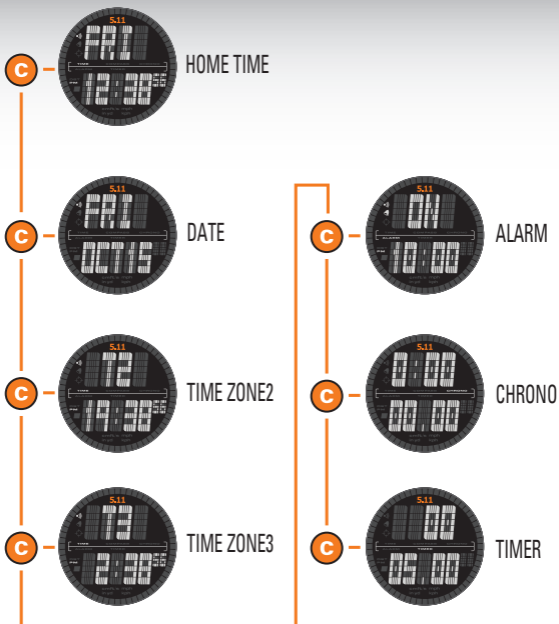

SURESHOT® OVERVIEW

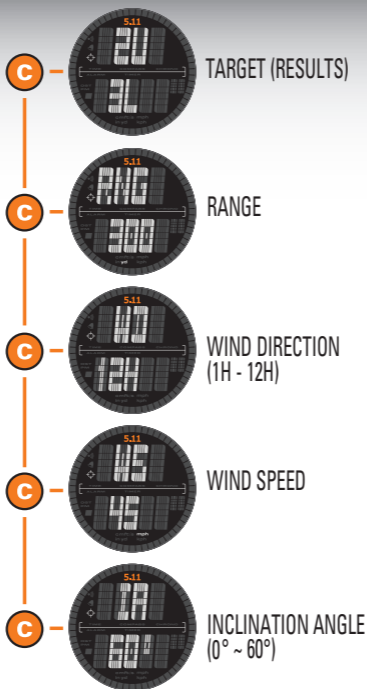

COMPASS OVERVIEW



PRESS **E** GO TO COMPASS

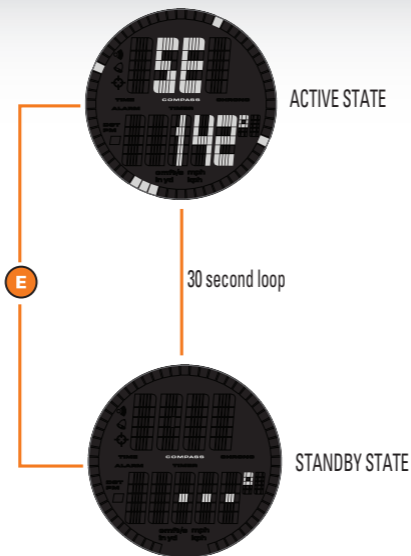

PRESS **A** to exit compass and return to HOME TIME

WATCH SETUP: TIME



HOME TIME

HOLD **A**



PRESS **C**
to click through
setup options

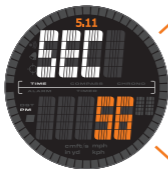

PRESS **D**
to increase value



PRESS **B**
to decrease value

HOURLY CHIME

In HOME TIME mode:
Press **B** to toggle the
hourly chime (🔔) on/off

HOLD **A**
to exit setup
and return to
HOME TIME

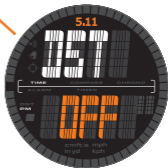

WATCH SETUP: DATE



DATE MODE

HOLD **A**



HOLD **A**
to exit setup
and return to
DATE

PRESS **C**
to click through
setup options

PRESS **D**
to increase value

PRESS **B**
to decrease value

WATCH SETUP: TIME 2 AND TIME 3

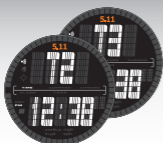

TIME 2 & TIME 3

HOLD **A**



PRESS **C**
to click through
setup options



PRESS **D**
to increase value

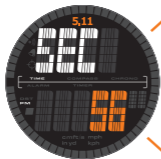

PRESS **B**
to decrease value



HOLD **A**
to exit setup
and return to
TIME



ALARM SETUP



ALARM

HOLD **A**



HOLD **A**
to exit setup
and return to
ALARM

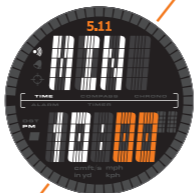

PRESS **C**
to click through
setup options

PRESS **D**
to increase value

PRESS **B**
to decrease value



In ALARM mode: Press **B**
to toggle the alarm (🔊) on/off

Note: Alarm icon appears on screen when activated.



PRESS **B**
to start/stop

CHRONOGRAPH



HOLD **B**
to clear
and reset

TIMER



TIMER

PRESS B
to start/stop

HOLD B
to reset

HOLD A
to enter
TIMER setup

PRESS C
to click through
setup options

PRESS D
to increase value

PRESS B
to decrease value

HOLD A
to exit setup
and return to **TIMER**



HOUR



MINUTE



SECONDS



5.11® has partnered with Horus Vision to bring their popular software to you in a convenient and discreet multifunctional watch platform. Extensive development and field testing ensure that the software works with equal precision in our watches.

Popular among law enforcement and military snipers, hunters, and long range shooting enthusiasts, Horus Vision's unique software enables shooters to accurately calculate their bullet's trajectory and drop at extended ranges, up to and beyond 1000 yards.

This product is produced under license from Horus Vision, LLC and is protected by U.S. Patents 6,681,512, 6,516,699, 6,453,595, 6,032,374, and 5,920,995, as well as other pending patents.

WARNING:

THE TECHNOLOGY PROVIDED BY THIS WATCH IS NOT INTENDED TO, AND IT CANNOT REPLACE, SHARPSHOOTING TRAINING AND EXPERIENCE, NOR IS IT INTENDED OR ABLE TO ADDRESS ALL VARIABLES THAT MIGHT AFFECT ANY GIVEN SITUATION. RELYING UPON THE WATCH'S TECHNOLOGY WITHOUT EXTENSIVE TRAINING AND EXPERIENCE AND WITHOUT CAREFULLY CONSIDERING AND ACCOUNTING FOR ALL RELEVANT CIRCUMSTANCES AND FACTORS COULD RESULT IN SERIOUS INJURY OR DEATH.



Temperature: As air temperature increases, air density decreases. And as air density decreases it offers less resistance against your bullet's flight which can affect the bullet's point of impact.

Bore Height: The distance between the center of your bore and the center of your scope. It is expressed as inches and tenths, eg 1.7 inches. It is not the height of your rings. Your scope should be mounted as low as possible to the barrel, but not touching.

Ballistic Coefficient: This is the efficiency of the bullet as it travels through space. This information is available for popular match type bullets from quality bullet manufacturers. It is typically expressed like .533. Many bullet manufacturers post the Ballistic Coefficient data on their web site, or check your reloading books.

Muzzle Velocity: This is the speed at which the bullet leaves the barrel of your rifle. This number is the average of a series of bullets fired through a chronograph. Typically a group of 10 shots provides a good average. That number is expressed in FPS, or Feet Per Second.

Zero Range: This is the range at which you have zeroed your rifle.



Display: You have the option of displaying your bullet's point of impact in Mildots, SMOA or TMOA. We recommend that you begin with SMOA. Once you understand the concept and application you will be better informed to select between Mildot, SMOA and TMOA.

Clicks: Most scopes have quarter-minute clicks (4 clicks of adjustment within an inch at 100 yards). Some scopes offer eighth-minute clicks, while some may even offer half or third-minute clicks. Select the appropriate number of clicks per minute.

Units: Select from English or Metric units.

SIDEBAR: In order for the 5.11 Field Ops watch to calculate your bullet's trajectory with any reliability, your rifle and you need to be capable of "1 MOA" shooting. That is you need to be able to shoot a 1-inch group at 100 yards. MOA means "Minute of Angle" and is approximately 1" at 100 yards. MOA is further expressed as SMOA ("Shooter's Minute of Angle") and ("True Minute of Angle"). TMOA is true minute of angle and equals 1.047 inch drop at 100 yards. To make the math easier, some scope manufacturers use SMOA or Shooters minute of angle = 1 inch drop at 100 yards. Mildot is another popular unit of measure for tactical and long-range shooters.

SURESHOT® ENVIROMENT AND TARGET SETTINGS

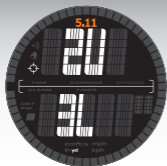

SURESHOT™
RESULTS

PRESS **C**



RANGE



WIND DIRECTION

PRESS **A**
to exit setup
and return to
HOME TIME



WIND
SPEED

PRESS **C**
to click through
setup options

PRESS **D**
to increase value

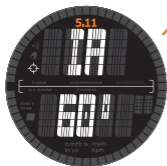

INCLINATION ANGLE

PRESS **B**
to decrease value

Note: During any programming mode, hold **C** to immediately return to the Target Results screen.

SURESHOT® RIFLE DATA

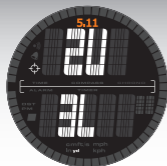

SURESHOT™
RESULTS

HOLD **A**
to enter
setup



TEMPERATURE

ALTITUDE



UNITS



PRESS **C**
to click through
setup options

BORE HEIGHT



CLICKS



BALLISTIC
COEFFICIENT



DISPLAY



PRESS **D**
to increase value

PRESS **B**
to decrease value

MUZZLE
VELOCITY



ZERO RANGE



HOLD **A**
to exit setup
and return to
RESULTS



Compass Calibration:

To ensure that your compass is providing an accurate result, or if your compass displays an ERROR message, follow these steps to calibrate your compass.

While in Compass

Mode HOLD **A**



MAGNETIC DECLINATION SETTING

Q : Why set the magnetic declination?

A : Compass usually indicates the direction of magnetic north. However, magnetic north is not true north. In order to make the compass indicate true north, the magnetic declination should be set to compensate for the difference between magnetic north and true north.

PRESS **D**

to increase value

PRESS **B**

to decrease value

PRESS **E**

to confirm and go to **COMPASS**

PRESS **C**

calibrate compass



CALIBRATION STATE



Compass Calibration:

Place the watch on a flat, level surface. The digital bezel will animate clockwise. Rotate the watch one rotation per minute for two-to-three minutes. The watch will pause after each minute, then restart the bezel animation.

After three minutes, the watch will run a data check to ensure that the calibration is complete.

During any point in this calibration, pressing **C** will confirm calibration and the watch will attempt to run a data check.

If the data check is correct the compass will state: "CAL DONE". If the data check is not correct, the compass will state: "CAL ERROR", or "TRY AGAIN".



TO CHANGE OR REPLACE STRAP

Use the 5.11® strap tool (included) and follow the diagrams below.

When tightening screws, be sure to carefully screw and tighten to a firm but not forced end - Do not over tighten the screw.

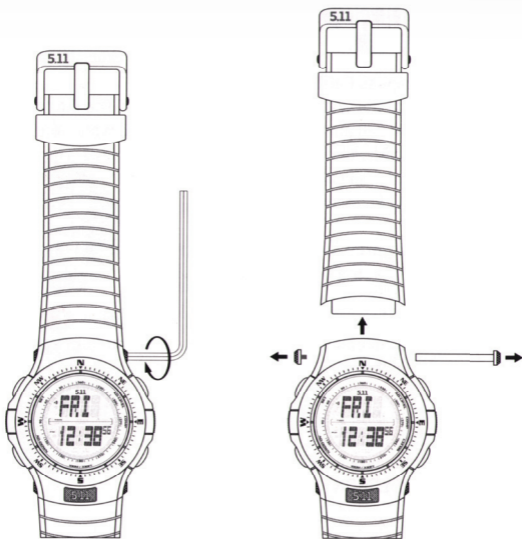

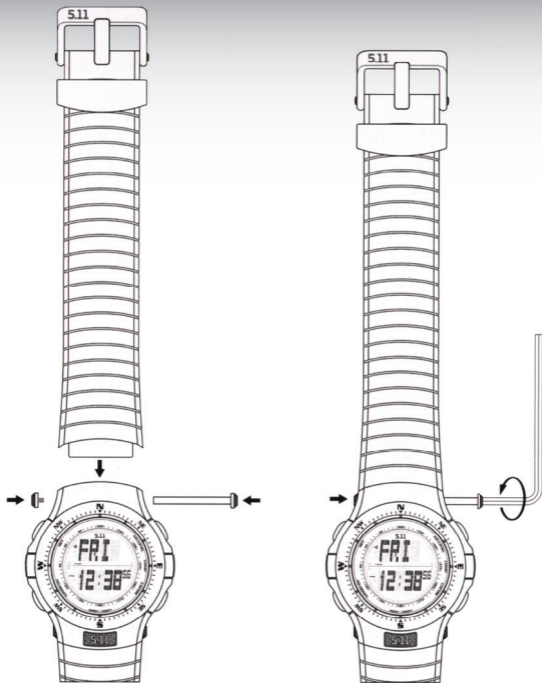



Scope of Warranty

5.11, Inc. ("5.11") warrants each watch sold by 5.11 or its authorized dealers ("Product") to be free of defects in materials or workmanship for two (2) years, or for the maximum period allowed by the laws of your jurisdiction, if less.

Exclusions from Coverage

Excluded from coverage under this warranty are the following:

- Products purchased other than from 5.11 or from an authorized 5.11 dealer.
- Damage resulting from abuse or misuse.
- Damage resulting from extended wear and tear.
- Damage resulting from opening, tampering, or a customer modification.
- Damage resulting from attempted service or repairs by an unauthorized service provider.
- Damage resulting from exposure to a caustic substance.
- Consequential, incidental, indirect, punitive, exemplary, and/or special damages (although some states in the United States do not allow the exclusion or limitation of consequential or incidental damages, so this exclusion might not apply to you).

This warranty is the exclusive warranty provided by 5.11 relating to the product and, to the maximum extent permitted by law, 5.11 disclaims all other express or implied warranties.



State and International Laws

This warranty gives you specific legal rights, and you may also have other rights which vary from state to state in the United States and in other countries.

What You Will Need to Do

If 5.11 determines that the Product is defective, 5.11 will either replace the Product or repair the Product. All determinations made by 5.11 will be within 5.11's sole discretion and will be final.

All warranty claims **MUST** include a purchase receipt that clearly shows the purchase date. Packaging or this instruction booklet is **NOT** proof of purchase from an authorized dealer.

We will always do our best to ensure your watch is repaired with the utmost care and consideration. In some cases, however, discontinued styles may not be repairable as the parts may be obsolete and not available. If we cannot repair your part with an exact match, we will offer you a comparable part in its place.

All returns by 5.11 in the United States will be sent using ground shipping; shipments being returned to a P.O. Box will be made using U.S. Mail. All returns to international customers will be sent using standard shipping.

WARRANTY SERVICE



If you have a warranty claim, please contact 5.11 for a Return Authorization (RA) number at the address below. Watches received at our authorized service facility without RA numbers will not be repaired under the terms of the warranty. Do not send your watch to 5.11 for service or repair.

5.11, Inc.
4300 Spyres Way
Modesto, CA 95356
Phone: 209-527-4511
Toll Free: 866-451-1726
Fax: 209-527-1511
Email: customerservice@511tactical.com

If you need service or repairs not covered under the warranty, please contact our authorized service facility for an estimate of the cost and time for the work requested:

Watch Service Company
3443 S. State Street #5
Salt Lake City, UT 84115
Toll Free: 877-972-8463
Email: info@watchservices.com

WARRANTY CLAIM FORM



Include this completed warranty claim form when you send your watch to our authorized service facility for warranty repairs.

NAME:

RETURN ADDRESS:

DAYTIME PHONE:
WITH AREA CODE

E-MAIL:

AUTHORIZATION
NUMBER:

BRIEF DESCRIPTION OF PROBLEM: