

PF Controllers

Power Quality Solutions



PF Controllers BR604 and BR6000 Series

Intelligent • User-friendly • Cost-effective • Version 6.0

SABA KHAZEN

Selection table				
	BR604	BR6000-R6 ¹⁾	BR6000-R12 ¹⁾	BR6000-T6
Ordering code	B44066R6004E230	B44066R6006E230	B44066R6012E230	B44066R6106E230
		BR6000-R6/HD	BR6000-R12/HD	
Ordering code		B44066R6506E230	B44066R6512E230	
Supply voltage	230 V AC	110 ... 230 V AC		
Measurement voltage range	= supply voltage: 230 V AC (L-N)	30 ... 525 V AC (L-N) or (L-L)		
LCD illumination	no	yes	yes	yes
Plain language	English / German / Portuguese / Spanish	Czech / Dutch / English / French / German / Polish / Portuguese / Russian / Spanish / Turkish		
Number of relay outputs	4	6	12	–
Number of transistor outputs	–	–	–	6
Alarm output	no	yes	yes	yes
• Insufficient compensation	n/a	yes	yes	yes
• Overcompensation	n/a	yes	yes	yes
• Under-/overvoltage	n/a	yes	yes	yes
• Overcurrent	n/a	yes	yes	yes
Automatic initialization	n/a	yes	yes	no
Parameters displayed				
• System voltage	yes	yes	yes	yes
• Reactive power	yes	yes	yes	yes
• Active power	yes	yes	yes	yes
• Frequency	no	yes	yes	yes
• THD-V, THD-I	no	yes	yes	no
• Energy	no	yes	yes	yes
• Individual harmonics up to 19th	no	yes	yes	no
• Monitoring of individual capacitor currents	no	yes	yes	no
• Apparent power	yes	yes	yes	yes
• Apparent current	yes	yes	yes	yes
• Temperature °C / °F)	no	yes	yes	yes
• Real time cos φ	yes	yes	yes	yes
• Target cos φ	yes	yes	yes	yes
• kvar value to target cos φ	yes	yes	yes	yes
Recall recorded values				
• Number of contactor switching operations	no	yes	yes	no
• Maximum voltage	yes	yes	yes	yes
• Maximum active power	yes	yes	yes	yes
• Maximum reactive power	yes	yes	yes	yes
• Maximum value of harmonic	no	yes	yes	no
• Maximum apparent power	yes	yes	yes	yes
• Maximum temperature (°C)	no	yes	yes	yes
• Operation time of all capacitors	no	yes	yes	no
Switching and discharge time range	1 ... 255 seconds	1 ... 1200 seconds		20 ... 1000 ms
Number of control series	23 series preset	20 series preset and control series editor for free programming		
Weight	0.5 kg	1 kg		
Dimensions	100 x 100 x 40 mm	144 x 144 x 55 mm		
Suitable for dynamic PFC	no	no	no	yes

¹⁾ For types with OLED-display, please contact our local sales office.

PF-controllers BR7000-I Series

Intelligent • Cost-effective • Standard, mixed and dynamic compensation

SABA KHAZEN

General

The PF controller-series BR7000-I features all characteristics of the well proven BR6000 series in combination with the advantages of a better visualization of the BR7000 series. Some additional innovative characteristics offer the possibility of customized PFC solutions.

The new series BR7000-I-TH and BR7000-I-TH/S485 with 12 relay and 12 transistor outputs are perfectly suited for dynamic and mixed compensation. The BR7000-I-TH/S485 with its additional RS485 interface allows controlling of up to 32 thyristor modules type TSM-LC-S.



BR7000-I

Features

- Intelligent control
- Menu-driven handling, plain language: CZ/EN/ES/FR/GER/NL/PL/PT/RU/TR
- Self-optimizing control capability
- Automatic initialization
- Test-run possible
- Large voltage measuring range
- Recall function for recorded values
- Four quadrant operation (e.g. standby generator)
- Powerful alarm output
- Second parameter set
- Control series editor
- Detailed expert modes
- Controlling of inductive compensation systems possible
- Large number of system parameters displayed:
 - System voltage (V AC)
 - Reactive power (kvar)
 - Active power (kW)
 - Frequency
 - Apparent power (kVA)
 - Apparent current (A)
 - Temperature (°C)
 - Real-time cos-φ
 - Target cos-φ
 - kvar value to target cos-φ
 - Energy
 - Odd Harmonics (3rd ... 33th) V (%), I (%)
 - Even and odd harmonics (2nd, 3rd, 4th – 17th)

- Extended supply voltage 110 ... 230 V
- BR7000-I-TH and BR7000-I-TH/S485 for mixed and dynamic compensation
- BR7000-I-TH/S485 for direct triggering of up to 32 thyristor switches TSM-LC-S at the bus

Additional characteristics

- Large graphical display (128 x 64 dots) – like PF controller series BR7000
- HELP-button for context related help text
- ESCAPE-button allows backspace whilst navigating in the menu
- Outputs:
 - BR7000-I: always 12 relay outputs, 1 alarm relay
 - BR7000-I/TH and BR7000-I/TH/S: 12 relay and 12 transistor outputs, 1 alarm/fan relay output
- 3-digit display of the power factor (cos-φ)/switchable display as tan-φ

- Display-Mode:
 - Simultaneous large display of 3 measuring values for additional usage as measuring and display device; the desired display values editable
 - Uneven harmonics measurable up to 33rd harmonic
 - Even harmonics measurable up to 16th harmonic
 - Graphical display of selected harmonics as bar graph
 - Message/alarm relay programmable with shutter or opener function
- Code number (Password) programmable by the customer
- Update firmware possible

The version BR7000-I/S485 and BR7000-I-TH/S485 even allow visualization, programming and data proceeding via PC with evaluation software BR7000-SOFT included in the delivery. These types feature an additional external input (function programmable for example for a 2nd parameter set and additional freely programmable message relay (e.g. for fan or status message). The serial interface RS485 can be used for controller coupling or embedding into networks.

PF-controllers BR7000-I Series

Intelligent • Cost-effective • Standard, mixed and dynamic compensation

SABA KHAZEN

Technical data			
	BR7000-I	BR7000-I/S485	BR7000-I-TH BR7000-I-TH/S485
Operating voltage	110 ... 230 V AC +/- 15%, 50 and 60 Hz		
Measuring voltage	30 ... 440 V AC (L-N); 50 ... 760 V AC (L-L); 50/60 Hz		
Measuring current	X:5A / X:1A selectable		
Power consumption	< 5 VA		
Sensitivity	50 mA/10 mA		
Switching outputs			
Relay outputs	12		12
Transistor outputs	–		12
Alarm relay	1		1
Switching power of relays	250 V AC, 1000 W		
Number of active outputs	programmable		
Operation and display			
Display	illuminated full graphic display 128 x 64 dots		
Menu languages	CZ/EN/ES/F/GER/NL/PL/PT/RU/TR		
Freely editable control series	1 via Editor		
Control			
Control principle	sequential switching, circle switching, intelligent switching behavior, 4-quadrant operation		
Automatic initialization/test-run	possible		no
Target cos-φ	0.3 inductive up to 0.3 capacitive adjustable		
Switch on time	selectable from 1 sec. to 20 min.		Dynamic/relay 20 ... 1000 ms / 1 sec ... 20 min
Switch off time	selectable from 1 sec. to 20 min.		Dynamic/relay 20 ... 1000 ms / 1 sec ... 20 min
Discharge time	selectable from 1 sec. to 20 min.		Dynamic/relay 20 ... 1000 ms / 1 sec ... 20 min
Manual operation	yes		
Fixed steps/skip steps	programmable		
Zero voltage release	standard		
Display/display functions			
Display of grid parameters	cos-φ, V, I, F, W, Q, P, S, ΔQ, THD-V, THD-I		
Display of harmonics	3 rd to 33 rd harmonics of V and I / even harmonics 2 nd to 16 th		
Accuracy	current/voltage: 1% active, apparent and reactive power: 2%		
Integrated help function	context dependent		

PF-controllers BR7000-I Series

Single-phase measurement and controlling • Standard, mixed and dynamic compensation

SABA KHAZEN

Technical data				
	BR7000-I	BR7000-I/S485	BR7000-I-TH	BR7000-I-TH/S485
Storage function				
Storage of maximum values	voltage, current, active/reactive/apparent power, temperature, THD-V, THD-I			
Storage of switching operations	yes, each output can be reset separately		relay outputs only	
Storage of operation time	yes, each capacitor can be reset separately		relay outputs only	
Error storage	error register in plain language			
Temperature monitoring				
Monitoring	automatic step switch off			
Temperature measuring range	-20 ... +100 °C			
Casing				
Panel mounted instrument	DIN 43700, 144 x 144 x 55 mm			
Weight	1 kg			
Ambient operating temperature	-20 ... +60 °C			
Protection class acc. DIN 40050 0	front: IP54, rear: IP 20			
Safety regulations	IEC 601010-1:2001, EN61010-1:2001			
Interference resistance	EN50082-1:1995			
EMC interference	IEC61000-4-2: 8 kV IEC61000-4-4: 4 kV			
Interface RS485	no	RS485	no	RS485
Additional external input	no	yes; function programmable	no	yes; function programmable
Additional message relay	no	yes; freely programmable	no	yes; freely programmable
Evaluation software BR7000-SOFT	no	included in the delivery	no	included in the delivery
Ordering code	B44066R7012E230	B44066R7112E230	B44066R7412E230	B44066R7612E230

PF Controllers BR7000/BR7000-T

15 outputs • Three-phase measuring and controlling

SABA KHAZEN

General

The PF controllers BR7000/BR7000-T are a follow-up development of the PF controller BR6000-series, featuring two devices in one: it can be used as a controller as well as a grid measuring tool.

The BR7000 offers 15 relay outputs for the steps and three message/ alarm relays. The BR7000-T features 15 transistor outputs for usage in dynamic PFC-systems with thyristor modules TSM-series. Due to the possibility of programming, the 15 outputs can be used for a broad range of applications, for example:

- 15 conventional steps, each for one three-phase capacitor
- 15 steps for single-phase capacitors, where each output will switch a single-phase capacitor to N (usually 5 per phase, balancing of grid is possible)
- Mixed operation: e. g. 6 single-phase capacitors (2 per phase) for balancing plus 9 steps for conventional compensation (three-phase capacitors)

The controller can be connected to a PC via an RS485 interface. The Windows-based software BR7000-SOFT allows the readout

of acquired data. The possibility of graphical display of all values offers a comfortable visualization.



BR7000

Features

- LCD full graphic display
128 x 64 dots, 8 lines, versions BR7000-HD and BR7000-T/HD with OLED-display
- Self explanatory menu navigation in five languages
- Three-phase measuring and controlling; display of following grid parameters:
 - Voltage
 - Current
 - Frequency
 - Energy
 - Real power
 - Reactive power
 - Apparent power
 - Power factor
 - Missing reactive power
 - Harmonic of voltage and current (up to 31st)
 - THD-V
 - THD-I
 - Temperature
- HELP-button for interactive help text
- 15 switching outputs
- 3 additional alarm/message relays
- 2 isolated interfaces
- Detailed error messages with time stamp
- Automatic initialization/test run¹⁾
- Automatic and manual operation, service operation, expert mode
- Three-phase and single-phase controlling; mixed mode possible
- Display and storage of maximum values
- Display of switching operations and operating time¹⁾
- Display of date and time
- Time-controlled functions possible by internal timer
- Oscilloscope mode for graphical display
- Quick programming¹⁾

¹⁾ Only for BR7000 and BR7000-HD series

PF Controllers BR7000/BR7000-T

15 outputs • Three-phase measuring and controlling

SABA KHAZEN

Technical data	
BR7000/BR7000-T	
Supply voltage	110 ... 230 V AC 50/60 Hz
Measurement voltage range	3 · 30 ... 440 V AC (L-N); 50 ... 760 V AC (L-L)
Power consumption	< 3 VA
Operating ambient temperature	-20 ... +60 °C
Display	illuminated graphic display, 128 x 64 dots, 8 lines, HD versions with OLED display
Large display of 3 grid parameters	selection in display editor
Plain language	E / ES / GER / RU / TR
In- and outputs	
Number of outputs	BR7000: 15 relay outputs freely programmable for switching of 1- or 3-phase capacitors BR7000-T: 15 transistor outputs freely programmable for switching of 1- or 3-phase capacitors, suitable for dynamic PFC
Alarm/message relay	1/1
Additional separate fan relay	1
Interface	2 independent isolated RS485-interfaces
Input 2nd parameter-set switchover target PF	yes
Special functions	
Measuring	three-phase
Controlling	single-phase, three-phase, mixed mode
Automatic initialization	yes ¹⁾
Test-run of complete PFC-system	yes ¹⁾
Quick-program	yes ¹⁾
Internal timers	yes
Oscilloscope (graphical display) mode	yes
Display editor	yes
Backwards navigation ESCAPE button	yes
HELP button for interactive help text	yes
Number of control series	20 series pre-set
Control series editor for free programming	yes

¹⁾ Only for BR7000 and BR7000-HD series

PF Controllers BR7000/BR7000-T

15 outputs • Three-phase measuring and controlling

SABA KHAZEN

Technical data	
Parameters displayed (three-phase display)	
Apparent current (A)	real value / large display / in %
Reactive power (kvar)	real value / large display / in %
Active power (kW)	real value / large display / in %
Apparent power (kVA)	real value / large display / in %
kvar value to target cos φ	real value / large display / in %
Energy	real value / large display ¹⁾
Frequency	real value / large display
Temperature	real value / large display
Real-time cos φ	real value / large display
Target cos φ	real value / large display
Individual harmonics up to	up to 31st, real value / in % / bar graph
THD-V, THD-I	real value / in % / bar graph
Time/date	yes
Recall recorded values	
Min. and maximum voltage	yes, with time stamp
Maximum current	yes, with time stamp
Maximum active power	yes, with time stamp
Maximum reactive power	yes, with time stamp
Maximum apparent power	yes, with time stamp
Maximum value THD-V, THD-I	yes, with time stamp
Maximum temperature (°C)	yes, with time stamp
Operation time of all capacitors	yes ¹⁾
Number of contactor switching operations	yes ¹⁾
Others	
Weight	1 kg
Dimensions (h x w x d)	144 x 144 x 60 mm
PC-software included	yes
Suitable for dynamic PFC	only versions BR7000-T and BR7000-T/HD
Ordering code	BR7000: B44066R7415E230 BR7000-HD: B44066R7515E230 BR7000-T: B44066R7615E230 BR7000-T/HD: B44066R7715E230

¹⁾ Only for BR7000 and BR7000-HD series

Evaluation Software BR7000-SOFT

SABA KHAZEN

BR7000-SOFT Windows-based software

This program offers the possibility for a comfortable parameterization, recording, analysis and visualization of grid parameters in online operation via a PC. It is compatible with PF controller series BR7000.

The software allows the recording and a graphical evaluation of all values including export- and print function. The spectrum of harmonics can be displayed as bar chart.

The configuration manager is used for a complete read out, editing, storing and writing of all parameters of the PF controller via PC. All data can be stored in a configuration file.

Features

- Connection to RS485-bus
- Administration of several PF controllers possible
- Convenient analysis of recorded values
- Direct connection to USB port of a PC via USB adapter
- CD-ROM included in the delivery of PF controller BR7000 and BR7000-I/S485

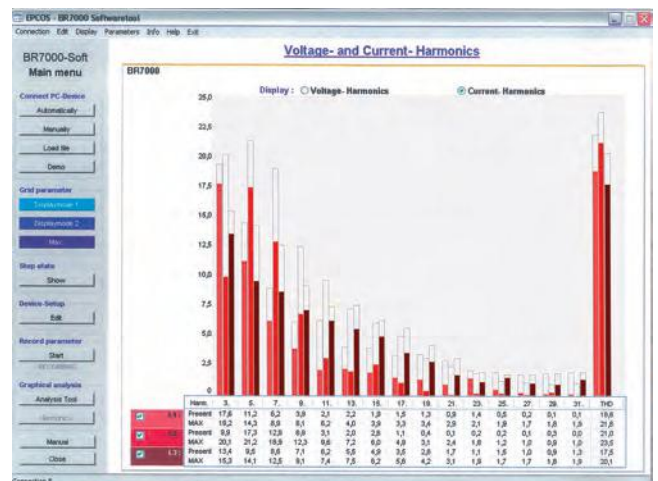
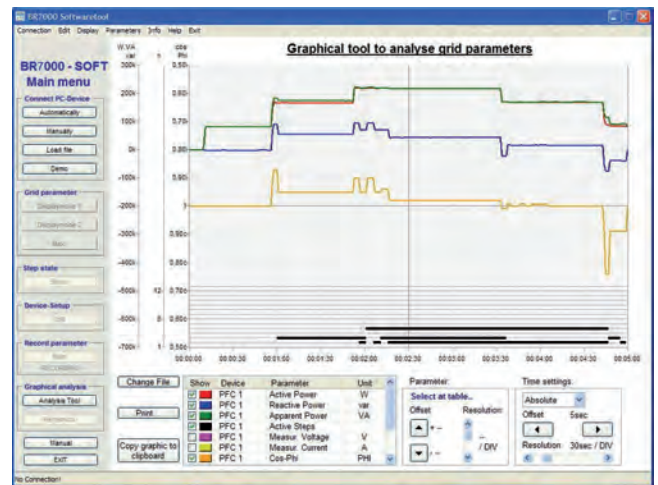
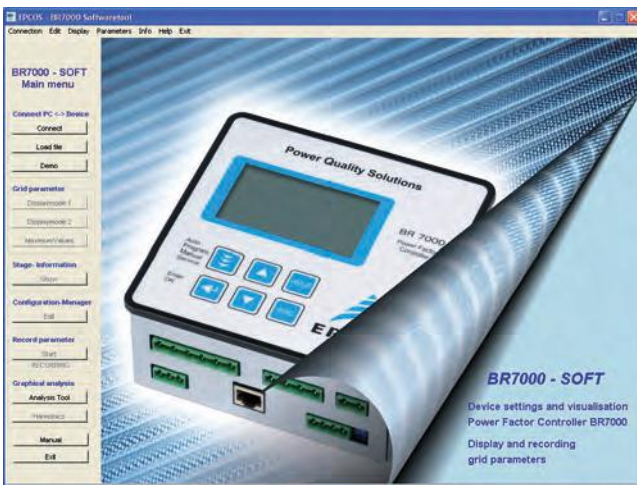

Accessories for PF Controllers

SABA KHAZEN

Accessories: USB to RS485 converter

Characteristics

Design	compact form in plastic casing
Dimensions (h x w x d)	28 x 66 x 66 mm
Weight	approx. 0.1 kg
Connection	RS485 four pole terminal with mating plug for 1:1-connection with BR6000
Signals	A, B, GND
USB	USB-B standard bushing, one USB cable 1 m length included
Power supply	via USB connection of the PC
Power consumption	auxiliary power approx. 40 mA, depending on number of connected devices and cable length
Compatibility	USB 2.0, downward compatible
Configuration	plug and play
Ambient temperature	-10 ... +60 °C
Storage temperature	-20 ... +75 °C
Ordering code	B44066R3333E230

USB to RS485 converter to connect the PF controllers BR7000, BR7000-I/S485 and BR7000-I-TH/S485 or other devices with Interface RS485 to a PC with USB interface. Connection of several devices at RS485 possible.



Accessories: DataLogSD

Characteristics

Design	compact plastic casing
Dimensions (h x w x d)	66 x 66 x 28 mm
Weight	approx. 0.1 kg
Power supply	self supporting via interface BR7000, BR7000-I/S485 and BR7000-I-TH/S485
Recorded grid parameters	V, I, reactive, effective and apparent power, frequency, harmonics up to 31st of V and I, $\cos-\varphi$, THD-V, THD-I, energy
Recorded parameters of the PFC-system	system temperature, step output, control history of the system (switching operations, switching behavior, power-on-time)
Content of delivery	DataLogSD, SD-card, evaluation software CD, patch cable 0.5 m
Ordering code	B44066R1311E230

Data logger for recording, visualisation and evaluation for grid parameters. Comfortable evaluation of acquired data (recorded on SD-card) via Windows-based software.



Accessories for PF Controllers

SABA KHAZEN

Accessories: RJ45 adapter connectors

Characteristics

Design	compact form
Dimensions (w x h x l)	35 x 15 x 30 mm
Weight	approx. 0.1 kg
Variants	1xRJ45-BR6000: 4-pole interface-terminal BR7000, BR7000-I/S485 and BR7000-I-TH/S485 to 1xRJ45 jack 2xRJ45-BR6000: 4-pole interface-terminal BR7000, BR7000-I/S485 and BR7000-I-TH/S485 to 2xRJ45 jack (in parallel) 2xRJ45-MMI6000: 4-pole interface-terminal MMI6000 to 2xRJ45 jack
Protection class (IEC 60529)	IP00
Ambient and storage temp.	-20 ... +60 °C
Ordering codes	1 x RJ45 for BR7000, BR7000-I/S485 and BR7000-I-TH/S485: B44066R1611E230 2 x RJ45 for BR7000, BR7000-I/S485 and BR7000-I-TH/S485: B44066R1711E230 2 x RJ45 for MMI6000: B44066R1811E230

RJ45 adapter connectors for PF controller series BR7000 and BR7000-I-TH/S485 as well as for the MMI6000 multi-measuring interface. Three different versions of the adapter connectors enable the following configurations:

- Terminal to RJ45 converter
- To connect the interface terminal of BR7000 and BR7000-I-TH/S485 or MMI6000 via a RJ45-standard cable (1:1)
- Connection of several devices at the RS485 bus with simple connection (one click)
Example:
 - Connection of several BR7000, BR7000-I/S485 and BR7000-I-TH/S485 to a PC with BR7000-SOFT
 - Coupling of several BR7000-I/S485 with each other

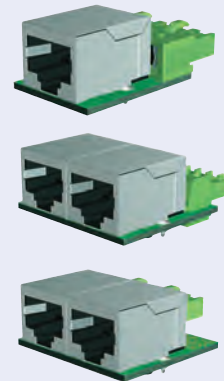

Accessories for PF Controllers

SABA KHAZEN

Accessories: Touch Panel VIP-3-TP for coupling of 3 compensation-systems with PF-controllers BR7000-I/S

Characteristics

Dimensions (w x h x d):	
Front	212 x 156 x 6 mm
Rear	196 x 140 x 51 mm
Cut out for panel	198 x 142 mm
Weight	1.2 kg
Size of display	7"
Resolution	800 x 480 pixel
Operating voltage	24 V DC
Power consumption (rated value)	0.4 A
Degree of protection:	
Front	IP65
Rear	IP20
Operating/storage temperature	0 ... +50 °C / -20 ... +60 °C
Interfaces	COM2: RS485 (25 pol. Sub-D); USB; 24 V DC
Accessories incl. in the delivery	Panel (software pre-installed), mounting clips, Sub-D to RJ45-adapter
Ordering codes	B44066R1703E230

Comfortable control device for intelligent coupling of 3 compensation systems. Enables operation of compensation systems in parallel for three coupled feeding transformers without any retroactivity. The control device „VIP-3-TP“ realizes the coupling with PF-controllers BR7000-I/S485 and at the same time offers a comfortable visualization of the measuring values, switching states and of the actual system state.

To achieve this, the device is connected to the PF-controllers via Patch-cables only (RS485-interface).

All possibilities of coupling are supported:

- Coupling with 2 coupling switches
- Ring coupling (3 coupling switches)
- Coupling via separate coupling bus bars (3 coupling switches)

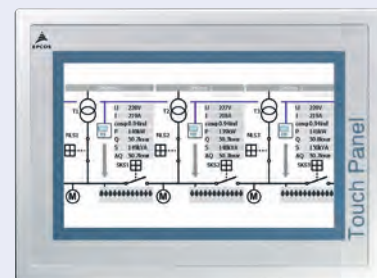

Accessories for PF Controllers

SABA KHAZEN

Accessories: Touch Panel VIP-3-TP for coupling of 3 compensation-systems with PF-controllers BR7000-I/S

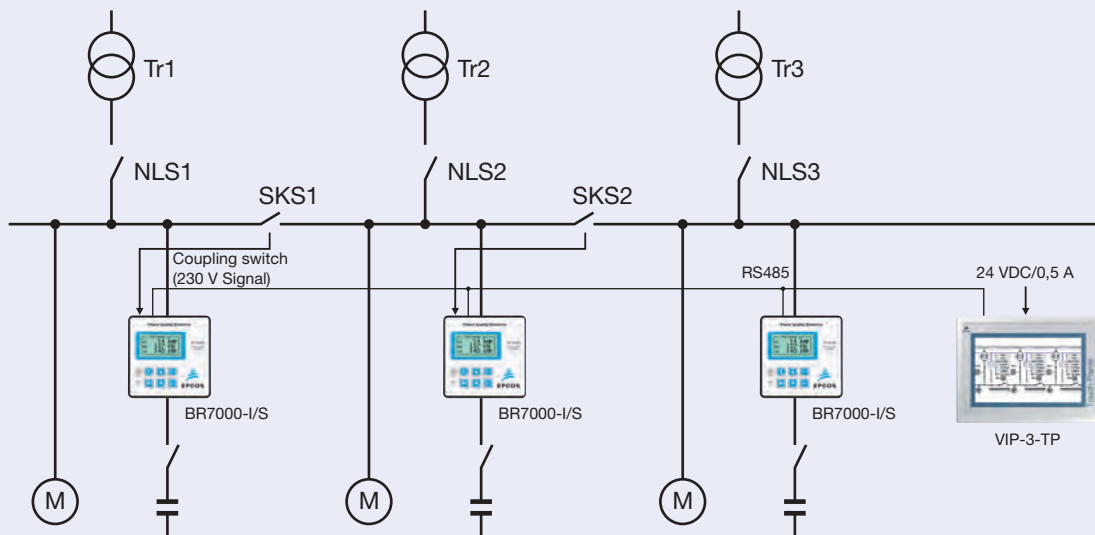

Accessories for PF Controllers

SABA KHAZEN

Accessories: S0-Impulse-Module UCM-5

Characteristics

Dimensions (w x h x d)	33 x 82 x 126 mm
Weight	approx. 0.1 kg
Power supply	24 V DC (18 ... 27 V)
Power consumption	> 1 VA
Inputs (S0-interface) 5 ... 27 V galvanically separated	5 impulse inputs for P+, P- (active power: consumption/delivery) Q+, Q- (reactive power: inductive/capacitive) synchronic impulse
Outputs	interface RS485 (Modbus-RTU) 4-pole plug connector included in the delivery (via adapter: system interface RS485 possible)
Baud rate	9600, 19200, 38400 Baud (factory setting)
Operation mode cost center management	readings recorder (counter values), for embedding of up to 32 devices (also MMI6000/MMI7000) in Modbus networks for further processing in software MMI-energy
PF controller supported during controlling acc. counter impulses	BR7000-I-TH/S485 BR7000 BR7000-I/S485
Degree of protection (VDE 0470)	IP20
Content of delivery	compact device, software-CD
Allowed operation temp.	-10 ... +50 °C
Ordering code	B44066R1411E230

- Bus compatible S0-impulse module for software MMI-energy for conversion of counter impulses (Q+, Q-, P+, P-, synchronic) on RS485 (MODBUS-RTU protocol)
- Accessory for processing of counter values in PF controller (controlling of reactive power related to counter impulses instead of current transformer)
- Allows processing of counter values via Windows-software MMI-energy (included in the delivery): cost center management, visualization and evaluation
- Cross-linking of up to 32 devices (UCM-5, MMI6000, MMI7000, MMI8003, BR7000) at MODBUS
- Compact design in plastic case
- Mounting on DIN-rail possible
- Evaluation software included in the delivery

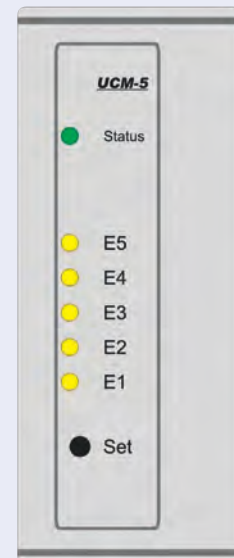

Multi Measuring Interfaces

Stand-alone device as trigger • Accessory for PF controller BR-series

SABA KHAZEN

General

The MMI6000, MMI7000 and MMI8003, universal measuring devices, display and record a large number of key grid parameters. Harmful conditions in the grid

(e.g. a high harmonic content) with a negative impact on the system are thus revealed immediately.

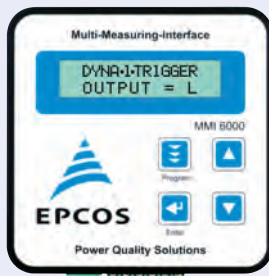

MMI6000



MMI7000



MMI8003

MMI6000

Measuring device for single phase measuring. It is an external meter combining many devices in one. Combined with a PF controller with interface the MMI6000 monitors the input lead of the PFC system.

Versions:

- MMI6000-R with relay output
 - MMI6000-T with transistor output
- All versions are with an interface RS485.

Applications

Coupling MMI6000 – BR7000 via RS485 interface

- Genuine monitoring of the particular capacitor currents offers additional protection for the whole PFC-system.

MMI6000 / Modbus RTU

- Usage as separate measuring device allows display of all network parameters and delivery via Modbus-RTU-protocol.

MMI6000 / ASCII OUT

- Measured values are provided in ASCII code via interface; usage also as a trigger relay.

MMI6000-T Dyna-I-trigger

- Triggering of TSM-thyristor switches in real time, providing the switching within 1 ms.

MMI7000

Supported by the “BR7000-SOFT” (windows-based software) if connected to a RS485 bus, the measured values from all connected devices can be displayed via a PC.

Three versions available:

- MMI7000-B (basic version)
- MMI7000-S (2 interfaces)
- MMI7000-E (1 interface, memory card, additional outputs)

Applications

Three-phase measuring device in panels:

- Grid measurements
- Power measurements
- Measurement of harmonics
- Energy counter (sub-counter)
- Display device in incoming supply or all outgoing lines
- Triggering of messages or switching operations
- Four relay outputs
- Storage of all grid parameters – long-term monitoring via SD card
- Transmitter for external systems
- Coupling with PF controllers with interface for 3-phase external monitoring of the capacitor currents – additional protection for the whole PFC system

MMI8003

Genuine measuring device for three phase measuring. Supported by the “BR7000-SOFT” (windows-based software) it has to connect to a RS485 bus, the measured values from all connected devices can be displayed and processed via a PC or an external control system.

- without display
- for using inside a cabinet
- with interface (2x RJ45)
- mounting on hut rail

Applications

Three-phase measuring device in panels:

- Grid measurements
- Power measurements
- Measurement of harmonics
- Energy counter (sub-counter)
- Display device in incoming supply or all outgoing lines

All values can be read out via Modbus in real time.

Multi Measuring Interfaces

Stand-alone device as trigger • Accessory for PF controller BR-series

SABA KHAZEN

Technical data			
	MMI6000	MMI7000	MMI8003
Weight	0.5 kg	1.0 kg	0.5 kg
Dimensions (h x w x d)	panel mounting instrument 100 x 100 x 45 mm	panel mounting instrument 144 x 144 x 35 mm (MMI7000-B) 144 x 144 x 60 mm (MMI7000-S/-E)	Plastic casing for hut rail mounting, 92 x 90 x 38 mm
Interface	1x RS485 (4-pole terminal) Protocol: MODBUS RTU	MMI7000-E: 1x RS485 (RJ45) MMI7000-S: 2x RS485 (RJ45) Protocol: MODBUS RTU	System interface RS485 (Modbus RTU)
Windows-software BR7000-soft	–	included in the delivery	included in the delivery, additional PC-software for parametrization
Output capacity	MMI6000-R: 250 V AC, 1000 W MMI6000-T: 60 V DC, 150 mA	MMI7000-E: 250VAC, 1000 W	n/a
Display	Graphical, 2 x 16 characters, illuminated	Graphical, 128 x 64 dots, illuminated	n/a
Menu languages	English/German	English/German/Russian/ Spanish/Turkish	n/a
Measuring and display	Single phase V, I, F, Q, P, S, cos-φ, W, temperature	Three phase V, I, F, Q, P, S, cos-φ, THD-V, THD-I, W, harmonic of voltage up to 51st, harmonic of current up to 51st, temperature	Three phase V, I, Q, P, S, F, THD-V, THD-I, W, cos-phi, single harmonics of voltage and current. All values can be read out via Modbus in real time
Operating voltage	230 V AC	110 ... 230 V AC +/- 15 %	24 V DC (via external terminal)
Measuring voltage	230 V AC	Three phase 3 · 30 ... 440 V AC (L-N) 3 · 50 ... 760 V AC (L-L)	Three phase 3 · 30 ... 440 V~ (L-N) 3 · 50 ... 690 V~ (L-L)
Frequency	50/60 Hz	50/60 Hz	10 ... 80 Hz
Power consumption	< 4 VA	< 5 VA	< 1 VA
Measurement current	X:5A and X:1A	3 · X:5A / X:1A	3 · X:5A / X:1A selectable
Measuring temperature range	0 ... +100 °C	-20 ... +100°C	n/a
Ambient temperature range	-10 ... +55 °C	-10 ... +55 °C	-10 ... +55 °C
Storage temperature range	-20 ... +75 °C	-20 ... +75 °C	-20 ... +75 °C
Overvoltage class	II	II	II
Pollution degree	2	2	2
Humidity class	15 ... 95% without dew	15 ... 95% without dew	15 ... 95% without dew
Mounting position	any	any	any
Protection class to IEC 60529	Front IP54, rear IP20	Front IP54, rear IP20	IP20
Safety guidelines	IEC 61010-1:2001, EN 61010-1:2001	IEC 61010-1:2001, EN 61010-1:2001	IEC 61010-1:2001, EN 61010-1:2001
Sensitivity to interferences (Industrial areas)	IEC 61000-4-2:8 kV, IEC 61000-4-4:4 kV	IEC 61000-4-2:8 kV, IEC 61000-4-4:4 kV	IEC 61000-4-2:8 kV, IEC 61000-4-4:4 kV
Ordering code	MMI6000-R: B44066M6000E230 MMI6000-T: B44066M6100E230	MMI7000-B: B44066M7100E230 MMI7000-S: B44066M7200E230 MMI7000-E: B44066M7300E230	B44066M8003E024

