

Filtros de alto rendimiento

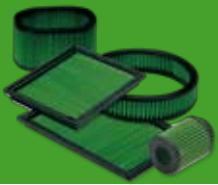



Filtros de alto rendimiento



¿Por qué elegir un filtro de aire GREEN?

- Un filtro GREEN aumenta la potencia entre entre un 3 y un 10% y el par motor entre un 5 y 10%.
- Mantiene el motor limpio incrementando su vida útil.
- Disminuye el consumo en un 3%
- Disminuye la contaminación.
- Su diseño de pliegues permite incrementar el volumen de aire que penetra en los cilindros del motor en un 40%.

Alto Rendimiento

Los filtros de algodón Green son pre-tratados con un aceite especialmente diseñado para atrapar la suciedad. Este aceite crea un polo de atracción en el filtro que atrae la carga negativa de las partículas de suciedad, alargando la vida del filtro.



*Los filtros de esponja y de papel tienden a absorber la suciedad en lugar de atraparla por lo que, cuando se humedecen, la capacidad de filtración queda limitada.

FZ 600 FAZER

FUCHS

V.2.11

18°-950hPa-41%G=3.48%P=22.6mN
18°-950hPa-41%G=3.30%P=28.7mN

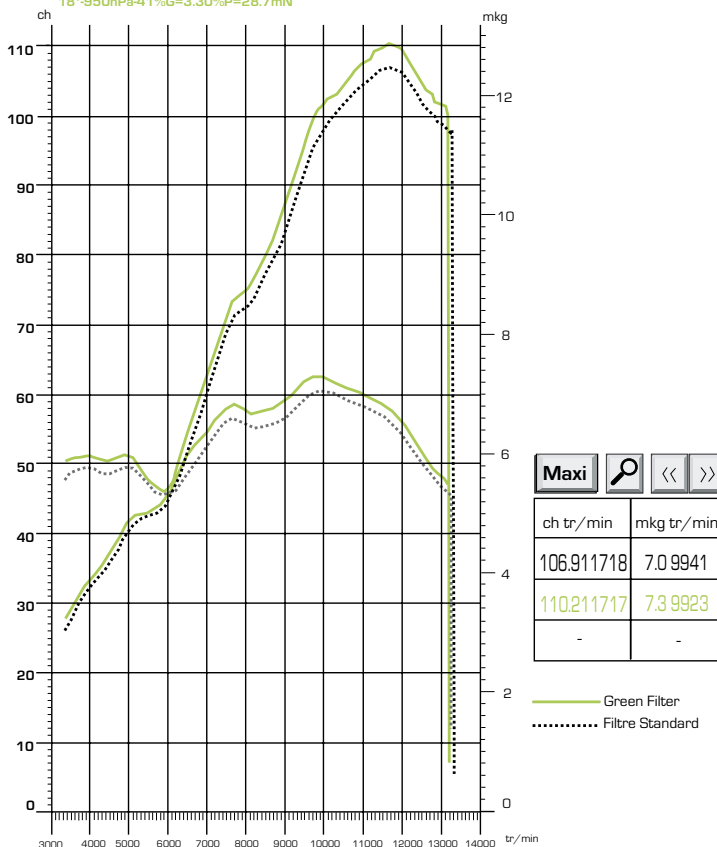

Attention : les valeurs de puissance standard sont parfois celles des versions libres, pour utilisation circuit.

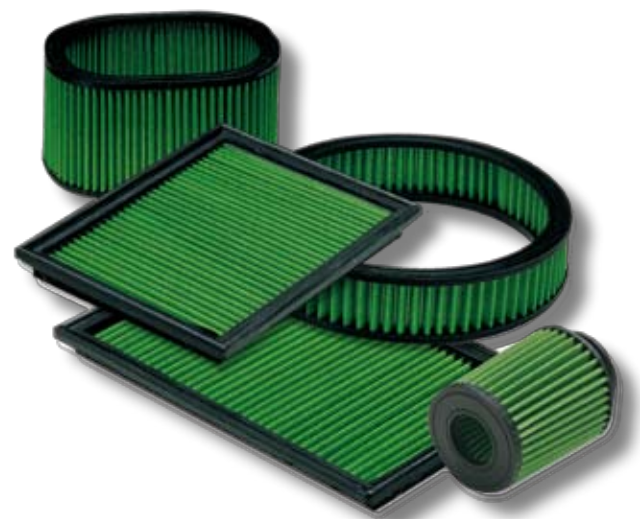

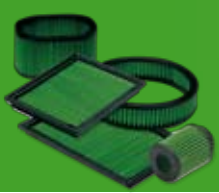

Filtros de alto rendimiento

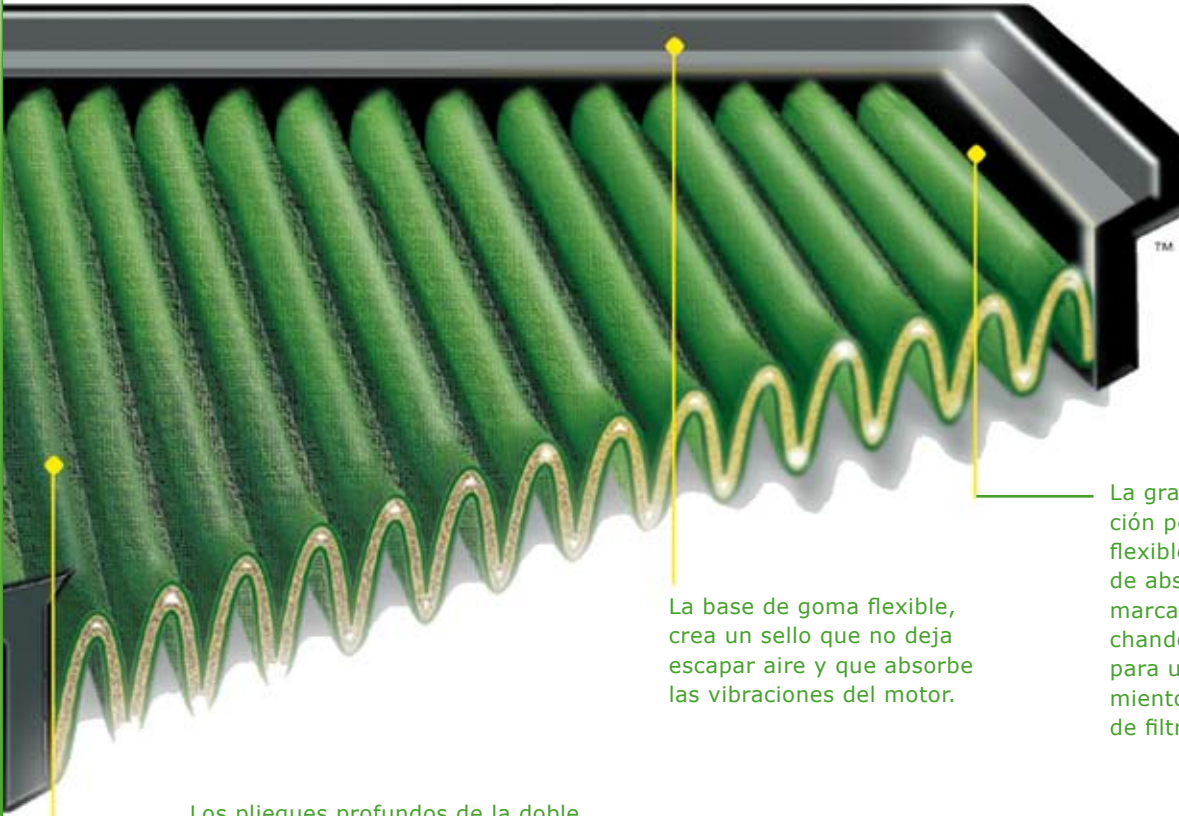

Los pliegues profundos de la doble capa de algodón aumentan en un 10-20% la superficie de filtrado. Ésto permite incrementar el volumen de aire que penetra en los cilindros

La base de goma flexible, crea un sello que no deja escapar aire y que absorbe las vibraciones del motor.

La gran calidad de construcción permite que la goma flexible no invada la zona de absorción, como en otras marcas de filtros, aprovechando toda la superficie para un perfecto funcionamiento sin perder superficie de filtración

Cómo limpiar los filtros GREEN?



- 1) Los filtros de aire Green se pueden limpiar a los 8000 kilómetros o dos veces por año, excepto en caso de utilización en condiciones extremas como en los quads o motocross. Cada filtro puede ser lavado de 15 a 20 veces.
- 2) Seguir las instrucciones suministradas dentro de los kits de limpieza



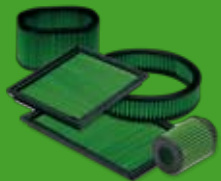

Filtros de alto rendimiento



CC	MARCA/MODELO	AÑO	CÓDIGO	FIG.	CÓDIGO OE	CÓDIGO K&N
ADLY						
300	Thunderbike 300	04/	FQA022	105	—	—
300	Utilitarie 300	04/	FQA022	105	—	—
300	Interceptor 300	05/	FQA022	105	—	—
300	Crusader Utilitaire 300	05/	FQA022	105	—	—
APRILIA						
125	RS 125	97/06	FMA0531	66	—	—
650	I.E Pegaso	97/04	FMB0507	9	13721342355	BM1298
1000	RST Mille Futura	01/04	FMA0472	5	8102610	AL1098
1000	RSV Mille	98/00	FMA0472	5	8102610	AL1098
		01/03	FMA0495	5	8104211	AL1001
1000	RSV Mille R	00/03	FMA0495	5	8104211	AL1001
1000	RSV Mille SP	99/01	FMA0472	5	8102610	AL1098
1000	RSV Mille Tuono	01/03	FMA0495	5	8104211	AL1001
1000	RSV 1000 Tuono	06/	FMA0533	1	8104329	AL1004
1000	Tuono Fighter	03/04	FMA0495	5	8104211	AL1001
1000	Tuono Racing	04/05	FMA0495	5	8104211	AL1001
1000	Tuono 1000 R	05/	FMA0495	5	8104211	AL1001
1000	Tuono 1000 R Factory	05/	FMA0495	5	8104211	AL1001
1000	RSV 1000 Factory	04/05	FMA0533	1	8104329	AL1004
1000	RSV 1000 R Factory	05/	FMA0533	1	8104329	AL1004
1000	RSV 1000 Nera	04/05	FMA0533	1	8104329	AL1004
1000	RSV 1000 R	04/05	FMA0533	1	8104329	AL1004
1000	SL Mille Falco	00/04	FMA0472	5	8102610	AL1098
1000	SL Mille Tuono Fighter	02/04	FMA0495	5	8104211	AL1001
ARCTIC CAT						
250	250 2X4	99/05	FQA034	91	0470355/0470421	AC3098
250	250 4X4	01/05	FQA034	91	0470355/0470421	AC3098
250	250 DVX	06/	FQK017	82	1721ALBA790	KY2504
300	300 2X4	98/03	FQA034	91	0470355/0470421	AC3098
300	300 4X4	98/05	FQA034	91	0470355/0470421	AC3098
375	375 2X4	02/	FQA026	33	0470322/0391/0460	AC-4096-1
375	375 4X4	02/	FQA026	33	0470322/0391/0460	AC-4096-1
400	400 2X4	98/05	FQA026	33	0470322/0391/0460	AC-4096-1
		98/05	FQA026	33	0470322/0391/0460	AC-4096-1
400	400 4X4	06/	FQA038	161	470494	AC6504
		06/	FQA038	161	470494	AC6504
400	400 4X4 Auto LE	06/	FQA038	161	470494	AC6504
400	400 4X4 Auto TBX	06/	FQA038	161	470494	AC6504
400	400 4X4 Auto TRV	06/	FQA038	161	470494	AC6504
454	454 2X4	96/98	FQA026	33	0470322/0391/0460	AC-4096-1
454	454 4X4	96/98	FQA026	33	0470322/0391/0460	AC-4096-1
500	500 4X4	98/02	FQA026	33	0470322/0391/0460	AC-4096-1
		05/	FQA038	161	470494	AC-4004
500	500 4X4 Auto	05/	FQA038	161	470494	AC-4004
500	500 4X4 Auto LE	05/	FQA038	161	470494	AC-4004
500	500 4X4 Auto TBX	05/	FQA038	161	470494	AC-4004
500	500 4X4 Auto TRV	05/	FQA038	161	470494	AC-4004
650	650 4X4 Auto	04/06	FQA038	161	470494	AC6504
650	650 4X4 Auto LE	04/06	FQA038	161	470494	AC6504
650	650 H1 4X4 Auto	05/06	FQA038	161	470494	AC6504
650	650 H1 4X4 SE	06/	FQA038	161	470494	AC6504

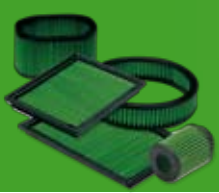

Filtros de alto rendimiento



CC	MARCA/MODELO	AÑO	CÓDIGO	FIG.	CÓDIGO OE	CÓDIGO K&N
650	650 V2 4X4 Auto	05/06	FQA038	161	470494	AC6504
650	650 V2 4X4	06/	FQA038	161	470494	AC6504
650	650 V2 4X4 Auto LE	05/	FQA038	161	470494	AC6504
650	650 V2 4X4 LE TS	06/	FQA038	161	470494	AC6504
650	Prowler XT 650 H1	06/	FQA038	161	470494	AC6504
AXR						
250	250 UT	04/	FQY013	21	—	—
282	300 SP	04/	FQA022	105	—	—
BMW						
125	C1	00/	FRSC005	5	7.650.185	—
200	C1	00/	FRSC005	5	7.650.185	—
600	R60	70/79	FMB0505	5	13.721.254.382	BM0200
650	F650	93/00	FMB0504	76	13.722.345.007	BM0200
650	F650 CS	02/	FMB0502	1	13.717.659.972	BM0200
650	F650 GS	00/05	FMB0497	1	13.712.345.232	BM0200
650	F650 GS Dakar	00/05	FMB0497	1	13.712.345.232	BM0200
650	R65	78/95	FMB0500	74	13.721.337.080	BM0200
650	R65 LS	78/84	FMB0500	74	13.721.337.080	BM0200
750	K75	88/95	FMB0499	1	13.721.460.337	BM0200
750	K75 (ABS)	94/95	FMB0499	1	13.721.460.337	BM0300
750	K75/3 (ABS)	95/	FMB0499	1	13.721.460.337	BM0300
750	K75 C	86/95	FMB0499	1	13.721.460.337	BM0300
750	K75 RT (ABS)	91/95	FMB0499	1	13.721.460.337	BM0300
750	K75 S (ABS)	86/95	FMB0499	1	13.721.460.337	BM0300
750	K75 T (ABS)	86/	FMB0499	1	13.721.460.337	BM0300
750	R75	69/84	FMB0505	5	13.721.254.382	BM0200
800	F800 S/ST	06/	FMB0514	1	13.717.678.281	BM8006
800	R80	84/95	FMB0500	74	13.721.337.080	BM0300
800	R80 GS	80/86	FMB0500	74	13.721.337.080	BM0300
800	R80 RT	76/84	FMB0505	5	13.721.254.382	BM0200
		85/95	FMB0500	74	13.721.337.080	BM0300
800	R80 ST	80/86	FMB0500	74	13.721.337.080	BM0300
850	R850 R/GS/RT/RS	96/02	FMB0479	5	13.711.341.528	BM0300
900	R90	75/76	FMB0505	5	13.721.254.382	BM0200
900	R90 S	69/76	FMB0505	5	13.721.254.382	BM0200
1000	K1	89/93	FMB0499	1	13.721.460.337	BM2605
1000	K1 (ABS)	91/93	FMB0499	1	13.721.460.337	BM2605
1000	K100	83/89	FMB0499	1	13.721.460.337	BM2605
1000	K100 LT	83/93	FMB0499	1	13.721.460.337	BM2605
1000	K100 LT (ABS)	83/93	FMB0499	1	13.721.460.337	BM2605
1000	K100 RS	83/93	FMB0499	1	13.721.460.337	BM2605
1000	K100 RS (ABS)	83/93	FMB0499	1	13.721.460.337	BM2605
1000	K100 RT	83/89	FMB0499	1	13.721.460.337	BM2605
1000	R100	76/84	FMB0505	5	13.721.254.382	BM0200
1000	R100 CS	76/84	FMB0500	74	13.721.337.080	BM0300
1000	R100 GS	87/95	FMB0500	74	13.721.337.080	BM0300
1000	R100 MYS	91/95	FMB0500	74	13.721.337.080	BM0300
1000	R100 PD	87/95	FMB0500	74	13.721.337.080	BM0300
1000	R100 R	91/95	FMB0500	74	13.721.337.080	BM0300
1000	R100 RS	76/95	FMB0500	74	13.721.337.080	BM0300
1000	R100 RT	76/95	FMB0500	74	13.721.337.080	BM0300

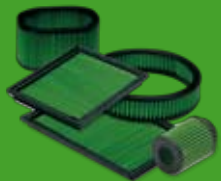

Filtros de alto rendimiento



CC	MARCA/MODELO	AÑO	CÓDIGO	FIG.	CÓDIGO OE	CÓDIGO K&N
1000	R100 S	76/84	FMB0500	74	13.721.337.080	BM0300
1000	R100 T	80/	FMB0500	74	13.721.337.080	BM0300
1000	R100 T Sport	80/	FMB0500	74	13.721.337.080	BM0300
1000	R100 TR	82/	FMB0500	74	13.721.337.080	BM0300
1100	K 1100 LT (ABS)	93/97	FMB0499	1	13.721.460.337	BM2605
		99/03	FMB0508	1	13.721.650.975	BM1199
1100	K1100 RS (ABS)	90/97	FMB0499	1	13.721.460.337	BM2605
1100	R1100 GS/R/RA/RS/RSL/RT (ABS)	96/02	FMB0479	5	13.711.341.528	BM0400
1100	R1100 S	93/97	FMB0499	1	13.721.460.337	BM2605
1150	R1150 R/GS/RS/RT	95/04	FMB0479	5	13.711.341.528	BM0400
1200	K1200 C	02/	FMB0503	22	13.711.464.916	BM1299
1200	K1200 GT	02/05	FMB0503	22	13.711.464.916	BM1299
1200	K1200 LT (ABS)	98/04	FMB0503	22	13.711.464.916	BM1299
1200	K1200 RS	97/04	FMB0503	22	13.711.464.916	BM1299
1200	K1200S (2 filtros por moto)	05/	FMB0561	139	13.717.672.602	BM1205
1200	K1200R (2 filtros por moto)	05/	FMB0561	139	13.717.672.602	BM1205
1200	R1200 C	98/04	FMB0507	9	13.711.342.354	BM1298
1200	R1200 C Avantgarde	98/03	FMB0507	9	13.711.342.354	BM1298
1200	R1200 C Classic	98/03	FMB0507	9	13.711.342.354	BM1298
1200	R1200 CL	03/	FMB0507	9	13.711.342.354	BM1298
1200	R1200 C Independent	98/03	FMB0507	9	13.711.342.354	BM1298
1200	R1200 C Montauk	98/04	FMB0507	9	13.711.342.354	BM1298
1200	R1200 C Phoenix	98/03	FMB0507	9	13.711.342.354	BM1298
1200	R1200 C Ruser	98/03	FMB0507	9	13.711.342.354	BM1298
1200	R1200 GS	04/	FMB0514	1	13.717.672.552	BM1204
1200	R1200 RT	05/	FMB0514	1	13.717.672.552	BM1204
1200	R1200 ST	05/	FMB0514	1	13.717.672.552	BM1204
1000	R100 T	79/	FMB0505	5	13.721.254.382	BM0200
—	R (Todos)	70/79	FMB0505	5	13.721.254.382	BM0200
BOMBARDIER						
330	Outlander 330 HO	03/	FQB016	25	707.800.120	BD3303
330	Outlander 330 HO 2X4	04/	FQB016	25	707.800.120	BD3303
330	Outlander 330 HO 4X4	04/	FQB016	25	707.800.120	BD3303
400	Outlander 400	03/	FQB016	25	707.800.120	BD3303
400	Outlander 400 HO 4X4	03/	FQB016	25	707.800.120	BD3303
400	Outlander Max 400 HO	04/	FQB016	25	707.800.120	BD3303
400	Outlander Max 400 HO 2X4	04/	FQB016	25	707.800.120	BD3303
400	Outlander Max 400 HO 4X4	04/	FQB016	25	707.800.120	BD3303
500	Quest 500	02/	FQB015	29	707.800.072	BD6502
500	Traxter 500	99/05	FQB015	29	707.800.072	BD6502
500	Traxter Max 500	04/	FQB015	29	707.800.072	BD6502
500	Traxter XL 500	04/	FQB015	29	707.800.072	BD6502
500	Traxter XT 500	03/	FQB015	29	707.800.072	BD6502
650	DS 650	00/05	FQB012	82	707.800.023	BD6500
650	DS 650 X	06/	FQB012	82	707.800.023	BD6500
650	Outlander 650	06/	FQB043	25	707.800.174	BD6506
650	Outlander 650 XT	06/	FQB043	25	707.800.174	BD6506
650	Outlander Max 650 , CAN AM HO	06/	FQB043	25	707.800.174	BD6506
650	Outlander Max 650 XT	06/	FQB043	25	707.800.174	BD6506
650	Quest 650	02/	FQB015	29	707.800.072	BD6502
650	Quest Max 650	02/	FQB015	29	707.800.072	BD6502

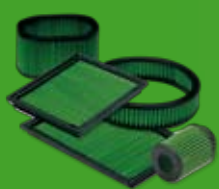

Filtros de alto rendimiento



CC	MARCA/MODELO	AÑO	CÓDIGO	FIG.	CÓDIGO OE	CÓDIGO K&N
650	Traxter 650	05/	FQB015	29	707.800.072	BD6502
650	Traxter Max 650	05/	FQB015	29	707.800.072	BD6502
800	Outlander 800	06/	FQB043	25	707.800.174	BD6506
800	Outlander 800 XT	06/	FQB043	25	707.800.174	BD6506
800	Outlander Max 800, CAN AM HO	06/	FQB043	25	707.800.174	BD6506
800	Outlander Max 800 XT	06/	FQB043	25	707.800.174	BD6506
BUELL						
500	Blast	06/	FMB0540	120	P021302A8	BU9003
900	XB9R Firebolt	02/	FMB0540	120	P021302A8	BU9003
900	XB9S Lightning	03/04	FMB0540	120	P021302A8	BU9003
900	XB9SX Lightning City	05/	FMB0540	120	P021302A8	BU9003
1200	M2	97/00	FMB0496	73	29239-96Y	BU1297
1200	S1 Lightning	96/98	FMB0496	73	29239-96Y	BU1297
1200	S1 White Lightning	98/02	FMB0496	73	29239-96Y	BU1297
1200	S2 Thudderbolt	94/02	FMB0496	73	29239-96Y	BU1297
1200	S3 Thunderbolt	97/02	FMB0496	73	29239-96Y	BU1297
1200	S3T Thunderbolt	97/02	FMB0496	73	29239-96Y	BU1297
1200	X1 Lightning	99/02	FMB0496	73	29239-96Y	BU1297
1200	XB12R Firebolt	04/	FMB0540	120	P021302A8	BU9003
1200	XB12S Lightning	04/	FMB0540	120	P021302A8	BU9003
1200	XB12SCG Lightning	05/	FMB0540	120	P021302A8	BU9003
1200	XB12SS Lightning Long	06/	FMB0540	120	P021302A8	BU9003
1200	XB12X Ulysses	05/	FMB0540	120	P021302A8	BU9003
CAGIVA						
900	Elefant 900	92/96	FMG0471	1	800064754	CG9002
900	Grand Canyon 900	97/00	FMG0471	1	800064754	CG9002
1000	1000 Raptor	00/	FMS0489	72	800092735	SU0007
1000	1000 V Raptor	00/	FMS0489	72	800092735	SU0007
1000	Xtra-Raptor	00/	FMS0489	72	800092735	SU0007
1000	Navigator 1000	98/03	FMG0471	1	800064754	CG9002
CAN AM						
450	DS 450	todos	FQH003	25	707800216	CM4508
500	Renegade 500	todos	FQB043	25	707800174	BD6506
650	Outlander 650	todos	FQB043	25	707800174	BD6506
800	Outlander 800	todos	FQB043	25	707800174	BD6506
800	Renegade 800	todos	FQB043	25	707800174	BD6506
DELTA MICS						
260	260	—	FQD007	40	—	—
DINLI						
270	DL 901 DMX 270	05/	FQA022	105	F15012400	—
350	DL 801 HR	06/	FQA022	105	F15012400	—
450	DL 901 DMX 450	05/	FQD037	1	F15012400	—
DUCATI						
350	Supersport 350	—	FMD0449	1	426 100 91A	DU9098
400	Monster 400	95/03	FMD0449	1	426 100 91A	DU9098
400	Monster 400 IE	05/	FMD0468	1	426 101 11A	DU9001
400	Monster 400 Dark IE	05/	FMD0468	1	426 101 11A	DU9001
400	Supersport 400	93/01	FMD0449	1	426 100 91A	DU9098

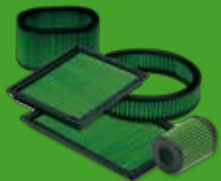

EUROMOTO85, S.A.

Tel: +34 936 376 611

Fax: +34 936 376 092

euromoto85@euromoto85.es

www.euromoto85.es



Filtros de alto rendimiento



CC	MARCA/MODELO	AÑO	CÓDIGO	FIG.	CÓDIGO OE	CÓDIGO K&N
600	Monster 600	91/01	FMD0449	1	426 100 91A	DU9098
620	Monster 620/S IE	02/06	FMD0468	1	426 101 11A	DU9001
620	Monster 620 DARK	01/06	FMD0468	1	426 101 11A	DU9001
620	Multistrada 620	05/06	FMD0522	104	426 101 31A	DU1004
620	Multistrada Dark 620	05/	FMD0522	104	426 101 31A	DU1004
620	Sport 620	03/	FMD0449	1	426 100 91A	DU9001
620	Sport 620 IE	02/03	FMD0449	1	426 100 91A	DU9098
695	Monster 695	07/	FMD0468	1	426 101 11A	DU9001
750	Paso 750	87/88	FMD0449	1	426 100 91A	DU9098
750	Monster 750	96/01	FMD0449	1	426 100 91A	DU9098
750	Monster 750 IE	02/	FMD0468	1	426 101 11A	DU9001
750	Sport 750	01/02	FMD0449	1	426 100 91A	DU9097
750	Supersport 750	91/02	FMD0449	1	426 100 91A	DU9098
800	Monster 800S/IE	03/04	FMD0468	1	426 101 11A	DU9001
800	Sport 800	03/04	FMD0449	1	426 100 91A	DU9098
800	Supersport 800	03/	FMD0449	1	426 100 91A	DU9098
800	Monster S2R	05/	FMD0468	1	426 101 11A	DU9001
800	Monster Dark S2R	05/06	FMD0468	1	426 101 11A	DU9001
851	Superbike 851	91/92	FMD0449	1	426 100 91A	DU9098
888	Superbike 888	93/95	FMD0449	1	426 100 91A	DU9098
900	Paso 900	87/88	FMD0449	1	426 100 91A	DU9098
900	MHE 900	01/02	FMD0468	1	426 101 11A	DU9001
900	Monster 900	93/99	FMD0449	1	426 100 91A	DU9001
900	Monster 900 IE	00/01	FMD0449	1	426 100 91A	DU9098
900	Monster 900 IE	02/	FMD0468	1	426 101 11A	DU9001
900	Sport 900	02/	FMD0449	1	426 101 11A	DU9098
900	Superlight 900	93/94	FMD0449	1	426 100 91A	DU9098
900	Supersport 900	91/99	FMD0449	1	426 100 91A	DU9098
900	Supersport 900 IE	00/02	FMD0449	1	426 100 91A	DU9098
907	907 IE	90/93	FMD0449	1	426 100 91A	DU9098
916	Monster S4 916	01/03	FMD0468	1	426 101 11A	DU9001
916	ST4 916	99/04	FMD0449	1	426 100 91A	DU9098
944	ST2 944	97/03	FMD0449	1	426 100 91A	DU9098
996	Monster S4R 996	03/05	FMD0468	1	426 101 11A	DU9001
996	ST4S 996	01/04	FMD0449	1	426 100 91A	DU9098
996	ST4S ABS 996	01/04	FMD0449	1	426 100 91A	DU9098
998	Monster S4RS Testastretta 998	06/	FMD0468	1	426 201 11A	DU9001
1000	Monster 1000/IE	03/	FMD0468	1	426 201 11A	DU9001
1000	Monster 1000 S IE	03/	FMD0468	1	426 201 11A	DU9001
1000	Monster S2R 1000	06/	FMD0468	1	426 201 11A	DU9001
1000	Multistrada DS1000	03/06	FMD0522	104	426 101 31A	DU1004
1000	ST3 1000	04/	FMD0449	1	426 100 91A	DU9098
1000	Supersport 1000DS	03/	FMD0449	1	426 100 91A	DU9098
1078	Multistrada 1100/1100S	07/	FMD0522	104	426 101 31A	DU1004
E-TON						
250	VectorR	05 /	FQA022	102	—	—
HARLEY DAVIDSON						
883	XL53C Sportster Custom	00/	FMHD0563	142	29331-96/29036-88B	HD1388
883	XL883C Sportster Custom	03/	FMHD0563	142	29331-96/29036-88B	HD1388
883	XL883R Sportster	02/03	FMHD0563	142	29331-96/29036-88B	HD1388

238

Filtros de alto rendimiento

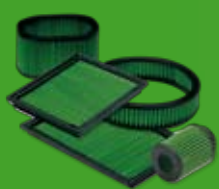

Filtros de alto rendimiento



CC	MARCA/MODELO	AÑO	CÓDIGO	FIG.	CÓDIGO OE	CÓDIGO K&N
883	XLH883 Sportster	88/03	FMHD0563	142	29331-96/29036-88B	HD1388
883	XLH883 Sportster Custom	99/02	FMHD0563	142	29331-96/29036-88B	HD1388
883	XLH883 Sportster Deluxe	88/95	FMHD0563	142	29331-96/29036-88B	HD1388
883	XLH883 Sportster Hugger	88/03	FMHD0563	142	29331-96/29036-88B	HD1388
883	XLH883R Sportster Flat Track	00/03	FMHD0563	142	29331-96/29036-88B	HD1388
1130	VRSCA V-Rod	02/06	FMHD0541	16	2943701	HD1102
1130	VRSCB V-Rod	04/05	FMHD0541	16	2943701	HD1102
1130	VRSCD Night Rod	06/	FMHD0541	16	2943701	HD1102
1130	VRSCR Street Rod	05/	FMHD0541	16	2943701	HD1102
1200	XL1200C Sportster Custom	96/03	FMHD0563	142	29331-96/29036-88B	HD1388
1200	XL1200S Sportster Sport	96/03	FMHD0563	142	29331-96/29036-88B	HD1388
1200	XLH1200 Sportster	88/02	FMHD0563	142	29331-96/29036-88B	HD1388
1200	XLH1200 Sportster ANNV	93/03	FMHD0563	142	29331-96/29036-88B	HD1388
1250	VRFCDX Night Rod/Night Rod Special	06/	FMHD0541	16	2943701	HD1102
1340	Carbureted (Evolution Eng.)	90/99	FMHD0470	54	29330-96/29259-91A	HD1390
1340	FLHR Electra Glide Road King	94/00	FMHD0470	54	29330-96/29259-91A	HD1390
1340	FLHS Electra Glide	95/98	FMHD0470	54	29330-96/29259-91A	HD1390
1340	FLHS Electra Glide Sport	90/93	FMHD0470	54	29330-96/29259-91A	HD1390
1340	FLHT Electra Glide	95/98	FMHD0470	54	29330-96/29259-91A	HD1390
1340	FLHTC	90/	FMHD0470	54	29330-96/29259-91A	HD1390
1340	FLHTC Classic Anniversary	93/	FMHD0470	54	29330-96/29259-91A	HD1390
1340	FLHTC Electra Glide Classic	91/98	FMHD0470	54	29330-96/29259-91A	HD1390
1340	FLHTCU Ultra	90/	FMHD0470	54	29330-96/29259-91A	HD1390
1340	FLHTCU Ultra Anniversary	93/	FMHD0470	54	29330-96/29259-91A	HD1390
1340	FLHTCU Ultra Classic	91/98	FMHD0470	54	29330-96/29259-91A	HD1390
1340	FLHTCU Ultra W/SC	90/92	FMHD0470	54	29330-96/29259-91A	HD1390
1340	FLHTCU Electra Glide Ultra Classic	90/	FMHD0470	54	29330-96/29259-91A	HD1390
1340	FLST Heritage Softail	90/	FMHD0470	54	29330-96/29259-91A	HD1390
1340	FLSTC	90/	FMHD0470	54	29330-96/29259-91A	HD1390
1340	FLSTC Heritage Softail Classic	90/00	FMHD0470	54	29330-96/29259-91A	HD1390
1340	FLSTF Fat Boy	90/00	FMHD0470	54	29330-96/29259-91A	HD1390
1340	FLSTN Heritage Softail Nostalgia	93/95	FMHD0470	54	29330-96/29259-91A	HD1390
1340	FLSTN Heritage Softail Special	96/98	FMHD0470	54	29330-96/29259-91A	HD1390
1340	FLSTN Heritage Springer	97/99	FMHD0470	54	29330-96/29259-91A	HD1390
1340	FLSTS Heritage Springer	97/99	FMHD0470	54	29330-96/29259-91A	HD1390
1340	FLTC Tour Glide Classic	90/91	FMHD0470	54	29330-96/29259-91A	HD1390
1340	FLTC Tour Glide Classic W/SC	91/	FMHD0470	54	29330-96/29259-91A	HD1390
1340	FLTCU Ultra	90/91	FMHD0470	54	29330-96/29259-91A	HD1390
1340	FLTCU Ultra TG Anniversary	93/	FMHD0470	54	29330-96/29259-91A	HD1390
1340	FLTCU Ultra TG W/SC	91/92	FMHD0470	54	29330-96/29259-91A	HD1390
1340	FLTCU Ultra W/SC	90/	FMHD0470	54	29330-96/29259-91A	HD1390
1340	FLTCU Ultra TG Classic	90/95	FMHD0470	54	29330-96/29259-91A	HD1390
1340	FLTR Road Glide	98/00	FMHD0470	54	29330-96/29259-91A	HD1390
1340	FXD Dyna Super Glide	95/00	FMHD0470	54	29330-96/29259-91A	HD1390
1340	FXDB Dyna Daytona	92/	FMHD0470	54	29330-96/29259-91A	HD1390
1340	FXDB Dyna Sturgis	91/	FMHD0470	54	29330-96/29259-91A	HD1390
1340	FXDC Dyna Glide Custom	92/	FMHD0470	54	29330-96/29259-91A	HD1390
1340	FXDL Dyna Low Rider	93/98	FMHD0470	54	29330-96/29259-91A	HD1390
1340	FXDS-CONV Dyna Convertable	96/00	FMHD0470	54	29330-96/29259-91A	HD1390
1340	FXDS-CONV Dyna Low Rider	94/95	FMHD0470	54	29330-96/29259-91A	HD1390
1340	FXDWG Dyna Wide Glide	93/00	FMHD0470	54	29330-96/29259-91A	HD1390
1340	FXDWG Dyna Wide Glide Anniversary	93/	FMHD0470	54	29330-96/29259-91A	HD1390

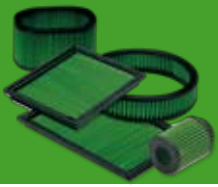

Filtros de alto rendimiento



CC	MARCA/MODELO	AÑO	CÓDIGO	FIG.	CÓDIGO OE	CÓDIGO K&N
1340	FXLR Low Rider Custom	90/94	FMHD0470	54	29330-96/29259-91A	HD1390
1340	FXLR Low Rider Custom Anniversary	93/	FMHD0470	54	29330-96/29259-91A	HD1390
1340	FXR Super Glide	90/94	FMHD0470	54	29330-96/29259-91A	HD1390
1340	FXRS-CONV	90/93	FMHD0470	54	29330-96/29259-91A	HD1390
1340	FXRS Lox Rider	90/93	FMHD0470	54	29330-96/29259-91A	HD1390
1340	FXRS-SP Low Rider Sport	90/93	FMHD0470	54	29330-96/29259-91A	HD1390
1340	FXRT Sport Glide	90/92	FMHD0470	54	29330-96/29259-91A	HD1390
1340	FXST Softail	90/99	FMHD0470	54	29330-96/29259-91A	HD1390
1340	FXSTB Night Train	99/	FMHD0470	54	29330-96/29259-91A	HD1390
1340	FXSTC Softail Custom	90/99	FMHD0470	54	29330-96/29259-91A	HD1390
1340	FXSTS Springer Softail	90/00	FMHD0470	54	29330-96/29259-91A	HD1390
1340	FXSTS SPRINGER SOFTAIL	01/05	FMHD0459	53	29461-99	HD1390
1340	FXSTSB Bad Boy	95/97	FMHD0470	54	29330-96/29259-91A	HD1499
1340	FXSTSI Springer Softail	01/	FMHD0459	53	29461-99	HD1499
1450	Carbureted (Twin Cam Eng.)	99/00	FMHD0459	53	29461-99	HD1499
1450	FLHR Road King	99/	FMHD0459	53	29461-99	HD1499
1450	FLHR Electra Glide Road King	99/03	FMHD0459	53	29461-99	HD1499
1450	FLHRI Electra Glide Road King F/I	00/01	FMHD0566	147	29461-99	HD1499
1450	FLHRCI Road King Classic F/I	99/01	FMHD0566	147	29461-99	HD1499
1450	FLHRCI Road King Classic	02/03	FMHD0459	53	29461-99	HD1499
1450	FLHT Electra Glide Classic	99/02	FMHD0459	53	29461-99	HD1499
1450	FLHT Electra Glide/STD	99/03	FMHD0459	53	29461-99	HD1499
1450	FLHTC Electra Glide Classic	99/05	FMHD0459	53	29461-99	HD1499
1450	FLHTCI Electra Glide Classic F/I	99/01	FMHD0566	147	29461-99	HD1499
1450	FLHTCI Electra Glide Classic	02/	FMHD0459	53	29461-99	HD1499
1450	FLHTCU Electra Glide Ultra Classic	02/	FMHD0459	53	29461-99	HD1499
1450	FLHTCUI Ultra Classic Electra Glide F/I	99/01	FMHD0566	147	29461-99	HD1499
1450	FLSTC Heritage Softail Classic	00/03	FMHD0459	53	29461-99	HD1499
1450	FLSTCI Heritage Softail Classic F/I	01/	FMHD0566	147	29461-99	HD1499
1450	FLSTCI Heritage Softail Classic	02/05	FMHD0459	53	29461-99	HD1499
1450	FLSTF Fat Boy	00/05	FMHD0459	53	29461-99	HD1499
1450	FLSTFI Fat Boy	01/05	FMHD0459	53	29461-99	HD1499
1450	FLSTS Heritage Springer	00/	FMHD0459	53	29461-99	HD1499
1450	FLSTS Heritage Springer	02/03	FMHD0459	53	29461-99	HD1499
1450	FLSTSI Heritage Springer	01/	FMHD0459	53	29461-99	HD1499
1450	FLTR Road Glide	99/02	FMHD0459	53	29461-99	HD1499
1450	FLTRI Road Glide F/I	99/01	FMHD0566	147	29461-99	HD1499
1450	FLTRI Road Glide	02/	FMHD0459	53	29461-99	HD1499
1450	FXD Dyna Super Glide	99/05	FMHD0459	53	29461-99	HD1499
1450	FXDL Dyna Low Rider	99/05	FMHD0459	53	29461-99	HD1499
1450	FXDS Dyna Convertible	99/00	FMHD0459	53	29461-99	HD1499
1450	FXDWG Dyna Wide Glide	99/05	FMHD0459	53	29461-99	HD1499
1450	FXDX Dyna Super Glide	99/	FMHD0459	53	29461-99	HD1499
1450	FXDX Dyna Super Glide Sport	99/04	FMHD0459	53	29461-99	HD1499
1450	FXDXT Dyna Super Glide Sport	01/03	FMHD0459	53	29461-99	HD1499
1450	FXST Softail	00/05	FMHD0459	53	29461-99	HD1499
1450	FXSTB Night Train	00/05	FMHD0459	53	29461-99	HD1499
1450	FXSTBI Night Train	01/	FMHD0459	53	29461-99	HD1499
1450	FXSTD Softail Deuce	00/05	FMHD0459	53	29461-99	HD1499
1450	FXSTDI Softail Deuce	01/05	FMHD0459	53	29461-99	HD1499

240

Filtros de alto rendimiento

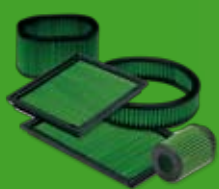

Filtros de alto rendimiento



CC	MARCA/MODELO	AÑO	CÓDIGO	FIG.	CÓDIGO OE	CÓDIGO K&N
GAS GAS						
240	Wild HP 240	05/	FQG040	164	BE250128000	—
300	Wild HP 300	05/	FQG040	164	BE250128000	—
450	Wild HP 450	05/06	FQG040	164	BE250128000	—
450	Wild HP 450	07/	FQG041	25	BQ450728000	—
GOES						
196	220	05/	FQA022	105	—	—
HONDA						
125	CBR 125 R	05/06	FMH0548	127	17210-KPP-900	HA1502
125	NX 125	—	FMH0562	141	—	—
125	SH 125, @ 125 , Dylan 125	05/	FMH0596	180	17210-KGF-900	—
125	PS 125 i	06/	FMH0596	180	17210-KGF-900	—
125	XL 125 Varadero	01/06	FMH0570	151	—	—
125	VT 125C Shadow	99/	FMH0560	5	17210-MBG-000	HA8098
150	SH 150, @ 150, Dyalna 150	05/	FMH0596	180	17210-KGF-900	—
400	CB 400 Super Four	—	FMH0545	109	17230-MY9-000	HA5094
500	CB 500	94/99	FMH0545	109	17230-MY9-000	HA5094
500	CBF 500	04/	FMH0473	21	17230-KEA-020	HA6098
600	CB 600 Hornet	98/	FMH0473	21	17230-KEA-020	HA6098
600	CBF 600 /S	98/05	FMH0473	21	17230-KEA-020	HA6098
600	CBF 600 F	05/	FMH0473	21	17230-KEA-020	HA6098
600	CBR 600 F	01/06	FMH0567	148	17210-MBW-D21	HA6001
600	CBR 600 (FR/FS)	01/04	FMH0567	148	17210-MBW-D21	HA6001
600	CBR 600 F4I	01/04	FMH0567	148	17210-MBW-D21	HA6001
650	FMX 650	05/08	FMH0598	185	17225-MAK-E20	HA6505
650	NX 650 Dominator	88/00	FMH0474	5	17213-MN9-000	HA0001
750	CB 750 Nightawk	91/03	FMH0583	168	17211-MJ0-950	HA7591
750	CB 750 Seventy	96/02	FMH0583	168	17211-MJ0-950	HA7591
750	CBX 750	84/86	FMH0583	168	17211-MJ0-950	HA7591
750	VT 750 Shadow A.C.E	98/00	FMH0573	72	17213-MBA-000/010	HA7500
750	VT 750 Shadow A.C.E DELUXE	01/03	FMH0573	72	17213-MBA-000/010	HA7500
750	VT 750 Shadow Aero	04/05	FMH0552	91	17213-MEG-000	HA7504
750	VT 750 Shadow Deluxe	98/01	FMH0573	72	17213-MBA-000/010	HA7500
750	VT 750 Shadow Spirit	98/03	FMH0573	72	17213-MBA-000/010	HA7500
750	VT 750 DC Shadow Spirit	05/06	FMH0573	72	17213-MBA-000/010	HA7500
800	VFR 800 F Interceptor	98/05	FMH0550	128	17210-MBG-000	HA8098
800	VFR 800 V-TEC	02/	FMH0550	128	17210-MBG-000	HA8098
900	CB 900 Hornet	02/	FMH0572	21	17210-MCZ-003	HA6098
900	CB 900 F Hornet	05/	FMH0572	21	17210-MCZ-003	HA6098
919	CB 919	02/	FMH0572	21	17210-MCZ-003	HA6098
1000	CB 1000 R	08/	FMH0603	73	17210-MFL-000	—
1000	CBR 1000 RR (2 filtros por moto)	04/	FMH0530	86	17210-MEL-000	HA1004
1000	CBR 1000 RR Fireblade (2 filtros por moto)	04/	FMH0530	86	17210-MEL-000	HA1004
1000	CBR 1000 RR Repsol Edition (2 filtros por moto)	05/	FMH0530	86	17210-MEL-000	HA1004
1000	RC 51 (2 filtros por moto)	00/05	FMH0475	77	17235-MCF-000/A20/D30	HA5100
1000	VTR1000 Firestorm	97/05	FMH0571	152	17210-MBB-000	HA0011
1000	VTR1000 Super Hawk	97/05	FMH0571	152	17210-MBB-000	HA0011
1000	VTR 1000 SP1 (2 filtros por moto)	00/	FMH0475	77	17235-MCF-000/A20/D30	HA5100
1000	VTR 1000 SP2 (2 filtros por moto)	00/	FMH0475	77	17235-MCF-000/A20/D30	HA5100
1000	XL1000 Varadero	99/02	FMH0571	152	17210-MBB-000	HA-0011

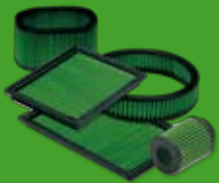

EUROMOTO85, S.A.

Tel: +34 936 376 611

Fax: +34 936 376 092

euromoto85@euromoto85.es

www.euromoto85.es



Filtros de alto rendimiento



CC	MARCA/MODELO	AÑO	CÓDIGO	FIG.	CÓDIGO OE	CÓDIGO K&N
1300	CB 1300	01/	FMH0544	21	17210-MEJ-000	HA1301
1300	ST 1300	02/	FMH0590	72	17210-MCS-G00	HA1302
1300	ST 1300 Pan European	02/	FMH0590	72	17210-MCS-G00	HA1302
1500	GL 1500 Gold Wing	88/90	FMH0587	163	17205-MN5-003	HA8088
1500	GL 1500 SE Gold Wing	90/00	FMH0587	163	17205-MN5-003	HA8088
1500	GL 1500 Gold Wing Aspencade	91/00	FMH0587	163	17205-MN5-003	HA8088
1500	GL 1500 Gold Wing Interstate	91/96	FMH0587	163	17205-MN5-003	HA8088
HONDA ATV/QUAD						
250	250 R Fourtrax	86/89	FQH003	25	17213-HB9-770	—
250	TRX 250 EX	89/00	FQH003	25	17213-HB9-770	—
		01/06	FQH024	110	17254-HM-800	HA-2501
250	TRX 250 Recon	97/01	FQH003	25	17254-HM-8680	HA-2597
		02/06	FQH024	110	17254-HM-800	HA-2501
250	TRX 250 R Fourtrax	86/90	FQH003	25	17213-HB9-770	—
300	TRX 300 EX	93/05	FQB015	29	17254-HC0-680	HA-3094
400	TRX 400 EX	99/	FQH028	82	17254-HN-1000	HA-4099
450	TRX 450 R	04/06	FQH032	105	17254-HP-1000	HA-4504
		07/	FQB012	82	17254-HP-1600	BD6500
500	TRX 500 Foreman Rubicon	00/07	FQH025	105	17254-HN-1000	HA-5000
500	TRX 500 Foreman	05/07	FQH025	105	17254-HN-1000	HA-5000
500	TRX 500 Foreman 4X4	05/07	FQH025	105	17254-HN-1000	HA-5000
650	TRX 650 Rincon	03/05	FQH025	105	17254-HN-1000	HA-5000
HYTRACK						
265	HY265	04/	FQP002	40	—	—
JOHN DEERE						
500	Buck 500	05/	FQB015	29	707.800.072	BD6502
500	Buck EX 500	05/	FQB015	29	707.800.072	BD6502
500	Buck EXT 500	05/	FQB015	29	707.800.072	BD6502
500	Trail Buck 500	05/	FQB015	29	707.800.072	BD6502
650	Trail Buck 650	05/	FQB015	29	707.800.072	BD6502
650	Trail Buck EX 650	05/	FQB015	29	707.800.072	BD6502
650	Trail Buck EXT 650	05/	FQB015	29	707.800.072	BD6502
KAWASAKI						
125	KX 125	87/89	FMK0498	60	11013-1150	KA1287
200	KDX 200	89/02	FMK0498	60	11013-1150	KA1287
220	KDX 220	97/00	FMK0498	60	11013-1150	KA1287
220	KDX 220R	01/04	FMK0498	60	11013-1150	KA1287
250	KDX 250	91/94	FMK0498	60	11013-1150	KA1287
250	KDX 250R	94/96	FMK0498	60	11013-1150	KA1287
250	KX 250	87/89	FMK0498	60	11013-1150	KA1287
250	KX 250F	04/05	FMK0549	125	11013-0008	KA2504
250	KLX 250 D / Traker	98/06	FMK0498	60	11013-1150	KA1287
250	KLX 250 R	94/97	FMK0498	60	11013-1150	KA1287
250	KLX 250S	07/	FMK0498	60	11013-1150	KA1287
300	KLX 300	96/	FMK0498	60	11013-1150	KA1287
300	KLX 300R	01/	FMK0498	60	11013-1150	KA1287
400	ZR 400 Zephyr	89/95	FMK0584	165	11013-1013/11013-1157	KA0850
500	ER5	97/05	FMK0469	5	11013-1261	KA0018
500	GPZ 500	87/02	FMK0556	1	—	—

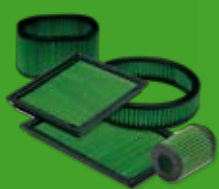

Filtros de alto rendimiento



CC	MARCA/MODELO	AÑO	CÓDIGO	FIG.	CÓDIGO OE	CÓDIGO K&N
500	KX 500	87/03	FMK0498	60	11013-1150	KA1287
550	KZ 550 A	80/83	FMK0584	165	11013-1013/11013-1157	KA0850
550	KZ 550 C LTD	80/83	FMK0584	165	11013-1013/11013-1157	KA0850
550	KZ 550 D GP	81/86	FMK0584	165	11013-1013/11013-1157	KA0850
550	KZ 550 LTD	84/	FMK0584	165	11013-1013/11013-1157	KA0850
550	KZ 550 Spectre	83/84	FMK0584	165	11013-1013/11013-1157	KA0850
550	ZX 550 GPZ	84/86	FMK0584	165	11013-1013/11013-1157	KA0850
550	ZR 550 Zephyr	90/99	FMK0584	165	11013-1013/11013-1157	KA0850
600	ER 6 F	06/08	FMK0582	171	—	—
600	ER 6 N	06/08	FMK0582	171	—	—
600	ZX 600 Ninja	85/87	FMK0584	165	11013-1013/11013-1157	KA0850
600	ZX6R Ninja	98/02	FMK0536	118	11013-1274	KA6098
600	ZX6RR NINJA	03/04	FMK0554	133	11013-1301	KA6003
		05/06	FMK0534	117	11013-0010	KA6005
		07/	FMK0600	188	11013-0016	KA6007
600	ZZR600 US	05/	FMK0536	118	11013-1274	KA6098
600	ZX6R Ninja	95/97	FMK0592	118	110131240	KA6095
636	ZX6R NINJA	98/02	FMK0536	118	11013-1274	KA6098
		03/04	FMK0554	133	11013-1301	KA6003
		05/06	FMK0534	117	11013-0010	KA6005
650	KLE 650 Versys	06/	FMK0582	171	—	—
650	KLX 650R	93/97	FMK0498	60	11013-1150	KA1287
750	Z750	04/08	FMK0527	112	11013-1302	KA1003
750	Z750S	05/08	FMK0527	112	11013-1302	KA1003
750	ZR 750 Zephyr	92/99	FMK0584	165	11013-1013/11013-1157	KA0850
750	ZR 7/S	00/03	FMK0584	165	11013-1013/11013-1157	KA0850
900	ZX9R Ninja	98/03	FMK0538	119	11013-1270	KA9098
1000	KLX 1000	04/05	FMK0579	162	11013-012/3S012	SU1002
1000	Z1000	03/08	FMK0527	112	11013-1302	KA1003
1000	ZX 10 R Ninja	04/	FMK0510	87	11013-0004	KA1004
1100	ZRX1100	97/00	FMK0532	5	11013-1235	KA1199
1100	ZX11 Ninja	93/01	FMK0539	123	11013-1227	KA1093
1100	ZZR1100	93/01	FMK0539	123	11013-1227	KA1093
1200	ZRX1200 /S/R	01/05	FMK0532	5	11013-1235	KA1199
1200	ZX 12 R Ninja (2 filtros por moto)	00/05	FMK0521	101	11029-1016	KA1299
1200	ZZR1200	02/05	FMK0539	123	11013-1227	KA1093
KAWASAKI ATV/QUAD						
360	KVF 360 Prairie 2x4, 4x4, Advantage Classic	03/	FQK029	21	11013-1292	KA3603
360	KVF 360 KL, Hardwoods Green HD	05/	FQK029	21	11013-1292	KA3603
400	KFX 400	03/	FQSK039	109	11013-S011	SU4002
450	KFX 450 R	08/	FQK044	25	110130017	KA4508
650	KFX 650 Pririe 4x4 ATV	03/	FQK014	69	11013-0001	KA6503
650	KVF 650 Prairie 4X4 ATV	03/	FQK014	69	11013-0001	KA6503
650	KVF 650 Brute Force 4X4 ATV, Camo	05/	FQK014	69	11013-0001	KA6503
700	KFX 700 4X4 ATV	03/	FQK014	69	11013-0001	KA6503
700	KFX 700 Prairie 4X4 ATV	03/	FQK014	69	11013-0001	KA6503
700	KFX 700 Special Edition	05/	FQK014	69	11013-0001	KA6503
700	KFX 700 V Force	03/	FQK014	69	11013-0001	KA6503
700	KVF 700 4X4 ATV	04/	FQK014	69	11013-0001	KA6503

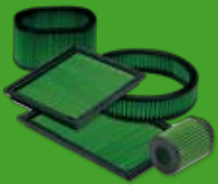

EUROMOTO85, S.A.

Tel: +34 936 376 611

Fax: +34 936 376 092

euromoto85@euromoto85.es

www.euromoto85.es



Filtros de alto rendimiento



CC	MARCA/MODELO	AÑO	CÓDIGO	FIG.	CÓDIGO OE	CÓDIGO K&N
KTM						
60	60 SX	98/08	FMK0547	126	58406015100	—
65	65 SX	98/08	FMK0547	126	58406015100	—
400	400 LC4	00/03	FMK0547	126	58406015100	—
625	625 LC4 SMC	00/04	FMK0547	126	58406015100	—
625	625 LC4 SXC	00/04	FMK0547	126	58406015100	—
625	640 LC4	00/03	FMK0547	126	58406015100	—
640	640 LC4 Adventure	04/	FMK0547	126	58406015100	—
640	640 LC4 Six Days	00/	FMK0547	126	58406015100	—
690	690 Duke	08	FMK0602	1	75006015000	33-2515
KYMCO ATV/QUAD						
250	KXR 250	03/	FQK017	82	1721ALBA790	KY2504
250	Mongoose 250	06/	FQK017	82	1721ALBA790	KY2504
250	MXU 250	04/06	FQK017	82	1721ALBA790	KY2504
250	Urban Quad	04/	FQK017	82	1721ALBA790	KY2504
300	MXU 300	05/	FQK017	82	1721ALBA790	KY2504
300	Maxxer 300	05/	FQK017	82	1721ALBA790	KY2504
LAVERDA						
650	650	95/99	FML0464	1	LAV668S	—
750	750	97/00	FML0463	1	LAV750SF	—
1000	1000 3 CL	76/80	FML0578	159	—	—
LINHAI						
260	LH260H / Yeti	04/	FQP002	40	—	—
MASSEY FERGUSON						
400	400 i	98/05	FQA026	33	—	—
500	500 i	98/05	FQA026	33	—	—
MINICO						
300	Puma 300	04/	FQP002	40	—	—
MOTO GUZZI						
1000	Daytona 1000	94/97	FMG0471	1	30113600	CG9002
1000	Daytona 1000 IE Racing	—	FMG0471	1	30113600	CG9002
1000	Daytona 1000 RS	94/97	FMG0471	1	30113600	CG9002
1000	V10 Centauro	98/	FMG0471	1	30113600	CG9002
1100	1100 Sport	94/97	FMG0471	1	30113600	CG9002
1100	California	94/97	FMG0471	1	30113600	CG9002
1100	California Vintage	06/	FMG0471	1	30113600	CG9002
1100	V11	—	FMG0471	1	30113600	CG9002
1100	V11 Le Mans	—	FMG0471	1	30113600	CG9002
1100	V11 Sport	94/97	FMG0471	1	30113600	CG9002
PGO						
250	Bugrider 250	05/	FQP046	184	M2262030000	—
POLARIS						
200	Phoenix 200	05/	FQP031	105	1253355/0452306	PL1004
200	Sawtooth 200	06/	FQP031	105	1253355/0452306	PL1004
250	Trail Blazer 250 2X4	96/00	FQP008	40	1253118/7080369	PL1001
250	Trail Blazer 250	01/	FQP031	105	1253355/0452306	PL1004
250	Trail Boss 250	96/99	FQP008	40	1253118/7080369	PL1001

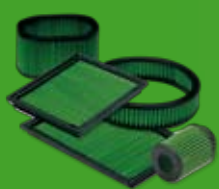

Filtros de alto rendimiento



CC	MARCA/MODELO	AÑO	CÓDIGO	FIG.	CÓDIGO OE	CÓDIGO K&N
250	Xplorer 250 4X4	00/	FQP008	40	1253118/7080369	PL1001
300	Hawkeye 300 2X4	06/	FQP031	105	1253355/0452306	PL1004
300	Hawkeye 300 4X4	06/	FQP031	105	1253355/0452306	PL1004
300	Xplorer 300 4X4	96/99	FQP008	40	1253118/7080369	PL1001
300	Xpress 300	96/99	FQP008	40	1253118/7080369	PL1001
325	Magnum 325 2X4	00/01	FQP002	40	1253144/7080595	PL1003
325	Magnum 325 4X4	00/01	FQP002	40	1253144/7080595	PL1003
325	Magnum 325 2X4	01/02	FQP035	27	1253372	PL1005
325	Magnum 325 4X4	01/02	FQP035	27	1253372	PL1005
325	Trail Boss 325	00/01	FQP002	40	1253144/7080595	PL1003
325	Trail Boss 325 2X4	01/02	FQP035	27	1253372	PL1005
325	Xpedition 325	00/02	FQP002	40	1253144/7080595	PL1003
330	Magnum 330 2X4	03/05	FQP035	27	1253372	PL1005
330	Magnum 330 4X4	03/05	FQP035	27	1253372	PL1005
330	Trail Boss 330	03/06	FQP035	27	1253372	PL1005
330	ATP 330	04/05	FQP035	27	1253372	PL1005
335	Sportsman 335	99/01	FQP002	40	1253144/7080595	PL1003
400	Big Boss 6X6 400L	96/97	FQP008	40	1253118/7080369	PL1001
400	Sportsman 400	04/	FQP002	40	1253144/7080595	PL1003
400	Sportsman 400 2X4	01/	FQP002	40	1253144/7080595	PL1003
400	Sportsman 400 4X4	95/96	FQP008	40	1253118/7080369	PL1001
400		02/	FQP002	40	1253144/7080595	PL1003
400	Xplorer 400L	96/98	FQP008	40	1253118/7080369	PL1003
400		01/	FQP031	105	1253355/0452306	PL1004
425	Xpedition 425	00/02	FQP002	40	1253144/7080595	PL1003
450	Sportsman 450	06/07	FQP002	40	1253144/7080595	PL1003
455	Diesel 455 4X4	99/	FQP002	40	1253144/7080595	PL1003
500	ATP 500 HO	04/	FQP002	40	1253144/7080595	PL1003
500	Magnum 500 4X4	99/03	FQP002	40	1253144/7080595	PL1003
500	Predator 500	03/	FQP020	1	5830226/2873083	PL5003
500	Predator Troy Lee 500	05/	FQP020	1	5830226/2873083	PL5003
500	Ranger 6X6	99/00	FQP002	40	1253144/7080595	PL1003
500	Scrambler 500	97/05	FQP002	40	1253144/7080595	PL1003
500	Scrambler 500 2X4	02/	FQP002	40	1253144/7080595	PL1003
500	Scrambler 500 4X4	97/05	FQP002	40	1253144/7080595	PL1003
500	Sportsman 500	96/05	FQP002	40	1253144/7080595	PL1003
500	Sportsman 500 6X6	00/04	FQP002	40	1253144/7080595	PL1003
500	Sportsman 500 HO 4X4	02/03	FQP002	40	1253144/7080595	PL1003
500	Sportsman 500 HO/HO Mossy OAK	04/	FQP002	40	1253144/7080595	PL1003
500	Xplorer 500 4X4	97/	FQP002	40	1253144/7080595	PL1003
525	Outlaw 525	08/	FQB012	82	2520738	PL5207
600	Sportsman 600 4X4	01/	FQP002	40	1253144/7080595	PL1003
700	Sportsman 700 4X4	01/	FQP002	40	1253144/7080595	PL1003
700	Sportsman 700 Twin	04/	FQP002	40	1253144/7080595	PL1003
700	Sportsman 700 Twin EFI	04/	FQP002	40	1253144/7080595	PL1003
700	Sportsman 700 MV	05/	FQP002	40	1253144/7080595	PL1003
700	Sportsman 700 Twin Mossy OAK	04/	FQP002	40	1253144/7080595	PL1003
800	Sportsman 800 Twin F/I	05/	FQP002	40	1253144/7080595	PL1003
SCORPA						
250	SY 250 F	06/	FMS0509	86	—	—

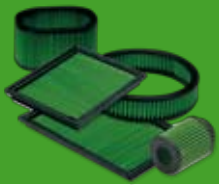

Filtros de alto rendimiento



CC	MARCA/MODELO	AÑO	CÓDIGO	FIG.	CÓDIGO OE	CÓDIGO K&N
SUMICO						
250	G-Part I 250	05/	FQY013	21	5GH-14451-00-00	—
250	Hunter 250	05/	FQY013	21	5GH-14451-00-00	—
SUZUKI						
125	GN 125	87/01	FMS0588	173	—	—
250	RMZ250	04/	FMK0549	125	110130008	KA2504
500	GS 500	01/	FMS0591	146	13780-01D51/D00/D01/D20	SU5589
500	GS 500E	89/00	FMS0591	146	13780-01D51/D00/D01/D20	SU5589
500	GS 500F	04/	FMS0591	146	13780-01D51/D00/D01/D20	SU5589
600	GSF 600 Bandit	96/99	FMS0517	96	13780-17E00	SU7593
		00/03	FMS0516	96	13780-31F00	SU6000
600	GSF 600 Bandit S	97/99	FMS0517	96	13780-17E00	SU7593
		00/04	FMS0516	96	13780-31F00	SU6000
600	GSX 600 F	88/05	FMS0569	150	13780-20C00	SU7592
600	GSX 600 F Katana	88/	FMS0569	150	13780-20C00/48B10	SU7592
600	GSR 600	06/07	FMS0595	179	13780-44G00	SU6006
600	GSX-R 600	97/00	FMS0520	72	13780-33E00/01	SU7596
		01/03	FMS0480	68	13780-35F00	SU7500
		04/05	FMS0597	181	13780-29G00	SU7504
		06/08	FMS0599	179	13780-01H00	SU7506
600	GSX-R 600/W	92/93	FMS0517	96	13780-17E00	SU7593
650	DL 650 V-Strom	04/	FMK0579	162	13780-06G00	SU1002
650	GSF 650 Bandit N/S	05/08	FMS0516	96	13780-31F00	SU6000
650	SV 650/S	99/02	FMS0546	124	13780-20F10	SU6599
		03/05	FMS0557	136	13780-16F00	SU6503
700	GV 700 Madura	85/86	FMS0591	146	13780-01D51/D00/D01/D20	SU5589
750	GSX 750 F	89/05	FMS0569	150	13780-20C00	SU7592
750	GSX 750 F Katana	89/06	FMS0569	150	13780-20C00/48B10	SU7592
750	GSX 750 Retro	98/99	FMS0591	146	13780-01D51/D00/D01/D20	SU5589
750	GSX-R 750	96/99	FMS0520	72	13780-33E00/01	SU7596
		00/03	FMS0480	68	13780-35F00	SU7500
750	GSX-R 750 W	93/95	FMS0517	96	13780-17E00	SU7593
750	GSXR 750	04/05	FMS0597	181	13780-29G00	SU7504
		06/07	FMS0599	179	13780-01H00	SU7506
1000	DL 1000 V-Strom/GT	02/08	FMK0579	162	13780-06G00	SU1002
1000	GSX-R 1000	00/04	FMS0480	68	13780-35F00	SU7500
		05/08	FMS0555	68	13780-41G00	SU1005
1000	SV 1000/S	03/05	FMS0557	136	13780-16F00	SU6503
1000	TL 1000S	97/01	FMS0489	72	13780-02F00	SU0007
1100	GSX 1100 F	88/94	FMS0569	150	13780-20C00	SU7592
1100	GSX 1100 F Katana	87/94	FMS0569	150	13780-20C00/48B10	SU7592
1100	GSX-R 1100 W	93/98	FMS0517	96	13780-17E00	SU7593
1200	GSF 1200 Bandit S	99/00	FMS0517	96	13780-17E00	SU7593
		01/05	FMS0516	96	13780-31F00	SU6000
1200	GSF 1200 Bandit	96/00	FMS0517	96	13780-17E00	SU7593
		01/03	FMS0516	96	13780-31F00	SU6000
1200	GV 1200 Madura	85/86	FMS0591	146	13780-01D51/D00/D01/D20	SU5589
1250	GSF Bandit N/S	07/	FMS0516	96	13780-31F00	SU6000
1300	GSX 1300R Hayabusa	99/07	FMS0467	52	13780-24F00	SU1399
1400	GSX 1400	01/08	FMS0565	146	13780-42F00	SU1402
1500	VL 1500LC Intruder	98/05	FMS0528	113	13780-10F00	SU1598

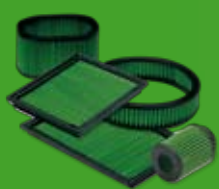

Filtros de alto rendimiento



CC	MARCA/MODELO	AÑO	CÓDIGO	FIG.	CÓDIGO OE	CÓDIGO K&N
SUZUKI ATV/QUAD						
250	LTF 250 Ozark	02/05	FQSK023	109	13780-05G00	SU-2504
250	QuadSport LTZ 250	04/	FQSK023	109	13780-05G00	SU-2504
400	LTZ 400	02/	FQSK039	109	11013-S011	SU-4002
400	Z 400 QuadSport	03/	FQSK039	109	11013-S011	SU-4002
450	LT-R QuadRacer 450	06/	FQS041	109	13780-45G00	—
700	TWIN Peaks LTV 700 4X4 ATV	03/	FQK014	69	11013-0001	KA6503
SYM ATV/QUAD						
250	Quad Lander	05/	FQA022	105	—	—
TRIUMPH						
600	Daytona 600	04/	FMT0559	1	T2204000	TB6000
600	Speed Four 600	03/	FMT0559	1	T2204000	TB6000
600	TT 600	00/	FMT0559	1	T2204000	TB6000
650	Daytona 650	05/	FMT0559	1	T2204000	TB6000
750	Daytona 750	91/95	FMT0593	177	2202002T031/03T0301/04T0301	TB9091
750	Trident 750	92/97	FMT0593	177	2202002T031/03T0301/04T0301	TB9091
800	America 800	02/	FMT0580	91	T2202450	TB8002
800	Bonneville	01/	FMT0515	91	T2201548	TB9004
800	Bonneville T100	02/04	FMT0515	91	T2201548	TB9004
865	Trhuxton 900	04/	FMT0515	91	T2201548	TB9004
885	Speed Triple T509	97/01	FMT0462	1	T 2201273	TB9097
900	Adventurer 900	96/01	FMT0551	130	T2201200	TB9095
900	Bonneville T100	05/	FMT0515	91	T2201548	TB9004
900	Daytona 900	94/96	FMT0593	177	2202002T031/03T0301/04T0301	TB9091
900	Daytona Super III 900	94/97	FMT0593	177	2202002T031/03T0301/04T0301	TB9091
900	Legend TT 900	99/01	FMT0551	130	T2201200	TB9095
900	Scrambler 900	06/	FMT0515	91	T2201548	TB9004
900	Speedmaster 900	05/	FMT0580	91	T2202450	TB8002
900	Speed Triple 900	94/98	FMT0593	177	2202002T031/03T0301/04T0301	TB9091
900	Sprint 900	95/98	FMT0593	177	2202002T031/03T0301/04T0301	TB9091
900	Thunderbird 900/Sport	95/03	FMT0551	130	T2201200	TB9095
900	Tiger 900	91/98	FMT0593	177	2202002T031/03T0301/04T0301	TB9091
900	Tiger	99/01	FMT0462	1	T 2201273	TB9097
900	Trident 900	91/98	FMT0593	177	2202002T031/03T0301/04T0301	TB9091
900	Trophy 900	91/01	FMT0593	177	2202002T031/03T0301/04T0301	TB9091
955	Daytona 955/955IE	02/05	FMT0535	7	T2201751	TB9002
955	Daytona T595	97/00	FMT0462	1	T 2201273	TB9097
955	Daytona T955	99/01	FMT0462	1	T 2201273	TB9097
955	Speed Triple 955	02/04	FMT0535	7	T2201751	TB9002
955	Speed Triple T509	02/	FMT0535	7	T2201751	TB9002
955	Speed Triple T955	99/01	FMT0462	1	T 2201273	TB9097
955	Sprint RS 955	00/01	FMT0462	1	T 2201273	TB9002
955		02/03	FMT0535	7	T2201751	TB9002
955	Sprint ST 955	99/01	FMT0462	1	T 2201273	TB9097
955		02/04	FMT0535	7	T2201751	TB9002
955	Tiger 955	01/05	FMT0462	1	T 2201273	TB9097
1000	Daytona 1000	91/95	FMT0593	177	2202002T031/03T0301/04T0301	TB9091
1200	Daytona 1200	93/97	FMT0593	177	2202002T031/03T0301/04T0301	TB9091
1200	Trophy 1200	91/03	FMT0593	177	2202002T031/03T0301/04T0301	TB9091
2300	Rocket III	04/	FMT0574	7	T2202203	TB2204

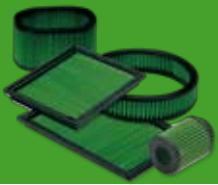

Filtros de alto rendimiento



CC	MARCA/MODELO	AÑO	CÓDIGO	FIG.	CÓDIGO OE	CÓDIGO K&N
URAL						
650	Gear Up	/03	FMU0594	5	GB7904	—
650	Patrol	/03	FMU0594	5	GB7904	—
650	Raven	/03	FMU0594	5	GB7904	—
650	Retro	/03	FMU0594	5	GB7904	—
650	Tourist	/03	FMU0594	5	GB7904	—
650	Troyka	/03	FMU0594	5	GB7904	—
650	Wolf	/03	FMU0594	5	GB7904	—
750	Gear Up	04/	FMU0594	5	GB7904	—
750	Patrol	04/	FMU0594	5	GB7904	—
750	Raven	04/	FMU0594	5	GB7904	—
750	Retro	04/	FMU0594	5	GB7904	—
750	Tourist	04/	FMU0594	5	GB7904	—
750	Troyka	04/	FMU0594	5	GB7904	—
750	Wolf	04/	FMU0594	5	GB7904	—
VOXAN						
1000	Black Magic 1000	05/	FMV0478	5	F0155104XS	—
1000	Cafe Racer 1000	99/	FMV0478	5	F0155104XS	—
1000	Charade Racing	05/	FMV0478	5	F0155104XS	—
1000	New Roaster	04/	FMV0478	5	F0155104XS	—
1000	Roaster	99/	FMV0478	5	F0155104XS	—
1000	Roxter 1000	99/03	FMV0478	5	F0155104XS	—
1000	Scrambler 1000	99/	FMV0478	5	F0155104XS	—
1000	Street Scrambler 1000	04/	FMV0478	5	F0155104XS	—
YAMAHA						
125	DT 125 E	89/90	FMY0564	145	3BN-14451-0000	—
125	DT 125 R	91/05	FMY0564	145	3BN-14451-0000	—
125	DT 125 RE	91/05	FMY0564	145	3BN-14451-0000	—
125	DT 125 MX	91/05	FMY0564	145	3BN-14451-0000	—
125	DT 125 X	91/05	FMY0564	145	3BN-14451-0000	—
125	TDR 125	89/93	FMY0564	145	4FU-14451-0000	—
125	XQ 125 Maxter	98/02	FRSC003	5	5DS-E4451-00	YA2598
125	XN 125 Teo's	00/03	FRSC003	5	5DS-E4451-00	YA2598
125	XV 125	97/00	FMY0576	141	2UJ-14451-0000/4KF-14451-0000	—
125	XV 125 S	97/00	FMY0576	141	2UJ-14451-0000/4KF-14451-0000	—
125	YZ 125	97/07	FMY0586	164	4XM-14451-0000	YA4098-1
125	YP 125 Majesty	01/02	FRSC003	5	5DS-E4451-00	YA2598
150	XQ 150 Maxter 150	01/02	FRSC003	5	5DS-E4451-00	YA2598
150	XN 150 Teo's	00/03	FRSC003	5	5DS-E4451-00	YA2598
150	YM 150	99/	FRSC003	5	5DS-E4451-00	YA2598
150	YP 150 Majesty 150	00/02	FRSC003	5	5DS-E4451-00	YA2598
180	YP 180 Majesty 180	03/	FRSC003	5	5DS-E4451-00	YA2598
200	DT	88/	FMY0564	145	4FU-14451-0000	—
240	XV 240	/94	FMY0576	141	2UJ-14451-0000/4KF-14451-0000	—
250	WR 250 F	03/07	FMY0488	71	5TJ-14451-0000	YA4503
240	XV 250 Virago	95/98	FMY0576	141	2UJ-14451-0000/4KF-14451-0000	—
240	XV 250 S Virago	95/98	FMY0576	141	2UJ-14451-0000/4KF-14451-0000	—
250	WR 250 F	01/02	FMY0586	164	4XM-14451-0000	YA4098-1
250	YZ 250	97/07	FMY0586	164	4XM-14451-0000	YA4098-1
250	YZ 250 F	01/05	FMY0586	164	4XM-14451-0000	YA4098-1
400	WR 400 F	98/02	FMY0586	164	4XM-14451-0000	YA4098-1

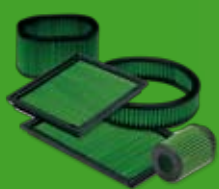

Filtros de alto rendimiento



CC	MARCA/MODELO	AÑO	CÓDIGO	FIG.	CÓDIGO OE	CÓDIGO K&N
400	YZ 400 F	98/99	FMY0586	164	4XM-14451-0000	YA4098-1
426	WR 426 F	01/02	FMY0586	164	4XM-14451-0000	YA4098-1
426	YZ 426 F	00/02	FMY0586	164	4XM-14451-0000	YA4098-1
450	WR 450 F	03/07	FMY0488	71	5TJ-14451-0000	YA4503
450	YZ 450 F	03/06	FMY0586	164	4XM-14451-0000	YA4098-1
500	500 XT E	96/02	FMY0506	80	4PT-44510-100	YA6090
500	FZR 500	92/02	FMY0494	49	1WG-14451-0000	YA6089
500	XP 500 T Max	01/	FPSC004	1	4BH-14451-0000	YA5001
600	600 XT E	95/03	FMY0506	80	4PT-14451-0100	YA5001
600	660 XTZ Tenere	96/	FMY0506	80	4PT-14451-0100	YA6090
600	FZ 6 N/S	04/07	FMY0491	78	5VX-14451-0000	YA6004
600	FZR 600 /M/N	89/99	FMY0494	49	1WG-14451-0000	YA6089
600	FZS 600 S/SP Fazer	98/03	FMY0477	67	4YR-14451-0100	YA6098
600	FZS 600 Fazer	04/	FMY0491	78	5VX-14451-0000	YA6089
600	XJ 600 N	92/02	FMY0466	49	1AE-14451-0000	YA7585
600	XJ 600S Diversion	92/02	FMY0466	49	1AE-14451-0000	YA7585
600	YZF R6	99/05	FMY0484	116	5EB-14451-0000	YA6001
600	YZF R6 S	06/07	FMY0484	116	5EB-14451-0000	YA6001
660	MT03	06/07	FMY0523	106	5VK-14451-0000	YA6604
660	XT 660 X/R/Super Motard	04/	FMY0523	106	5VK-14451-0000	YA6604
700	FZ 700 Genesis	86/87	FMY0466	49	1AE-14451-0000	YA7585
750	FZ 750 S/SC/U/UC	85/91	FMY0466	49	1AE-14451-0000	YA7585
750	FZR 750 RT/RU	87/88	FMY0466	49	1AE-14451-0000	YA7585
850	TDM 850	91/02	FMY0466	49	1AE-14451-0000	YA7585
900	TDM 900	02/	FMY0482	121	5PS-14451-0000	YA9002
900	XJ900S Diversion	95/02	FMY0466	49	1AE-14451-0000	YA7585
1000	FZ 1	06/07	FMY0589	176	2F1-14451-0000	YA1006
1000	FZ 1 Fazer	06/07	FMY0589	176	5VX-14451-0000	YA1006
1000	FZR 1000	87/88	FMY0466	49	1AE-14451-0000	YA7585
1000		89/95	FMY0542	122	3GM-14451-0000	YA1089
1000	FZ 1	01/05	FMY0476	76	5LV-14451-0000	YA1001
1000	FZS 1000 Fazer	01/05	FMY0476	76	5LV-14451-0000	YA1001
1000	GTS 1000/A	93/98	FPSC004	1	4BH-14451-0000	YA5001
1000	YZF 1000R / Thunderace	96/01	FMY0542	122	3GM-14451-0000	YA1089
1000	YZF 1000 R1	98/01	FMY0460	50	4XV-14451-0000	YA1098
1000		02/03	FMY0483	79	5PW-14451-0000	YA1002
1000		04/06	FMY0524	107	5VY-14451-0000	YA1004
1000		07/08	FMY0601	118	4C8-14451-0000	YA1007
1100	BT 1100 Bulldog	02/05	FMY0466	49	1AE-14451-0000	YA7585
1100	XVS 1100 Dragstar	99/02	FMY0581	169	5EL-14451-0000	YA1199
1100	XVS 1100 A Dragstar Classic	02/03	FMY0581	169	5EL-14451-0000	YA1199
1100	XVS 1100 V-Star	99/01	FMY0581	169	5EL-14451-0000	YA1199
1100	XVS 1100 V-Star Classic	99/06	FMY0581	169	5EL-14451-0000	YA1199
1100	XVS 1100 V-Star Custom	99/06	FMY0581	169	5EL-14451-0000	YA1199
1100	XVS 1100 V-Star Silverado	03/06	FMY0581	169	5EL-14451-0000	YA1199
1200	1200 V MAX /G	85/01	FMY0501	75	1FK-14451-0000	YA1285
1200	XJR 1200	95/01	FMY0487	167	4KG-14451-0000	YA1295
1300	FJR 1300	01/06	FMY0481	166	5JW-14451-0000	YA1699
1300	XJR 1300	95/08	FMY0487	167	4KG-14451-0000	YA1295
1600	XV1600 Road Star	99/03	FMY0585	170	4WM-14451-0000	YA1699
1600	XV1600 Road Star Midnight	99/03	FMY0585	170	4WM-14451-0000	YA1699
1600	XV1600 Road Star Silverado	99/03	FMY0585	170	4WM-14451-0000	YA1699

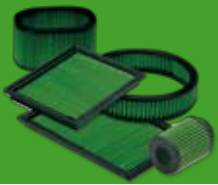

Filtros de alto rendimiento



CC	MARCA/MODELO	AÑO	CÓDIGO	FIG.	CÓDIGO OE	CÓDIGO K&N
1600	XV1600 Wild Star	99/04	FMY0585	170	4WM-14451-0000	YA1699
1670	MT01	05/08	FMY0553	131	5YU-14451-0000	YA1605
YAMAHA ATV/QUAD						
125	YFA 125 Breeze ATV	87/04	FQY009	63	2XJ-14451-00-00	YA-2088
125	YFM 125 Grizzly ATV	04/	FQY009	63	2XJ-14451-00-00	YA-2088
200	YFS 200 Blaster ATV	87/06	FQY009	63	2XJ-14451-00-00	YA-2088
250	YFM 250 Bear Tracker	99/04	FQY018	21	4EX-E4450-00-00	YA4001
250	YFM 250 Bruin	05/	FQY018	21	4EX-E4450-00-00	YA4001
250	YFM 250 Raptor	07/	FQY009	63	2XJ-14451-00-00	YA-2088
350	YFM Grizzly Auto 2x4, 4x4	07/	FQY045	29	5UH-E4451-0000	YA3504
350	YFM 350 FX Wolverine ATV	94/05	FQY010	64	1UY-14451-00-00	YA-4350
350	YFM 350 Bruin	04/	FQY019	86	5UH-E4451-0000	YA3504
350	YFM 350 Raptor/Special Edition	04/	FQY010	64	1UY-14451-00-00	YA-4350
350	YFM 350 Warrior ATV	87/04	FQY010	64	1UY-14451-00-00	YA-4350
350	YFM 350 Big Bear 4X4 ATV	94/99	FQY004	43	2GU-14451-00-00	YA-3502
350	YFZ 350 Banshee ATV	87/06	FQY004	43	2GU-14451-00-00	YA-3502
350	YFM 350 Bruin Auto 2X4	04/	FQY045	29	5UH-E4451-0000	YA3504
350	YFM 350 Bruin Auto 4X4	04/	FQY045	29	5UH-E4451-0000	YA3504
400	YFM 400 Big Bear/4X4	00/06	FQY018	21	4EX-E4450-00-00	YA4001
400	YFM 400 Grizzly Auto 4x4, Hunter	07/	FQY045	29	5UH-E4451-0000	YA3504
400	400 Kodiak Automatic 2W	00/	FQY013	21	5GH-14451-00-00	YA-4000
400	400 Kodiak Automatic 4X4	00/03	FQY013	21	5GH-14451-00-00	YA-4000
400	YFM 400 Kodiak Auto 2X4	04/	FQY045	29	5UH-E4451-0000	YA3504
400	YFM 400 Kodiak Auto 4X4	04/	FQY045	29	5UH-E4451-0000	YA3504
450	YFZ 450	03/08	FQY006	60	5TG-14451-0000	YA4504
450	YFZ R	09	FQY006	60	5TG-14451-0000	YA4504
450	YFM 450 Far Kodiak	03/	FQY019	86	5ND-E4451-0000	YA4003
450	YFM 450 Grizzly Auto 4x4	07/	FQY045	29	5UH-E4451-0000	YA3504
450	YFM 450 Kodiak Auto 4X4	05/	FQY045	29	5UH-E4451-0000	YA3504
450	YFM 450 Wolverine 4X4	06/	FQY045	29	5UH-E4451-0000	YA3504
600	YFM 600 Grizzly	97/01	FQY010	64	1UY-14451-00-00	YA4350
660	YFM 660 Grizzly	02/	FQY030	64	1UY-14451-00-00	YA6602
660	YFM 660 Raptor	01/05	FQY005	59	5LP-14451-01-00	YA6601
700	YFM 700 Raptor	05/	FQY033	141	1S3-14451-00-00	YA7006

KITS DE LIMPIEZA



Cada kit de limpieza contiene limpiador y aceite.
Disponibles en dos tamaños.

Código	KIT
FNH01	KIT LIMPIEZA GRANDE (limpiador 500 ml + aceite 300 ml)
FNH02	KIT LIMPIEZA PEQUEÑO (limpiador 500 ml + aceite 50 ml)

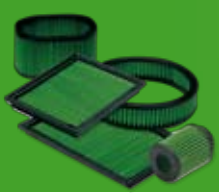

Filtros de alto rendimiento



Figuras de los filtros de alto rendimiento (Fig.1 hasta Fig.12)

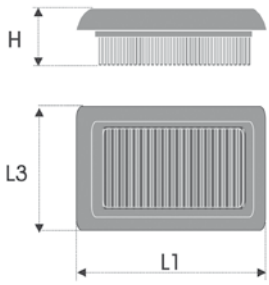

Fig.1

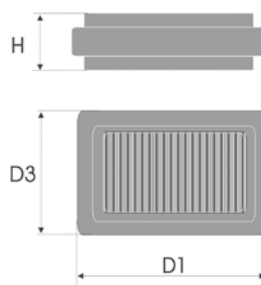

Fig.2

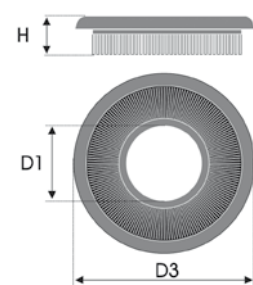

Fig.3

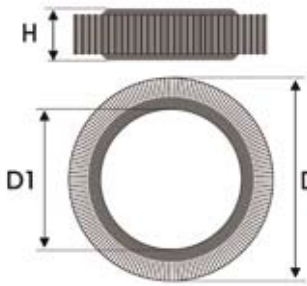

Fig.4

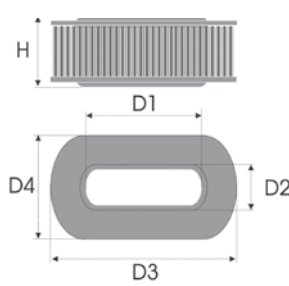

Fig.5

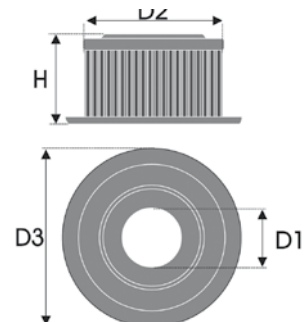

Fig.6

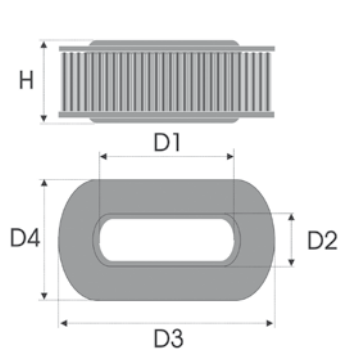

Fig.7

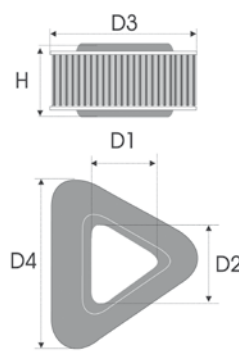

Fig.8

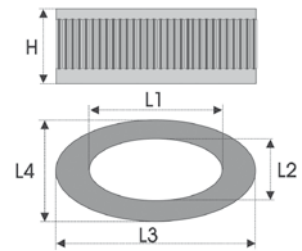

Fig.9

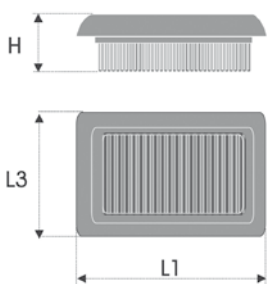

Fig.10

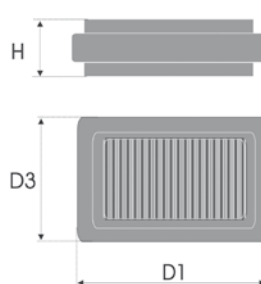

Fig.11

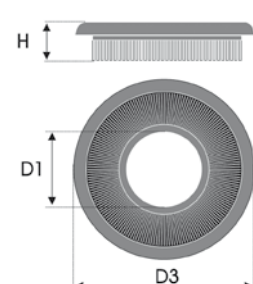
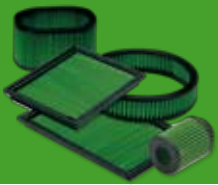

Fig.12



Filtros de alto rendimiento



Figuras de los filtros de alto rendimiento (Fig.13 hasta Fig.24)

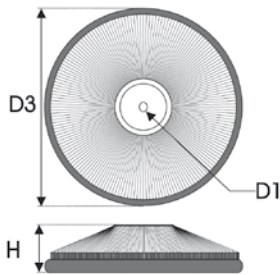

Fig.13

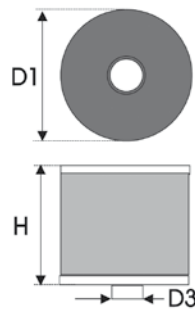

Fig.14

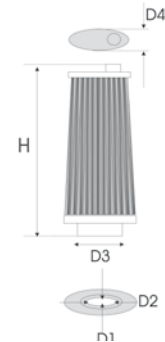

Fig.15

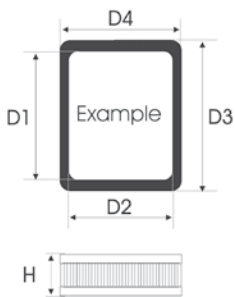

Fig.16

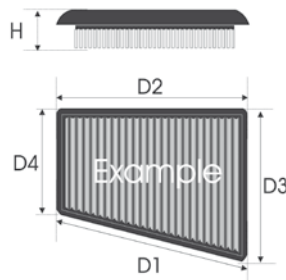

Fig.17

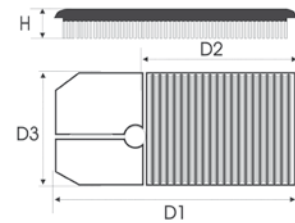

Fig.18

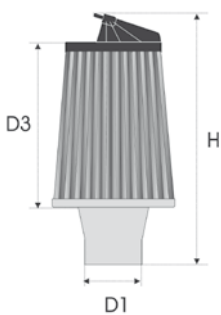

Fig.19

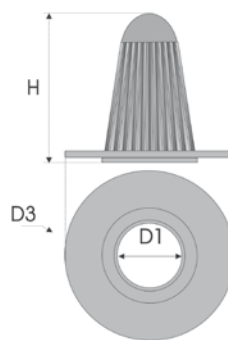

Fig.20

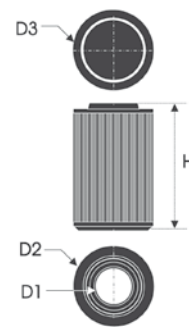

Fig.21

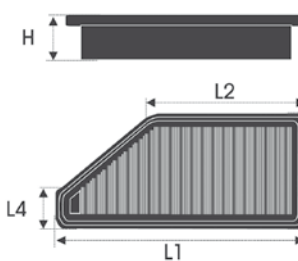

Fig.22

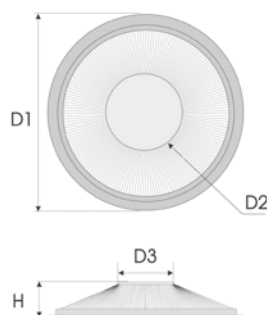

Fig.23

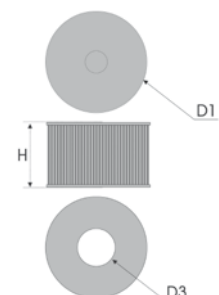
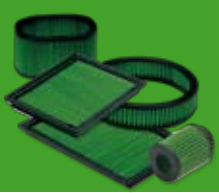

Fig.24



Filtros de alto rendimiento



Figuras de los filtros de alto rendimiento (Fig.25 hasta Fig.36)

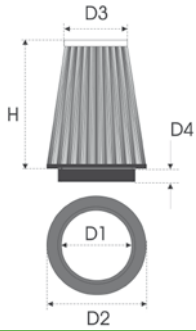

Fig.25

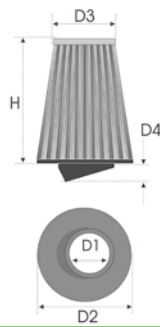

Fig.26

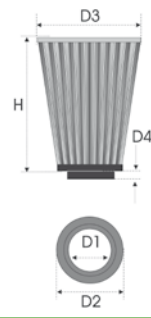

Fig.27

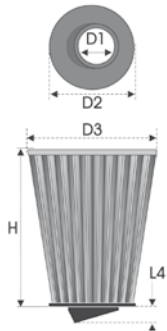

Fig.28

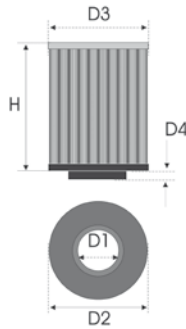

Fig.29

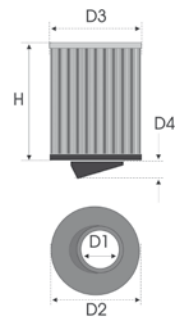

Fig.30

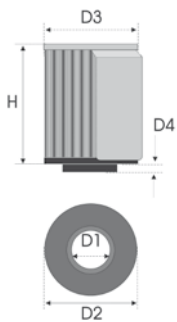

Fig.31

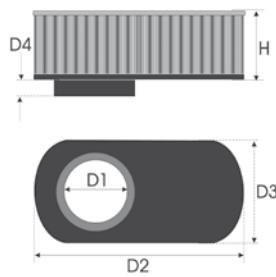

Fig.32

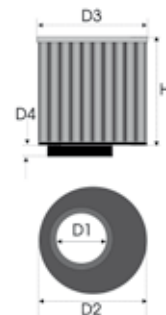

Fig.33

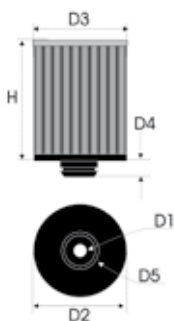

Fig.34

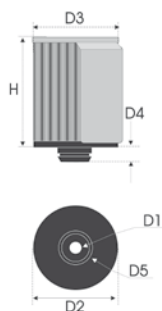

Fig.35

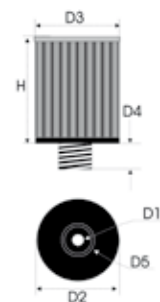
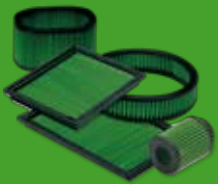

Fig.36



Filtros de alto rendimiento



Figuras de los filtros de alto rendimiento (Fig.37 hasta Fig.48)

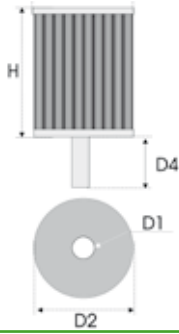

Fig.37

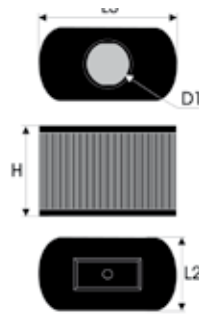

Fig.38

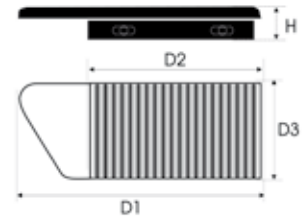

Fig.39

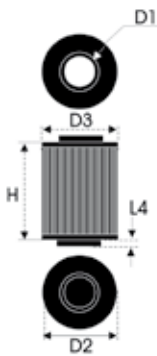

Fig.40

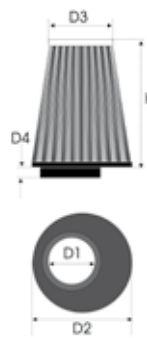

Fig.41

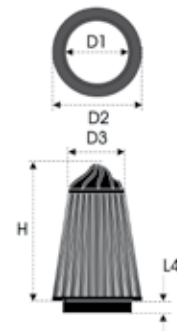

Fig.42

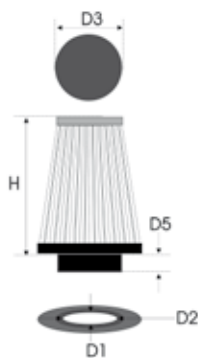

Fig.43

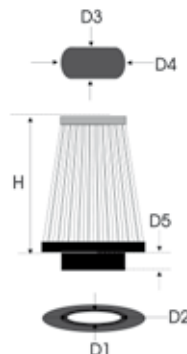

Fig.44

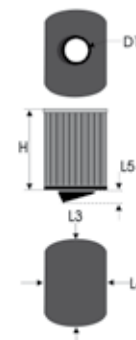

Fig.45

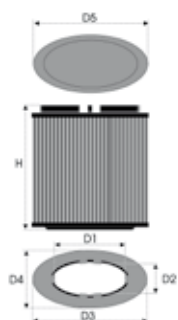

Fig.46

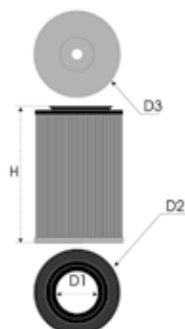
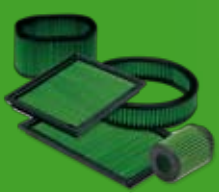

Fig.47



Fig.48



Filtros de alto rendimiento



Figuras de los filtros de alto rendimiento (Fig.49 hasta Fig.60)

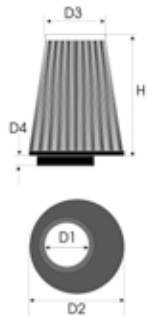

Fig.49

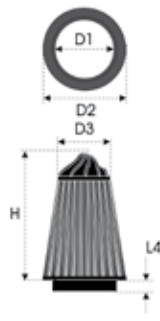

Fig.50

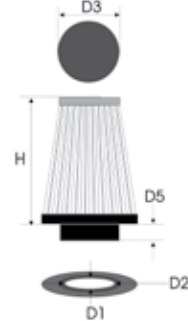

Fig.51

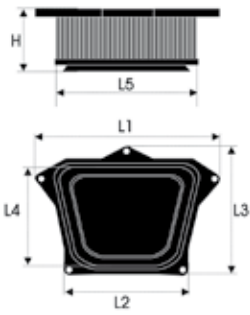

Fig.52

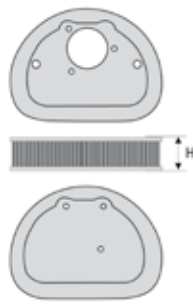

Fig.53

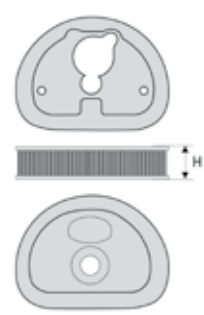

Fig.54

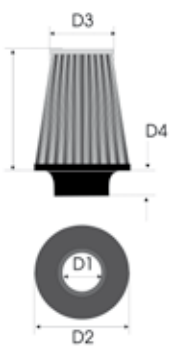

Fig.55

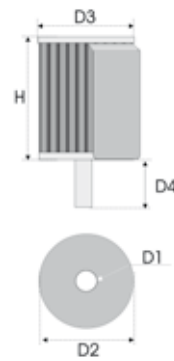

Fig.56



Fig.57

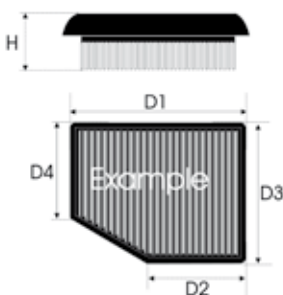

Fig.58

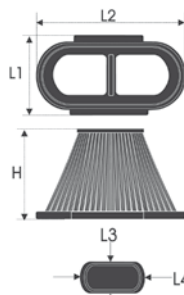

Fig.59

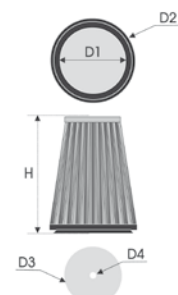
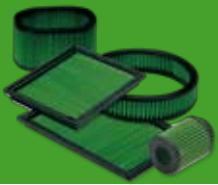

Fig.60



Filtros de alto rendimiento



Figuras de los filtros de alto rendimiento (Fig.61 hasta Fig.73)

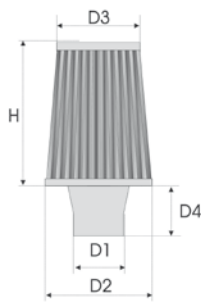

Fig.61

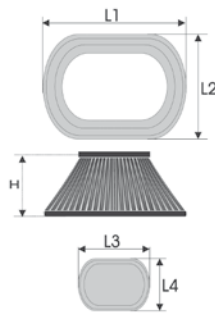

Fig.63

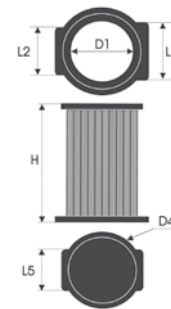

Fig.64

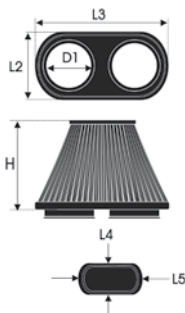

Fig.65

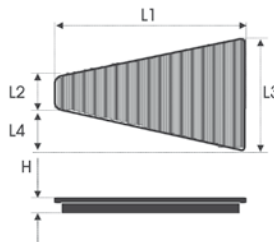

Fig.66

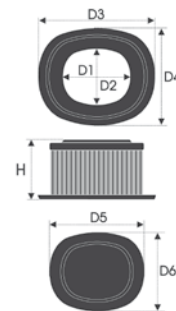

Fig.67

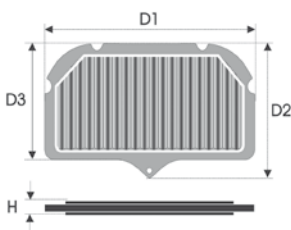

Fig.68

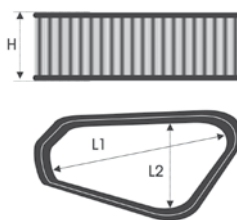

Fig.69

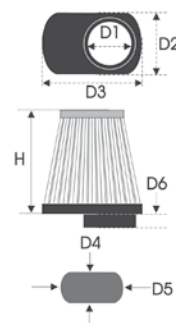

Fig.70

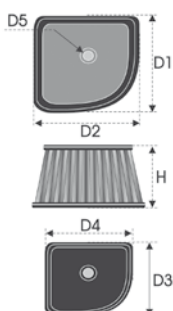

Fig.71

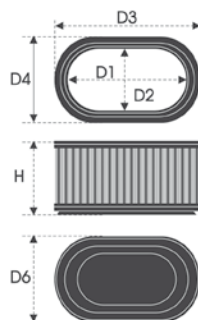

Fig.72

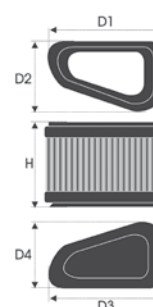
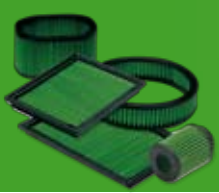

Fig.73

256

Filtros de alto rendimiento



Filtros de alto rendimiento



Figuras de los filtros de alto rendimiento (Fig.74 hasta Fig.85)

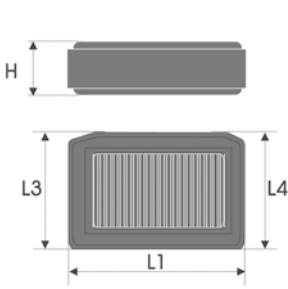

Fig.74

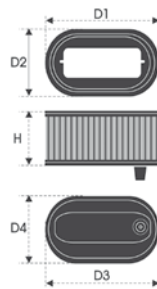

Fig.75

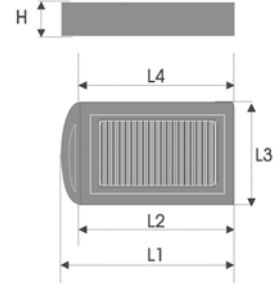

Fig.76

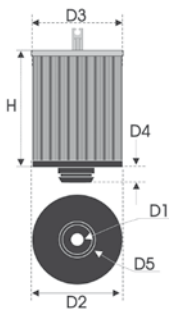

Fig.77

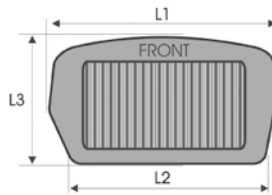

Fig.78

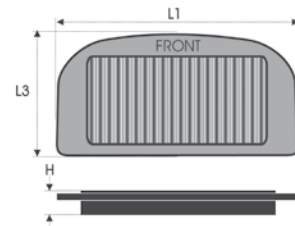

Fig.79

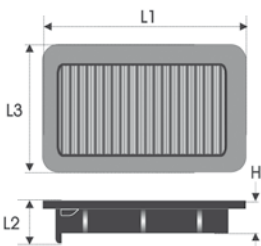

Fig.80

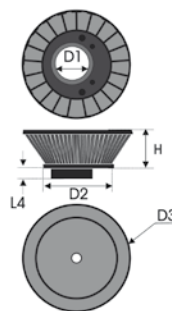

Fig.81

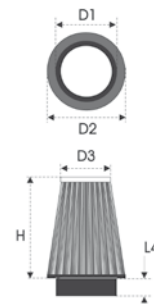

Fig.82

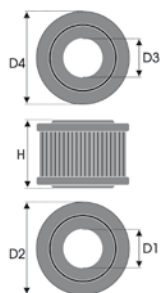

Fig.83

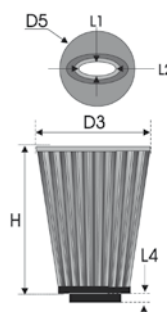

Fig.84

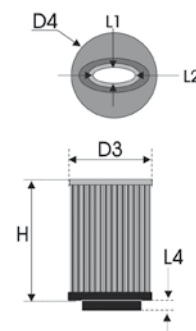
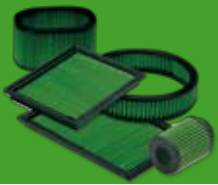

Fig.85



Filtros de alto rendimiento



Figuras de los filtros de alto rendimiento (Fig.86 hasta Fig.97)

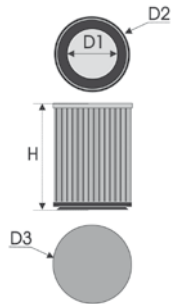

Fig.86

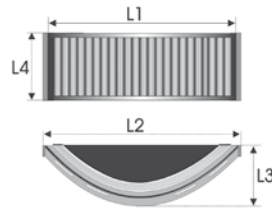

Fig.87

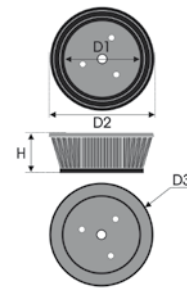

Fig.88

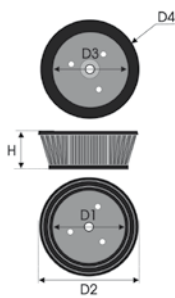

Fig.89

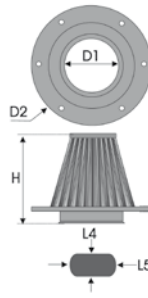

Fig.90

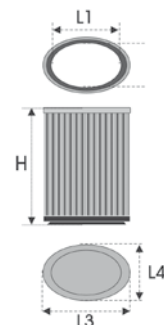

Fig.91

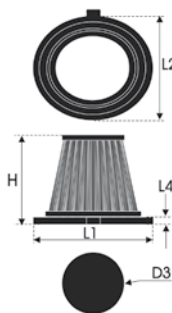

Fig.92

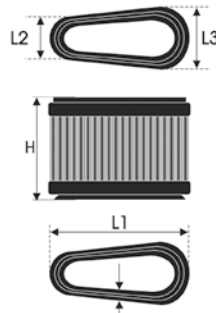

Fig.93

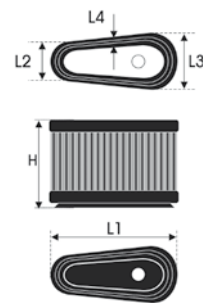

Fig.94

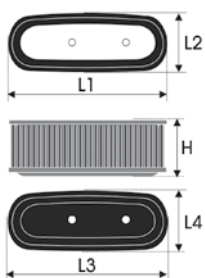

Fig.95

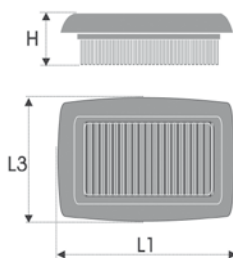

Fig.96

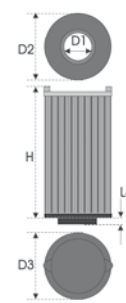
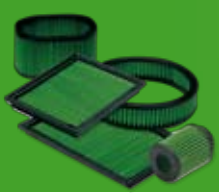

Fig.97



Filtros de alto rendimiento



Figuras de los filtros de alto rendimiento (Fig.98 hasta Fig.109)

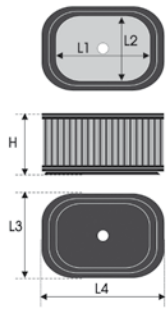

Fig.98

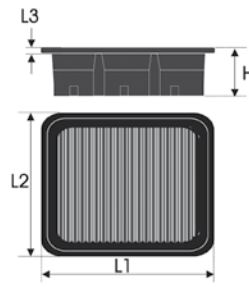

Fig.99



Fig.100

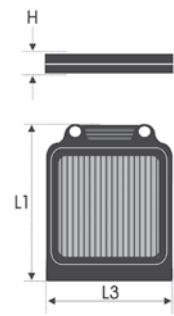

Fig.101

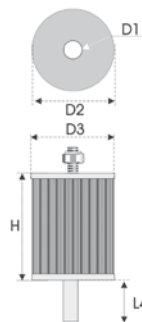

Fig.102

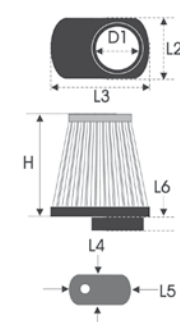

Fig.103

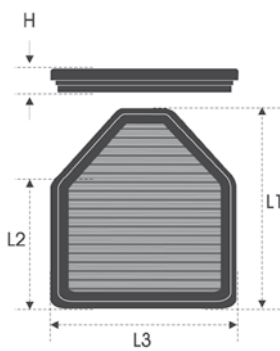

Fig.104

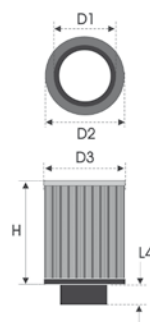

Fig.105

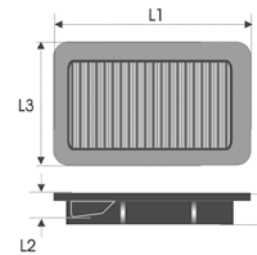

Fig.106

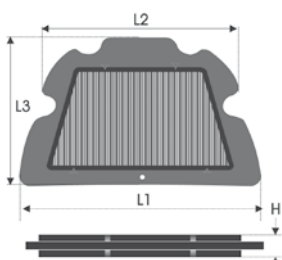

Fig.107

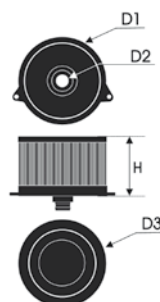

Fig.108

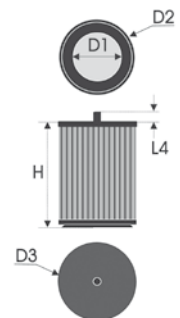
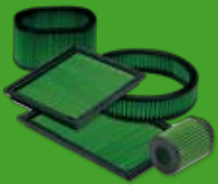

Fig.109



Filtros de alto rendimiento



Figuras de los filtros de alto rendimiento (Fig.110 hasta Fig.121)

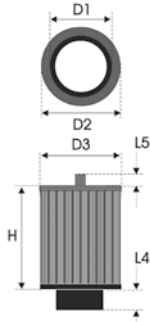

Fig.110

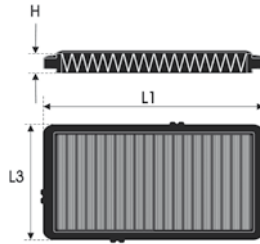

Fig.111

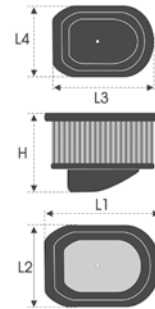

Fig.112

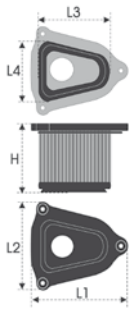

Fig.113

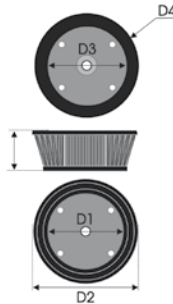

Fig.114

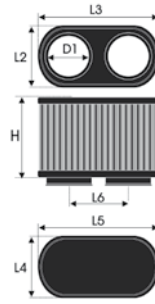

Fig.115

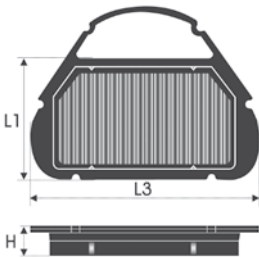

Fig.116

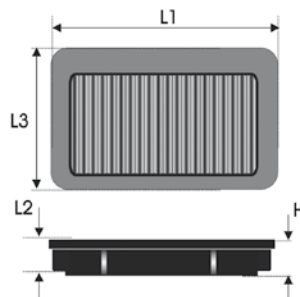

Fig.117

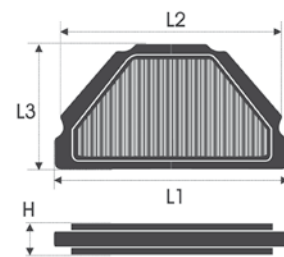

Fig.118

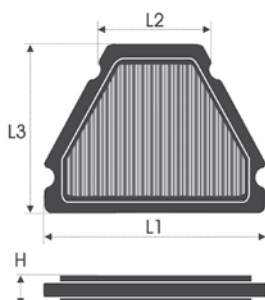

Fig.119

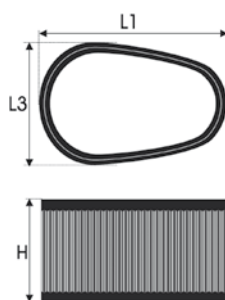

Fig.120

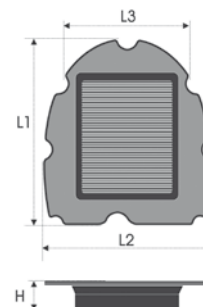
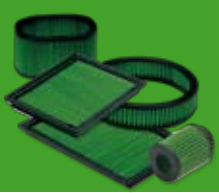

Fig.121



Filtros de alto rendimiento



Figuras de los filtros de alto rendimiento (Fig.122 hasta Fig.133)

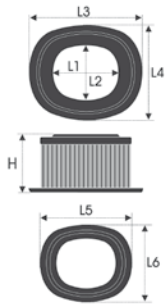

Fig.122

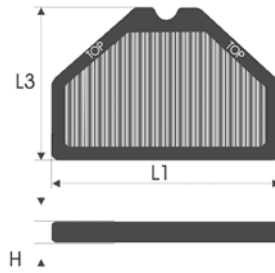

Fig.123

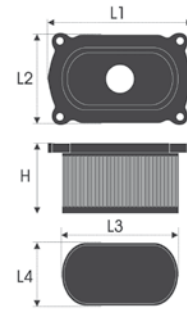

Fig.124

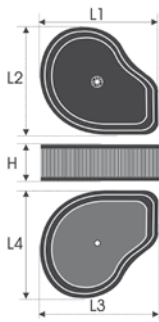

Fig.125

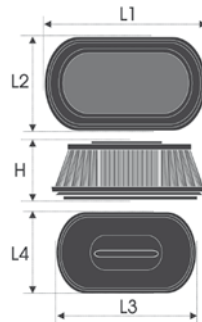

Fig.126

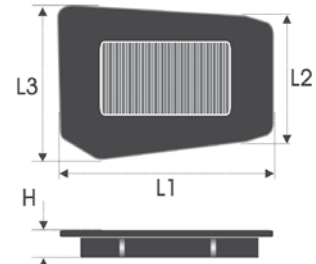

Fig.127

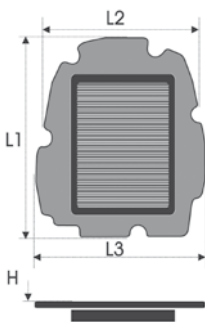

Fig.128

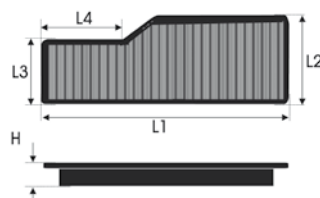

Fig.129

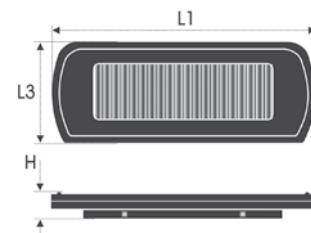

Fig.130

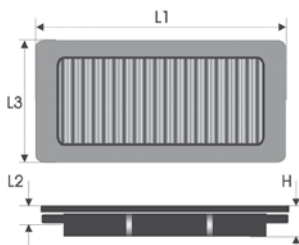

Fig.131

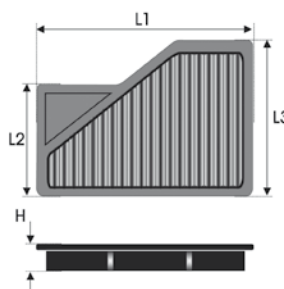

Fig.132

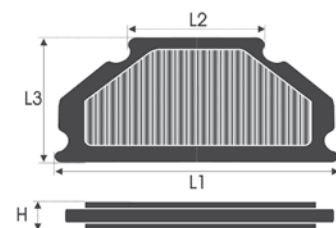
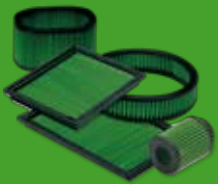

Fig.133



Filtros de alto rendimiento



Figuras de los filtros de alto rendimiento (Fig.134 hasta Fig.145)

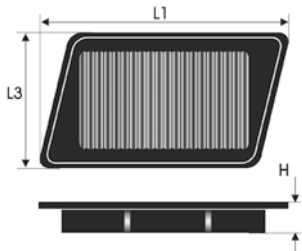

Fig.134

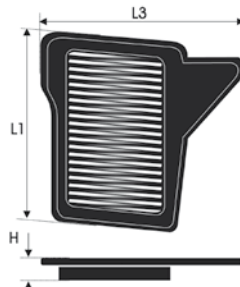

Fig.135

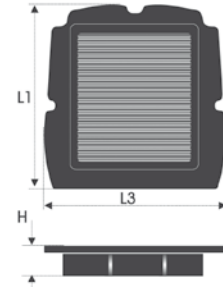

Fig.136

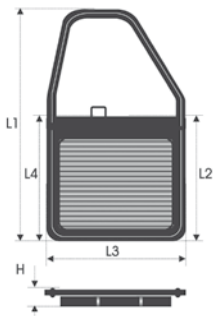

Fig.137

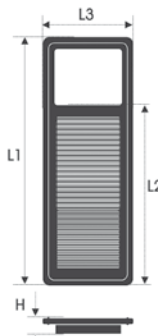

Fig.138

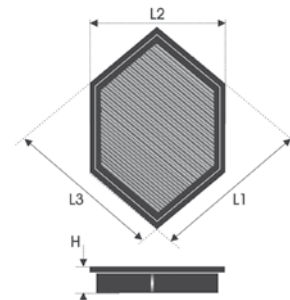

Fig.139

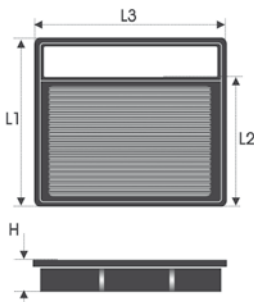

Fig.140

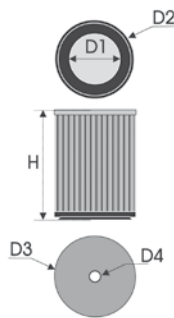

Fig.141

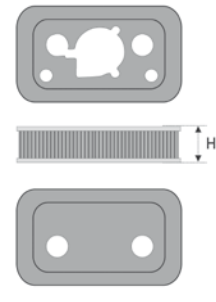

Fig.142

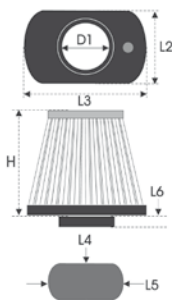

Fig.143

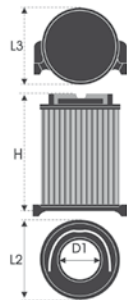

Fig.144

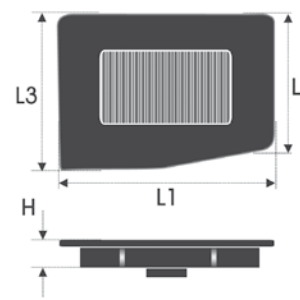
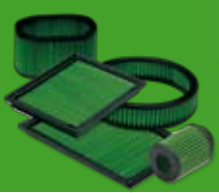

Fig.145



Filtros de alto rendimiento



Figuras de los filtros de alto rendimiento (Fig.146 hasta Fig.158)

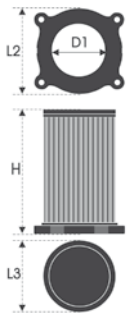

Fig.146

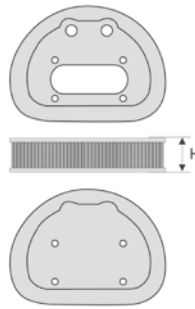

Fig.147

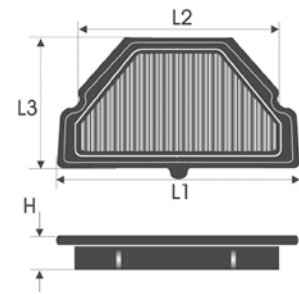

Fig.148

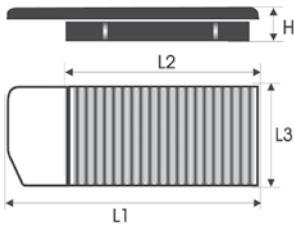

Fig.149

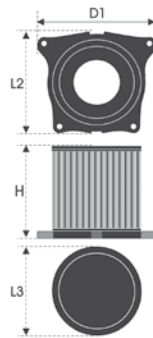

Fig.150

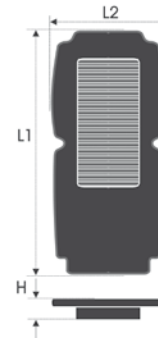

Fig.151

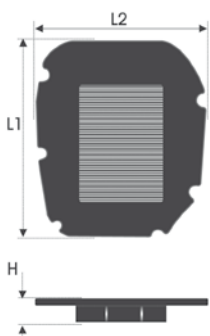

Fig.152

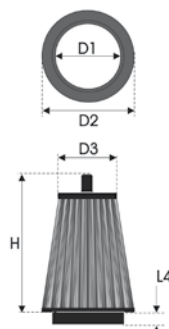

Fig.153

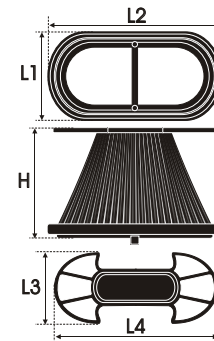

Fig.154

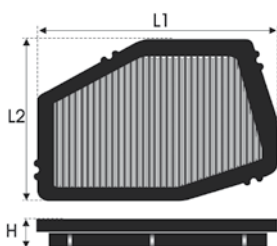

Fig.155

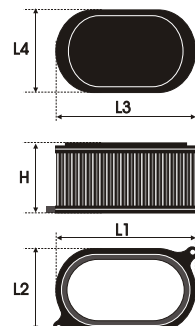

Fig.156

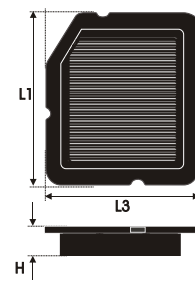
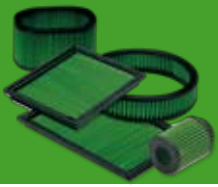

Fig.158



Filtros de alto rendimiento



Figuras de los filtros de alto rendimiento (Fig.159 hasta Fig.171)

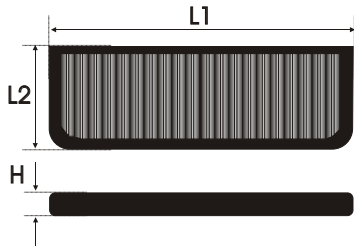

Fig.159

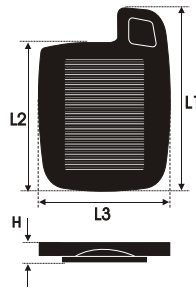

Fig.161

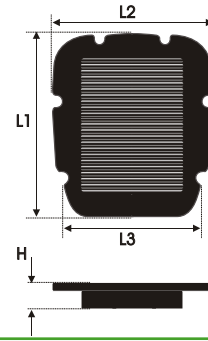

Fig.162

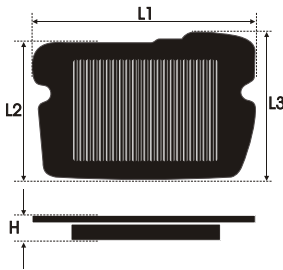

Fig.163

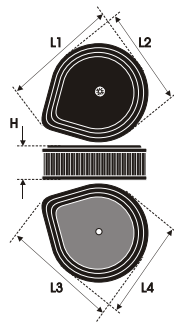

Fig.164

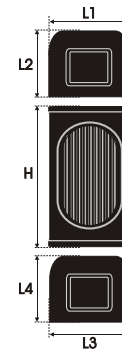

Fig.165

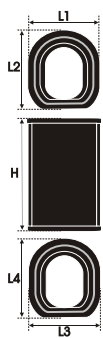

Fig.166

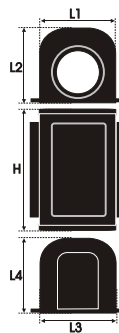

Fig.167

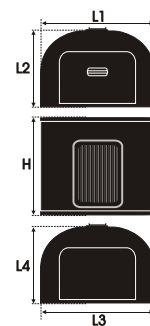

Fig.168

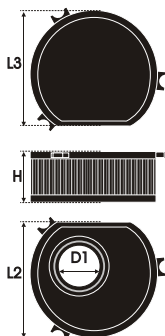

Fig.169

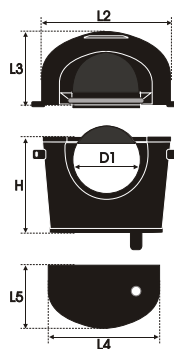

Fig.170

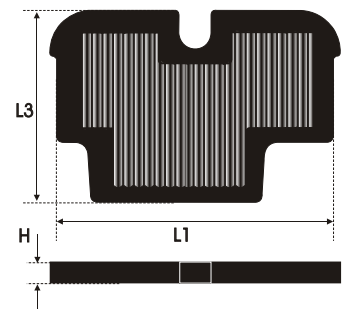
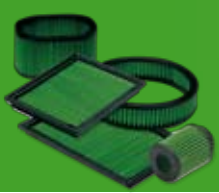

Fig.171



Filtros de alto rendimiento



Figuras de los filtros de alto rendimiento (Fig.173 hasta Fig.188)

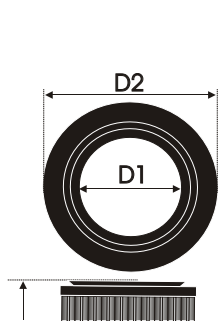

Fig.173

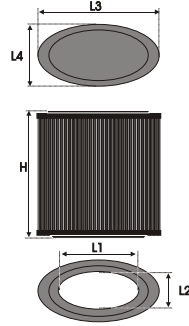

Fig.174

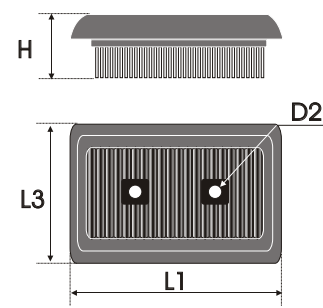

Fig.175

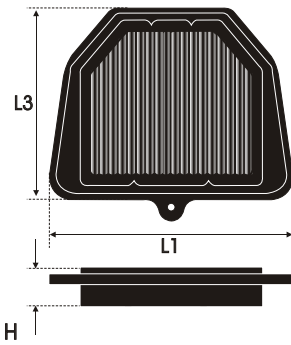

Fig.176

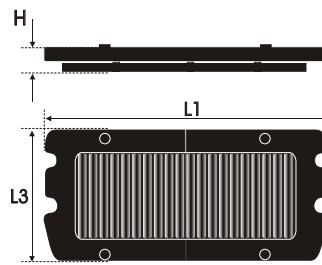

Fig.177

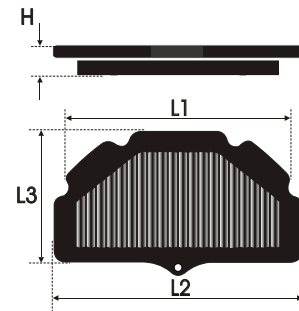

Fig.179

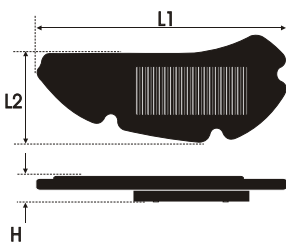

Fig.180

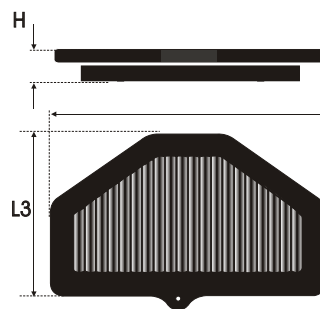

Fig.181

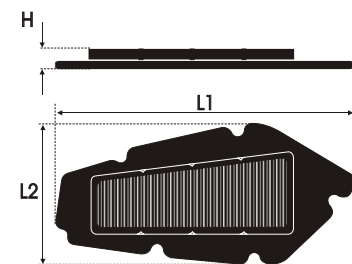

Fig.184

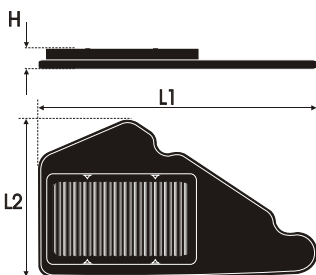

Fig.185

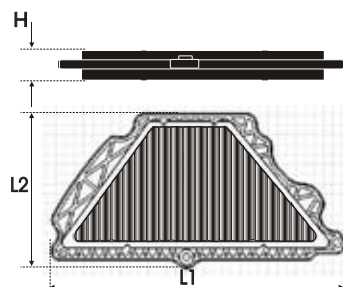

Fig.188