

Sariak

integrity solutions

Fire Alarm & Gas Detection System



Oil, Gas, petrochemical and Refinery plants

Steel, Copper and Cement industries

Chemical Plants

Power Plants & Substations

Commercial enterprises

Product Showcase

Honeywell Analytics and BW Technologies by Honeywell are able to offer a wide range of gas detection solutions designed to meet the needs of all applications and industries. In this feature we showcase the full range of gas detection products supplied by Honeywell.

Fixed Gas Detection (Flammable and Toxic)







Our comprehensive range of flammable, toxic and Oxygen gas detectors have options suited to all industries and applications.



						
SensepointXCD Flammable, toxic and Oxygen transmitter and sensor with tri-color display for viewing status from a distance	SearchlineExcel World renowned open path IR detector with 200m dynamic monitoring range	Apex High performance flammable and toxic detector with choice of communications platforms	Searchpoint OptimaPlus Market leading point IR detector with 100 gases available	SignalpointRange Low cost range of flammable, toxic and Oxygen gas detectors	SignalpointPro Low cost range of flammable, toxic and Oxygen gas detectors with integral gas concentration display	SensepointRange Low-cost ATEX certified flammable, toxic and Oxygen gas detectors

		
XNX Universal Transmitter A universal transmitter compatible with all Honeywell Analytics gas sensor technologies	Series3000MkII 2-wire loop powered toxic and Oxygen gas detector for use in potentially explosive atmospheres	Sensepoint XCDRFD A flammable gas transmitter for use with remotely mounted flammable gas sensors

Fixed Gas Detection (Toxic)

When it comes to laboratory work or hi-tech industries such as pharmaceutical or semi-conductor, the most sensitive instrumentation is required. We offer a diverse selection of robust solutions capable of detecting low levels (ppb) of toxic gases.

							
Chemcassette® Calibration free toxic gas detection with physical evidence of a leak	Satellite XT Small and compact toxic gas detection with a wide range of sensors	Sat-Ex Comprehensive monitoring of corrosive, combustible and toxic gases in potentially explosive atmospheres	SPM Single Point Monitor A fast response device detecting in the ppb range with physical evidence of a leak	ACM 100FT-IR Versatile and sensitive detection of up to 40 points with many gases available	ChemKey™TLD Portable, flexible toxic gas detection with physical evidence of a leak	CM4 Low cost, continuous monitoring of toxic gases on 4 points with minimal main tenance requirement	SatellitePGD Small and portable gas detection ideal for emergency response and laboratory work

		
Vertex M Cost effective, 8-24 point toxic gas monitoring with physical evidence of a leak	Vertex™ Flexible device providing continuous monitoring of up to 72 points	Midas® Sensitive detection using smart sensor cartridges and Power over Ethernet (PoE)

Product showcase

Benefits of using XNX Universal Transmitter

Reduce the ongoing cost of gas detection with a single transmitter interface solution to all your onsite gas detection

XNX Universal Transmitter from Honeywell Analytics is a feature rich transmitter that not only simplifies gas monitoring but also drives down the cost of gas detection in terms of installation and a reduced ongoing cost of ownership.

Its design means that XNX Universal Transmitter can be used with any of Honeywell Analytics' range of gas sensor technologies including Searchline Excel, Searchpoint Optima Plus, Sensepoint (HT and PPM) and Model 705. This means that sites using a variety of sensing principles for the detection of flammables, toxic or Oxygen gas hazards can have one common interface, helping to reduce the need for training and spares.

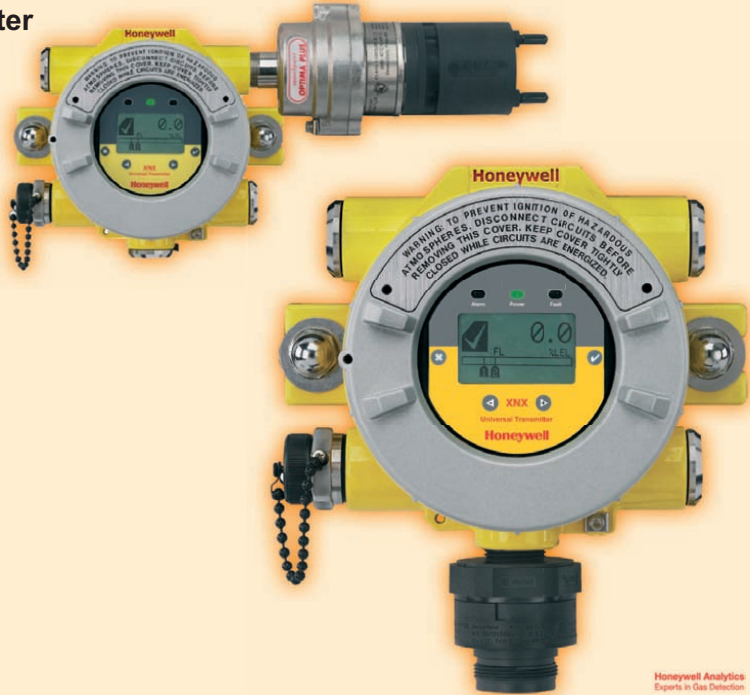

Honeywell Analytics
Experts in Gas Detection

Benefits of using XNX Universal Transmitter

Simplifies your on-site detection through single interface to all site gas detection needs

Compatible with all Honeywell Analytics' gas sensors; allows you to select the best sensor technology for each application

Adapts to your business needs

- Choice of output signals
- Local or remote sensor mounting capabilities
- Selectable sink, source or isolated 4-20mA output
- "Future-proof" design that allows new output standards to be added as they are adopted by industry

Operator friendly

- Easy read multilingual backlit LCD display with text, bar graph, digits and icons
- HART communications as standard, allowing for remote diagnostics/configuration

Reduces your operational costs

- No hot work permit needed when changing EC sensors
- Helps to reduce the cost of installation through the use of common tools and mounting arrangements
- Less training required with common interface

- Device goes into auto-inhibit during maintenance avoiding false alarms
- Reduced spares stock required with common parts

Applications and Certification

Ideal for a wide range of applications and industries including offshore and onshore oil and gas, petrochemical plants and power stations

Compliant with ATEX, UL, CSA Hazardous Area Standards and CSA performance approval. ATEX performance approval (pending).

Cost effective toxic gas detection for challenging environments and hard to reach applications. Sensepoint XCD RTD from Honeywell Analytics combines cost effective performance and maintenance with ease of use and the flexibility to meet the demands of a wide range of varied environments requiring the detection of toxic gases. The device has been designed for use with Honeywell Analytics' range of Sensepoint toxic and Oxygen sensors, providing the ideal solution for a wide variety of applications. The remote sensor mount aspect of Sensepoint XCD RTD (up to 30 metres / 100 feet from the transmitter), makes the device ideal for challenging environments where detection is difficult or locations that are hard to reach and require separate sensor mounting from the transmitter.

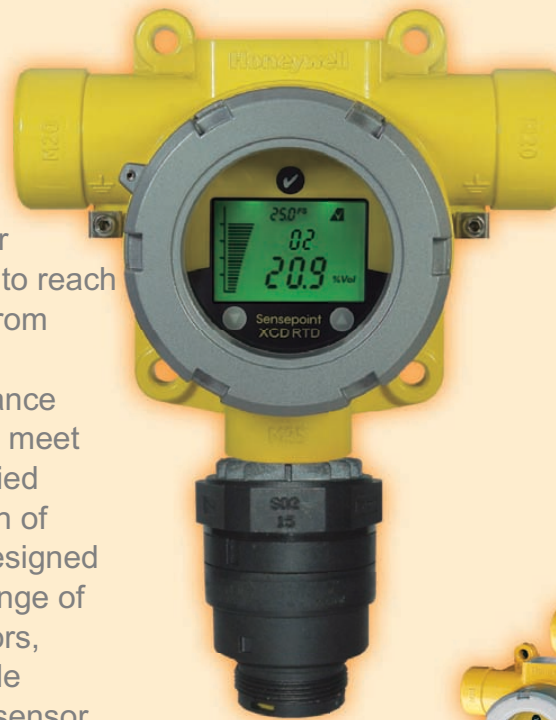

Honeywell Analytics
Experts in Gas Detection

Benefits of using Sensepoint XCD RTD

Helps you enhance on-site safety

- Helps keep your site safe with enhanced, easily accessible visual cues. The device's unique, fully illuminated tri-colour LCD shows the transmitter's status – normal, warning/fault or alarm – at a glance, even from a distance. A steady green backlight indicates normal operation, flashing yellow indicates warning/fault and flashing red indicates an alarm

Helps reduce the ongoing cost of your gas detection

- Simplifies set up and configuration with its LCD and non-intrusive magnetic switches

- Common transmitter platform reduces training costs
- Non-intrusive, one-man operation reduces cost of maintenance

Easy for you to use

- Compatible with Honeywell Analytics' Sensepoint range of toxic and Oxygen sensors
- Selectable sink or source 4-20mA output

Ideal toxic gas detection solution for challenging environments

- Remote mounting aspect makes device ideal for use in hard to reach locations or places where the transmitter needs to be separate from the sensor

- Wide range of gases are supported including Hydrogen Sulphide, Carbon Monoxide, Chlorine, Ammonia, Hydrogen, Nitrogen Monoxide, Sulphur Dioxide, Nitrogen Dioxide and Oxygen

Application and certification

- Suited to a wide variety of locations including industrial manufacturing facilities, power plants, waste water facilities, utilities, food and beverage providers and onshore and offshore oil and gas
- Certified for use in hazardous areas by ATEX (European) and IECEx (International)



40/40 UV/IR Flame Detector Series

Maximum choice of features in a high performance package



FEATURES & BENEFITS

- UV/IR Dual-Sensor
- High-Speed Response - 150 msec Response to Saturated Signal
- Solar blind
- Automatic Built-In-Test (BIT)* and Manual - to assure continued reliable operation
- Heated window - for operation in harsh weather conditions (snow, ice, condensation)
- Multiple output options for maximum flexibility and compatibility
 - Relays (3) for Alarm, Fault and Auxiliary
 - 0-20mA (stepped)
 - HART Protocol for maintenance and asset management
 - RS-485, Modbus Compatible
- High Reliability - MTBF - minimum 150,000 hours
- Approved to Safety Integrity Level 2 (SIL2 – TUV)
- 5-Year Warranty
- User Programmable via HART or RS-485
- Ex approved for Zone 1 hazardous area location
 - ATEX
 - IECEx
 - FM/FMC
 - CSA
- 3rd party Performance Tested
 - EN54-10 (LPCB)
 - FM3260 (FM)

*option

APPLICATIONS(model dependent)

- | | |
|---|-----------------------------------|
| Offshore Oil & Gas installations | Printing Industry |
| Onshore Oil & Gas installations and pipelines | Warehouses |
| Chemical plants | Automotive Industry |
| Petrochemicals plants | Explosives & Munitions |
| Storage Tank farms | Waste Disposal facilities |
| Aircraft hangars | Aerospace Industry |
| Power Generation facilities | Paint, Polymer and Glue processes |
| Pharmaceutical Industry | |

Spectrex offers two versions of the new

40/40 Series UV/IR Flame Detectors:

Model 40/40L (& LB) provides a combination of UV and IR sensors, where the IR sensor μm , and operates at a wavelength of 2.5-3.0 can detect hydrocarbon-based fuel and gas fires, hydroxyl and hydrogen fires, as well as metal and inorganic fires.

Model 40/40L4 (& L4B) is identical to the 40/40L except that the IR sensor works at a wavelength of 4.5 μm and is only suitable for hydrocarbon-based fires.

The UV/IR flame detector senses radiant energy in the short wave section of both the ultraviolet and infrared portions of the electromagnetic spectrum. The signals from both sensors are analyzed for frequency, intensity and duration. Simultaneous detection of radiant energy in both the UV and IR sensors triggers an alarm signal.

The UV sensor incorporates a special logic circuit that helps prevent false alarms caused by solar radiation.

Due to increased reliability, the 40/40 Series warranty period has been extended to 5 years and is SIL2 (TUV) approved to IEC 61508.

LEL. Open-path Gas Detection Concepts METERS

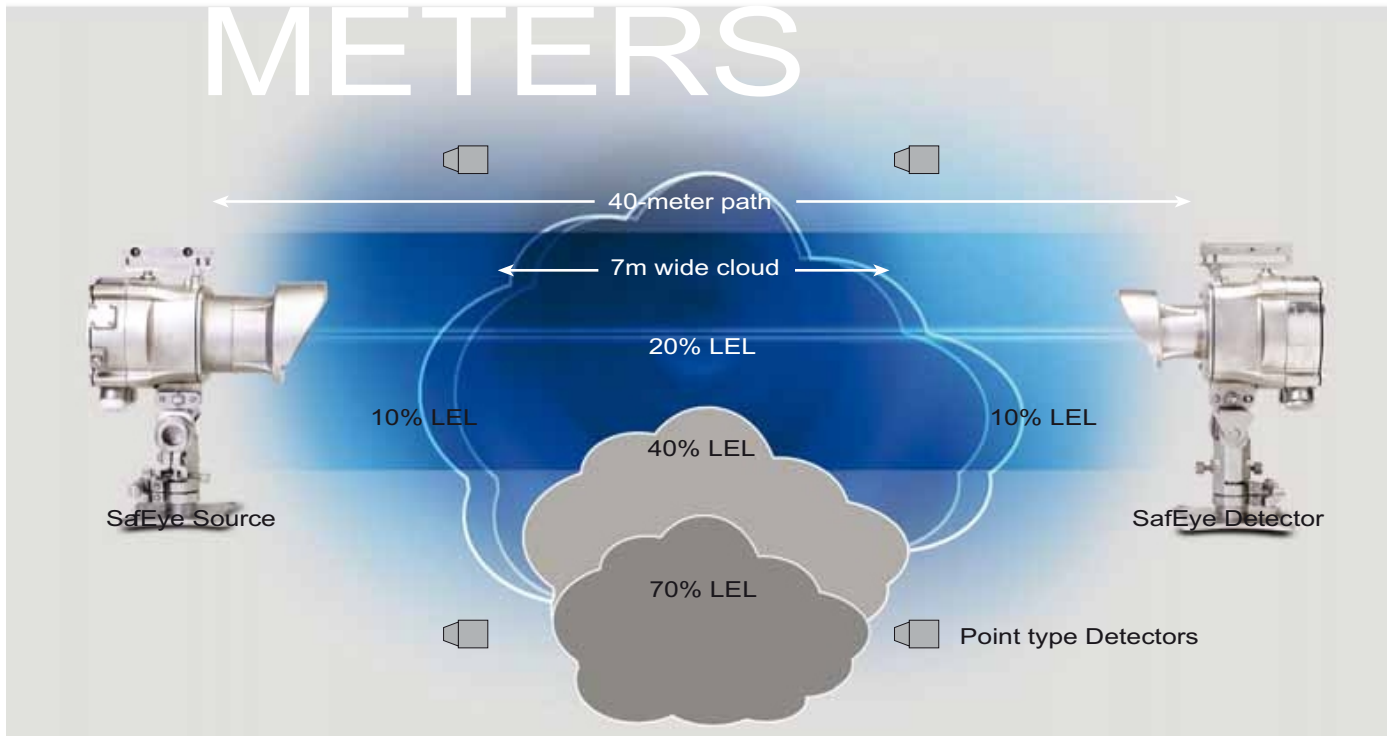

This scenario shows how the matrix of point type detectors can miss a leak or eventually only see diluted gas levels whereas SafEye 700 Open-Path will, in this case, measure 20% LEL x 7 m = 1.4 LEL.m - well above 1 LEL.m alarm level

Not all gas clouds are hazardous - only if a flammable gas cloud or plume is wide enough to allow flame acceleration to speeds greater than 100 m/sec does it become a significant threat.

- Just as an athlete performing the long jump needs a run-up distance, so too a flame front needs distance to reach the velocities which cause the damaging effects of over-pressure, pressure pulse and windage.
- The generally accepted quantity of gas that creates the potential to cause consequential damage if ignited is a cloud of the size 5 m diameter a stoichiometric concentration (about 200% LEL).
- To provide a safety margin, this concentration is halved to 100% LEL. Thus an open path beam traversing this cloud would indicate 5 LEL.m.
- Location of the SafEye 700 Open-Path Gas Detector is less important than with point type detectors as it provides a warning alarm from a diluted gas cloud and does not need to be close to the leakage source.
- Point type detectors measure gas at their location in terms of % LEL, whereas open-path gas detectors measure the amount of gas anywhere along the length of the path, in terms of the integral of concentration and length (LEL x meters).

LEL.meters

Detector output = gas cloud length (m) x gas cloud concentration (LEL)

The unit of measurement is
LEL.meters:
100% LEL of the gas = 1 LEL
1 LEL.meter = 1 LEL x 1 meter

Therefore:
20 m x 5% LEL = 1 LEL.meter
1 m x 100% LEL = 1 LEL.meter
10 m x 10% LEL = 1 LEL.meter

PRODUCT DESCRIPTION



The SafEye 700 Optical Open Path (Line-of-Sight) Gas Detection System employs “spectral fingerprint” analysis of the atmosphere using the Differential Optical Absorption Spectroscopy (DOAS) technique in a unique (patented) method.

SafEye 700 consists of an advanced Xenon Flash infrared transmitter (source) and infrared detector (receiver), separated over a line of sight from 13 ft. (4 m) up to 460 ft. (140 m) to detect and quantify flammable gas presence, even when challenged by extremely harsh environments where dust, fog, rain, snow or vibration can cause a high reduction of signal.

The SafEye 700 analyzes atmospheric absorption at three selected spectral bands, two in a region where the target gas absorbs and one where it does not absorb. The ratio between these absorption lines can provide accurate information of the gas concentration along an optical path.

The reference sensor detects beam blockage,

compensates for changing humidity and detects failed light source or dirty optics.

SafEye’s source and detector units are both housed in low profile, rugged, stainless steel, ATEX approved enclosures. The main enclosure is approved EExd flameproof with an integral, segregated, EExe increased safety terminal section. The hand-held communication unit can be connected in-situ via the intrinsically safe approved (EExia) data port on the detector. The combined ATEX approval is therefore Ex II 2(1) GD, EExde ia [ia] IIC T5 (55°C).

SafEye 700 includes heated optics on the transmitter (source) and receiver (detector) to address icing, condensation and snow.

Modern accessories include an Intrinsically Safe approved, Hand-Held Unit which is an all-in-one Diagnostic / Calibration / Interrogation plug-in unit that assists one-person installation and maintenance.

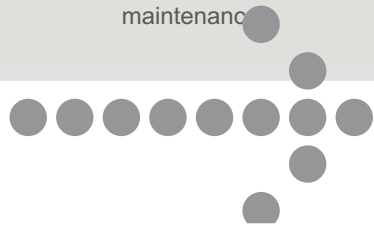

DISCOVERY



The Discovery Optical Detector has a white moulded polycarbonate case with wind-resistant smoke inlets. The indicator LEDs are colourless when the detector is in quiescent state and red in alarm. Within the case is a printed circuit board which, on one side, has the light-proof chamber with integral gauze surrounding the optical measuring system and, on the other, the signal processing and communications electronics.

An infra-red light emitting diode within its collimator is arranged at an obtuse angle to the photo-diode. The photo-diode has an integral daylight-blocking filter (Fig.2).

The IR LED emits a burst of collimated light every second. In clear air the photo-diode receives no light directly from the IR LED, because of the angular arrangement and the chamber baffles. When smoke enters the chamber it scatters light from the emitter IR LED onto the photo-diode in an amount related to the smoke characteristics and density. The photo-diode signal is processed to provide an analogue value for transmission when the detector is interrogated.

Optical detector operating modes

Mode	Alarm threshold %/m	dB/m	Minimum time to alarm (sec)
1	1.4	0.06	5
2	1.4	0.06	30
3	2.1	0.09	5
4	2.1	0.09	30
5	2.4	0.11	5

Compensation rate complies with EN54-7:2000

Table 1

Top section - Discovery Optical Smoke Detector

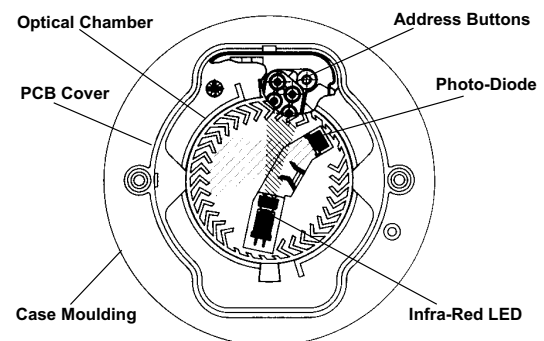

Fig. 2



OPERATING PRINCIPLES

The Discovery multisensor construction is similar to that of the optical detector but uses a different lid and optical mouldings to accommodate the thermistor (heat sensor). The sectional view (Fig 3) shows the arrangement of the optical chamber and the thermistor.

The Discovery Optical/heat multisensor detector contains an optical smoke sensor and a thermistor temperature sensor whose outputs are combined to give the final analogue value. The way in which the signals from the two sensors are combined depends on the response mode selected. The five modes provide response behaviour which incorporates pure heat detection, pure smoke detection and a combination of both. The multisensor is therefore useful over the widest range of applications.

The signals from the optical smoke sensing element and the temperature sensor are independent, and represent the smoke level and the air temperature respectively in the vicinity of the detector. The detector's micro-controller processes the two signals according to the mode selected. When the detector is operating as a multisensor (i.e. modes 1, 3 and 4) the temperature signal processing extracts only rate-of-rise information for combination with the optical signal. In these modes the detector will not respond to a slow temperature increase – even if the temperature reaches a high level. A large sudden change in temperature can, however, cause an alarm without the presence of smoke, if sustained for 20 seconds.

Additional heat sensor information

Discovery optical/heat multisensor detectors manufactured from mid 2009 incorporate additional temperature information that is intended for use in signal processing.

Temperature data can be read separately by the control panel (see Note 1) and used to validate an alarm signalled by the multisensor analogue value. An example of this would be a high multisensor analogue value not accompanied by an increase in heat: this would indicate that an agent other than smoke, e.g. steam, had caused the high analogue value.

The exact method of polling to make use of this feature is described in a Technical Sales document available to panel partners.

This feature offers protection from false alarms.

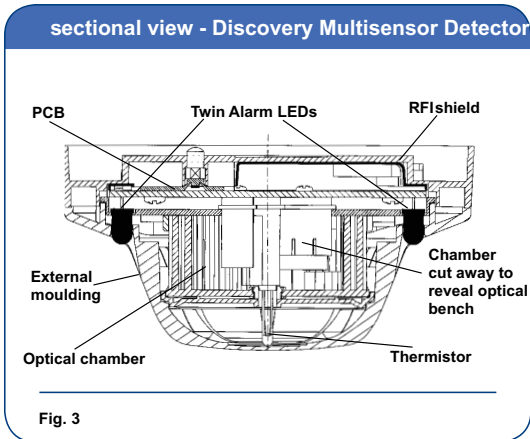

Fig. 3

Multisensor Detector operating modes

Mode	Smoke Sensitivity (grey smoke) %/m dB/m	Temperature Sensitivity (relative)	Response Type	Minimum Time to Alarm (seconds)
1	1.1 0.05	high	multisensor	20
2	2.1 0.09	Not set to heat response	Optical	30
3	2.8 0.12	Low	multisensor	20
4	4.2 0.19	high	multisensor	20
5	No response to smoke	See mode 5 opposite	heat A1R	15

Table 2

DISCOVERY



OPERATING PRINCIPLES

Discovery heat detectors have a common profile with ionisation and optical smoke detectors but have a low air flow resistance case made of self-extinguishing white polycarbonate.

The Discovery heat Detector uses a single thermistor to sense the air temperature at the detector position. The thermistor is connected in a resistor network, which produces a voltage output dependent on temperature. The design of the resistor network, together with the processing algorithm in the microcontroller, gives an approximately linear characteristic from 10°C to 80°C. This linearised signal is further processed, depending on the response mode selected, and converted to an analogue output.

For the European standard version of the detector, the five modes correspond to five “classes” as defined in EN54-5:2001. The classes in this standard correspond with different response behaviour, each of which is designed to be suitable for a range of application temperatures. All modes incorporate “fixed temperature” response, which is defined in the standard by the “static response temperature”. The application temperatures and static response temperatures for all response modes are given in Table 6.

In addition to the basic classification, a detector may be given an “R” or “S” suffix. The “R” suffix indicates that the detector has been shown to have a rate-of-rise characteristic. Such a detector will still give a rapid response even

when starting from an ambient temperature well below its typical application temperature. This type of detector is therefore suitable for areas such as unheated warehouses in which the ambient temperature may be very low for long periods.

The “S” suffix on the other hand indicates that the detector will not respond below its minimum static response temperature even when exposed to high rates of rise of air temperature. This type is therefore suitable for areas such as kitchens and boiler rooms where large, rapid temperature changes are considered normal.

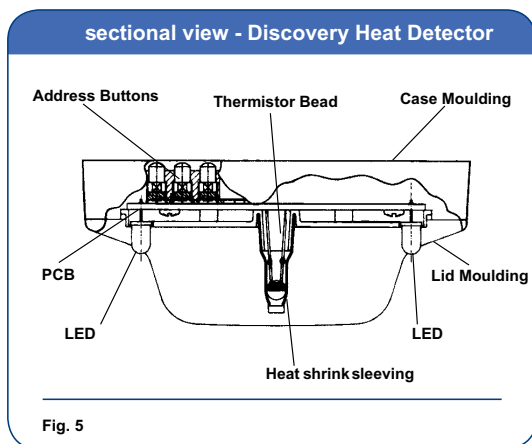

Heat Detector Response Modes

Mode	Class (EN54-5:2001)	Application Temperature		Static Response Temperature °C		
		Typical	Max	Min	Typ	Max
1	A1R	25	50	54	57	65
2	A2R	25	50	54	61	70
3	A2S	25	50	54	61	70
4	CR	55	80	84	90	100
5	CS	55	80	84	90	100

For air temperatures in the range 15°C to 55°C, the analogue value for a detector in mode 1 will correspond approximately to the air temperature.

Table 6



OPERATING PRINCIPLES

The Apollo Discovery EN54-11:2001 compliant manual Call Point (mCP) is based on the KAC conventional mCP range. It is electronically and mechanically compatible with previous Apollo call points based on KAC’s World Series product.

The address of each call point is set at the commissioning stage by means of a seven-segment DIL switch.

If an mCP is activated, it interrupts the normal protocol to give a fast response.

A single bi-coloured alarm LED is provided on the call point. This LED is controlled, independently of the call point, by the control panel and may be set to flash each time the call point is polled. The red LED is lit when the call point has been activated and sent into alarm. On the isolated versions an amber/yellow LED indicates a short circuit on the loop wiring either side of the call point.

Call points can be remotely tested from the panel by transmission of a single bit in the communications protocol. Call

points respond by providing a value of 64 which corresponds to the alarm value. The panel should recognise this response as a test signal and should not raise a general alarm.

Discovery manual Call Points are available with or without an isolator. Each version is available with a resettable element and a backbox for surface mounting as standard. If a glass option is required, spare glasses are available on request. For all part numbers please refer to table 7.

For ease of installation Discovery manual call points are supplied with clip-on terminal blocks and a connector which allows continuity testing before call points are commissioned.

To provide additional protection against accidental operation, a transparent hinged cover with a locking tag, part number 26729-152 is available, which can be fitted to the manual call point. Please note that the call point does not conform to EN54-11:2001 when this lid is fitted and secured with the locking tag.

WATERPROOF AND NON-STANDARD MANUAL CALL POINTS

Discovery waterproof (IP67) manual call points are available in red or yellow. For special purposes, such as initiating a ‘hazard’ alarm, specially coloured call points can be used on the fire system – see table opposite. However, these do not conform to EN54-11:2001 requirements.

DISCOVERY



INTERFACES

A comprehensive range of interfaces for use with Discovery systems is available from Apollo. They are designed to enable fire protection systems to be engineered simply and effectively without the need for custom-designed equipment.

These interfaces are available in three types of housing. The standard interfaces are designed to be surface or flush-mounted while the DIN-rail versions feature enclosures that clip to a standard 35mm DIN rails (DIN 46277) or are screwed to the base of a larger enclosure. miniature interfaces use very compact enclosures for installation into other equipment.

The standard interface range is fitted with bi-directional, short-circuit isolators. These interfaces allow for easier installation when large numbers of interfaces are required.

The following interfaces may be incorporated into Discovery systems:

- Input/Output Unit provides a relay output and one monitored input
- 3-channel Input/Output Unit provides 3 relay outputs and 3 monitored inputs
- Mains Switching Input/Output Unit switches machinery operating at 230V
- Output Unit provides one relay output
- Zone Monitor controls a zone of conventional detectors
- Switch Monitor monitors the operation of a switch
- Switch Monitor Plus monitors the operation of a switch; also incorporates a time delay
- Sounder Controller controls the operation of conventional sounders
- Mini Switch Monitor monitors the operation of a switch and is small enough to fit into other equipment
- Dual Isolator

For further information on the range of compatible interfaces, please refer to Apollo publication PP2025 'Interfaces for Intelligent Systems'.



The Discovery® Open Area Sounder Beacon is an alarm device comprising a sounder, a beacon and a short-circuit isolator for use with Discovery detection systems. It is supplied with a mounting base which incorporates a short-circuit isolator.

Application

The Discovery Open Area Sounder Beacon is used to provide audible and visual warning of fire and is controlled by the fire control panel by means of the Discovery protocol. The particular features of this sounder beacon are available only when it is being controlled by the full Discovery protocol with the panel programmed accordingly. Information on available features should be requested from the panel manufacturer.

Features & advantages

These are identical to the Discovery Sounder Beacon Base but the Open Area Sounder Beacon is a wall-mounted stand-alone device that produces a higher sound output of up to 100dB(A).

TECHNICAL DATA	
Discovery Open Area Sounder Beacon	
Part No 58000-005 (red), 58000-007 (white)	
specifications are typical at 23°C and 50% relative humidity unless otherwise stated.	
Operating voltage:	17–28V DC (polarity sensitive)
Protocol pulses:	5–9V
Current consumption at 24V:	switch-on surge, <1s 1.2mA quiescent 350µA device operated at maximum volume 8.2mA
Maximum sound output at 90°:	100dB(A) Sound pressure level data is published in PIN sheet PP2203 available from Apollo
Operating temperature:	–20°C to +60°C
Humidity (no condensation or icing):	0–95%
IP rating:	65

XgardIQ

Intelligent Gas Detector and Transmitter

When lives and property are at risk and you need gas detection equipment that is totally reliable, you need Crowcon. For over 45 years Crowcon has been developing and manufacturing high quality products with a reputation for reliability and technical innovation.

Crowcon fixed-point detectors have been proven in many arduous environments, including oil and gas exploration and production, petrochemicals, water treatment, chemical plants and steel mills. XgardIQ provides fail-safe detection of a very wide range of gases and vapours.



Product Description

XgardIQ is an intelligent and versatile gas detector and transmitter compatible with Crowcon's full range of sensor technologies. XgardIQ is available fitted with a variety of flammable, toxic and oxygen gas sensors and provides a bright OLED display with clear and comprehensive status information in a range of languages.

Confidence with Positive Safety

Bright LEDs indicate detector status at a glance; the unique Positive Safety LED confirms the detector is operating safely and alerts operators to any irregular events that may affect product integrity such as the ambient temperature exceeding sensor limits. When working safely, the blue LED remains on constantly. If any abnormal conditions are detected the LED will flash and a warning message will be displayed.

Flexible signal outputs

XgardIQ provides comprehensive and powerful output signal options; analogue 4-20mA signal with auto sink/source detection feature and RS-485 Modbus communications are provided as standard. Alarm and fault relays featuring heavy-duty changeover contacts, rated 230Vac 5A, are available at purchase or may be added at any time after installation. HART communications can be provided both over the analogue signal and via local I.S. terminals for diagnostics via any HART asset management system or hand-held device.

Improved safety

XgardIQ minimises the time personnel spend in potentially hazardous locations by using simple hot-swappable sensor modules. Sensors can be bump tested and calibrated in-situ or removed in seconds using one hand, and either replaced with a pre-calibrated sensor module or re-calibrated in a safe area before being re-fitted. All functions and adjustments can be made via the integral keypad without the need for special tools or hot-work permits.



Rugged and robust

ATEX and IECEx certified for use in Zone 1 and Zone 2 hazardous areas, XgardIQ has been designed for long-life operation in extreme environments. Featuring a rugged 316 stainless steel construction and a wide operating temperature range from -40°C to +75°C, XgardIQ is suitable for the most demanding applications.



XgardIQ Options

XgardIQ is compatible with Crowcon's full range of sensor technologies. The transmitter provides analogue 4-20mA and RS-485 Modbus signals as standard and HART communications is available as an option. A relay module may be fitted at the time of purchase, or retrofitted at any time. The 316 stainless steel enclosure has three cable entries suitable for either M20 or 1/2" NPT cable glands.

If XgardIQ is to be installed months ahead of scheduled commissioning, it can be supplied without a sensor module to avoid the possibility of the sensor being poisoned or expiring whilst inactive. The transmitter is supplied with a dummy sensor module to maintain dust and water ingress protection and sensor modules can be delivered and installed prior to commissioning.



Transmitter with Sensor

- Pre-calibrated flammable, toxic or oxygen sensor module
- Huge range of gas sensors.



Transmitter Only

- Enables transmitter to be installed in advance of commissioning
- Supplied with a dummy sensor module for weather protection
- Auto-configure function when the sensor module is plugged in.

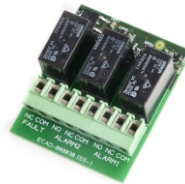

Relays

- Simple plug-in module
- Heavy-duty 230Vac, 5A contacts
- Alarm 1, Alarm 2 and Fault relays
- On-delay and off-delay timers
- Can be retrofitted as needed.



HART Communications

- Enables diagnostics via asset management systems
- Local I.S. HART terminal connection
- Detectors can be installed on a HART addressable network.

IRmax

Infrared Hydrocarbon Gas Detector

When lives and property are at risk and you need gas detection equipment that is totally reliable, you need Crowcon. For over 40 years Crowcon has been developing and manufacturing high quality products with a reputation for reliability and technical innovation.

Crowcon fixed detectors have been proven in many arduous environments, including oil and gas exploration, water treatment, and steel and chemical plants. IRmax offers uniquely low powered, fail-safe detection of hydrocarbon gases and vapours.



Choosing the fixed gas detector for your needs

IRmax is a compact, low power and highly rugged infrared gas detector, that delivers rapid, fail-safe detection of methane, butane, propane and many other hydrocarbon gases and vapours.

The reliability of IRmax has been proven in hot, cold, wet and saline environments, making it ideal for use offshore. Unlike conventional IR gas detectors, IRmax does not utilise heaters to prevent condensation on windows and mirrors. IRmax's unique STAY-CL IR optical components are treated with a highly durable coating that completely prevents faults due to condensation. As IRmax contains no components for artificially heating optical surfaces, power consumption is dramatically reduced, requiring only 1W of power, typically 75-90% lower than conventional IR gas detectors.

Simple to install

Compact size	Requires less space, effort and time to install
Various installation options	Can be wall mounted, fitted to a 50mm (2 inch) pipe or connected to an auxiliary junction box using a choice of mounting accessories
Industry standard 4-20mA output	IRmax is compatible with virtually any control system
Options for HART communications and RS-485 Modbus	

Easy maintenance

Remote non-intrusive calibration	The IR Display can be mounted up to 30 metres from the IRmax and test gas can be applied without requiring direct access to the detector
Hand-held Intrinsically Safe (I.S) calibrator	IRmax detectors fitted with an I.S barrier module can be checked and calibrated using an I.S calibration accessory
STAY-IR optics	Prevents condensation on optical components

Low cost of ownership

Low power	IRmax only consumes 1W of power, enabling small power supplies and battery back up systems to be used
Automatic optical obscuration monitoring	Minimal routine maintenance keeps costs to a minimum
Annual proof-test interval	

Please see the back page for full technical specifications.

IRmax options

IRmax is available either as a basic unit without display, or with three display options. The Fixed IR Display is permanently fixed to the IRmax detector to enable simple status checking and non-intrusive calibration. The Remote IR Display can be mounted up to 30 metres from the IRmax detector, simplifying checking and maintenance of detectors mounted in inaccessible areas. The Hand-Held I.S. Calibrator is available for temporary connection to IRmax detectors fitted with an I.S. Barrier Module.



Fixed IR Display

- Large, clear display shows gas level and other status information
- Simple non-intrusive calibration
- Enables connection of hand-held HART communicators
- Can be rotated up and down to provide the optimum viewing angle

Remote IR Display

- Can be mounted up to 30 metres from IRmax
- Removes the need to directly access the IRmax detector
- Choice of connection lead lengths

I.S. Hand-Held Calibrator

- Enables calibration and interrogation of IRmax detectors without a Fixed or Remote IR Display
- Only one I.S. hand-held calibrator required per IRmax detector fleet
- Intrinsically Safe; suitable for use in hazardous areas

HART communications

- Hand-held HART communicators can be connected to the IR Display for local diagnostics and calibration
- HART data is super-imposed onto the 4-20mA signal for communicating with HART enabled control systems
- Compatible with point-to-point or addressable HART topologies

RS-485 Modbus

- Enables remote interrogation of IRmax
- Enables up to 32 detectors to be multi-dropped on an addressable network
- RS-485 physical platform for transmission of data up to 1Km



Accessories



Calibration cap



Spigot gland



Duct mounting kit



Auxiliary junction box



Mounting bracket kit



Remote calibration unit



Flow adaptor



I.S. remote display connecting leads

Addressable Fire Alarm Control Panel



The Solution F1 Fire Control Panel range is a new generation, modular and ultramodern Fire Control Panel range.

These have been developed to meet international standards and to satisfy specific international requirements at the highest level.

These panels contain numerous new features – several are unique in the security business – and they convince by their comprehensive equipment.

Many optional (at extra cost) features in other panels are included in the “Solution F1” standard configuration. This range has been designed to be a universal and flexible product in terms of both the different configuration possibilities as well as the front fascia design. It thus meets the requirements for all possible applications.

By the outstanding modularity of this panel it can be perfectly adapted to all anticipated user requirements. Flexibility – especially for connecting different detectors was one of the most important aims during the development of this new Fire Control Panel.

Obviously it is a standard for this panel to connect nearly all conventional detectors of the market but very remarkable: The “Solution F1” panels are compatible to the newest analogue addressable detectors of Hochiki and Apollo –two of the biggest and best known players in the detector market worldwide.

- **Modular, intelligent Hybrid Fire Control Panel Range**
- **Supports Hochiki ESP and Apollo XP95 / Discovery detectors**
- **2 – 18 loops in one standard housing**
- **Brand new touch screen control panel**
- **Graphics LCD module 240 x 64 as standard included on basic model**
- **Integral Power supply 24V DC with max. 7,5 A or 4,0 A as standard included**
- **32 bit high performance CPU**
- **Flash memory up to 8 MB and RAM memory up to 8 MB**
- **Many powerful features included**

Description of Addressable Fire Alarm Control Panel

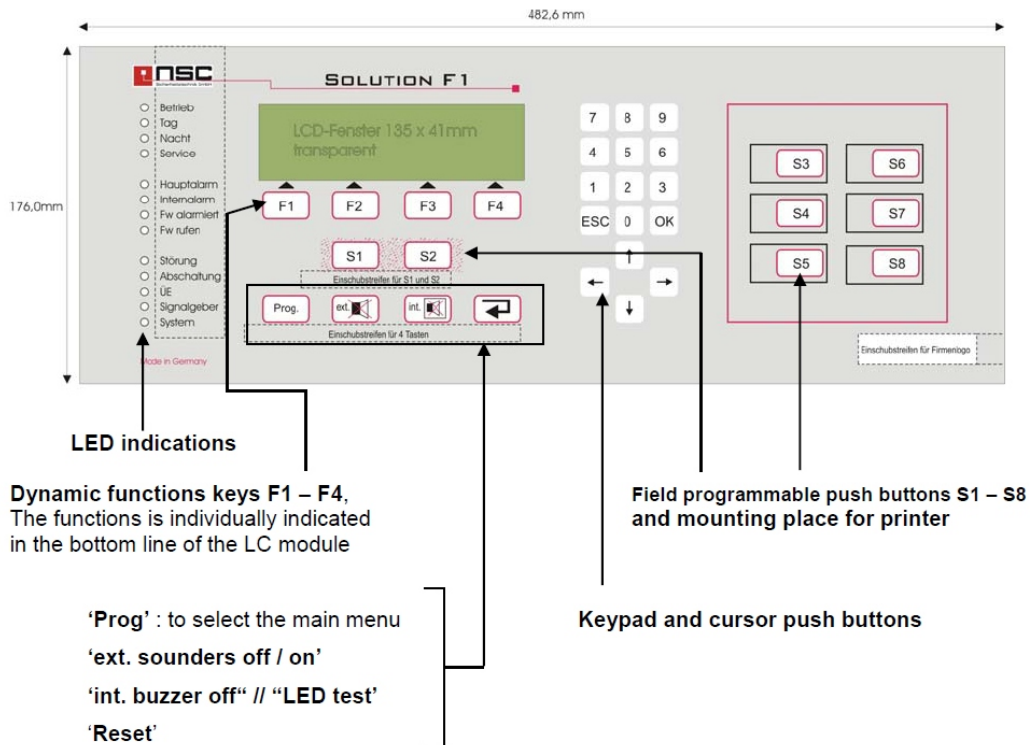

LED indications:

LED :	Description :
green LED „In Operation“	The Fire Control Panel (FCP) is in operation.
green LED „Day Mode“	Indicates that the FCP is in „Day Mode“. That means the main alarm is delayed if a delay time is configured.
green LED „Night Mode“	Indicates that the FCP is in „Day Mode“. That means the main alarm is NOT delayed and any alarm activates the Fire Brigade immediately.
green LED „Service“	Indicates that the FCP is in „Service Mode“.
red LED „Main alarm“	Indicates that the FCP is in Alarm condition. See LC module for detailed information. If an alarm transmission device (TD) is connected to the panel the panel has tried to activate the TD.
red LED „Internal alarm“	Indicates that the FCP is in Alarm condition. See LC module for detailed information.
red LED „Fire Brigade alarmed“	Indicates that the FCP has activated the alarm transmission device (TD) to the Fire Brigade and the TD gave a response to confirm the activation. (Input

Main Components

Loop Card for Solution F1 with 2 loops / 8 stub lines

- 2 loop- each maximum 127 detectors/ module or alternative 8 stub line
- 8 user programmable open collector outputs
- Cable shielding monitored for open and short circuit to +/- wire
- Earth fault detection



Redundant Loop Card for Solution F1 with 2 loops / 8 stub lines

As loop card for Solution F1 with 2 loop/ 8 stub lines but additional with 100% redundancy. This means the microprocessor, the RAM and the operating system memory are doubled on this card.

So there will be no failure in case of micro processor fault.



The Reliability

- If for certain applications a higher reliability as EN-54 and VdS standards is required – that will be no problem for the
 - “Solution F1” control panel: the Control Processing Unit can be doubled as well as the system boards which are responsible for the communication with the sensors and which passes the information from the detectors to the CPU. So the user gets a 100% redundancy of his whole system.
 - But the R&D people did not stop the ambitious aims for reliability there: They created a brand new control panel technology with absolutely no mechanical parts any longer which is unique in the security business and which has a lot of advantages for the installer as well as for the end user.
 - It contains a pressure sensitive piezo lacquer and doesn't have to be adjusted. The surface makes a worth-while impression because of it's glass like design.
 - This material is resistant against cleansing, there is absolutely no attrition over years and moreover it is very stable against EMC influences.
- If for certain applications a higher reliability as EN-54 and VdS standards is required – that will be no problem for the
 - “Solution F1” control panel: the Control Processing Unit can be doubled as well as the system boards which are responsible for the communication with the sensors and which passes the information from the detectors to the CPU. So the user gets a 100% redundancy of his whole system.
 - But the R&D people did not stop the ambitious aims for reliability there: They created a brand new control panel technology with absolutely no mechanical parts any longer which is unique in the security business and which has a lot of advantages for the installer as well as for the end user.
 - It contains a pressure sensitive piezo lacquer and doesn't have to be adjusted. The surface makes a worth-while impression because of it's glass like design.
 - This material is resistant against cleansing, there is absolutely no attrition over years and moreover it is very stable against EMC influences.



Main Components

Conventional detector card

- Compatible to almost all conventional detectors on the market
- 32 detectors per line
- 8 programmable open collector alarm outputs
- Earth fault detection
- Failure mode in case of microprocessor fault



Conventional detector card with 100% redundancy for 8 stub lines

As Conventional detector card for 8 stub lines but with 100 % redundancy.

That means the microprocessor, the Ram and the operating system memory are doubled on this card. So there will be no failure in case of microprocessor fault.



Main Components

Relay card with 8 change over contacts

- Compatible to fire detection system but usable as a universal device in other systems too
- 8 programmable change over contacts, each 250V AC / 5 A

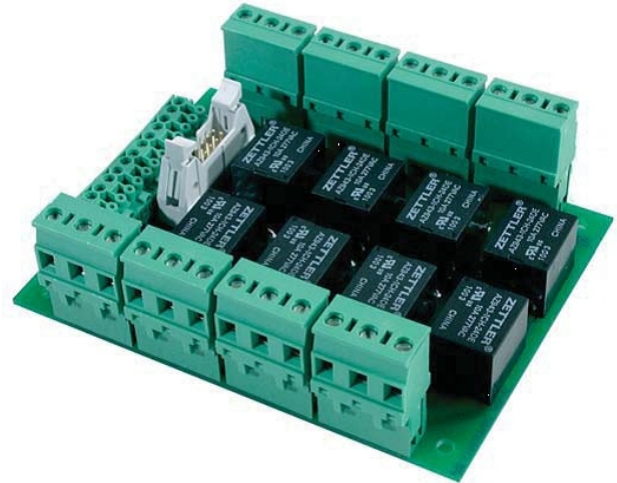

Analogue or ISDN modem for operating the configuration software via telephone line

- The modules can be plugged into a slot in the Fire Control Panel. Data speed up to 64.000 bps and they use the Fire Control Panel battery backup in case of mains failure.



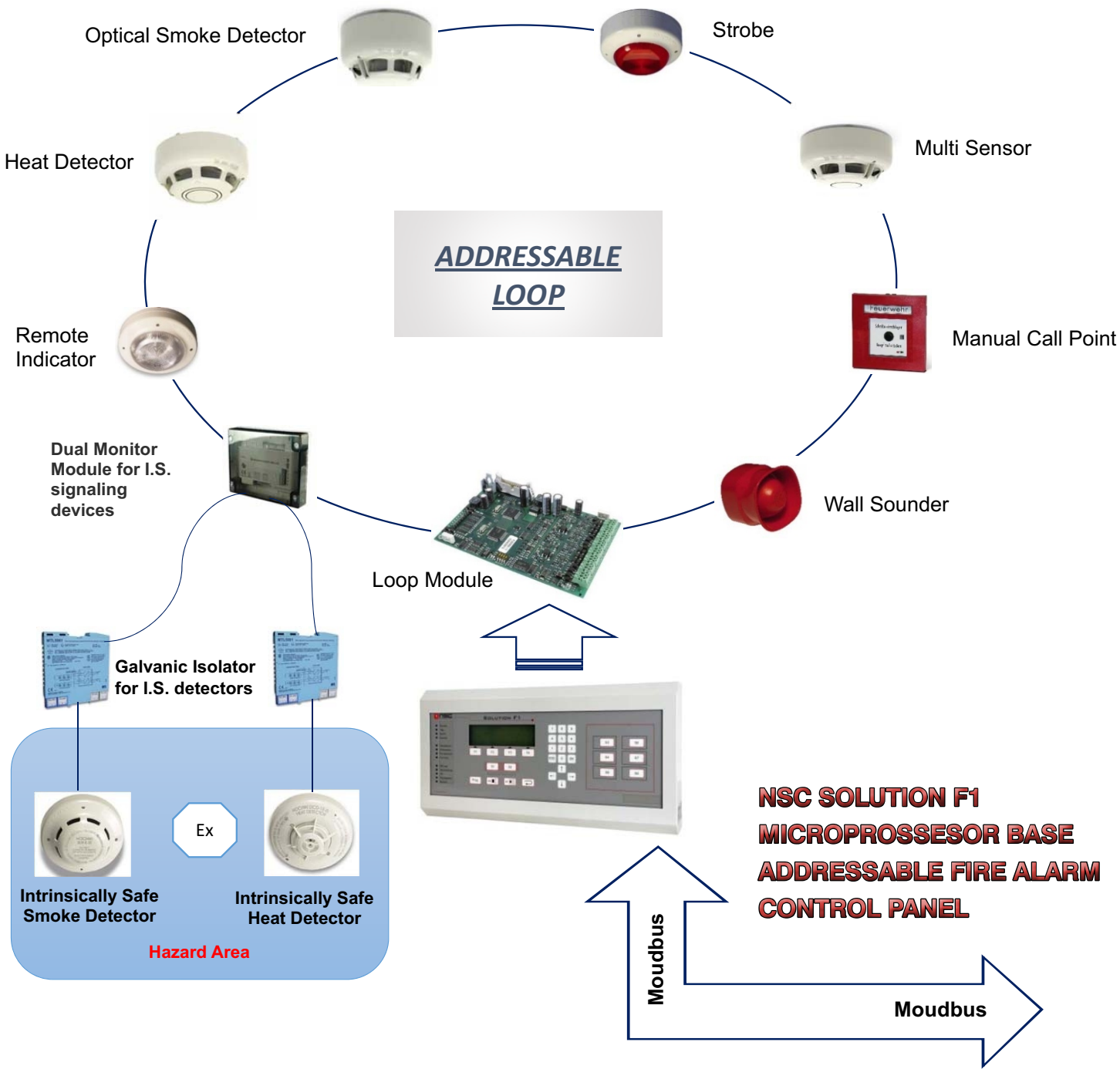

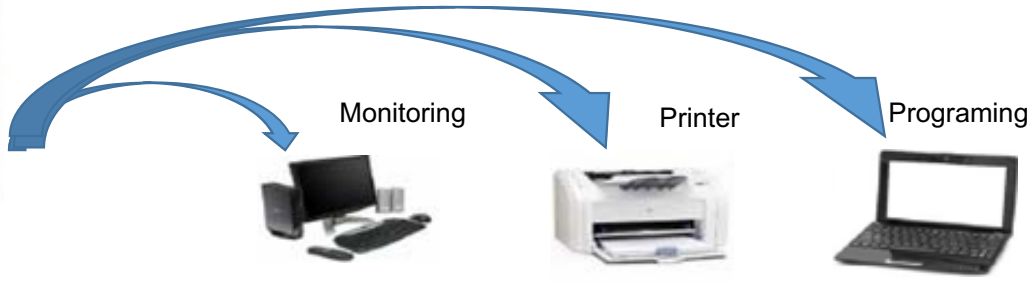
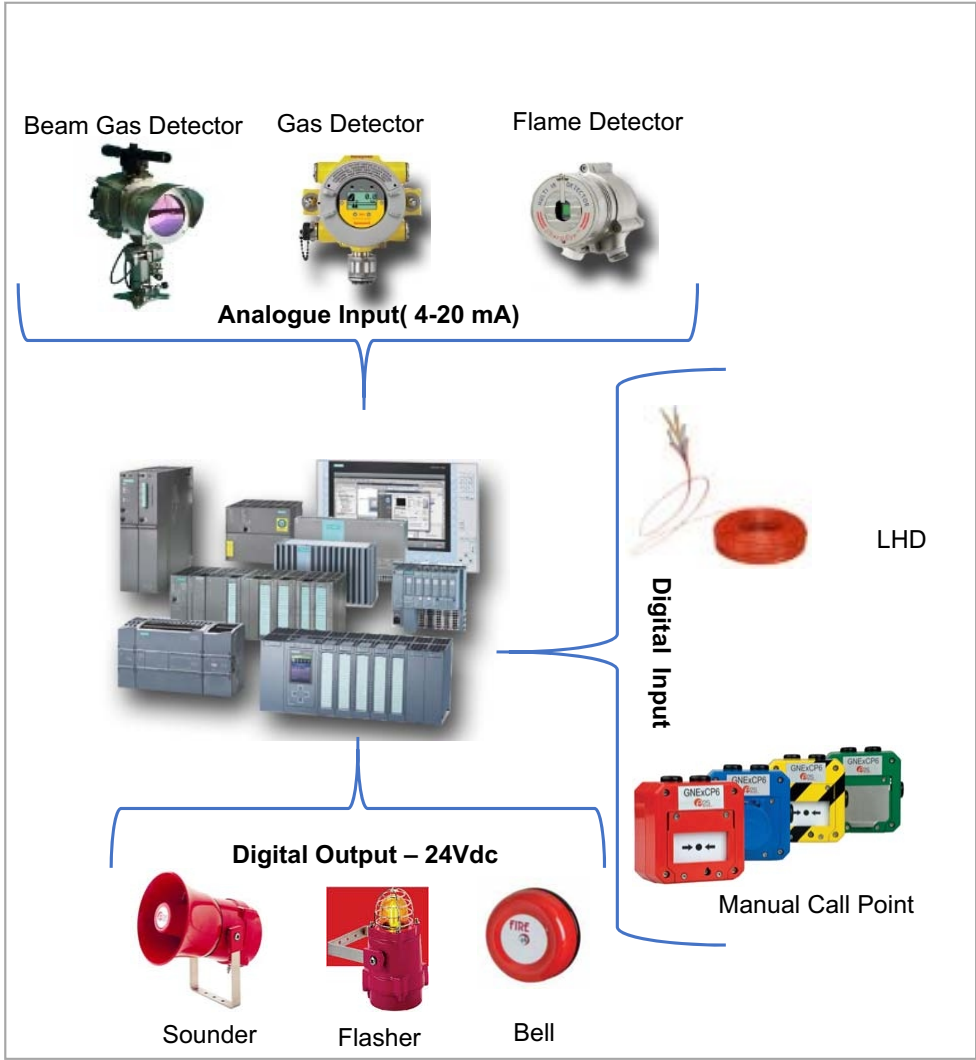



PHONE 0098 21 8873 38 12-3

FAX 0098 21 8876 44 55

WEB www.sariak.com

EMAIL info@sariak.com

Central Office: No.24, 12th St, Niloofar St,
Khoramshahr Ave., Tehran - Iran
P.O.Box: 16315-173