



# **Firestopping - Plan Review and Inspection of Joints**

**Presenter: Brice Miller**

**Tuesday, September 12, 2017**

**1:30 PM - 4:30 PM**



# Firestop Plan Review and Inspection of Joints

Presented by: Brice Miller



## Brice Miller

- ▶ 25 years as Building Official, Inspector and Plans Examiner with four ICC Certifications
- ▶ Past President of Colorado Chapter of ICC
- ▶ ICC – Proposed approved ICC Firestop Inspector Certification and served on Code Development and Certification committee's
- ▶ Code Instructor for Front Range Community College (Part time) for 15 years
- ▶ Provided firestop training throughout the US for 12 years
- ▶ Served as the Executive Director for International Firestop Council for 2-1/2 years

2

## Outline of Presentation

- ▶ Welcome and Introductions
- ▶ Importance
- ▶ Code Requirements and Testing
- ▶ Penetration and Perimeter Firestop Systems
- ▶ Joint Systems
- ▶ Review of Special Inspection requirements
- ▶ ASTM Inspection Standards
- ▶ Plan Review / Inspection of Joint Systems



## What is Firestopping?

**Which of the Following is the Definition of Firestopping:**

- A) That expensive red goop with the UL logo on the tube.
- B) The process of restoring the hourly rating to fire barrier walls and floors that have lost their fire rating from penetrations, joints and other openings (using materials tested to ASTM E-814 and UL1479.)
- C) A huge pain in the neck.

**Answer: All of the above**

4

**Education  
needs to  
continue!**



5

**Who's Responsible for Making Certain  
Firestopping is code compliant?**

- Owner
- Design Professional
- Manufacturer
- General Contractor
- Installer
- Plans Examiner
- Firestop Inspector



6

## FIRESTOP PROCESS

1. Designed
2. Plan Review
3. Installation
4. Inspection
5. Maintenance

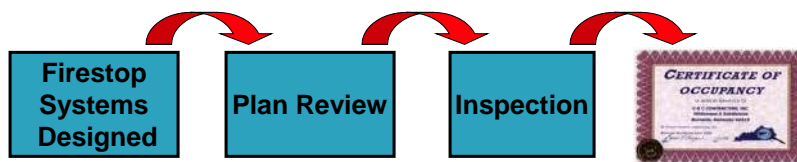

7

## International Code Council Certified Firestop Inspector?

- ▶ The International Code Council (ICC) has approved a new Firestop Inspector Certification that is on hold.



8

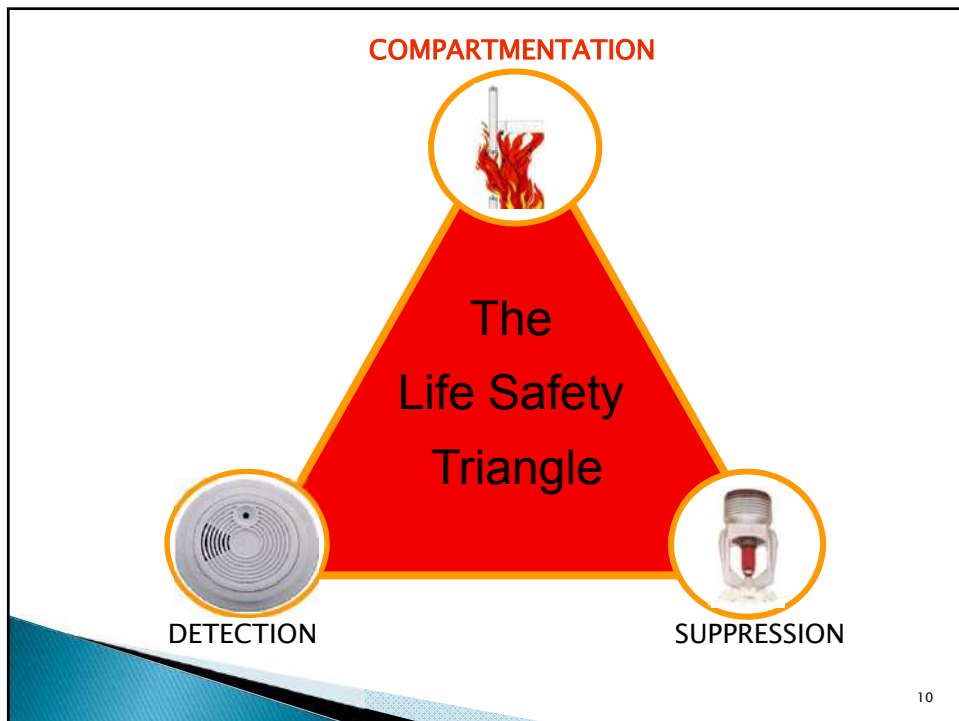
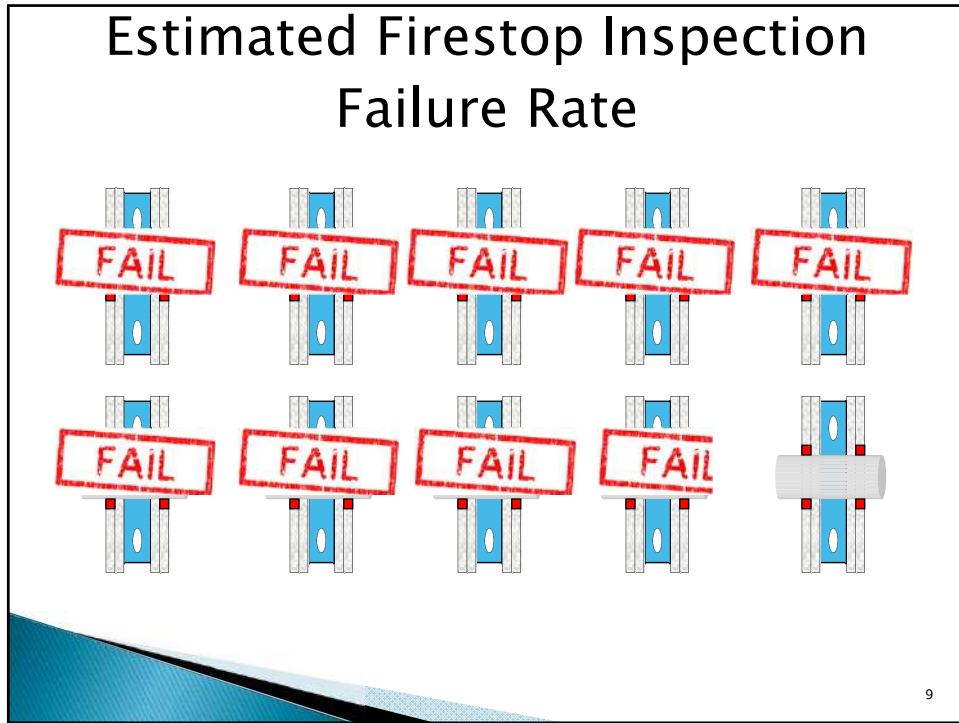

## Why is Firestopping Required

- Life Safety
- Property Protection
- Compartmentation



11

## Importance

- ▶ **Unsealed or improperly sealed openings cost lives and property!**
  - MGM Grand, Las Vegas, NV – Fire confined to 1<sup>st</sup> floor. Eighty-four fatalities, most on upper floors.
  - Hilton Hotel, Las Vegas, NV – Fire spread from 8<sup>th</sup> to 23<sup>rd</sup> floor in 25 minutes at exterior of building. Eight fatalities.
  - First Interstate Bank, Los Angeles, CA – Fire spread from 12<sup>th</sup> to 16<sup>th</sup> floor through improperly protected penetrations and unprotected perimeter joint. One fatality.
  - One Meridian Plaza, Philadelphia, PA – Fire spread from 22<sup>nd</sup> to 30<sup>th</sup> floor through improperly protected penetrations and through perimeter joint. Three fatalities.

1  
2

## What is the Leading Killer in Fires?



Smoke & Toxic Gases



13

## Sprinklers suppress flames, NOT smoke & gasses

75% of all fire deaths are caused by **smoke inhalation**.

Source: Hall, Jr. John R. NFPA Fire Analysis & Research, Quincy, MA. "Burns, Toxic Gases, and other Hazards".



14



## Containment in Construction

- ▶ Fire-resistance-rated assemblies
  - *Fire Walls*
  - *Fire Barriers*
  - *Fire Partitions*
  - *Smoke Barriers*
  - *Horizontal Assemblies*
- ▶ **Through- and Membrane-Penetrations**
- ▶ **Fire-resistant joint systems (i.e. construction joints and perimeter joints)**
- ▶ **Opening protection (i.e. fire-rated doors and windows)**
- ▶ **Air ducts and air transfer openings (i.e. dampers)**

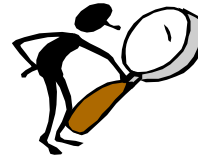

15

## Firestopping needed in many Applications

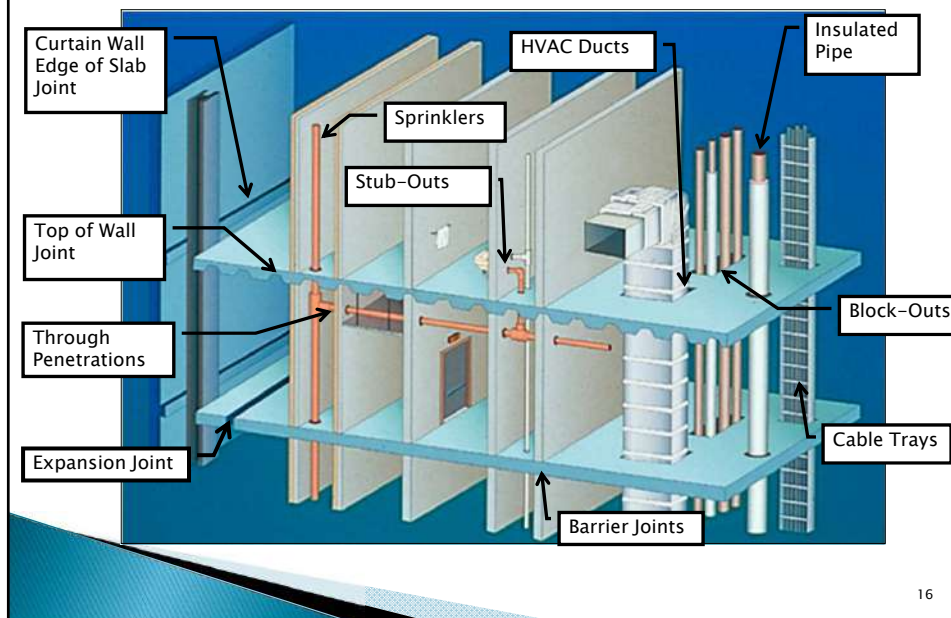

16

## Containment In Construction

### Through-Penetrations



17

## Containment in Construction

### Membrane-Penetrations



18

## Containment In Construction

### Construction Joints



19

## Containment In Construction

### Perimeter Containment

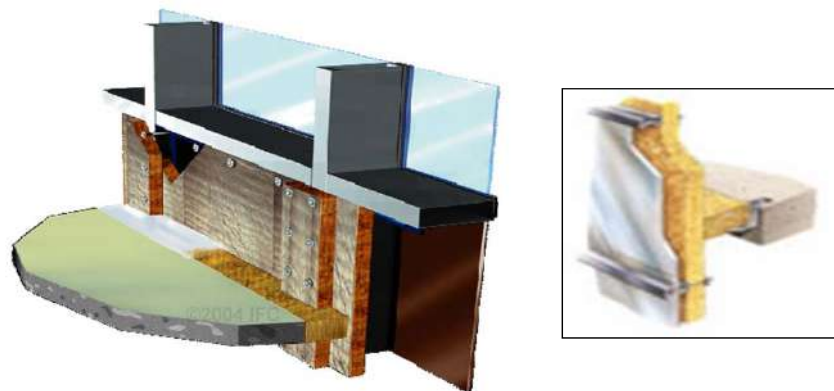

20

## Code Requirements – Firestopping

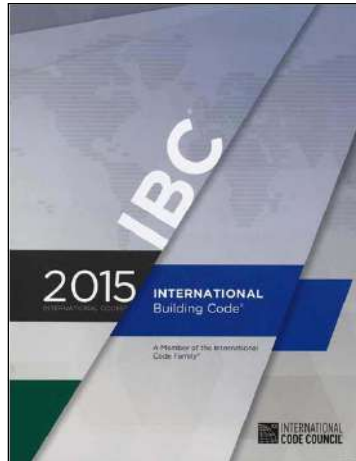

21

## Code Requirements – Firestopping

Minimum requirements for New Construction & Maintenance

- International Building Code – Chapter 7
  - New Construction
- International Fire Code – Chapter 7
  - Existing Buildings
- NFPA 101 – Chapter 8
- NFPA 1 – Chapter 12

22

## Firestop Code Requirements – IBC Submittals

- ▶ Code provisions provide clear direction for inclusion information on the plans.
  - **107.1.1** – Information on Construction Documents shall be of sufficient clarity to indicate the location, nature and extent of the work proposed and show in detail that it will conform to the provisions of this codes
  - **107.3.4.1-Deferred submittals** Deferred submittals are defined as those portions of the design that are not submitted at the time of the application and that are to be submitted to the building official within a specified period.



23

## Firestop Code Requirements – IBC Inspection

- ▶ Codes mandate that all firestop systems **MUST NOT** be concealed from view until inspected and approved:
- ▶ **110.3.6** Protection of joints and penetrations in fire-resistance-rated assemblies, *smoke barriers and smoke partitions shall not be concealed from view until inspected and approved.*

24

## Firestop Code Requirements – IBC Joints

- **Section 715.1: Fire Resistive Joint Systems**

“Joints installed in or between fire-resistance rated walls, floor or floor/ceiling assemblies and roofs or roof/ceiling assemblies shall be protected by an approved fire-resistant joint system designed to resist the passage of fire for a time period not less than the required fire-resistance rating of the wall, floor or roof in or between which it is installed.”

25

## Firestop Code Requirements – IBC Perimeter Barriers

- **Section 715.4 : “Exterior curtain wall/floor intersection.**

Where fire resistance-rated floor or floor/ceiling assemblies are required, voids created at the intersection of the exterior curtain wall assemblies and such floor assemblies shall be sealed with an approved system to prevent the interior spread of fire.”

- **715.4.1:** “Voids created at the intersection of exterior curtain wall assemblies and non-fire-resistance-rated floor or floor/ceiling assemblies shall be sealed with an approved material or system to retard the interior spread of fire and hot gases between stories.”

26

## Firestop Code Requirements 2012 IBC Special Inspections

- ▶ **1705.16** Fire-resistant penetrations and joints. In high-rise buildings or in buildings assigned to *Risk Category III or IV* in accordance with Section 1604.5, special inspections for through-penetrations, membrane penetration firestops, fire resistant joint systems, and perimeter fire barrier systems that are tested and listed
- ▶ **1705.1.1** Special cases. *Special inspections shall be required for proposed work that is, in the opinion of the building official, unusual in its nature*
- ▶ ASTM standards required in 1705.16 for inspection procedures (E2174-04 and E2393-04)

27

## International Fire Code (IFC) Inspection during life of a building

- **703.1 Maintenance.** The required fire-resistance rating of fire-resistance-rated construction (including walls, firestops, shaft enclosures, partitions, smoke barriers, floors, fire-resistive coatings and sprayed fire-resistant materials applied to structural members and fire-resistant joint systems) shall be maintained.
- 2009: Such elements shall be visually inspected by the owner annually and properly repaired, restored or replaced when damaged, altered, breached or penetrated.

28

## How Firestop Joint systems are Tested



29

## Code Requirements – IBC

### International Building Code Firestop Test Standards

 IBC	
Through Penetration	ASTM E814 UL 1479
Joints	UL 2079 ASTM E1966
Perimeter Barriers	ASTM E2307



30



## Fire-resistance ratings and fire tests

Section 703.2:

- Requires ratings per ASTM E 119 or UL 263
- Also includes the following three concepts:
  - Section 703.3 may be used as an alternate means for determining fire resistance.
  - When incorporating materials, systems or devices that were not tested as a part of an assembly's fire test, sufficient data must be made available to the building official to show the required fire-resistance rating has not been reduced.
  - Materials and methods used to protect joints and penetrations shall not reduce the fire-resistance rating of an element, component or assembly.



## Fire-resistance ratings and fire tests

ASTM E 119 and UL 263 evaluate ability to:

- Contain fire
- Maintain structural ability

Test also

- Measures and evaluates heat transfer through membrane elements that protect structural framing, and through entire assembly



## Joint firestop systems

### Compliant systems

- Accommodate cyclical movement of adjacent assemblies
- Prevent the passage of flame and hot gases sufficient to ignited cotton waste on unexposed side of the assembly
- Will remain in place when subjected to the hose stream test



## Test criteria – Section 715.3

ASTM E 1966 and UL 2079 are essentially equivalent

- Both focus on joint and ability to go through movement cycles
  - ASTM E 1966 does not evaluate smoke leakage so must use UL 2079 for L rating

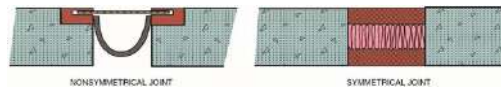

Nonsymmetrical wall joint systems must be tested from both sides, or from least fire-resistant side (similar to 703.2.1 wall test)

- Exception for exterior walls with fire separation distance greater than 5 feet.



## Where required

Section 715.1 states joints “in or between fire-resistance-rated” walls or horizontal assemblies are required to be protected by approved systems

- Most locations are covered by this general requirement or the exception in 715.1
  - There are nine exempt locations in 715.1
- Sections 715.4 through 715.6 contain specific requirements for certain locations



## Exception from 715.1

The exception in 715.1 list nine locations where joint systems are not required to be installed

- Most eliminate joint protection due to fact that some other code provision would allow a fire to circumvent the joint system
- Therefore code cannot justify requiring a joint system where the fire can bypass it by another route



## Exempt locations

- Item 3: Floors within atriums
  - Applies within the atrium enclosure
  - Does not extend to entire floor level unless space is included in smoke control system design

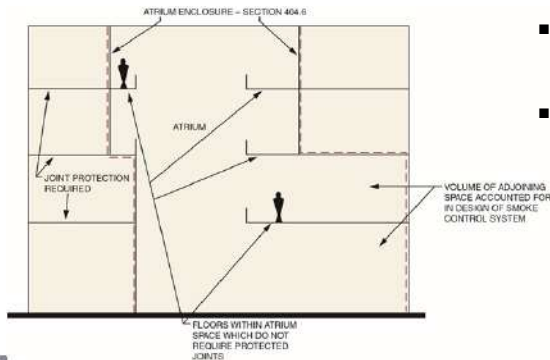

## Conditioning Prior to Fire Test

Movement Class	Min. No. of Cycles	Min. Cycling Rate (Cycles / Minutes)
Class I (Thermal)	500	1
Class II (Wind Sway)	500	10
Class III (Seismic)	100	30

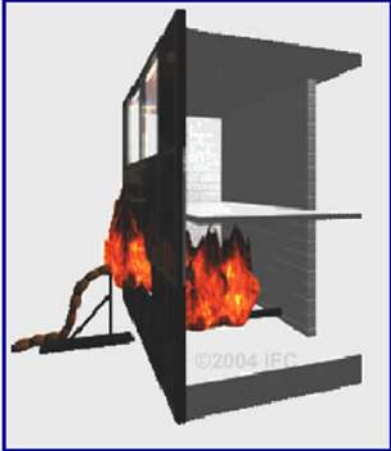

**ASTM E2307**  
**Standard Test Method  
for Determining Fire  
Resistance of Perimeter  
Fire Barriers Using  
Intermediate-Scale,  
Multi-Story Test  
Apparatus**

39

## **General features in ASTM E 2307 systems**

Perimeter fire containment systems passing ASTM E 2307 typically include:

- Some type of mineral wool insulation mechanically secured to the interior side of the spandrel panels of the exterior wall so it protects the curtain wall framing system;
- A reinforcing angle or channel mechanically secured to the curtain wall adjacent to the floor slab;
- Compressed mineral wool insulation filling the gap or void between the floor and the curtain wall, which is commonly referred to as “safing;” and
- A smoke seal applied on top of the safing insulation.



## Cyclic Movement and Measuring Min.& Max. Joint Widths of Architectural Joint Systems



41

## Fire Resistive Joint Testing

*Head of Wall Joint*



*Floor to Floor Joint*

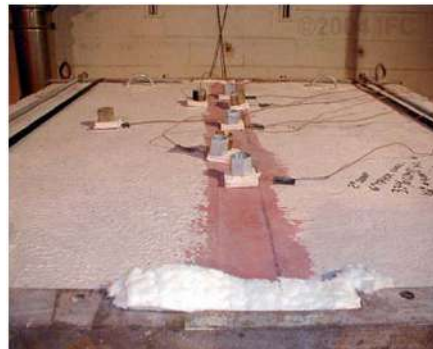

42

## Time - Temperature Curve

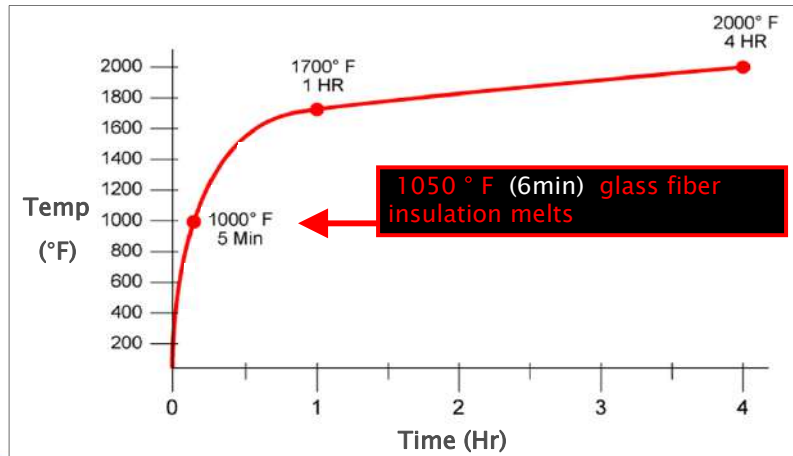

43

## Hose Stream Test



## Now that we understand testing of firestopping

How are they expressed?

- ▶ Shop Drawings
- ▶ UL systems (or another lab)
- ▶ Design Listings

All are essentially “Firestop Systems”



## Evaluating Firestopping

It is all about the  
**SYSTEMS**

### Points to remember

- Firestop materials are not systems
- Systems employ Firestop materials
- Products do not receive ratings, “Systems Do”



## Questions / Discussion



47

## Engineering Judgments:

- ▶ What are they?
- ▶ When are they acceptable?
- ▶ When are they not appropriate?
- ▶ What are the guidelines?
- ▶ When should the AHJ review these?



48

## Engineering Judgments

- ▶ An Engineering Judgment is a letter or report issued by some knowledgeable party which evaluates the construction of some site-specific application which deviates from a tested design, system or assembly and concludes with a judgment of the applicable rating of that assembly
- ▶ Engineering Judgments are commonly called EJ's.
- ▶ They are also known as:
  - *Certificate of compliance*
  - *Engineering recommendations*
  - *Alternative solutions*

49

## IBC References Justifying Engineering Judgments

- ▶ IBC 104.11 Alternative materials, design and methods of construction and equipment
- ▶ IBC 703.2 Fire-resistance ratings
- ▶ IBC 703.3 Alternative methods for determining fire resistance

50

## Engineering Judgments Review

- ▶ Contractor or architect typically initiates process
- ▶ Can be in letter and/or drawing
- ▶ AHJ makes decision on validity of engineering judgment letter and if approved, inspects construction for consistency with letter.

51

## Who Issues Engineering Judgments?

- Professional engineer
- Fire protection engineer
- Manufacturer
- Testing laboratory
- ▶ Must be acceptable to the Building Official or the AHJ



52

## IFC Guidelines

- ▶ Two Documents
  - Recommended IFC Guidelines for Evaluating Firestop Systems in Engineering Judgments (EJs)
    - Covers firestops, joint systems and grease/air duct assemblies
  - Recommended IFC Guidelines for Evaluating Firestop Systems in Engineering Judgments (EJs) – Perimeter Fire Barrier Systems
    - Covers perimeter fire barriers systems (a.k.a. perimeter fire containment systems or perimeter joints)

53

## Questions / Discussion



54

## Penetration Firestop Systems

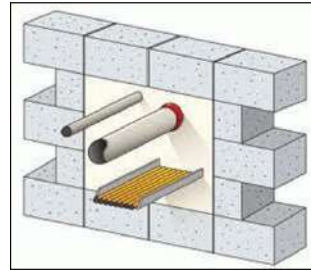

55

There are 3  
parts to a  
Listed  
Firestop  
System



56

## Penetration Firestop System

Consists of:

- ▶ Assembly being penetrated
- ▶ Penetrating item
- ▶ Fill, void or cavity materials (firestopping materials)

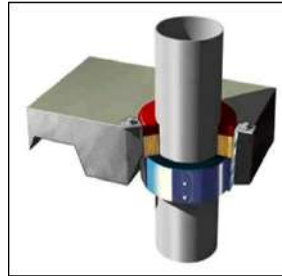

57

## Questions / Discussion



58

## Sprinkler Pipe Considerations

### Metallic Sprinkler Pipe Penetrations:

- ▶ NFPA 13 Annular Space Limitations
  - If Pipe < 3.5" then annular = 1"
  - If pipe > 3.5" then annular = 2"
- ▶ Pipe Movement
  - Seismic Movement



59

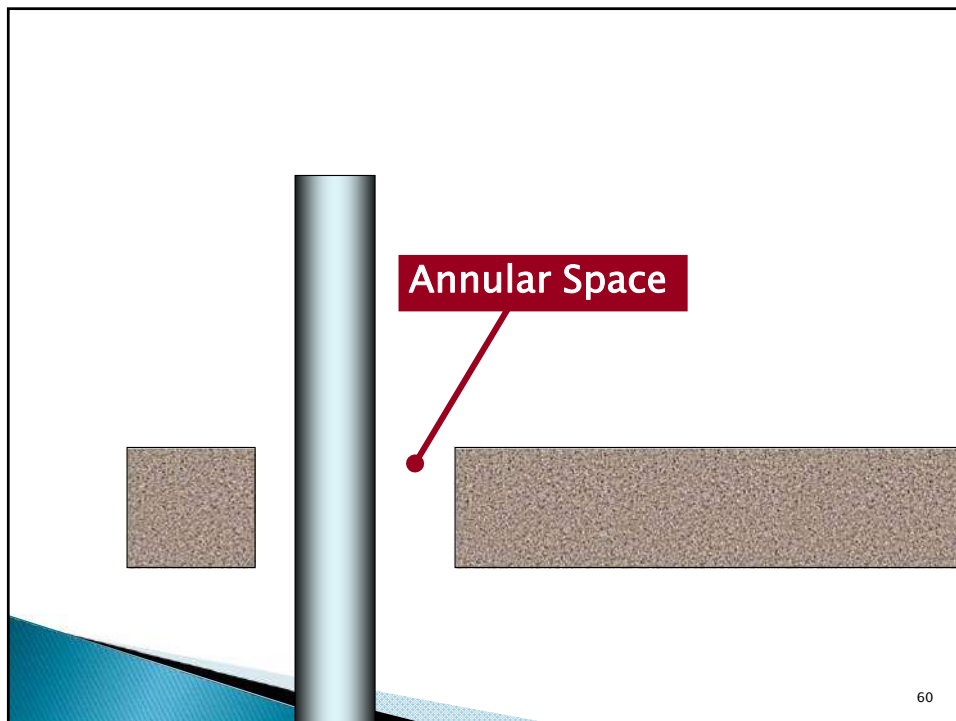

60

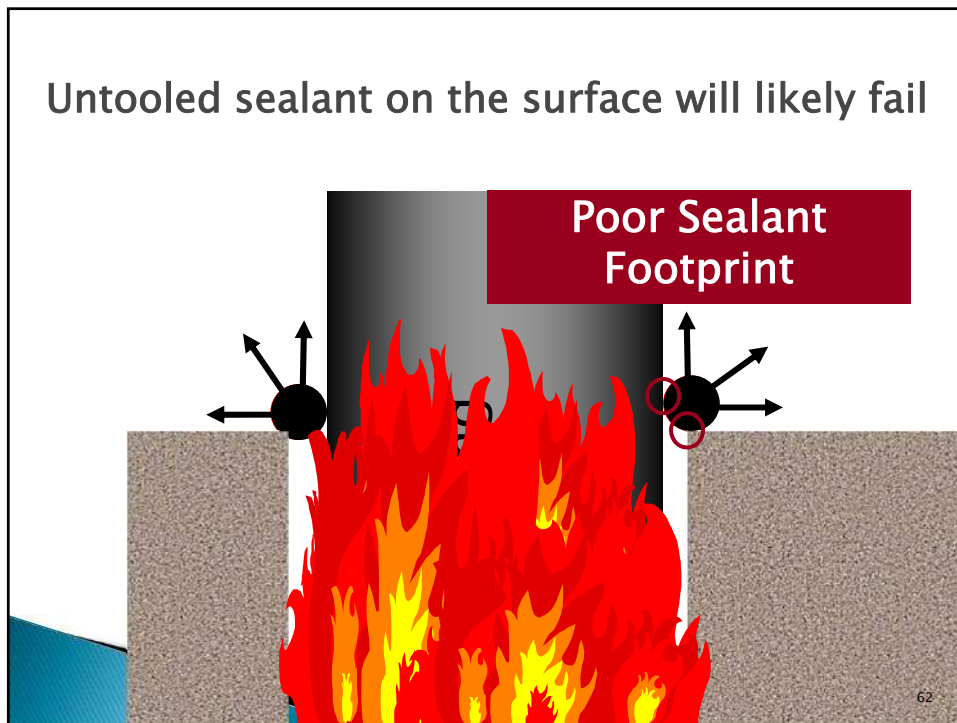
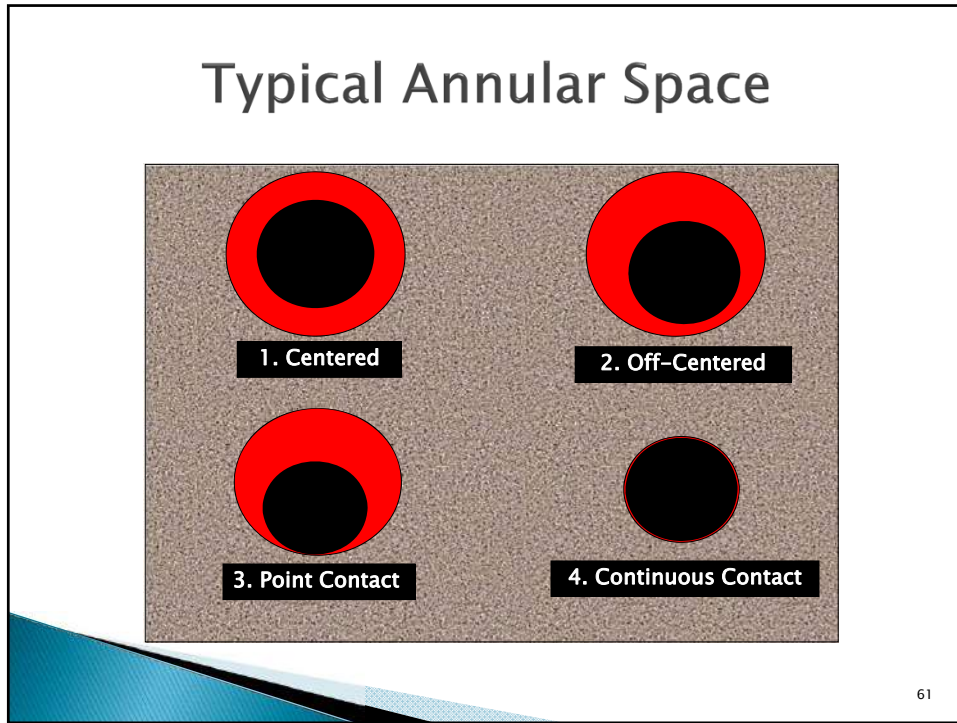



Properly recessed and tooled sealant will expand inward as designed.



## Properly Tooled Penetrations

- ▶ The Firestop sealant must be well bonded to penetrating item and surrounding wall or floor
- ▶ Should always inspect both sides



64

## Questions / Discussion



65

## Evaluating a Penetration It is all about the **SYSTEMS**

### Points to remember

- Firestop materials are not systems
- Systems employ Firestop materials
- Products do not receive ratings,  
“Systems Do”

66

## Where Can I Find The Most Current Listings?



## Online Certifications Directory

- ▶ Helps you achieve code compliance
- ▶ Is continuously updated
- ▶ Needs no password
- ▶ Is free - no charge for use
- ▶ [www.ul.com/database](http://www.ul.com/database)

## For the Contractor

**UL Systems serve two roles:**

- 1) Evidence of compliance**
- 2) A set of build-instructions**

Reproduced courtesy of Underwriters Laboratories, Inc. Created or Revised: 01/01/00  
 Specified Technologies, Inc., Somerville, NJ (908) 982-1180 F100-3386

## For the Building / Fire Official

**UL Systems serve two roles:**

- 1) Evidence of compliance**
- 2) Document by which to inspect**

Reproduced courtesy of Underwriters Laboratories, Inc. Created or Revised: 01/01/00  
 Specified Technologies, Inc., Somerville, NJ (908) 982-1180 F100-3386

## Questions / Discussion



71

## Joint Systems



72

## Building Code Requirements 2012 IBC – Joints

- ▶ 715.1 – Joints installed in or between fire-resistance-rated assemblies shall be protected by an approved fire-resistant joint system designed to resist the passage of fire for a time period not less than the required fire-resistance rating of the assembly in which it is installed

73

## Building Code Requirements IBC – Joints in Smoke Barriers

- ▶ Joints systems in smoke barriers needs to be designed and constructed to restrict the movement of smoke. The type of rating used is an L Rating which is a measurement of air leakage rate through a fire resistive joint system or penetration.
- ▶ 715.6 – Joints in smoke barriers shall have an L Rating not in excess of 5 cfm / lineal ft of opening

74

## Building Code Requirements IBC – Joints

- ▶ 715.2 – Fire-resistant joint systems shall be securely installed in or on the joint for its entire length so as not to dislodge, loosen or otherwise impair its ability to accommodate expected building movements and to resist the passage of fire and hot gasses
- ▶ 715.3 – Joints shall be tested to ANSI/UL 2079 or ASTM E 1966”

75

## 4 Types of Rated Joint Systems

- ▶ Floor-to-Floor (Expansion Joint)
- ▶ Floor-to-Wall (Slab/Shaft)
- ▶ Wall-to-Floor (Top & Bottom of Wall)
- ▶ Wall-to-Wall (Vertical Control Joint)

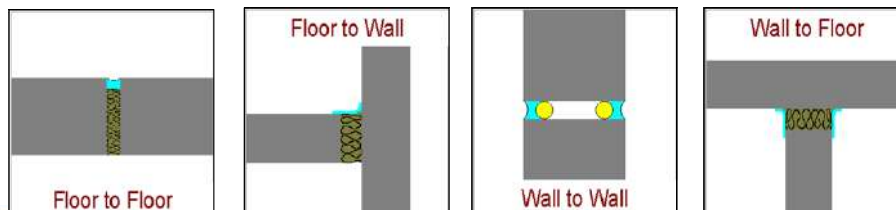

76

## Construction Joint Terminology

- ▶ Nominal Joint Width
- ▶ Assembly Rating
- ▶ Movement
- ▶ Extension
- ▶ Compression
- ▶ Percent (%) Extension / Compression
- ▶ Mineral Wool Compression
- ▶ Sealant Depth

77

## Categories of Fire-Resistive Joints

- ▶ Sealant Systems (Caulks)
- ▶ Sprayed /Elastomeric Membranes (Sprays)
- ▶ Mechanical Joints

78



## Head-Of-Wall Joint Systems

For interior non-load bearing fire-rated walls



79

## Typical Head of Wall Joint System With Nominal Joint Width

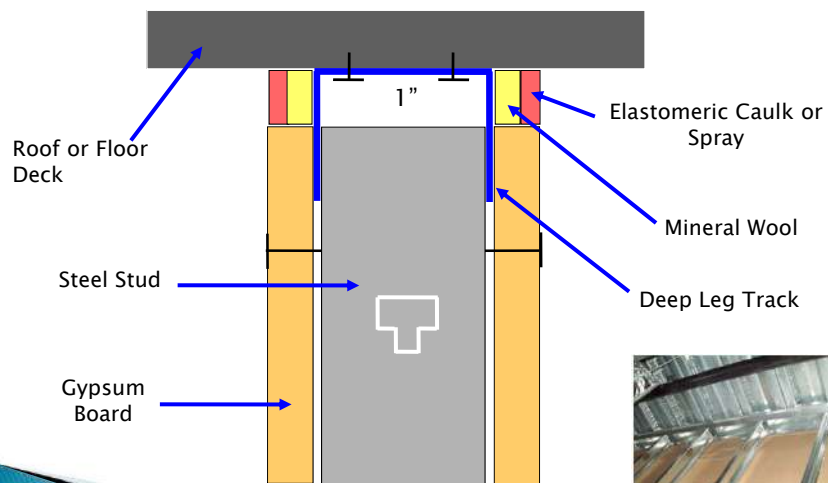

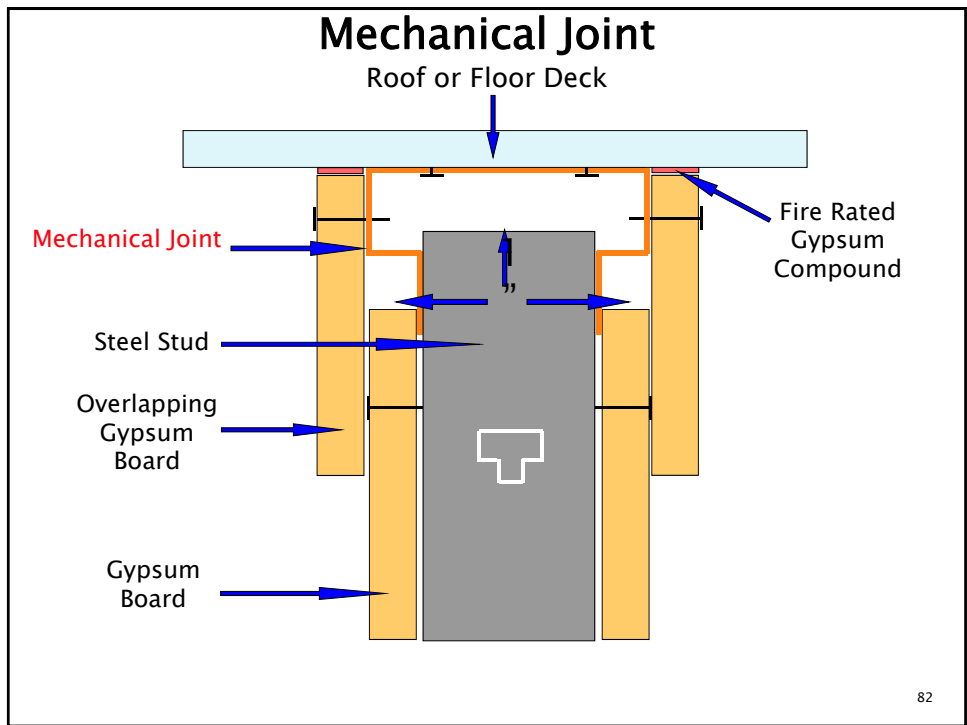
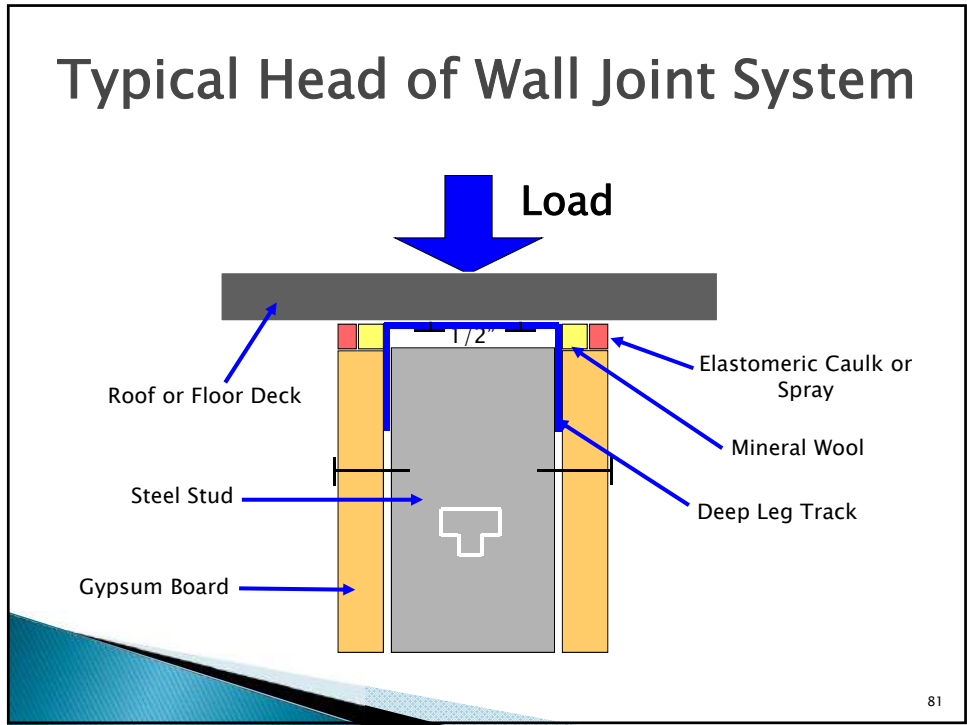

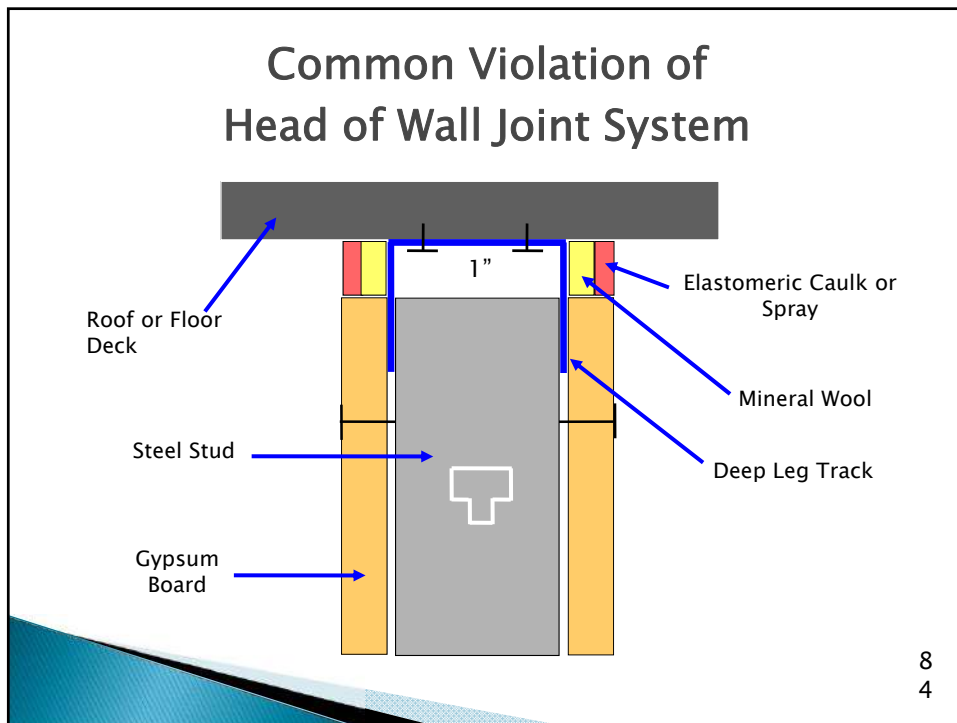
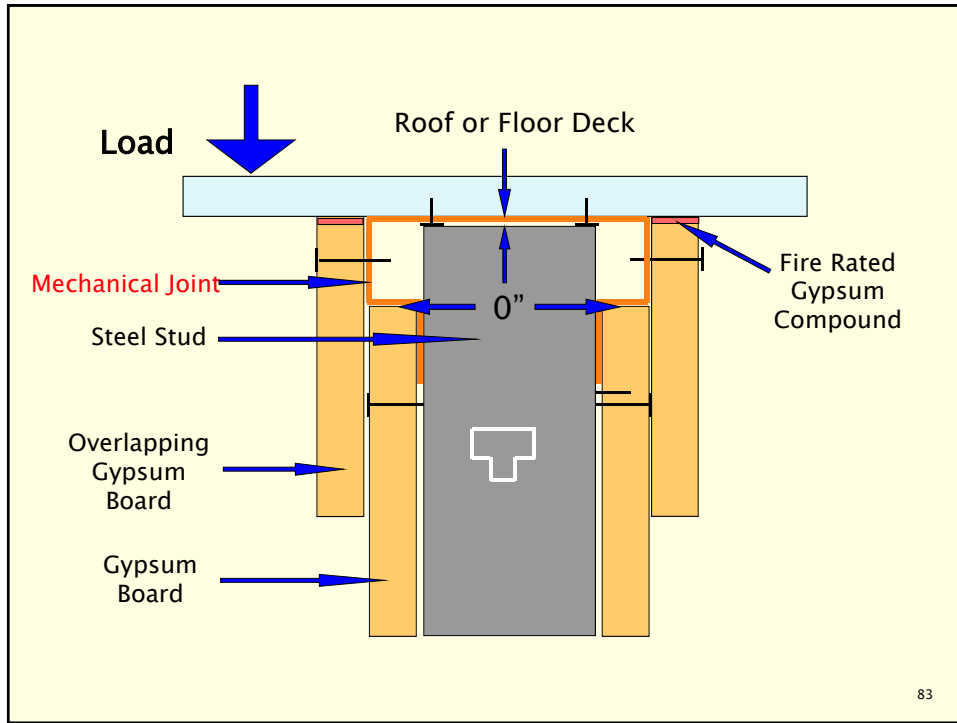

## HEAD OF WALL SOLUTIONS



**TAB - TRACK  
SLOTTED TRACK**

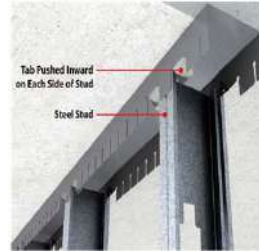

85

## Other Types of Head of Wall Joints



## Other Joint systems to Maintain fire ratings

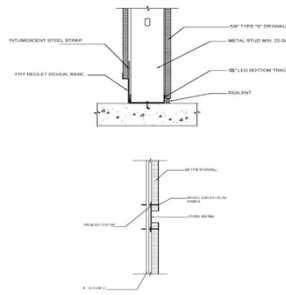
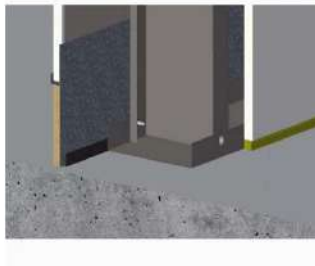

## Wall to Wall Joints

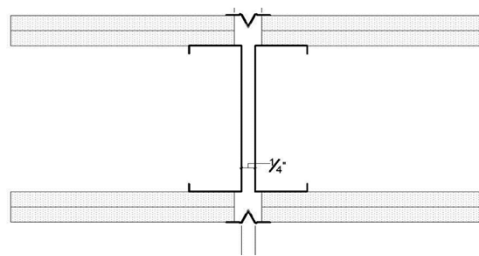

# Evaluating a Fire-Resistive Joint System

**System No. FW-D-0001**

**Assembly Rating - 1 Hr**  
 I. Rating at Ambient — Less than 1 CFM/Lin Ft  
 I. Rating at 400 F — Less than 1 CFM/Lin Ft  
 Nominal Joint Width - 2 In.  
 Class II Movement Capabilities - 12.5% Compression or Extension

1. WI
- 
2. WI  
fr
- 
3. WI
- 
4. WI
5. Hc
- 
6. Ar
-

oint?  
ling  
ed

size)  
asure

1. **Wall Assembly** — Min 4-1/2 in. thick reinforced lightweight or normal weight (100 - 150 pcf) structural concrete. Wall may also be constructed of any UL Classified **Concrete Blocks\***. See **Concrete Blocks (CAZT)** category in the Fire Resistance Directory for names of manufacturers.

2. **Floor Assembly** — Min 2-1/2 in. thick reinforced lightweight or normal weight (100 - 150 pcf) structural concrete.

3. **Joint System** — Max separation between edge of floor and face of wall (at time of installation of joint system) is 2 in. The joint system is designed to accommodate a max 12.5 percent compression or extension from it's installed width. The joint system shall consist of the following:

A. **Forming Material\*** — Min 4 pcf mineral wool batt insulation installed in joint opening as a permanent form. Pieces of batt cut to min width of 2-1/2 in. and installed edge-first into joint opening, parallel with joint direction, such that batt sections are compressed min 50 percent in thickness and that the compressed batt sections are flush with top surface of the floor. Adjoining lengths of batt to be tightly-butted with butted seams spaced min 24 in. apart along the length of the joint.  
ROXUL INC. — SAFE Mineral Wool  
 THERMAFIBER L.L.C. — SAF Mineral Wool

B. **Fill, Void or Cavity Material\* - Spray** — Min 1/8 in. wet thickness of fill material applied on top surface of floor to completely cover the mineral wool and overlap a min 1/2 in. onto concrete floor and side of wall.  
ABC FIRESTOPPING CO. — SuperDuper Firestop Spray

\*Bearing the UL Classification Mark

Navigating the UL Directory:

**JOINT SYSTEMS (XHBN)**

**HW - D - 0060**

**First Two Alpha Characters** identify the type of joint system:

- FF = Floor-to-Floor
- WW = Wall-to-Wall
- FW = Floor-to-Wall
- HW = Head-of-Wall

Resource: ICC/IFC Pocket Guide

91

Navigating the UL Directory:

**JOINT SYSTEMS (XHBN)**

**HW - D - 0060**

**Third Alpha Character** identifies the movement capabilities of the system:

- D = Dynamic (movement capabilities)
- S = Static (no movement capabilities)

92

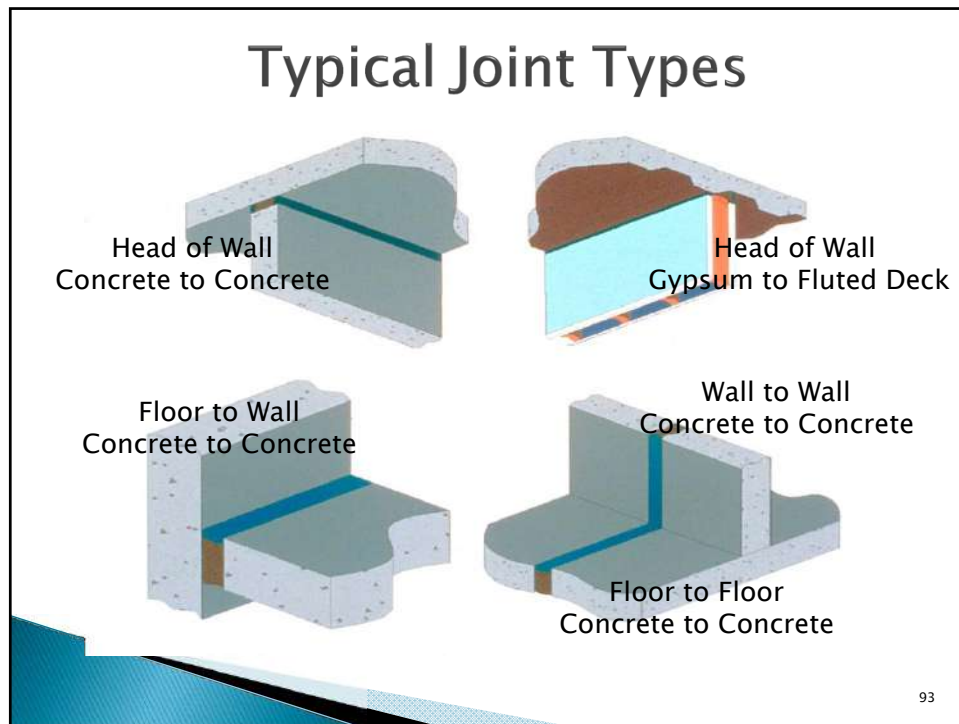

## Plan Review of Joint Systems

- ▶ What type of joint is being protected?
- ▶ What is the required hourly rating?
- ▶ What is the width of the joint (nominal installed width)?
- ▶ How much movement is required?
- ▶ Is an L Rating required?
- ▶ Is submitted system consistent with the above requirements?

94



## Recommended Joint System Correction Notice

- ▶ Deflection is required to be installed with an approved joint system per Section 715 of the IBC. The assemblies need to be designed to allow joints to compress and extend with movement of structure while maintaining the fire-rating of the assemblies.
- ▶ Please clarify building deflection by listing the Maximum and Minimum building deflection movements to determine movement capabilities of assembly and identify listed assemblies for all joint systems.

95

## Inspection of Joint Systems

- ▶ Inspect joints at framing inspection
- ▶ What type of building assemblies form the joint (type and thickness)?
- ▶ What materials are the assemblies constructed from?
- ▶ Are there any special considerations? (EJ's)

96

## Inspection of Joint Systems

- ▶ Is the nominal joint width installed per the listing?
- ▶ Does the joint width fall within the system limits? (Compression and/or Extension)
- ▶ Is backing material required by the system?
- ▶ Is the backing compression ratio correct?
- ▶ Does the sealant depth match the system requirements?

97

## Questions / Discussion



## Perimeter Fire Containment Systems



PATHS OF FIRE PROPAGATION

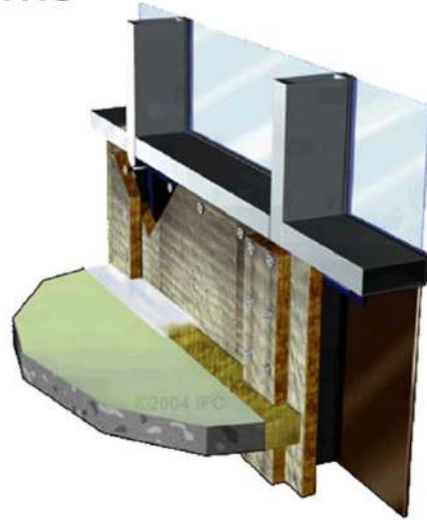

99

## Extending the Floor to the Wall...

**MANDATORY!**

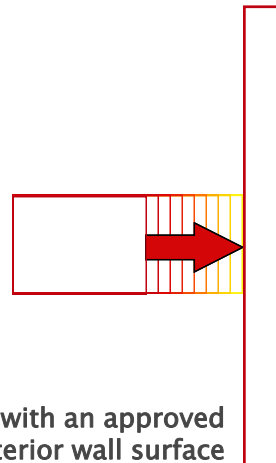

The perimeter joint must be sealed with an approved material or system that extends to the exterior wall surface

100

## Code Requirements

- ▶ Sections 715.4 Exterior curtain wall/floor intersection. Void at edge of rated floor shall be sealed with an approved system, shall be securely installed and Tested to ASTM E 2307 for time period equal to rating of floor
- ▶ 715.4.1 “Voids created at the intersection of exterior curtain wall assemblies and non-fire-resistance-rated floor or floor/ceiling assemblies shall be sealed with an *approved material or system to retard the interior spread of fire and hot gases between stories.*”
- ▶ Section 715.5 Spandrel Wall. Height and fire-resistance requirements for curtain wall spandrels shall comply with Section 705.8.5.

101

## Curtain wall and nonrated floor assembly intersections

Section 715.4.1 applies where curtain wall is adjacent to a nonrated floor assembly

- Little code guidance as to level of protection required – uses term “approved”
- Is permissible to use a tested system – even with nonrated floor
- Material should be secured into place and compatible for floor construction and use



2015 IBC Dampers, Penetration Firestops and Joint Systems

102

## Terminology

Industry uses a number of terms to describe these systems

- Perimeter fire containment system
- Perimeter joint systems
- Floor edge joint systems
- Safing joint systems
- Perimeter fire barrier systems



2015 IBC Dampers, Penetration Firestops and Joint Systems

103

## Terminology

Aluminum Transom

Vision Glass



Spandrel: Glass, Aluminum or .....

Aluminum Mullion

104

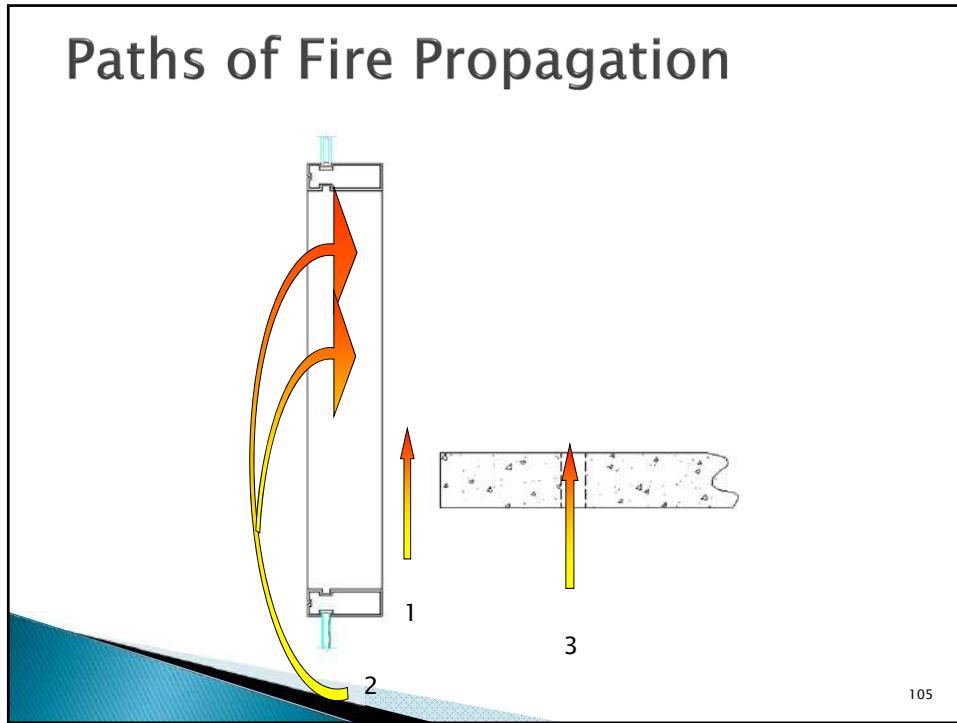

## Typical Curtain Wall System Cont.

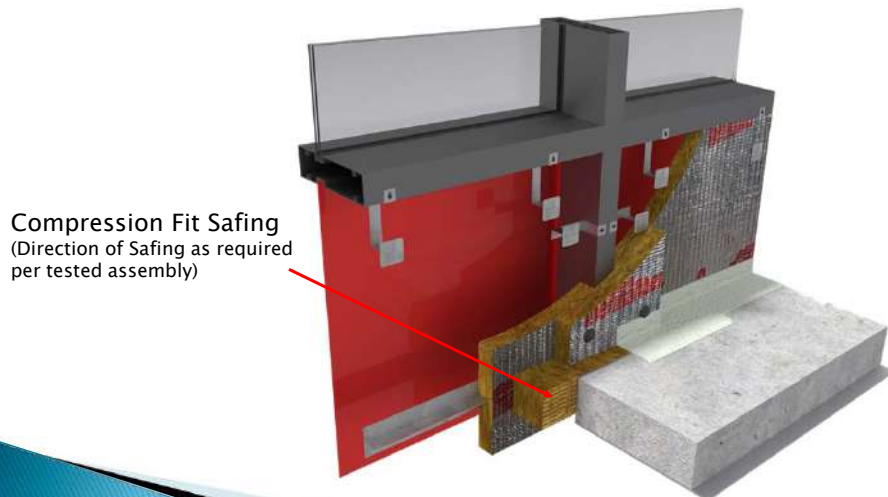

Compression Fit Saffing  
(Direction of Saffing as required  
per tested assembly)

107

## Typical Curtain Wall System Cont

- ▶ To allow for movement between the slab and wall mineral wool must be inserted perpendicular to the joint and compressed to the proper %

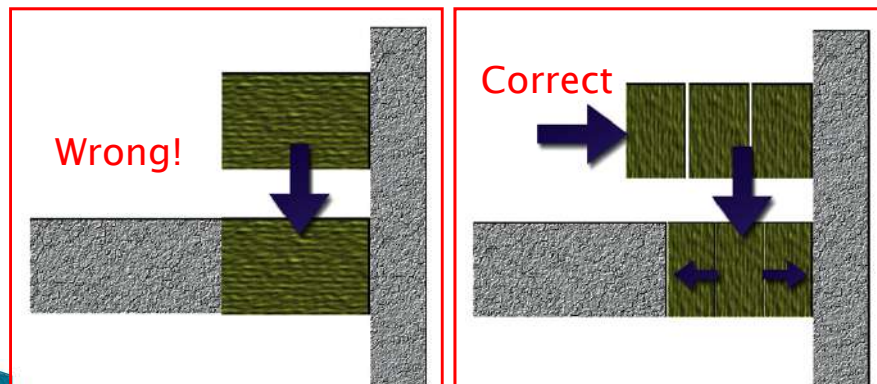

STI Graphic

108

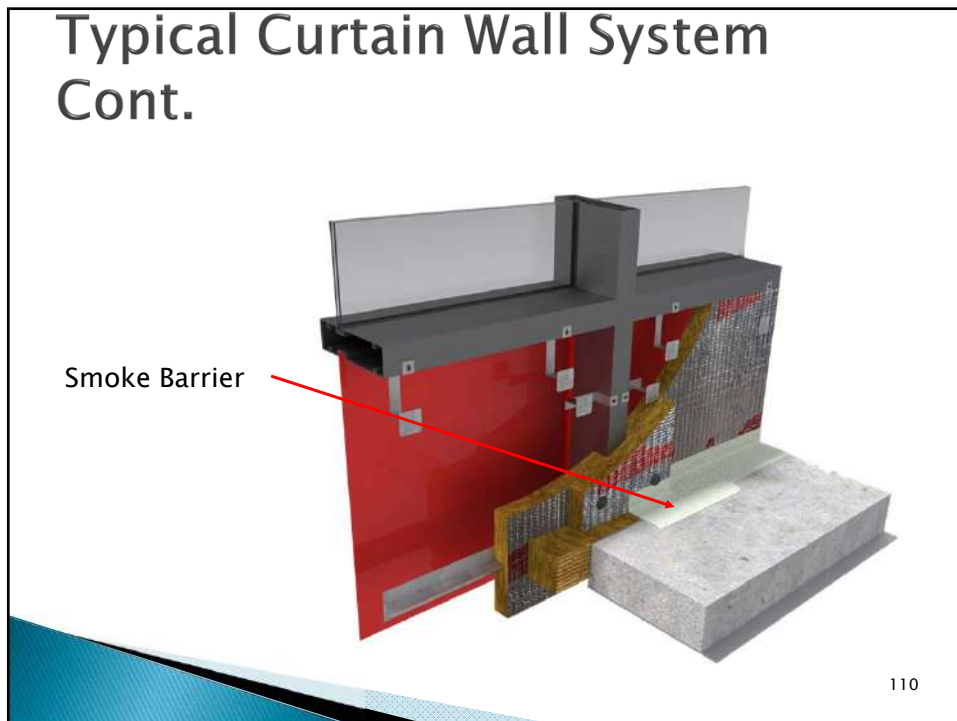
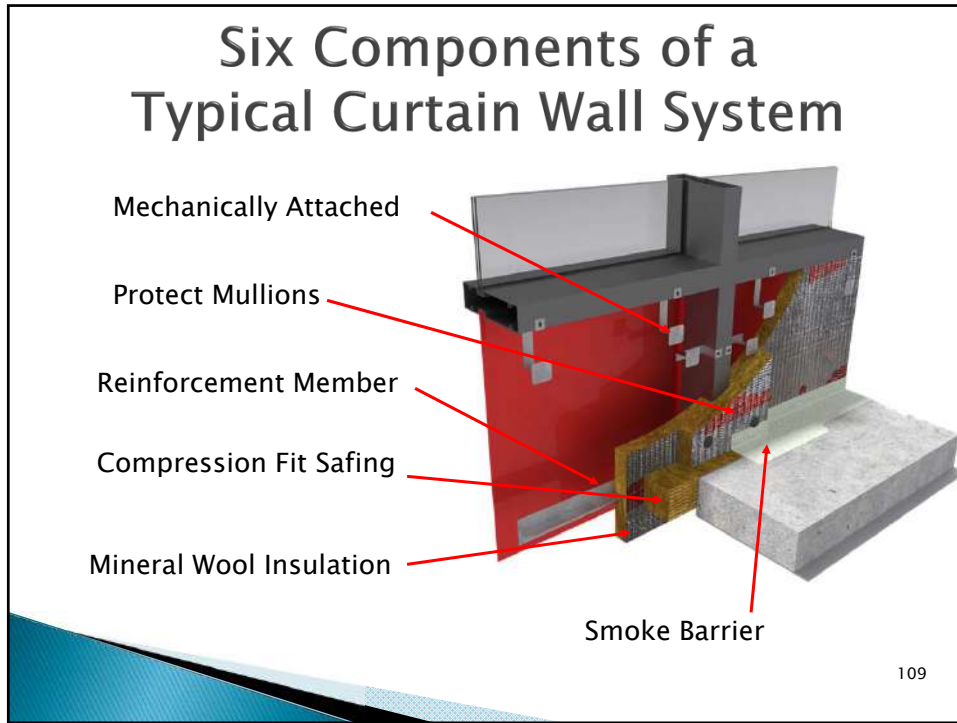



## Evaluating a Perimeter Joint System

### PERIMETER FIRE CONTAINMENT SYSTEMS (XHDG)

**Third Alpha Character** identifies the movement capabilities of the system:

- D = Dynamic (movement capabilities)
- S = Static (no movement capabilities)

112

## Plan Review of Perimeter Joints

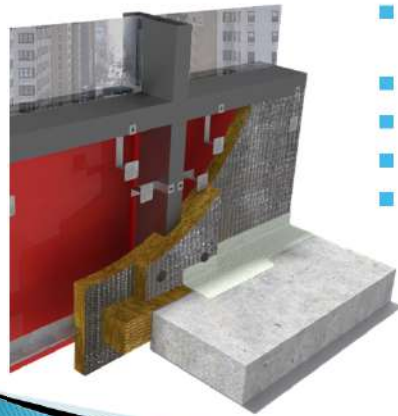

- Floor and/or wall construction type and thickness
- Joint width
- Movement requirements
- Rating requirement
- Firestopping materials

113

## Inspection of Perimeter Fire Containment Systems

- ▶ Inspected at rough inspection
- ▶ Does the size of joint fit within the guidelines of the tested assembly?
- ▶ Was the firestopping material installed to minimum depth and installed with the correct overlap onto both the insulation and the concrete floor?

114

## Inspection of Perimeter Fire Containment Systems

- ▶ Floor Assembly
- ▶ Curtain Wall Assembly
- ▶ Safing Materials
- ▶ Attachment methods
- ▶ Sealants
- ▶ Remember compression and orientation of mineral wool

115

## Questions / Discussion



116

## Firestopping is a Headache



- There is no other code-required work anywhere in construction that is installed by every trade.

- No single trade takes ownership for firestop.

- Many trades consider firestopping a *necessary evil*, rather than a critical element of the fire-safety envelope.

117

## FIRESTOP INSTALLATION

- All Trades – “Person who pokes hole, fills hole”
- Multiple Contracts - To Firestop Contractors or Subs
- Single Source Firestop Contractor

118

## FM 4991 Approved or UL Qualified Contractor

- Programs that certify a company has the knowledge and quality control procedures to properly install firestopping
  - Min. 2 years in firestop installation business
  - Designated Responsible Individual (DRI) is formally tested by FM or UL at regular intervals
  - Documented and archived record keeping system for all installations
  - Must have an approved Quality Control Manual
    - Firestop Systems and Assemblies
    - Training

119

## Questions / Discussion



120

## Significant Firestopping Code Changes



121

## 2015 IBC Continuity Head-of-Wall Joints

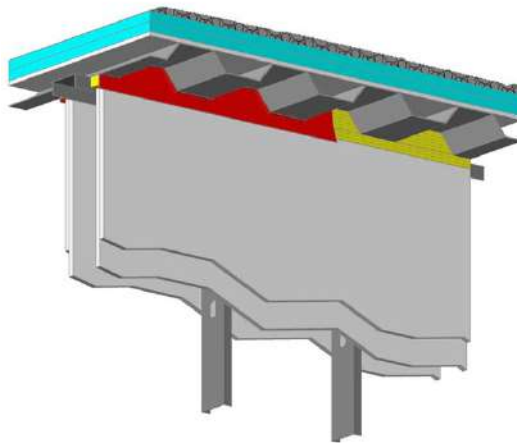

122

## 2015 IBC Requirement

- ▶ 707.9 – The voids created at the intersection of a fire barrier and a non-fire resistance rated roof assembly shall be filled. An approved material or system shall be used to fill the void, shall be securely installed in or on the intersection for its entire length so as not to dislodge, loosen or.....

123

## Barrier Identification

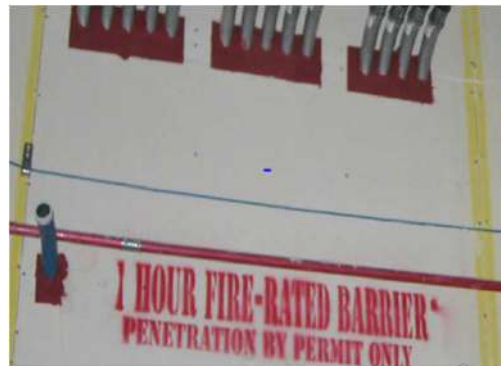

124

## IBC 2009/2012 Code Changes

Such Identification shall be located in accessible concealed floor, floor ceiling or attic spaces.

- ▶ Within 15 feet (4572 mm) of the end of each wall and at intervals not exceeding 30 feet (9144 mm) measured horizontally along the wall or partition
- ▶ Include lettering not less than 3 inches (76 mm) in height with a minimum 3/8 inch (9.5 mm) stroke in a contrasting color incorporating the suggested wording:  
FIRE AND/OR SMOKE BARRIER—PROTECT ALL OPENINGS

125

## International Fire Code (IFC) Inspection and Maintenance of buildings

- **703.1 Maintenance.** The required fire-resistance rating of fire-resistance-rated construction (including walls, firestops, shaft enclosures, partitions, smoke barriers, floors, fire-resistive coatings and sprayed fire-resistant materials applied to structural members and fire-resistant joint systems) shall be maintained.
- In 2009 IFC added provisions **requiring building owners to annually inspect all fire-resistance-rated construction including firestops and joint systems**

126



## Firestop Special Inspections

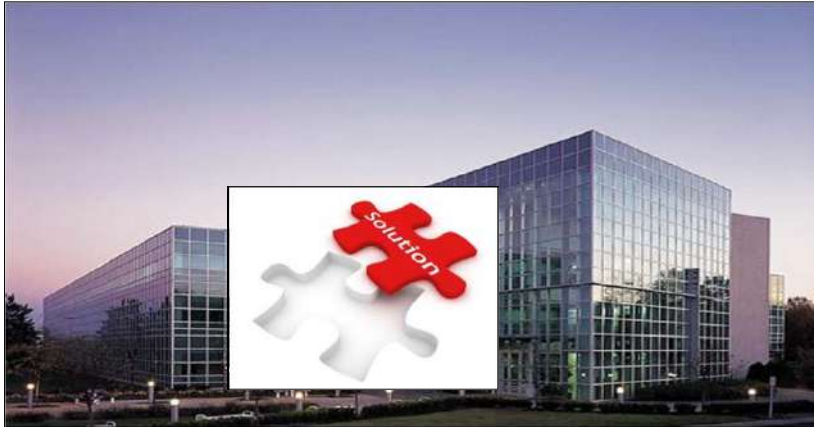

127

## Firestop Special Inspections 2000 & 2009 IBC

- ▶ 1704.15 Special Cases. Special inspections shall be required if in the opinion of the building official the proposed work is unusual in its nature.
- ▶ Also states that special inspections can be required if this work involves materials and systems required to be installed with additional manufacture instructions that prescribe requirements not contained in this code or standards referenced in this code
  - Tested listed systems
  - ASTM Firestop Inspection Standards

128

## Firestopping Special Inspections Approved for 2012 IBC

- ▶ 1705.16 Fire-resistant penetrations and joints. special inspections for through-penetrations, membrane penetration firestops, fire resistant joint systems, and perimeter fire barrier systems that are tested.....
- ▶ Required for buildings over 75 ft. and for Category 3 and 4 buildings
- ▶ ASTM Inspection Standards ASTM E 2174 and ASTM E 2393 are required

129

## SUMMARY OF RISK CATEGORY III BUILDINGS

- ▶ Public assembly over 300 occupants
- ▶ Schools over 250 occupants
- ▶ Prisons and Jails
- ▶ Buildings over 5,000 occupants
- ▶ Water and waste treatment facilities

130

## SUMMARY OF RISK CATEGORY IV BUILDINGS

- ▶ Buildings designed as essential facilities
- ▶ Group I-2 with emergency treatment
- ▶ Fire, rescue and police stations
- ▶ Emergency shelters and operation centers
- ▶ Aviation towers and control centers

131

## Questions / Discussion



132

## ASTM E 2174 Inspection Standards for Penetrations



## ASTM E 2393 Inspection Standards of Joint System and Perimeter Fire Barriers

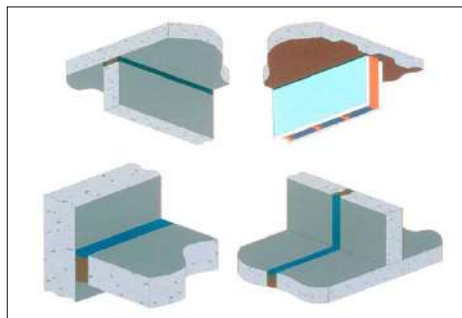

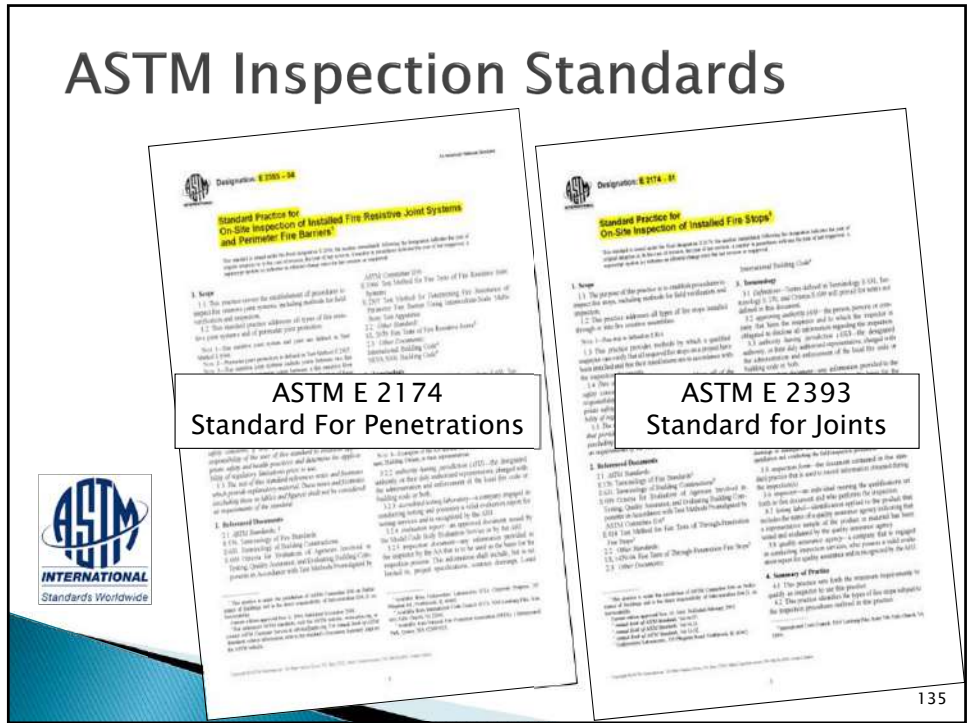

## ASTM Firestop Inspection Standards Overview

- Addresses all types of firestop systems
- Documents must go through a plan review
- Scheduling of firestop inspections
- Covers inspector qualifications
- Provides forms, reports and documents
- Inspection methods are identified

## ASTM Firestop Inspector Qualifications

- Have a minimum of 2 years experience in construction field inspection and have education, credentials, and experience acceptable to the AA. OR
- Be a Quality Assurance Agency accredited by the AHJ. OR
- Meet the criteria contained in ASTM E699 “Standard Practice for Evaluation of Agencies Involved in Testing Quality Assurance, and Evaluating of Building Components”
- **NOTE:** Authorizing Authority (AA) is a designated person charged with administration of the ASTM Inspection Standards. This person could be an architect, Engineer or owner

137

## Conflict of Interest Statement

ASTM E 2174 and 2393

- ❖ 6.2.1 The inspector shall be completely independent of, and divested from, the installer, contractor, manufacturer, or supplier of any material being inspected
- ❖ 6.2.2 The inspector shall not be a competitor of the installer, contractor, manufacture, or supplier of any material being inspected
- ❖ 6.3 The inspector shall submit notarized statements to the AA assuring compliance with 6.2

## ASTM E 2174 and 2393

### General Requirements

- Inspection documents submitted 10 days prior to field inspection
- Installer and inspector must agree upon schedule
- If mechanical systems are used they need to be inspected after installation
- Inspector **shall** provide visual and/or destructive testing for a percentage of the systems
- Must observe all firestop systems



139

## ASTM Inspection Schedule

- ▶ The inspector and installer(s) shall mutually agree upon a schedule for the notification of the following:
  - Start of installation of fire resistive joint systems,
  - Anticipated schedule of inspection(s) and
  - Anticipated completion of inspection(s).
  - The installer shall notify the inspector within one working day when any item agreed to on the schedule must be changed

140

## ASTM E 2174 and 2393 Inspection Documents

- ▶ The AA shall provide the inspector with a complete set of inspection documents at least ten working days prior to the inspection. The inspector shall review all inspection documents prior to conducting any inspection.
- ▶ As part of the inspection documents, Listed Designs shall be provided for every fire resistive joint system.

141

## ASTM E 2174 and ASTM E 2393 Reporting/Inspection Forms

- Inspection Date
- Inspectors Name
- Project
- Reference No.
- Firestop type per Inspection
- Quantity of Firestop type on Project
- Quantity Inspected (the day of Inspection)
- Total Quantity Inspected to Date
- Locations of Inspected Firestop
- Deficiency (if non-compliant )

142



## ASTM E 2174 and ASTM E 2393 Reporting/Inspection

- The Standards calls for the Inspector to verify that the materials bear a Listing Label
- Manufacturer's container labels shall include
  - Manufacturer's name
  - Product name
  - Manufactured Date or Expiration Date
- Where the material is being stored, does it comply with Manufacturer guidelines

143

## ASTM E 2174 and ASTM E 2393 Reporting/Inspection

- The Inspector shall advise the contractor of any deficiencies found within one working day.
- If deficient the standards will require a Percent of additional systems to be inspected
- After the Non-compliance Report is issued the contractor will repair the deficiencies and QC their work, then call for a Re-Inspection



144

## ASTM E 2174 and ASTM E 2393 Final Report

- Report should contain:
  - Cover Page
  - Name and Address of Inspector
  - Name and Address of each firestop Installer, as well as the prime contractor
  - Name and Address of the AA
  - Name and Address of the AHJ
  - Executive Summary outlining verification method used to ascertain compliance
  - Notarized written statement of Conflict of Interest
  - Summary of contain percentages of deficiencies
  - All daily inspection reports

145

## ASTM Inspection

- 10.12.2.1 The method shall be approved by the AA and the AHJ, which shall require one of the following methods:
  - 1) Destructive type
  - 2) Disassembly or
  - 3) Visual inspection
  - 4) Other appropriate methods
- 10.14 All observed deficiencies shall be documented and marked on the inspection forms.

146

## ASTM E 2174

- **Onsite Inspection of Installed Firestop Penetrations**
  - 2 Different type of inspections
    - ❖ Visual Inspection: randomly witnessing a minimum of 10% of each type of firestop installed *OR*
    - ❖ Destruction Testing: destructively sampling 2% of like firestop systems within a 10,000 sq ft. area or less
    - ❖ Can not interfere or direct installation



147

## ASTM E 2393

### **On-site Inspection of Installed Fire Resistive Joint Systems and Perimeter Fire Barriers**

- 2 Different Type of Inspection
  - ❖ Visual Inspection: observing installation process of a minimum of 5% of the total lineal ft. *OR*
  - ❖ Destructive Inspection: destructively sampling a minimum of one sample per type of joint system per 500 lineal ft.
  - ❖ Can not interfere or direct installation

148

## Questions / Discussion



149

## Special Inspections Chapter 17



## Independence 1703.1.1

- ▶ An *approved agency* shall be *objective, competent and independent from* the contractor responsible for the work being inspected.
- ▶ The agency shall also disclose possible *conflicts of interest* so that objectivity can be confirmed.

## Report requirement 1704.2.4

- ▶ Special inspectors shall *keep records of inspections*. The special inspector shall furnish inspection reports to the *building official*, and to the registered *design professional* in responsible charge
- ▶ Reports shall indicate that work inspected *was or was not completed in conformance to approved construction documents*.

## Approved Agency 1703.1

- ▶ An approved agency shall provide all information as necessary for the building official to determine that the agency meets the applicable requirements.

## Is there a Firestop Inspector Certification?

- ▶ ICC Firestop Inspector Certification which is *on hold*
- ▶ International Accreditation Service (IAC) AC 291 Which is for the *firestop company*
- ▶ **Firestop Inspector Certification/Qualification With the IFC and Intertek**
  - International Firestop Council (IFC) ([www.firestop.org](http://www.firestop.org))
  - Intertek IQP Program



## Questions / Discussion



155

## General Discussion of Visual and Destructive Firestop Inspections



156

## Firestop Inspection Recommendations

- ▶ Per Construction Firestop Meeting with all Trade firestop installers to make sure the inspection process works properly.
- ▶ Have clearly marked set of drawings highlighting fire and smoke walls along with approved firestop submittals
- ▶ Consider requiring fill material and annular space inspection before sealant inspection.

157

## Fill Material Inspection



158



## Sealant Inspection

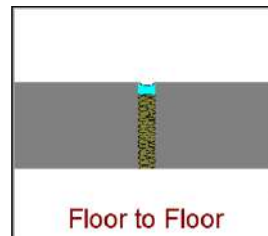
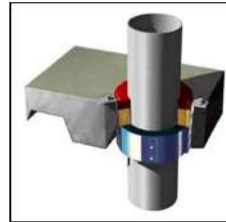

159

## Visual Inspection of Joint Systems



Fire-rated barrier  
(both sides of joint)

Joint width  
(depends on 'movement zone')

Firestop product  
(depth, how to identify?)

Movement specification  
(dynamic, % of joint width)

ASTM E2393: Randomly witness installation of min 5% of total lin ft each type of joint systems or one post installation destructive sampling per 500 lin ft of each type of joint system (mechanical joint systems – no post installation inspection)

160

## Firestop Joint Inspections

- ▶ Is the nominal joint width installed per the listing?
- ▶ Does the joint width fall within the system limits? (Compression and/or Extension)
- ▶ Is backing material required by the system?
- ▶ Is the backing compression ratio correct?
- ▶ Does the sealant depth match the system requirements?

161

There are systems that can be installed at one time. How do we inspect these systems

Floors and decks



Walls



Special Conditions



162

## Visual inspection of Head of wall Joints

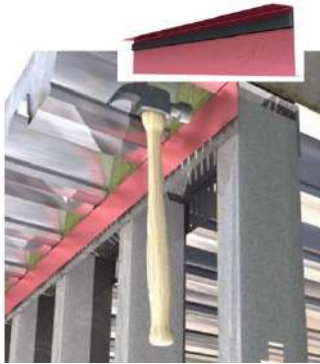

## Questions / Discussion



164

## Recommended Firestop Inspection Tips & Techniques



165

## Firestop Destructive Testing Inspection Techniques

- ▶ Need to measure at multiple locations
- ▶ Measure sealant depth at all points of adhesion
- ▶ Have contractor repair firestop system after inspection



## Firestop Destructive Testing Inspection Techniques Joints

- ▶ For coatings applied in joint systems need to take measurements within 6 to 12 inch for every 500 lineal feet

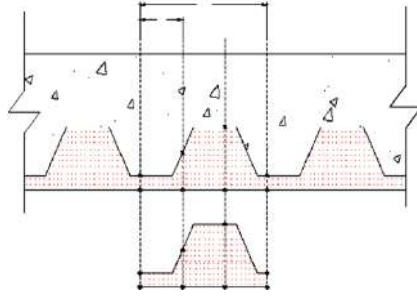

167





## Inspection of Mechanical Joint

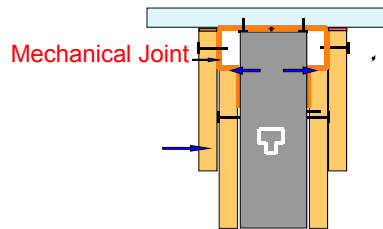

## Wall to Wall Inspections

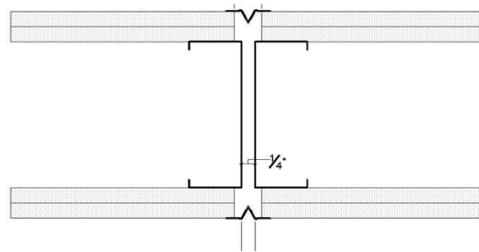

## Firestop Destructive Testing Inspection Issues

- ▶ Pre-formed firestop devices (Collars)
- ▶ Movement during Cure and the life of the building
- ▶ Mechanical Joints
- ▶ Aging of firestop material
- ▶ Painting firestop material
- ▶ Firestop sealant shrinkage
  - Wet sealant depth
  - Dry sealant depth

173

## Firestop Inspection Practices



174



## Firestop Inspection Practices Pre-Construction Meeting

- Review Design Drawings Submittals
- Obtain Pre-Approved Engineering Judgments
- Establish inspection guidelines and expectations
- Review qualifications/experience of firestop installers
- Schedule firestop Inspections with the firestop contractor if possible



175

## Firestop Inspection Practices

- ▶ Inspections typically done by AHJ, but *may be inspected by approved agency or individual (Firestop Special Inspector)*
- ▶ Require construction documents that detail all firestop locations and systems
- ▶ During framing inspection observe that joints are installed in manner that required movement can be achieved

176

## Firestop Inspection Practices

### MOCKUP'S CONSTRUCTED IN THE FIELD

- ▶ Mockup's are not required by code; however, it is highly recommended
- ▶ Prior to installing firestop systems it is recommended to erect mockups for each different firestop system
- ▶ The AHJ's should approve the mockups before start of firestop installation.
- ▶ Mockups should be retained and maintained during construction.



## Firestop Inspection Practices

- ▶ Verify who did installation of systems to determine reasonable verification
- ▶ Observe the products, empty containers or boxes for label with name, description and approved testing agency
- ▶ General Contractor should understand that you may require a ladder or lift
- ▶ Have your inspection tools such as a flashlight, coring device, wire, drill bit, tape measure, digital calipers, camera and other appropri



### Firestop Tools



179

### Firestop Tools Cont.



180

## Questions / Discussion



181

## Building and Fire Department Firestop Guidelines for Plan Review



182

## PROCESS

### Building Department Submittals



- ▶ 107.1.1 – Construction documents shall be of sufficient clarity to indicate the location, nature and extent of the work proposed and show in detail that it will conform to the provisions of this code

183

## PROCESS

### Plans Examination/Review

- ▶ Firestop systems details should be included on the plans and specifications (Project Documents)
- ▶ Recommended to have all firestop Details reproduced on the plans
- ▶ Who should select firestop systems?
  - Design Professional
  - Firestop Contractor
  - Manufacturer
  - AHJ

184

**PROCESS**

**Plans Examination/Review Cont.**

- ▶ For unique conditions have policy for Engineering Judgments
- ▶ Consider requiring 3<sup>rd</sup> party firestop inspectors for the large projects
- ▶ The structural engineer should provide the amount of movement required for all joints before the framing inspection

185

**PROCESS**

**Plans Examination/Review Cont.**

- ▶ All firestop systems for fire rated construction need to be reproduced on the plans as tested by an approved testing laboratory.
- ▶ Schedule of tested and listed systems by assembly, penetration or joint
  - Show system details with location of the firestopping
  - Review systems that may need engineering judgments

186

## Questions / Discussion



187



**This is what code calls for...**



## Firestopping in the Real World

- ▶ Firestop system details are hardly ever on plans
- ▶ Firestopping is not included in Plan Check Submittal checklist
- ▶ Building departments generally do not have the resources to provide visual inspections according to standards
- ▶ Code officials are not accustomed to providing destructive testing according to the standards



190



## Firestopping in the Real World Cont.

- ▶ Code Officials generally do not ask for copies of Tested and Listed firestop systems
- ▶ Tested/Listed systems rarely installed correctly
- ▶ Joints are generally not inspected during the framing inspection and installed to provide movement
- ▶ Engineering judgments are being used when there are tested and listed systems available
- ▶ Most users are untrained



191

## Question for your Building Official

- ▶ **What is our Building Department's Plan Review and Building Inspection Policy and Procedure for Firestopping?**

192

## OPTIONS FOR AHJ TO CONSIDER IF CHANGE FIRESTOP POLICY AND PROCEDURE

- Firestopping level of enforcement for your staff
  - Will provide all firestop enforcement
  - According to 2015 IBC firestop special inspections
  - *Large projects provided by 3<sup>rd</sup> party and other projects by staff*
  - 3<sup>rd</sup> party will provide all firestop enforcement



193

## Questions / Discussion



194

# Firestop Joint Systems Tales From The Field

195

## Improper Firestop Installations



196

## Inspection of Mechanical Joint

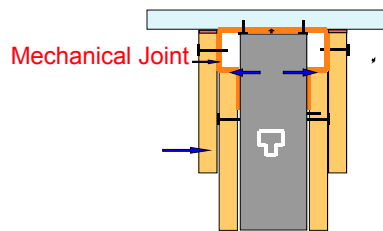

## Improper Firestop Installations



## Improper Firestop Installations



199

## Correct Firestop Installations



200

## Correct Firestop Installations



201

## Correct Firestop Installations



202

## Correct Firestop Installations



203

## Visual Inspection Quiz What's wrong with this install?



204

## Questions / Discussion



205

## Final Points!



206



## Available Resources General

- ▶ International Firestop Council (IFC)  
[www.firestop.org](http://www.firestop.org)
- ▶ Firesafe North America  
[www.firesafenorthamerica.org](http://www.firesafenorthamerica.org)
- ▶ Firestop Contractors International Association  
[www.fcia.org](http://www.fcia.org)
- ▶ ASTM International standards  
[www.astm.org](http://www.astm.org)

207

## Reference Materials

- ▶ ASTM E 2174 & ASTM E 2393 “Standard Practice for On-Site Inspection of Installed Fire Stops”
- ▶ **UL-IFC Video** “CLOSE ENOUGH IS NOT GOOD ENOUGH”: (YouTube: UL and IFC Video)
- ▶ ICC/IFC Pocket Guide for Inspectors
- ▶ ICC Firestop and Damper book by Jay Woodward.



208

## Questions / Discussion



209

## THANK YOU

Brice Miller  
Fire Containment Training Services  
Fort Collins Colorado  
Phone; 970-223-4985  
Email: [brice@FireContainmentTraining.com](mailto:brice@FireContainmentTraining.com)  
[www.FireContainmentTraining.com](http://www.FireContainmentTraining.com)  
*FCTS APPRECIATES THE OPPORTUNITY*



210