

Technical

The Technical Reference section includes articles covering regulator theory, sizing, selection, overpressure protection, noise, freezing, and other topics relating to regulators. This section begins with the basic theory of a regulator and ends with conversion tables and other informative charts. If there's something you need to know about a regulator that's not covered in this section, please contact your Fisher Sales Representative or contact your nearest Fisher Sales Office.

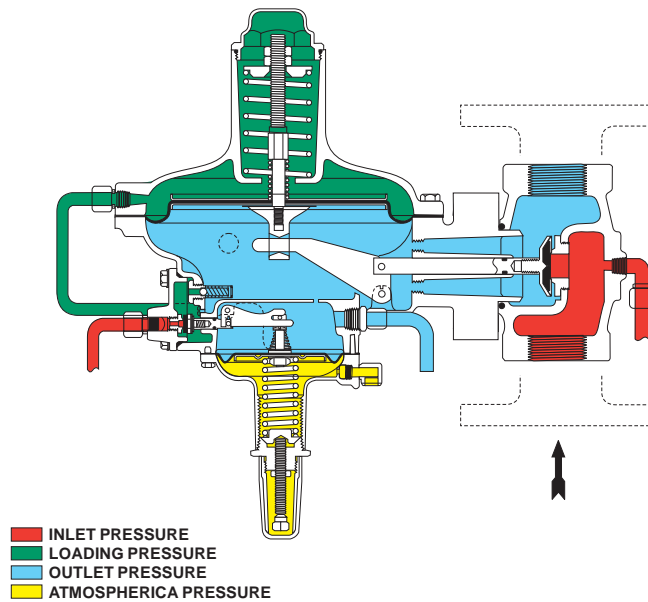

Table of Contents

REGULATOR COMPONENTS

Straight Stem Style Direct-Operated K-2
 Lever Style Direct-Operated K-3
 Loading Style (Two-Path Control) Pilot-Operated K-4
 Unloading Style Pilot-Operated K-5

INTRODUCTION TO REGULATORS

Introduction K-6
 Types of Regulators K-6
 Direct-Operated (Self-Operated) Regulators K-6
 Pilot-Operated Regulators K-6
 Specific Regulator Types K-6
 Pressure Reducing Regulators K-7
 Backpressure Regulators and Relief Valves K-7
 Pressure Switching Valves K-7
 Vacuum Regulators and Breakers K-7
 Pressure Reducing Regulator Selection K-8
 Backpressure Regulator Selection K-10
 Relief Valve Selection K-10

PRINCIPLES OF DIRECT-OPERATED REGULATORS

Introduction K-11
 Regulator Basics K-11
 Essential Elements K-11
 Restricting Element K-12
 Measuring Element K-12
 Loading Element K-12
 Regulator Operation K-12
 Increasing Demand K-12
 Decreasing Demand K-12
 Weights versus Springs K-12
 Spring Rate K-13
 Equilibrium with a Spring K-13
 Spring as Loading Element K-13
 Throttling Example K-13
 Regulator Operation and P_2 K-14
 Regulator Performance K-14
 Setpoint K-14
 Droop K-14
 Capacity K-14
 Accuracy K-14
 Lockup K-14

Spring Rate and Regulator Accuracy K-15
 Spring Rate and Droop K-15
 Effect on Plug Travel K-15
 Light Spring Rate K-15
 Diaphragm Area and Regulator Accuracy K-15
 Restricting Element and Regulator Performance K-16
 Critical Flow K-16
 Orifice Size and Capacity K-16
 Orifice Size and Stability K-17
 Orifice Size, Lockup, and Wear K-17
 Orifice Guideline K-17
 Increasing P_1 K-17
 Factors Affecting Regulator Accuracy K-17
 Performance Limits K-17
 Cycling K-17
 Design Variations K-17
 Improving Regulator Accuracy with a Pitot Tube K-17
 Decreased Droop (Boost) K-18
 Improving Performance with a Lever K-18

PRINCIPLES OF PILOT-OPERATED REGULATORS

Pilot-Operated Regulator Basics K-19
 Regulator Pilots K-19
 Gain K-19
 Identifying Pilots K-19
 Setpoint K-19
 Spring Action K-19
 Pilot Advantage K-19
 Gain and Restrictions K-19
 Stability K-19
 Restrictions, Response Time, and Gain K-20
 Loading and Unloading Designs K-20
 Two-Path Control (Loading Design) K-20
 Two-Path Control Advantages K-20
 Unloading Control K-21
 Unloading Control Advantages K-21
 Performance Summary K-21
 Accuracy K-21
 Capacity K-21
 Lockup K-21
 Applications K-21
 Two-Path Control K-21
 Unloading Design K-23

Table of Contents

SELECTING AND SIZING PRESSURE REDUCING REGULATORS

Introduction	K-24
The Fisher Regulator Handbook	K-24
Special Requirements	K-24
The Role of Experience	K-24
Sizing Equations	K-24
General Sizing Guidelines	K-25
Body Size	K-25
Construction	K-25
Pressure Ratings	K-25
Wide-Open Flow Rate	K-25
Outlet Pressure Ranges and Springs	K-25
Accuracy	K-25
Inlet Pressure Losses	K-25
Orifice Diameter	K-25
Speed of Response	K-25
Turn-Down Ratio	K-25
Sizing Exercises	K-25
Problem 1: Industrial Plant Gas Supply	K-26
Problem 2: Steam Space Heater	K-26
Problem 3: High Pressure Water Supply	K-27
Problem 4: Corrosive Gas	K-28

OVERPRESSURE PROTECTION METHODS

Methods of Overpressure Protection	K-29
Relief Valves	K-29
Monitoring Regulators	K-30
Working Monitor	K-30
Series Regulation	K-30
Shutoff Devices	K-31
Relief Monitor	K-31
Summary	K-32

PRINCIPLES OF RELIEF VALVES

Overpressure Protection	K-33
Maximum Pressure Considerations	K-33
Downstream Equipment	K-33
Main Regulator	K-33
Piping	K-33
Relief Valves	K-33
Selection Criteria	K-34
Pressure Buildup	K-34
Periodic Maintenance	K-34

Cost versus Performance	K-34
Installation and Maintenance Considerations	K-34
Pop Type Relief Valve	K-34
Operation	K-34
Typical Applications	K-35
Direct-Operated Relief Valves	K-35
Operation	K-35
Product Example	K-36
Pitot Tube	K-36
Typical Applications	K-36
Pilot-Operated Relief Valves	K-36
Operation	K-37
Product Example	K-37
Performance	K-37
Typical Applications	K-37
Internal Relief	K-38
Operation	K-38
Product Example	K-38
Performance and Typical Applications	K-38
Selection and Sizing Criteria	K-39
Maximum Allowable Pressure	K-39
Regulator Ratings	K-39
Piping	K-39
Maximum Allowable System Pressure	K-39
Determining Required Relief Valve Flow	K-39
Determine Constant Demand	K-39
Selecting Relief Valves	K-40
Regulator Lockup Pressure	K-40
Applicable Regulations	K-40
Sizing and Selection Exercise	K-40

PRINCIPLES OF SERIES REGULATION AND MONITOR REGULATORS

Series Regulation	K-42
Upstream Wide-Open Monitors	K-42
Downstream Wide-Open Monitors	K-43
Upstream Versus Downstream Monitors	K-43
Working Monitors	K-43
Sizing Monitor Regulators	K-44

VALVE SIZING CALCULATIONS

Introduction	K-45
Sizing for Liquid Service	K-45
Viscosity Corrections	K-45

Table of Contents

Predicting Flow Rate K-47
 Predicting Pressure Drop K-47
 Flashing and Cavitation K-47
 Choked Flow K-48
 Sizing for Gas or Steam Service K-51
 Universal Gas Sizing Equation K-51
 General Adaptation for Steam and Vapors K-52
 Equation Form for Steam Below 1000 psig K-52

VACUUM CONTROL

Vacuum Applications K-54
 Vacuum Terminology K-54
 Vacuum Control Devices K-54
 Vacuum Regulators K-54
 Vacuum Breakers (Relief Valves) K-55
 Vacuum Regulator Installation Examples K-56
 Vacuum Breaker Installation Examples K-57
 Gas Blanketing in Vacuum K-59
 Features of Fisher’s Vacuum Regulators and Breakers K-59

FREEZING

Introduction K-60
 Reducing Freezing Problems K-60
 Heat the Gas K-60
 Antifreeze Solution K-60
 Equipment Selection K-61
 System Design K-61
 Water Removal K-61
 Summary K-61

CHEMICAL COMPATIBILITY OF ELASTOMERS AND METALS

Introduction K-62
 Elastomers: Chemical Names and Uses K-62
 General Properties of Elastomers K-63
 Fluid Compatibility of Elastomers K-64
 Compatibility of Metals K-65

SULFIDE STRESS CRACKING—NACE MR0175

Introduction K-67
 The Basics of Sulfide Stress Cracking K-68
 Carbon Steel K-69
 Cast Iron K-69

Stainless Steel K-69
 Nonferrous Alloys K-70
 Springs K-70
 Coatings K-70
 Stress Relieving K-70
 Bolting K-70
 Composition Materials K-70
 Codes and Standards K-71

COLD TEMPERATURE CONSIDERATIONS

Regulators Rated for Low Temperatures K-73
 Selection Criteria K-73
 Low Temperature Fisher Regulators K-73

POWDER PAINT COATING

Introduction K-74
 Economic Advantages K-74
 Environmental Advantages K-74
 Mechanical Properties K-75
 Corrosion Resistance K-75

REGULATOR TIPS

Regulator Tips K-76

CONVERSIONS, EQUIVALENTS, AND USEFUL INFORMATION

Pressure Equivalents K-78
 Pressure Conversion - Pounds per Square Inch
 (Psi) to Bar K-78
 Volume Equivalents K-78
 Volume Rate Equivalents K-79
 Mass Conversion—Pounds to Kilograms K-79
 Temperature Conversion Formulas K-79
 Area Equivalents K-79
 Kinematic-Viscosity Conversion Formulas K-79
 Conversion Units K-80
 Other Useful Conversions K-80
 Converting Volumes of Gas K-80
 Fractional Inches to Millimeters K-81
 Length Equivalents K-81
 Whole Inch-Millimeter Equivalents K-81
 Metric Prefixes and Symbols K-81
 Greek Alphabet K-81

Table of Contents

Length Equivalents - Fractional and Decimal		Vapor Pressures of Propane	K-107
Inches to Millimeters	K-82	Converting Volumes of Gas	K-107
Temperature Conversions	K-83	BTU Comparisons	K-107
A.P.I. and Baumé Gravity Tables and Weight Factors . .	K-86	Capacities of Spuds and Orifices	K-108
Characteristics of the Elements	K-87	Kinematic Viscosity - Centistokes	K-111
Recommended Standard Specifications for Valve		Specific Gravity of Typical Fluids vs.	
Materials Pressure-Containing Castings	K-88	Temperature	K-112
Physical Constants of Hydrocarbons	K-91	Effect of Inlet Swage On Critical Flow	
Physical Constants of Various Fluids	K-92	C _g Requirements	K-113
Properties of Water	K-94	ANSI Face-To-Face Dimensions for	
Properties of Saturated Steam	K-94	Flanged Regulators	K-114
Properties of Saturated Steam—Metric Units	K-97	Seat Leakage Classifications	K-114
Properties of Superheated Steam	K-98	Class VI Seat Leakage Allowable	K-114
Determine Velocity of Steam in Pipes	K-101	Pressure-Temperature Ratings for Valve Bodies	K-115
Recommended Steam Pipe Line Velocities	K-101	Diameter of Bolt Circles	K-116
Typical Condensation Rates in Insulated Pipes	K-101	Wear and Galling Resistance Chart of Material	
Typical Condensation Rates without Insulation	K-101	Combinations	K-117
Flow of Water Through Schedule 40 Steel Pipes	K-102	Equivalent Lengths of Pipe Fittings and Valves	K-117
Flow of Air Through Schedule 40 Steel Pipes	K-104	Pipe Data: Carbon and Alloy Steel—Stainless Steel . .	K-118
Average Properties of Propane	K-106	American Pipe Flange Dimensions	K-120
Orifice Capacities for Propane	K-106	DIN Cast Steel Flange Standards	K-120
Standard Domestic Propane Tank Specifications	K-106	DIN Standards - DIN Cast Steel Valve Ratings	K-121
Approximate Vaporization Capacities of		Drill Sizes for Pipe Taps	K-122
Propane Tanks	K-106	Standard Twist Drill Sizes	K-122
Pipe and Tubing Sizing	K-107		

Regulator Components

STRAIGHT STEM STYLE DIRECT-OPERATED REGULATOR COMPONENTS

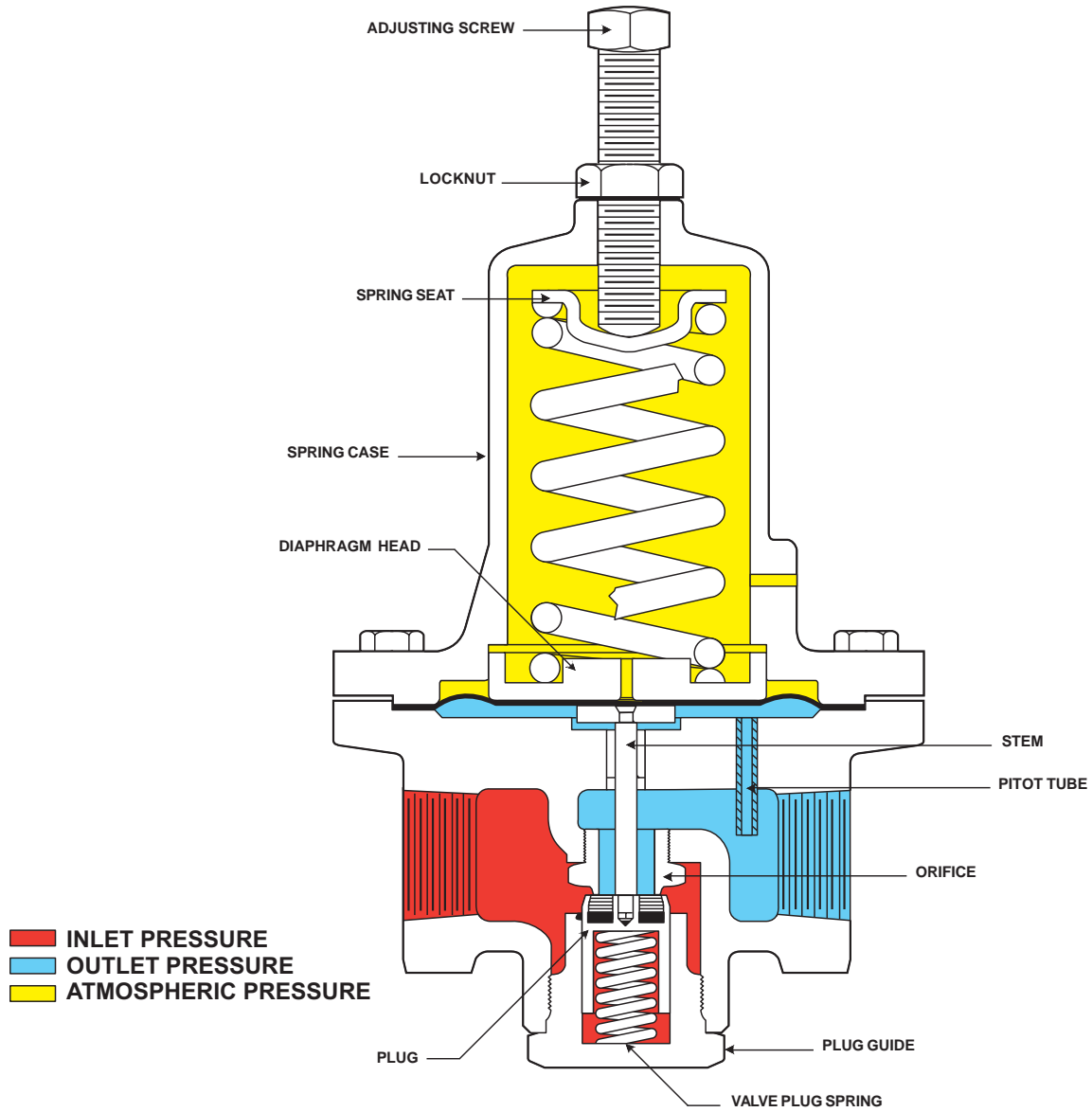

Type 95H

Regulator Components

LEVER STYLE DIRECT-OPERATED REGULATOR COMPONENTS

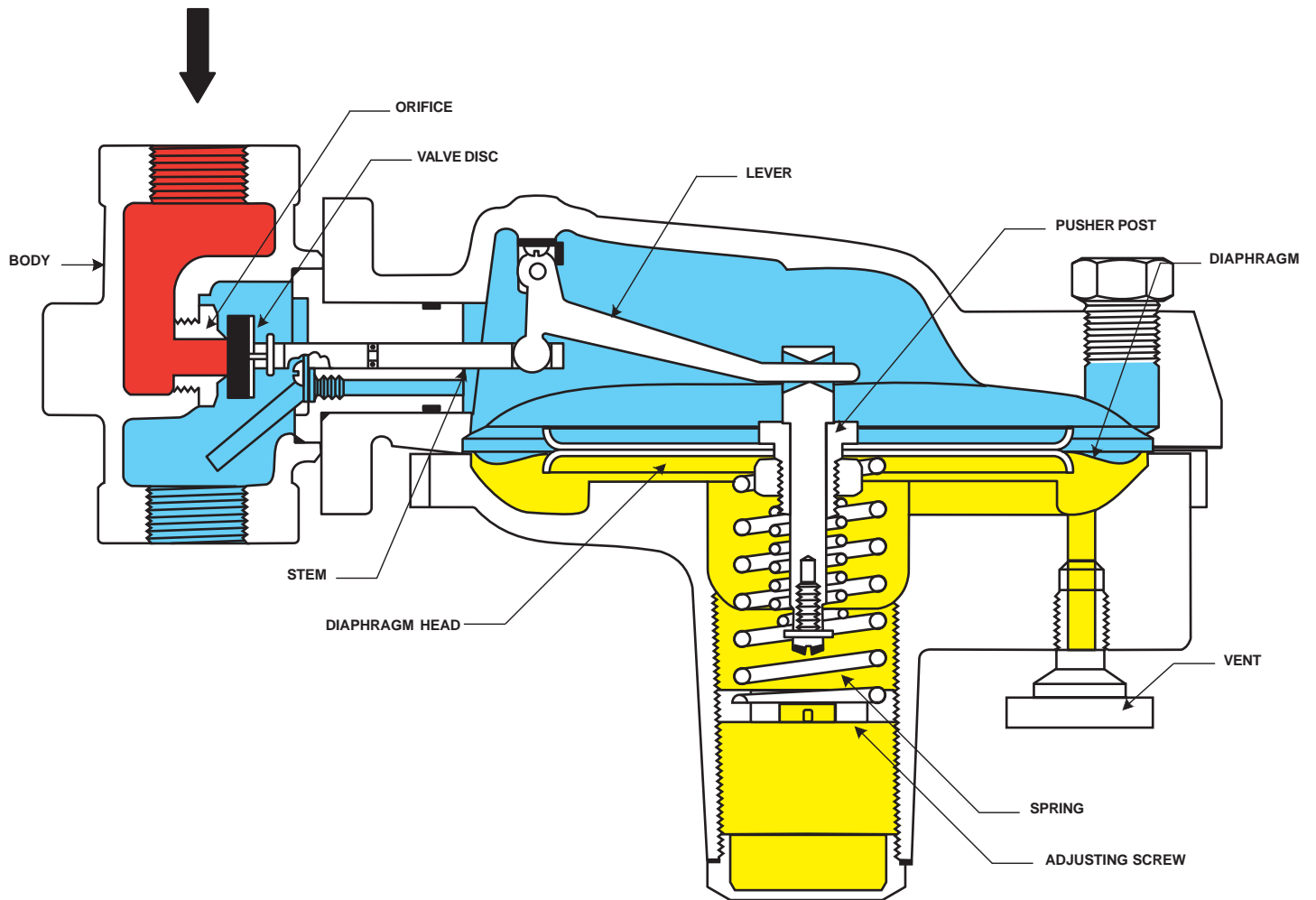

Type Y690A

Regulator Components

LOADING STYLE (TWO-PATH CONTROL) PILOT-OPERATED REGULATOR COMPONENTS

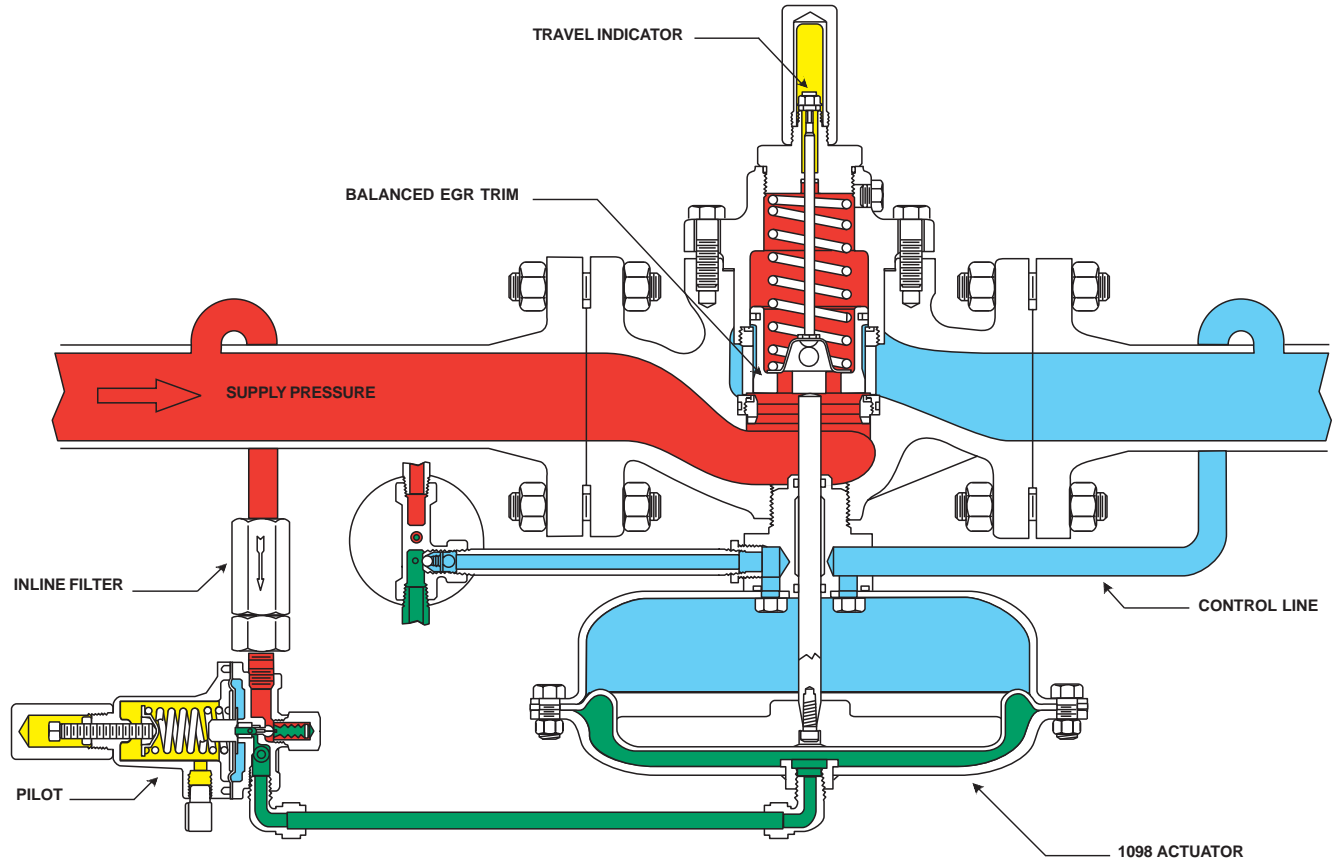

- INLET PRESSURE
- OUTLET PRESSURE
- LOADING PRESSURE
- ATMOSPHERIC PRESSURE

Type 1098-EGR

Regulator Components

UNLOADING STYLE PILOT-OPERATED REGULATOR COMPONENTS

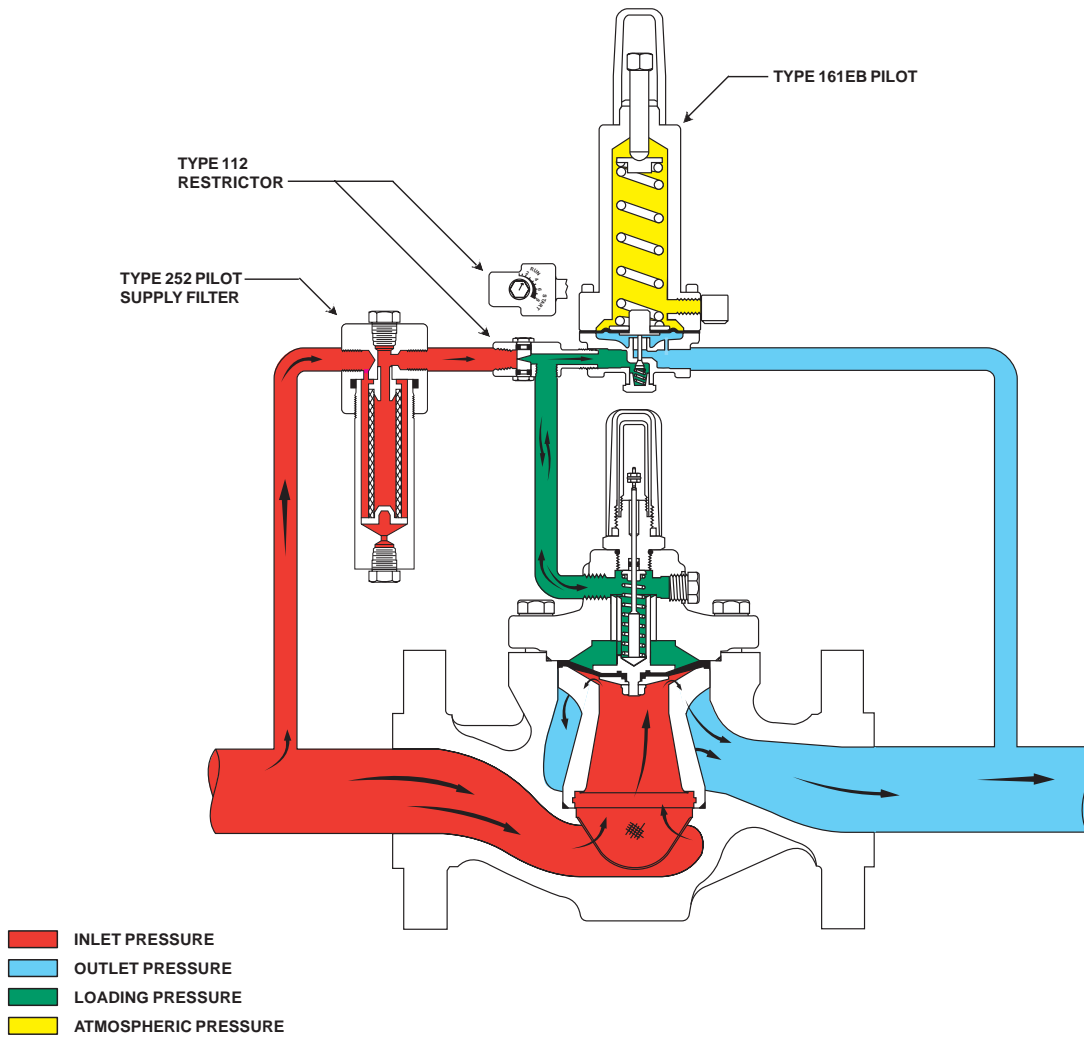

Type EZR

Introduction to Regulators

INTRODUCTION

Instrument engineers agree that the simpler a system is the better it is, as long as it provides adequate control. In general, regulators are simpler devices than control valves. Regulators are self-contained, self-operated control devices which use energy from the controlled system to operate whereas control valves require external power sources, transmitting instruments, and control instruments.

TYPES OF REGULATORS

This section describes the various types of regulators. All regulators fit into one of the following two categories:

1. Direct-Operated (also called Self-Operated)
2. Pilot-Operated

Direct-Operated (Self-Operated) Regulators

Direct-operated regulators are widely used where outlet pressure is less than 1 psig (0,069 bar) and as a first-stage rough cut for higher outlet pressures. This 10 to 20 percent change is typical, although finer control can be achieved depending on the specific application requirements.

In operation, a direct-operated, pressure reducing regulator senses the downstream pressure through either internal pressure registration or an external control line. This downstream pressure opposes a spring which moves the diaphragm and valve plug to change the size of the flow path through the regulator.

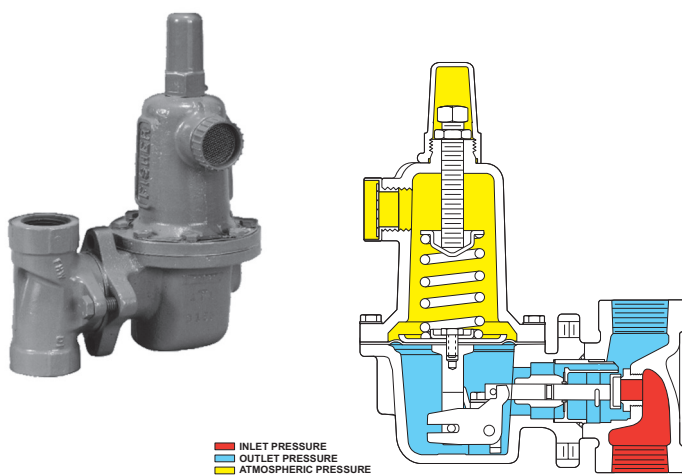

Figure 1. Type 627 Direct-Operated Regulator and Operational Schematic

Pilot-Operated Regulators

Pilot-operated regulators are preferred for high flow rates or where precise pressure control is required. A popular type of pilot-operated system uses two-path control. In two-path control, the main valve diaphragm responds quickly to downstream pressure changes, causing an immediate correction in the main valve plug position. At the same time, the pilot diaphragm diverts some of the reduced inlet pressure to the other side of the main valve diaphragm to control the final positioning of the main valve plug. Two-path control results in fast response.

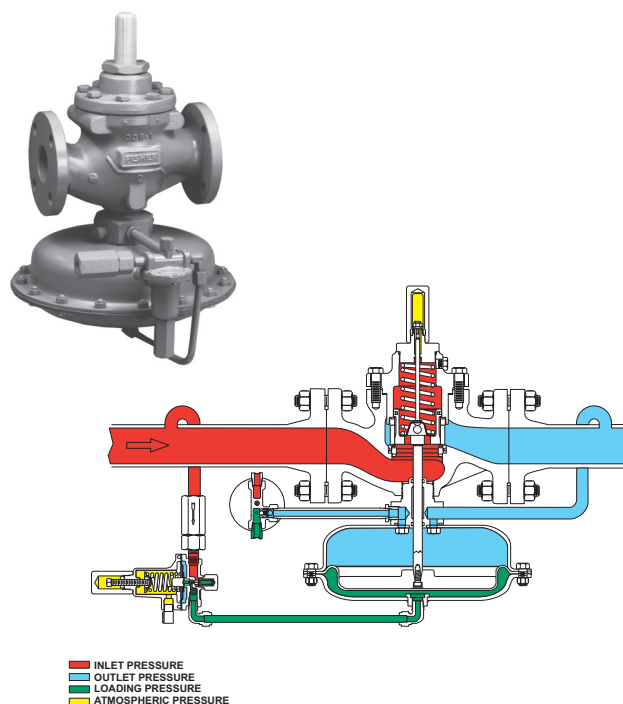

Figure 2. Type 1098-EGR Pilot-Operated Regulator and Operational Schematic

SPECIFIC REGULATOR TYPES

Within the broad categories of direct-operated and pilot-operated regulators fall virtually all of the general regulator designs, including:

- Pressure reducing regulators
- Backpressure regulators
- Pressure relief valves
- Pressure switching regulators
- Vacuum regulators and breakers

Introduction to Regulators

Pressure Reducing Regulators

A pressure reducing regulator maintains a desired reduced outlet pressure while providing the required fluid flow to satisfy a downstream demand. The pressure which the regulator maintains is the outlet pressure setting (setpoint) of the regulator.

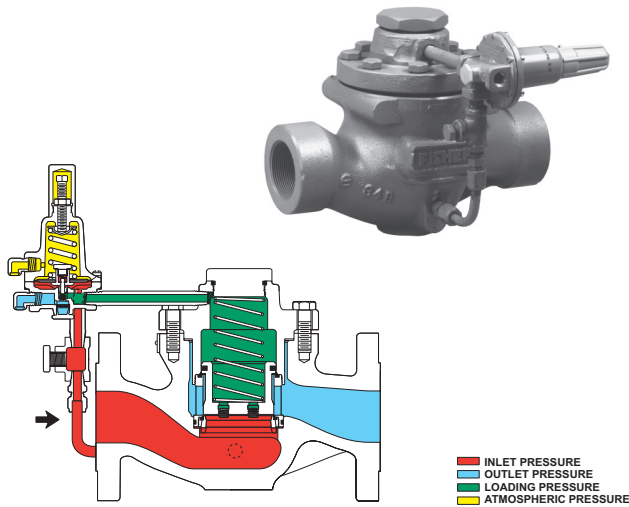

Figure 3. Type 63-EG Backpressure Regulator/Relief Valve and Operational Schematic

Backpressure Regulators and Pressure Relief Valves

A backpressure regulator maintains a desired upstream pressure by varying the flow in response to changes in upstream pressure. A pressure relief valve limits pressure buildup (prevents overpressure) at its location in a pressure system. The relief valve opens to prevent a rise of internal pressure in excess of a specified value. The pressure at which the relief valve begins to open pressure is the relief pressure setting.

Relief valves and backpressure regulators are the same devices. The name is determined by the application. Fisher relief valves are not ASME safety relief valves.

Pressure Switching Valves

Pressure switching valves are used in pneumatic logic systems. These valves are for either two-way or three-way switching. Two way switching valves are used for on/off service in pneumatic systems.

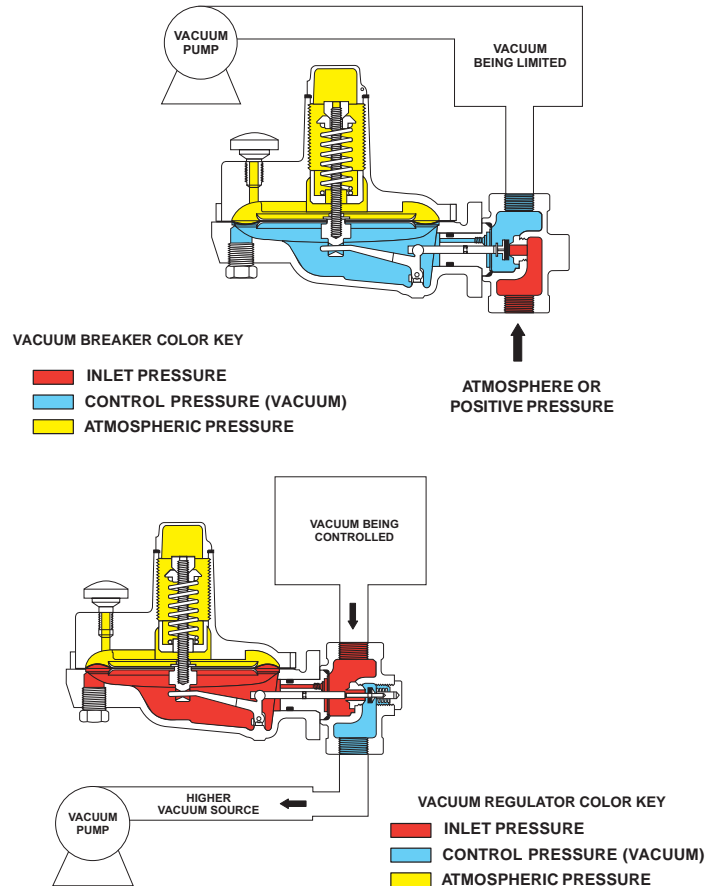

Figure 4. Type Y690VB Vacuum Breaker and Type Y695VR Vacuum Regulator Operational Schematics

Three-way switching valves direct inlet pressure from one outlet port to another whenever the sensed pressure exceeds or drops below a preset limit.

Vacuum Regulators and Breakers

Vacuum regulators and vacuum breakers are devices used to control vacuum. A vacuum regulator maintains a constant vacuum at the regulator inlet with a higher vacuum connected to the outlet. During operation, a vacuum regulator remains closed until a vacuum decrease (a rise in absolute pressure) exceeds the spring setting and opens the valve disk. A vacuum breaker prevents a vacuum from exceeding a specified value. During operation, a vacuum breaker remains closed until an increase in vacuum (a decrease in absolute pressure) exceeds the spring setting and opens the valve disk.

Introduction to Regulators

REGULATOR SELECTION CRITERIA

This section describes the procedure normally used to select regulators for various applications. For most applications, there is generally a wide choice of regulators that will accomplish the required function. The vendor and the customer, working together, have the task of deciding which of the available regulators is best suited for the job at hand. The selection procedure is essentially a process of elimination wherein the answers to a series of questions narrow the choice down to a specific regulator.

Control Application

To begin the selection procedure, it's necessary to define what the regulator is going to do. In other words, what is the control application? The answer to this question will determine the general type of regulator required, such as:

- Pressure reducing regulators
- Backpressure regulators
- Pressure relief valves
- Vacuum regulators
- Vacuum breaker

The selection criteria used in selecting each of these general regulator types is described in greater detail in the following subsections.

PRESSURE REDUCING REGULATOR SELECTION

The majority of applications require a pressure reducing regulator. Assuming the application calls for a pressure reducing regulator, the following parameters must be determined:

- Outlet pressure to be maintained
- Inlet pressure to the regulator
- Capacity required
- Shutoff capability required
- Process fluid
- Process fluid temperature
- Accuracy required
- Pipe size required
- End connection style
- Material requirements
- Control lines
- Stroking speed
- Overpressure protection

Outlet Pressure to be Maintained

For a pressure reducing regulator, the first parameter to determine is the required outlet pressure. When the outlet pressure is known, it helps determine:

- Spring requirements
- Casing pressure rating
- Body outlet rating
- Orifice rating and size
- Regulator size

Inlet Pressure of the Regulator

The next parameter is the inlet pressure. The inlet pressure (minimum and maximum) determines the:

- Pressure rating for the body inlet
- Orifice pressure rating and size
- Main spring (in a pilot-operated regulator)
- Regulator size

If the inlet pressure varies significantly, it can have an effect on:

- Accuracy of the controlled pressure
- Capacity of the regulator
- Regulator style (two-stage or unloading)

Capacity Required

The required flow capacity influences the following decisions:

- Size of the regulator
- Orifice size
- Style of regulator (direct-operated or pilot-operated)

Shutoff Capability

The required shutoff capability determines the type of disk material:

- Standard disk materials are nitrile and neoprene, these materials provide the tightest shutoff.
- Other materials, such as nylon, teflon (TFE), fluoroelastomer (FKM), and ethylenepropylene (EPDM), are used when standard material cannot be used; but, these usually do not shut off as tight.
- Metal disks are used in high temperatures and when elastomers are not compatible with the process fluid; however, tight shutoff is typically not achieved.

Introduction to Regulators

Process Fluid

Each process fluid has its own set of unique characteristics in terms of its chemical composition, corrosive properties, impurities, flammability, hazardous nature, toxic effect, explosive limits, and molecular structure. In some cases special care must be taken to select the proper materials that will come in contact with the process fluid.

Process Fluid Temperature

Fluid temperature may determine the materials used in the regulator. Standard regulators use nitrile or neoprene elastomers that are good for a temperature range of -20° to 180°F (-29° to 82°C). Temperatures above and below this range may require special materials, such as stainless steel, ethylenepropylene (EPDM), or perfluoroelastomer (FFKM).

Accuracy Required

The accuracy requirement of the process determines the acceptable droop (also called proportional band or offset). Regulators fall into the following groups as far as droop is concerned:

- **Rough cut group.** This group generally includes many first-stage rough cut direct-operated regulators. This group usually has the highest amount of droop; however, some designs are very accurate, especially the low-pressure gas or air types, such as house service regulators, which incorporate a relatively large diaphragm casing.
- **Close control group.** This group usually includes pilot-operated regulators. They provide high accuracy over a large range of flows.

Applications that require close control include these examples:

- Burner control where the fuel/air ratio is critical to burner efficiency and the gas pressure has a significant effect on the fuel/air ratio
- Metering devices, such as gas meters, which require constant input pressures to ensure accurate measurement

Pipe Size Required

If the pipe size is known, it gives the specifier of a new regulator a more defined starting point. If, after making an initial selection of a regulator, the regulator is larger than the pipe size, it usually means that an error has been made either in selecting the pipe size or the regulator, or in determining the original parameters (such as pressure or flow) required for regulator selection. In many cases, the outlet piping needs to be larger than the regulator for the regulator to reach full capacity.

End Connection Style

In general, the following end connections are available for the indicated regulator sizes:

- NPT screwed or socket weld: 2-inch (DN 50) and smaller
- Butt weld: 1-inch (DN 25) and larger
- Flanged: 1-inch (DN 25) and larger

Note: Not all end connections are available for all regulators.

Required Materials

The regulator construction materials are generally dictated by the application. Standard materials are:

- Aluminum
- Cast iron or ductile iron
- Steel
- Bronze and brass
- Stainless steel

Special materials required by the process can have an effect on the type of regulator that can be used. Oxygen service, for example, requires special materials, and requires that no oil or grease be in the regulator.

Control Lines

For pressure registration, control lines are connected downstream of a pressure reducing regulator, and upstream of a backpressure regulator. Typically large direct-operated regulators have external control lines, while small direct-operated regulators have internal registration instead of a control line. Most pilot-operated regulators have external control lines, but this should be confirmed for each regulator type considered.

Stroking Speed

Stroking speed is often an important selection criteria. Direct-operated regulators are very fast, while pilot-operated regulators are slightly slower. Both types are faster than most control valves. When speed is critical, techniques can be used to decrease stroking time.

Overpressure Protection

The need for overpressure protection should always be considered. Overpressure protection is generally provided by an external relief valve, or in some regulators, by an internal relief valve. For some regulators,

Introduction to Regulators

internal relief is an option that you must choose at the time of purchase. The capacity of internal relief is usually limited in comparison with a separate relief valve.

Regulator Replacement

When a regulator is being selected to replace an existing regulator, the existing regulator can provide the following information:

- Style of regulator
- Size of regulator
- Type number of the regulator
- Special requirements for the regulator, such as downstream pressure sensing through a control line versus internal pressure registration

Regulator Price

The price of a regulator is only a part of the cost of ownership. Additional costs include installation and maintenance. In selecting a regulator, you should consider all of the costs that will accrue over the life of the regulator. The regulator with a low initial cost may not be the most economical in the long run. For example, a direct-operated regulator is generally less expensive, but a pilot-operated regulator may provide more capacity per dollar. To illustrate, a 2-inch (DN 50) pilot-operated regulator can have the same capacity and a lower price than a 3-inch (DN 80), direct-operated regulator.

BACKPRESSURE REGULATOR SELECTION

Backpressure regulators control the inlet pressure rather than the outlet pressure. The selection criteria for a backpressure regulator is exactly the same as for a pressure reducing regulator.

RELIEF VALVE SELECTION

An external relief valve is a form of backpressure regulator. A relief valve opens when the inlet pressure exceeds a set value. Relief is generally to atmosphere. The selection criteria is the same as for a pressure reducing regulator.

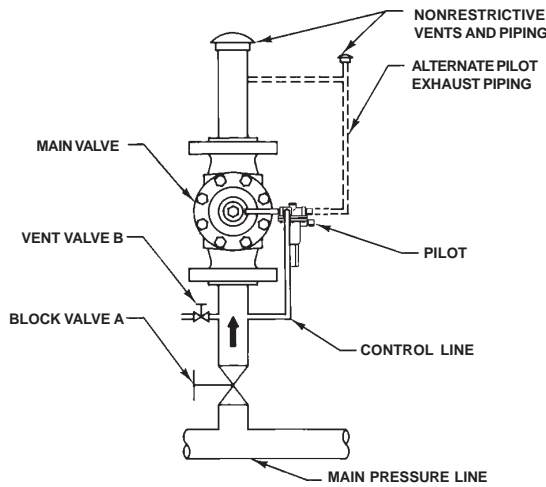

Relief Pressure Control at Relief Valve Inlet

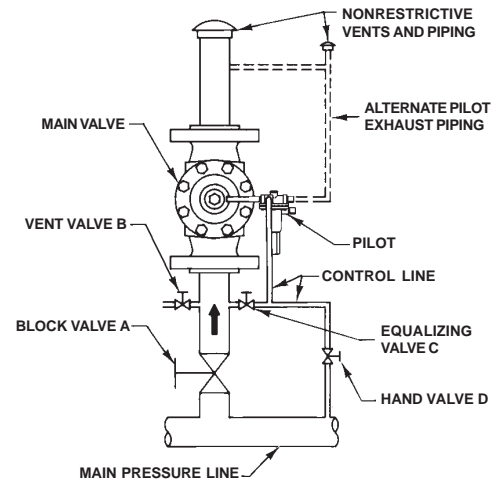

Relief Pressure Control at Main Line

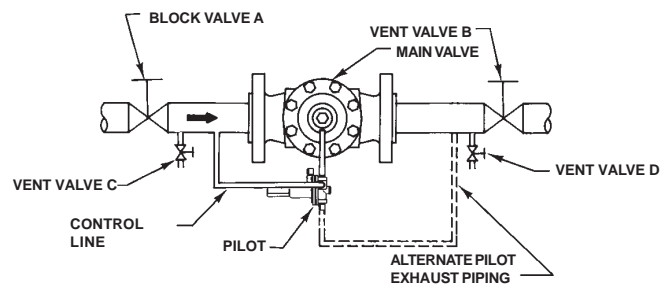

Backpressure Control

Figure 5. Backpressure Regulator/Relief Valve Applications

Principles of Direct-Operated Regulators

INTRODUCTION

Pressure regulators have become very familiar items over the years, and nearly everyone has grown accustomed to seeing them in factories, public buildings, by the roadside, and even on the outside of their own homes. As is frequently the case with such familiar items, we have a tendency to take them for granted. It's only when a problem develops, or when we are selecting a regulator for a new application, that we need to look more deeply into the fundamentals of the regulator's operation.

Regulators provide a means of controlling the flow of a gas or other fluid supply to downstream processes or customers. An ideal regulator would supply downstream demand while keeping downstream pressure constant; however, the mechanics of direct-operated regulator construction are such that there will always be some deviation (droop or offset) in downstream pressure.

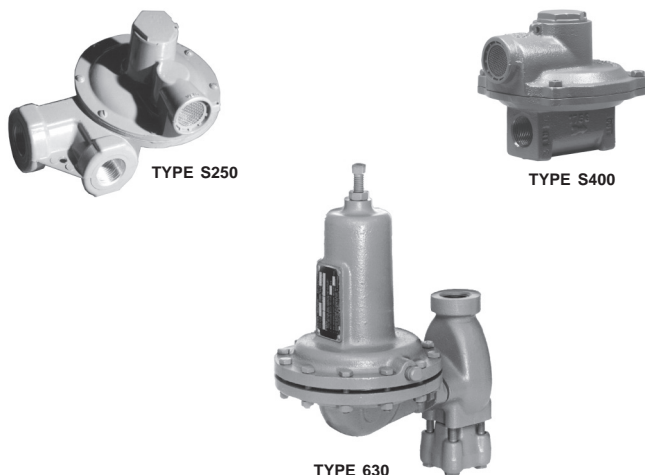

Figure 1. Direct-Operated Regulators

REGULATOR BASICS

A pressure reducing regulator must satisfy a downstream demand while maintaining the system pressure within certain acceptable limits. When the flow rate is low, the regulator plug or disk approaches its seat and restricts the flow. When demand increases, the plug or disk moves away from its seat, creating a larger opening and increased flow. Ideally, a regulator should provide a constant downstream pressure while delivering the required flow.

The service regulator mounted on the meter outside virtually every home serves as an example. As appliances such as a furnace or stove call for the flow of more gas, the service regulator responds by delivering the required flow. As this happens, the pressure should be held constant. This is important because the gas meter, which is the cash register of the system, is often calibrated for a given pressure.

Direct-operated regulators have many commercial and residential uses. Typical applications include industrial, commercial, and domestic gas service, instrument air supply, and a broad range of applications in industrial processes.

Regulators automatically adjust flow to meet downstream demand. Before regulators were invented, someone had to watch a pressure gauge for pressure drops which signaled an increase in downstream demand. When the downstream pressure decreased, more flow was required. The operator then opened the regulating valve until the gauge pressure increased, showing that downstream demand was being met.

ESSENTIAL ELEMENTS

Direct-operated regulators have three essential elements:

- A restricting element—a valve, disk, or plug
- A measuring element—generally a diaphragm
- A loading element—generally a spring

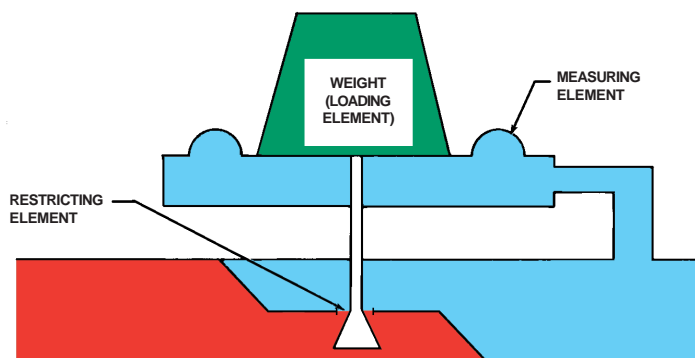

Figure 2. Three Essential Elements

Principles of Direct-Operated Regulators

Restricting Element

The regulator's restricting element is generally a disk or plug that can be positioned fully open, fully closed, or somewhere in between to control the amount of flow. When fully closed, the disk or plug seats tightly against the valve orifice or seat ring to shut off flow.

Measuring Element

The measuring element is usually a flexible diaphragm that senses downstream pressure (P_2). The diaphragm moves as pressure beneath it changes. The restricting element is often attached to the diaphragm with a stem so that when the diaphragm moves, so does the restricting element.

Loading Element

A weight or spring acts as the loading element. The loading element counterbalances downstream pressure (P_2). The amount of unbalance between the loading element and the measuring element determines the position of the restricting element. Therefore, we can adjust the desired amount of flow through the regulator, or setpoint, by varying the load. Some of the first direct-operated regulators used weights as loading elements. Most modern regulators use springs.

REGULATOR OPERATION

To examine how the regulator works, let's consider these values for a direct-operated regulator installation:

- Upstream Pressure (P_1) = 100 psig
- Downstream Pressure (P_2) = 10 psig
- Pressure Drop Across the Regulator (P) = 90 psi
- Diaphragm Area (A_D) = 10 square inches
- Loading Weight = 100 pounds

Let's examine a regulator in equilibrium as shown in Figure 3. The pressure acting against the diaphragm creates a force acting up to 100 pounds.

$$\text{Diaphragm Force (F}_D\text{)} = \text{Pressure (P}_2\text{)} \times \text{Area of Diaphragm (A}_D\text{)}$$

or

$$F_D = 10 \text{ psig} \times 10 \text{ square inches} = 100 \text{ pounds}$$

The 100-pound weight acts down with a force of 100 pounds, so all the opposing forces are equal, and the regulator plug remains stationary.

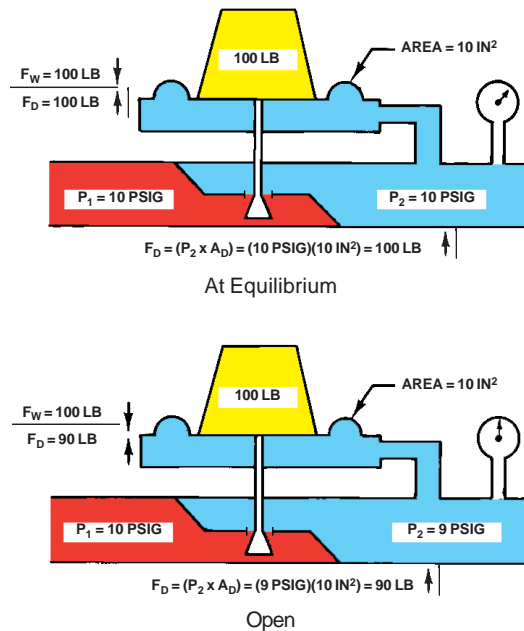

Figure 3. Elements

Increasing Demand

If the downstream demand increases, P_2 will drop. The pressure on the diaphragm drops, allowing the regulator to open further. Suppose in our example P_2 drops to 9 psig. The force acting up then equals 90 pounds (9 psig x 10 square inches = 90 pounds). Because of the unbalance of the measuring element and the loading element, the restricting element will move to allow passage of more flow.

Decreasing Demand

If the downstream demand for flow decreases, downstream pressure increases. In our example, suppose P_2 increases to 11 psig. The force acting up against the weight becomes 110 pounds (11 psig x 10 square inches = 110 pounds). In this case, unbalance causes the restricting element to move up to pass less flow or lockup.

Weights versus Springs

One of the problems with weight-loaded systems is that they are slow to respond. So if downstream pressure changes rapidly, our weight-loaded regulator may not be able to keep up. Always behind, it may

Principles of Direct-Operated Regulators

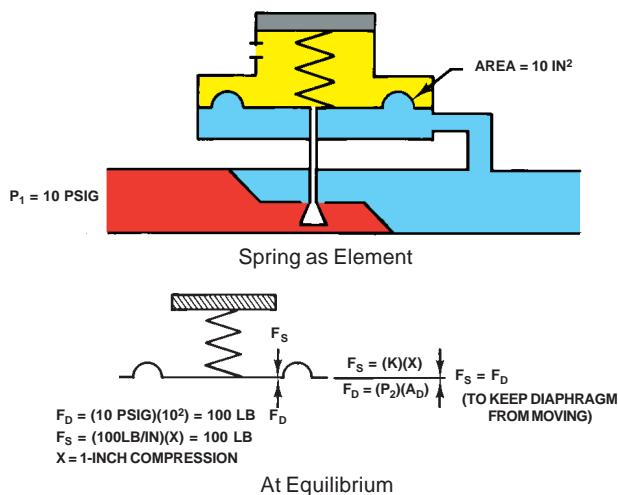

Figure 4. Spring as Element

become unstable and cycle—continuously going from the fully open to the fully closed position. There are other problems. Since the amount of weight controls regulator setpoint, the regulator is not easy to adjust. The weight will always have to be on top of the diaphragm. So, let's consider using a spring. By using a spring instead of a weight, regulator stability increases because a spring has inertia.

Spring Rate

We choose a spring for a regulator by its spring rate (K). K represents the amount of force necessary to compress the spring one inch. For example, a spring with a rate of 100 pounds per inch needs 100 pounds of force to compress it one inch, 200 pounds of force to compress it two inches, and so on.

Equilibrium with a Spring

Instead of a weight, let's substitute a spring with a rate of 100 pounds per inch. And, with the regulator's spring adjuster, we'll wind in one inch of compression to provide a spring force (F_S) of 100 pounds. This amount of compression of the regulator spring determines setpoint, or the downstream pressure that we want to hold constant. By adjusting the initial spring compression, we change the spring loading force, so P₂ will be at a different value in order to balance the spring force.

Now the spring acts down with a force of 100 pounds, and the downstream pressure acts up against the diaphragm producing a force of 100 pounds (F_D = P₂ x A_D). Under these conditions the regulator has achieved equilibrium; that is, the plug or disk is holding a fixed position.

SPRING AS LOADING ELEMENT

By using a spring instead of a fixed weight, we gain better control and stability in the regulator. The regulator will now be less likely to go fully open or fully closed for any change in downstream pressure (P₂). In effect, the spring acts like a multitude of different weights.

Throttling Example

Assume we still want to maintain 10 psig downstream. Consider what happens now when downstream demand increases and pressure P₂ drops to 9 psig. The diaphragm force (F_D) acting up is now 90 pounds.

$$F_D = P_2 \times A_D$$

$$F_D = 9 \text{ psig} \times 10 \text{ in}^2$$

$$F_D = 90 \text{ pounds}$$

We can also determine how much the spring will move (extend) which will also tell us how much the disk will travel. To keep the regulator in equilibrium, the spring must produce a force (F_S) equal to the force of the diaphragm. The formula for determining spring force (F_S) is:

$$F_S = (K)(X)$$

where K = spring rate in pounds/inch and X = travel or compression in inches.

We know F_S is 90 pounds and K is 100 pounds/inch, so we can solve for X with:

$$X = F_S / K$$

$$X = 90 \text{ pounds} / 100 \text{ pounds/inch}$$

$$X = 0.9 \text{ inch}$$

The spring, and therefore the disk, has moved down 1/10-inch, allowing more flow to pass through the regulator body.

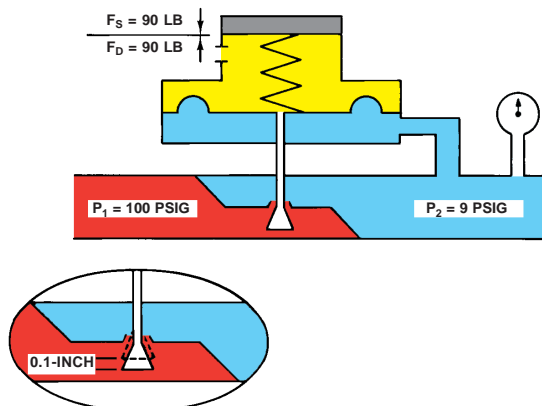
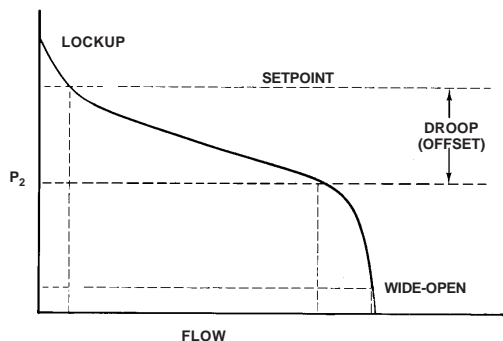

Figure 5. Plug Travel

Principles of Direct-Operated Regulators



As the flow rate approaches zero, P_2 increases steeply. Lockup is the term applied to the value of P_2 at zero flow.

Figure 6. Typical Performance Curve

Regulator Operation and P_2

Now we see the irony in this regulator design. We recall that the purpose of an ideal regulator is to match downstream demand while keeping P_2 constant. But for this regulator design to increase flow, there must be a change in P_2 .

REGULATOR PERFORMANCE

We can check the performance of any regulating system by examining its characteristics. Most of these characteristics can be best described using pressure versus flow curves as shown in Figure 6.

Performance Criteria

We can plot the performance of an ideal regulator such that no matter how the demand changes, our regulator will match that demand (within its capacity limits) with no change in the downstream pressure (P_2). This straight line performance becomes the standard against which we can measure the performance of a real regulator.

Setpoint

The constant pressure desired is represented by the setpoint. But no regulator is ideal. The downward sloping line on the diagram represents pressure (P_2) plotted as a function of flow for an actual direct-operated regulator. The setpoint is determined by the initial compression of the regulator spring. By adjusting the initial spring compression you change the spring loading force, so P_2 will be at a different value in order to balance the spring force. This establishes setpoint.

Droop

Droop, proportional band, and offset are terms used to describe the phenomenon of P_2 dropping below setpoint as flow increases. Droop is the amount of deviation from setpoint at a given flow, expressed as a percentage of setpoint. This “droop” curve is important to a user because it indicates regulating (useful) capacity.

Capacity

Capacities published by regulator manufacturers are given for different amounts of droop. Let’s see why this is important.

Let’s say that for our original problem, with the regulator set at 10 psig, our process requires 200 scfh (standard cubic feet per hour) with no more than a 1 psig drop in setpoint. We need to keep the pressure at or above 9 psig because we have a low limit safety switch set at 9 psig that will shut the system down if pressure falls below this point. Figure 6 illustrates the performance of a regulator that can do the job. And, if we can allow the downstream pressure to drop below 9 psig, the regulator can allow even more flow.

The capacities of a regulator published by manufacturers are generally given for 10 percent droop and 20 percent droop. In our example, this would relate to flow at 9 psig and at 8 psig.

Accuracy

The accuracy of a regulator is determined by the amount of flow it can pass for a given amount of droop. The closer the regulator is to the ideal regulator curve (setpoint), the more accurate it is.

Lockup

Lockup is the pressure above setpoint that is required to shut the regulator off tight. In many regulators, the orifice has a knife edge while the disk is a soft material. Some extra pressure, P_2 , is required to force the soft disk into the knife edge to make a tight seal. The amount of extra pressure required is lockup pressure. Lockup pressure may be important for a number of reasons. Consider the example above where a low pressure limit switch would shut down the system if P_2 fell below 9 psig. Now consider the same system with a high pressure safety cut out switch set a 10.5 psig. Because our regulator has a lockup pressure of 11 psig, the high limit switch will shut the system down before the regulator can establish tight shutoff. Obviously, we’ll want to select a regulator with a lower lockup pressure.

Principles of Direct-Operated Regulators

SPRING RATE AND REGULATOR ACCURACY

Using our initial problem as an example, let's say we now need the regulator to flow 300 scfh at a droop of 10 percent from our original setpoint of 10 psig. Ten percent of 10 psig = 1 psig, so P_2 cannot drop below 10 - 1, or 9 psig. Our present regulator would not be accurate enough. For our regulator to pass 300 scfh, P_2 will have to drop to 8 psig, or 20% droop.

Spring Rate and Droop

One way to make our regulator more accurate is to change to a lighter spring rate. To see how spring rate affects regulator accuracy, let's return to our original example. We first tried a spring with a rate of 100 pounds/inch. Let's substitute one with a rate of 50 pounds/inch. To keep the regulator in equilibrium, we'll have to initially adjust the spring to balance the 100 pound force produced by P_2 acting on the diaphragm. Recall how we calculate spring force:

$$F_S = K (\text{spring rate}) \times X (\text{compression})$$

Knowing that F_S must equal 100 pounds and $K = 50$ pounds/inch, we can solve for X , or spring compression, with:

$$X = F_S \div K, \text{ or } X = 2 \text{ inches}$$

So, we must wind in 2-inches of initial spring compression to balance diaphragm force, F_D .

Effect on Plug Travel

We saw before that with a spring rate of 100 pounds/inch, when P_2 dropped from 10 to 9 psig, the spring relaxed (and the valve disk traveled) 0.1 inch. Now let's solve for the amount of disk travel with the lighter spring rate of 50 pounds per inch. The force produced by the diaphragm is still 90 pounds.

$$F_D = P_2 \times A_D$$

To maintain equilibrium, the spring must also produce a force of 90 pounds. Recall the formula that determines spring force:

$$F_S = (K)(X)$$

Because we know F_S must equal 90 pounds and our spring rate (K) is 50 pounds/inch, we can solve for compression (X) with:

$$X = F_S \div K$$

$$X = 90 \text{ pounds} \div 50 \text{ pounds/inch}$$

$$X = 1.8\text{-inches}$$

To establish setpoint, we originally compressed this spring 2 inches. Now it has relaxed so that it is only compressed 1.8 inches, a change of 0.2 inch. So with a spring rate of 50 pounds/inch, the regulator responded to a 1 psig drop in P_2 by opening twice as far as it did with a spring rate of 100 pounds/inch. Therefore, our regulator is now more accurate because it has greater capacity for the same change in P_2 . In other words, it has less droop or offset. Using this example, it is easy to see how capacity and accuracy are related and how they are related to spring rate.

Light Spring Rate

Experience has shown that choosing the lightest available spring rate will provide the most accuracy (least droop). For example, a spring with a range of 35 to 100 psig is more accurate than a spring with a range of 90 to 200 psig. If you want to set your regulator at 100 psig, the 35 to 100 psig spring will provide better accuracy.

Practical Limits

While a lighter spring can reduce droop and improve accuracy, using too light a spring can cause instability problems. Fortunately, most of the work in spring selection is done by regulator manufacturers. They determine spring rates that will provide good performance for a given regulator, and publish these rates along with other sizing information.

DIAPHRAGM AREA AND REGULATOR ACCURACY

Diaphragm Area

Until this point, we have assumed the diaphragm area to be constant. In practice, the diaphragm area changes with travel. We're interested in this changing area because it has a major influence on accuracy and droop.

Diaphragms have convolutions in them so that they are flexible enough to move over a rated travel range. As they change position, they also change shape because of the pressure applied to them. Consider the example shown in Figure 7. As downstream pressure (P_2) drops, the diaphragm moves down. As it moves down, it changes shape and diaphragm area increases because the centers of the convolutions become further apart. The larger diaphragm area magnifies the effect of P_2 so even less P_2 is required to hold the diaphragm in place. This is called diaphragm effect. The result is decreased accuracy because incremental changes in P_2 do not result in corresponding changes in spring compression or disk position.

Principles of Direct-Operated Regulators

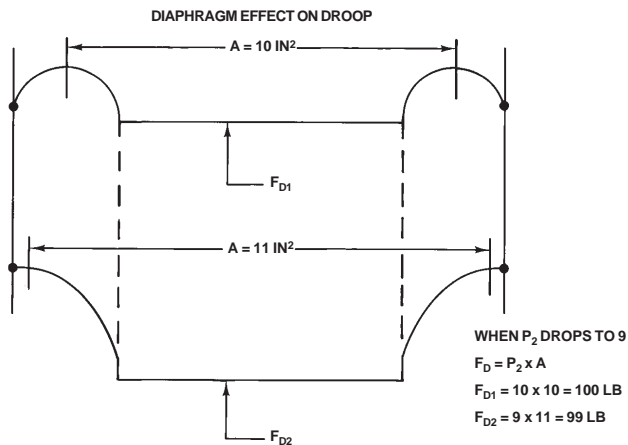

Figure 7. Changing Diaphragm Area

Increasing Diaphragm Area

To better understand the effects of changing diaphragm area, let's calculate the forces in the exaggerated example given in Figure 7. First, assume that the regulator is in equilibrium with a downstream pressure P_2 of 10 psig. Also assume that the area of the diaphragm in this position is 10 square inches. The diaphragm force (F_D) is:

$$F_D = (P_2)(A_D)$$

$$F_D = (10 \text{ psi})(10 \text{ square inches})$$

$$F_D = 100 \text{ pounds}$$

Now assume that downstream pressure drops to 9 psig signaling the need for increased flow. As the diaphragm moves, its area increases to 11 square inches. The diaphragm force now produced is:

$$F_D = (9 \text{ psi})(11 \text{ square inches})$$

$$F_D = 99 \text{ pounds}$$

The change in diaphragm area increases the regulator's droop. While it's important to note that diaphragm effect contributes to droop, diaphragm sizes are generally determined by manufacturers for different regulator types, so there is rarely a user option.

Diaphragm Size and Sensitivity

Also of interest is the fact that increasing diaphragm size can result in increased sensitivity. A larger diaphragm area will produce more force for a given change in P_2 . Therefore, larger diaphragms are often used when measuring small changes in low-pressure applications. Service regulators used in domestic gas service are an example.

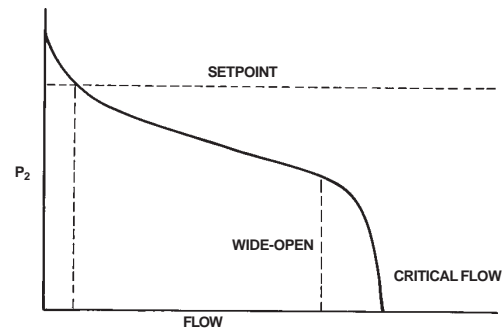

Figure 8. Critical Flow

RESTRICTING ELEMENT AND REGULATOR PERFORMANCE

Critical Flow

While changing the orifice size can increase capacity, a regulator can pass only so much flow for a given orifice size and inlet pressure, no matter how much we improve the unit's accuracy. As you can see in Figure 8, after the regulator is wide-open, reducing P_2 does not result in higher flow. This area of the flow curve identifies critical flow. To increase the amount of flow through the regulator, the flowing fluid must pass at higher and higher velocities. But, the fluid can only go so fast. Holding P_1 constant while decreasing P_2 , flow approaches a maximum which is the speed of sound in that particular gas, or its sonic velocity. Sonic velocity depends on the inlet pressure and temperature for the flowing fluid. Critical flow is generally anticipated when downstream pressure (P_2) approaches a value that is less than or equal to one-half of inlet pressure, P_1 .

Orifice Size and Capacity

One way to increase capacity is to increase the size of the orifice. The variable flow area between disk and orifice depends directly on orifice diameter. Therefore, the disk will not have to travel as far with a larger orifice to establish the required regulator flow rate, and droop is reduced. Sonic velocity is still a limiting factor, but the flow rate at sonic velocity is greater because more gas is passing through the larger orifice.

Stated another way, a given change in P_2 will produce a larger change in flow rate with a larger orifice than it would with a smaller orifice. However, there are definite limits to the size of orifice that can be used. Too large an orifice makes the regulator more sensitive to fluctuating inlet pressures. If the regulator is overly sensitive, it will have a tendency to become unstable and cycle.

Principles of Direct-Operated Regulators

Orifice Size and Stability

One condition that results from an oversized orifice is known as the “bathtub stopper” effect. As the disk gets very close to the orifice, the forces of fluid flow tend to slam the disk into the orifice and shut off flow. Downstream pressure drops and the disk opens. This causes the regulator to cycle—open, closed, open, closed. By selecting a smaller orifice, the disk will operate farther away from the orifice so the regulator will be more stable.

Orifice Size, Lockup, and Wear

A larger orifice size also requires a higher shutoff pressure, or lockup pressure. In addition, an oversized orifice usually produces faster wear on the valve disk and orifice because it controls flow with the disk near the seat. This wear is accelerated with high flow rates and when there is dirt or other erosive material in the flowstream.

Orifice Guideline

Experience indicates that using the smallest possible orifice is generally the best rule-of-thumb for proper control and stability.

Increasing P_1

Regulator capacity can be increased by increasing inlet pressure (P_1).

FACTORS AFFECTING REGULATOR ACCURACY

As we have seen, the design elements of a regulator—the spring, diaphragm, and orifice size—can affect its accuracy. Some of these inherent limits can be overcome with changes to the regulator design.

Performance Limits

The three curves in Figure 9 summarize the effects of spring rate, diaphragm area, and orifice size on the shape of the controlled pressure-flow rate curve. Curve A is a reference curve representing a typical regulator. Curve B represents the improved performance from either increasing diaphragm area or decreasing spring rate. Curve C represents the effect of increasing orifice size. Note that increased orifice size also offers higher flow capabilities. But remember that too large an orifice size can produce problems that will negate any gains in capacity.

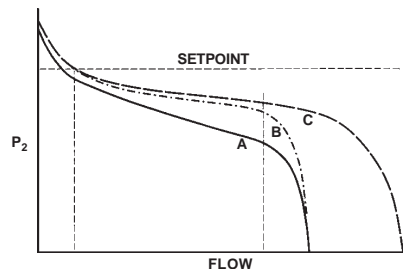

Figure 9. Increased Sensitivity

Cycling

The sine wave in Figure 10 might be what we see if we increase regulator sensitivity beyond certain limits. The sine wave indicates instability and cycling.

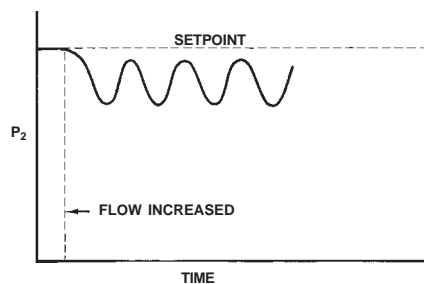

Figure 10. Cycling

DESIGN VARIATIONS

All direct-operated regulators have performance limits that result from droop. Some regulators are available with features designed to overcome or minimize these limits.

Improving Regulator Accuracy with a Pitot Tube

In addition to the changes we can make to diaphragm area, spring rate, orifice size, and inlet pressure, we can also improve regulator accuracy by adding a pitot tube. Internal to the regulator, the pitot tube connects the diaphragm casing with a low-pressure, high velocity region within the regulator body. The pressure at this area will be lower than P_2 further downstream. By using a pitot tube to measure the lower pressure, the regulator will make more dramatic changes in response to any change in P_2 . In other words, the pitot tube tricks the regulator, causing it to respond more than it would otherwise.

Principles of Direct-Operated Regulators

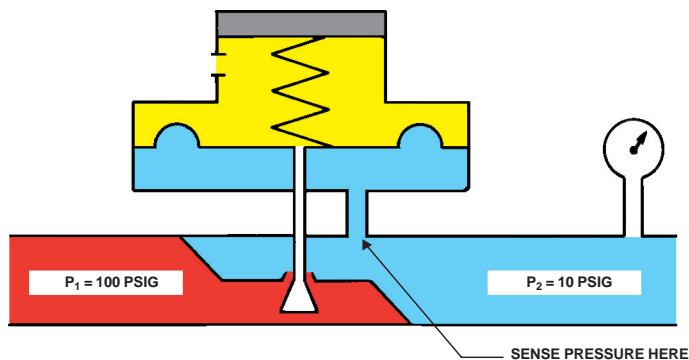

Figure 11. Pitot Tube

Numerical Example

For example, we'll establish setpoint by placing a gauge downstream and adjusting spring compression until the gauge reads 10 psig for P_2 . Because of the pitot tube, the regulator may actually be sensing a lower pressure. When P_2 drops from 10 psig to 9 psig, the pressure sensed by the pitot tube may drop from 8 psig to 6 psig. Therefore, the regulator opens further than it would if it were sensing actual downstream pressure.

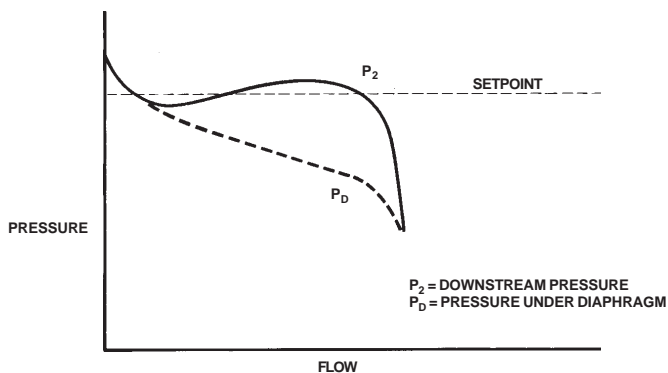

Figure 12. Performance with Pitot Tube

Decreased Droop (Boost)

The pitot tube offers one chief advantage for regulator accuracy, it decreases droop. As we see in Figure 12, the diaphragm pressure, P_D , must drop just as low with a pitot tube as without to move the disk far enough to supply the required flow. But the solid curve shows that P_2 does not decrease as much as it did without a pitot tube. In fact, P_2 may increase. This is called boost instead of droop. So the use of a pitot tube, or similar device, can dramatically improve droop characteristics of a regulator.

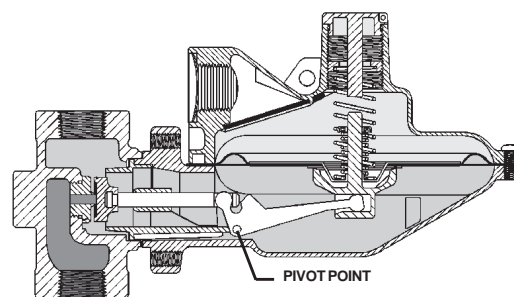

Figure 13. Lever Style Regulator

Improving Performance with a Lever

The lever style regulator is a variation of the simple direct-operated regulator. It operates in the same manner, except that it uses a lever to gain mechanical advantage and provide a high shutoff force.

In earlier discussions, we noted that the use of a larger diaphragm can result in increased sensitivity. This is because any change in P_2 will result in a larger change in diaphragm force. The same result is obtained by using a lever to multiply the force produced by the diaphragm as shown in Figure 13.

The main advantage of lever designs is that they provide increased force for lockup without the extra cost, size, and weight associated with larger diaphragms, diaphragm casings, and associated parts.

Principles of Pilot-Operated Regulators

PILOT-OPERATED REGULATOR BASICS

In the evolution of pressure regulator designs, the shortcomings of the direct-operated regulator naturally led to attempts to improve accuracy and capacity. A logical next step in regulator design is to use what we know about regulator operation to explore a method of increasing sensitivity that will improve all of the performance criteria discussed.

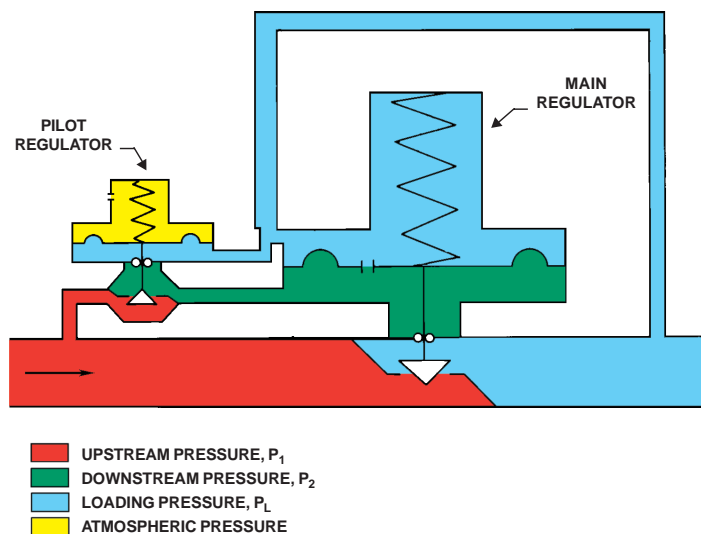

Figure 1. Pilot-Operated Regulator

Regulator Pilots

To improve the sensitivity of our regulator, we would like to be able to sense P_2 and then somehow make a change in loading pressure (P_L) that is greater than the change in P_2 . To accomplish this, we can use a device called a pilot, or pressure amplifier.

The major function of the pilot is to increase regulator sensitivity. If we can sense a change in P_2 and translate it into a larger change in P_L , our regulator will be more responsive (sensitive) to changes in demand. In addition, we can significantly reduce droop so its effect on accuracy and capacity is minimized.

Gain

The amount of amplification supplied by the pilot is called “gain.” To illustrate, a pilot with a gain of 20 will multiply the effect of a 1 psi change on the main diaphragm by 20. For example, a decrease in P_2 opens the pilot to increase P_L 20 times as much.

Identifying Pilots

Analysis of pilot-operated regulators can be simplified by viewing them as two independent regulators connected together. The smaller of the two is generally the pilot.

Setpoint

We may think of the pilot as the “brains” of the system. Setpoint and many performance variables are determined by the pilot. It senses P_2 directly and will continue to make changes in P_L on the main regulator until the system is in equilibrium. The main regulator is the “muscle” of the system, and may be used to control large flows and pressures.

Spring Action

Notice that the pilot uses a spring-open action as found in direct-operated regulators. The main regulator, shown in Figure 1, uses a spring-close action. The spring, rather than loading pressure, is used to achieve shutoff. Increasing P_L from the pilot onto the main diaphragm opens the main regulator.

Pilot Advantage

Because the pilot is the controlling device, many of the performance criteria we have discussed apply to the pilot. For example, droop is determined mainly by the pilot. By using very small pilot orifices and light springs, droop can be made small. Because of reduced droop, we will have greater usable capacity. Pilot lockup determines the lockup characteristics for the system. The main regulator spring provides tight shutoff whenever the pilot is locked up.

GAIN AND RESTRICTIONS

Stability

While increased gain (sensitivity) is often considered an advantage, it also increases the gain of the entire pressure regulator system. If the system gain is too high, it may become unstable. In other words, the regulator may tend to oscillate; over-reacting by continuously opening and closing. Pilot gain can be modified to tune the regulator to the system. To provide a means for changing gain, every pilot-operated regulator system contains both a fixed and a variable restriction. The relative size of one restriction compared to the other can be varied to change gain and speed of response.

Principles of Pilot-Operated Regulators

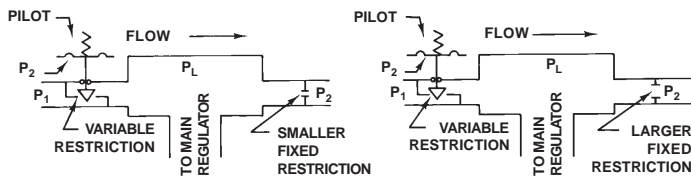

Figure 2. Fixed Restrictions and Gain (Used on Two-Path Control Systems)

Restrictions, Response Time, and Gain

Consider the example shown in Figure 2 with a small fixed restriction. Decreasing P_2 will result in pressure P_L increasing. Increasing P_2 will result in a decrease in P_L while P_L bleeds out through the small fixed restriction.

If a larger fixed restriction is used with a variable restriction, the gain (sensitivity) is reduced. A larger decrease in P_2 is required to increase P_L to the desired level because of the larger fixed restriction.

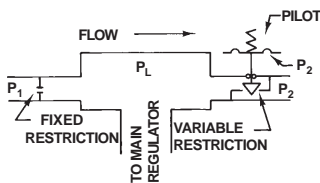
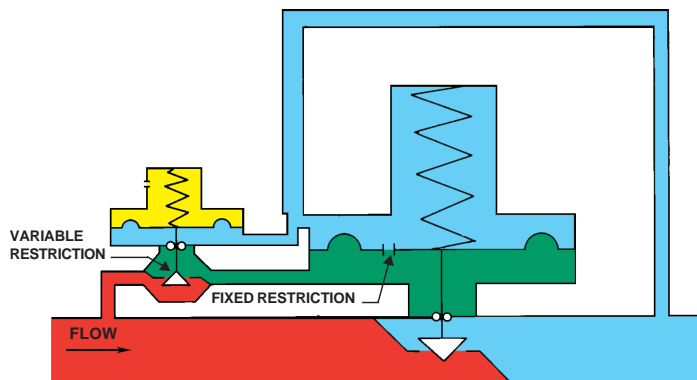

Figure 3. Unloading Systems

LOADING AND UNLOADING DESIGNS

A loading pilot-operated design (Figure 2), also called two-path control, is so named because the action of the pilot loads P_L onto the main regulator measuring element. The variable restriction, or pilot orifice, opens to increase P_L .

An unloading pilot-operated design (Figure 3) is so named because the action of the pilot unloads P_L from the main regulator.



- UPSTREAM PRESSURE, P_1
- LOADING PRESSURE, P_L
- DOWNSTREAM PRESSURE, P_2
- ATMOSPHERIC PRESSURE

Figure 4. Two-Path Control

Two-Path Control (Loading Design)

In two-path control systems (Figure 4), the pilot is piped so that P_2 is registered on the pilot diaphragm and on the main regulator diaphragm at the same time. When downstream demand is constant, P_2 positions the pilot diaphragm so that flow through the pilot will keep P_2 and P_L on the main regulator diaphragm. When P_2 changes, the force on top of the main regulator diaphragm and on the bottom of the pilot diaphragm changes. As P_2 acts on the main diaphragm, it begins repositioning the main valve plug. This immediate reaction to changes in P_2 tends to make two-path designs faster than other pilot-operated regulators. Simultaneously, P_2 acting on the pilot diaphragm repositions the pilot valve and changes P_L on the main regulator diaphragm. This adjustment to P_L accurately positions the main regulator valve plug. P_L on the main regulator diaphragm bleeds through a fixed restriction until the forces on both sides are in equilibrium. At that point, flow through the regulator valve matches the downstream demand.

Two-Path Control Advantages

The primary advantages of two-path control are speed and accuracy. These systems may limit droop to less than one percent. They are well suited to systems with requirements for high accuracy, large capacity, and a wide range of pressures.

Principles of Pilot-Operated Regulators

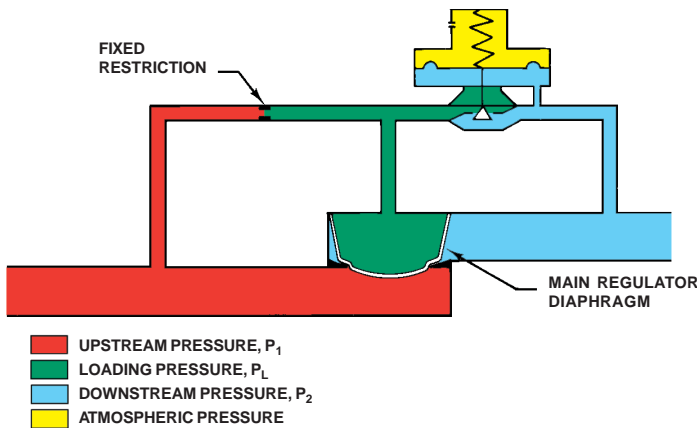

Figure 5. Unloading Control

Unloading Control

Unloading systems (Figure 5) locate the pilot so that P_2 acts only on the pilot diaphragm. P_1 constantly loads under the regulator diaphragm and has access to the top of the diaphragm through a fixed restriction.

When downstream demand is constant, the pilot valve is open enough that P_L holds the position of the main regulator diaphragm. When downstream demand changes, P_2 changes and the pilot diaphragm reacts accordingly. The pilot valve adjusts P_L to reposition and hold the main regulator diaphragm.

Unloading Control Advantages

Unloading systems are not quite as fast as two-path systems, and they can require higher differential pressures to operate. However, they are simple and more economical, especially in large regulators. Unloading control is used with popular elastomer diaphragm style regulators. These regulators use a flexible membrane to throttle flow.

PERFORMANCE SUMMARY

Accuracy

Because of their high gain, pilot-operated regulators are extremely accurate. Droop for a direct-operated regulator may be in the range of 10 to 20 percent whereas pilot-operated regulators are between one and three percent with values under one percent possible.

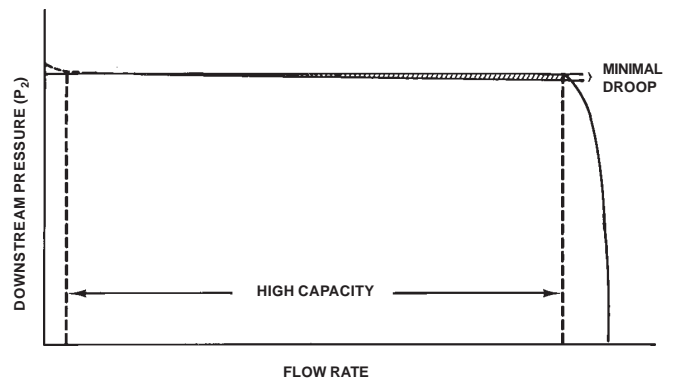

Figure 6. Pilot-Operated Regulator Performance

Capacity

Pilot-operated designs provide high capacity for two reasons. First, we have shown that capacity is related to droop. And because droop can be made very small by using a pilot, capacity is increased. In addition, the pilot becomes the “brains” of the system and controls a larger, sometimes much larger, main regulator. This also allows increased flow capabilities.

Lockup

The lockup characteristics for a pilot-operated regulator are the lockup characteristics of the pilot. Therefore, with small orifices, lockup pressures can be small.

Applications

Pilot-operated regulators should be considered whenever accuracy, capacity, and/or high pressure are important selection criteria. They can often be applied to high capacity services with greater economy than a control valve and actuator with controller.

TWO-PATH CONTROL

In some designs (Figure 7), the pilot and main regulator are separate components. In others (Figure 8), the system is integrated into a single package. All, however, follow the basic design concepts discussed earlier.

Principles of Pilot-Operated Regulators

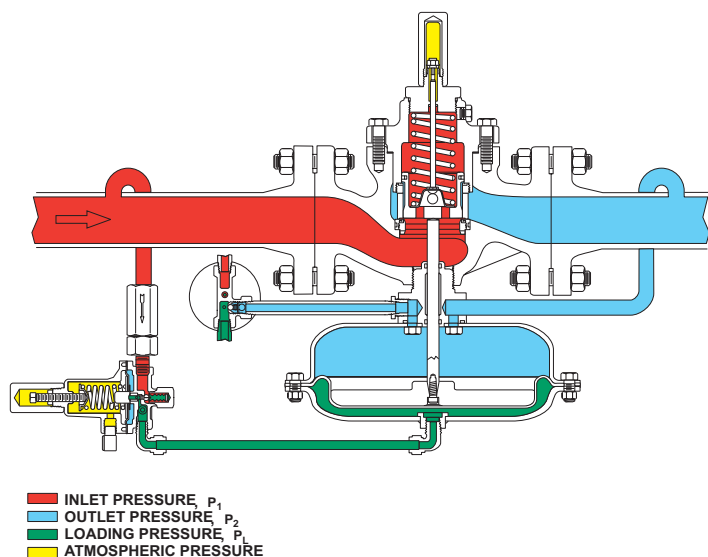

Figure 7. Type 1098-EGR, Typical Two-Path Control

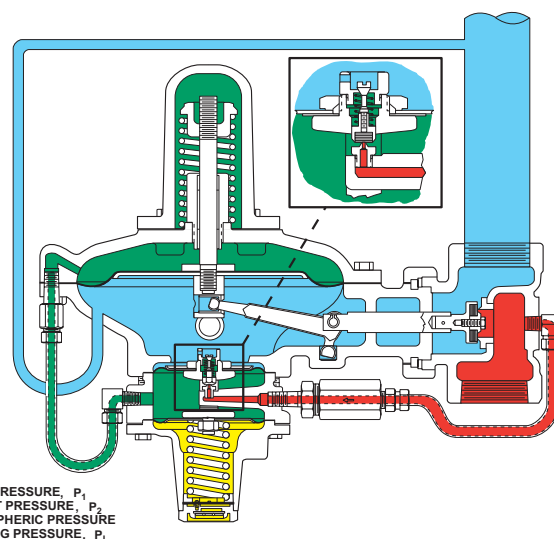

Figure 8. Type 99, Typical Two-Path Control with Integrally Mounted Pilot

Type 1098-EGR

The schematic in Figure 7 illustrates the Type 1098-EGR regulator's operation. It can be viewed as a model for all two-path, pilot-operated regulators. The pilot is simply a sensitive direct-operated regulator used to send loading pressure to the main regulator diaphragm.

Identify the inlet pressure (P_1). Find the downstream pressure (P_2). Follow it to where it opposes the loading pressure on the main regulator diaphragm. Then, trace P_2 back to where it opposes the control spring in the pilot. Finally, locate the route of P_2 between the pilot and the regulator diaphragm.

Changes in P_2 register on the pilot and main regulator diaphragms at the same time. As P_2 acts on the main diaphragm, it begins repositioning the main valve plug. Simultaneously, P_2 acting on the pilot diaphragm repositions the pilot valve and changes P_L on the main regulator diaphragm. This adjustment in P_L accurately positions the main regulator valve plug.

As downstream demand is met, P_2 rises. Because P_2 acts directly on both the pilot and main regulator diaphragms, this design provides fast response.

Type 99

The schematic in Figure 8 illustrates another typical two-path control design, the Type 99. The difference between the Type 1098-EGR and the Type 99 is the integrally mounted pilot of the Type 99.

The pilot diaphragm measures P_2 . When P_2 falls below the pilot setpoint, the diaphragm moves away from the pilot orifice and allows loading pressure to increase. This loads the top of the main regulator diaphragm and strokes the main regulator valve open further.

Principles of Pilot-Operated Regulators

UNLOADING DESIGN

Unloading designs incorporate a molded composition diaphragm that serves as the combined loading and restricting component of the main regulator. Full upstream pressure (P_1) is used to load the regulator diaphragm when it is seated. The Type 399A shown in Figure 9 incorporates an elastomeric valve closure member.

Unloading regulator designs are slower than two-path control systems because the pilot must first react to changes in P_2 before the main regulator valve moves. Recall that in two-path designs, the pilot and main regulator diaphragms react simultaneously.

P_1 passes through a fixed restriction and fills the space above the regulator diaphragm. This fixed restriction may be adjusted to increase or decrease regulator gain. P_1 also fills the cavity below the regulator diaphragm. Because the surface area on the top side of the diaphragm is larger than the area exposed to P_1 below, the diaphragm is forced down against the cage to close the regulator.

When downstream demand increases, the pilot opens. When the pilot opens, regulator loading pressure escapes downstream much faster than P_1 can bleed through the fixed restriction. As pressure above the regulator diaphragm decreases, P_1 forces the diaphragm away from its seat.

When downstream demand is reduced, P_2 increases until it's high enough to compress the pilot spring and close the pilot valve. As the pilot valve closes, P_1 continues to pass through the fixed restriction and flows into the area above the main regulator diaphragm. This loading pressure, P_L , forces the diaphragm back toward the cage, reducing flow through the regulator.

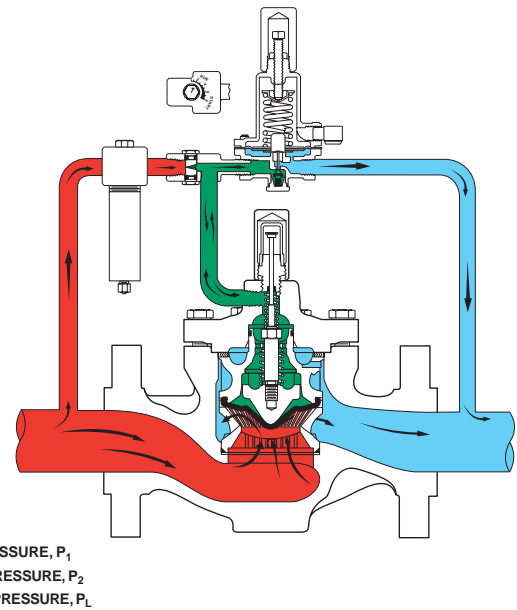

Figure 9. Type 399A, Typical Elastomer Element Design

Selecting and Sizing Pressure Reducing Regulators

INTRODUCTION

Those who are new to the regulator selection and sizing process are often overwhelmed by the sheer number of regulator types available and the seemingly endless lists of specifications in manufacturer's literature. This handbook is designed to assist you in selecting a regulator that fits your application's specific needs.

THE FISHER REGULATOR HANDBOOK

While it may seem obvious, the first step is to consider the application itself. Some applications immediately point to a group of regulators designed specifically for that type of service. The Fisher Regulator Handbook is divided into applications sections to help identify regulators that are designed for specific applications. Within each section there is an Application Map, Quick Selection Guide, an Application Guide, and Product Pages. The Application Map shows some of the common applications and the regulators that are used in those applications. The Quick Selection Guide lists the regulators by application, and provides important selection information about each regulator. The Application Guide explains the applications covered in the section and it also explains many of the application considerations. The Product Pages provide specific details about the regulators that are suitable for the applications covered in the section. To begin selecting a regulator, turn to the Quick Selection Guide in the appropriate application section.

Quick Selection Guides

Quick Selection Guides identify the regulators with the appropriate pressure ratings, outlet pressure ranges, and capacities. These guides quickly narrow the range of potentially appropriate regulators. The choices identified by using a Quick Selection Guide can be narrowed further by using the Product Pages to find more information about each of the regulators.

Product Pages

Identifying the regulators that can pass the required flow narrows the possible choices further. When evaluating flow requirements, consider the minimum inlet pressure and maximum flow requirements. Again, this worst case combination ensures that the regulator can pass the required flow under all anticipated conditions.

After one or more regulators have been identified as potentially suitable for the service conditions, consult specific Product Pages to check regulator specifications and capabilities. The application

requirements are compared to regulator specifications to narrow the range of appropriate selections. The following specifications can be evaluated in the Product Pages:

- Product description and available sizes
- Maximum inlet and outlet pressures (operating and emergency)
- Outlet pressure ranges
- Flow capacity
- End connection styles
- Regulator construction materials
- Accuracy
- Pressure registration (internal or external)
- Temperature capabilities

After comparing the regulator capabilities with the application requirements, the choices can be narrowed to one or a few regulators. Final selection may depend upon other factors including special requirements, availability, price, and individual preference.

Special Requirements

Finally, evaluate any special considerations, such as the need for external control lines, special construction materials, or internal overpressure protection. While overpressure protection may be considered during sizing and selection, it is not covered in this section.

The Role of Experience

Experience in the form of knowing what has worked in the past, and familiarity with specific products, has great value in regulator sizing and selection. Knowing the regulator performance characteristics required for a specific application simplifies the process. For example, when fast speed of response is required, a direct-operated regulator may come to mind; or a pilot-operated regulator with an auxiliary, large capacity pilot to speed changes in loading pressure.

SIZING EQUATIONS

Sizing equations are useful when sizing pilot-operated regulators and relief valves. They can also be used to calculate the wide-open flow of direct-operated regulators. Use the capacity tables or curves in this handbook when sizing direct-operated regulators and relief/backpressure regulators. The sizing equations are in the Valve Sizing Calculations section.

Selecting and Sizing Pressure Reducing Regulators

GENERAL SIZING GUIDELINES

The following are intended to serve only as guidelines when sizing pressure reducing regulators. When sizing any regulator, consult with experienced personnel or the regulator manufacturer for additional guidance and information relating to specific applications.

Body Size

Regulator body size should never be larger than the pipe size. However, a properly sized regulator may be smaller than the pipeline.

Construction

Be certain that the regulator is available in materials that are compatible with the controlled fluid and the temperatures used. Also, be sure that the regulator is available with the desired end connections.

Pressure Ratings

While regulators are sized using minimum inlet pressures to ensure that they can provide full capacity under all conditions, pay particular attention to the maximum inlet and outlet pressure ratings.

Wide-Open Flow Rate

The capacity of a regulator when it has failed wide-open is usually greater than the regulating capacity. For that reason, use the regulating capacities when sizing regulators, and the wide-open flow rates only when sizing relief valves.

Outlet Pressure Ranges and Springs

If two or more available springs have published outlet pressure ranges that include the desired pressure setting, use the spring with the lower range for better accuracy. Also, it is not necessary to attempt to stay in the middle of a spring range, it is acceptable to use the full published outlet pressure range without sacrificing spring performance or life.

Accuracy

Of course, the need for accuracy must be evaluated. Accuracy is generally expressed as droop, or the reduction of outlet pressure experienced as the flow rate increases. It is stated in percent, inches

of water column, or pounds per square inch. It indicates the difference between the outlet pressure at low flow rates and the outlet pressure at the published maximum flow rate. Droop is also called offset or proportional band.

Inlet Pressure Losses

The regulator inlet pressure used for sizing should be measured directly at the regulator inlet. Measurements made at any distance upstream from the regulator are suspect because line loss can significantly reduce the actual inlet pressure to the regulator. If the regulator inlet pressure is given as a system pressure upstream, some compensation should be considered. Also, remember that downstream pressure always changes to some extent when inlet pressure changes.

Orifice Diameter

The recommended selection for orifice size is the smallest diameter that will handle the flow. This can benefit operation in several ways: instability and premature wear may be avoided, relief valves may be smaller, and lockup pressures may be reduced.

Speed of Response

Direct-operated regulators generally have faster response to quick flow changes than pilot-operated regulators.

Turn-Down Ratio

Within reasonable limits, most soft-seated regulators can maintain pressure down to zero flow. Therefore, a regulator sized for a high flow rate will usually have a turndown ratio sufficient to handle pilot-light sized loads during periods of low demand.

SIZING EXERCISES

Regulator selection and sizing generally requires some subjective evaluation and decision making. For those with little experience, the best way to learn is through example. Therefore, these exercises present selection and sizing problems for practicing the process of identifying suitable regulators.

Selecting and Sizing Pressure Reducing Regulators

PROBLEM 1: INDUSTRIAL PLANT GAS SUPPLY

Our first problem is to select a regulator to supply reduced pressure natural gas to meet the needs of a small industrial plant. The regulated gas is metered before entering the plant. The selection parameters are:

- Minimum inlet pressure, $P_{1min} = 30$ psig
- Maximum inlet pressure, $P_{1max} = 40$ psig
- Outlet pressure setting, $P_2 = 1$ psig
- Flow, $Q = 95,000$ scfh
- Accuracy, droop = 10% or less

Quick Selection Guide

Turn to the Natural Gas section. Find the Commercial/Industrial Quick Selection Guide. From the Quick Selection Guide, we find that there are three possible choices:

- Type 133
- Type 1098-EGR
- Type 99

Product Pages

Under the product number on the Quick Selection Guide is the page number of the Product Page. Look at the flow capacities of each of the possible choices. From the Product Pages we found the following:

- At 30 psig inlet pressure and 10% droop, the Type 133 has a flow capacity of 90,000 scfh. This regulator does not meet the required flow capacity.
- At 30 psig inlet pressure, the Type 1098-EGR has a flow capacity of 131,000 scfh. By looking at the Proportional Band (Droop) table, we see that the Type 6352 pilot with the yellow pilot spring and the green main valve has 0.05 psig droop. This regulator meets the selection criteria.
- At 30 psig inlet pressure, The Type 99 has a flow capacity of 39,000 scfh. This regulator does not meet the required flow capacity.

Final Selection

We find that the Type 1098-EGR meets the selection criteria.

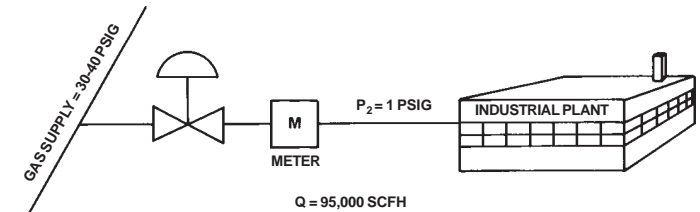

Figure 1. Natural Gas Supply

PROBLEM 2: STEAM SPACE HEATER

In this exercise, we need to select and size a regulator controlling steam to a space heater used to heat an area of a plant. The application parameters are:

- Inlet pressure, $P_1 = 125$ psig
- Outlet pressure setting, $P_2 = 10$ psig
- Flow, $Q = 500$ pounds per hour (pph)
- Droop = 20% or less

Quick Selection Guide

Turn to the Steam section. Find the Pressure Reducing Regulator Quick Selection Guide. From the Quick Selection Guide, we find that there are three possible choices:

- 95L Series
- Type 92C
- 95H Series

Product Pages

Under the product number on the Quick Selection Guide is the page number of the Product Page. Look at the flow capacities of each of the possible choices. From the Product Pages we found the following:

- By looking at the Type 95L capacity table, we find that in the required outlet pressure range there is not a listed flow capacity. We will have to interpolate the flow capacity using the 100 and 200 inlet pressure flow capacities, 440 and 600 pph. The interpolated flow capacity is 480 pph. The following steps were used to find the interpolated flow capacity:

Selecting and Sizing Pressure Reducing Regulators

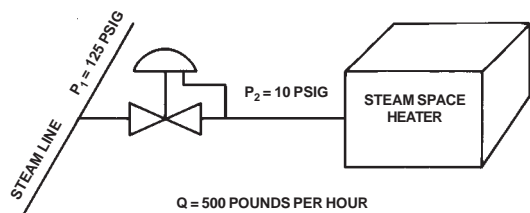

Figure 2. One Steam Space Heater

PROBLEM 3: HIGH PRESSURE WATER SUPPLY

For this exercise we want to select a regulator to control a high pressure water supply to a water-powered hydraulic system. The application parameters are:

- Inlet pressure, $P_1 = 600$ psig
- Outlet pressure, $P_2 = 400$ psig
- Flow, $Q = 20$ gallons per minute (gpm)

Quick Selection Guide

Turn to the Liquid section. Find the Pressure Reducing Regulator Quick Selection Guide. From the Quick Selection Guide, we find that there are two possible choices:

- 95H Series
- 627W Series

Product Pages

Under the product number on the Quick Selection Guide is the page number of the Product Page. Look at the flow capacities of each of the possible choices. From the Product Pages we find the following:

- From looking at the specifications and maximum pressures of the 95H Series, we find that the Type 95HP meets the application's pressure parameters. Looking at the Type 95HP capacity tables, we find that a 1/2-inch body has a flow capacity of 22 gpm at 20% droop and a 3/4-inch body has a flow capacity of 33 gpm at 10% droop. This regulator is available in two sizes that meet the application specifications.
- By looking at the specifications on the first page of the 627W Series, we see that the Type 627WH provides the desired outlet pressure. Using the Type 627WH capacity table, we see that the 1-inch body at 500 psig inlet pressure has a flow capacity of 19 gpm and with 750 psig inlet pressure the flow capacity is 27 gpm. By interpolating, we find that at 400 psig inlet pressure this regulator will flow at 21 gpm. This regulator meets the application specifications.

Final Selection

We can see that both of these regulators meet the requirements of the application. In this case, the final selection will depend upon other factors including special requirements, availability, price, individual preference, and installation and maintenance considerations.

1. Subtract the 100 psig capacity from the 200 psig capacity
 $600 - 440 = 160$
2. Divide the difference by the number of steps from 100 to 200
 $160 \div 4 = 40$
3. Add the result to the lower capacity
 $440 + 40 = 480$

Inlet Pressure, psig	Interpolated Capacities, pph
100	440
125	480
150	520
175	580
200	600

The interpolated capacities show that the Type 95L does not meet the flow capacity requirement of this application; however, it is so close that it may prove worthwhile to examine the actual flow capacity requirements of the application.

- From the capacity tables we find that a 1/2-inch Type 92C with 10% droop has a flow capacity of 550 pph at 100 psig and 600 pph at 150 psig. By interpolating, we find that the flow capacity at 125 psig would be 575 pph. This regulator meets the required specifications of the application.
- Looking at the Type 95H capacity tables we find that a 1-1/2 or 2-inch body would meet the required application specifications.

Final Selection

For this application, all of the possible selections may be suitable. The final selection will depend upon the actual flow requirements of the system and other factors, such as the price and availability of the regulators, regulator type and construction, process conditions, and personal preference.

Selecting and Sizing Pressure Reducing Regulators

PROBLEM 4: CORROSIVE GAS

In this exercise, we will select a regulator for a low-pressure gas system. This is corrosive gas that requires Hastelloy C wetted metal parts and ethylenepropylene (EPDM) or teflon (TFE or PTFE) elastomer parts. The application parameters are:

- Minimum inlet pressure = 60 psig
- Maximum inlet pressure = 125 psig
- Outlet pressure = 7-inches w.c.
- Flow, Q = 200 SCFH
- Specific Gravity = 0.9 at 60°F

Quick Selection Guide

Turn to the Process Gases section. We go to the Process Gases section because this application requires special materials. Find the Pressure Reducing Regulators Quick Selection Guide. From the Quick Selection Guide, we find that the following regulators meet the pressure and flow requirements:

- Y690 Series
- Type Y692
- Type 1098-EGR
- Type 99

However, we need to make sure these regulators are available in the materials that this application requires. There is a Material Availability Chart as part of the Application Guide. This chart allows you to quickly identify the regulators that are available in the materials required for your application.

By looking at this chart, we find that two of the regulators meet the application's material requirements:

- Type Y690
- Type Y692

Product Pages

Under the product number on the Quick Selection Guide is the page number of the Product Page. Look at the flow capacities of each of the possible choices. The capacities in this section are shown in scfh of air (1.0 specific gravity at 60°F). We need to keep in mind that the specific gravity of the gas affects the regulator's flow capacity. Because the specific gravity of the gas in this application is only slightly lower than the specific gravity of air, it should not significantly affect the flow capacity; however, when there is a larger difference you will need to make the necessary flow rate conversions. From the Product Pages we found the following:

- The Y690 Series Construction Materials table shows that the regulator body and diaphragm case are available in Hastelloy C and the elastomeric parts are available in ethylenepropylene (EPDM) and PTFE (teflon). From the Maximum Operating Inlet Pressure table, we find that there are two spring ranges that provide the desired outlet pressure and we need to use a 1/8-inch orifice to meet our inlet pressure specification. Next, we check the Capacity tables to make sure this regulator meets our flow requirements. The first outlet pressure range, found in the Type Y690 Capacities table, does not show an outlet pressure setting of 7-inches w.c. For now, we will move on to the next outlet pressure range shown in the Type Y690H and Y690M Capacities for 3/4-inch Body table. We see that this regulator meets our flow requirements at both the maximum and minimum inlet pressures.

- By looking at the specifications of the Type Y692, we see that this regulator is only available in 1-1/2 and 2-inch bodies. This regulator more than meets our requirements; however, it would be oversized for this application.

Final Selection

In this case, the best choice for our application is the Type Y690.

Overpressure Protection Methods

Overpressure protective devices are of vital concern. Safety codes and current laws require their installation each time a pressure reducing station is installed that supplies gas from any system to another system with a lower maximum allowable operating pressure.

METHODS OF OVERPRESSURE PROTECTION

The most commonly used methods of overpressure protection, not necessarily in order of use or importance, include:

- Relief Valves (Figure 1)
- Monitors (Figures 2 and 3)
- Series Regulation (Figure 4)
- Shutoff (Figure 5)

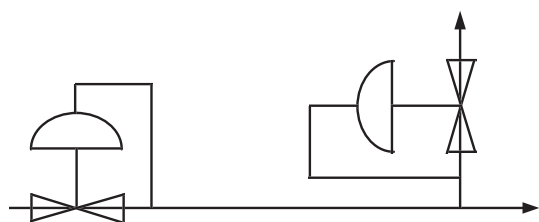

Figure 1. Relief Valve Schematic

RELIEF VALVES

A relief valve is a device that vents process fluid to atmosphere to maintain the pressure downstream of the regulator below the safe maximum pressure. Relief is a common form of overpressure protection typically used for low to medium capacity applications. (Note: Fisher relief valves are not ASME safety relief valves.)

Types of Relief Valves

The basic types of relief valves are:

- Pop type
- Direct-operated relief valves
- Pilot-operated relief valves
- Internal relief valves

The pop type relief valve is the simplest form of relief. Pop relief valves tend to go wide-open once the pressure has exceeded its setpoint by a small margin. The setpoint can drift over time, and because of its quick opening characteristic the pop relief can sometimes become unstable when relieving, slamming open and closed. Many have a non-adjustable setpoint that is set and pinned at the factory.

If more accuracy is required from a relief valve, the direct-operated relief valve would be the next choice. They can throttle better than a pop relief valve, and tend to be more stable, yet are still relatively simple. Although there is less drift in the setpoint of the direct-operated relief valve, a significant amount of buildup is often required to obtain the required capacity.

The pilot-operated relief valves have the most accuracy, but are also the most complicated and expensive type of relief. They use a pilot to dump loading pressure, fully stroking the main valve with very little buildup above setpoint. They have a large capacity and are available in larger sizes than other types of relief.

Many times, internal relief will provide adequate protection for a downstream system. Internal relief uses a relief valve built into the regulator for protection. If the pressure builds too far above the setpoint of the regulator, the relief valve in the regulator opens up, allowing excess pressure to escape through the regulator vent.

Advantages

The relief valve is considered to be the most reliable type of overpressure protection because it is not subject to blockage by foreign objects in the line during normal operations. It also imposes no decrease in the regulator capacity which it is protecting, and it has the added advantage of being its own alarm when it vents. It is normally reasonable in cost and keeps the customer in service despite the malfunction of the pressure reducing valve.

Disadvantages

When the relief valve blows, it could possibly create a hazard in the surrounding area by venting. The relief valve must be sized carefully to relieve the gas or fluid that could flow through the pressure reducing valve at its maximum inlet pressure and in the wide-open position, assuming no flow to the downstream. Therefore, each application must be sized individually. The requirement for periodic testing of relief valves also creates an operational and/or public relations problem.

Overpressure Protection Methods

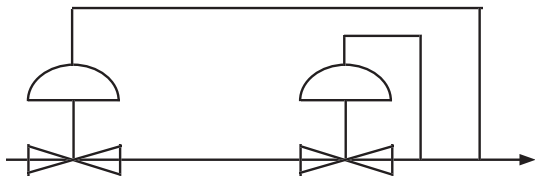

Figure 2. Monitoring Regulators Schematic

MONITORING REGULATORS

Monitoring is overpressure control by containment. When the working pressure reducing valve ceases to control the pressure, a second regulator installed in series, which has been sensing the downstream pressure, goes into operation to maintain the downstream pressure at a slightly higher than normal pressure. The monitoring concept is gaining in popularity, especially in low-pressure systems, because very accurate relay pilots permit reasonably close settings of the working and monitoring regulators.

The two types of wide-open monitoring are upstream and downstream monitoring. One question often asked is, “Which is better, upstream or downstream monitoring?” Using two identical regulators, there is no difference in overall capacity with either method.

When using monitors to protect a system or customer who may at times have zero load, a small relief valve is sometimes installed downstream of the monitor system with a setpoint just above the monitor. This allows for a token relief in case dust or dirt in the system prevents bubble tight shutoff of the regulators.

Advantages

The major advantage is that there is no venting to atmosphere. During an overpressure situation, monitoring keeps the customer on line and keeps the downstream pressure relatively close to the setpoint of the working regulator. Testing is relatively easy and safe. To perform a periodic test on a monitor, increase the outlet set pressure of the working device and watch the pressure to determine if the monitor takes over.

Disadvantages

Compared to relief valves, monitoring generally requires a higher initial investment. Monitoring regulators are subject to blocking, which is why filters or strainers are specified with increasing frequency. Because the monitor is in series, it is an added restriction in the line. This extra restriction can sometimes force one to use a larger, more expensive working regulator.

Another disadvantage related to monitoring installations is that there is no way of knowing for certain that a stand-by wide-open monitor will work if required. In many cases, the monitor will be examined more frequently than other forms of overpressure protection.

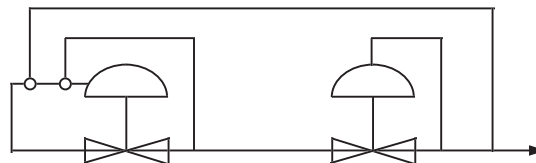

Figure 3. Working Monitor Schematic

WORKING MONITOR

A variation of monitoring overpressure protection that overcomes some of the disadvantages of a wide-open monitor is the “working monitor” concept wherein a regulator upstream of the working regulator uses two pilots. This additional pilot permits the monitoring regulator to act as a series regulator to control an intermediate pressure during normal operation. In this way, both units are always operating and can be easily checked for proper operation. Should the downstream pressure regulator fail to control, however, the monitoring pilot takes over the control at a slightly higher than normal pressure and keeps the customer on line. This is pressure control by containment and eliminates public relations problems.

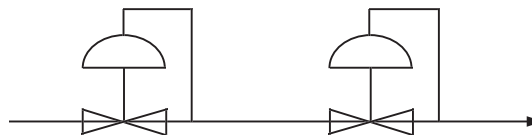

Figure 4. Series Regulation Schematic

SERIES REGULATION

Series regulation is also overpressure protection by containment in that two regulators are set in the same pipeline. The first unit maintains an inlet pressure to the second valve that is within the maximum allowable operating pressure of the downstream system. Under this setup, if either regulator should fail, the resulting downstream pressure maintained by the other regulator would not exceed the safe maximum pressure.

This type of protection is normally used where the regulator station is reducing gas to a pressure substantially below the maximum allowable

Overpressure Protection Methods

operating pressure of the distribution system being supplied. Series regulation is also found frequently in farm taps and in similar situations within the guidelines mentioned above.

Advantages

Again, nothing is vented to atmosphere.

Disadvantages

Because the intermediate pressure must be cut down to a pressure that is safe for the entire downstream, the second-stage regulator often has very little pressure differential available to create flow. This can sometimes make it necessary to increase the size of the second regulator significantly. Another drawback occurs when the first-stage regulator fails and no change in the final downstream pressure is noticed because the system operates in what appears to be a “normal” manner without benefit of protection. Also, the first-stage regulator and intermediate piping must be capable of withstanding and containing maximum upstream pressure.

The second-stage regulator must also be capable of handling the full inlet pressure in case the first-stage unit fails to operate. In case the second-stage regulator fails, its actuator will be subjected to the intermediate pressure set by the first-stage unit. The second-stage actuator pressure ratings should reflect this possibility.

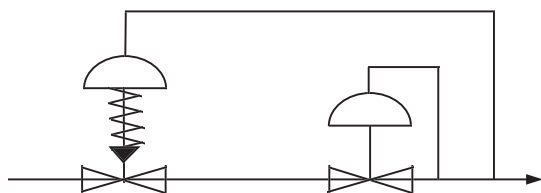

Figure 5. Shutoff Schematic

SHUTOFF DEVICES

The shutoff device also accomplishes overpressure protection by containment. In this case, the customer is shut off completely until the cause of the malfunction is determined and the device is manually reset. Many gas distribution companies use this as an added measure of protection for places of public assembly such as schools, hospitals, churches, and shopping centers. In those cases, the shutoff device is a secondary form of overpressure protection. Shutoff valves are also commonly used by boiler manufacturers in combustion systems.

Advantages

By shutting off the customer completely, the safety of the downstream system is assured. Again, there is no public relations problem or hazard from venting gas or other media.

Disadvantages

The customer may be shut off because debris has temporarily lodged under the seat of the operating regulator, preventing tight shutoff. A small relief valve can take care of this situation.

On a distribution system with a single supply, using a slam-shut can require two trips to each customer, the first to shut off the service valve, and the second visit after the system pressure has been restored to turn the service valve back on and re-light the appliances. In the event a shutoff is employed on a service line supplying a customer with processes such as baking, melting metals, or glass making, the potential economic loss could dictate the use of an overpressure protection device that would keep the customer online.

Another problem associated with shutoffs is encountered when the gas warms up under no-load conditions. For instance, a regulator locked up at approximately 7-inches w.c. could experience a pressure rise of approximately 0.8-inches w.c. per degree Fahrenheit rise, which could cause the high-pressure shutoff to trip when there is actually no equipment failure.

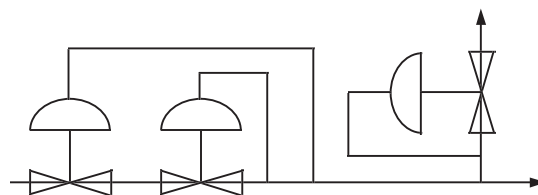

Figure 6. Relief Monitor Schematic

RELIEF MONITOR

Another concept in overpressure protection for small industrial and commercial loads, up to approximately 10,000 cubic feet per hour, incorporates both an internal relief valve and a monitor. In this device, the relief capacity is purposely restricted to prevent excess venting of gas in order to bring the monitor into operation more quickly. The net result is that the downstream pressure is protected, in some cases to less than 1 psig. The amount of gas vented under maximum inlet pressure conditions does not exceed the amount vented by a domestic relief type service regulator.

Overpressure Protection Methods

Types of Overpressure Protection						
PERFORMANCE QUESTIONS	RELIEF	WORKING MONITOR	MONITOR	SERIES REGULATION	SHUTOFF	RELIEF MONITOR
Keeps application online?	YES	YES	YES	YES	NO	YES
Venting to atmosphere?	YES	NO	NO	NO	NO	MINOR
Manual resetting required after operation?	NO	NO	NO	NO	YES	NO
Reduces capacity of regulator?	NO	YES	YES	YES	NO	NO
Constantly working during normal operation?	NO	YES	NO	YES	NO	YES
Demands "emergency" action?	YES	NO	NO	NO	YES	MAYBE
Will surveillance of pressure charts indicate partial loss of performance of overpressure devices?	NO	YES	MAYBE	YES	NO	NO
Will surveillance of pressure charts indicate regulator has failed and safety device is in control?	YES	YES	YES	YES	YES	YES

With this concept, the limitation by regulator manufacturers of inlet pressure by orifice size, as is found in "full relief" devices, is overcome. Downstream protection is maintained, even with abnormally high inlet pressure. Public relations problems are kept to a minimum by the small amount of vented gas. Also, the unit does not require manual resetting, but can go back into operation automatically.

Dust or dirt can clear itself off the seat, but if the obstruction to the disk closing still exists when the load goes on, the customer would be kept online. When the load goes off, the downstream pressure will again be protected. During normal operation, the monitoring portion of the relief monitor is designed to move slightly with minor fluctuations in downstream pressure or flow.

SUMMARY

From the foregoing discussion, it becomes obvious that there are many design philosophies available and many choices of equipment to meet overpressure protection requirements. Also, assume the overpressure

device will be called upon to operate sometime after it is installed. The overall design must include an analysis of the conditions created when the protection device operates.

The accompanying table shows:

- What happens when the various types of overpressure protection devices operate
- The type of reaction required
- The effect upon the customer or the public
- Some technical conditions

These are the general characteristics of the various types of safety devices. From the conditions and results shown, it is easier to decide which type of overpressure equipment best meets your needs. Undoubtedly, compromises will have to be made between the conditions shown here and any others which may govern your operating parameters.

Principles of Relief Valves

OVERPRESSURE PROTECTION

Overpressure protection is a primary consideration in the design of any piping system. The objective of overpressure protection is to maintain the pressure downstream of a regulator at a safe maximum value.

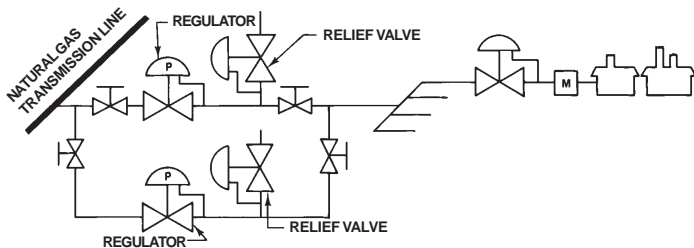

Figure 1. Distribution System

In the system shown in Figure 1, a high-pressure transmission system delivers natural gas through a pressure reducing regulator to a lower pressure system that distributes gas to individual customers. The regulators, the piping, and the devices that consume gas are protected from overpressure by relief valves. The relief valve's setpoint is adjusted to a level established by the lowest maximum pressure rating of any of the lower pressure system components.

MAXIMUM PRESSURE CONSIDERATIONS

Overpressure occurs when the pressure of a system is above the setpoint of the device controlling its pressure. It is evidence of some failure in the system (often the upstream regulator), and it can cause the entire system to fail if it's not limited. To implement overpressure protection, the weakest part in the pressure system is identified and measures are taken to limit overpressure to that component's maximum pressure rating. The most vulnerable components are identified by examining the maximum pressure ratings of the:

- downstream equipment
- low-pressure side of the main regulator
- piping

The lowest maximum pressure rating of the three is the maximum allowable pressure.

Downstream Equipment

The downstream component (appliance, burner, boiler, etc.) with the lowest maximum pressure rating sets the highest pressure that all the downstream equipment can be subjected to.

Main Regulator

Pressure reducing regulators have different pressure ratings which refer to the inlet, outlet, and internal components. The lowest of these should be used when determining the maximum allowable pressure.

Piping

Piping is limited in its ability to contain pressure. In addition to any physical limitations, some applications must also conform to one or more applicable pressure rating codes or regulations.

RELIEF VALVES

Relief involves maintaining the pressure downstream of a regulator at a safe maximum pressure using any device that vents fluid to a lower pressure system (often the atmosphere). Relief valve exhaust must be directed or piped to a safe location. Relief valves perform this function. They are considered to be one of the most reliable types of overpressure protection available and are available in a number of different types. Fisher relief valves are not ASME safety relief valves.



H200 Series Pop Type



Type 289 Direct-Operated



Type 289P-6358 Pilot-Operated



Type 627 with Internal Relief

Figure 2. Types of Relief Valves

Principles of Relief Valves

Relief Valve Popularity

Relief valves are popular for several reasons. They do not block the normal flow through a line. They do not decrease the capacities of the regulators they protect. And, they have the added advantage of being an alarm if they vent to atmosphere.

Relief Valve Types

Relief valves are available in four general types. These include: pop type, direct-operated, pilot-operated, and internal relief valves.

SELECTION CRITERIA

Pressure Buildup

A relief valve has a setpoint at which it begins to open. For the valve to fully open and pass the maximum flow, pressure must build up to some level above the setpoint of the relief valve. This is known as pressure buildup over setpoint, or simply, buildup.

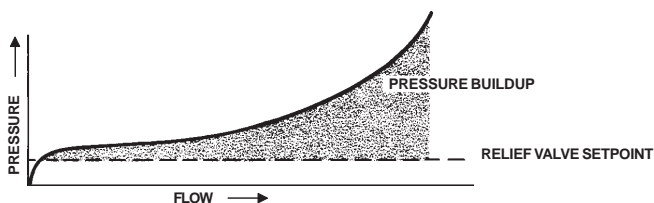

Figure 3. Pressure Buildup

Periodic Maintenance

A relief valve installed in a system that normally performs within design limits is very seldom exercised. The relief valve sits and waits for a failure. If it sits for long periods it may not perform as expected. Disks may stick in seats, setpoints can shift over time, and small passages can become clogged with pipeline debris. Therefore, periodic maintenance and inspection is recommended. Maintenance requirements may influence the selection of a relief valve.

Cost versus Performance

Given several types of relief valves to choose from, selecting one type is generally based on the ability of the valve to provide adequate protection at the most economical cost. Reduced pressure buildup and increased capacity generally come at an increased price.

Installation and Maintenance Considerations

Initial costs are only a part of the overall cost of ownership. Maintenance and installation costs must also be considered over the life of the relief valve. For example, internal relief may be initially more economical than an external relief valve. However, maintaining a regulator with internal relief requires that the system be shut down and the regulator isolated. This may involve additional time and the installation of parallel regulators and relief valves if flow is to be maintained to the downstream system during maintenance operations.

POP TYPE RELIEF VALVE

The most simple type of relief valve is the pop type. They are used wherever economy is the primary concern and some setpoint drift is acceptable.

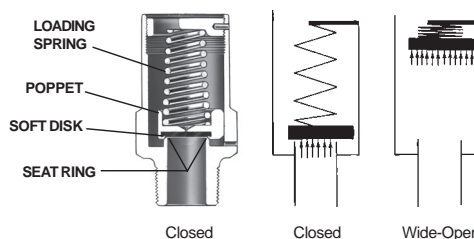

Figure 4. Pop Type Relief Valve Construction and Operation

OPERATION

Pop type relief valves are essentially on-off devices. They operate in either the closed or wide-open position. Pop type designs register pressure directly on a spring-opposed poppet. The poppet assembly includes a soft disk for tight shutoff against the seat ring. When the inlet pressure increases above setpoint, the poppet assembly is pushed away from the seat. As the poppet rises, pressure registers against a greater surface area of the poppet. This dramatically increases the force on the poppet. Therefore, the poppet tends to travel to the fully open position reducing pressure buildup.

Buildup Over Setpoint

Recall that pressure buildup relates capacity to pressure; increasing capacity requires some increase in pressure. In throttling relief valves, pressure buildup is related to accuracy. In pop type relief valves, buildup over setpoint results largely because the device is a restriction to flow rather than the spring rate of the valve's loading spring.

Principles of Relief Valves

Fixed Setpoint

The setpoint of a pop type valve cannot be adjusted by the user. The spring is initially loaded by the manufacturer. A pinned spring retainer keeps the spring in position. This is a safety measure that prevents tampering with the relief valve setpoint.

Typical Applications

This type of relief valve may be used where venting to the atmosphere is acceptable, when the process fluid is compatible with the soft disk, and when relief pressure variations are allowable. They are often used as inexpensive token relief. For example, they may be used simply to provide an audible signal of an overpressure condition.

These relief valves may be used to protect against overpressure stemming from a regulator with a minimal amount of seat leakage. Unchecked, this seat leakage could allow downstream pressure to build to full P_1 over time. The use of a small pop type valve can be installed to protect against this situation.

These relief valves are also commonly installed with a regulator in a natural gas system farm tap, in pneumatic lines used to operate air drills, jackhammers, and other pneumatic equipment, and in many other applications.

Advantages

Pop type relief valves use few parts. Their small size allows installation where space is limited. Also, low initial cost, easy installation, and high capacity per dollar invested can result in economical system relief.

Disadvantages

The setpoint of a pop type relief valve may change over time. The soft disk may stick to the seat ring and cause the pop pressure to increase.

As an on-off device, this style of relief valve does not throttle flow over a pressure range. Because of its on-off nature, this type of relief valve may create pressure surges in the downstream system.

If the relief valve capacity is significantly larger than the failed regulator's capacity, the relief valve may over-compensate each time it opens and closes. This can cause the downstream pressure system to become unstable and cycle. Cycling can damage the relief valve and downstream equipment.

DIRECT-OPERATED RELIEF VALVES

Compared to pop type relief valves, direct-operated relief valves provide throttling action and may require less pressure buildup to open the relief valve.

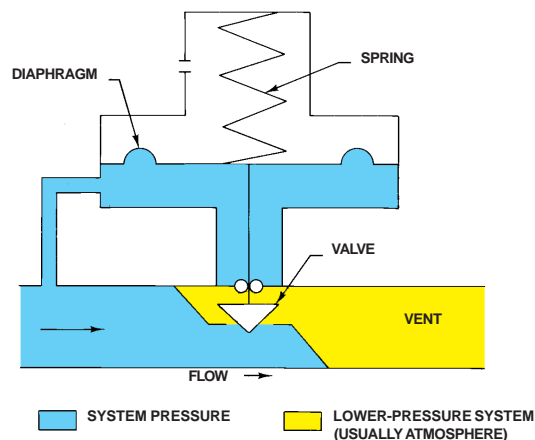

Figure 5. Direct-Operated Relief Valve Schematic

OPERATION

A schematic of a direct-operated relief valve is shown in Figure 5. It looks like an ordinary direct-operated regulator except that it senses upstream pressure rather than downstream pressure. And, it uses a spring-close rather than a spring-open action. It contains the same essential elements as a direct-operated regulator:

- A **diaphragm** that measures system pressure
- A **spring** that provides the initial load to the diaphragm and is used to establish the relief setpoint
- A **valve** that throttles the relief flow

Opening the Valve

As the inlet pressure rises above the setpoint of the relief valve, the diaphragm is pushed upward moving the valve plug away from the seat. This allows fluid to escape.

Pressure Buildup Over Setpoint

As system pressure increases, the relief valve opens wider. This allows more fluid to escape and protects the system. The increase in pressure

Principles of Relief Valves

above the relief setpoint that is required to produce more flow through the relief valve is referred to as pressure buildup. The spring rate and orifice size influence the amount of pressure buildup that is required to fully stroke the valve.

PRODUCT EXAMPLE

Pitot Tube

The relief valve shown in Figure 6 includes a pitot tube to reduce pressure buildup. When the valve is opening, high fluid velocity through the seat ring creates an area of relatively low pressure. Low pressure near the end of the pitot tube draws fluid out of the volume above the relief valve diaphragm and creates a partial vacuum which helps to open the valve. The partial vacuum above the diaphragm increases the relief valve capacity with less pressure buildup over setpoint.

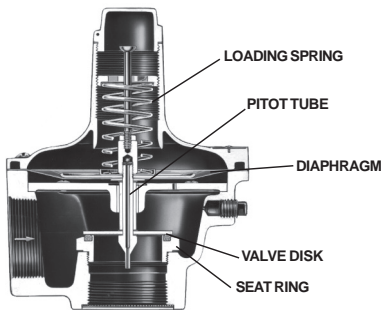

Figure 6. Type 289 Relief Valve with Pitot Tube

Typical Applications

Direct-operated relief valves are commonly used in natural gas systems supplying commercial enterprises such as restaurants and laundries, and in industry to protect industrial furnaces and other equipment.

SELECTION CRITERIA

Pressure Buildup

Some direct-operated relief valves require significant pressure buildup to achieve maximum capacity. Others, such as those using pitot tubes,

often pass high flow rates with minimal pressure buildup. Direct-operated relief valves can provide good accuracy within their design capacities.

Cost versus Performance

The purchase price of a direct-operated relief valve is typically lower than that of a pilot-operated design of the same size. However, pilot-operated designs may cost less per unit of capacity at very high flow rates.

PILOT-OPERATED RELIEF VALVES

Pilot-operated relief valves utilize a pair of direct-operated relief valves; a pilot and a main relief valve. The pilot increases the effect of changes in inlet pressure on the main relief valve.

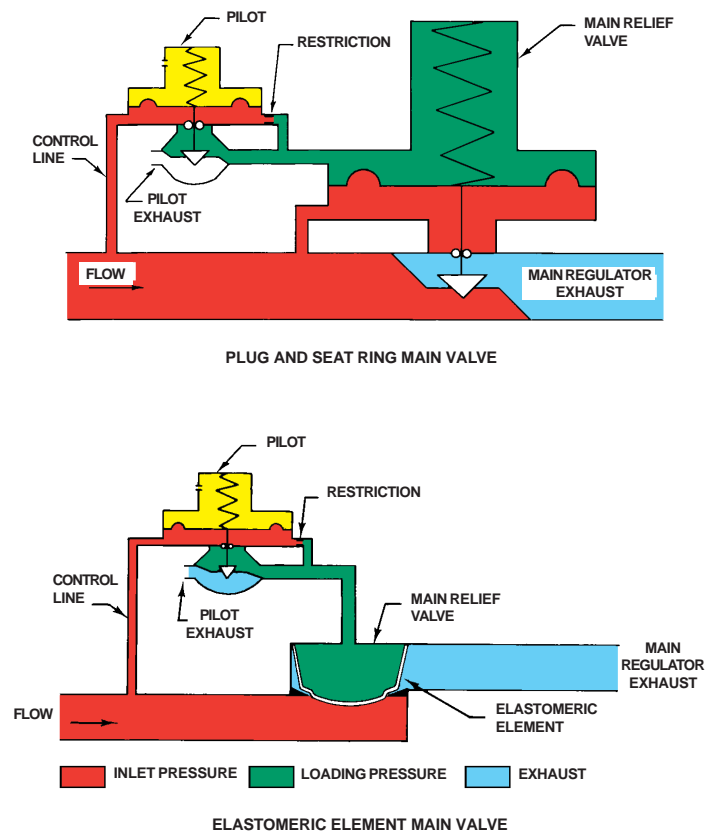

Figure 7. Pilot-Operated Designs

Principles of Relief Valves

OPERATION

The operation of a pilot-operated relief valve is quite similar to the operation of a pilot-operated pressure reducing regulator. In normal operation, when system pressure is below setpoint of the relief valve, the pilot remains closed. This allows loading pressure to register on top of the main relief valve diaphragm. Loading pressure on top of the diaphragm is opposed by an equal pressure (inlet pressure) on the bottom side of the diaphragm. With little or no pressure differential across the diaphragm, the spring keeps the valve seated. Notice that a light rate spring may be used because it does not oppose a large pressure differential across the diaphragm. The light-rate spring enables the main valve to travel to the wide-open position with little pressure buildup.

Increasing Inlet Pressure

When the inlet pressure rises above the relief setpoint, the pilot spring is compressed and the pilot valve opens. The open pilot bleeds fluid out of the main valve spring case, decreasing pressure above the main relief valve diaphragm. If loading pressure escapes faster than it can be replaced through the restriction, the loading pressure above the main relief valve diaphragm is reduced and the relief valve opens. System overpressure exhausts through the vent.

Decreasing Inlet Pressure

If inlet pressure drops back to the relief valve setpoint, the pilot loading spring pushes the pilot valve plug back against the pilot valve seat. Inlet pressure again loads the main relief valve diaphragm and closes the main valve.

Control Line

The control line connects the pilot with the pressure that is to be limited. When overpressure control accuracy is a high priority, the control line tap is installed where protection is most critical.

PRODUCT EXAMPLE

Physical Description

This relief valve is a direct-operated relief valve with a pilot attached (Figure 8). The pilot is a modified direct-operated relief valve, the inlet pressure loads the diaphragm and flows through a restriction to supply loading pressure to the main relief valve diaphragm.

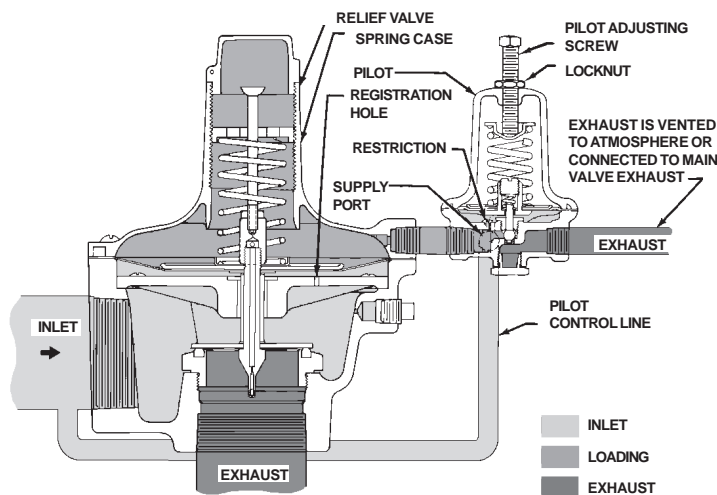

Figure 8. Pilot-Operated Relief Valve

Operation

During normal operation, the pilot is closed allowing loading pressure to register above the main relief valve's diaphragm. This pressure is opposed by inlet pressure acting on the bottom of the diaphragm.

If inlet pressure rises above setpoint, the pilot valve opens, exhausting the loading pressure. If loading pressure is reduced above the main relief valve diaphragm faster than it is replaced through the pilot fixed restriction, loading pressure is reduced and inlet pressure below the diaphragm will cause the main regulator to open.

If inlet pressure falls below the relief set pressure, the pilot spring will again close the pilot exhaust, increasing loading pressure above the main relief valve diaphragm. This increasing loading pressure causes the main valve to travel towards the closed position.

Performance

Pilot-operated relief valves are able to pass large flow rates with a minimum pressure buildup.

Typical Applications

Pilot-operated relief valves are used in applications requiring high capacity and low pressure buildup.

Principles of Relief Valves

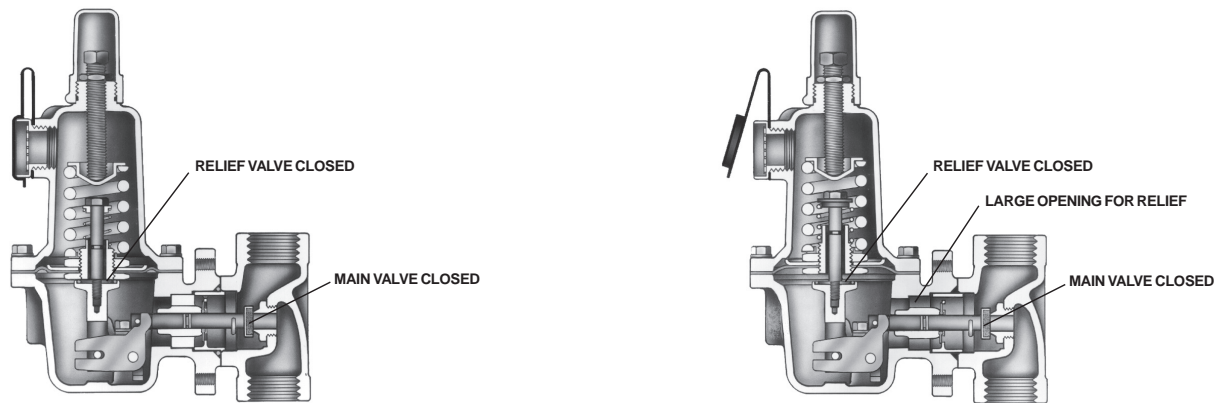

Regulators that include internal relief valves often eliminate the requirement for external overpressure protection. The illustration on the left shows the regulator with both the relief valve and the regulator valve in the closed position. The illustration on the right shows the same unit after P_2 has increased above the relief valve setpoint. The diaphragm has moved off the relief valve seat allowing flow (excess pressure) to exhaust through the screened vent.

Figure 9. Internal Relief Design

SELECTION CRITERIA

Minimal Buildup

The use of a pilot to load and unload the main diaphragm and the light-rate spring enables the main valve to travel wide-open with little pressure buildup over setpoint.

Throttling Action

The sensitive pilot produces smooth throttling action when inlet pressure rises above setpoint. This helps to maintain a steady downstream system pressure.

INTERNAL RELIEF

Regulators that include internal relief valves may eliminate the requirement for external overpressure protection.

OPERATION

The regulator shown in Figure 9 includes an internal relief valve. The relief valve has a measuring element (the main regulator diaphragm), a loading element (a light spring), and a restricting element (a valve seat and disk). The relief valve assembly is located in the center of the regulator diaphragm.

Buildup Over Setpoint

Like other spring-loaded designs, internal relief valves will only open wider if the inlet pressure increases. The magnitude of pressure buildup is determined by the spring rates of the loading spring plus the main spring. Both springs are considered because they act together to resist diaphragm movement when pressure exceeds the relief valve setpoint.

Product Example

A typical internal relief regulator construction is shown in Figure 9. The illustration on the left shows the regulator with both the relief valve and regulator valve in the closed position. The illustration on the right shows the same unit after the inlet pressure has increased above the relief valve setpoint. The diaphragm has moved off the relief valve seat allowing the excess pressure to exhaust through the vent.

Performance and Typical Applications

This design is available in configurations that can protect many pressure ranges and flow rates. Internal relief is often used in applications such as farm taps, industrial applications where atmospheric exhaust is acceptable, and house service regulators.

Principles of Relief Valves

SELECTION CRITERIA

Pressure Buildup

Relief setpoint is determined by a combination of the relief valve and regulator springs; this design generally requires significant pressure buildup to reach its maximum relief flow rate. For the same reason, internal relief valves have limited relief capacities. They may provide full relief capacity, but should be carefully sized for each application.

Space

Internal relief has a distinct advantage when there is not enough space for an external relief valve.

Cost versus Performance

Because a limited number of parts are simply added to the regulator, this type of overpressure protection is relatively inexpensive compared to external relief valves of comparable capacity.

Maintenance

Because the relief valve is an integral part of the regulator's diaphragm, the regulator must be taken out of service when maintenance is performed. Therefore, the application should be able to tolerate either the inconvenience of intermittent supply, or the expense of parallel regulators and relief valves.

SELECTION AND SIZING CRITERIA

There are a number of common steps in the relief valve selection and sizing process. For every application, the maximum pressure conditions, the wide-open regulator flow capacity, and constant downstream demand should be determined. Finally, this information is used to select an appropriate relief valve for the application.

Maximum Allowable Pressure

Downstream equipment includes all the components of the system that contain pressure; household appliances, tanks, tools, machines, outlet rating of the upstream regulators, or other equipment. The component with the lowest maximum pressure rating establishes the maximum allowable system pressure.

Regulator Ratings

Pressure reducing regulators upstream of the relief valve have ratings for their inlet, outlet, and internal components. The lowest rating should be used when determining maximum allowable pressure.

Piping

Piping pressure limitations imposed by governmental agencies, industry standards, manufacturers, or company standards should be verified before defining the maximum overpressure level.

Maximum Allowable System Pressure

The smallest of the pressure ratings mentioned above should be used as the maximum allowable pressure. This pressure level should not be confused with the relief valve setpoint which must be set below the maximum allowable system pressure.

Determining Required Relief Valve Flow

A relief valve must be selected to exhaust enough flow to prevent the pressure from exceeding the maximum allowable system pressure. To determine this flow, review all upstream components for the maximum possible flow that will cause overpressure. If overpressure is caused by a pressure reducing regulator, use the regulator's wide-open flow coefficient to calculate the required flow of the relief valve. This regulator's wide-open flow is larger than the regulating flow used to select the pressure reducing regulator.

Sizing equations have been developed to standardize valve sizing. Refer to the Valve Sizing Calculations section to find these equations and explanations on how they are used.

Determine Constant Demand

In some applications, the required relief capacity can be reduced by subtracting any load that is always on the system. This procedure should be approached with caution because it may be difficult to predict the worst-case scenario for downstream equipment failures. It may also be important to compare the chances of making a mistake in predicting the level of continuous flow consumption with the potential negative aspects of an error. Because of the hazards involved, relief valves are often sized assuming no continuous flow to downstream equipment.

Principles of Relief Valves

SELECTING RELIEF VALVES

Required Information

We have already reviewed the variables required to calculate the regulator's wide-open flow rate. In addition, we need to know the type and temperature of the fluid in the system, and the size of the piping. Finally, if a vent stack will be required, any additional buildup due to vent stack resistance should be considered.

Regulator Lockup Pressure

A relief valve setpoint is adjusted to a level higher than the regulator's lockup pressure. If the relief valve setpoint overlaps lockup pressure of the regulator, the relief valve may open while the regulator is still attempting to control the system pressure.

Identify Appropriate Relief Valves

Once the size, relief pressure, and flow capacity are determined, we can identify a number of potentially suitable relief valves using the Quick Selection Guide in the front of each application section in this handbook. These selection guides give relief set (inlet) pressures, capacities, and type numbers. These guides can then be further narrowed by reviewing individual product pages in each section.

Final Selection

Final selection is usually a matter of compromise. Relief capacities, buildup levels, sensitivity, throttling capabilities, cost of installation and maintenance, space requirements, initial purchase price, and other attributes are all considered when choosing any relief valve.

Applicable Regulations

The relief valves installed in some applications must meet governmental, industry, or company criteria.

SIZING AND SELECTION EXERCISE

To gain a better understanding of the selection and sizing process, it may be helpful to step through a typical relief valve sizing exercise.

Initial Parameters

We'll assume that we need to specify an appropriate relief valve for a regulator serving a large plant air supply. There is sufficient space to install the relief valve and the controlled fluid is clean plant air that can be exhausted without adding a vent stack.

Performance Considerations

The plant supervisor wants the relief valve to throttle open smoothly so that pressure surges will not damage instruments and equipment in the downstream system. This will require the selection of a relief valve that will open smoothly. Plant equipment is periodically shut down but the air supply system operates continuously. Therefore, the relief valve must also have the capacity to exhaust the full flow of the upstream system.

Upstream Regulator

The regulator used is 1 inch in size with a 3/8-inch orifice. The initial system parameters of pressure and flow were determined when the regulator was sized for this application.

Pressure Limits

The plant maintenance engineer has determined that the relief valve should begin to open at 20 psig, and downstream pressure should not rise above 30 psig maximum allowable system pressure.

Relief Valve Flow Capacity

The wide-open regulator flow is calculated to be 23,188 scfh.

Principles of Relief Valves

RELIEF VALVE SELECTION

Quick Selection Guide

Find the Relief Valve Quick Selection Guide in the Air section of this handbook; it gives relief set (inlet) pressures and comparative flow capacities of various relief valves. Since this guide is used to identify potentially suitable relief valves, we can check the relief set (inlet) pressures closest to 20 psig and narrow the range of choices. We find that two relief valves have the required flow capacity at our desired relief set (inlet) pressure.

Product Pages

If we look at the product pages for the potential relief valves, we find that a 1-inch 289H provides the required capacity within the limits of pressure buildup specified in our initial parameters.

Checking Capacity

Capacity curves for the 1-inch Type 289H with this spring are shown in Figure 10. By following the curve for the 20 psig setpoint to the point where it intersects with the 30 psig division, we find that our relief valve can handle more than the 23,188 scfh required.

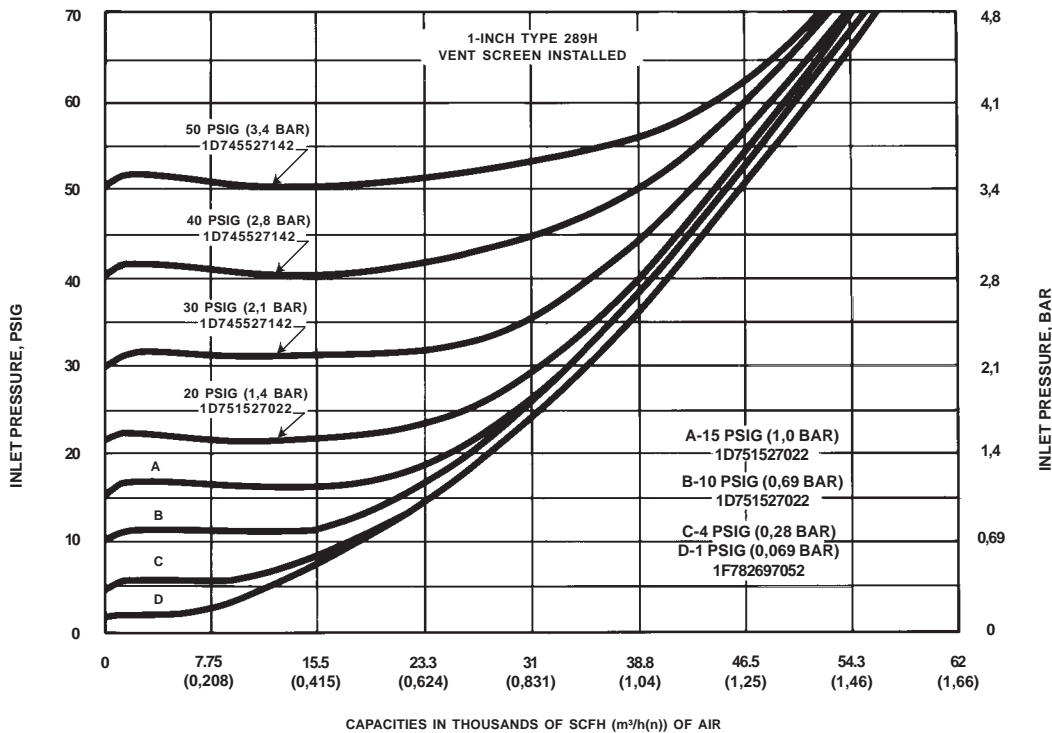

Figure 10. Type 289H Flow Capacities

Principles of Series Regulation and Monitor Regulators

SERIES REGULATION

Series regulation is one of the simplest systems used to provide overpressure protection by containment. In the example shown in Figure 1, the inlet pressure is 100 psig, the desired downstream pressure is 10 psig, and the maximum allowable operating pressure (MAOP) is 40 psig. The setpoint of the downstream regulator is 10 psig, and the setpoint of the upstream regulator is 30 psig.

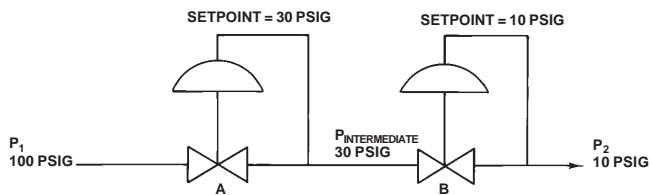

Figure 1. Series Regulation

Failed System Response

If regulator B fails, downstream pressure (P_2) is maintained at the setpoint of regulator A less whatever drop is required to pass the required flow through the failed regulator B. If regulator A fails, the intermediate pressure will be 100 psig. Regulator B must be able to withstand 100 psig inlet pressure.

Regulator Considerations

Either direct-operated or pilot-operated regulators may be used in this system. Should regulator A fail, $P_{\text{intermediate}}$ will approach P_1 so the outlet rating and spring casing rating of regulator A must be high enough to withstand full P_1 . This situation may suggest the use of a relief valve between the two regulators to limit the maximum value of $P_{\text{intermediate}}$.

APPLICATIONS AND LIMITATIONS

A problem with series regulation is maintaining tight control of P_2 if the downstream regulator fails. In this arrangement, it is often impractical to have the setpoints very close together. If they are, the pressure drop across regulator B will be quite small. With a small pressure drop, a very large regulator may be required to pass the desired flow.

Because of the problem in maintaining close control of P_2 , series regulation is best suited to applications where the regulator station is reducing pressure to a value substantially below the maximum allowable operating pressure of the downstream system. Farm taps are a good example. The problem of low-pressure drop across the second regulator is less pronounced in low flow systems.

UPSTREAM WIDE-OPEN MONITORS

The only difference in configuration between series regulation and monitors is that in monitor installations, both regulators sense downstream pressure, P_2 . Thus, the upstream regulator must have a control line.

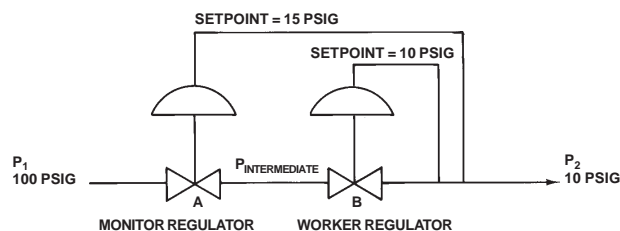

In wide-open monitor systems, both regulators sense downstream pressure. Setpoints may be very close to each other. If the worker regulator fails, the monitor assumes control at a slightly higher setpoint. If the monitor regulator fails, the worker continues to provide control.

Figure 2. Wide-Open Upstream Monitor

System Values

In the example shown in Figure 2, assume that P_1 is 100 psig, and the desired downstream pressure, P_2 , is 10 psig. Also assume that the maximum allowable operating pressure of the downstream system is 20 psig; this is the limit we cannot exceed. The setpoint of the downstream regulator is set at 10 psig to maintain the desired P_2 and the setpoint of the upstream regulator is set at 15 psig to maintain P_2 below the maximum allowable operating pressure.

Normal Operation

When both regulators are functioning properly, regulator B holds P_2 at its setpoint of 10 psig. Regulator A, sensing a pressure lower than its setpoint of 15 psig tries to increase P_2 by going wide-open. This configuration is known as an upstream wide-open monitor where upstream regulator A monitors the pressure established by regulator B. Regulator A is referred to as the monitor or standby regulator while regulator B is called the worker or the operator.

Principles of Series Regulation and Monitor Regulators

Worker Regulator B Fails

If regulator B fails open, regulator A, the monitor, assumes control and holds P_2 at 15 psig. Note that pressure $P_{Intermediate}$ is now P_2 plus whatever drop is necessary to pass the required flow through the failed regulator B.

Equipment Considerations

Wide-open monitoring systems may use either direct- or pilot-operated regulators, the choice of which is dependent on other system requirements. Obviously, the upstream regulator must have external registration capability in order to sense downstream pressure, P_2 .

In terms of ratings, $P_{Intermediate}$ will rise to full P_1 when regulator A fails, so the body outlet of regulator A and the inlet of regulator B must be rated for full P_1 .

DOWNSTREAM WIDE-OPEN MONITORS

The difference between upstream and downstream monitor systems (Figure 3) is that the functions of the two regulators are reversed. In other words, the monitor, or standby regulator, is downstream of the worker, or operator. Systems can be changed from upstream to downstream monitors, and vice-versa, by simply reversing the setpoints of the two regulators.

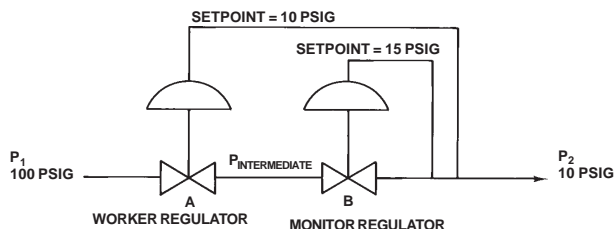

The only difference between upstream wide-open monitor systems and downstream wide-open monitor systems is the role each regulator plays. Workers and monitors may be switched by simply reversing the setpoints.

Figure 3. Wide-Open Downstream Monitor

Normal Operation

Again, assume an inlet pressure of 100 psig and a controlled pressure (P_2) of 10 psig. Regulator A is now the worker so it maintains P_2 at its setpoint of 10 psig. Regulator B, the monitor, is set at 15 psig and so remains open.

Worker Regulator A Fails

If the worker, regulator A, fails in an open position, the monitor, regulator B, senses the increase in P_2 and holds P_2 at its setpoint of 15 psig. Note that $P_{Intermediate}$ is now P_1 minus whatever drop is taken across the failed regulator A.

UPSTREAM VERSUS DOWNSTREAM MONITORS

The decision to use either an upstream or downstream monitor system is largely a matter of personal preference or company policy.

In normal operation, the monitor remains open while the worker is frequently exercised. Many users see value in changing the system from an upstream to a downstream monitor at regular intervals, much like rotating the tires on an automobile. Most fluids have some impurities such as moisture, rust, or other debris, which may deposit on regulator components, such as stems, and cause them to become sticky or bind. Therefore, occasionally reversing the roles of the regulators so that both are exercised is sometimes seen as a means of ensuring that protection is available when needed. The job of switching is relatively simple as only the setpoints of the two regulators are changed. In addition, the act of changing from an upstream to a downstream monitor requires that someone visit the site so there is an opportunity for routine inspection.

WORKING MONITORS

Working monitors (Figure 4) use design elements from both series regulation and wide-open monitors. In a working monitor installation, the two regulators are continuously working as series regulators to take two pressure cuts.

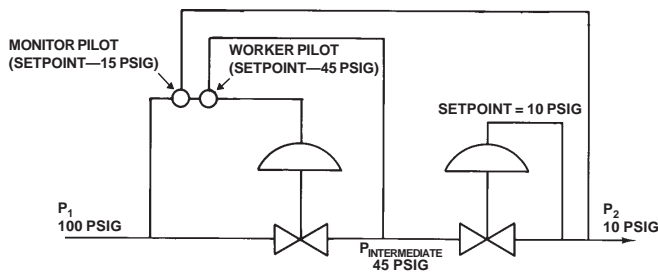

Working monitor systems must use a pilot-operated regulator as the monitor, which is always in the upstream position. Two pilots are used on the monitor regulator; one to control the intermediate pressure and one to monitor the downstream pressure. By taking two pressure drops, both regulators are allowed to exercise.

Figure 4. Working Monitor

Principles of Series Regulation and Monitor Regulators

Downstream Regulator

The downstream regulator may be either direct- or pilot-operated. It is installed just as in a series or wide-open monitor system. Its setpoint controls downstream pressure, P_2 .

Upstream Regulator

The upstream regulator must be a pilot-operated type because it uses two pilots; a monitor pilot and a worker pilot. The worker pilot is connected just as in series regulation and controls the intermediate pressure $P_{\text{Intermediate}}$. Its setpoint (45 psig) is at some intermediate value that allows the system to take two pressure drops. The monitor pilot is in series ahead of the worker pilot and is connected so that it senses downstream pressure, P_2 . The monitor pilot setpoint (15 psig) is set slightly higher than the normal P_2 (10 psig).

Normal Operation

When both regulators are performing properly, downstream pressure is below the setting of the monitor pilot, so it is fully open trying to raise system pressure. Standing wide-open, the monitor pilot allows the worker pilot to control the intermediate pressure, $P_{\text{Intermediate}}$ at 45 psig. The downstream regulator is controlling P_2 at 10 psig.

Downstream Regulator Fails

If the downstream regulator fails, the monitor pilot will sense the increase in pressure and take control at 15 psig.

Upstream Regulator Fails

If the upstream regulator fails, the downstream regulator will remain in control at 10 psig. Note that the downstream regulator must be rated for the full system inlet pressure P_1 of 100 psig because this will be its inlet pressure if the upstream regulator fails. Also note that the outlet rating of the upstream regulator, and any other components that are exposed to $P_{\text{Intermediate}}$, must be rated for full P_1 .

SIZING MONITOR REGULATORS

The difficult part of sizing monitor regulators is that $P_{\text{Intermediate}}$ is needed to determine the flow capacity for both regulators. Because $P_{\text{Intermediate}}$ is not available, other sizing methods are used to determine the capacity. There are three methods for sizing monitor regulators: estimating flow when pressure drop is critical, assuming $P_{\text{Intermediate}}$ to calculate flow, and the Fisher Monitor Sizing Program.

Estimating Flow when Pressure Drop is Critical

If the pressure drop across both regulators from P_1 to P_2 is critical (assume $P_{\text{Intermediate}} = P_1 - P_2/2 + P_2$, $P_1 - P_{\text{Intermediate}} \geq P_1$, and $P_{\text{Intermediate}} - P_2 \geq 1/2 P_{\text{Intermediate}}$), and both regulators are the same type, the capacity of the two regulators together is 70 to 73 percent of a single regulator reducing the pressure from P_1 to P_2 .

Assuming $P_{\text{Intermediate}}$ to Determine Flow

Assume $P_{\text{Intermediate}}$ is halfway between P_1 and P_2 . Guess a regulator size. Use the assumed $P_{\text{Intermediate}}$ and the C_g for each regulator to calculate the available flow rate for each regulator. If $P_{\text{Intermediate}}$ was correct, the calculated flow through each regulator will be the same. If the flows are not the same, change $P_{\text{Intermediate}}$ and repeat the calculations. ($P_{\text{Intermediate}}$ will go to the correct assumed pressure whenever the flow demand reaches maximum capacity.)

Fisher Monitor Sizing Program

Fisher offers a Monitor Sizing Program on the Fisher Regulator CD. Call your Fisher Sales Representative to request a copy.

Valve Sizing Calculations

INTRODUCTION

Improper valve sizing can be both expensive and inconvenient. A valve that is too small will not pass the required flow, and the process will be starved. An oversized valve will be more expensive, and it may lead to instability and other problems.

The days of selecting a valve based upon the size of the pipeline are gone. Selecting the correct valve size for a given application requires a knowledge of process conditions that the valve will actually see in service. The technique for using this information to size the valve is based upon a combination of theory and experimentation.

SIZING FOR LIQUID SERVICE

Using the principle of conservation of energy, Daniel Bernoulli found that as a liquid flows through an orifice, the square of the fluid velocity is directly proportional to the pressure differential across the orifice and inversely proportional to the specific gravity of the fluid. The greater the pressure differential, the higher the velocity; the greater the density, the lower the velocity. The volume flow rate for liquids can be calculated by multiplying the fluid velocity times the flow area.

By taking into account units of measurement, the proportionality relationship previously mentioned, energy losses due to friction and turbulence, and varying discharge coefficients for various types of orifices (or valve bodies), a basic liquid sizing equation can be written as follows:

$$Q = C_v \sqrt{\Delta P / G} \quad (1)$$

where:

- Q = Capacity in gallons per minute
- C_v = Valve sizing coefficient determined experimentally for each style and size of valve, using water at standard conditions as the test fluid
- ΔP = Pressure differential in psi
- G = Specific gravity of fluid (water at 60°F = 1.0000)

Thus, C_v is numerically equal to the number of U.S. gallons of water at 60°F that will flow through the valve in one minute when the pressure differential across the valve is one pound per square inch. C_v varies with both size and style of valve, but provides an index for comparing liquid capacities of different valves under a standard set of conditions.

To aid in establishing uniform measurement of liquid flow capacity coefficients (C_v) among valve manufacturers, the Fluid Controls Institute (FCI) developed a standard test piping arrangement, shown in Figure 1. Using such a piping arrangement, most valve manufacturers

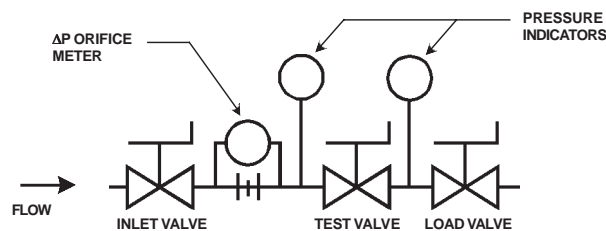

Figure 1. Standard FCI Test Piping for C_v Measurement

develop and publish C_v information for their products, making it relatively easy to compare capacities of competitive products.

To calculate the expected C_v for a valve controlling water or other liquids that behave like water, the basic liquid sizing equation above can be re-written as follows:

$$C_v = Q \sqrt{\frac{G}{\Delta P}} \quad (2)$$

Viscosity Corrections

Viscous conditions can result in significant sizing errors in using the basic liquid sizing equation, since published C_v values are based on test data using water as the flow medium. Although the majority of valve applications will involve fluids where viscosity corrections can be ignored, or where the corrections are relatively small, fluid viscosity should be considered in each valve selection.

Fisher has developed a nomograph (Figure 2) that provides a viscosity correction factor (F_v). It can be applied to the standard C_v coefficient to determine a corrected coefficient (C_{vr}) for viscous applications.

Finding Valve Size

Using the C_v determined by the basic liquid sizing equation and the flow and viscosity conditions, a fluid Reynolds number can be found by using the nomograph in Figure 2. The graph of Reynolds number vs. viscosity correction factor (F_v) is used to determine the correction factor needed. (If the Reynolds number is greater than 3500, the correction will be ten percent or less.) The actual required C_v (C_{vr}) is found by the equation:

$$C_{vr} = F_v C_v \quad (3)$$

From the valve manufacturer's published liquid capacity information, select a valve having a C_v equal to or higher than the required coefficient (C_{vr}) found by the equation above.

Valve Sizing Calculations

INDEX

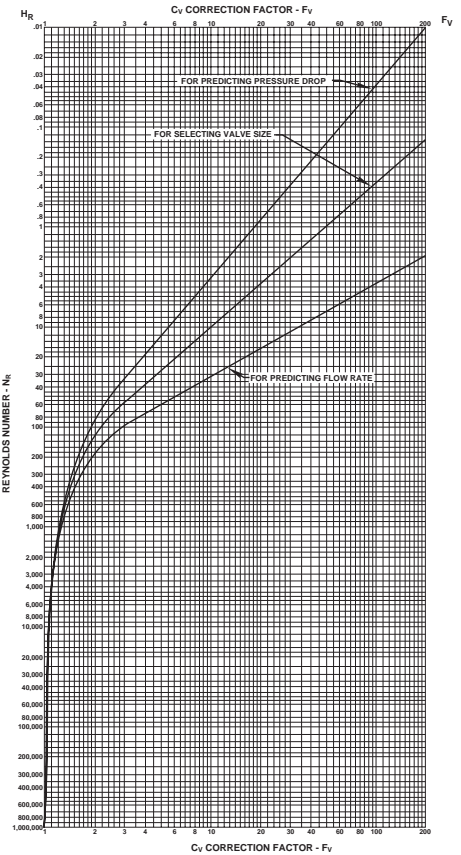
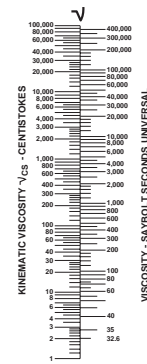
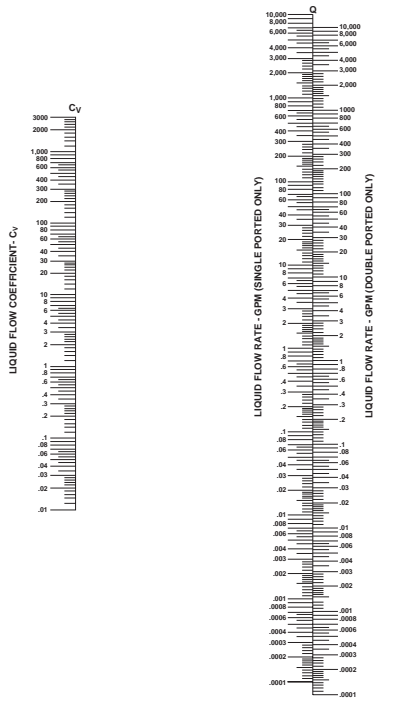

NOMOGRAPH INSTRUCTIONS

Use this nomograph to correct for the effects of viscosity. When assembling data, all units must correspond to those shown on the nomograph. For high-recovery, ball-type valves, use the liquid flow rate Q scale designated for single-ported valves. For butterfly and eccentric disk rotary valves, use the liquid flow rate Q scale designated for double-ported valves.

NOMOGRAPH EQUATIONS

1. Single-Ported Valves:
$$N_R = 17250 \frac{Q}{\sqrt{C_v v_{cs}}}$$
2. Double-Ported Valves:
$$N_R = 12200 \frac{Q}{\sqrt{C_v v_{cs}}}$$

NOMOGRAPH PROCEDURE

1. Lay a straight edge on the liquid sizing coefficient on C_v scale and flow rate on Q scale. Mark intersection on index line. Procedure A uses value of C_{vC} ; Procedures B and C use value of C_{vV} .
2. Pivot the straight edge from this point of intersection with index line to liquid viscosity on proper V scale. Read Reynolds number on N_R scale.
3. Proceed horizontally from intersection on N_R scale to proper curve, and then vertically upward or downward to F_v scale. Read C_v correction factor on F_v scale.

Figure 2. Nomograph for Determining Viscosity Correction

Valve Sizing Calculations

Predicting Flow Rate

Select the required liquid sizing coefficient (C_{vr}) from the manufacturer's published liquid sizing coefficients (C_v) for the style and size valve being considered. Calculate the maximum flow rate (Q_{max}) in gallons per minute (assuming no viscosity correction required) using the following adaptation of the basic liquid sizing equation:

$$Q_{max} = C_{vr} \sqrt{\Delta P / G} \quad (4)$$

Then incorporate viscosity correction by determining the fluid Reynolds number and correction factor F_v from the viscosity correction nomograph and the procedure included on it.

Calculate the predicted flow rate (Q_{pred}) using the formula:

$$Q_{pred} = \frac{Q_{max}}{F_v} \quad (5)$$

Predicting Pressure Drop

Select the required liquid sizing coefficient (C_{vr}) from the published liquid sizing coefficients (C_v) for the valve style and size being considered. Determine the Reynolds number and correct factor F_v from the nomograph and the procedure on it. Calculate the sizing coefficient (C_{vc}) using the formula:

$$C_{vc} = \frac{C_{vr}}{F_v} \quad (6)$$

Calculate the predicted pressure drop (ΔP_{pred}) using the formula:

$$\Delta P_{pred} = G (Q / C_{vc})^2 \quad (7)$$

Flashing and Cavitation

The occurrence of flashing or cavitation within a valve can have a significant effect on the valve sizing procedure. These two related physical phenomena can limit flow through the valve in many applications and must be taken into account in order to accurately size a valve. Structural damage to the valve and adjacent piping may also result. Knowledge of what is actually happening within the valve may permit selection of a size or style of valve which can reduce, or compensate for, the undesirable effects of flashing or cavitation.

The "physical phenomena" label is used to describe flashing and cavitation because these conditions represent actual changes in the form

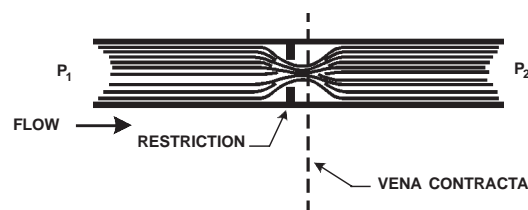

Figure 3. Vena Contracta

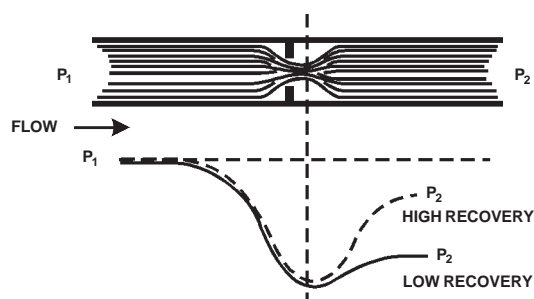

Figure 4. Comparison of Pressure Profiles for High and Low Recovery Valves

of the fluid media. The change is from the liquid state to the vapor state and results from the increase in fluid velocity at or just downstream of the greatest flow restriction, normally the valve port. As liquid flow passes through the restriction, there is a necking down, or contraction, of the flow stream. The minimum cross-sectional area of the flow stream occurs just downstream of the actual physical restriction at a point called the vena contracta, as shown in Figure 3.

To maintain a steady flow of liquid through the valve, the velocity must be greatest at the vena contracta, where cross sectional area is the least. The increase in velocity (or kinetic energy) is accompanied by a substantial decrease in pressure (or potential energy) at the vena contracta. Further downstream, as the fluid stream expands into a larger area, velocity decreases and pressure increases. But, of course, downstream pressure never recovers completely to equal the pressure that existed upstream of the valve. The pressure differential (ΔP) that exists across the valve is a measure of the amount of energy that was dissipated in the valve. Figure 4 provides a pressure profile explaining the differing performance of a streamlined high recovery valve, such as a ball valve and a valve with lower recovery capabilities due to greater internal turbulence and dissipation of energy.

Regardless of the recovery characteristics of the valve, the pressure differential of interest pertaining to flashing and cavitation is the

Valve Sizing Calculations

differential between the valve inlet and the vena contracta. If pressure at the vena contracta should drop below the vapor pressure of the fluid (due to increased fluid velocity at this point) bubbles will form in the flow stream. Formation of bubbles will increase greatly as vena contracta pressure drops further below the vapor pressure of the liquid. At this stage, there is no difference between flashing and cavitation, but the potential for structural damage to the valve definitely exists.

If pressure at the valve outlet remains below the vapor pressure of the liquid, the bubbles will remain in the downstream system and the process is said to have “flashed.” Flashing can produce serious erosion damage to the valve trim parts and is characterized by a smooth, polished appearance of the eroded surface. Flashing damage is normally greatest at the point of highest velocity, which is usually at or near the seat line of the valve plug and seat ring.

However, if downstream pressure recovery is sufficient to raise the outlet pressure above the vapor pressure of the liquid, the bubbles will collapse, or implode, producing cavitation. Collapsing of the vapor bubbles releases energy and produces a noise similar to what one would expect if gravel were flowing through the valve. If the bubbles collapse in close proximity to solid surfaces, the energy released gradually wears the material leaving a rough, cinderlike surface. Cavitation damage may extend to the downstream pipeline, if that is where pressure recovery occurs and the bubbles collapse. Obviously, “high recovery” valves tend to be more subject to cavitation, since the downstream pressure is more likely to rise above the liquid’s vapor pressure.

Choked Flow

Aside from the possibility of physical equipment damage due to flashing or cavitation, formation of vapor bubbles in the liquid flowstream causes a crowding condition at the vena contracta which tends to limit flow through the valve. So, while the basic liquid sizing equation implies that there is no limit to the amount of flow through a valve as long as the differential pressure across the valve increases, the realities of flashing and cavitation prove otherwise. If valve pressure drop is increased slightly beyond the point where bubbles begin to form, a choked flow condition is reached. With constant upstream pressure, further increases in pressure drop (by reducing downstream pressure) will not produce increased flow. The limiting pressure differential is designated ΔP_{allow} and the valve recovery coefficient (K_m) is experimentally determined for each valve, in order to relate choked flow for that particular valve to the basic liquid sizing equation. K_m is normally published with other valve capacity coefficients. Figures 4 and 5 show these flow vs. pressure drop relationships.

Use the following equation to determine maximum allowable pressure drop that is effective in producing flow. Keep in mind, however, that

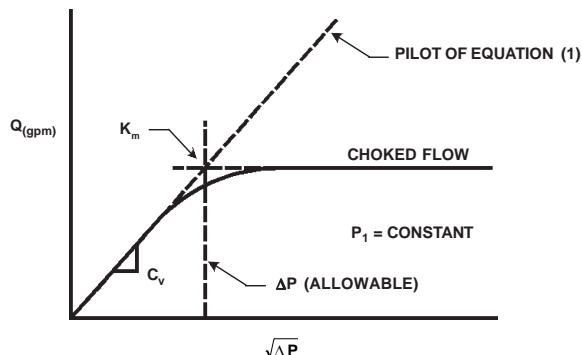

Figure 5. Flow Curve Showing C_v and K_m

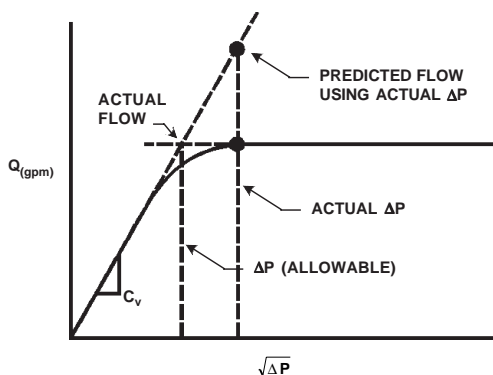

Figure 6. Relationship Between Actual ΔP and ΔP Allowable

the limitation on the sizing pressure drop, ΔP_{allow} , does not imply a maximum pressure drop that may be controlled by the valve.

$$\Delta P_{allow} = K_m (P_1 - r_c P_v) \quad (8)$$

where:

ΔP_{allow} = maximum allowable differential pressure for sizing purposes, psi

K_m = valve recovery coefficient from manufacturer’s literature

P_1 = body inlet pressure, psia

r_c = critical pressure ratio determined from Figures 7 and 8

P_v = vapor pressure of the liquid at body inlet temperature, psia (vapor pressures and critical pressures for many common liquids are provided in the Physical Constants of Hydrocarbons and Physical Constants of Fluids tables; refer to the Table of Contents on page K-i for the page number).

Valve Sizing Calculations

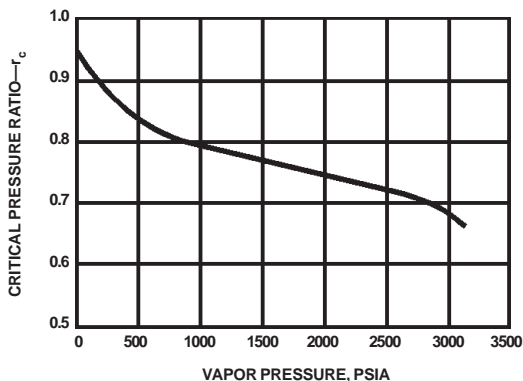

Use this curve for water. Enter on the abscissa at the water vapor pressure at the valve inlet. Proceed vertically to intersect the curve. Move horizontally to the left to read the critical pressure ratio, r_c , on the ordinate.

Figure 7. Critical Pressure Ratios for Water

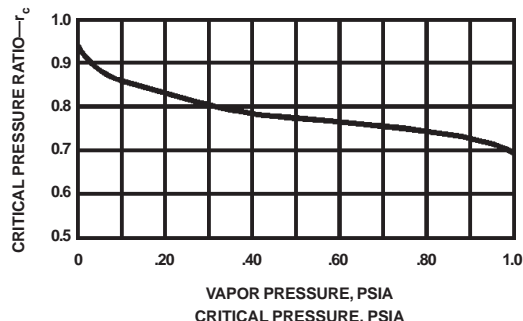

Use this curve for liquids other than water. Determine the vapor pressure/critical pressure ratio by dividing the liquid vapor pressure at the valve inlet by the critical pressure of the liquid. Enter on the abscissa at the ratio just calculated and proceed vertically to intersect the curve. Move horizontally to the left and read the critical pressure ratio, r_c , on the ordinate.

Figure 8. Critical Pressure Ratios for Liquid Other than Water

After calculating ΔP_{allow} , substitute it into the basic liquid sizing equation $Q = C_v \sqrt{\Delta P/G}$ to determine either Q or C_v . If the actual ΔP is less than the ΔP_{allow} , then the actual ΔP should be used in the equation.

The equation used to determine ΔP_{allow} should also be used to calculate the valve body differential pressure at which significant cavitation can occur. Minor cavitation will occur at a slightly lower pressure differential than that predicted by the equation, but should produce negligible damage in most globe-style control valves.

Consequently, it can be seen that initial cavitation and choked flow occur nearly simultaneously in globe-style or low-recovery valves.

However, in high-recovery valves such as ball or butterfly valves, significant cavitation can occur at pressure drops below that which produces choked flow. So while ΔP_{allow} and K_m are useful in predicting choked flow capacity, a separate cavitation index (K_c) is needed to determine the pressure drop at which cavitation damage will begin (ΔP_c) in high-recovery valves.

The equation can be expressed:

$$\Delta P_c = K_c (P_1 - P_v) \tag{9}$$

This equation can be used anytime outlet pressure is greater than the vapor pressure of the liquid.

Addition of anti-cavitation trim tends to increase the value of K_m . In other words, choked flow and insipient cavitation will occur at substantially higher pressure drops than was the case without the anti-cavitation accessory.

Liquid Sizing Summary

The most common use of the basic liquid sizing equation is to determine the proper valve size for a given set of service conditions. The first step is to calculate the required C_v by using the sizing equation. The ΔP used in the equation must be the actual valve pressure drop or ΔP_{allow} , whichever is smaller. The second step is to select a valve, from the manufacturer's literature, with a C_v equal to or greater than the calculated value.

Accurate valve sizing for liquids requires use of the dual coefficients of C_v and K_m . A single coefficient is not sufficient to describe both the capacity and the recovery characteristics of the valve. Also, use of the additional cavitation index factor K_c is appropriate in sizing high recovery valves, which may develop damaging cavitation at pressure drops well below the level of the choked flow.

Valve Sizing Calculations

Liquid Sizing Equation Application		
EQUATION		APPLICATION
1	$Q = C_v \sqrt{\Delta P / G}$	Basic liquid sizing equation. Use to determine proper valve size for a given set of service conditions. (Remember that viscosity effects and valve recovery capabilities are not considered in this basic equation.)
2	$C_v = Q \sqrt{\frac{G}{\Delta P}}$	Use to calculate expected C_v for valve controlling water or other liquids that behave like water.
3	$C_{vr} = F_v C_v$	Use to find actual required C_v for equation (2) after including viscosity correction factor.
4	$Q_{max} = C_{vr} \sqrt{\Delta P / G}$	Use to find maximum flow rate assuming no viscosity correction is necessary.
5	$Q_{pred} = \frac{Q_{max}}{F_v}$	Use to predict actual flow rate based on equation (4) and viscosity factor correction.
6	$C_{vc} = \frac{C_{vr}}{F_v}$	Use to calculate corrected sizing coefficient for use in equation (7).
7	$\Delta P_{pred} = G (Q / C_{vc})^2$	Use to predict pressure drop for viscous liquids.
8	$\Delta P_{allow} = K_m (P_1 - r_c P_v)$	Use to determine maximum allowable pressure drop that is effective in producing flow.
9	$\Delta P_c = K_c (P_1 - P_v)$	Use to predict pressure drop at which cavitation will begin in a valve with high recovery characteristics.

Liquid Sizing Nomenclature

- | | |
|----------------------------------------------------------------------------------------------------------------------------------------------------------------------------------------------------------------------------------------------------------------------------------------------------------------------------------------------------------------------------------------------------------------------------------------------------------------------------------------------------------------------------------------------------------------------------------------------------------------------------------------------------------------------------------------------------------|----------------------------------------------------------------------------------------------------------------------------------------------------------------------------------------------------------------------------------------------------------------------------------------------------------------------------------------------------------------------------------------------------------------------------------------------------------------------------------------------------------------------------------------------------------------------------------------------------------------------------------------------------------------------------------------------------------------------------------------------------------------------------|
| <p>C_v = valve sizing coefficient for liquid determined experimentally for each size and style of valve, using water at standard conditions as the test fluid</p> <p>C_{vc} = calculated C_v coefficient including correction for viscosity</p> <p>C_{vr} = corrected sizing coefficient required for viscous applications</p> <p>ΔP = differential pressure, psi</p> <p>ΔP_{allow} = maximum allowable differential pressure for sizing purposes, psi</p> <p>ΔP_c = pressure differential at which cavitation damage begins, psi</p> <p>F_v = viscosity correction factor</p> | <p>G = specific gravity of fluid (water at 60°F = 1.0000)</p> <p>K_c = dimensionless cavitation index used in determining ΔP_c</p> <p>K_m = valve recovery coefficient from manufacturer's literature</p> <p>P_1 = body inlet pressure, psia</p> <p>P_v = vapor pressure of liquid at body inlet temperature, psia</p> <p>Q = flow rate capacity, gallons per minute</p> <p>Q_{max} = designation for maximum flow rate, assuming no viscosity correction required, gallons per minute</p> <p>Q_{pred} = predicted flow rate after incorporating viscosity correction, gallons per minute</p> <p>r_c = critical pressure ratio</p> |
|----------------------------------------------------------------------------------------------------------------------------------------------------------------------------------------------------------------------------------------------------------------------------------------------------------------------------------------------------------------------------------------------------------------------------------------------------------------------------------------------------------------------------------------------------------------------------------------------------------------------------------------------------------------------------------------------------------|----------------------------------------------------------------------------------------------------------------------------------------------------------------------------------------------------------------------------------------------------------------------------------------------------------------------------------------------------------------------------------------------------------------------------------------------------------------------------------------------------------------------------------------------------------------------------------------------------------------------------------------------------------------------------------------------------------------------------------------------------------------------------|

Valve Sizing Calculations

SIZING FOR GAS OR STEAM SERVICE

A sizing procedure for gases can be established based on adaptations of the basic liquid sizing equation. By introducing conversion factors to change flow units from gallons per minute to cubic feet per hour and to relate specific gravity in meaningful terms of pressure, an equation can be derived for the flow of air at 60°F. Since 60°F corresponds to 520° on the Rankine absolute temperature scale, and since the specific gravity of air at 60°F is 1.0, an additional factor can be included to compare air at 60°F with specific gravity (G) and absolute temperature (T) of any other gas. The resulting equation can be written:

$$Q_{scfh} = 59.64 C_v P_1 \sqrt{\frac{\Delta P}{P_1}} \sqrt{\frac{520}{GT}} \quad (A)$$

The equation shown above, while valid at very low pressure drop ratios, has been found to be very misleading when the ratio of pressure drop (ΔP) to inlet pressure (P_1) exceeds 0.02. The deviation of actual flow capacity from the calculated flow capacity is indicated in Figure 8 and results from compressibility effects and critical flow limitations at increased pressure drops.

Critical flow limitation is the more significant of the two problems mentioned. Critical flow is a choked flow condition caused by increased gas velocity at the vena contracta. When velocity at the vena contracta reaches sonic velocity, additional increases in ΔP by reducing downstream pressure produce no increase in flow. So, after critical flow condition is reached (whether at a pressure drop/inlet pressure ratio of about 0.5 for globe valves or at much lower ratios for high recovery valves) the equation above becomes completely useless. If applied, the C_v equation gives a much higher indicated capacity than actually will exist. And in the case of a high recovery valve which reaches critical flow at a low pressure drop ratio (as indicated in Figure 8), the critical flow capacity of the valve may be over-estimated by as much as 300 percent.

The problems in predicting critical flow with a C_v -based equation led to a separate gas sizing coefficient based on air flow tests. The coefficient (C_g) was developed experimentally for each type and size of valve to relate critical flow to absolute inlet pressure. By including the correction factor used in the previous equation to compare air at 60°F with other gases at other absolute temperatures, the critical flow equation can be written:

$$Q_{critical} = C_g P_1 \sqrt{520 / GT} \quad (B)$$

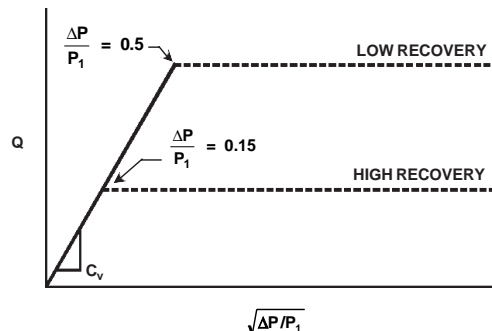

Figure 9. Critical Flow for High and Low Recovery Valves with Equal C_v

Universal Gas Sizing Equation

To account for differences in flow geometry among valves, equations (A) and (B) were consolidated by the introduction of an additional factor (C_1). C_1 is defined as the ratio of the gas sizing coefficient and the liquid sizing coefficient and provides a numerical indicator of the valve's recovery capabilities. In general, C_1 values can range from about 16 to 37, based on the individual valve's recovery characteristics. As shown in the example, two valves with identical flow areas and identical critical flow (C_g) capacities can have widely differing C_1 values dependent on the effect internal flow geometry has on liquid flow capacity through each valve. Example:

High Recovery Valve

$$\begin{aligned} C_g &= 4680 \\ C_v &= 254 \\ C_1 &= C_g / C_v \\ &= 4680 / 254 \\ &= 18.4 \end{aligned}$$

Low Recovery Valve

$$\begin{aligned} C_g &= 4680 \\ C_v &= 135 \\ C_1 &= C_g / C_v \\ &= 4680 / 135 \\ &= 34.7 \end{aligned}$$

Valve Sizing Calculations

So we see that two sizing coefficients are needed to accurately size valves for gas flow— C_g to predict flow based on physical size or flow area, and C_1 to account for differences in valve recovery characteristics. A blending equation, called the Universal Gas Sizing Equation, combines equations (A) and (B) by means of a sinusoidal function, and is based on the “perfect gas” laws. It can be expressed in either of the following manners:

$$Q_{scfh} = \sqrt{\frac{520}{GT}} C_g P_1 \text{ SIN} \left[\left(\frac{59.64}{C_1} \right) \sqrt{\frac{\Delta P}{P_1}} \right] \text{ rad.} \quad (C)$$

OR

$$Q_{scfh} = \sqrt{\frac{520}{GT}} C_g P_1 \text{ SIN} \left[\left(\frac{3417}{C_1} \right) \sqrt{\frac{\Delta P}{P_1}} \right] \text{ Deg.} \quad (D)$$

In either form, the equation indicates critical flow when the sine function of the angle designated within the brackets equals unity. The pressure drop ratio at which critical flow occurs is known as the critical pressure drop ratio. It occurs when the sine angle reaches $\pi/2$ radians in equation (C) or 90 degrees in equation (D). As pressure drop across the valve increases, the sine angle increases from zero up to $\pi/2$ radians (90°). If the angle were allowed to increase further, the equations would predict a decrease in flow. Since this is not a realistic situation, the angle must be limited to 90 degrees maximum.

Although “perfect gases,” as such, do not exist in nature, there are a great many applications where the Universal Gas Sizing Equation, (C) or (D), provides a very useful and usable approximation.

General Adaptation for Steam and Vapors

The density form of the Universal Gas Sizing Equation is the most general form and can be used for both perfect and non-perfect gas applications. Applying the equation requires knowledge of one additional condition not included in previous equations, that being the inlet gas, steam, or vapor density (d_1) in pounds per cubic foot. (Steam density can be determined from tables.)

Then the following adaptation of the Universal Gas Sizing Equation can be applied:

$$Q_{lb/hr} = 1.06 \sqrt{d_1 P_1} C_g \text{ SIN} \left(\frac{3417}{C_1} \right) \sqrt{\frac{\Delta P}{P_1}} \text{ Deg.} \quad (E)$$

Special Equation Form for Steam Below 1000 psig

If steam applications do not exceed 1000 psig, density changes can be compensated for by using a special adaptation of the Universal Gas Sizing Equation. It incorporates a factor for amount of superheat in degrees Fahrenheit (T_{sh}) and also a sizing coefficient (C_s) for steam. **Equation (F) eliminates the need for finding the density of superheated steam, which was required in Equation (E). At pressures below 1000 psig, a constant relationship exists between the gas sizing coefficient (C_g) and the steam coefficient (C_s). This relationship can be expressed: $C_s = C_g/20$. For higher steam pressure applications, use Equation (E).**

$$Q_{lb/hr} = \left[\left(\frac{C_s P_1}{1 + 0.00065 T_{sh}} \right) \right] \text{ SIN} \left[\left(\frac{3417}{C_1} \right) \sqrt{\frac{\Delta P}{P_1}} \right] \text{ Deg.} \quad (F)$$

Gas and Steam Sizing Summary

The Universal Gas Sizing Equation can be used to determine the flow of gas through any style of valve. Absolute units of temperature and pressure must be used in the equation. When the critical pressure drop ratio causes the sine angle to be 90 degrees, the equation will predict the value of the critical flow. For service conditions that would result in an angle of greater than 90 degrees, the equation must be limited to 90 degrees in order to accurately determine the critical flow.

Most commonly, the Universal Gas Sizing Equation is used to determine proper valve size for a given set of service conditions. The first step is to calculate the required C_g by using the Universal Gas Sizing Equation. The second step is to select a valve from the manufacturer’s literature. The valve selected should have a C_g which equals or exceeds the calculated value. Be certain that the assumed C_1 value for the valve is selected from the literature.

It is apparent that accurate valve sizing for gases that requires use of the dual coefficient is not sufficient to describe both the capacity and the recovery characteristics of the valve.

Proper selection of a control valve for gas service is a highly technical problem with many factors to be considered. Leading valve manufacturers provide technical information, test data, sizing catalogs, nomographs, sizing slide rules, and computer or calculator programs that make valve sizing a simple and accurate procedure.

Valve Sizing Calculations

Gas and Steam Sizing Equation Application		
EQUATION	APPLICATION	
A	$Q_{scfh} = 59.64 C_v P_1 \sqrt{\frac{\Delta P}{P_1}} \sqrt{\frac{520}{GT}}$	Use only at very low pressure drop (DP/P_1) ratios of 0.02 or less.
B	$Q_{critical} = C_g P_1 \sqrt{520 / GT}$	Use only to determine critical flow capacity at a given inlet pressure.
C	$Q_{scfh} = \sqrt{\frac{520}{GT}} C_g P_1 \sin \left[\left(\frac{59.64}{C_1} \right) \sqrt{\frac{\Delta P}{P_1}} \right] \text{ rad.}$	Universal Gas Sizing Equation. Use to predict flow for either high or low recovery valves, for any gas adhering to the perfect gas laws, and under any service conditions.
D	$Q_{scfh} = \sqrt{\frac{520}{GT}} C_g P_1 \sin \left[\left(\frac{3417}{C_1} \right) \sqrt{\frac{\Delta P}{P_1}} \right] \text{ Deg.}$	
E	$Q_{lb/hr} = 1.06 \sqrt{d_1 P_1} C_g \sin \left(\frac{3417}{C_1} \right) \sqrt{\frac{\Delta P}{P_1}} \text{ Deg.}$	Use to predict flow for perfect or non-perfect gas sizing applications, for any vapor including steam, at any service condition when fluid density is known.
F	$Q_{lb/hr} = \left[\left(\frac{C_s P_1}{1 + 0.00065 T_{sh}} \right) \right] \sin \left[\left(\frac{3417}{C_1} \right) \sqrt{\frac{\Delta P}{P_1}} \right] \text{ Deg.}$	Use only to determine steam flow when inlet pressure is 1000 psig or less.

Gas and Steam Sizing Nomenclature

- $C_1 = C_g / C_v$
- $C_g =$ gas sizing coefficient
- $C_s =$ steam sizing coefficient, $C_g / 20$
- $C_v =$ liquid sizing coefficient
- $d_1 =$ density of steam or vapor at inlet, pounds/cu. foot
- $G =$ gas specific gravity (air = 1.0)
- $P_1 =$ valve inlet pressure, psia

- $\Delta P =$ pressure drop across valve, psi
- $Q_{critical} =$ critical flow rate, scfh
- $Q_{scfh} =$ gas flow rate, scfh
- $Q_{lb/hr} =$ steam or vapor flow rate, pounds per hour
- $T =$ absolute temperature of gas at inlet, degrees Rankine
- $T_{sh} =$ degrees of superheat, °F

Vacuum Control

VACUUM APPLICATIONS

Vacuum regulators and vacuum breakers are widely used in process plants. However, there is little application information available from regulator manufacturers. Conventional regulators and relief valves are suitable for vacuum service if applied correctly. This section provides fundamentals and examples.

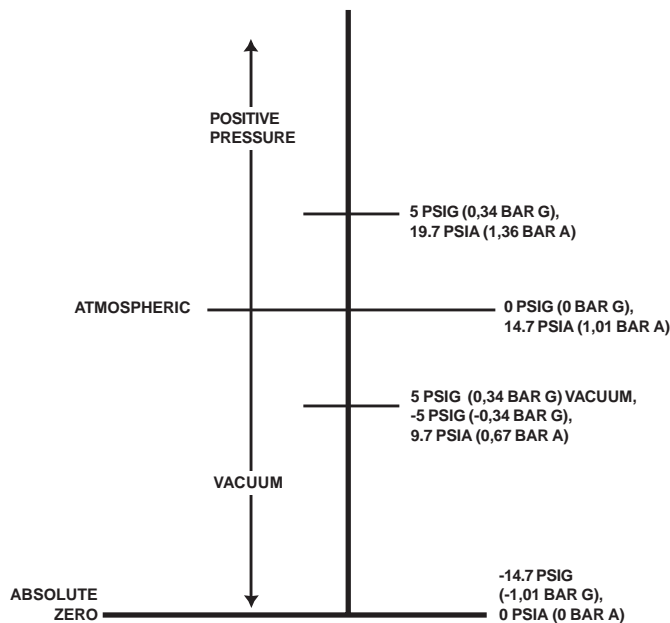

Figure 1. Vacuum Terminology

Vacuum Terminology

Engineers use a variety of terminology to describe vacuum, which can cause some confusion. Determine whether the units are in absolute pressure or gauge pressure (0 psi gauge (0 bar gauge) is atmospheric pressure).

- 5 psig (0,34 bar g) vacuum is 5 psi (0,34 bar) below atmospheric pressure
- -5 psig (0,34 bar g) is 5 psi (0,34 bar) below atmospheric pressure.
- 9.7 psia (0,67 bar a) is 9.7 psi (0,67 bar) above absolute zero or 5 psi (0,34 bar) below atmospheric pressure (14.7 psia - 5 psi = 9.7 psia (1,01 bar a - 0,34 bar = 0,67 bar a)).

Vacuum Control Devices

Just like there are pressure reducing regulators and pressure relief valves for positive pressure service, there are also two basic types of valves for vacuum service. The terms used for each are sometimes confusing. Therefore, it is sometimes necessary to ask further questions to determine the required function of the valve. Fisher uses the terms vacuum regulator and vacuum breaker to differentiate between the two types.

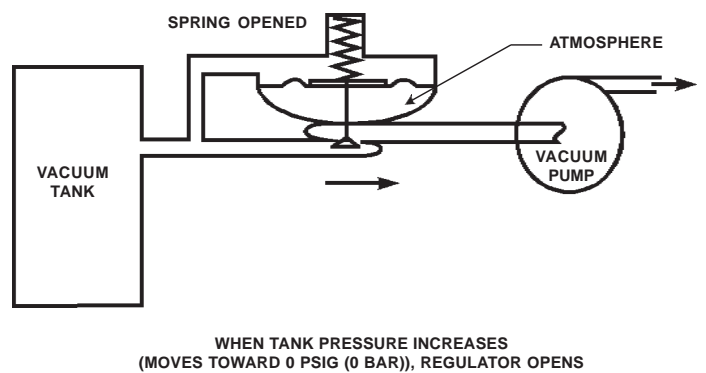

Figure 2. Conventional Regulator used as a Vacuum Regulator

VACUUM REGULATORS

Vacuum regulators maintain a constant vacuum at the regulator inlet. A decrease in this vacuum (increase in absolute pressure) beyond setpoint registers on the diaphragm and opens the disk. It depends on the valve as to which side of the diaphragm control pressure is measured. Opening the valve plug permits a downstream vacuum of lower absolute pressure than the upstream vacuum to restore the upstream vacuum to its original setting.

Besides the typical vacuum regulator, a conventional regulator can be suitable if applied correctly. Any pressure reducing regulator (spring to open device) that has an external control line connection and an O-ring stem seal can be used as a vacuum regulator. Installation requires a control line to connect the vacuum being controlled and the spring case. The regulator spring range is now a negative pressure range and the body flow direction is the same as in conventional pressure reducing service.

Vacuum Control

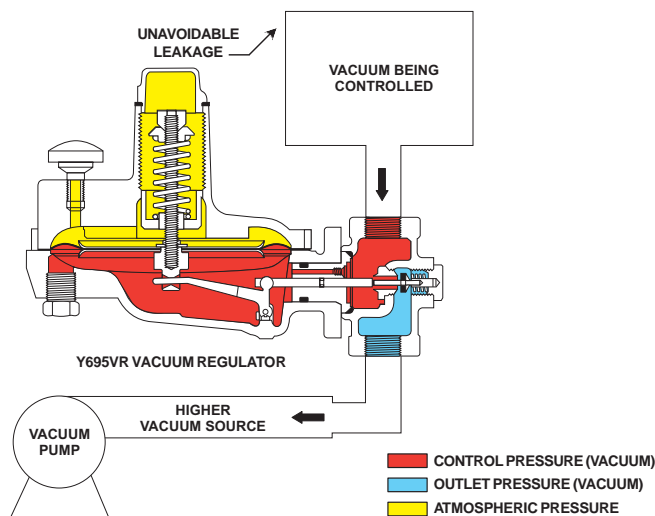

Figure 3. Typical Vacuum Regulator Installation

VACUUM BREAKERS (RELIEF VALVES)

Vacuum breakers are used in applications where an increase in vacuum must be limited. An increase in vacuum (decrease in absolute pressure) beyond a certain value causes the diaphragm to move and open the disk. This permits atmospheric pressure, positive pressure, or an upstream vacuum that has higher absolute pressure than the downstream vacuum, to enter the system and restore the controlled vacuum to its original pressure setting.

A vacuum regulator is a spring-to-close device, meaning that if there is no pressure on the valve the spring will push the valve plug into its seat. Fisher Controls has various products to handle this application. Some valves are designed as vacuum breakers. Fisher relief valves can also be used as vacuum breakers.

A conventional relief valve can be used as a vacuum breaker, as long as it has a threaded spring case vent so a control line can be attached. If inlet pressure is atmospheric air, then the internal pressure registration from body inlet to lower casing admits atmospheric pressure to the lower casing. If inlet pressure is not atmospheric, a relief valve in which the lower casing can be vented to atmosphere when the body inlet is pressurized must be chosen. In this case, Fisher uses the terminology 'blocked throat' or 'external registration with O-ring stem seal.'

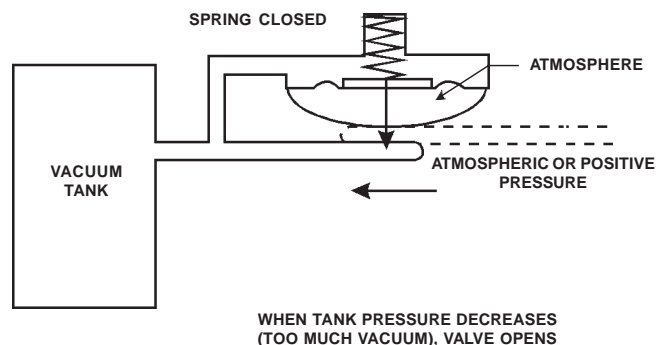

Figure 4. Conventional Relief Valve used as a Vacuum Breaker

A spring that normally has a range of 6 to 11-inches w.c. (15 to 27 mbar) positive pressure will now have a range of 6 to 11-inches w.c. (15 to 27 mbar) vacuum (negative pressure). It may be expedient to benchset the vacuum breaker if the type chosen uses a spring case closing cap. Removing the closing cap to gain access to the adjusting screw will admit air into the spring case when in vacuum service.

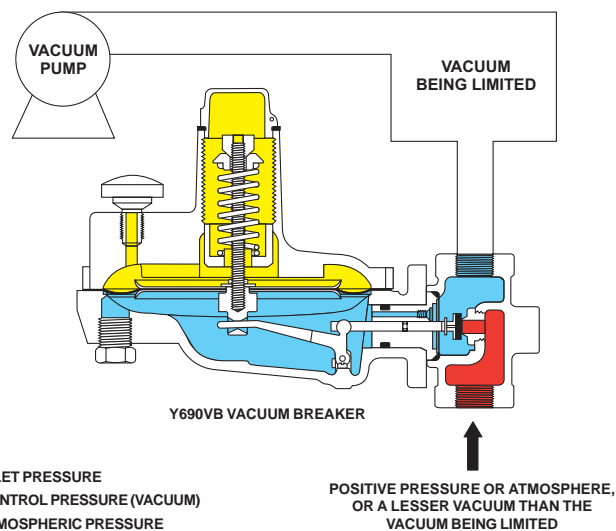

Figure 5. Typical Vacuum Breaker Installation

Vacuum Control

VACUUM REGULATOR INSTALLATION EXAMPLES

- CONTROL PRESSURE (VACUUM)
- OUTLET PRESSURE (VACUUM)
- ATMOSPHERIC PRESSURE

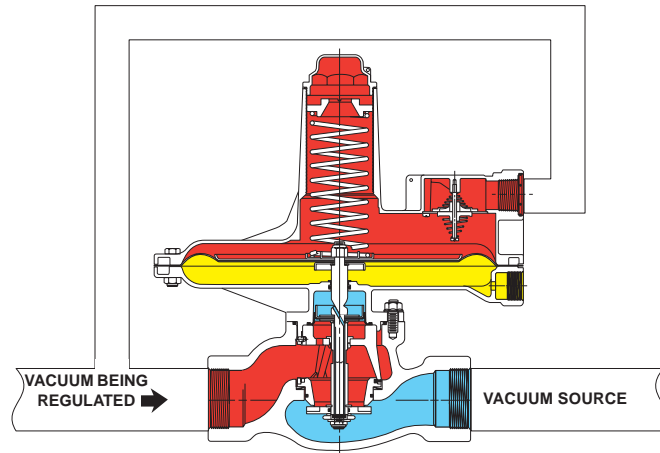

Figure 6. Type 133L

- CONTROL PRESSURE (VACUUM)
- LOADING PRESSURE
- ATMOSPHERIC PRESSURE
- OUTLET PRESSURE (VACUUM)

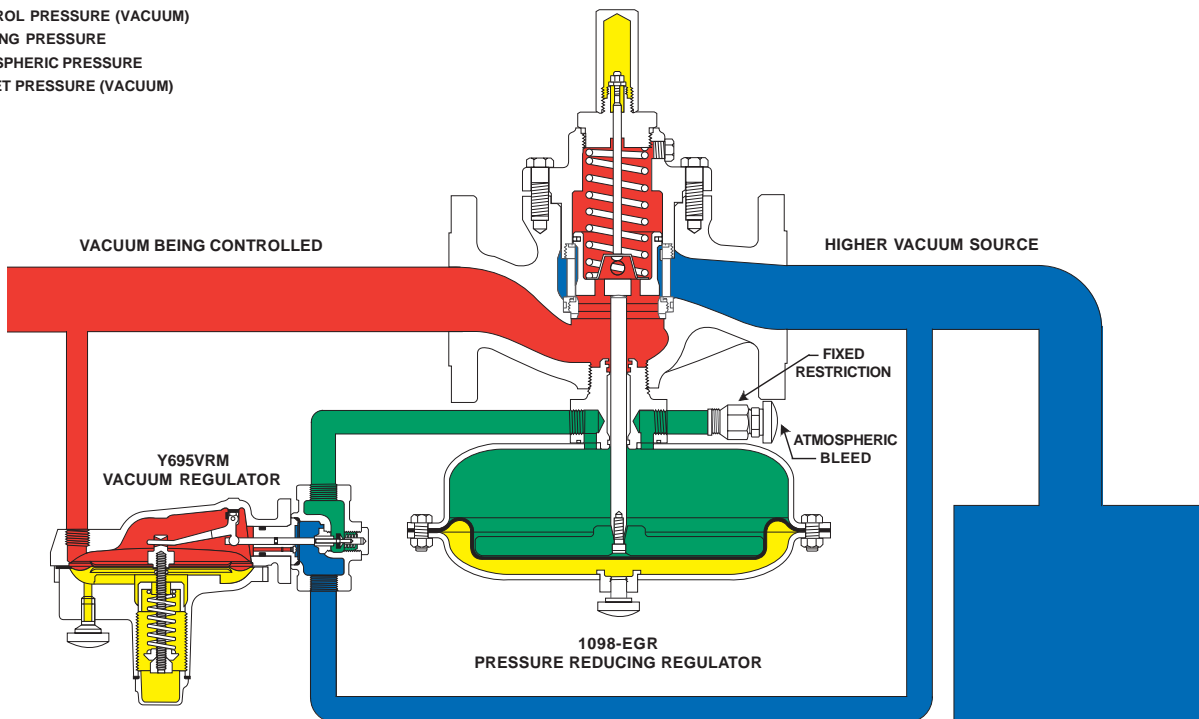

Figure 7. Type Y695VRM used with Type 1098-EGR in a Vacuum Regulator Installation

Vacuum Control

VACUUM BREAKER INSTALLATION EXAMPLES

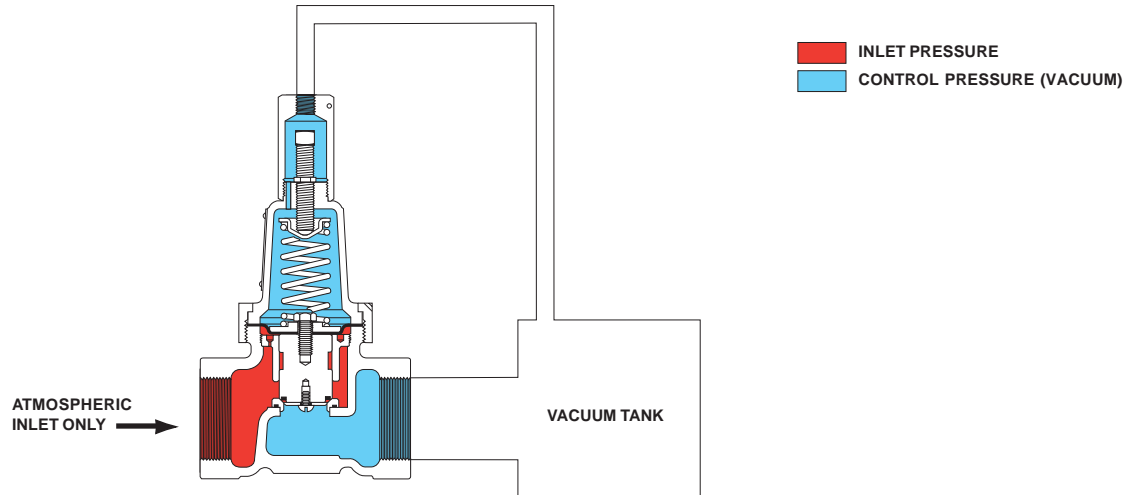

Figure 8. Type 1805

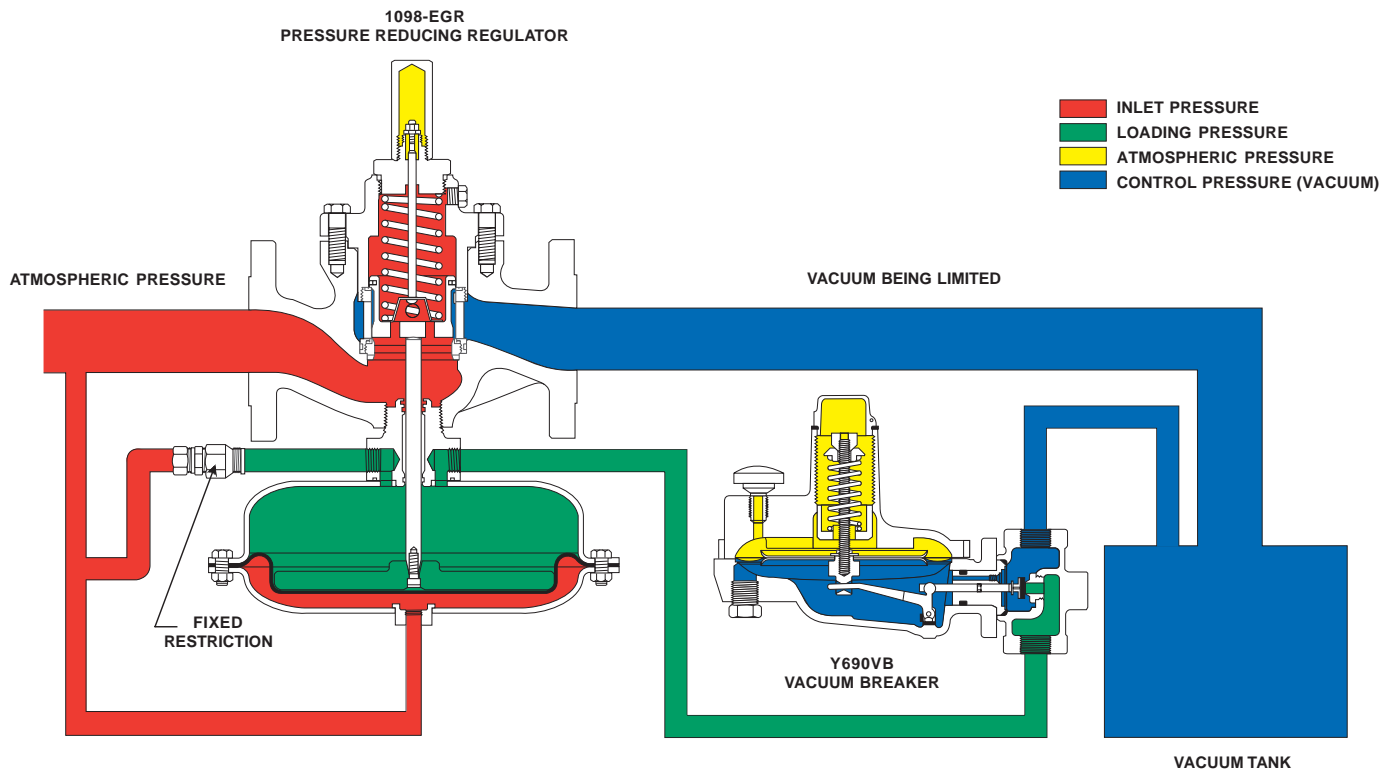

Figure 9. Type Y690VB used with Type 1098-EGR in a Vacuum Breaker Installation. If the positive pressure exceeds the Type 1098-EGR casing rating, then a Type 67AF with a Type H800 relief valve should be added.

Vacuum Control

VACUUM BREAKER INSTALLATION EXAMPLES

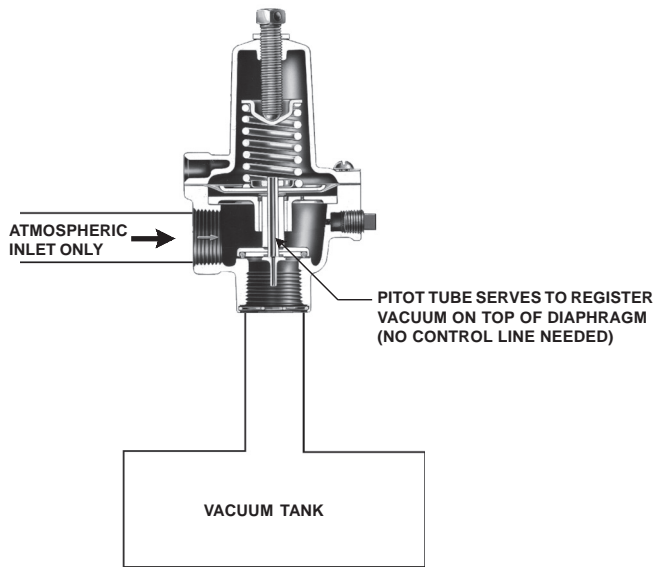
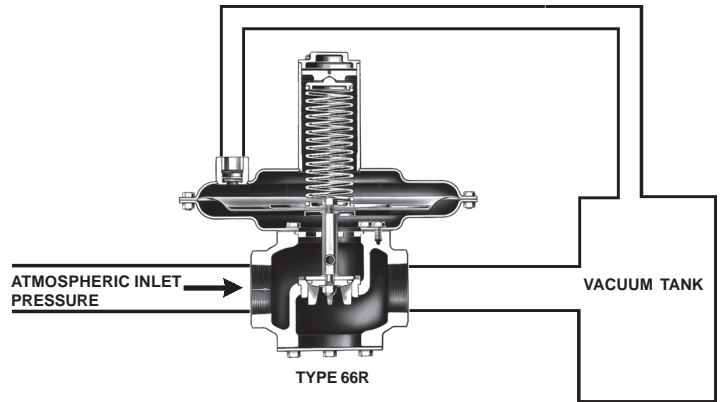

Figure 10. Type 289H Relief Valve used in a Vacuum Breaker Installation



If inlet is positive pressure:

- Select balancing diaphragm and tapped lower casing construction.
- Leave lower casing open to atmospheric pressure.

Figure 11. Type 66R Relief Valve used in a Vacuum Breaker Installation

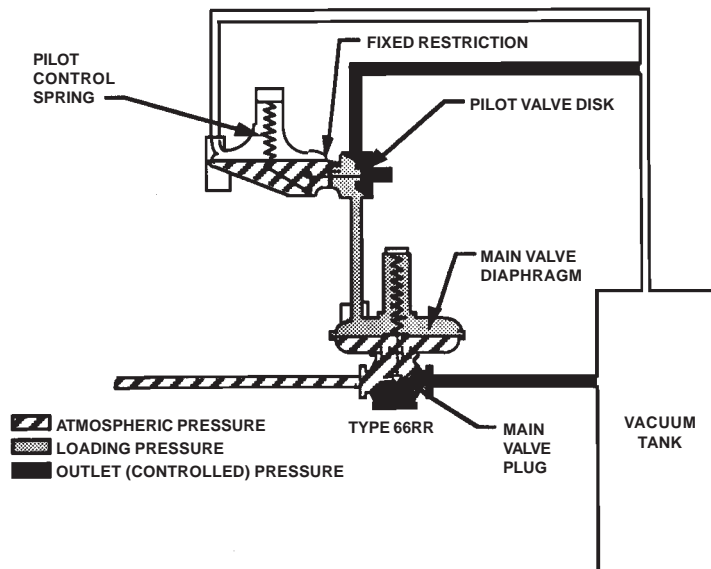

Figure 12. Type 66RR Relief Valve used in a Vacuum Breaker Installation

Vacuum Control

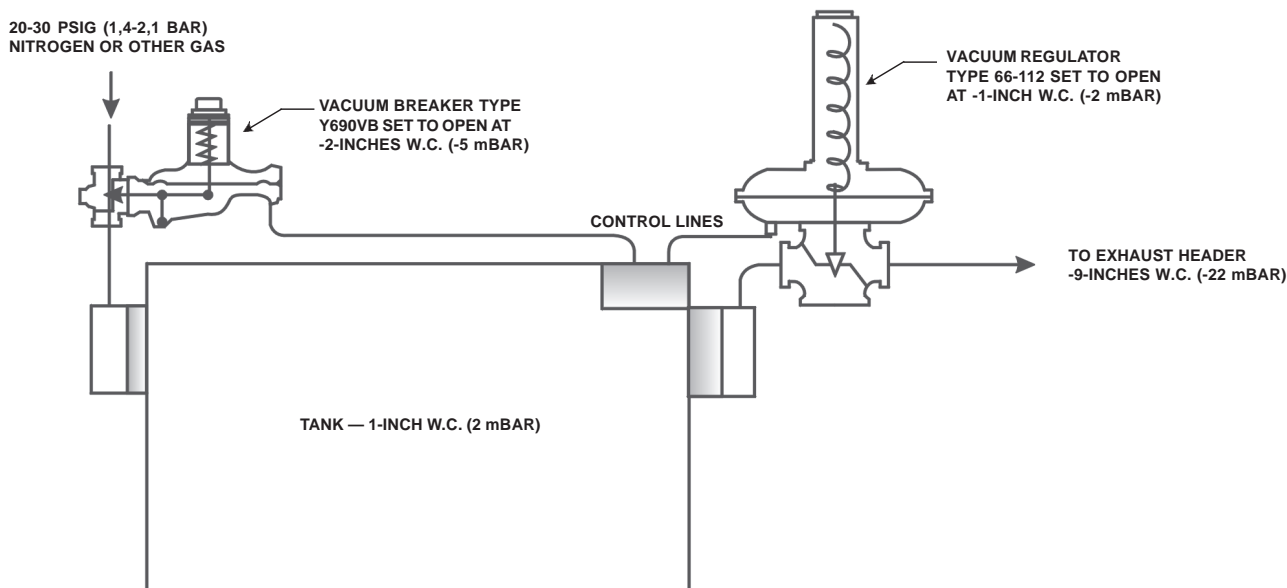

Figure 13. Example of Gas Blanketing in Vacuum

GAS BLANKETING IN VACUUM

When applications arise where the gas blanketing requirements are in vacuum, a combination of a vacuum breaker and a regulator may be used. For example, in low inches of water column vacuum, a Type Y690VB vacuum breaker and a Type 66-112 vacuum regulator can be used for very precise control.

Vacuum blanketing is useful if you suspect vessel leakage to atmosphere and the material inside the vessel is harmful to the surrounding employees or environment. If leakage were to occur, only outside air would enter the vessel because of the pressure differential in the tank. Therefore, any process vapors in the tank would be contained.

FEATURES OF FISHER'S VACUUM REGULATORS AND BREAKERS

- **Precision Control of Low Pressure Settings**—Large diaphragm areas provide more accurate control at low pressure settings. Some of these regulators are used as pilots on our Tank Blanketing and Vapor Recovery Regulators. Therefore, they are designed to be highly accurate, usually within 1-inch water column.
- **Corrosion Resistance**—Constructions are available in a variety of materials for compatibility with corrosive process gases. Wide selection of elastomers compatible with flowing media.
- **Rugged Construction**—Diaphragm case and internal parts are designed to withstand vibration and shock.
- **Wide Product Offering**—Fisher Controls can offer either direct-operated or pilot-operated regulators.
- **Fisher Advantage**—Widest range of products and a proven history in the design and manufacture of process control equipment. A Sales Channel that offers local stock and support.
- **Spare Parts**—Low cost parts that are interchangeable with other Fisher Regulators in your plant.
- **Easy Sizing and Selection**—Most applications can be sized utilizing the Fisher Sizing Program and sizing coefficients.

Freezing

INTRODUCTION

Freezing has been a problem since the birth of the gas industry. This problem will likely continue, but there are ways to minimize the effects of the phenomenon.

There are two areas of freezing. The first is the formation of ice from water travelling within the gas stream. Ice will form when temperatures drop below 32°F (0°C).

The second is hydrate formation. Hydrate is a frozen mixture of water and hydrocarbons. This bonding of water around the hydrocarbon molecule forms a compound which can freeze above 32°F (0°C). Hydrates can be found in pipelines that are saturated with water vapor. It is also common to have hydrate formation in natural gas of high BTU content. Hydrate formation is dependent upon operating conditions and gas composition.

REDUCING FREEZING PROBLEMS

To minimize problems, we have several options.

1. Keep the fluid temperature above the freezing point by applying heat.
2. Feed an antifreeze solution into the flow stream.
3. Select equipment that is designed to be ice-free in the regions where there are moving parts.
4. Design systems that minimize freezing effects.
5. Remove the water from the flow stream.

Heat the Gas

Obviously, warm water does not freeze. What we have to know is when heat is needed, then apply the heat.

Gas temperature is reduced whenever pressure is reduced. This temperature drop is about 1°F (1°C) for each 15 psi (2 bar) pressure drop. Potential problems can be identified by calculating the temperature drop and subtracting from the initial temperature. Usually ground temperature, about 50°F (10°C) is the initial temperature. If a pressure reducing station dropped the pressure from 400 to 250 psi (27 to 17 bar) and the initial temperature is 50°F (10°C), the final temperature would be 40°F (5°C).

$$50^{\circ}\text{F} - (400-250 \text{ psi}) (1^{\circ}\text{F}/15 \text{ psi}) = 40^{\circ}\text{F}$$

$$(10^{\circ}\text{C} - (27 - 17 \text{ bar}) (1^{\circ}\text{C}/2 \text{ bar}) = 5^{\circ}\text{C})$$

In this case, a freezing problem is not expected. However, if the final pressure was 25 psi (3 bar) instead of 250 psi (27 bar), the final temperature would be 25°F (-2°C). We should expect freezing in this example if there is any moisture in the gas stream.

We can heat the entire gas stream with line heaters where the situation warrants. However, this does involve some large equipment and considerable fuel requirements.

Many different types of large heaters are on the market today. Some involve boilers that heat a water/glycol solution which is circulated through a heat exchanger in the main gas line. Two important considerations are: (1) fuel efficiencies, and (2) noise generation.

In many cases, it is more practical to build a box around the pressure reducing regulator and install a small catalytic heater to warm the regulator. When pilot-operated regulators are used, we may find that the ice passes through the regulator without difficulty but plugs the small ports in the pilot. A small heater can be used to heat the pilot supply gas or the pilot itself. A word of caution is appropriate. When a heater remains in use when it is not needed, it can overheat the rubber parts of the regulator. They are usually designed for 180°F (82°C) maximum. Using an automatic temperature control thermostat can prevent overheating.

Antifreeze Solution

An antifreeze solution can be introduced into the flow stream where it will combine with the water. The mixture can pass through the pressure reducing station without freezing. The antifreeze is dripped into the pipeline from a pressurized reservoir through a needle valve. This system is quite effective if one remembers to replenish the reservoir. There is a system that allows the antifreeze to enter the pipeline only when needed. We can install a small pressure regulator between the reservoir and the pipeline with the control line of the small regulator connected downstream of the pressure reducing regulator in the pipeline. The small regulator is set at a lower pressure than the regulator in the pipeline. When the controlled pressure is normal, the small regulator remains closed and conserves the antifreeze. When ice begins to block the regulator in the pipeline, downstream pressure will fall below the setpoint of the small regulator which causes it to open, admitting antifreeze into the pipeline as it is needed. When the ice is removed, the downstream pressure returns to normal and the small regulator closes until ice begins to re-form. This system is quite reliable as long as the supply of the antifreeze solution is maintained. It is usually used at low volume pressure reducing stations.

Freezing

Equipment Selection

We can select equipment that is somewhat tolerant of freezing if we know how ice forms in a pressure reducing regulator. Since the pressure drop occurs at the orifice, this is the spot where we might expect the ice formation. However, this is not necessarily the case. Metal regulator bodies are good heat conductors. As a result, the body, not just the port, is cooled by the pressure drop. The moisture in the incoming gas strikes the cooled surface as it enters the body and freezes to the body wall before it reaches the orifice. If the valve plug is located upstream of the orifice, there is a good chance that it will become trapped in the ice and remain in the last position. This ice often contains worm holes which allow gas to continue to flow. In this case, the regulator will be unable to control downstream pressure when the flow requirement changes. If the valve plug is located downstream of the port, it is operating in an area that is frequently ice-free. It must be recognized that any regulator can be disabled by ice if there is sufficient moisture in the flow stream.

System Design

We can arrange station piping to reduce freezing if we know when to expect freezing. Many have noted that there are few reported instances of freezing when the weather is very cold (0°F (-18°C)). They have observed that most freezing occurs when the atmospheric temperature is between 35° and 45°F (2° and 7°C). When the atmospheric temperature is quite low, the moisture within the gas stream freezes to the pipe wall before it reaches the pressure reducing valve which leaves only dry gas to pass through the valve. We can take advantage of this concept by increasing the amount of piping that is exposed above ground upstream of the pressure reducing valve. This will assure ample opportunity for the moisture to contact the pipe wall and freeze to the wall.

When the atmospheric temperature rises enough to melt the ice from the pipe wall, it is found that the operating conditions are not favorable to ice formation in the pressure reducing valve. There may be sufficient solar heat gain to warm the regulator body or lower flow rates which reduces the refrigeration effect of the pressure drop.

Parallel pressure reducing valves make a practical antifreeze system for low flow stations such as farm taps. The two parallel regulators are set at slightly different pressures (maybe one at 50 psi (3 bar) and one at 60 psi (4 bar)). The flow will automatically go through the regulator with the higher setpoint. When this regulator freezes closed, the pressure will drop and the second regulator will open and carry the load. Since most freezing instances occur when the atmospheric temperature is between 35° and 45°F (2° and 7°C), we expect the ice

in the first regulator to begin thawing as soon as the flow stops. When the ice melts from the first regulator, it will resume flowing gas. These two regulators will continue to alternate between flowing and freezing until the atmospheric temperature decreases or increases, which will get the equipment out of the ice formation temperature range.

Water Removal

Removing the moisture from the flow stream solves the problem of freezing. However, this can be a difficult task. Where moisture is a significant problem, it may be beneficial to use a method of dehydration. Dehydration is a process that removes the water from the gas stream. Effective dehydration removes enough water to prevent reaching the dew point at the lowest temperature and highest pressure.

Two common methods of dehydration involve glycol absorption and desiccants. The glycol absorption process requires the gas stream to pass through glycol inside a contactor. Water vapor is absorbed by the glycol which in turn is passed through a regenerator that removes the water by distillation. The glycol is reused after being stripped of the water. The glycol system is continuous and fairly low in cost. It is important, however, that glycol is not pushed downstream with the dried gas.

The second method, solid absorption or desiccant, has the ability to produce much drier gas than glycol absorption. The solid process has the gas stream passing through a tower filled with desiccant. The water vapor clings to the desiccant, until it reaches saturation. Regeneration of the desiccant is done by passing hot gas through the tower to dry the absorption medium. After cooling, the system is ready to perform again. This is more of a batch process and will require two or more towers to keep a continuous flow of dry gas. The desiccant system is more expensive to install and operate than the glycol units.

Most pipeline gas does not have water content high enough to require these measures. Sometimes a desiccant dryer installed in the pilot gas supply lines of a pilot-operated regulator is quite effective. This is primarily true where water is present on an occasional basis.

SUMMARY

It is ideal to design a pressure reducing station that will never freeze, but anyone who has spent time working on this problem will acknowledge that no system is foolproof. We can design systems that minimize the freezing potential by being aware of the conditions that favor freezing.

Chemical Compatibility of Elastomers and Metals

INTRODUCTION

This section explains the uses and compatibilities of elastomers commonly used by Fisher. The following tables provide the compatibility of the most common elastomers and metals to a variety of chemicals and/or compounds.

ELASTOMERS: CHEMICAL NAMES AND USES

NBR - Nitrile Rubber, also called Buna-N, is a copolymer of butadiene and acrylonitrile. Nitrile is recommended for: general purpose sealing, petroleum oils and fluids, water, silicone greases and oils, di-ester based lubricants (such as MIL-L-7808), and ethylene glycol based fluids (Hydrolubes). It is not recommended for: halogenated hydrocarbons, nitro hydrocarbons (such as nitrobenzene and aniline), phosphate ester hydraulic fluids (Skydrol, Cellulube, Pydraul), ketones (MEK, acetone), strong acids, ozone, and automotive brake fluid. Its temperature range is -60° to +225°F (-51° to +107°C), although this would involve more than one compound.

EPDM, EPM - Ethylenepropylene rubber is an elastomer prepared from ethylene and propylene monomers. EPM is a copolymer of ethylene and propylene, while EPDM contains a small amount of a third monomer (a diene) to aid in the curing process. EP is recommended for: phosphate ester based hydraulic fluids, steam to 400°F (204°C), water, silicone oils and greases, dilute acids, dilute alkalis, ketones, alcohols, and automotive brake fluids. It is not recommended for: petroleum oils, and di-ester based lubricants. Its temperature range is -60° to +500°F (-51° to +260°C) (The high limit would make use of a special high temperature formulation developed for geothermal applications).

FKM - This is a fluoroelastomer of the polymethylene type having substituent fluoro and perfluoroalkyl or perfluoroalkoxy groups on the polymer chain. Viton and Fluorel are the most common trade names. FKM is recommended for: petroleum oils, di-ester based lubricants, silicate ester based lubricants (such as MLO 8200, MLO 8515, OS-45), silicone fluids and greases, halogenated hydrocarbons, selected phosphate ester fluids, and some acids. It is not recommended for: ketones, Skydrol 500, amines (UDMH), anhydrous ammonia, low molecular weight esters and ethers, and hot hydrofluoric and chlorosulfonic acids. Its temperature range is -20° to +450°F (-29° to +232°C) (Limited use at each end of the temperature range).

CR - This is chloroprene, commonly known as neoprene, which is a homopolymer of chloroprene (chlorobutadiene). CR is recommended for: refrigerants (Freons, ammonia), high aniline point petroleum oils, mild acids, and silicate ester fluids. It is not recommended for: phosphate ester fluids and ketones. Its temperature range is -60° to +200°F (-51° to +93°C), although this would involve more than one compound.

NR - This is natural rubber which is a natural polyisoprene, primarily from the tree, *Hevea Brasiliensis*. The synthetics have all but completely replaced natural rubber for seal use. NR is recommended for automotive brake fluid, and it is not recommended for petroleum products. Its temperature range is -80° to +180°F (-62° to +82°C).

FKM - This is a copolymer of tetrafluoroethylene and propylene; hence, it is sometimes called TFE/P rubber. Common trade names are Aflas (3M Co.) and Fluoraz (Greene, Tweed & Co.). It is generally used where resistance to both hydrocarbons and hot water are required. Its temperature range is +20° to +400°F (-7° to +204°C).

ECO - This is commonly called Hydrin rubber, although that is a trade name for a series of rubber materials by B.F. Goodrich. CO is the designation for the homopolymer of epichlorohydrin, ECO is the designation for a copolymer of ethylene oxide and chloromethyl oxirane (epichlorohydrin copolymer), and ETER is the designation for the terpolymer of epichlorohydrin, ethylene oxide, and an unsaturated monomer. All the epichlorohydrin rubbers exhibit better heat resistance than nitrile rubbers, but corrosion with aluminum may limit applications. Typical operating temperature ranges are -20° to +325°F (-29° to +163°C) for the CO and -55° to +300°F (-48° to +149°C) for the ECO and ETER elastomers.

FFKM - This is a perfluoroelastomer generally better known as Kalrez (DuPont) and Chemraz (Greene, Tweed). Perfluoro rubbers of the polymethylene type have all substituent groups on the polymer chain of fluoro, perfluoroalkyl, or perfluoroalkoxy groups. The resulting polymer has superior chemical resistance and heat temperature resistance. This elastomer is extremely expensive and should be used only when all else fails. Its temperature range is 0° to +500°F (-18° to +260°C). Some materials, such as Kalrez 4079 can be used to 600°F (316°C).

FVMQ - This is fluorosilicone rubber which is an elastomer that should be used for static seals because it has poor mechanical properties. It has good low and high temperature resistance and is reasonably resistant to oils and fuels because of its fluorination. Because of the cost, it only finds specialty use. Its temperature range is -80° to +350°F (-62° to +177°C).

VMQ - This is the most general term for silicone rubber. Silicone rubber can be designated MQ, PMQ, and PVMQ, where the Q designates any rubber with silicon and oxygen in the polymer chain, and M, P, and V represent methyl, phenyl, and vinyl substituent groups on the polymer chain. This elastomer is used only for static seals due to its poor mechanical properties. Its temperature range is -65° to +450°F (-54° to +232°C).

Chemical Compatibility of Elastomers and Metals

General Properties of Elastomers													
PROPERTY		NATURAL RUBBER	BUNA-S	NITRILE	NEOPRENE	BUTYL	THIOLKOL	SILICONE	HYPALON	VITON ^(1,2)	POLYURETHANE ⁽²⁾	POLY-ACRYLIC ⁽¹⁾	ETHYLEN-EPROPYLENE ⁽³⁾
Tensile Strength, Psi (Bar)	Pure Gum	3000 (207)	400 (28)	600 (41)	3500 (241)	3000 (207)	300 (21)	200-450 (14-31)	4000 (276)	---	---	100 (7)	---
	Reinforced	4500 (310)	3000 (207)	4000 (276)	3500 (241)	3000 (207)	1500 (103)	1100 (76)	4400 (303)	2300 (159)	6500 (448)	1800 (124)	2500 (172)
Tear Resistance		Excellent	Poor-Fair	Fair	Good	Good	Fair	Poor-Fair	Excellent	Good	Excellent	Fair	Poor
Abrasion Resistance		Excellent	Good	Good	Excellent	Fair	Poor	Poor	Excellent	Very Good	Excellent	Good	Good
Aging: Sunlight Oxidation		Poor Good	Poor Fair	Poor Fair	Excellent Good	Excellent Good	Good Good	Good Very Good	Excellent Very Good	Excellent Excellent	Excellent Excellent	Excellent Excellent	Good
Heat (Maximum Temperature)		200°F (93°C)	200°F (93°C)	250°F (121°C)	200°F (93°C)	200°F (93°C)	140°F (60°C)	450°F (232°C)	300°F (149°C)	400°F (204°C)	200°F (93°C)	350°F (177°C)	350°F (177°C)
Static (Shelf)		Good	Good	Good	Very Good	Good	Fair	Good	Good	---	---	Good	Good
Flex Cracking Resistance		Excellent	Good	Good	Excellent	Excellent	Fair	Fair	Excellent	---	Excellent	Good	---
Compression Set Resistance		Good	Good	Very Good	Excellent	Fair	Poor	Good	Poor	Poor	Good	Good	Fair
Solvent Resistance: Aliphatic Hydrocarbon Aromatic Hydrocarbon Oxygenated Solvent Halogenated Solvent		Very Poor	Very Poor	Good	Fair	Poor	Excellent	Poor	Fair	Excellent	Very Good	Good	Poor
		Very Poor	Very Poor	Fair	Poor	Very Poor	Good	Very Poor	Poor	Very Good	Fair	Poor	Fair
		Good	Good	Poor	Fair	Good	Fair	Poor	Poor	Good	Poor	Poor	---
		Very Poor	Very Poor	Very Poor	Very Poor	Poor	Very Poor	Poor	Very Poor	Very Poor	---	---	Poor
Oil Resistance: Low Aniline Mineral Oil High Aniline Mineral Oil Synthetic Lubricants Organic Phosphates		Very Poor	Very Poor	Excellent	Fair	Very Poor	Excellent	Poor	Fair	Excellent	---	Excellent	Poor
		Very Poor	Very Poor	Excellent	Good	Very Poor	Excellent	Good	Good	Excellent	---	Excellent	Poor
		Very Poor	Very Poor	Fair	Very Poor	Poor	Poor	Fair	Poor	---	---	Fair	Poor
		Very Poor	Very Poor	Very Poor	Very Poor	Good	Good	Poor	Poor	Poor	Poor	Poor	Very Good
Gasoline Resistance: Aromatic Non-Aromatic		Very Poor Very Poor	Very Poor Very Poor	Good Excellent	Poor Good	Very Poor Very Poor	Excellent Excellent	Poor Good	Poor Fair	Good Very Good	Fair Good	Fair Poor	Fair Poor
Acid Resistance: Diluted (Under 10%) Concentrated ⁽⁴⁾		Good Fair	Good Poor	Good Poor	Fair Fair	Good Fair	Poor Very Poor	Fair Poor	Good Good	Excellent Very Good	Fair Poor	Poor Poor	Very Good Good
Low Temperature Flexibility (Maximum)		-65°F (-54°C)	-50°F (-46°C)	-40°F (-40°C)	-40°F (-40°C)	-40°F (-40°C)	-40°F (-40°C)	-100°F (-73°C)	-20°F (-29°C)	-30°F (-34°C)	-40°F (-40°C)	-10°F (-23°C)	-50°F (-45°C)
Permeability to Gases		Fair	Fair	Fair	Very Good	Very Good	Good	Fair	Very Good	Good	Good	Good	Good
Water Resistance		Good	Very Good	Very Good	Fair	Very Good	Fair	Fair	Fair	Excellent	Fair	Fair	Very Good
Alkali Resistance: Diluted (Under 10%) Concentrated		Good Fair	Good Fair	Good Fair	Good Good	Very Good Very Good	Poor Poor	Fair Poor	Good Good	Excellent Very Good	Fair Poor	Poor Poor	Excellent Good
Resilience		Very Good	Fair	Fair	Very Good	Very Good	Poor	Good	Good	Good	Fair	Very Poor	Very Good
Elongation (Maximum)		700%	500%	500%	500%	700%	400%	300%	300%	425%	625%	200%	500%

1. Do not use with steam
 2. Do not use with ammonia
 3. Do not use with petroleum based fluids. Use with ester based non-flammable hydraulic oils and low pressure steam applications to 300°F (149°C).
 4. Except for nitric and sulfuric acid.

Chemical Compatibility of Elastomers and Metals

Fluid Compatibility of Elastomers					
FLUID	MATERIAL				
	Neoprene (CR)	Nitrile (NBR)	Fluoroelastomer (FKM)	Ethylenepropylene (EPDM)	Perfluoroelastomer (FFKM)
Acetic Acid (30%)	B	C	C	A	A
Acetone	C	C	C	A	A
Air, Ambient	A	A	A	A	A
Air, Hot (200°F (93°C))	C	B	A	A	A
Alcohol (Ethyl)	A	C	C	A	A
Alcohol (Methyl)	A	A	C	A	A
Ammonia (Anhydrous) (Cold)	A	A	C	A	A
Ammonia (Gas, Hot)	B	C	C	B	A
Beer	A	A	A	A	A
Benzene	C	C	B	C	A
Brine (Calcium Chloride)	A	A	B	A	A
Butadiene Gas	C	C	B	C	A
Butane (Gas)	A	A	A	C	A
Butane (Liquid)	C	A	A	C	A
Carbon Tetrachloride	C	C	A	C	A
Chlorine (Dry)	C	C	A	C	A
Chlorine (Wet)	C	C	B	C	A
Coke Oven Gas	C	C	A	C	A
Ethyl Acetate	C	C	C	B	A
Ethylene Glycol	A	A	A	A	A
Freon 11	C	B	A	C	A
Freon 12	A	A	B	B	A
Freon 22	A	C	C	A	A
Freon 114	A	A	B	A	A
Gasoline (Automotive)	C	B	A	C	A
Hydrogen Gas	A	A	A	A	A
Hydrogen Sulfide (Dry)	A	A ⁽¹⁾	C	A	A
Hydrogen Sulfide (Wet)	B	C	C	A	A
Jet Fuel (JP-4)	B	A	A	C	A
Methyl Ethyl Ketone (MEK)	C	C	C	A	A
MTBE	C	C	C	C	A
Natural Gas	A	A	A	C	A
Nitric Acid (50 to 100%)	C	C	B	C	A
Nitrogen	A	A	A	A	A
Oil (Fuel)	C	A	A	C	A
Propane	B	A	A	C	A
Sulfur Dioxide	A	C	A	A	A
Sulfuric Acid (up to 50%)	B	C	A	B	A
Sulfuric Acid (50 to 100%)	C	C	A	B	A
Water (Ambient)	A	A	A	A	A
Water (at 200°F/93°C)	C	B	B	A	A

1. Performance worsens with hot temperatures.
A - Recommended
B - Minor to moderate effect. Proceed with caution.
C - Unsatisfactory
N/A - Information not available

Chemical Compatibility of Elastomers and Metals

Compatibility of Metals														
CORROSION INFORMATION														
Fluid	Material													
	Carbon Steel	Cast Iron	S30200 or S30400 Stainless Steel	S31600 Stainless Steel	Bronze	Monel	Hastelloy B	Hastelloy C	Durimet 20	Titanium	Cobalt-Base Alloy 6	S41600 Stainless Steel	440C Stainless Steel	17-4PH Stainless Steel
Acetaldehyde	A	A	A	A	A	A	IL	A	A	IL	IL	A	A	A
Acetic Acid, Air Free	C	C	B	B	B	B	A	A	A	A	A	C	C	B
Acetic Acid, Aerated	C	C	A	A	A	A	A	A	A	A	A	C	C	B
Acetic Acid Vapors	C	C	A	A	B	B	IL	A	B	A	A	C	C	B
Acetone	A	A	A	A	A	A	A	A	A	A	A	A	A	A
Acetylene	A	A	A	A	IL	A	A	A	A	IL	A	A	A	A
Alcohols	A	A	A	A	A	A	A	A	A	A	A	A	A	A
Aluminum Sulfate	C	C	A	A	B	B	A	A	A	A	IL	C	C	IL
Ammonia	A	A	A	A	C	A	A	A	A	A	A	A	A	IL
Ammonium Chloride	C	C	B	B	B	B	A	A	A	A	B	C	C	IL
Ammonium Nitrate	A	C	A	A	C	C	A	A	A	A	A	C	B	IL
Ammonium Phosphate (Mono Basic)	C	C	A	A	B	B	A	A	B	A	A	B	B	IL
Ammonium Sulfate	C	C	B	A	B	A	A	A	A	A	A	C	C	IL
Ammonium Sulfite	C	C	A	A	C	C	IL	A	A	A	A	B	B	IL
Aniline	C	C	A	A	C	B	A	A	A	A	A	C	C	IL
Asphalt	A	A	A	A	A	A	A	A	A	IL	A	A	A	A
Beer	B	B	A	A	B	A	A	A	A	A	A	B	B	A
Benzene (Benzol)	A	A	A	A	A	A	A	A	A	A	A	A	A	A
Benzoic Acid	C	C	A	A	A	A	IL	A	A	A	IL	A	A	A
Boric Acid	C	C	A	A	A	A	A	A	A	A	A	B	B	IL
Butane	A	A	A	A	A	A	A	A	A	IL	A	A	A	A
Calcium Chloride (Alkaline)	B	B	C	B	C	A	A	A	A	A	IL	C	C	IL
Calcium Hypochlorite	C	C	B	B	B	B	C	A	A	A	IL	C	C	IL
Carbolic Acid	B	B	A	A	A	A	A	A	A	A	A	IL	IL	IL
Carbon Dioxide, Dry	A	A	A	A	A	A	A	A	A	A	A	A	A	A
Carbon Dioxide, Wet	C	C	A	A	C	A	A	A	A	A	A	A	A	A
Carbon Disulfide	A	A	A	A	B	B	A	A	A	A	A	B	B	IL
Carbon Tetrachloride	B	B	B	B	A	A	B	A	A	A	IL	C	A	IL
Carbonic Acid	C	C	B	B	B	A	A	A	A	A	IL	A	A	A
Chlorine Gas, Dry	A	A	B	B	B	A	A	A	A	C	B	C	C	C
Chlorine Gas, Wet	C	C	C	C	C	C	C	B	C	A	B	C	C	C
Chlorine, Liquid	C	C	C	C	B	C	C	A	B	C	B	C	C	C
Chromic Acid	C	C	C	B	C	A	C	A	C	A	B	C	C	C
Citric Acid	IL	C	B	A	A	B	A	A	A	A	IL	B	B	B
Coke Oven Gas	A	A	A	A	A	B	A	A	A	A	A	A	A	A
Copper Sulfate	C	C	B	B	B	C	IL	A	A	A	IL	A	A	A
Cottonseed Oil	A	A	A	A	A	A	A	A	A	A	A	A	A	A
Creosote	A	A	A	A	C	A	A	A	A	IL	A	A	A	A
Ethane	A	A	A	A	A	A	A	A	A	A	A	A	A	A
Ether	B	B	A	A	A	A	A	A	A	A	A	A	A	A
Ethyl Chloride	C	C	A	A	A	A	A	A	A	A	A	B	B	IL
Ethylene	A	A	A	A	A	A	A	A	A	A	A	A	A	A
Ethylene Glycol	A	A	A	A	A	A	IL	IL	A	IL	A	A	A	A
Ferric Chloride	C	C	C	C	C	C	C	B	C	A	B	C	C	IL
Formaldehyde	B	B	A	A	A	A	A	A	A	A	A	A	A	A
Formic Acid	IL	C	B	B	A	A	A	A	A	C	B	C	C	B
Freon, Wet	B	B	B	A	A	A	A	A	A	A	A	IL	IL	IL
Freon, Dry	B	B	A	A	A	A	A	A	A	A	A	IL	IL	IL
Furfural	A	A	A	A	A	A	A	A	A	A	A	B	B	IL
Gasoline, Refined	A	A	A	A	A	A	A	A	A	A	A	A	A	A

A - Recommended
 B - Minor to moderate effect. Proceed with caution.
 C - Unsatisfactory
 IL - Information lacking

- continued -

Chemical Compatibility of Elastomers and Metals

Compatibility of Metals (continued)														
CORROSION INFORMATION														
Fluid	Material													
	Carbon Steel	Cast Iron	S30200 or S30400 Stainless Steel	S31600 Stainless Steel	Bronze	Monel	Hastelloy B	Hastelloy C	Durimet 20	Titanium	Cobalt-Base Alloy 6	S41600 Stainless Steel	440C Stainless Steel	17-4PH Stainless Steel
Glucose	A	A	A	A	A	A	A	A	A	A	A	A	A	A
Hydrochloric Acid, Aerated	C	C	C	C	C	C	A	B	C	C	B	C	C	C
Hydrochloric Acid, Air free	C	C	C	C	C	C	A	B	C	C	B	C	C	C
Hydrofluoric Acid, Aerated	B	C	C	B	C	C	A	A	B	C	B	C	C	C
Hydrofluoric Acid, Air free	A	C	C	B	C	A	A	A	B	C	IL	C	C	IL
Hydrogen	A	A	A	A	A	A	A	A	A	A	A	A	A	A
Hydrogen Peroxide	IL	A	A	A	C	A	B	B	A	A	IL	B	B	IL
Hydrogen Sulfide, Liquid	C	C	A	A	C	C	A	A	B	A	A	C	C	IL
Magnesium Hydroxide	A	A	A	A	B	A	A	A	A	A	A	A	A	IL
Mercury	A	A	A	A	C	B	A	A	A	A	A	A	A	B
Methanol	A	A	A	A	A	A	A	A	A	A	A	A	B	A
Methyl Ethyl Ketone	A	A	A	A	A	A	A	A	A	IL	A	A	A	A
Milk	C	C	A	A	A	A	A	A	A	A	A	C	C	C
Natural Gas	A	A	A	A	A	A	A	A	A	A	A	A	A	A
Nitric Acid	C	C	A	B	C	C	C	B	A	A	C	C	C	B
Oleic Acid	C	C	A	A	B	A	A	A	A	A	A	A	A	IL
Oxalic Acid	C	C	B	B	B	B	A	A	A	B	B	B	B	IL
Oxygen	A	A	A	A	A	A	A	A	A	A	A	A	A	A
Petroleum Oils, Refined	A	A	A	A	A	A	A	A	A	A	A	A	A	A
Phosphoric Acid, Aerated	C	C	A	A	C	C	A	A	A	B	A	C	C	IL
Phosphoric Acid, Air Free	C	C	A	A	C	B	A	A	A	B	A	C	C	IL
Phosphoric Acid Vapors	C	C	B	B	C	C	A	IL	A	B	C	C	C	IL
Picric Acid	C	C	A	A	C	C	A	A	A	IL	IL	B	B	IL
Potassium Chloride	B	B	A	A	B	B	A	A	A	A	IL	C	C	IL
Potassium Hydroxide	B	B	A	A	B	A	A	A	A	A	IL	B	B	IL
Propane	A	A	A	A	A	A	A	A	A	A	A	A	A	A
Rosin	B	B	A	A	A	A	A	A	A	IL	A	A	A	A
Silver Nitrate	C	C	A	A	C	C	A	A	A	A	B	B	B	IL
Sodium Acetate	A	A	B	A	A	A	A	A	A	A	A	A	A	A
Sodium Carbonate	A	A	A	A	A	A	A	A	A	A	A	B	B	A
Sodium Chloride	C	C	B	B	A	A	A	A	A	A	A	B	B	B
Sodium Chromate	A	A	A	A	A	A	A	A	A	A	A	A	A	A
Sodium Hydroxide	A	A	A	A	C	A	A	A	A	A	A	B	B	A
Sodium Hypochloride	C	C	C	C	B-C	B-C	C	A	B	A	IL	C	C	IL
Sodium Thiosulfate	C	C	A	A	C	C	A	A	A	A	IL	B	B	IL
Stannous Chloride	B	B	C	A	C	B	A	A	A	A	IL	C	C	IL
Stearic Acid	A	C	A	A	B	B	A	A	A	A	B	B	B	IL
Sulfate Liquor (Black)	A	A	A	A	C	A	A	A	A	A	IL	IL	IL	IL
Sulfur	A	A	A	A	C	A	A	A	A	A	A	A	A	A
Sulfur Dioxide, Dry	A	A	A	A	A	A	B	A	A	A	A	B	B	IL
Sulfur Trioxide, Dry	A	A	A	A	A	A	B	A	A	A	A	B	B	IL
Sulfuric Acid (Aerated)	C	C	C	C	C	C	A	A	A	B	B	C	C	C
Sulfuric Acid (Air Free)	C	C	C	C	B	B	A	A	A	B	B	C	C	C
Sulfurous Acid	C	C	B	B	B	C	A	A	A	A	B	C	C	IL
Tar	A	A	A	A	A	A	A	A	A	A	A	A	A	A
Trichloroethylene	B	B	B	A	A	A	A	A	A	A	A	B	B	IL
Turpentine	B	B	A	A	A	B	A	A	A	A	A	A	A	A
Vinegar	C	C	A	A	B	A	A	A	A	IL	A	C	C	A
Water, Boiler Feed	B	C	A	A	C	A	A	A	A	A	A	B	A	A
Water, Distilled	A	A	A	A	A	A	A	A	A	A	A	B	B	IL
Water, Sea	B	B	B	B	A	A	A	A	A	A	A	C	C	A
Whiskey and Wines	C	C	A	A	A	B	A	A	A	A	A	C	C	IL
Zinc Chloride	C	C	C	C	C	C	A	A	A	A	B	C	C	IL
Zinc Sulfate	C	C	A	A	B	A	A	A	A	A	A	B	B	IL

A - Recommended
 B - Minor to moderate effect. Proceed with caution.
 C - Unsatisfactory
 IL - Information lacking

Sulfide Stress Cracking—NACE MR0175

INTRODUCTION

The NACE Standard MR0175, “Sulfide Stress Corrosion Cracking Resistant Metallic Materials for Oil Field Equipment” is widely used throughout the world. The standard specifies the proper materials, heat treat conditions and strength levels required to provide good service life in sour gas and oil environments. NACE (National Association of Corrosion Engineers) is a worldwide technical organization which studies various aspects of corrosion and the damage that may result in refineries, chemical plants, water systems, and other industrial systems.

History

MR0175 was first issued in 1975, but the origin of the document dates to 1959 when a group of engineers in Western Canada pooled their experience in successful handling of sour gas. The group organized as NACE committee T-1B and in 1963 issued specification 1B163, “Recommendations of Materials for Sour Service.” In 1965, NACE organized the nationwide committee T-1F-1 which issued 1F166 in 1966 and MR0175 in 1975. The specification is revised on an annual basis.

NACE committee T-1F-1 continues to have responsibility for MR0175. All revisions and additions must be unanimously approved by the 500-plus member committee T-1, Corrosion Control in Petroleum Production. MR0175 is intended to apply only to oil field equipment, flow line equipment, and oil field processing facilities where H₂S is present. Only sulfide stress cracking (SSC) is addressed. Users are advised that other forms of failure mechanisms must be considered in all cases. Failure modes, such as severe general corrosion, chloride stress corrosion cracking, hydrogen blistering or step-wise cracking are outside the scope of the document. Users must carefully consider the process conditions when selecting materials.

While the standard is intended to be used only for oil field equipment, industry has taken MR0175 and applied it to many other areas including refineries, LNG plants, pipelines, and natural gas systems. The judicious use of the document in these applications is constructive and can help prevent SSC failures wherever H₂S is present.

Requirements

The various sections of MR0175 cover the commonly available forms of materials and alloy systems. The requirements for heat treatment, hardness levels, conditions of mechanical work, and post-weld heat treatment are addressed for each form of material. Fabrication techniques, bolting, platings, and coatings are also addressed.

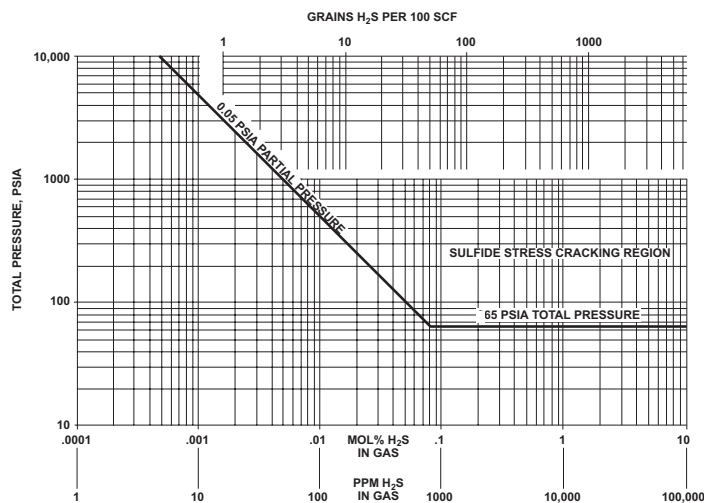

Figure 1. Sour Gas Systems

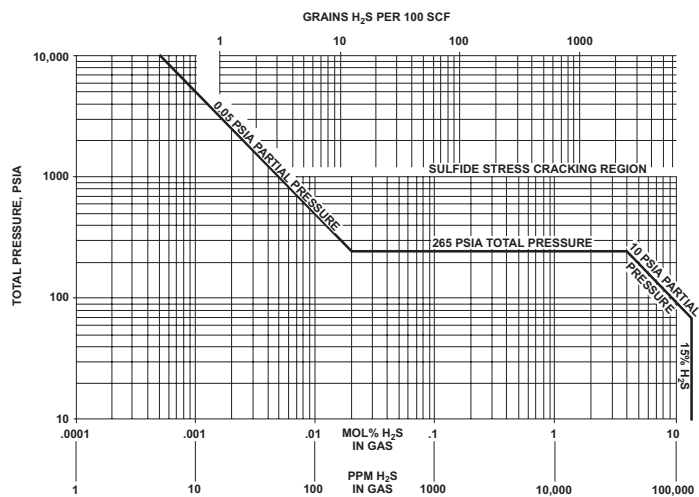

Figure 2. Sour Multiphase Systems

Sulfide Stress Cracking—NACE MR0175

Figures 1 and 2 taken from MR0175 define the sour systems where SSC may occur. Low concentrations of H₂S at low pressures are considered outside the scope of the document. The low stress levels at low pressures or the inhibitive effects of oil may give satisfactory performance with standard commercial equipment. Many users, however, have elected to take a conservative approach and specify NACE compliance any time a measurable amount of H₂S is present. The decision to follow MR0175 must be made by the user based on economic impact, the safety aspects should a failure occur, and past field experience. Legislation can impact the decision as well. MR0175 must now be followed by law for sour applications under several jurisdictions; Texas (Railroad Commission), off-shore (under U.S. Minerals Management Service), and Alberta, Canada (Energy Conservation Board).

THE BASICS OF SULFIDE STRESS CRACKING

SSC develops in aqueous solutions as corrosion forms on a material. Hydrogen ions are a product of many corrosion processes (Figure 3). These ions pick up electrons from the base material producing hydrogen atoms. At that point, two hydrogen atoms may combine to form a hydrogen molecule. Most molecules will eventually collect, form hydrogen bubbles, and float away harmlessly. Some percentage of the hydrogen atoms will diffuse into the base metal and embrittle the crystalline structure. When the concentration of hydrogen becomes critical and the tensile stress exceeds the threshold level, SSC occurs. H₂S does not actively participate in the SSC reaction; sulfides promote the entry of the hydrogen atoms into the base material.

In many instances, particularly among carbon and low alloy steels, the cracking will initiate and propagate along the grain boundaries. This is called intergranular stress cracking. In other alloy systems or under specific conditions, the cracking will propagate through the grains. This is called transgranular stress corrosion cracking.

Sulfide stress cracking is most severe at ambient temperature, 20° to 120°F (-7° to 49°C). Below 20°F (-7°C) the diffusion rate of the hydrogen is so slow that the critical concentration is never reached. Above 120°F (49°C) the diffusion rate is so fast that the hydrogen passes through the material in such a rapid manner that the critical concentration is not reached. The occurrence of stress corrosion cracking above 120°F (49°C) is still likely and must be carefully considered when selecting material. In most cases, the stress corrosion cracking will not be SSC but some other form. Chloride stress corrosion cracking is likely in deep sour wells as most exceed 300°F (149°C) and contain significant chloride levels.

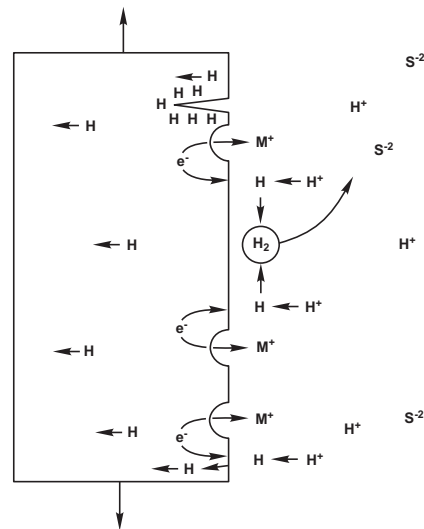

Figure 3. Schematic showing the generation on entry of hydrogen producing sulfide stress cracking

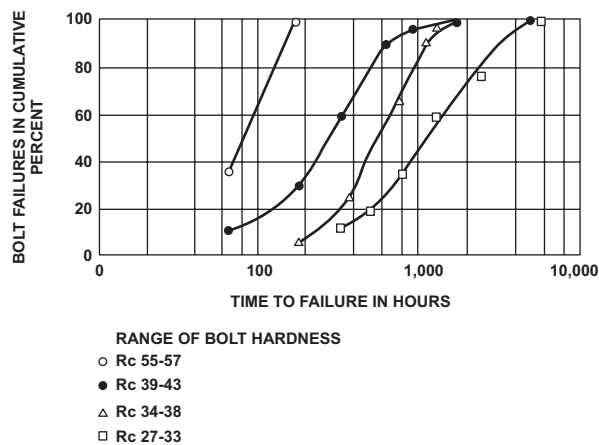

Figure 4. Effect of hardness on time to failure of AISI 4140 steel bolts in H₂S + water at 104°F (40°C) and 250 psi (17.2 bar)

Sulfide Stress Cracking—NACE MR0175

The susceptibility of a material to SSC is directly related to its strength or hardness level. This is true for carbon steels, stainless steels, and nickel based alloys. When carbon or alloy steel is heat treated to progressively higher hardness levels, the time to failure decreases rapidly for a given stress level (Figure 4). Years of field experience have shown that good SSC resistance is obtained below 22 HRC for the carbon and low alloy steels. SSC can still occur below 22 HRC, but the likelihood of failure is greatly reduced.

Carbon Steel

Carbon and low alloy steels have acceptable resistance to SSC provided their processing is carefully monitored. The hardness must be less than 22 HRC. If welding or significant cold working is done, stress relief is required. Even though the base metal hardness of a carbon or alloy steel is less than 22 HRC, areas of the heat effected zone will be harder. Post-weld heat treatment will eliminate these excessively hard areas.

ASME SA216 grades WCB and WCC are the most commonly used body casting materials. It is Fisher's policy to stress relieve all WCB and WCC castings to MR0175 whether they have been welded or not. This eliminates the chance of a weld repair going undetected and not being stress-relieved.

ASME SA352 grades LCB and LCC are very similar to WCB and WCC. They are impact tested at -50°F (-46°C) to ensure good toughness in low temperature service. LCB and LCC are used in the northern U.S., Alaska, and Canada where temperatures commonly drop below the -20°F (-32°C) permitted for WCB. All LCB and LCC castings to MR0175 are also stress-relieved.

Cast Iron

Gray, austenitic, and white cast irons cannot be used for any pressure retaining parts, due to low ductility. Ferritic ductile iron to ASTM A395 is acceptable when permitted by ANSI, API, or industry standards.

Stainless Steel

UNS S41000 stainless steel (410 stainless steel) and other martensitic grades must be double tempered to a maximum allowable hardness level of 25 HRC. Post-weld heat treatment is also required. S41600 stainless steel is similar to S41000 with the exception of a sulfur addition to produce free machining characteristics. Use of free machining steels is not permitted by MR0175.

CA6NM is a modified version of the cast S41000 stainless steel. MR0175 allows its use, but specifies the exact heat treatment required. Generally, the carbon content must be restricted to 0.3 percent maximum to meet the 23 HRC maximum hardness. Post-weld heat treatment is required for CA6NM.

The austenitic stainless steels have exceptional resistance to SSC in the annealed condition. The standard specifies that these materials must be 22 HRC maximum and free of cold work to prevent SSC. The cast and wrought equivalents of 302, 304, 304L, 305, 308, 309, 310, 316, 316L, 317, 321, and 347 are all acceptable per MR0175.

Post-weld heat treatment of the 300 Series stainless steels is not required. The corrosion resistance may be effected by welding. However, this can be controlled by using the low carbon grades, or low heat input levels and low interpass temperatures.

Wrought S17400 (17-4PH) stainless steel is allowed, but must be carefully processed to prevent SSC. The standard now gives two different acceptable heat treatments for S17400. One treatment is the double H1150 heat treatment which requires exposing the material at 1150°F (621°C) for four hours followed by air cooling and then exposing for another four hours at 1150°F (621°C). A maximum hardness level of 33 HRC is specified. The second heat treatment is the H1150M treatment. First, the material is exposed for two hours at 1400°F (760°C), then air cooled and exposed for four hours at 1150°F (621°C). The maximum hardness level is the same for this condition.

CB7Cu-1 (Cast 17-4PH) is not approved per MR0175. However, many users have successfully applied it for trim parts in past years in the same double heat treated conditions as the wrought form.

Two high strength stainless steel grades are acceptable for MR0175. The first is S66286 (grade 660 or A286) which is a precipitation hardening alloy with excellent resistance to SSC and general corrosion. The maximum hardness level permitted is 35 HRC.

The second material is S20910 (XM-19) which is commonly called Nitronic 50R. This high strength stainless steel has excellent resistance to SSC and corrosion resistance superior to S31600 or S31700. The maximum allowable hardness is 35 HRC. The "high strength" condition, which approaches 35 HRC, can only be produced by hot working methods. Cold drawn S20910 is also acceptable for shafts, stems, and pins. It is our experience that the SSC resistance of S20910 is far superior to S17400 or other austenitic stainless steels at similar hardness levels. The only other materials with similar stress cracking resistance at these strength levels are the nickel-based alloys which are, of course, much more expensive.

Sulfide Stress Cracking—NACE MR0175

A few duplex stainless steels are now acceptable per MR0175. Wrought S31803 (2205) and S32550 (Ferralium 255) are acceptable to 28 HRC. Wrought S32404 (Uranus 50) is acceptable to 20 HRC. Only one cast duplex stainless steel is acceptable, alloy Z 6CNDU20.08M, NF A 320-55 French National Standard.

Nonferrous Alloys

The final category in MR0175 is the nonferrous materials section. In general, the nickel-based alloys are acceptable to a maximum hardness level of 35 HRC. All have excellent resistance to SSC. Commonly used acceptable materials include nickel-copper alloys N04400 (alloy 400) and N04405 (alloy 405) and the precipitation hardening alloy N05500 (K500). The nickel-iron-chromium alloys include alloys N06600 (alloy 600) and N07750 (alloy X750). The acceptable nickel-chromium-molybdenum alloys include alloys N06625 (alloy 625), and N10276 (alloy C276). The precipitation hardening grade N07718 (alloy 718) is also acceptable to 40 HRC. Where high strength levels are required along with good machinability, Fisher uses N05500, N07718, N07750, or N09925 (alloy 925). They can be drilled or turned, then age hardened. Several cobalt based materials are acceptable, including R30035 (alloy MP35N), R30003 (Elgiloy), and R30605 (Haynes 25 or L605).

Aluminum based and copper alloys may be used for sour service, but the user is cautioned that severe corrosion attack may occur on these materials. They are seldom used in direct contact with H₂S.

Several wrought titanium grades are now included in MR0175. The only common industrial alloy is R50400 (grade 2).

SPRINGS

Springs in compliance with NACE represent a difficult problem. To function properly, springs must have very high strength (hardness) levels. Normal steel and stainless steel springs would be very susceptible to SSC and fail to meet MR0175.

In general, very soft, low strength materials must be used. Of course, these materials produce poor springs. The two exceptions allowed are the cobalt based alloys, such as R30003, which may be cold worked and hardened to a maximum hardness of 60 HRC and alloy N07750 which is permitted to 50 HRC.

COATINGS

Coatings, platings, and overlays may be used provided the base metal is in a condition which is acceptable per MR0175. The coatings may

not be used to protect a base material which is susceptible to SSC. Coatings commonly used in sour service are chromium plating, electroless nickel (ENC) and ion nitriding. Overlays and castings commonly used include CoCr-A (StelliteR or alloy 6), R30006 (alloy 6B), and NiCr-C (ColmonoyR 6) nickel-chromium-boron alloys. Tungsten carbide alloys are acceptable in the cast, cemented, or thermally sprayed conditions. Ceramic coatings such as plasma sprayed chromium oxide are also acceptable.

ENC is often used by Fisher as a wear-resistant coating. As required by MR0175, it is applied only to acceptable base metals. ENC has excellent corrosion resistance in sour, salt containing environments.

STRESS RELIEVING

Many people have the misunderstanding that stress relieving following machining is required by MR0175. Provided good machining practices are followed using sharp tools and proper lubrication, the amount of cold work produced is negligible. SSC resistance will not be affected. MR0175 actually permits the cold rolling of threads, provided the component will meet the heat treat conditions and hardness requirements specified for the given parent material. Cold deformation processes such as burnishing are also acceptable.

BOLTING

Bolting materials must meet the requirements of MR0175 when bolting is directly exposed to a sour environment. Standard ASTM A193 grade B7 bolts or A194 grade 2H nuts can be used per MR0175 provided they are outside of the sour environment. If the bolting will be deprived atmospheric contact by burial, insulation, or flange protectors, then grades of bolting such as B7 and 2H are unacceptable. The most commonly used fasteners for “exposed” applications are ASTM A193 grade B7M bolts and A194 grade 2M nuts. They are tempered and hardness tested versions of the B7 and 2H grades. HRC 22 is the maximum allowable hardness.

Many customers use only B7M bolting for bonnet, packing box, and flange joints. This reduces the likelihood of SSC if a leak develops and goes undetected or unrepaired for an extended time. It must be remembered, however, that use of lower strength bolting materials such as B7M often requires pressure vessel derating.

COMPOSITION MATERIALS

MR0175 does not address elastomer and polymer materials. However, the importance of these materials in critical sealing functions cannot be

Sulfide Stress Cracking—NACE MR0175

overlooked. User experience has been successful with elastomers such as nitrile, neoprene, fluoroelastomer (FKM), and perfluoroelastomer (FFKM). In general, fluoropolymers such as teflon (TFE) can be applied without reservation within their normal temperature range.

CODES AND STANDARDS

Applicable ASTM, ANSI, ASME, and API standards are used along with MR0175 as they would normally be used for other applications. The MR0175 requires that all weld procedures be qualified to these same standards. Welders must be familiar with the procedures and capable of making welds which comply.

The Commercial Application of NACE

Special documentation of materials to MR0175 is not required by the standard and NACE itself does not issue any type of a certification. It is the producer's responsibility to properly monitor the materials and processes as required by MR0175.

It is not uncommon for manufacturers to "upgrade" standard manufactured components to MR0175 by hardness testing. This produces a product which complies with MR0175, but which may not provide the best solution for the long-term. If the construction was not thoroughly recorded at the outset, it may be difficult to get replacement parts in the proper materials. The testing necessary to establish that each part complies is quite expensive. And, due to the "local" nature of a hardness test, there is also some risk that "upgraded" parts do not fully comply.

With proper in-house systems, it is quite simple to confidently produce a construction which can be certified to MR0175 without the necessity of after manufacture testing. This eliminates many costly extras and additionally provides a complete record of the construction for future parts procurement. An order entry, procurement, and manufacturing system which is integrated and highly structured is required in order to confidently and automatically provide equipment which complies.

Due to its hierarchical nature and its use by all company functions, the Fisher system is ideal for items such as MR0175 which requires a moderate degree of control without undue cost. In order to illustrate the system used by Fisher, an example will be used.

Most products produced by Fisher (including products to MR0175) will be specified by a Fisher Standard (FS) number. These numbers (e.g. FSED-542) completely specify a standardized construction including size, materials, and other characteristics. The FS number is

a short notation which represents a series of part groups (modules) describing the construction. One module may represent a 3-inch WCB valve body with ANSI Class 300 flanges, another may specify a certain valve plug and seat ring. The part numbers which make up these modules are composed of a drawing number and a material/finish identifier. The drawing describes the dimensions and methods used to make the part, while the material/finish reference considers material chemistry, form, heat treatment, and a variety of other variables. The part number definition also includes a very specific "material reference number" which is used to identify a material specification for purchase of materials. The material specification includes the ASME designation as well as additional qualifiers, as necessary, to ensure compliance with specifications such as NACE MR0175.

For NACE compliant products, an FS number and a NACE option are generally specified. The FS number establishes the standard construction variation. The option modifies the construction and materials to comply totally with MR0175 requirements. The option eliminates certain standard modules and replaces them with NACE suitable modules. Each part in a NACE suitable module has been checked to assure that it complies to the specification in form and manufacturing method and that it is produced from an appropriate material.

It is due to this top-to-bottom system integrity that Fisher can be confident of MR0175 compliance without the need for extensive test work. At each level of the system documentation, there are specific references to and requirements for compliance to MR0175. Further, since the construction is permanently documented at all levels of detail, it is possible to confidently and simply procure replacement parts at any future date.

Test documentation is available in a variety of forms, including certificates of compliance, hardness test data, chemical and physical test reports, and heat treat reports. Since these items will have some cost associated with them, it is important to examine the need for documentation in light of the vendor's credibility and manufacturing control systems. Fisher's normal manufacturing processes and procedures assure that all NACE specified products will comply without the need for additional test expense.

Fisher has been producing equipment for a variety of sour conditions and specifications since the mid-1950's and has thousands of devices in service. MR0175 has been shown to be an excellent technical reference for solving the complex application problems found in the handling of sour fluids. As more sour hydrocarbons are produced, it grows in importance and applicability.

Sulfide Stress Cracking—NACE MR0175

Comparison of UNS Numbers with Common Material Designations and Tradenames			
UNS NUMBERS	MATERIAL DESIGNATION OR TRADENAME	UNS NUMBERS	MATERIAL DESIGNATION OR TRADENAME
AWS A5.13-80	CoCr-A, Stellite 6, Alloy 6	N10002	Hastelloy C, Alloy C, CW12MW, CW2M
AWS A.13-80	NiCr-C, Colmonoy 6	N10276	Hastelloy C276
British Standard Aerospace Series HR3	Nimonic 105	R05200	Commerically Pure Tantalum
S66286 (K66286)	A-286, Grade 660	R30003	Elgiloy
N04400	Monel 400, Alloy 400, M35-1, M30C	R30004	Havar
N04405	Monel R405, R Monel, Alloy R405	R30035	MP35N
N05500	Monel K500, K Monel, K500	R30260	Duratherm 2602
N06002	Hastelloy X, Pyromet Alloy 680	R30605	L605, Haynes Alloy 25
N06007	Hastelloy G	R50400	Titanium Grade 2, RMI 40, Ti-50A, ALSMet Gr 2, Cabot Ti-40
N06110	Allcorr	R53400	Grade 12, Ti Code-12
N06600	Inconel 600, Alloy 600, Cy40	R56260	RMI 6A1-2Sn-4Zr-6Mo, Alpha-Beta
N06625	Inconel 625, Alloy 625, CW6MC	R58640	Beta Ti, Ti-38-6-44, Ti-3A1-8V-6Cr-4Zr-4Mo
N06985	Hastelloy G-3	S15700	PH15-7Mo, 15-7Mo
N07031	Pyromet 31	S20910	Nitronic 50, 22Cr-13Ni-5MN, ASTM Grade XM19
N07718	Inconel 718, Alloy 718, Pyrotool 7	S17400	17-4PH, Custom 630
N07750	Inconel X750, Alloy X750	S45000	Custom 450
N08020	Carpenter 20cb-3, Alloy 20, Duromet 20, CN7M	S20910, ASTM Grade XM19	Nitronic 50, 22Cr-13Ni-5MN
N08028	Sanicro 28	S31803, DIN 1.4462	SAF2205, 2205
N08800	Incoloy 800, Alloy 800	S32550	Ferralium Alloy 255
N08825	Incoloy 825, Alloy 825	S45000	Custom 450
N09925	Incoloy 925, Alloy 925	Z6CNDU20.08M	Uranus 50M

Cold Temperature Considerations

REGULATORS RATED FOR LOW TEMPERATURES

In some areas of the world, regulators periodically operate in temperatures below -20°F (-29°C). These cold temperatures require special construction materials to prevent regulator failure. Fisher offers regulator constructions that are RATED for use in service temperatures below -20°F (-29°C).

SELECTION CRITERIA

When selecting a regulator for extreme cold temperature service, the following guidelines should be considered:

- The body material should be 300 Series stainless steel, LCC, or LCB due to low carbon or zero carbon content in the material makeup.
- Give attention to the casting bolts used. Generally, special stainless steel bolting is required.
- Gaskets and O-rings may need to be addressed if providing a seal between two parts exposed to the cold.
- Special springs may be required in order to prevent fracture when exposed to extreme cold.
- Soft parts in the regulator that are also being used as a seal gasket between two metal parts (such as a diaphragm) may need special consideration. Alternate diaphragm materials should be used to prevent leakage caused by hardening and stiffening of the standard materials.

LOW TEMPERATURE FISHER REGULATORS

The following Fisher regulators have constructions readily available that are rated for use at temperatures below -20°F (-29°C):

- 1301 Series
- 627 Series
- Type 630
- 95 Series
- Type 1098-EGR

Please consult your Fisher Sales Representative for more information on regulators for cold temperature applications.

Powder Paint Coating

INTRODUCTION

Powder coating is the most exciting finishing method to be introduced in the past one hundred years. Powder coating offers significant performance advantages, an excellent solution to meeting current environmental regulations, a good balance of mechanical properties, and excellent corrosion resistance.

ECONOMIC ADVANTAGES

Powder coating systems save energy and virtually eliminate air and water pollution because they are solvent-free. The need for air make-up and the high cost of heating is reduced, resulting in considerable energy savings. Costly anti-pollution equipment and time and money spent dealing with state and federal regulatory agencies is also reduced. There is a major reduction in expensive and difficult disposal problems because there is no liquid paint sludge to send to a hazardous waste site. Because powder coatings do not require any flash-off time, conveyor racks can be more closely spaced; more parts coated per hour means a lower unit cost. In addition to the increased production rate for a powder coating system, reject rates are much lower than in a wet system.

ENVIRONMENTAL ADVANTAGES

The Clean Air Act of 1970 [U.S. Law] propelled powder coating processes to the forefront of the industry. By eliminating volatile organic compounds (VOCs), air pollution was reduced. To many major

coating companies, The Clean Air Act signaled the end of solvent-based processes. Prior to that, the fluidized bed coating process was well established and though the electrostatic powder spray process had started to gain acceptance, powder coating processes in general were not widespread or commercially accepted. The powder coating method received more media attention between 1971 and 1975 than at any other time, before or after. Powder coating processes, especially electrostatic powder spray processes, are now universally accepted and specified as the **Best Available Control Technology** (BACT) to reduce air pollution. While powder coatings have many process and performance advantages over conventionally applied coatings, it is the ecological advantages that advance their growth and acceptance. Consider:

Powder Coatings Contain No Solvents or VOCs

- No VOC emissions to the atmosphere.
- Compliance with most environmental regulations.
- Permits may not be required or are typically easier to obtain for new booth installations.
- Administrative costs of inspections, permits, sample testing, and record keeping are significantly reduced.
- Coating booth exhaust air is returned to the coating room.
- Less oven air is exhausted to the outside.
- Inherently safer and cleaner than solvent-based paint systems.
- No special transportation, storage, or handling techniques required.

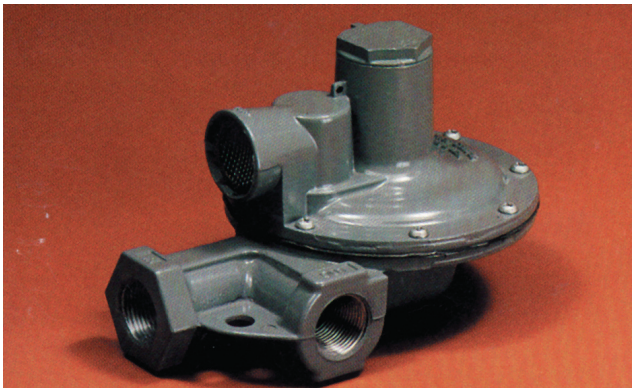

Figure 1. ANSI 49 Gray Powder Paint with Aluminum Oxide Coated Fasteners

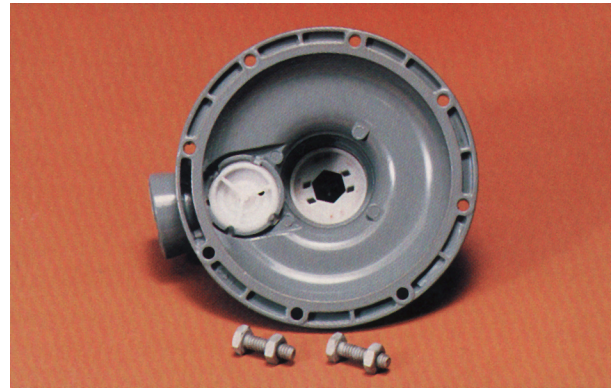

Figure 2. Inside and Outside Surfaces Coated for Corrosion Protection Eliminating the need for Chromate Conversion

Powder Paint Coating

Powder Coatings Reduce Waste and Present Few Hazards

- In most systems, powder coatings are collected and recycled.
- First pass transfer efficiency is high compared to conventional liquid paint application.
- Almost all powder coatings are free of heavy metals.
- The Resources Conservation and Recovery Act (RCRA) regulations consider almost no powder coating a hazardous waste.
- In most states, disposal methods for waste powder are the same as for non-hazardous industrial wastes.

MECHANICAL PROPERTIES

The general purpose powder coating formulations, now widely used, have a long established reputation for providing an excellent balance of mechanical properties including impact and abrasion resistance, and hardness. Resources now available allow for an even broader range of film properties than ever before. Extra hardness, greater chemical resistance, improved exterior gloss retention, and superior flexibility, though not necessarily in a single formulation, are all attainable. There are very few film properties available from liquid paint finishes that cannot be achieved with powder; however, some film properties easily attainable with powder are difficult or impossible to achieve with conventional wet paints.

CORROSION RESISTANCE

While proper metal pretreatment is important for optimum corrosion resistance, a combination of pretreatment and powder coatings can

provide outstanding corrosion resistance. Powder has achieved a good reputation due, in part, to its consistent delivery of high film builds and good edge coverage. Also, powders provide high crosslink density, good resistance to hydrolysis, low moisture and oxygen transmission rates, and films free from trace residual solvents.

ASTM TEST RESULTS

Dry powder paint successfully passed the following ASTM specified tests:

- Salt Spray Test (500 hours)
- Humidity Test (500 hours)
- QUV Test (500 hours)
- Test Fence (17 months)(test for gloss retention)
- Impact Test (140 inch pounds)
- Cold and High Temperature Test
- Adhesion Test
- Hardness Test
- Flexibility Test
- Chemical Resistance Tests:
 - Gasoline (unleaded, 24 hour immersion test)
 - Mineral Spirits (24 hour immersion test)
 - Nitric Acid (10% solution spot test for blistering)
 - Hydrochloric Acid (10% solution spot test for blistering)
 - Sulfuric Acid (10% solution spot test for blistering)
 - Sodium Hydroxide (10% solution spot test for blistering)
 - Liquid Propane Soak Test
 - Anhydrous Ammonia Reactivity Test

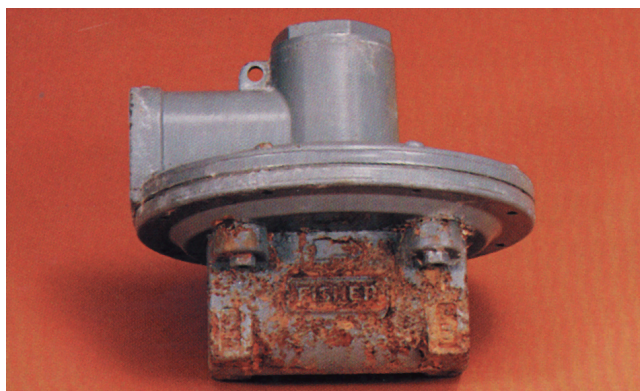

Figure 3. Standard Liquid Paint Coating after ASTM B117 500 Hour Salt Spray Test

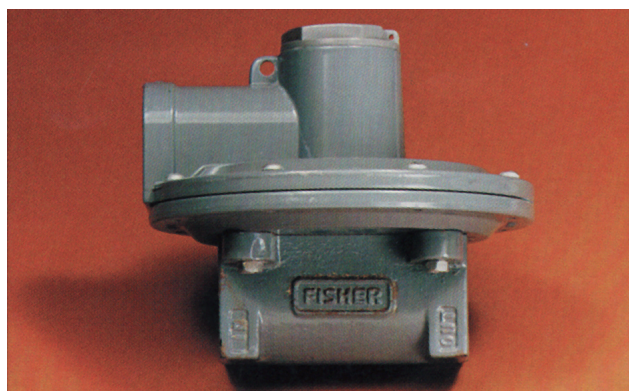

Figure 4. Dry Powder Paint and Aluminum Oxide Coated Fasteners after ASTM B117 500 Hour Salt Spray Test

Regulator Tips

1. All regulators should be installed and used in accordance with federal, state, and local codes and regulations.
2. Adequate overpressure protection should be installed to protect the regulator from overpressure. Adequate overpressure protection should also be installed to protect all downstream equipment in the event of regulator failure.
3. Downstream pressures significantly higher than the regulator's pressure setting may damage soft seats and other internal parts.
4. If two or more available springs have published pressure ranges that include the desired pressure setting, use the spring with the lower range for better accuracy.
5. The recommended selection for orifice diameters is the smallest orifice that will handle the flow.
6. Most regulators shown in this handbook are generally suitable for temperatures to 180°F (82°C). With high temperature fluoroelastomers (if available), the regulators can be used for temperatures to 300°F (149°C). Check the temperature capabilities to determine materials and temperature ranges available. Use stainless steel diaphragms and seats for higher temperatures, such as steam service.
7. The full advertised range of a spring can be utilized without sacrificing performance or spring life.
8. Regulator body size should never be larger than the pipe size. In many cases, the regulator body is one size smaller than the pipe size.
9. Do not oversize regulators. Pick the smallest orifice size or regulator that will work. Keep in mind when sizing a station that most restricted trims that do not reduce the main port size do not help with improved low flow control.
10. Speed of regulator response, in order:
 - Direct-operated
 - Two-path pilot-operated
 - Unloading pilot-operated
 - Control valve

Note: Although direct-operated regulators give the fastest response, all types provide quick response.
11. When a regulator appears unable to pass the published flow rate, be sure to check the inlet pressure measured at the regulator body inlet connection. Piping up to and away from regulators can cause significant flowing pressure losses.
12. When adjusting setpoint, the regulator should be flowing at least five percent of the normal operating flow.
13. Direct-operated regulators generally have faster response to quick flow changes than pilot-operated regulators.
14. Droop is the reduction of outlet pressure experienced by pressure-reducing regulators as the flow rate increases. It is stated as a percent, in inches of water column (mbar) or in pounds per square inch (bar) and indicates the difference between the outlet pressure setting made at low flow rates and the actual outlet pressure at the published maximum flow rate. Droop is also called offset or proportional band.
15. Downstream pressure always changes to some extent when inlet pressure changes.
16. Most soft-seated regulators will maintain the pressure within reasonable limits down to zero flow. Therefore, a regulator sized for a high flow rate will usually have a turndown ratio sufficient to handle pilot-light loads during off cycles.
17. Do not undersize the monitor set. It is important to realize that the monitor regulator, even though it is wide-open, will require pressure drop for flow. Using two identical regulators in a monitor set will yield approximately 70 percent of the capacity of a single regulator.

Regulator Tips

18. Diaphragms leak a small amount due to migration of gas through the diaphragm material. To allow escape of this gas, be sure casing vents (where provided) remain open.
19. Use control lines of equal or greater size than the control tap on the regulator. If a long control line is required, make it bigger. A rule of thumb is to use the next nominal pipe size for every 20 feet (6,1 meters) of control line. Small control lines cause a delayed response of the regulator, leading to increased chance of instability. 3/8-Inch OD tubing is the minimum recommended control line size.
20. For every 15 psid (1,0 bar, differential) pressure differential across the regulator, expect approximately a one degree drop in gas temperature due to the natural refrigeration effect. Freezing is often a problem when the ambient temperature is between 30° and 45°F (-1° and 7°C).
21. A disk with a cookie cut appearance probably means you had an overpressure situation. Thus, investigate further.
22. When using relief valves, be sure to remember that the reset point is lower than the start-to-bubble point. To avoid seepage, keep the relief valve setpoint far enough above the regulator setpoint.
23. Vents should be pointed down to help avoid the accumulation of water condensation or other materials in the spring case.
24. Make control line connections in a straight run of pipe about 10 pipe diameters downstream of any area of turbulence, such as elbows, pipe swages, or block valves.
25. When installing a working monitor station, get as much volume between the two regulators as possible. This will give the upstream regulator more room to control intermediate pressure.
26. Cutting the supply pressure to a pilot-operated regulator reduces the regulator gain or sensitivity and, thus, may improve regulator stability. (This can only be used with two path control.)
27. Regulators with high flows and large pressure drops generate noise. Noise can wear parts which can cause failure and/or inaccurate control. Keep regulator noise below 110 dBA.
28. Do not place control lines immediately downstream of rotary or turbine meters.
29. Keep vents open. Do not use small diameter, long vent lines. Use the rule of thumb of the next nominal pipe size every 10 feet (6,1 meters) of vent line and 3 feet (0,91 meters) of vent line for every elbow in the line.
30. Fixed factor measurement (or PFM) requires the regulator to maintain outlet pressure within $\pm 1\%$ of absolute pressure. For example: Setpoint of 2 psig + 14.7 psia = 16.7 psia x 0.01 = ± 0.167 psi. (Setpoint of 0,14 bar + 1,01 bar = 1,15 bar x 0,01 = $\pm 0,0115$ bar.)
31. Regulating C_g (coefficient of flow) can only be used for calculating flow capacities on pilot-operated regulators. Use capacity tables or flow charts for determining a direct-operated regulator's capacity.
32. Do not make the setpoints of the regulator/monitor too close together. The monitor can try to take over if the setpoints are too close, causing instability and reduction of capacity. Set them at least one proportional band apart.
33. Consider a butt-weld end regulator where available to lower costs and minimize flange leakages.
34. Do not use needle valves in control lines; use full-open valves. Needle valves can cause instability.
35. Burying regulators is not recommended. However, if you must, the vent should be protected from ground moisture and plugging.

Pressure Equivalents									
MULTIPLY NUMBER OF	TO OBTAIN BY	KG PER SQUARE CENTIMETER	POUNDS PER SQUARE INCH	ATMOSPHERE	BAR	INCHES OF MERCURY	KILOPASCALS	INCHES OF WATER COLUMN	FEET OF WATER COLUMN
		Kg per square cm	1	14.22	0.9678	0.98067	28.96	98,067	394.05
Pounds per square Inch	0,07031	1	0.06804	0,06895	2.036	6,895	27.7	2.309	
Atmosphere	1,0332	14.696	1	1,01325	29.92	101,325	407.14	33.93	
Bar	1,01972	14.5038	0.98692	1	29.53	100	402.156	33.513	
Inches of Mercury	0,03453	0.4912	0.03342	0,033864	1	3,3864	13.61	1.134	
Kilopascals	0,0101972	0.145038	0.0098696	0,01	0.2953	1	4.02156	0.33513	
Inches of Water	0,002538	0.0361	0.002456	0,00249	0.07349	0,249	1	0.0833	
Feet of Water	0,3045	0.4332	0.02947	0,029839	0.8819	2,9839	12	1	

1 ounce per square inch = 0.0625 pounds per square inch

Pressure Conversion - Pounds per Square Inch to Bar ⁽¹⁾										
POUNDS PER SQUARE INCH	0	1	2	3	4	5	6	7	8	9
	BAR									
0	0,000	0,069	0,138	0,207	0,276	0,345	0,414	0,482	0,552	0,621
10	0,689	0,758	0,827	0,896	0,965	1,034	1,103	1,172	1,241	1,310
20	1,379	1,448	1,517	1,586	1,655	1,724*	1,793	1,862	1,931	1,999
30	2,068	2,137	2,206	2,275	2,344	2,413	2,482	2,551	2,620	2,689
40	2,758	2,827	2,896	2,965	3,034	3,103	3,172	3,241	3,309	3,378
50	3,447	3,516	3,585	3,654	3,723	3,792	3,861	3,930	3,999	4,068
60	4,137	4,206	4,275	4,344	4,413	4,482	4,551	4,619	4,688	4,757
70	4,826	4,895	4,964	5,033	5,102	5,171	5,240	5,309	5,378	5,447
80	5,516	5,585	5,654	5,723	5,792	5,861	5,929	5,998	6,067	6,136
90	6,205	6,274	6,343	6,412	6,481	6,550	6,619	6,688	6,757	6,826
100	6,895	6,964	7,033	7,102	7,171	7,239	7,308	7,377	7,446	7,515

1. To convert to kilopascals, move decimal point two positions to the right; to convert to Megapascals, move decimal point one position to the left. Note: Round off decimal points to provide no more than the desired degree of accuracy.

*NOTE: To use this table, see the shaded example. 25 psig (20 from the left column plus five from the top row) = 1,724 bar

Volume Equivalents								
MULTIPLY NUMBER OF	TO OBTAIN BY	CUBIC DECIMETERS (LITERS)	CUBIC INCHES	CUBIC FEET	U.S. QUART	U.S. GALLON	IMPERIAL GALLON	U.S. BARREL (PETROLEUM)
		Cubic Decimeters (Liters)	1	61.0234	0.03531	1.05668	0.264178	0.220083
Cubic Inches	0,01639	1	5.787 x 10 ⁻⁴	1.01732	0.004329	0,003606	0.000103	
Cubic Feet	28,317	1728	1	29.9221	7.48055	6,22888	0.1781	
U.S. Quart	0,94636	57.75	0.03342	1	0.25	0,2082	0.00595	
U.S. Gallon	3,78543	231	0.13368	4	1	0,833	0.02381	
Imperial Gallon	4,54374	277.274	0.16054	4.80128	1.20032	1	0.02877	
U.S. Barrel (Petroleum)	158,98	9702	5.6146	168	42	34,973	1	

1 cubic meter = 1,000,000 cubic centimeters
1 liter = 1000 milliliters = 1000 cubic centimeters

Volume Rate Equivalents							
MULTIPLY NUMBER OF	BY	TO OBTAIN					
		LITERS PER MINUTE	CUBIC METERS PER HOUR	CUBIC FEET PER HOUR	LITERS PER HOUR	U.S. GALLONS PER MINUTE	U.S. BARRELS PER DAY
Liters per Minute		1	0,06	2.1189	60	0.264178	9.057
Cubic Meters per Hour		16,667	1	35.314	1000	4.403	151
Cubic Feet per Hour		0,4719	0,028317	1	28.317	0.1247	4.2746
Liters per Hour		0,016667	0,001	0.035314	1	0.004403	0.151
U.S. Gallons per Minute		3,785	0,2273	8.0208	227.3	1	34.28
U.S. Barrels per Day		0,1104	0,006624	0.23394	6.624	0.02917	1

Mass Conversion - Pounds to Kilograms										
LBS	0	1	2	3	4	5	6	7	8	9
	Kilograms									
0	0,00	0,45	0,91	1,36	1,81	2,27	2,72	3,18	3,63	4,08
10	4,54	4,99	5,44	5,90	6,35	6,80	7,26	7,71	8,16	8,62
20	9,07	9,53	9,98	10,43	10,89	11,34*	11,79	12,25	12,70	13,15
30	13,61	14,06	14,52	14,97	15,42	15,88	16,33	16,78	17,24	17,69
40	18,14	18,60	19,05	19,50	19,96	20,41	20,87	21,32	21,77	22,23
50	22,68	23,13	23,59	24,04	24,49	24,95	25,40	25,86	26,31	26,76
60	27,22	27,67	28,12	28,58	29,03	29,48	29,94	30,39	30,84	31,30
70	31,75	32,21	32,66	33,11	33,57	34,02	34,47	34,93	35,38	35,83
80	36,29	36,74	37,20	37,65	38,10	38,56	39,01	39,46	39,92	40,37
90	40,82	41,28	41,73	42,18	42,64	43,09	43,55	44,00	44,45	44,91

1 pound = 0,4536 kilograms

*NOTE: To use this table, see the shaded example.
25 pounds (20 from the left column plus five from the top row) = 11,34 kilograms

Area Equivalents						
MULTIPLY NUMBER OF	BY	TO OBTAIN				
		SQUARE METERS	SQUARE INCHES	SQUARE FEET	SQUARE MILES	SQUARE KILOMETERS
Square Meters		1	1549.99	10.7639	3.861 x 10 ⁻⁷	1 x 10 ⁻⁶
Square Inches		0,0006452	1	6.944 x 10 ⁻³	2.491 x 10 ⁻¹⁰	6.452 x 10 ⁻¹⁰
Square Feet		0,0929	144	1	3.587 x 10 ⁻⁸	9,29 x 10 ⁻⁸
Square Miles		2 589 999	---	27,878,400	1	2,59
Square Kilometers		1 000 000	---	10,763,867	0.3861	1

1 square meter = 10 000 square centimeters
1 square millimeter = 0,01 square centimeter = 0.00155 square inches

Temperature Conversion Formulas		
TO CONVERT FROM	TO	SUBSTITUTE IN FORMULA
Degrees Celsius	Degrees Fahrenheit	(°C x 9/5) + 32
Degrees Celsius	Kelvin	(°C + 273.16)
Degrees Fahrenheit	Degrees Celsius	(°F - 32) x 5/9
Degrees Fahrenheit	Degrees Rankin	(°F + 459.69)

Kinematic-Viscosity Conversion Formulas		
VISCOSITY SCALE	RANGE OF t, SEC	KINEMATIC VISCOSITY, STROKES
Saybolt Universal	32 < t < 100 t > 100	0.00226t - 1.95/t 0.00220t - 1.35/t
Saybolt Furol	25 < t < 40 t > 40	0.0224t - 1.84/t 0.0216t - 0.60/t
Redwood No. 1	34 < t < 100 t > 100	0.00226t - 1.79/t 0.00247t - 0.50/t
Redwood Admiralty	---	0.027t - 20/t
Engler	---	0.00147t - 3.74/t

Conversion Units		
MULTIPLY	BY	TO OBTAIN
Volume		
Cubic centimeter	0.06103	Cubic inches
Cubic feet	7.4805	Gallons (US)
Cubic feet	28.316	Liters
Cubic feet	1728	Cubic inches
Gallons (US)	0.1337	Cubic feet
Gallons (US)	3.785	Liters
Gallons (US)	231	Cubic inches
Liters	1.057	Quarts (US)
Liters	2.113	Pints (US)
Miscellaneous		
BTU	0.252	Calories
Decitherm	10,000	BTU
Kilogram	2.205	Pounds
Kilowatt Hour	3412	BTU
Ounces	28.35	Grams
Pounds	0.4536	Kilograms
Pounds	453.5924	Grams
Pounds	21,591	LPG BTU
Therm	100,000	BTU
API Bbls	42	Gallons (US)
Gallons of Propane	26.9	KWH
HP	746	KWH
HP (Steam)	42,418	BTU
Pressure		
Grams per square centimeter	0.0142	Pounds per square inch
Inches of mercury	0.4912	Pounds per square inch
Inches of mercury	1.133	Feet of water
Inches of water	0.0361	Pounds per square inch
Inches of water	0.0735	Inches of mercury
Inches of water	0.5781	Ounces per square inch
Inches of water	5.204	Pounds per foot
KPA	100	BAR
Kilograms per square centimeter	14.22	Pounds per square inch
Kilograms per square meter	0.2048	Pounds per square foot
Pounds per square inch	0.06804	Atmospheres
Pounds per square inch	0.07031	Kilograms per square centimeter
Pounds per square inch	.145	KPA
Pounds per square inch	2.036	Inches of mercury
Pounds per square inch	2.307	Feet of water
Pounds per square inch	14.5	BAR
Pounds per square inch	27.67	Inches of water
Length		
Centimeters	0.3937	Inches
Feet	0.3048	Meters
Feet	30.48	Centimeters
Feet	304.8	Millimeters
Inches	2.540	Centimeters
Inches	25.40	Millimeters
Kilometer	0.6214	Miles
Meters	1.094	Yards
Meters	3.281	Feet
Meters	39.37	Inches
Miles (nautical)	1853.0	Meters
Miles (statute)	1609.0	Meters
Yards	0.9144	Meters
Yards	91.44	Centimeters

Other Useful Conversions		
TO CONVERT FROM	TO	MULTIPLY BY
Cubic Feet of Methane	B.T.U.	1000 (approx.)
Cubic Feet of Water	Pounds of Water	62.4
Degrees	Radians	0,01745
Gallons	Pounds of Water	8.336
Grams	Ounces	0.0352
Horsepower (mech.)	Foot Pounds per Minute	33,000
Horsepower (elec.)	Watts	746
Kg	Pounds	2.205
Kg per Cubic Meter	Pounds per Cubic Feet	0.06243
Kilowatts	Horsepower	1.341
Pounds	Kg	0,4536
Pounds of Air (14.7 psia & 60°F)	Cubic Feet of Air	13.1
Pounds per Cubic Feet	Kg per Cubic Meter	16,0184
Pounds per Hour (Gas)	SCFH	13.1 ÷ Specific Gravity
Pounds per Hour (Water)	Gallons per Minute	0.002
Pounds per Second (Gas)	SCFH	46,160 ÷ Specific Gravity
Radians	Degrees	57.3
Scfh Air	Scfh Propane	0.81
Scfh Air	Scfh Butane	0.71
Scfh Air	Scfh 0.6 Natural Gas	1.29
Scfh	Cu. Meters per Hr.	0.028317

Converting Volumes of Gas		
CFH TO CFH OR CFM TO CFM		
Multiply Flow of:	By	To Obtain Flow of:
Air	0.707	Butane
	1.290	Natural Gas
	0.808	Propane
Butane	1.414	Air
	1.826	Natural Gas
	1.140	Propane
Natural Gas	0.775	Air
	0.547	Butane
	0.625	Propane
Propane	1.237	Air
	0.874	Butane
	1.598	Natural Gas

Fractional Inches to Millimeters																
INCH	0	1/16	1/8	3/16	1/4	5/16	3/8	7/16	1/2	9/16	5/8	11/16	3/4	13/16	7/8	15/16
	mm															
0	0,0	1,6	3,2	4,8	6,4	7,9	9,5	11,1	12,7	14,3	15,9	17,5	19,1	20,6	22,2	23,8
1	25,4	27,0	28,6	30,2	31,8	33,3	34,9	36,5	38,1	39,7	41,3	42,9	44,5	46,0	47,6	49,2
2	50,8	52,4	54,0	55,6	57,2	58,7	60,3	61,9	63,5	65,1	66,7	68,3	69,9	71,4	73,0	74,6
3	76,2	77,8	79,4	81,0	82,6	84,1	85,7	87,3	88,9	90,5	92,1	93,7	95,3	96,8	98,4	100,0
4	101,6	103,2	104,8	106,4	108,0	109,5	111,1	112,7	114,3	115,9	117,5	119,1	120,7	122,2	123,8	125,4
5	127,0	128,6	130,2	131,8	133,4	134,9	136,5	138,1	139,7	141,3	142,9	144,5	146,1	147,6	149,2	150,8
6	152,4	154,0	155,6	157,2	158,8	160,3	161,9	163,5	165,1	166,7	168,3	169,9	171,5	173,0	174,6	176,2
7	177,8	179,4	181,0	182,6	184,2	185,7	187,3	188,9	190,5	192,1	193,7	195,3	196,9	198,4	200,0	201,6
8	203,2	204,8	206,4	208,0	209,6	211,1	212,7	214,3	215,9	217,5	219,1	220,7	222,3	223,8	225,4	227,0
9	228,6	230,2	231,8	233,4	235,0	236,5	238,1	239,7	241,3	242,9	244,5	246,1	247,7	249,2	250,8	252,4
10	254,0	255,6	257,2	258,8	260,4	261,9	263,5	265,1	266,7	268,3	269,9	271,5	273,1	274,6	276,2	277,8

1 inch = 25,4 millimeters

*NOTE: To use this table, see the shaded example.
 2-1/2 inches (2 from the left column plus 1/2 from the top row) = 63,5 millimeters

Length Equivalents							
MULTIPLY NUMBER OF	TO OBTAIN	Meters	Inches	Feet	Millimeters	Miles	Kilometers
		BY					
Meters	1	39.37	3.2808	1000	0.0006214	0,001	
Inches	0,0254	1	0.0833	25,4	0.0001578	0,0000254	
Feet	0,3048	12	1	304,8	0.0001894	0,0003048	
Millimeters	0,001	0.03937	0.0032808	1	0.000006214	0,000001	
Miles	1609,35	63,360	5,280	1 609 350	1	1,60935	
Kilometers	1000	39,370	3280,83	1 000 000	0.62137	1	

1 meter = 100 cm = 1000 mm = 0,001 km = 1,000,000 micrometers

Whole Inch-Millimeter Equivalents										
INCH	0	1	2	3	4	5	6	7	8	9
	mm									
0	0,00	25,4	50,8	76,2	101,6	127,0	152,4	177,8	203,2	228,6
10	254,0	279,4	304,8	330,2	355,6	381,0	406,4	431,8	457,2	482,6
20	508,0	533,4	558,8	584,2	609,6	635,0	660,4	685,8	711,2	736,6
30	762,0	787,4	812,8	838,2	863,6	889,0	914,4	939,8	965,2	990,6
40	1016,0	1041,4	1066,8	1092,2	1117,6	1143,0	1168,4	1193,8	1219,2	1244,6
50	1270,0	1295,4	1320,8	1346,2	1371,6	1397,0	1422,4	1447,8	1473,2	1498,6
60	1524,0	1549,4	1574,8	1600,2	1625,6	1651,0	1676,4	1701,8	1727,2	1752,6
70	1778,0	1803,4	1828,8	1854,2	1879,6	1905,0	1930,4	1955,8	1981,2	2006,6
80	2032,0	2057,4	2082,8	2108,2	2133,6	2159,0	2184,4	2209,8	2235,2	2260,6
90	2286,0	2311,4	2336,8	2362,2	2387,6	2413,0	2438,4	2463,8	2489,2	2514,6
100	2540,0	2565,4	2590,8	2616,2	2641,6	2667,0	2692,4	2717,8	2743,2	2768,6

Note: All values in this table are exact, based on the relation 1 inch = 25,4 mm.

*NOTE: To use this table, see the shaded example.
 25 inches (20 from the left column plus five from the top row) = 635 millimeters

Metric Prefixes and Symbols		
MULTIPLICATION FACTOR	PREFIX	SYMBOL
1 000 000 000 000 000 000 = 10 ¹⁸	exa	E
1 000 000 000 000 000 = 10 ¹⁵	peta	P
1 000 000 000 000 = 10 ¹²	tera	T
1 000 000 000 = 10 ⁹	giga	G
1 000 000 = 10 ⁶	mega	M
1 000 = 10 ³	kilo	k
100 = 10 ²	hecto	h
10 = 10 ¹	deka	da
0.1 = 10 ⁻¹	deci	d
0.01 = 10 ⁻²	centi	c
0.001 = 10 ⁻³	milli	m
0.000 001 = 10 ⁻⁶	micro	μ
0.000 000 001 = 10 ⁻⁹	nano	n
0.000 000 000 001 = 10 ⁻¹²	pico	p
0.000 000 000 000 001 = 10 ⁻¹⁵	femto	f
0.000 000 000 000 000 001 = 10 ⁻¹⁸	atto	a

Greek Alphabet								
CAPS	LOWER CASE	GREEK NAME	CAPS	LOWER CASE	GREEK NAME	CAPS	LOWER CASE	GREEK NAME
A	α	Alpha	I	ι	Iota	Ρ	ρ	Rho
B	β	Beta	Κ	κ	Kappa	Σ	σ	Sigma
Γ	γ	Gamma	Λ	λ	Lambda	Τ	τ	Tau
Δ	δ	Delta	Μ	μ	Mu	Υ	υ	Upsilon
E	ε	Epsilon	Ν	ν	Nu	Φ	φ	Phi
Z	ζ	Zeta	Ξ	ξ	Xi	Χ	χ	Chi
H	η	Eta	Ο	ο	Omicron	Ψ	ψ	Psi
Θ	θ	Theta	Π	π	Pi	Ω	ω	Omega

Length Equivalents - Fractional and Decimal Inches to Millimeters											
INCHES		mm	INCHES		mm	INCHES		mm	INCHES		mm
Fractions	Decimals		Fractions	Decimals		Fractions	Decimals		Fractions	Decimals	
	.00394	.1		.23	5.842	1/2	.50	12.7		.77	19.558
	.00787	.2	15/64	.234375	5.9531		.51	12.954		.78	19.812
	.01	.254		.23622	6.0		.51181	13.0	25/32	.78125	19.8438
	.01181	.3		.24	6.096	33/64	.515625	13.0969		.78740	20.0
1/64	.015625	.3969	1/4	.25	6.35		.52	13.208		.79	20.066
	.01575	.4		.26	6.604		.53	13.462	51/64	.796875	20.2406
	.01969	.5	17/64	.265625	6.7469	17/32	.53125	13.4938		.80	20.320
	.02	.508		.27	6.858		.54	13.716		.81	20.574
	.02362	.6		.27559	7.0	35/64	.546875	13.8906	13/16	.8125	20.6375
	.02756	.7		.28	7.112		.55	13.970		.82	20.828
	.03	.762	9/32	.28125	7.1438		.55118	14.0		.82677	21.0
1/32	.03125	.7938		.29	7.366		.56	14.224	53/64	.828125	21.0344
	.0315	.8	19/64	.296875	7.5406	9/16	.5625	14.2875		.83	21.082
	.13543	.9		.30	7.62		.57	14.478		.84	21.336
	.03937	1.0		.31	7.874	37/64	.578125	14.6844	27/32	.84375	21.4312
	.04	1.016	5/16	.3125	7.9375		.58	14.732		.85	21.590
3/64	.046875	1.1906		.31496	8.0		.59	14.986	55/64	.859375	21.8281
	.05	1.27		.32	8.128		.5905	15.0		.86	21.844
	.06	1.524	21/64	.328125	8.3344	19/32	.59375	15.0812		.86614	22.0
1/16	.0625	1.5875		.33	8.382		.60	15.24		.87	22.098
	.07	1.778		.34	8.636	39/64	.609375	15.4781	7/8	.875	22.225
5/64	.078125	1.9844	11/32	.34375	8.7312		.61	15.494		.88	22.352
	.07874	2.0		.35	8.89		.62	15.748		.89	22.606
	.08	2.032		.35433	9.0	5/8	.625	15.875	57/64	.890625	22.6219
	.09	2.286	23/64	.359375	9.1281		.62992	16.0		.90	22.860
3/32	.09375	2.3812		.36	9.144		.63	16.002		.90551	23.0
	.1	2.54		.37	9.398		.64	16.256	29/32	.90625	23.0188
7/64	.109375	2.7781	3/8	.375	9.525	41/64	.640625	16.2719		.91	23.114
	.11	2.794		.38	9.652		.65	16.510		.92	23.368
	.11811	3.0		.39	9.906	21/32	.65625	16.6688	59/64	.921875	23.1456
	.12	3.048	25/64	.390625	9.9219		.66	16.764		.93	23.622
1/8	.125	3.175		.39370	10.0		.66929	17.0	15/16	.9375	23.8125
	.13	3.302		.40	10.16		.67	17.018		.94	23.876
	.14	3.556	13/32	.40625	10.3188	43/64	.671875	17.0656		.94488	24.0
9/64	.140625	3.5719		.41	10.414		.68	17.272		.95	24.130
	.15	3.810		.42	10.668	11/16	.6875	17.4625	61/64	.953125	24.2094
5/32	.15625	3.9688	27/64	.421875	10.7156		.69	17.526		.96	24.384
	.15748	4.0		.43	10.922		.70	17.78	31/32	.96875	24.6062
	.16	4.064		.43307	11.0	45/64	.703125	17.8594		.97	24.638
	.17	4.318	7/16	.4375	11.1125		.70866	18.0		.98	24.892
11/64	.171875	4.3656		.44	11.176		.71	18.034		.98425	25.0
	.18	4.572		.45	11.430	23/32	.71875	18.2562	63/64	.984375	25.0031
3/16	.1875	4.7625	29/64	.453125	11.5094		.72	18.288		.99	25.146
	.19	4.826		.46	11.684		.73	18.542	1	1.00000	25.4000
	.19685	5.0	15/32	.46875	11.9062	47/64	.734375	18.6531			
	.2	5.08		.47	11.938		.74	18.796			
13/64	.203125	5.1594		.47244	12.0		.74803	19.0			
	.21	5.334		.48	12.192	3/4	.75	19.050			
7/32	.21875	5.5562	31/64	.484375	12.3031		.76	19.304			
	.22	5.588		.49	12.446	49/64	.765625	19.4469			

Note: Round off decimal points to provide no more than the desired degree of accuracy.

Temperature Conversions											
°C	TEMP. IN °C OR °F TO BE CONVERTED	°F	°C	TEMP. IN °C OR °F TO BE CONVERTED	°F	°C	TEMP. IN °C OR °F TO BE CONVERTED	°F	°C	TEMP. IN °C OR °F TO BE CONVERTED	°F
-273,16	-459,69		-90,00	-130	-202,0	-17,8	0	32,0	21,1	70	158,0
-267,78	-450		-84,44	-120	-184,0	-16,7	2	35,6	22,2	72	161,6
-262,22	-440		-78,89	-110	-166,0	-15,6	4	39,2	23,3	74	165,2
-256,67	-430		-73,33	-100	-148,0	-14,4	6	42,8	24,4	76	168,8
-251,11	-420		-70,56	-95	-139,0	-13,3	8	46,4	25,6	78	172,4
-245,56	-410		-67,78	-90	-130,0	-12,2	10	50,0	26,7	80	176,0
-240,00	-400		-65,00	-85	-121,0	-11,1	12	53,6	27,8	82	179,6
-234,44	-390		-52,22	-80	-112,0	-10,0	14	57,2	28,9	84	183,2
-228,89	-380		-59,45	-75	-103,0	-8,89	16	60,8	30,0	86	186,8
-223,33	-370		-56,67	-70	-94,0	-7,78	18	64,4	31,1	88	190,4
-217,78	-360		-53,89	-65	-85	-6,67	20	68,0	32,2	90	194,0
-212,22	-350		-51,11	-60	-76,0	-5,56	22	71,6	33,3	92	197,6
-206,67	-340		-48,34	-55	-67,0	-4,44	24	75,2	34,4	94	201,2
-201,11	-330		-45,56	-50	-58,0	-3,33	26	78,8	35,6	96	204,8
-195,56	-320		-42,78	-45	-49,0	-2,22	28	82,4	36,7	98	208,4
-190,00	-310		-40,00	-40	-40,0	-1,11	30	86,0	37,8	100	212,0
-184,44	-300		-38,89	-38	-36,4	0	32	89,6	43,3	110	230,0
-178,89	-290		-37,78	-36	-32,8	1,11	34	93,2	48,9	120	248,0
-173,33	-280		-36,67	-34	-29,2	2,22	36	96,8	54,4	130	266,0
-169,53	-273,16	-459,69	-35,56	-32	-25,6	3,33	38	100,4	60,0	140	284,0
-168,89	-272	-457,6	-34,44	-30	-22,0	4,44	40	104,0	65,6	150	302,0
-167,78	-270	-454,0	-33,33	-28	-18,4	5,56	42	107,6	71,1	160	320,0
-162,22	-260	-436,0	-32,22	-26	-14,8	6,67	44	111,2	76,7	170	338,0
-156,67	-250	-418,0	-31,11	-24	-11,2	7,78	46	114,8	82,2	180	356,0
-151,11	-240	-400,0	-30,00	-22	-7,6	8,89	48	118,4	87,8	190	374,0
-145,56	-230	-382,0	-28,89	-20	-4,0	10,0	50	122,0	93,3	200	392,0
-140,00	-220	-364,0	-27,78	-18	-0,4	11,1	52	125,6	98,9	210	410,0
-134,44	-210	-356,0	-26,67	-16	3,2	12,2	54	129,2	104,4	220	428,0
-128,89	-200	-328,0	-25,56	-14	6,8	13,3	56	132,8	110,0	230	446,0
-123,33	-190	-310,0	-24,44	-12	10,4	14,4	58	136,4	115,6	240	464,0
-117,78	-180	-292,0	-23,33	-10	14,0	15,6	60	140,0	121,1	250	482,0
-112,22	-170	-274,0	-22,22	-8	17,6	16,7	62	143,6	126,7	260	500,0
-106,67	-160	-256,0	-21,11	-6	21,2	17,8	64	147,2	132,2	270	518,0
-101,11	-150	-238,0	-20,00	-4	24,8	18,9	66	150,8	137,8	280	536,0
-95,56	-140	-220,0	-18,89	-2	28,4	20,0	68	154,4	143,3	290	665,0

- continued -

Temperature Conversions (continued)								
°C	TEMP. IN °C OR °F TO BE CONVERTED	°F	°C	TEMP. IN °C OR °F TO BE CONVERTED	°F	°C	TEMP. IN °C OR °F TO BE CONVERTED	°F
21,1	70	158.0	204,4	400	752.0	454,4	850	1562.0
22,2	72	161.6	210,0	410	770.0	460,0	860	1580.0
23,3	74	165.2	215,6	420	788.0	465,6	870	1598.0
24,4	76	168.8	221,1	430	806.0	471,1	880	1616.0
25,6	78	172.4	226,7	440	824.0	476,7	890	1634.0
26,7	80	176.0	232,2	450	842.0	482,2	900	1652.0
27,8	82	179.6	237,8	460	860.0	487,8	910	1670.0
28,9	84	183.2	243,3	470	878.0	493,3	920	1688.0
30,0	86	186.8	248,9	480	896.0	498,9	930	1706.0
31,1	88	190.4	254,4	490	914.0	504,4	940	1724.0
32,2	90	194.0	260,0	500	932.0	510,0	950	1742.0
33,3	92	197.6	265,6	510	950.0	515,6	960	1760.0
34,4	94	201.2	271,1	520	968.0	521,1	970	1778.0
35,6	96	204.8	276,7	530	986.0	526,7	980	1796.0
36,7	98	208.4	282,2	540	1004.0	532,2	990	1814.0
37,8	100	212.0	287,8	550	1022.0	537,8	1000	1832.0
43,3	110	230.0	293,3	560	1040.0	543,3	1010	1850.0
48,9	120	248.0	298,9	570	1058.0	548,9	1020	1868.0
54,4	130	266.0	304,4	580	1076.0	554,4	1030	1886.0
60,0	140	284.0	310,0	590	1094.0	560,0	1040	1904.0
65,6	150	302.0	315,6	600	1112.0	565,6	1050	1922.0
71,1	160	320.0	321,1	610	1130.0	571,1	1060	1940.0
76,7	170	338.0	326,7	620	1148.0	576,7	1070	1958.0
82,2	180	356.0	332,2	630	1166.0	582,2	1080	1976.0
87,8	190	374.0	337,8	640	1184.0	587,8	1090	1994.0
93,3	200	392.0	343,3	650	1202.0	593,3	1100	2012.0
98,9	210	410.0	348,9	660	1220.0	598,9	1110	2030.0
104,4	220	428.0	354,4	670	1238.0	604,4	1120	2048.0
110,0	230	446.0	360,0	680	1256.0	610,0	1130	2066.0
115,6	240	464.0	365,6	690	1274.0	615,6	1140	2084.0
121,1	250	482.0	371,1	700	1292.0	621,1	1150	2102.0
126,7	260	500.0	376,7	710	1310.0	626,7	1160	2120.0
132,2	270	518.0	382,2	720	1328.0	632,2	1170	2138.0
137,8	280	536.0	287,8	730	1346.0	637,8	1180	2156.0
143,3	290	665.0	393,3	740	1364.0	643,3	1190	2174.0

- continued -

Temperature Conversions (continued)											
°C	TEMP. IN °C OR °F TO BE CONVERTED	°F	°C	TEMP. IN °C OR °F TO BE CONVERTED	°F	°C	TEMP. IN °C OR °F TO BE CONVERTED	°F	°C	TEMP. IN °C OR °F TO BE CONVERTED	°F
148,9	300	572.0	315,6	600	1112.0	482,2	900	1652.0	648,9	1200	2192.0
154,4	310	590.0	321,1	610	1130.0	487,8	910	1670.0	654,4	1210	2210.0
160,0	320	608.0	326,7	620	1148.0	493,3	920	1688.0	660,0	1220	2228.0
165,6	330	626.0	332,2	630	1166.0	498,9	930	1706.0	665,6	1230	2246.0
171,1	340	644.0	337,8	640	1184.0	504,4	940	1724.0	671,1	1240	2264.0
176,7	350	662.0	343,3	650	1202.0	510,0	950	1742.0	676,7	1250	2282.0
182,2	360	680.0	348,9	660	1220.0	515,6	960	1760.0	682,2	1260	2300.0
187,8	370	698.0	354,4	670	1238.0	521,1	970	1778.0	687,8	1270	2318.0
189,9	380	716.0	360,0	680	1256.0	526,7	980	1796.0	693,3	1280	2336.0
193,3	390	734.0	365,6	690	1274.0	532,2	990	1814.0	698,9	1290	2354.0
204,4	400	752.0	371,1	700	1292.0	537,8	1000	1832.0	704,4	1300	2372.0
210,0	410	770.0	376,7	710	1310.0	543,3	1010	1850.0	710,0	1310	2390.0
215,6	420	788.0	382,2	720	1328.0	548,9	1020	1868.0	715,6	1320	2408.0
221,1	430	806.0	387,8	730	1346.0	554,4	1030	1886.0	721,1	1330	2426.0
226,7	440	824.0	393,3	740	1364.0	560,0	1040	1904.0	726,7	1340	2444.0
232,2	450	842.0	398,9	750	1382.0	565,6	1050	1922.0	732,2	1350	2462.0
237,8	460	860.0	404,4	760	1400.0	571,1	1060	1940.0	737,8	1360	2480.0
243,3	470	878.0	410,0	770	1418.0	576,7	1070	1958.0	743,3	1370	2498.0
248,9	480	896.0	415,6	780	1436.0	582,2	1080	1976.0	748,9	1380	2516.0
254,4	490	914.0	421,1	790	1454.0	587,8	1090	1994.0	754,4	1390	2534.0
260,0	500	932.0	426,7	800	1472.0	593,3	1100	2012.0	760,0	1400	2552.0
265,6	510	950.0	432,2	810	1490.0	598,9	1110	2030.0	765,6	1410	2570.0
271,1	520	968.0	437,8	820	1508.0	604,4	1120	2048.0	771,1	1420	2588.0
276,7	530	986.0	443,3	830	1526.0	610,0	1130	2066.0	776,7	1430	2624.0
282,2	540	1004.0	448,9	840	1544.0	615,6	1140	2084.0	782,2	1440	2624.0
287,8	550	1022.0	454,4	850	1562.0	621,1	1150	2102.0	787,8	1450	2642.0
293,3	560	1040.0	460,0	860	1580.0	626,7	1160	2120.0	793,3	1450	2642.0
298,9	570	1058.0	465,6	870	1598.0	632,2	1170	2138.0	798,9	1470	2678.0
304,4	580	1076.0	471,1	880	1616.0	637,8	1180	2156.0	804,4	1480	2696.0
310,0	590	1094.0	476,7	890	1634.0	643,3	1190	2174.0	810,0	1490	2714.0

A.P.I. and Baumé Gravity Tables and Weight Factors

A.P.I. Gravity	Baumé Gravity	Specific Gravity	Lbs/U.S. Gallons	U.S. Gallons-/Lb	A.P.I. Gravity	Baumé Gravity	Specific Gravity	Lbs/U.S. Gallons	U.S. Gallons-/Lb	A.P.I. Gravity	Baumé Gravity	Specific Gravity	Lbs/U.S. Gallons	U.S. Gallons-/Lb	A.P.I. Gravity	Baumé Gravity	Specific Gravity	Lbs/U.S. Gallons	U.S. Gallons-/Lb
0	10.247	1.0760	8.962	0.1116															
1	9.223	1.0679	8.895	0.1124	31	30.78	0.9808	7.251	0.1379	61	60.46	0.7351	6.119	0.1634	81	80.25	0.6659	5.542	0.1804
2	8.198	1.0599	8.828	0.1133	32	31.77	0.8654	7.206	0.1388	62	61.45	0.7313	6.087	0.1643	82	81.24	0.6628	5.516	0.1813
3	7.173	1.0520	8.762	0.1141	33	332.76	0.8602	7.163	0.1396	63	62.44	0.7275	6.056	0.1651	83	82.23	0.6597	5.491	0.1821
4	6.148	1.0443	8.698	0.1150	34	33.75	0.8550	7.119	0.1405	64	63.43	0.7238	6.025	0.1660	84	83.22	0.6566	5.465	0.1830
5	5.124	1.0366	8.634	0.1158	35	34.73	0.8498	7.075	0.1413	65	64.42	0.7201	6.994	0.1668	85	84.20	0.6536	5.440	0.1838
6	4.099	1.0291	8.571	0.1167	36	35.72	0.8448	7.034	0.1422	66	65.41	0.7165	5.964	0.1677	86	85.19	0.6506	5.415	0.1847
7	3.074	1.0217	8.509	0.1175	37	36.71	0.8398	6.993	0.1430	67	66.40	0.7128	5.934	0.1685	87	86.18	0.6476	5.390	0.1855
8	2.049	1.0143	8.448	0.1184	38	37.70	0.8348	6.951	0.1439	68	67.39	0.7093	5.904	0.1694	88	87.17	0.6446	5.365	0.1864
9	1.025	1.0071	8.388	0.1192	39	38.69	0.8299	6.910	0.1447	69	68.37	0.7057	5.874	0.1702	89	88.16	0.6417	5.341	0.1872
10	10.00	1.0000	8.328	0.1201	40	39.68	0.8251	6.870	0.1456	70	69.36	0.7022	5.845	0.1711	90	89.15	0.6388	5.316	0.1881
11	10.99	0.9930	8.270	0.1209	41	40.67	0.8203	6.830	0.1464	71	70.35	0.6988	5.817	0.1719	91	90.14	0.6360	5.293	0.1889
12	11.98	0.9861	8.212	0.1218	42	41.66	0.8155	6.790	0.1473	72	71.34	0.6953	5.788	0.1728	92	91.13	0.6331	5.269	0.1898
13	12.97	0.9792	8.155	0.1226	43	42.65	0.8109	6.752	0.1481	73	72.33	0.6919	5.759	0.1736	93	92.12	0.6303	5.246	0.1906
14	13.96	0.9725	8.099	0.1235	44	43.64	0.8063	6.713	0.1490	74	73.32	0.6886	5.731	0.1745	94	93.11	0.6275	5.222	0.1915
15	14.95	0.9659	8.044	0.1243	45	44.63	0.8017	6.675	0.1498	75	74.31	0.6852	5.703	0.1753	95	94.10	0.6247	5.199	0.1924
16	15.94	0.9593	7.989	0.1252	46	45.62	0.7972	6.637	0.1507	76	75.30	0.6819	5.676	0.1762	96	95.09	0.6220	5.176	0.1932
17	16.93	0.9529	7.935	0.1260	47	50.61	0.7927	6.600	0.1515	77	76.29	0.6787	5.649	0.1770	97	96.08	0.6193	5.154	0.1940
18	17.92	0.9465	7.882	0.1269	48	50.60	0.7883	6.563	0.1524	78	77.28	0.6754	5.622	0.1779	98	97.07	0.6166	5.131	0.1949
19	18.90	0.9402	7.930	0.1277	49	50.59	0.7839	6.526	0.1532	79	78.27	0.6722	5.595	0.1787	99	98.06	0.6139	5.109	0.1957
20	19.89	0.9340	7.778	0.1286	50	50.58	0.7796	6.490	0.1541	80	79.26	0.6690	5.568	0.1796	100	99.05	0.6112	5.086	0.1966
21	20.88	0.9279	7.727	0.1294	51	50.57	0.7753	6.455	0.1549	The relation of Degrees Baume or A.P.I. to Specific Gravity is expressed by these formulas: For liquids lighter than water: $D = \frac{140}{G - 130}$ $G = \frac{140}{130 + \text{Degrees Baume}}$ For liquids heavier than water: $D = \frac{145}{145 - G}$ $G = \frac{145}{145 - \text{Degrees Baume}}$ Degrees A.P.I. = $\frac{141}{5} - 1315 G = \frac{1415}{1315 + \text{Degrees A.P.I.}}$ G = Specific Gravity = ratio of weight of a given volume of oil at 60°F to the weight of the same volume of water at 60°F. The above tables are based on the weight of 1 gallon (U.S.) of oil with a volume of 231 cubic inches at 60°F in air at 760 mm pressure and 50% relative humidity. Assumed weight of 1 gallon of water at 60°F in air is 8.32828 pounds. To determine the resulting gravity by mixing oils of different gravities: $D = \frac{m d_1 + n d_2}{m + n}$ D = Density or Specific Gravity of mixture m = Proportion of oil of d ₁ density n = Proportion of oil of d ₂ density d ₁ = Specific gravity of m oil d ₂ = Specific Gravity of n oil									
22	21.87	0.9218	7.676	0.1303	52	51.55	0.7711	6.420	0.1558										
23	22.86	0.9159	7.627	0.1311	53	52.54	0.7669	6.385	0.1566										
24	23.85	0.9100	7.578	0.1320	54	53.53	0.7628	6.350	0.1575										
25	24.84	0.9042	7.529	0.1328	55	54.52	0.7587	6.316	0.1583										
26	25.83	0.8984	7.481	0.1337	56	55.51	0.7547	6.283	0.1592										
27	26.82	0.8927	7.434	0.1345	57	56.50	0.7507	6.249	0.1600										
28	27.81	0.8871	7.387	0.1354	58	57.49	0.7467	6.216	0.1609										
29	28.80	0.8816	7.341	0.1362	59	58.48	0.7428	6.184	0.1617										
30	29.79	0.8762	7.296	0.1371	60	59.47	0.7389	6.151	0.1626										

Characteristics of the Elements											
Element	Symbol	Atomic Number	Mass Number ⁽¹⁾	Melting Point (°C)	Boiling Point (°C)	Element	Symbol	Atomic Number	Mass Number ⁽¹⁾	Melting Point (°C)	Boiling Point (°C)
actinium	Ac	89	(227)	1600†		neon	Ne	10	20	-248.67	-245.9
aluminum	Al	13	27	659.7	2057	neptunium	Np	93	(237)		
americum	Am	95	(243)			nickel	Ni	28	58	1455	2900
antimony	Sb	51	121	630.5	1380	niobium	Nb	41	93	2500±50	3700
(stibium)											
argon	Ar	18	40	-189.2	-185.7	nitrogen	N	7	14	-209.86	-195.8
arsenic	As	33	75	sublimes at 615	sublimes at 615	nobelium	No	102	(253)		
astatine	At	85	(210)			osmium	Os	76	192	2700	>5300
barium	Ba	56	138	850	1140	oxygen	O	8	16	-218.4	-182.86
berkelium	Bk	97	(247)			palladium	Pd	46	106	1549.4	2000
beryllium	Be	4	9	1278 ± 5	2970	phosphorus	P	15	31		
bismuth	Bi	83	209	271.3	1560±5	platinum	Pt	78	195	1773.5	4300
boron	B	5	11	2300	2550	plutonium	Pu	94	(242)		
bromine	Br	35	79	-7.2	58.78	polonium	Po	84	(209)		
cadmium	Cd	48	114	320.9	767±2	potassium	K	19	39	53.3	760
calcium	Ca	20	40	842±8	1240	praseodymium	Pr	59	141	940	
californium	Cf	98	(249)			promethium	Pm	61	(145)		
carbon	C	6	12	>3550	4200	protactinium	Pa	91	(231)		
cerium	Ce	58	140	804	1400	radium	Ra	88	(226)	700	
cesium	Cs	55	133	28.5	670	radon	Rn	86	(222)	-71	1140
chlorine	Cl	17	35	-103±5	-34.6	rehenium	Re	75	187	3167±60	-61.8
chromium	Cr	24	52	1890	2480	rhodium	Rh	45	103	1966±3	>2500
cobalt	Co	27	59	1495	2900	rubidium	Rb	37	85	38.5	700
copper	Cu	29	63	1083	2336	ruthenium	Ru	44	102	2450	2700
curium	Cm	96	(248)			samarium	Sm	62	152	>1300	
dysprosium	Dy	66	164			scandium	Sc	21	45	1200	2400
einsteinium	Es	99	(254)			selenium	Se	34	80	217	688
erbium	Er	68	166			silicon	Si	14	28	1420	2355
europium	Eu	63	153	1150±50		silver	Ag	47	107	960.8	1950
fermium	Fm	100	(252)			sodium	Na	11	23	97.5	880
fluorine	F	9	19	-223	-188	strontium	Sr	38	88	800	1150
francium	Fr	87	(223)			sulfur	S	16	32		
gadolinium	Gd	64	158			tantalum	Ta	73	180	2996±50	c.4100
gallium	Ga	31	69	29.78	1983	technetium	Tc	43	(99)		
germanium	Ge	32	74	958.5	2700	tellurium	Te	52	130	452	1390
gold	Au	79	197	1063	2600	terbium	Tb	65	159	327±5	
hafnium	Hf	72	180	1700 ⁽²⁾	>3200	thallium	Tl	81	205	302	1457±10
helium	He	2	4	-272	-268.9	thorium	Th	90	232	1845	4500
holmium	Ho	67	165			thulium	Tm	69	169		
hydrogen	H	1	1	-259.14	-252.8	tin	Sn	50	120	231.89	2270
indium	In	49	115	156.4	2000±10	titanium	Ti	22	48	1800	>3000
iodine	I	53	127	113.7	184.35	tungsten (wolfram)	W	74	184	3370	5900
irridium	Ir	77	193	2454	>4800	uranium	U	92	238	c.1133	
iron	Fe	26	56	1535	3000	vanadium	V	23	51	1710	3000
krypton	Kr	36	84	-156.6	-152.9	xenon	Xe	54	132	-112	-107.1
lanthanum	La	57	139	826		ytterbium	Yb	70	174	1800	
lawrencium	Lw	103	(257)			yttrium	Y	39	89	1490	2500
lead	Pb	82	208	327.43	1620	zinc	Zn	30	64	419.47	907
lithium	Li	3	7	186	1336±5	zirconium	Zr	40	90	1857	>2900
lutetium	Lu	71	175								
magnesium	Mg	12	24	651	1107						
manganese	Mn	25	55	1260	1900						
mendelevium	Mv	101	(256)								
mercury	Hg	80	202	-38.87	356.58						
molybdenum	Mo	42	98	2620±10	4800						
neodymium	Nd	60	142	840							

1. Mass number shown is that of the stable isotope most common in nature. Mass numbers shown in parentheses designate the isotope with the longest half-life (slowest rate of radioactive decay) for those elements having an unstable isotope.
 2. Calculated
 > Greater than.

Recommended Standard Specifications for Valve Materials Pressure-Containing Castings			
1	Carbon Steel ASTM A216 Grade WCB Temp. range = -20°F to 1000°F Composition (Percent) C 0.30 max Mn 1.00 max P 0.05 max S 0.06 max Si 0.60 max	2	Carbon Steel ASTM A352 Grade LCB Temp. range = -50°F to 650°F Composition: same as ASTM A216 Grade WCB
3	Chrome Moly Steel ASTM A217 Grade C5 Temp. range = -20°F to 1100°F Composition (Percent) C 0.20 max Mn 0.40 to 0.70 P 0.05 max S 0.06 max Si 0.75 max Cr 4.00 to 6.50 Mo 0.45 to 0.65	4	Carbon Moly Steel ASTM A217 Grade WC1 Temp. range = -20°F to 850°F Composition (Percent) C 0.25 Mn 0.50 to 0.80 P 0.05 max S 0.06 max Si 0.60 max Mo 0.45 to 0.65
5	Chrome Moly Steel ASTM A217 Grade WC6 Temp. range = -20°F to 1000°F Composition (Percent) C 0.20 max Mn 0.50 to 0.80 P 0.05 max S 0.06 max Si 0.60 max Cr 1.00 to 1.50 Mo 0.45 to 0.65	6	Chrome Moly Steel ASTM A217 Grade WC9 Temp. range = -20°F to 1050°F Composition (Percent) C 0.18 max Mn 0.40 to 0.70 P 0.05 max Si 0.60 max Cr 2.00 to 2.75 Mo 0.90 to 1.20
7	3 1/2% Nickel Steel ASTM A352 Grade LC3 Temp. range = -150°F to 650°F Composition (Percent) C 0.15 max Mn 0.50 to 0.80 P 0.05 max S 0.05 max Si 0.60 max Ni 3.00 to 4.00	8	Chrome Moly Steel ASTM A217 Grade C12 Temp. range = -20°F to 1100°F Composition (Percent) C 0.20 max Si 1.00 max Mn 0.35 to 0.65 Cr 8.00 to 10.00 Mo 0.90 to 1.20 P 0.05 max S 0.06 max
9	Type 304 Stainless Steel ASTM A351 Grade CF-8 Temp. range = -425°F to 1500°F Composition (Percent) C 0.08 max Mn 1.50 max Si 2.00 max S 0.04 max P 0.04 max Cr 18.00 to 21.00 Ni 8.00 to 11.00	10	Type 316 Stainless Steel ASTM A351 Grade CF-8M Temp. range = -425°F to 1500°F Composition (Percent) C 0.08 max Mn 1.50 max Si 2.00 max P 0.04 max S 0.04 max Cr 18.00 to 21.00 Ni 9.00 to 12.00 Mo 2.00 to 3.00
		11	Cast Iron ASTM A126 Class B Temp. range = -150°F to 450°F Composition (Percent) P 0.75 max S 0.12 max
		12	Cast Iron ASTM A126 Class C Temp. range = -150°F to 450°F Composition (Percent) P 0.75 max S 0.12 max
		13	Ductile Iron ASTM A395 Type 60-45-15 Temp. range = -20°F to 650°F Composition (Percent) C 3.00 min Si 2.75 max P 0.08 max
		14	Ductile Ni-Resist* Iron ASTM A439 Type D-2B Temp. range = -20°F to 750°F Composition (Percent) C 3.00 max Si 1.50 to 3.00 Mn 0.70 to 1.25 P 0.08 max Ni 18.00 to 22.00 Cr 2.75 to 4.00
		15	Standard Valve Bronze ASTM B62 Temp. range = -325°F to 450°F Composition (Percent) Cu 84.00 to 86.00 Sn 4.00 to 6.00 Pb 4.00 to 6.00 Zn 4.00 to 6.00 Ni 1.00 max Fe 0.30 max P 0.05 max
		16	Tin Bronze ASTM B143 Alloy 1A Temp. range = -325°F to 400°F Composition (Percent) Cu 86.00 to 89.00 Sn 9.00 to 11.00 Pb 0.30 max Zn 1.00 to 3.00 Ni 1.00 max Fe 0.15 max P 0.05 max
		17	Manganese Bronze ASTM B147 Alloy 8A Temp. range = -325°F to 350°F Composition (Percent) Cu 55.00 to 60.00 Sn 1.00 max Pb 0.40 max Ni 0.50 max Fe 0.40 to 2.00 Al 0.50 to 1.50 Mn 1.50 max Zn Remainder
		18	Aluminum Bronze ASTM B148 Alloy 9C Temp. range = -325°F to 500°F Composition (Percent) Cu 83.00 min Al 10.00 to 11.50 Fe 3.00 to 5.00 Mn 0.50 Ni 2.50 max Min. total named elements = 99.5
		19	Mondel* Alloy 411 (Weldable Grade) Temp. range = -325°F to 900°F Composition (Percent) Ni 60.00 min Cu 26.00 to 33.00 C 0.30 max Mn 1.50 max Fe 3.50 max S 0.015 max Si 1.00 to 2.00 Nb 1.00 to 3.00
		20	Nickel-Moly Alloy "B" ASTM A494 (Hastelloy "B" †) Temp. range = -325°F to 700°F Composition (Percent) Cr 1.00 max Fe 4.00 to 6.00 C 0.12 max Si 1.00 max Co 2.50 max Mn 1.00 max V 0.20 to 0.60 Mo 26.00 to 30.00 P 0.04 max S 0.03 max Ni Remainder

- continued -

Recommended Standard Specifications for Valve Materials Pressure-Containing Castings (continued)			
<p>21 Nickel-Moly-Chrome Alloy "C" ASTM A494 (Hastelloy "C" †)</p> <p>Temp. range = -325°F to 1000°F Composition (Percent)</p> <p>Cr 15.50 to 17.50 Fe 4.50 to 7.50 W 3.75 to 5.25 C 0.12 max Si 1.00 max Co 2.50 max Mn 1.00 max V 0.20 to 0.40 Mo 16.00 to 18.00 P 0.04 S 0.03 Ni Remainder</p>	<p>22 Cobalt-based Alloy No. 6 Stellite † No. 6</p> <p>Composition (Percent)</p> <p>C 0.90 to 1.40 Mn 1.00 W 3.00 to 6.00 Ni 3.00 Cr 26.00 to 32.00 Mo 1.00 Fe 3.00 Se 0.40 to 2.00 Co Remainder</p>	<p>31 Type 316 Stainless Steel ASTM A276 Type 316</p> <p>Composition (Percent)</p> <p>C 0.08 max Mn 2.00 max P 0.045 max S 0.030 max Si 1.00 max Cr 16.00 to 18.00 Ni 10.00 to 14.00 Mo 2.00 to 3.00</p>	<p>32 Type 316L Stainless Steel ASTM A276 Type 316L</p> <p>Composition (Percent)</p> <p>C 0.03 max Mn 2.00 max P 0.045 max S 0.030 max Si 1.00 max Cr 16.00 to 18.00 Ni 10.00 to 14.00 Mo 2.00 to 3.00</p>
<p>23 Aluminum Bar ASTM B211 Alloy 20911-T3</p> <p>Composition (Percent)</p> <p>Si 0.40 max Fe 0.70 max Cu 5.00 to 6.00 Zn 0.30 max Bi 0.20 to 0.60 Pb 0.20 to 0.60 Other Elements 0.15 max Al Remainder</p>	<p>24 Yellow Brass Bar ASTM B16 1/2 Hard</p> <p>Composition (Percent)</p> <p>Cu 60.00 to 63.00 Pb 2.50 to 3.70 Fe 0.35 max Zn Remainder</p>	<p>33 Type 410 Stainless Steel ASTM A276 Type 410</p> <p>Composition (Percent)</p> <p>C 0.15 max Mn 1.00 max P 0.040 max S 0.030 max Si 1.00 max Cr 11.50 to 13.50 Al 0.10 to 0.30</p>	<p>34 Type 17-4PH Stainless Steel ASTM A461 Grade 630</p> <p>Composition (Percent)</p> <p>C 0.07 max Mn 1.00 max Si 1.00 max P 0.04 max S 0.03 max Cr 15.50 to 17.50 Nb 0.05 to 0.45 Cu 3.00 to 5.00 Ni 3.00 to 5.00 Fe Remainder</p>
<p>25 Naval Brass Bar ASTM B21 Allow 464</p> <p>Composition (Percent)</p> <p>Cu 59.00 to 62.00 Sn 0.50 to 1.00 Pb 0.20 max Zn Remainder</p>	<p>26 Leaded Steel Bar AISI 12L14</p> <p>Composition (Percent)</p> <p>C 0.15 max Mn 0.80 to 1.20 P 0.04 to 0.09 S 0.25 to 0.35 Pb 0.15 to 0.35</p>	<p>35 Nickel-Copper Alloy Bar Alloy K500 (K Monel*)</p> <p>Composition (Percent)</p> <p>Ni 63.00 to 70.00 Fe 2.00 max Mn 1.50 max Si 1.00 max C 0.25 max S 0.01 max Al 2.00 to 4.00 Ti 0.25 to 1.00 Cu Remainder</p>	<p>36 Nickel-Moly Alloy "B" Bar ASTM B335 (Hastelloy "B" †)</p> <p>Composition (Percent)</p> <p>Cr 1.00 max Fe 4.00 to 6.00 C 0.04 max Si 1.00 max Co 2.50 max Mn 1.00 max V 0.20 to 0.40 Mo 26.00 to 30.00 P 0.025 max S 0.030 max Ni Remainder</p>
<p>27 Carbon Steel Bar ASTM A108 Grade 1018</p> <p>Composition (Percent)</p> <p>C 0.15 to 0.20 Mn 0.60 to 0.90 P 0.04 max S 0.05 max</p>	<p>28 AISI 4140 Chrome-Moly Steel (Suitable for ASTM A193 Grade B7 bolt material)</p> <p>Composition (Percent)</p> <p>C 0.38 to 0.43 Mn 0.75 to 1.00 P 0.035 max S 0.04 max Si 0.20 to 0.35 Cr 0.80 to 1.10 Mo 0.15 to 0.25 Fe Remainder</p>	<p>37 Nickel-Moly-Chrome Alloy "C" Bar ASTM B336 (Hastelloy "C" †)</p> <p>Composition (Percent)</p> <p>Cr 14.50 to 16.50 Fe 4.00 to 7.00 W 3.00 to 4.50 C 0.08 max Si 1.00 max Co 2.50 max Mn 1.00 max Va 0.35 max Mo 15.00 to 17.00 P 0.04 S 0.03 Ni Remainder</p>	
<p>29 Type 302 Stainless Steel ASTM A276 Type 302</p> <p>Composition (Percent)</p> <p>C 0.15 max Mn 2.00 max P 0.045 max S 0.030 max Si 1.00 max Cr 17.00 to 19.00 Ni 8.00 to 10.00</p>	<p>30 Type 304 Stainless Steel ASTM A276 Type 304</p> <p>Composition (Percent)</p> <p>C 0.08 max Mn 2.00 max P 0.045 max S 0.030 max Si 1.00 max Cr 18.00 to 20.00 Ni 8.00 to 12.00</p>		

Recommended Standard Specifications for Valve Materials Pressure-Containing Castings								
MATERIAL CODE AND DESCRIPTION		MINIMUM PHYSICAL PROPERTIES				MODULUS OF ELASTICITY AT 70°F (PSI x 10 ⁶)	APPROXIMATE BRINELL HARDNESS	
		Tensile (Psi)	Yield Point (Psi)	Elong. in 2" (%)	Reduction of Area (%)			
1	Carbon Steel	ASTM A 216 Grade WCB	70,000	36,000	22	35	27.9	137-187
2	Carbon Steel	ASTM A 352 Grade LCB	65,000	35,000	24	35	27.9	137-187
3	Chrome Moly Steel	ASTM A217 Grade C5	90,000	60,000	18	35	27.4	241 Max.
4	Carbon Moly Steel	ASTM A217 Grade WC1	65,000	35,000	24	35	29.9	215 Max.
5	Chrome Moly Steel	ASTM A217 Grade WC6	70,000	40,000	20	35	29.9	215 Max.
6	Chrome Moly Steel	ASTM A217 Grade WC9	70,000	40,000	20	35	29.9	241 Max.
7	3 1/2% Nickel Steel	ASTM A352 Grade LC3	65,000	40,000	24	35	27.9	137
8	Chrome Moly Steel	ASTM A217 Grade C12	90,000	60,000	18	35	27.4	180-240
9	Type 304 Stainless Steel	ASTM A351 Grade CF-8	65,000	28,000	35	---	28.0	140
10	Type 316 Stainless Steel	ASTM A351 Grade CF-8M	70,000	30,000	30	---	28.3	156-170
11	Cast Iron	ASTM A126 Class B	31,000	---	---	---	---	160-220
12	Cast Iron	ASTM A126 Class C	41,000	---	---	---	---	160-220
13	Ductile Iron	ASTM A395 Type 60-45-15	60,000	45,000	15	---	23-26	143-207
14	Ductile Ni-Resist Iron ⁽¹⁾	ASTM A439 Type D-2B	58,000	30,000	7	---	---	148-211
15	Standard Valve Bronze	ASTM B62	30,000	14,000	20	17	13.5	55-65*
16	Tin Bronze	ASTM B143 Alloy 1A	40,000	18,000	20	20	15	75-85*
17	Manganese Bronze	ASTM B147 Alloy 8A	65,000	25,000	20	20	15.4	98*
18	Aluminum Bronze	ASTM B148 Alloy 9C	75,000	30,000	12 min.	12	17	150
19	Monel Alloy 411	(Weldable Grade)	65,000	32,500	25	---	23	120-170
20	Nickel-Moly Alloy "B"	ASTM A494 (Hastelloy "B")	72,000	46,000	6	---	---	---
21	Nickel-Moly-Chrome Alloy "C"	ASTM A494 (Hastelloy "C")	72,000	46,000	4	---	---	---
22	Cobalt-base Alloy No. 6	Stellite No. 6	121,000	64,000	1-2	---	30.4	---
23	Aluminum Bar	ASTM B211 Alloy 20911-T3	44,000	36,000	15	---	10.2	95
24	Yellow Brass Bar	ASTM B16-1/2 Hard	45,000	15,000	7	50	14	---
25	Naval Brass Bar	ASTM B21 Alloy 464	60,000	27,000	22	55	---	---
26	Leaded Steel Bar	AISI 12L14	79,000	71,000	16	52	---	163
27	Carbon Steel Bar	ASTM A108 Grade 1018	69,000	48,000	38	62	---	143
28	AISI 4140 Chrome-Moly Steel	(Suitable for ASTM A193 Grade B7 bolt material)	135,000	115,000	22	63	29.9	255
29	Type 302 Stainless Steel	ASTM A276 Type 302	85,000	35,000	60	70	28	150
30	Type 304 Stainless Steel	ASTM A276 Type 304	85,000	35,000	60	70	---	149
31	Type 316 Stainless Steel	ASTM A276 Type 316	80,000	30,000	60	70	28	149
32	Type 316L Stainless Steel	ASTM A276 Type 316L	81,000	34,000	55	---	---	146
33	Type 410 Stainless Steel	ASTM A276 Type 410	75,000	40,000	35	70	29	155
34	Type 17-4PH Stainless Steel	ASTM A461 Grade 630	135,000	105,000	16	50	29	275-345
35	Nickel-Copper Alloy Bar	Alloy K500 (K Monel)	100,000	70,000	35	---	26	175-260
36	Nickel-Moly Alloy "B" Bar	ASTM B335 (Hastelloy "B")	100,000	46,000	30	---	---	---
37	Nickel-Moly Alloy "C" Bar	ASTM B336 (Hastelloy "C")	100,000	46,000	20	---	---	---

1. 500 kg load.

Physical Constants of Hydrocarbons

NO.	COMPOUND	FORMULA	MOLECULAR WEIGHT	BOILING POINT AT 14.696 PSIA (°F)	VAPOR PRESSURE AT 100°F (PSIA)	FREEZING POINT AT 14.696 PSIA (°F)	CRITICAL CONSTANTS		SPECIFIC GRAVITY AT 14.696 PSIA	
							Critical Temperature (°F)	Critical Pressure (psia)	Liquid, (3, 4) 60°F/60°F	Gas at 60°F (Air = 1) ⁽¹⁾
1	Methane	CH ₄	16.043	-258.69	(5000) ⁽²⁾	-296.46 ⁽⁵⁾	-116.63	667.8	0.3 ⁽⁸⁾	0.5539
2	Ethane	C ₂ H ₆	30.070	-127.48	(800) ⁽²⁾	-297.89 ⁽⁵⁾	90.09	707.8	0.3564 ⁽⁷⁾	1.0382
3	Propane	C ₃ H ₈	44.097	-43.67	190	-305.84 ⁽⁵⁾	206.01	616.3	0.5077 ⁽⁷⁾	1.5225
4	n-Butane	C ₄ H ₁₀	58.124	31.10	51.6	-217.05	305.65	550.7	0.5844 ⁽⁷⁾	2.0068
5	Isobutane	C ₄ H ₁₀	58.124	10.90	72.2	-255.29	274.98	529.1	0.5631 ⁽⁷⁾	2.0068
6	n-Pentane	C ₅ H ₁₂	72.151	96.92	15.570	-201.51	385.7	488.6	0.6310	2.4911
7	Isopentane	C ₅ H ₁₂	72.151	82.12	20.44	-255.83	369.10	490.4	0.6247	2.4911
8	Neopentane	C ₅ H ₁₂	72.151	49.10	35.9	2.17	321.13	464.0	0.5967 ⁽⁷⁾	2.4911
9	n-Hexane	C ₆ H ₁₄	86.178	155.72	4.956	-139.58	453.7	436.9	0.6640	2.9753
10	2-Methylpentane	C ₆ H ₁₄	86.178	140.47	6.767	-244.63	435.83	436.6	0.6579	2.9753
11	3-Methylpentane	C ₆ H ₁₄	86.178	145.89	6.098	-	448.3	453.1	0.6689	2.9753
12	Neohexane	C ₆ H ₁₄	86.178	121.52	9.856	-147.72	420.13	446.8	0.6540	2.9753
13	2, 3-Dimethylbutane	C ₆ H ₁₄	86.178	136.36	7.404	-199.38	440.29	453.5	0.6664	2.9753
14	n-Heptane	C ₇ H ₁₆	100.205	209.17	1.620	-131.05	512.8	396.8	0.6882	3.4596
15	2-Methylhexane	C ₇ H ₁₆	100.205	194.09	2.271	-180.89	495.00	396.5	0.6830	3.4596
16	3-Methylhexane	C ₇ H ₁₆	100.205	197.32	2.130	-	503.78	408.1	0.6917	3.4596
17	3-Ethylpentane	C ₇ H ₁₆	100.205	200.25	2.012	-181.48	513.48	419.3	0.7028	3.4596
18	2,2-Dimethylpentane	C ₇ H ₁₆	100.205	174.54	3.492	-190.86	477.23	402.2	0.6782	3.4596
19	2,4-Dimethylpentane	C ₇ H ₁₆	100.205	176.89	3.292	-182.63	475.95	396.9	0.6773	3.4596
20	3,3-Dimethylpentane	C ₇ H ₁₆	100.205	186.91	2.773	-210.01	505.85	427.2	0.6976	3.4596
21	Triptane	C ₇ H ₁₆	100.205	177.58	3.374	-12.82	496.44	428.4	0.6946	3.4596
22	n-Octane	C ₈ H ₁₈	114.232	258.22	0.537	-70.18	564.22	360.6	0.7068	3.9439
23	Disobutyl	C ₈ H ₁₈	114.232	228.39	1.101	-132.07	530.44	360.6	0.6979	3.9439
24	Isooctane	C ₈ H ₁₈	114.232	210.63	1.708	-161.27	519.46	372.4	0.6962	3.9439
25	n-Nonane	C ₉ H ₂₀	128.259	303.47	0.179	-64.28	610.68	332	0.7217	4.4282
26	n-Decane	C ₁₀ H ₂₂	142.286	345.48	0.0597	-21.36	652.1	304	0.7342	4.9125
27	Cyclopentane	C ₅ H ₁₀	70.135	120.65	9.914	-136.91	461.5	653.8	0.7504	2.4215
28	Methylcyclopentane	C ₆ H ₁₂	84.162	161.25	4.503	-224.44	499.35	548.9	0.7536	2.9057
29	Cyclohexane	C ₆ H ₁₂	84.162	177.29	3.264	43.77	536.7	591	0.7834	2.9057
30	Methylcyclohexane	C ₇ H ₁₄	98.189	213.68	1.609	-195.98	570.27	503.5	0.7740	3.3900
31	Ethylene	C ₂ H ₄	28.054	-154.62	-	-272.45 ⁽⁵⁾	48.58	729.8	-	0.9686
32	Propene	C ₃ H ₆	42.081	-53.90	226.4	-301.45 ⁽⁵⁾	196.9	669	0.5220 ⁽⁷⁾	1.4529
33	1-Butene	C ₄ H ₈	56.108	20.75	63.05	-301.63 ⁽⁵⁾	295.6	583	0.6013 ⁽⁷⁾	1.9372
34	Cis-2-Butene	C ₄ H ₈	56.108	38.69	45.54	-218.06	324.37	610	0.6271 ⁽⁷⁾	1.9372
35	Trans-2-Butene	C ₄ H ₈	56.108	33.58	49.80	-157.96	311.86	595	0.6100 ⁽⁷⁾	1.9372
36	Isobutene	C ₄ H ₈	56.108	19.59	63.40	-220.61	292.55	580	0.6004 ⁽⁷⁾	1.9372
37	1-Pentene	C ₅ H ₁₀	70.135	85.93	19.115	-265.39	376.93	590	0.645 ⁽⁷⁾	2.4215
38	1,2-Butadiene	C ₄ H ₆	54.092	51.56	(20) ⁽²⁾	-213.16	(339) ⁽²⁾	(653) ⁽²⁾	0.658 ⁽⁷⁾	1.8676
39	1,3-Butadiene	C ₄ H ₆	54.092	24.06	(60) ⁽²⁾	-164.02	306	628	0.6272 ⁽⁷⁾	1.8676
40	Isoprene	C ₅ H ₈	68.119	93.30	16.672	-230.74	(412) ⁽²⁾	(558.4) ⁽²⁾	0.6861	2.3519
41	Acetylene	C ₂ H ₂	26.038	-119 ⁽⁶⁾	-	-114 ⁽⁵⁾	95.31	890.4	0.615 ⁽⁹⁾	0.8990
42	Benzene	C ₆ H ₆	78.114	176.17	3.224	41.96	552.22	710.4	0.8844	2.6969
43	Toluene	C ₇ H ₈	92.141	231.13	1.032	-138.94	605.55	595.9	0.8718	3.1812
44	Ethylbenzene	C ₈ H ₁₀	106.168	277.16	0.371	-138.91	651.24	523.5	0.8718	3.6655
45	o-Xylene	C ₈ H ₁₀	106.168	291.97	0.264	-13.30	675.0	541.4	0.8848	3.6655
46	m-Xylene	C ₈ H ₁₀	106.168	282.41	0.326	-54.12	651.02	513.6	0.8687	3.6655
47	p-Xylene	C ₈ H ₁₀	106.168	281.05	0.342	55.86	649.6	509.2	0.8657	3.6655
48	Styrene	C ₈ H ₈	104.152	293.29	(0.24) ⁽²⁾	-23.10	706.0	580	0.9110	3.5959
49	Isopropylbenzene	C ₉ H ₁₂	120.195	306.34	0.188	-140.82	676.4	465.4	0.8663	4.1498

1. Calculated values.
2. () - Estimated values.
3. Air saturated hydrocarbons.
4. Absolute values from weights in vacuum.
5. At saturation pressure (triple point).
6. Sublimation point.
7. Saturation pressure at 60°F.
8. Apparent value for methane at 60°F.
9. Specific gravity, 119°F/60°F (sublimation point).

Physical Constants of Various Fluids								
FLUID	FORMULA	MOLECULAR WEIGHT	BOILING POINT (°F AT 14.696 PSIA)	VAPOR PRESSURE AT 70°F (PSIG)	CRITICAL TEMPERATURE (°F)	CRITICAL PRESSURE (PSIA)	SPECIFIC GRAVITY	
							Liquid 60°F/60°F	Gas
Acetic Acid	HC ₂ H ₃ O ₃	60.06	245				1.05	
Acetone	C ₃ H ₆ O	58.08	133		455	691	0.79	2.01
Air	N ₂ O ₂	28.97	-317		-221	547	0.86‡	1.0
Alcohol, Ethyl	C ₂ H ₅ O	46.07	173	2.3 ⁽²⁾	470	925	0.794	1.59
Alcohol, Methyl	CH ₄ O	32.04	148	4.63 ⁽²⁾	463	1174	0.796	1.11
Ammonia	NH ₃	17.03	-28	114	270	1636	0.62	0.59
Ammonium Chloride ⁽¹⁾	NH ₄ Cl						1.07	
Ammonium Hydroxide ⁽¹⁾	NH ₄ OH						0.91	
Ammonium Sulfate ⁽¹⁾	(NH ₄) ₂ SO ₄						1.15	
Aniline	C ₆ H ₇ N	93.12	365		798	770	1.02	
Argon	A	39.94	-302		-188	705	1.65	1.38
Bromine	Br ₂	159.84	138		575		2.93	5.52
Calcium Chloride ⁽¹⁾	CaCl ₂						1.23	
Carbon Dioxide	CO ₂	44.01	-109	839	88	1072	0.801 ⁽³⁾	1.52
Carbon Disulfide	CS ₂	76.1	115				1.29	2.63
Carbon Monoxide	CO	28.01	-314		-220	507	0.80	0.97
Carbon Tetrachloride	CCl ₄	153.84	170		542	661	1.59	5.31
Chlorine	Cl ₂	70.91	-30	85	291	1119	1.42	2.45
Chromic Acid	H ₂ CrO ₄	118.03					1.21	
Citric Acid	C ₆ H ₈ O ₇	192.12					1.54	
Copper Sulfate ⁽¹⁾	CuSO ₄						1.17	
Ether	(C ₂ H ₅) ₂ O	74.12	34				0.74	2.55
Ferric Chloride ⁽¹⁾	FeCl ₃						1.23	
Fluorine	F ₂	38.00	-305	300	-200	809	1.11	1.31
Formaldehyde	H ₂ CO	30.03	-6				0.82	1.08
Formic Acid	HCO ₂ H	46.03	214				1.23	
Furfural	C ₅ H ₄ O ₂	96.08	324				1.16	
Glycerine	C ₃ H ₈ O ₃	92.09	554				1.26	
Glycol	C ₂ H ₆ O ₂	62.07	387				1.11	
Helium	He	4.003	-454		-450	33	0.18	0.14
Hydrochloric Acid	HCl	36.47	-115				1.64	
Hydrofluoric Acid	HF	20.01	66	0.9	446		0.92	
Hydrogen	H ₂	2.016	-422		-400	188	0.07 ⁽³⁾	0.07
Hydrogen Chloride	HCl	36.47	-115	613	125	1198	0.86	1.26
Hydrogen Sulfide	H ₂ S	34.07	-76	252	213	1307	0.79	1.17
Isopropyl Alcohol	C ₃ H ₈ O	60.09	180				0.78	2.08
Linseed Oil			538				0.93	

1. Aqueous Solution - 25% by weight of compound
 2. Vapor pressure in psia at 100°F
 3. Density of liquid, gm/ml at normal boiling point.

- continued -

Physical Constants of Various Fluids (continued)

FLUID	FORMULA	MOLECULAR WEIGHT	BOILING POINT (°F AT 14.696 PSIA)	VAPOR PRESSURE AT 70°F (PSIG)	CRITICAL TEMPERATURE (°F)	CRITICAL PRESSURE (PSIA)	SPECIFIC GRAVITY	
							Liquid 60°F/60°F	Gas
Magnesium Chloride ⁽¹⁾	MgCl ₂						1.22	
Mercury	Hg	200.61	670				13.6	6.93
Methyl Bromide	CH ₃ Br	94.95	38	13	376		1.73	3.27
Methyl Chloride	CH ₃ Cl	50.49	-11	59	290	969	0.99	1.74
Naphthalene	C ₁₀ H ₈	128.16	424				1.14	4.43
Nitric Acid	HNO ₃	63.02	187				1.5	
Nitrogen	N ₂	28.02	-320		-233	493	0.81 ⁽³⁾	0.97
Oil, Vegetable							0.91 - 0.94	
Oxygen	O ₂	32	-297		-181	737	1.14 ⁽³⁾	1.105
Phosgene	COCl ₂	98.92	47	10.7	360	823	1.39	3.42
Phosphoric Acid	H ₃ PO ₄	98.00	415				1.83	
Potassium Carbonate ⁽¹⁾	K ₂ CO ₃						1.24	
Potassium Chloride ⁽¹⁾	KCl						1.16	
Potassium Hydroxide ⁽¹⁾	KOH						1.24	
Refrigerant 11	CCl ₃ F	137.38	75	13.4	388	635		5.04
Refrigerant 12	CCl ₂ F ₂	120.93	-22	70.2	234	597		4.2
Refrigerant 13	CClF ₃	104.47	-115	458.7	84	561		
Refrigerant 21	CHCl ₂ F	102.93	48	8.4	353	750		3.82
Refrigerant 22	CHClF ₂	86.48	-41	122.5	205	716		
Refrigerant 23	CHF ₃	70.02	-119	635	91	691		
Sodium Chloride ⁽¹⁾	NaCl						1.19	
Sodium Hydroxide ⁽¹⁾	NaOH						1.27	
Sodium Sulfate ⁽¹⁾	Na ₂ SO ₄						1.24	
Sodium Thiosulfate ⁽¹⁾	Na ₂ SO ₃						1.23	
Starch	(C ₆ H ₁₀ O ₅) _x						1.50	
Sugar Solutions ⁽¹⁾	C ₁₂ H ₂₂ O ₁₁						1.10	
Sulfuric Acid	H ₂ SO ₄	98.08	626				1.83	
Sulfur Dioxide	SO ₂	64.6	14	34.4	316	1145	1.39	2.21
Turpentine			320				0.87	
Water	H ₂ O	18.016	212	0.9492 ⁽²⁾	706	3208	1.00	0.62
Zinc Chloride ⁽¹⁾	ZnCl ₂						1.24	
Zinc Sulfate ⁽¹⁾	ZnSO ₄						1.31	

1. Aqueous Solution - 25% by weight of compound
2. Vapor pressure in psia at 100°F
3. Density of liquid, gm/ml at normal boiling point.

Properties of Water				
Temperature of Water (°F)	Saturation Pressure (Pounds per Square Inch Absolute)	Weight (Pounds per Gallon)	Specific Gravity 60°F/60°F	Conversion Factor, ⁽¹⁾ Lbs./Hr. to GPM
32	0.0885	8.345	1.0013	0.00199
40	0.1217	8.345	1.0013	0.00199
50	0.1781	8.340	1.0007	0.00199
60	0.2653	8.334	1.0000	0.00199
70	0.3631	8.325	0.9989	0.00200
80	0.5069	8.314	0.9976	0.00200
90	0.6982	8.303	0.9963	0.00200
100	0.9492	8.289	0.9946	0.00201
110	1.2748	8.267	0.9919	0.00201
120	1.6924	8.253	0.9901	0.00201
130	2.2225	8.227	0.9872	0.00202
140	2.8886	8.207	0.9848	0.00203
150	3.718	8.182	0.9818	0.00203
160	4.741	8.156	0.9786	0.00204
170	5.992	8.127	0.9752	0.00205
180	7.510	8.098	0.9717	0.00205
190	9.339	8.068	0.9681	0.00206
200	11.526	8.039	0.9646	0.00207
210	14.123	8.005	0.9605	0.00208
212	14.696	7.996	0.9594	0.00208
220	17.186	7.972	0.9566	0.00209
240	24.969	7.901	0.9480	0.00210
260	35.429	7.822	0.9386	0.00211
280	49.203	7.746	0.9294	0.00215
300	67.013	7.662	0.9194	0.00217
350	134.63	7.432	0.8918	0.00224
400	247.31	7.172	0.8606	0.00232
450	422.6	6.892	0.8270	0.00241
500	680.8	6.553	0.7863	0.00254
550	1045.2	6.132	0.7358	0.00271
600	1542.9	5.664	0.6796	0.00294
700	3093.7	3.623	0.4347	0.00460

1. Multiply flow in pounds per hour by the factor to get equivalent flow in gallons per minute. Weight per gallon is based on 7.48 gallons per cubic foot.

Properties of Saturated Steam							
Absolute Pressure		Vacuum (Inches of Hg)	Temp. t (°F)	Heat of the Liquid (BTU/Lb.)	Latent Heat of Evaporation (BTU/Lb.)	Total Heat of Steam H _g (BTU/Lb.)	Specific Volume ∇ (Cubic Ft./Lb.)
Psi P'	Inches of Hg						
0.20	0.41	29.51	53.14	21.21	1063.8	1085.0	1526.0
0.25	0.51	29.41	59.30	27.36	1060.3	1087.7	1235.3
0.30	0.61	29.31	64.47	32.52	1057.4	1090.0	1039.5
0.35	0.71	29.21	68.93	36.97	1054.9	1091.9	898.5
0.40	0.81	29.11	72.86	40.89	1052.7	1093.6	791.9
0.45	0.92	29.00	76.38	44.41	1050.7	1095.1	708.5
0.50	1.02	28.90	79.58	47.60	1048.8	1096.4	641.4
0.60	1.22	28.70	85.21	53.21	1045.7	1098.9	540.0
0.70	1.43	28.49	90.08	58.07	1042.9	1101.0	466.9
0.80	1.63	28.29	94.38	62.36	1040.4	1102.8	411.7
0.90	1.83	28.09	98.24	66.21	1038.3	1104.5	368.4
1.0	2.04	27.88	101.74	69.70	1036.3	1106.0	333.6
1.2	2.44	27.48	107.92	75.87	1032.7	1108.6	280.9
1.4	2.85	27.07	113.26	81.20	1029.6	1110.8	243.0
1.6	3.26	26.66	117.99	85.91	1026.9	1112.8	214.3
1.8	3.66	26.26	122.23	90.14	1024.5	1114.6	191.8
2.0	4.07	25.85	126.08	93.99	1022.2	1116.2	173.73
2.2	4.48	25.44	129.62	97.52	1020.2	1117.7	158.85
2.4	4.89	25.03	132.89	100.79	1018.3	1119.1	146.38
2.6	5.29	24.63	135.94	103.83	1016.5	1120.3	135.78
2.8	5.70	24.22	138.79	106.68	1014.8	1121.5	126.65
3.0	6.11	23.81	141.48	109.37	1013.2	1122.6	118.71
3.5	7.13	22.79	147.57	115.46	1009.6	1125.1	102.72
4.0	8.14	21.78	152.97	120.86	1006.4	1127.3	90.63
4.5	9.16	20.76	157.83	125.71	1003.6	1129.3	81.16
5.0	10.18	19.74	162.24	130.13	1001.0	1131.1	73.52
5.5	11.20	18.72	166.30	134.19	998.5	1132.7	67.24
6.0	12.22	17.70	170.06	137.96	996.2	1134.2	61.98
6.5	13.23	16.69	173.56	141.47	994.1	1135.6	57.50
7.0	14.25	15.67	176.85	144.76	992.1	1136.9	53.64
7.5	15.27	14.65	179.94	147.86	990.2	1138.1	50.29
8.0	16.29	13.63	182.86	150.79	988.5	1139.3	47.34
8.5	17.31	12.61	185.64	153.57	986.8	1140.4	44.73
9.0	18.32	11.60	188.28	156.22	985.2	1141.4	42.40
9.5	19.34	10.58	190.80	158.75	983.6	1142.3	40.31
10.0	20.36	9.56	193.21	161.17	982.1	1143.3	38.42
11.0	22.40	7.52	197.75	165.73	979.3	1145.0	35.14
12.0	24.43	5.49	201.96	169.96	976.6	1146.6	32.40
13.0	26.47	3.45	205.88	173.91	974.2	1148.1	30.06
14.0	28.50	1.42	209.56	177.61	971.9	1149.5	28.04

- continued -

Properties of Saturated Steam (continued)													
Pressure (PSI)		Temp. t (°F)	Heat of the Liquid (BTU/Lb.)	Latent Heat of Evaporation (BTU/Lb.)	Total Heat of Steam H _g (BTU/Lb.)	Specific Volume ∇ (Cu. Ft./Lb.)	Pressure (PSI)		Temp. t (°F)	Heat of the Liquid (BTU/Lb.)	Latent Heat of Evaporation (BTU/Lb.)	Total Heat of Steam H _g (BTU/Lb.)	Specific Volume ∇ (Cu. Ft./Lb.)
Absolute P'	Gauge P						Absolute P'	Gauge P					
14.696	0.0	212.00	180.07	970.3	1150.4	26.80							
15.0	0.3	213.03	181.11	969.7	1150.8	26.29	75.0	60.3	307.60	277.43	904.5	1181.9	5.816
16.0	1.3	216.32	184.42	967.6	1152.0	24.72	76.0	61.3	308.50	278.37	903.7	1182.1	5.743
17.0	2.3	219.44	187.56	965.5	1153.1	23.39	77.0	62.3	309.40	279.30	903.1	1182.4	5.673
18.0	3.3	222.41	190.56	963.6	1154.2	22.17	78.0	63.3	310.29	280.21	902.4	1182.6	5.604
19.0	4.3	225.24	193.42	961.9	1155.3	21.08	79.0	64.3	311.16	281.12	901.7	1182.8	5.537
20.0	5.3	227.96	196.16	960.1	1156.3	20.089	80.0	65.3	312.03	282.02	901.1	1183.1	5.472
21.0	6.3	230.57	198.79	958.4	1157.2	19.192	81.0	66.3	312.89	282.91	900.4	1183.3	5.408
22.0	7.3	233.07	201.33	956.8	1158.1	18.375	82.0	67.3	313.74	283.79	899.7	1183.5	5.346
23.0	8.3	235.49	203.78	955.2	1159.0	17.627	83.0	68.3	314.59	284.66	899.1	1183.8	5.285
24.0	9.3	237.82	206.14	953.7	1159.8	16.938	84.0	69.3	315.42	285.53	898.5	1184.0	5.226
25.0	10.3	240.07	208.42	952.1	1160.6	16.303	85.0	70.3	316.25	286.39	897.8	1184.2	5.168
26.0	11.3	242.25	210.62	950.7	1161.3	15.715	86.0	71.3	317.07	287.24	897.2	1184.4	5.111
27.0	12.3	244.36	212.75	949.3	1162.0	15.170	87.0	72.3	317.88	288.08	896.5	1184.6	5.055
28.0	13.3	246.41	214.83	947.9	1162.7	14.663	88.0	73.3	318.68	288.91	895.9	1184.8	5.001
29.0	14.3	248.40	216.86	946.5	1163.4	14.189	89.0	74.3	319.48	289.74	895.3	1185.1	4.948
30.0	15.3	250.33	218.82	945.3	1164.1	13.746	90.0	75.3	320.27	290.56	894.7	1185.3	4.896
31.0	16.3	252.22	220.73	944.0	1164.7	13.330	91.0	76.3	321.06	291.38	894.1	1185.5	4.845
32.0	17.3	254.05	222.59	942.8	1165.4	12.940	92.0	77.3	321.83	292.18	893.5	1185.7	4.796
33.0	18.3	255.84	224.41	941.6	1166.0	12.572	93.0	78.3	322.60	292.98	892.9	1185.9	4.747
34.0	19.3	257.58	226.18	940.3	1166.5	12.226	94.0	79.3	323.36	293.78	892.3	1186.1	4.699
35.0	20.3	259.28	227.91	939.2	1167.1	11.898	95.0	80.3	324.12	294.56	891.7	1186.2	4.652
36.0	21.3	260.95	229.60	938.0	1167.6	11.588	96.0	81.3	324.87	295.34	891.1	1186.4	4.606
37.0	22.3	262.57	231.26	936.9	1168.2	11.294	97.0	82.3	325.61	296.12	890.5	1186.6	4.561
38.0	23.3	264.16	232.89	935.8	1168.7	11.015	98.0	83.3	326.35	296.89	889.9	1186.8	4.517
39.0	24.3	265.72	234.48	934.7	1169.2	10.750	99.0	84.3	327.08	297.65	889.4	1187.0	4.474
40.0	25.3	267.25	236.03	933.7	1169.7	10.498	100.0	85.3	327.81	298.40	888.8	1187.2	4.432
41.0	26.3	268.74	237.55	932.6	1170.2	10.258	101.0	86.3	328.53	299.15	888.2	1187.4	4.391
42.0	27.3	270.21	239.04	931.6	1170.7	10.029	102.0	87.3	329.25	299.90	887.6	1187.5	4.350
43.0	28.3	271.64	240.51	930.6	1171.1	9.810	103.0	88.3	329.96	300.64	887.1	1187.7	4.310
44.0	29.3	273.05	241.95	929.6	1171.6	9.601	104.0	89.3	330.66	301.37	886.5	1187.9	4.271
45.0	30.3	274.44	243.36	928.6	1172.0	9.401	105.0	90.3	331.36	302.10	886.0	1188.1	4.232
46.0	31.3	275.80	244.75	927.7	1172.4	9.209	106.0	91.3	332.05	302.82	885.4	1188.2	4.194
47.0	32.3	277.13	246.12	926.7	1172.9	9.025	107.0	92.3	332.74	303.54	884.9	1188.4	4.157
48.0	33.3	278.45	247.47	925.8	1173.3	8.848	108.0	93.3	333.42	304.26	884.3	1188.6	4.120
49.0	34.3	279.74	248.79	924.9	1173.7	8.678	109.0	94.3	334.10	304.97	883.7	1188.7	4.084
50.0	35.3	281.01	250.09	924.0	1174.1	8.515	110.0	95.3	334.77	305.66	883.2	1188.9	4.049
51.0	36.3	282.26	251.37	923.0	1174.4	8.359	111.0	96.3	335.44	306.37	882.6	1189.0	4.015
52.0	37.3	283.49	252.63	922.2	1174.8	8.208	112.0	97.3	336.11	307.06	882.1	1189.2	3.981
53.0	38.3	284.70	253.87	921.3	1175.2	8.062	113.0	98.3	336.77	307.75	881.6	1189.4	3.947
54.0	39.3	285.90	255.09	920.5	1175.6	7.922	114.0	99.3	337.42	308.43	881.1	1189.5	3.914
55.0	40.3	287.07	256.30	919.6	1175.9	7.787	115.0	100.3	338.07	309.11	880.6	1189.7	3.882
56.0	41.3	288.28	257.50	918.8	1176.3	7.656	116.0	101.3	338.72	309.79	880.0	1189.8	3.850
57.0	42.3	289.37	258.67	917.9	1176.6	7.529	117.0	102.3	339.36	310.46	879.5	1190.0	3.819
58.0	43.3	290.50	259.82	917.1	1176.9	7.407	118.0	103.3	339.99	311.12	879.0	1190.1	3.788
59.0	44.3	291.61	260.96	916.3	1177.3	7.289	119.0	104.3	340.62	311.78	878.4	1190.2	3.758
60.0	45.3	292.71	262.09	915.5	1177.6	7.175	120.0	105.3	341.25	312.44	877.9	1190.4	3.728
61.0	46.3	293.79	263.20	914.7	1177.9	7.064	121.0	106.3	341.88	313.10	877.4	1190.5	3.699
62.0	47.3	294.85	264.30	913.9	1178.2	6.957	122.0	107.3	342.50	313.75	876.9	1190.7	3.670
63.0	48.3	295.90	265.38	913.1	1178.5	6.853	123.0	108.3	343.11	314.40	876.4	1190.8	3.642
64.0	49.3	296.94	266.45	912.3	1178.8	6.752	124.0	109.3	343.72	315.04	875.9	1190.9	3.614
65.0	50.3	297.97	267.50	911.6	1179.1	6.655	125.0	110.3	344.33	315.68	875.4	1191.1	3.587
66.0	51.3	298.99	268.55	910.8	1179.4	6.560	126.0	111.3	344.94	316.31	874.9	1191.2	3.560
67.0	52.3	299.99	269.58	910.1	1179.7	6.468	127.0	112.3	345.54	316.94	874.4	1191.3	3.533
68.0	53.3	300.98	270.60	909.4	1180.0	6.378	128.0	113.3	346.13	317.57	873.9	1191.5	3.507
69.0	54.3	301.96	291.61	908.7	1180.3	6.291	129.0	114.3	346.73	318.19	873.4	1191.6	3.481
70.0	55.3	302.92	272.61	907.9	1180.6	6.206	130.0	115.3	347.32	318.81	872.9	1191.7	3.455
71.0	56.3	303.88	273.60	907.2	1180.8	6.124	131.0	116.3	347.90	319.43	872.5	1191.9	3.430
72.0	57.3	304.83	274.57	906.5	1181.1	6.044	132.0	117.3	348.48	320.04	872.0	1192.0	3.405
73.0	58.3	305.76	275.54	905.8	1181.3	5.966	133.0	118.3	349.06	320.65	871.5	1192.1	3.381
74.0	59.3	306.68	276.49	905.1	1181.6	5.890	134.0	119.3	349.64	321.25	871.0	1192.2	3.357

- continued -

Properties of Saturated Steam (continued)													
Pressure (PSI)		Temp. t (°F)	Heat of the Liquid (BTU/Lb.)	Latent Heat of Evaporation (BTU/Lb.)	Total Heat of Steam H _g (BTU/Lb.)	Specific Volume ∇ (Cu. Ft./Lb.)	Pressure (PSI)		Temp. t (°F)	Heat of the Liquid (BTU/Lb.)	Latent Heat of Evaporation (BTU/Lb.)	Total Heat of Steam H _g (BTU/Lb.)	Specific Volume ∇ (Cu. Ft./Lb.)
Absolute P'	Gauge P						Absolute P'	Gauge P					
135.0	120.3	350.21	321.85	870.6	1192.4	3.333	400.0	385.3	444.59	424.0	780.5	1204.5	1.1613
136.0	121.3	350.78	322.45	870.1	1192.5	3.310	420.0	405.3	449.39	429.4	775.2	1204.6	1.1061
137.0	122.3	351.35	323.05	869.6	1192.6	3.287	440.0	425.3	454.02	434.6	770.0	1204.6	1.0556
138.0	123.3	351.91	323.64	869.1	1192.7	3.264	460.0	445.3	458.50	439.7	764.9	1204.6	1.0094
139.0	124.3	352.47	324.23	868.7	1192.9	3.242	480.0	465.3	462.82	444.6	759.9	1204.5	0.9670
140.0	125.3	353.02	324.82	868.2	1193.0	3.220	500.0	485.3	467.01	449.4	755.0	1204.4	0.9278
141.0	126.3	353.57	325.40	867.7	1193.1	3.198	520.0	505.3	471.07	454.1	750.1	1204.2	0.7815
142.0	127.3	354.12	325.98	867.2	1193.2	3.177	540.0	525.3	475.01	458.6	745.4	1204.0	0.8578
143.0	128.3	354.67	326.56	866.7	1193.3	3.155	560.0	545.3	478.85	463.0	740.8	1203.8	0.8265
144.0	129.3	355.21	327.13	866.3	1193.4	3.134	580.0	565.3	482.58	467.4	736.1	1203.5	0.7973
145.0	130.3	355.76	327.70	865.8	1193.5	3.114	600.0	585.3	486.21	471.6	731.6	1203.2	0.7698
146.0	131.3	356.29	328.27	865.3	1193.6	3.094	620.0	605.3	489.75	475.7	727.2	1202.9	0.7440
147.0	132.3	356.83	328.83	864.9	1193.8	3.074	640.0	625.3	493.21	479.8	722.7	1202.5	0.7198
148.0	133.3	357.36	329.39	864.5	1193.9	3.054	660.0	645.3	496.58	483.8	718.3	1202.1	0.6971
149.0	134.3	357.89	329.95	864.0	1194.0	3.034	680.0	665.3	499.88	487.7	714.0	1201.7	0.6757
150.0	135.3	358.42	330.51	863.6	1194.1	3.015	700.0	685.3	503.10	491.5	709.7	1201.2	0.6554
152.0	137.3	359.46	331.61	862.7	1194.3	2.977	720.0	705.3	506.25	495.3	705.4	1200.7	0.6362
154.0	139.3	360.49	332.70	861.8	1194.5	2.940	740.0	725.3	509.34	499.0	701.2	1200.2	0.6180
156.0	141.3	361.52	333.79	860.9	1194.7	2.904	760.0	745.3	512.36	502.6	697.1	1199.7	0.6007
158.0	143.3	362.53	334.86	860.0	1194.9	2.869	780.0	765.3	505.33	506.2	692.9	1199.1	0.5843
160.0	145.3	363.53	335.93	859.2	1195.1	2.834	800.0	785.3	518.23	509.7	688.9	1198.6	0.5687
162.0	147.3	364.53	336.98	858.3	1195.3	2.801	820.0	805.3	521.08	513.2	684.8	1198.0	0.5538
164.0	149.3	365.51	338.02	857.5	1195.5	2.768	840.0	825.3	523.88	516.6	680.8	1197.4	0.5396
166.0	151.3	366.48	339.05	856.6	1195.7	2.736	860.0	845.3	526.63	520.0	676.8	1196.8	0.5260
168.0	153.3	367.45	340.07	855.7	1195.8	2.705	880.0	865.3	529.33	523.3	672.8	1196.1	0.5130
170.0	155.3	368.41	341.09	854.9	1196.0	2.675	900.0	885.3	531.98	526.6	668.8	1195.4	0.5006
172.0	157.3	369.35	342.10	854.1	1196.2	2.645	920.0	905.3	534.59	529.8	664.9	1194.7	0.4886
174.0	159.3	370.29	343.10	853.3	1196.4	2.616	940.0	925.3	537.16	533.0	661.0	1194.0	0.4772
176.0	161.3	371.22	344.09	852.4	1196.5	2.587	960.0	945.3	539.68	536.2	657.1	1193.3	0.4663
178.0	163.3	372.14	345.06	851.6	1196.7	2.559	980.0	965.3	542.17	539.3	653.3	1192.6	0.4557
180.0	165.3	373.06	346.03	850.8	1196.9	2.532	1000.0	985.3	544.61	542.4	649.4	1191.8	0.4456
182.0	167.3	373.96	347.00	850.0	1197.0	2.505	1050.0	1035.3	550.57	550.0	639.9	1189.9	0.4218
184.0	169.3	374.86	347.96	849.2	1197.2	2.479	1100.0	1085.3	556.31	557.4	630.4	1187.8	0.4001
186.0	171.3	375.75	348.92	848.4	1197.3	2.454	1150.0	1135.3	561.86	565.4	621.0	1185.6	0.3802
188.0	173.3	376.64	349.86	847.6	1197.5	2.429	1200.0	1185.3	567.22	571.7	611.7	1183.4	0.619
190.0	175.3	377.51	350.79	846.8	1197.6	2.404	1250.0	1235.3	572.42	578.6	602.4	1181.0	0.3450
192.0	177.3	378.38	351.72	846.1	1197.8	2.380	1300.0	1285.3	577.46	585.4	593.2	1178.6	0.3293
194.0	179.3	379.24	352.64	845.3	1197.9	2.356	1350.0	1335.3	582.35	592.1	584.0	1176.1	0.3148
196.0	181.3	380.10	353.55	844.5	1198.1	2.333	1400.0	1385.3	587.10	598.7	574.7	1173.4	0.3012
198.0	183.3	380.95	354.46	843.7	1198.2	2.310	1450.0	1435.3	591.73	605.2	565.5	1170.7	0.2884
200.0	185.3	381.79	355.36	843.0	1198.4	2.288	1500.0	1485.3	596.23	611.6	556.3	1167.9	0.2765
205.0	190.3	383.86	357.58	841.0	1198.7	2.234	1600.0	1585.3	604.90	624.1	538.0	1162.1	0.2548
210.0	195.3	385.90	359.77	839.2	1199.0	2.183	1700.0	1685.3	613.15	636.3	519.6	1155.9	0.2354
215.0	200.3	387.89	361.91	837.4	1199.3	2.134	1800.0	1785.3	621.03	648.3	501.1	1149.4	0.2179
220.0	205.3	389.86	364.02	835.6	1199.6	2.087	1900.0	1885.3	628.58	660.1	482.4	1142.4	0.2021
225.0	210.3	391.79	366.09	833.8	1199.9	2.042	2000.0	1985.3	635.82	671.7	463.4	1135.1	0.1878
230.0	215.3	393.68	368.13	832.0	1200.1	1.992	2100.0	2085.3	642.77	683.3	444.1	1127.4	0.1746
235.0	220.3	395.54	370.14	830.3	1200.4	1.957	2200.0	2185.3	649.46	694.8	424.4	1119.2	0.1625
240.0	225.3	397.37	372.12	828.5	1200.6	1.918	2300.0	2285.3	655.91	706.5	403.9	1110.4	0.1513
245.0	230.3	399.18	374.08	826.8	1200.9	1.880	2400.0	2385.3	662.12	718.4	382.7	1101.1	0.1407
250.0	235.3	400.95	376.00	825.1	1201.1	1.843	2500.0	2485.3	668.13	730.6	360.5	1091.1	0.1307
255.0	240.3	402.70	377.89	823.4	1201.3	1.808	2600.0	2585.3	673.94	743.0	337.2	1080.2	0.1213
260.0	245.3	404.42	379.76	821.8	1201.5	1.774	2700.0	2685.3	679.55	756.2	312.1	1068.3	0.1123
265.0	250.3	406.11	381.60	820.1	1201.7	1.742	2800.0	2785.3	684.99	770.1	284.7	1054.8	0.1035
270.0	255.3	407.78	383.42	818.5	1201.9	1.710	2900.0	2885.3	690.26	785.4	253.6	1039.0	0.0947
275.0	260.3	409.43	385.21	816.9	1202.1	1.680	3000.0	2985.3	695.36	802.5	217.8	1020.3	0.0858
280.0	265.3	411.05	386.98	815.3	1202.3	1.651	3100.0	3085.3	700.31	825.0	168.1	993.1	0.0753
285.0	270.3	412.65	388.73	813.7	1202.4	1.622	3200.0	3185.3	705.11	872.4	62.0	934.4	0.0580
290.0	275.3	414.23	390.46	812.1	1202.6	1.595	3206.2	3191.5	705.40	902.7	0.0	902.7	0.0503
295.0	280.3	415.79	392.16	810.5	1202.7	1.568							
300.0	285.3	417.33	393.84	809.0	1202.8	1.543							
320.0	305.3	423.29	400.39	803.0	1203.4	1.448							
340.0	325.3	428.97	406.66	797.1	1203.7	1.364							
360.0	345.3	434.40	412.67	797.4	1204.1	1.289							
380.0	365.3	439.60	418.45	785.8	1204.3	1.222							

Properties of Saturated Steam (Metric)							
TEMPERATURE, K	PRESSURE, BAR	VOLUME, m ³ /kg		ENTHALPY, kJ/kg		ENTROPY, kJ/(kg x K)	
		Condensed	Vapor	Condensed	Vapor	Condensed	Vapor
150	6.30 - 11	1.073 - 3	9.55 + 9	- 539.6	2273	- 2.187	16.54
160	7.72 - 10	1.074 - 3	9.62 + 8	- 525.7	2291	- 2.106	15.49
170	7.29 - 9	1.076 - 3	1.08 + 8	- 511.7	2310	- 2.026	14.57
180	5.38 - 8	1.077 - 3	1.55 + 7	- 497.8	2328	- 1.947	13.76
190	3.23 - 7	1.078 - 3	2.72 + 6	- 483.8	2347	- 1.868	16.03
200	1.62 - 6	1.079 - 3	5.69 + 5	- 467.5	2366	- 1.789	12.38
210	7.01 - 6	1.081 - 3	1.39 + 5	- 451.2	2384	- 1.711	11.79
220	2.65 - 5	1.082 - 3	3.83 + 4	- 435.0	2403	- 1.633	11.20
230	8.91 - 5	1.084 - 3	1.18 + 4	- 416.3	2421	- 1.555	10.79
240	3.72 - 4	1.085 - 3	4.07 + 3	- 400.1	2440	- 1.478	10.35
250	7.59 - 4	1.087 - 3	1.52 + 3	- 318.5	2459	- 1.400	9.954
255	1.23 - 3	1.087 - 3	956.4	- 369.8	2468	- 1.361	9.768
260	1.96 - 3	1.088 - 3	612.2	- 360.5	2477	- 1.323	9.590
265	3.06 - 3	1.089 - 3	400.4	- 351.2	2486	- 1.281	9.461
270	4.69 - 3	1.090 - 3	265.4	- 339.6	2496	- 1.296	9.255
273.15	6.11 - 3	1.091 - 3	206.3	- 333.5	2502	- 1.221	9.158
273.15	0.00611	1.000 - 3	206.3	0.0	2502	0.000	9.158
275	0.00697	1.000 - 3	181.7	7.8	2505	0.028	9.109
280	0.00990	1.000 - 3	130.4	28.8	2514	0.104	8.890
285	0.01387	1.000 - 3	99.4	49.8	2523	0.178	8.857
290	0.01917	1.001 - 3	69.7	70.7	2532	0.251	8.740
295	0.02617	1.002 - 3	51.94	91.6	2541	0.323	8.627
300	0.03531	1.003 - 3	39.13	112.5	2550	0.393	8.520
305	0.04712	1.005 - 3	27.90	133.4	2559	0.462	8.417
310	0.06221	1.007 - 3	22.93	154.3	2568	0.530	8.318
315	0.08132	1.009 - 3	17.82	175.2	2577	0.597	8.224
320	0.01053	1.011 - 3	13.98	196.1	2586	0.649	8.151
325	0.01351	1.013 - 3	11.06	217.0	2595	0.727	8.046
330	0.01719	1.016 - 3	8.82	237.9	2604	0.791	7.962
335	0.02167	1.018 - 3	7.09	258.8	2613	0.854	7.881
340	0.02713	1.021 - 3	5.74	279.8	2622	0.916	7.804
345	0.3372	1.024 - 3	4.683	300.7	2630	0.977	7.729
350	0.4163	1.027 - 3	3.846	321.7	2639	1.038	7.657
355	0.5100	1.030 - 3	3.180	342.7	2647	1.097	7.588
360	0.6209	1.034 - 3	2.645	363.7	2655	1.156	7.521
365	0.7514	1.038 - 3	2.212	384.7	2663	1.214	7.456
370	0.9040	1.041 - 3	1.861	405.8	2671	1.271	7.394
373.15	1.0133	1.044 - 3	1.679	419.1	2676	1.307	7.356
375	1.0815	1.045 - 3	1.574	426.8	2679	1.328	7.333
380	1.2869	1.049 - 3	1.337	448.0	2687	1.384	7.275
385	1.5233	1.053 - 3	1.142	469.2	2694	1.439	7.218
390	1.794	1.058 - 3	0.980	490.4	2702	1.494	7.163
400	2.455	1.067 - 3	0.731	532.9	2716	1.605	7.058
410	3.302	1.077 - 3	0.553	575.6	2729	1.708	6.959
420	4.370	1.088 - 3	0.425	618.6	2742	1.810	6.865
430	5.699	1.099 - 3	0.331	661.8	2753	1.911	6.775
440	7.333	1.110 - 3	0.261	705.3	2764	2.011	6.689
450	9.319	1.123 - 3	0.208	749.2	2773	2.109	6.607
460	11.71	1.137 - 3	0.167	793.5	2782	2.205	6.528
470	14.55	1.152 - 3	0.136	838.2	2789	2.301	6.451
480	17.90	1.167 - 3	0.111	883.4	2795	2.395	6.377
490	21.83	1.184 - 3	0.0922	929.1	2799	2.479	6.312
500	26.40	1.203 - 3	0.0776	975.6	2801	2.581	6.233
510	31.66	1.222 - 3	0.0631	1023	2802	2.673	6.163
520	37.70	1.244 - 3	0.0525	1071	2801	2.765	6.093
530	44.58	1.268 - 3	0.0445	1119	2798	2.856	6.023
540	52.38	1.294 - 3	0.0375	1170	2792	2.948	5.953
550	61.19	1.323 - 3	0.0317	1220	2784	3.039	5.882
560	71.08	1.355 - 3	0.0269	1273	2772	3.132	5.808
570	82.16	1.392 - 3	0.0228	1328	2757	3.225	5.733
580	94.51	1.433 - 3	0.0193	1384	2737	3.321	5.654
590	108.3	1.482 - 3	0.0163	1443	2717	3.419	5.569
600	123.5	1.541 - 3	0.0137	1506	2682	3.520	5.480
610	137.3	1.612 - 3	0.0115	1573	2641	3.627	5.318
620	159.1	1.705 - 3	0.0094	1647	2588	3.741	5.259
625	169.1	1.778 - 3	0.0085	1697	2555	3.805	5.191
630	179.1	1.856 - 3	0.0075	1734	2515	3.875	5.115
635	190.9	1.935 - 3	0.0066	1783	2466	3.950	5.025
640	202.7	2.075 - 3	0.0057	1841	2401	4.037	4.912
645	215.2	2.351 - 3	0.0045	1931	2292	4.223	4.732
647.31	221.2	3.170 - 3	0.0032	2107	2107	4.443	4.443

Properties of Superheated Steam														
PRESSURE (PSI)		SAT. TEMP. t	v	TOTAL TEMPERATURE — °F (t)										
Absolute P'	Gauge P			360°	400°	440°	480°	500°	600°	700°	800°	900°	1000°	1200°
14.696	0.0	212.00	v _{hg}	33.03 1221.1	34.68 1239.9	36.32 1258.8	37.96 1277.6	38.78 1287.1	42.86 1334.8	46.94 1383.2	51.00 1432.3	55.07 1482.3	59.13 1533.1	67.25 1637.5
20.0	5.3	227.96	v _{hg}	24.21 1220.3	25.43 1239.2	26.65 1258.2	27.86 1277.1	28.46 1286.6	31.47 1334.4	34.47 1382.9	37.46 1432.1	40.45 1482.1	43.44 1533.0	49.41 1637.4
30.0	15.3	250.33	v _{hg}	16.072 1218.6	16.897 1237.9	17.714 1257.0	18.528 1276.2	18.933 1285.7	20.95 1333.8	22.96 1382.4	24.96 1431.17	26.95 1481.8	28.95 1532.7	32.93 1637.2
40.0	25.3	267.25	v _{hg}	12.001 1216.9	12.628 1236.5	13.247 1255.9	13.962 1275.2	14.168 1284.8	15.688 1333.1	17.198 1381.9	18.702 1431.3	20.20 1481.4	21.70 1532.4	24.69 1637.0
50.0	35.3	281.01	v _{hg}	9.557 1215.2	10.065 1235.1	10.567 1254.7	11.062 1274.2	11.309 1283.9	12.532 1332.5	13.744 1381.4	14.950 1430.9	16.152 1481.1	17.352 1532.1	19.747 1636.8
60.0	45.3	292.71	v _{hg}	7.927 1213.4	8.357 1233.6	8.779 1253.5	9.196 1273.2	9.403 1283.0	10.427 1331.8	11.441 1380.9	12.449 1430.5	13.452 1480.8	14.454 1531.9	16.451 1636.6
70.0	55.3	302.92	v _{hg}	6.762 1211.5	7.136 1232.1	7.502 1252.3	7.863 1272.2	8.041 1282.0	8.924 1331.1	9.796 1380.4	10.662 1430.1	11.524 1480.5	12.383 1531.6	14.097 1636.3
80.0	65.3	312.03	v _{hg}	5.888 1209.7	6.220 1230.7	6.544 1251.1	6.862 1271.1	7.020 1281.1	7.797 1330.5	8.562 1379.9	9.322 1429.7	10.077 1480.1	10.830 1531.3	12.332 1636.2
90.0	75.3	320.27	v _{hg}	5.208 1207.7	5.508 1229.1	5.799 1249.8	6.084 1270.1	6.225 1280.1	6.920 1329.8	7.603 1379.4	8.279 1429.3	8.952 1479.8	9.623 1531.0	10.959 1635.9
100.0	85.3	327.81	v _{hg}	4.663 1205.7	4.937 1227.6	5.202 1248.6	5.462 1269.0	5.589 1279.1	6.218 1329.1	6.835 1378.9	7.446 1428.9	8.052 1479.5	8.656 1530.8	9.860 1635.7
120.0	105.3	341.25	v _{hg}	3.844 1201.6	4.081 1224.4	4.307 1246.0	4.527 1266.9	4.636 1277.2	5.165 1327.7	5.683 1377.8	6.195 1428.1	6.702 1478.8	7.207 1530.2	8.212 1635.3
140.0	125.3	353.02	v _{hg}	3.258 1197.3	3.468 1221.1	3.667 1243.3	3.860 1264.7	3.954 1275.2	4.413 1326.4	4.861 1376.8	5.301 1427.2	5.738 1478.2	6.172 1529.7	7.035 1634.9
160.0	145.3	363.53	v _{hg}	---	3.008 1217.6	3.187 1240.6	3.359 1262.4	3.443 1273.1	3.849 1325.0	4.244 1375.7	4.631 1426.4	5.015 1477.5	5.396 1529.1	6.152 1634.5
180.0	165.3	373.06	v _{hg}	---	2.649 1214.0	2.813 1237.8	2.969 1260.2	3.044 1271.0	3.411 1323.5	3.964 1374.7	4.110 1425.6	4.452 1476.8	4.792 1528.6	5.466 1634.1
200.0	185.3	381.79	v _{hg}	---	2.361 1210.3	2.513 1234.9	2.656 1257.8	2.726 1268.9	3.060 1322.1	3.380 1373.6	3.693 1424.8	4.002 1476.2	4.309 1528.0	4.917 1633.7
220.0	205.3	389.86	v _{hg}	---	2.125 1206.5	2.267 1231.9	2.400 1255.4	2.465 1266.7	2.772 1320.7	3.066 1372.6	3.352 1424.0	3.634 1475.5	3.913 1527.5	4.467 1633.3
240.0	225.3	397.37	v _{hg}	---	1.9276 1202.5	2.062 1228.8	2.187 1253.0	2.247 1264.5	2.533 1319.2	2.804 1371.5	3.068 1432.2	3.327 1474.8	3.584 1526.9	4.093 1632.9
260.0	245.3	404.42	v _{hg}	---	---	1.8882 1225.7	2.006 1250.5	2.063 1262.3	2.330 1317.7	2.582 1370.4	2.827 1422.3	3.067 1474.2	3.305 1526.3	3.776 1632.5
280.0	265.3	411.05	v _{hg}	---	---	1.7388 1222.4	1.8512 1247.9	1.9047 1260.0	2.156 1316.2	2.392 1369.4	2.621 1421.5	2.845 1473.5	3.066 1525.8	3.504 1632.1
300.0	285.3	417.33	v _{hg}	---	---	1.6090 1219.1	1.7165 1245.3	1.7675 1257.6	2.005 1314.7	2.227 1368.3	2.442 1420.6	2.652 1472.8	2.859 1525.2	3.269 1631.7
320.0	305.3	423.29	v _{hg}	---	---	1.4950 1215.6	1.5985 1242.6	1.6472 1255.2	1.8734 1313.2	2.083 1367.2	2.285 1419.8	2.483 1472.1	2.678 1524.7	3.063 1631.3
340.0	325.3	428.97	v _{hg}	---	---	1.3941 1212.1	1.4941 1239.9	1.5410 1252.8	1.7569 1311.6	1.9562 1366.1	2.147 1419.0	2.334 1471.5	2.518 1524.1	2.881 1630.9
360.0	345.3	434.40	v _{hg}	---	---	1.3041 1208.4	1.4012 1237.1	1.4464 1250.3	1.6533 1310.1	1.8431 1365.0	2.025 1418.1	2.202 1470.8	2.376 1523.5	2.719 1630.5

v = specific volume, cubic feet per pound
h_g = total heat of steam, BTU per pound

- continued -

Properties of Superheated Steam (continued)														
PRESSURE (PSI)		SAT. TEMP. t	v	TOTAL TEMPERATURE — °F (t)										
Absolute P'	Gauge P			500°	540°	600°	640°	660°	700°	740°	800°	900°	1000°	1200°
380.0	365.3	439.60	v _{hg}	1.3616 1247.7	1.4444 1273.1	1.5605 1308.5	1.6345 1331.0	1.6707 1342.0	1.7419 1363.8	1.8118 1385.3	1.9149 1417.3	2.083 1470.1	2.249 1523.0	2.575 1630.0
400.0	385.3	444.59	v _{hg}	1.2851 1245.1	1.3652 1271.0	1.4770 1306.9	1.5480 1329.6	1.5827 1340.8	1.6508 1362.7	1.7177 1384.3	1.8161 1416.4	1.9767 1469.4	2.134 1522.4	2.445 1629.6
420.0	405.3	449.39	v _{hg}	1.2158 1242.5	1.2935 1268.9	1.4014 1305.3	1.4697 1328.3	1.5030 1339.5	1.5684 1361.6	1.6324 1383.3	1.7267 1415.5	1.8802 1468.7	2.031 1521.9	2.327 1629.2
440.0	425.3	454.02	v _{hg}	1.1526 1239.8	1.2282 1266.7	1.3327 1303.6	1.3984 1326.9	1.4306 1338.2	1.4934 1360.4	1.5549 1382.3	1.6454 1414.7	1.7925 1468.1	1.9368 1521.3	2.220 1628.8
460.0	445.3	458.5	v _{hg}	1.0948 1237.0	1.1685 1264.5	1.2698 1302.0	1.3334 1325.4	1.3644 1336.9	1.4250 1359.3	1.4842 1381.3	1.5711 1413.8	1.7124 1467.4	1.8508 1520.7	2.122 1628.4
480.0	465.3	462.82	v _{hg}	1.0417 1234.2	1.1138 1262.3	1.2122 1300.3	1.2737 1324.0	1.3038 1335.6	1.3622 1358.2	1.4193 1380.3	1.5031 1412.9	1.6390 1466.7	1.7720 1520.2	2.033 1628.0
500.0	485.3	467.01	v _{hg}	0.9927 1231.3	1.0633 1260.0	1.1591 1298.6	1.2188 1322.6	1.2478 1334.2	1.3044 1357.0	1.3596 1379.3	1.4405 1412.1	1.5715 1466.0	1.6996 1519.6	1.9504 1627.6
520.0	505.3	471.07	v _{hg}	0.9473 1228.3	1.0166 1257.7	1.1101 1296.9	1.1681 1321.1	1.1962 1332.9	1.2511 1355.8	1.3045 1378.2	1.3826 1411.2	1.5091 1465.3	1.636 1519.0	1.8743 1627.2
540.0	525.3	475.01	v _{hg}	0.9052 1225.3	0.9733 1255.4	1.0646 1295.2	1.1211 1319.7	1.1485 1331.5	1.2017 1354.6	1.2535 1377.2	1.3291 1410.3	1.4514 1464.6	1.5707 1518.5	1.8039 1626.8
560.0	545.3	478.85	v _{hg}	0.8659 1222.2	0.9330 1253.0	1.0224 1293.4	1.0775 1318.2	1.1041 1330.2	1.1558 1353.5	1.2060 1376.1	1.2794 1409.4	1.3978 1463.9	1.5132 1517.9	1.7385 1626.4
580.0	565.3	482.58	v _{hg}	0.8291 1219.0	0.8954 1250.5	0.9830 1291.7	1.0368 1316.7	1.0627 1328.8	1.1331 1352.3	1.1619 1375.1	1.2331 1408.6	1.3479 1463.2	1.4596 1517.3	1.6776 1626.0
600.0	585.3	486.21	v _{hg}	0.7947 1215.7	0.8602 1248.1	0.9463 1289.9	0.9988 1315.2	1.0241 1327.4	1.0732 1351.1	1.1207 1374.0	1.1899 1407.7	1.3013 1462.5	1.4096 1516.7	1.6208 1625.5
620.0	605.0	489.75	v _{hg}	0.7624 1212.4	0.8272 1245.5	0.9118 1288.1	0.9633 1313.7	0.9880 1326.0	1.0358 1349.9	1.0821 1373.0	1.1494 1406.8	1.2577 1461.8	1.3628 1516.2	1.5676 1625.1
640.0	625.3	493.21	v _{hg}	0.7319 1209.0	0.7963 1243.0	0.8795 1296.2	0.9299 1312.2	0.9541 1324.6	1.0008 1348.6	1.0459 1371.9	1.1115 1405.9	1.2168 1461.1	1.3190 1515.6	1.5178 1624.7
660.0	645.3	496.58	v _{hg}	0.7032 1205.4	0.7670 1240.4	0.8491 1284.4	0.8985 1310.6	0.9222 1323.2	0.9679 1347.4	1.0119 1370.8	1.0759 1405.0	1.1784 1460.4	1.2778 1515.0	1.4709 1624.3
680.0	665.3	499.88	v _{hg}	0.6759 1201.8	0.7395 1237.7	0.8205 1282.5	0.8690 1309.1	0.8922 1321.7	0.9369 1346.2	0.9800 1369.8	1.0424 1404.1	1.1423 1459.7	1.2390 1514.5	1.4269 1623.9
700.0	685.3	503.10	v _{hg}	--- ---	0.7134 1235.0	0.7934 1280.6	0.8411 1307.5	0.8639 1320.3	0.9077 1345.0	0.9498 1368.7	1.0108 1403.2	1.1082 1459.0	1.2024 1513.9	1.3853 1623.5
750.0	735.3	510.86	v _{hg}	--- ---	0.6540 1227.9	0.7319 1275.7	0.7778 1303.5	0.7996 1316.6	0.8414 1341.8	0.8813 1366.0	0.9391 1400.9	1.0310 1457.2	1.1196 1512.4	1.2912 1622.4
800.0	785.3	518.23	v _{hg}	--- ---	0.6015 1220.5	0.6779 1270.7	0.7223 1299.4	0.7433 1312.9	0.7833 1338.6	0.8215 1363.2	0.8763 1398.6	0.9633 1455.4	1.0470 1511.0	1.2088 1621.4
850.0	835.3	525.26	v _{hg}	--- ---	0.5546 1212.7	0.6301 1265.5	0.6732 1295.2	0.6934 1309.0	0.7320 1335.4	0.7685 1360.4	0.8209 1396.3	0.9037 1453.6	0.9830 1509.5	1.1360 1620.4
900.0	885.3	531.98	v _{hg}	--- ---	0.5124 1204.4	0.5873 1260.1	0.6294 1290.9	0.6491 1305.1	0.6863 1332.1	0.7215 1357.5	0.7716 1393.9	0.8506 1451.8	0.9262 1508.1	1.0714 1619.3
950.0	935.3	538.42	v _{hg}	--- ---	0.4740 1195.5	0.5489 1254.6	0.5901 1286.4	0.6092 1301.1	0.6453 1328.7	0.6793 1354.7	0.7275 1391.6	0.8031 1450.0	0.8753 1506.6	1.0136 1618.3
1000.0	985.3	544.61	v _{hg}	--- ---	--- ---	0.5140 1248.8	0.5546 1281.9	0.5733 1297.0	0.6084 1325.3	0.6413 1351.7	0.6878 1389.2	0.7604 1448.2	0.8294 1505.1	0.9615 1617.3

v = specific volume, cubic feet per pound
h_g = total heat of steam, BTU per pound

- continued -

Properties of Superheated Steam (continued)														
PRESSURE (PSI)		SAT. TEMP. t	v h _g	TOTAL TEMPERATURE -- °F (t)										
Absolute P'	Gauge P			660°	700°	740°	760°	780°	800°	860°	900°	1000°	1100°	1200°
1100.0	1085.3	556.31	v h _g	0.5110 1288.5	0.5445 1318.3	0.5755 1345.8	0.5904 1358.9	0.6049 1371.7	0.6191 1384.3	0.6601 1420.8	0.6866 1444.5	0.7503 1502.2	0.8117 1558.8	0.8716 1615.2
1200.0	1185.3	567.22	v h _g	0.4586 1279.6	0.4909 1311.0	0.5206 1339.6	0.5347 1353.2	0.5484 1366.4	0.5617 1379.3	0.6003 1416.7	0.6250 1440.7	0.6843 1499.2	0.7412 1556.4	0.7967 1613.1
1300.0	1285.3	577.46	v h _g	0.4139 1270.2	0.4454 1303.4	0.4739 1333.3	0.4874 1347.3	0.5004 1361.0	0.5131 1374.3	0.5496 1412.5	0.5728 1437.0	0.6284 1496.2	0.6816 1553.9	0.7333 1611.0
1400.0	1385.3	587.10	v h _g	0.3753 1260.3	0.4062 1295.5	0.4338 1326.7	0.4468 1341.3	0.4593 1355.4	0.4714 1369.1	0.5061 1408.2	0.5281 1433.1	0.5805 1493.2	0.6305 1551.4	0.6789 1608.9
1500.0	1485.3	596.23	v h _g	0.3413 1249.8	0.3719 1287.2	0.3989 1320.0	0.4114 1335.2	0.4235 1349.7	0.4352 1363.8	0.4684 1403.9	0.4893 1429.3	0.5390 1490.1	0.5862 1548.9	0.6318 1606.8
1600.0	1585.3	604.90	v h _g	0.3112 1238.7	0.3417 1278.7	0.3682 1313.0	0.3804 1328.8	0.3921 1343.9	0.4034 1358.4	0.4353 1399.5	0.4553 1425.3	0.5027 1487.0	0.5474 1546.4	0.5906 1604.6
1700.0	1685.3	613.15	v h _g	0.2842 1226.8	0.3148 1269.7	0.3410 1305.8	0.3529 1322.3	0.3643 1337.9	0.3753 1352.9	0.4061 1395.0	0.4253 1421.4	0.4706 1484.0	0.5132 1543.8	0.5542 1602.5
1800.0	1785.3	621.03	v h _g	0.2597 1214.0	0.2907 1260.3	0.3166 1298.4	0.3284 1315.5	0.3395 1331.8	0.3502 1347.2	0.3801 1390.4	0.3986 1417.4	0.4421 1480.8	0.4828 1541.3	0.5218 1600.4
1900.0	1885.3	628.58	v h _g	0.2371 1200.2	0.2688 1250.4	0.2947 1290.6	0.3063 1308.6	0.3171 1325.4	0.3277 1341.5	0.3568 1385.8	0.3747 1413.3	0.4165 1477.7	0.4556 1538.8	0.4929 1598.2
2000.0	1985.3	635.82	v h _g	0.2161 1184.9	0.2489 1240.0	0.2748 1282.6	0.2863 1301.4	0.2972 1319.0	0.3074 1335.5	0.3358 1381.2	0.3532 1409.2	0.3935 1474.5	0.4311 1536.2	0.4668 1596.1
2100.0	2085.3	642.77	v h _g	0.1962 1167.7	0.2306 1229.0	0.2567 1274.3	0.2682 1294.0	0.2789 1312.3	0.2890 1329.5	0.3167 1376.4	0.3337 1405.0	0.3727 1471.4	0.4089 1533.6	0.4433 1593.9
2200.0	2185.3	649.46	v h _g	0.1768 1147.8	0.2135 1217.4	0.2400 1265.7	0.2514 1286.3	0.2621 1305.4	0.2721 1323.3	0.2994 1371.5	0.3159 1400.8	0.3538 1468.2	0.3887 1531.1	0.4218 1591.8
2300.0	2285.3	655.91	v h _g	0.1575 1123.8	0.1978 1204.9	0.2247 1256.7	0.2362 1278.4	0.2468 1298.4	0.2567 1316.9	0.2835 1366.6	0.2997 1396.5	0.3365 1464.9	0.3703 1528.5	0.4023 1589.6
2400.0	2385.3	662.12	v h _g	---	0.1828 1191.5	0.2105 1247.3	0.2221 1270.2	0.2327 1291.1	0.2425 1310.3	0.2689 1361.6	0.2848 1392.2	0.3207 1461.7	0.3534 1525.9	0.3843 1587.4
2500.0	2485.3	668.13	v h _g	---	0.1686 1176.8	0.1973 1207.6	0.2090 1261.8	0.2196 1283.6	0.2294 1303.6	0.2555 1356.5	0.2710 1387.8	0.3061 1458.4	0.3379 1523.2	0.3678 1585.3
2600.0	2585.3	673.94	v h _g	---	0.1549 1160.6	0.1849 1227.3	0.1967 1252.9	0.2074 1275.8	0.2172 1296.8	0.2431 1351.4	0.2584 1383.4	0.2926 1455.1	0.3236 1520.6	0.3526 1583.1
2700.0	2685.3	679.55	v h _g	---	0.1415 1142.5	0.1732 1216.5	0.1853 1243.8	0.1960 1267.9	0.2059 1289.7	0.2315 1346.1	0.2466 1378.9	0.2801 1451.8	0.3103 1518.0	0.3385 1580.9
2800.0	2785.3	684.99	v h _g	---	0.1281 1121.4	0.1622 1205.1	0.1745 1234.2	0.1854 1259.6	0.1953 1282.4	0.2208 1340.8	0.2356 1374.3	0.2685 1448.5	0.2979 1515.4	0.3254 1578.7
2900.0	2885.3	690.26	v h _g	---	0.1143 1095.9	0.1517 1193.0	0.1644 1224.3	0.1754 1251.1	0.1853 1274.9	0.2108 1335.3	0.2254 1369.7	0.2577 1445.1	0.2864 1512.7	0.3132 1576.5
3000.0	2985.3	695.36	v h _g	---	0.0984 1060.7	0.1416 1180.1	0.1548 1213.8	0.1660 1242.2	0.1760 1267.2	0.2014 1329.7	0.2159 1365.0	0.2476 1441.8	0.2757 1510.0	0.3018 1574.3
3100.0	3085.3	700.31	v h _g	---	---	0.1320 1166.2	0.1456 1202.9	0.1571 1233.0	0.1672 1259.3	0.1926 1324.1	0.2070 1360.3	0.2382 1438.4	0.2657 1507.4	0.2911 1572.1
3200.0	3185.3	705.11	v h _g	---	---	0.1226 1151.1	0.1369 1191.4	0.1486 1223.5	0.1589 1251.1	0.1843 1318.3	0.1986 1355.5	0.2293 1434.9	0.2563 1504.7	0.2811 1569.9
3206.2	3191.5	705.40	v h _g	---	---	0.1220 1150.2	0.1363 1190.6	0.1480 1222.9	0.1583 1250.5	0.1838 1317.9	0.1981 1355.2	0.2288 1434.7	0.2557 1504.5	0.2806 1569.8

v = specific volume, cubic feet per pound
h_g = total heat of steam, BTU per pound

Determine Velocity of Steam in Pipes:

$$\text{Velocity (ft/s)} = \frac{(25)(A)}{(V)}$$

Where: A = Nominal pipe section area = $\frac{\pi(d)^2}{4}$
 d = Diameter
 V = Specific volume from steam tables
 in ft³/lb (m³/kg)

Note: Specific volume changes with steam pressure and temperature. Make sure to calculate velocities of inlet and outlet piping of the regulator.

Recommended Steam Pipe Line Velocities	
STEAM CONDITION	VELOCITY, FEET/SECOND (METERS/SECOND)
0 to 15 psig (0 to 1,0 bar), Dry and saturated	100 (30,5)
15 psig (1,0 bar), Dry and saturated and up	175 (53,3)
200 psig (13,8 bar), Superheated and up	250 (76,2)

Typical Condensation Rates In Insulated Steam Pipes						
PRESSURE, PSIG (BAR)	RATES IN POUNDS/HOUR (KG/HOUR) PER FOOT OF PIPE WITH 2 INCHES OF INSULATION					
	Pipe Diameter in Inches					
	3/4	1	1-1/2	2	3	4
1 (0,069)	0.02 (0,009)	0.03 (0,014)	0.03 (0,014)	0.04 (0,018)	0.05 (0,023)	0.06 (0,027)
5 (0,34)	0.03 (0,014)	0.03 (0,014)	0.04 (0,018)	0.04 (0,018)	0.05 (0,023)	0.06 (0,027)
10 (0,69)	0.03 (0,014)	0.03 (0,014)	0.04 (0,018)	0.04 (0,018)	0.05 (0,023)	0.07 (0,032)
25 (1,7)	0.03 (0,014)	0.04 (0,018)	0.05 (0,023)	0.05 (0,023)	0.06 (0,027)	0.08 (0,036)
50 (3,4)	0.04 (0,018)	0.04 (0,018)	0.05 (0,023)	0.06 (0,027)	0.09 (0,041)	0.11 (0,05)
75 (5,2)	0.04 (0,018)	0.05 (0,023)	0.06 (0,027)	0.07 (0,032)	0.11 (0,05)	0.14 (0,064)
100 (6,9)	0.05 (0,023)	0.05 (0,023)	0.07 (0,032)	0.08 (0,036)	0.12 (0,054)	0.15 (0,068)
125 (8,6)	0.05 (0,023)	0.06 (0,027)	0.07 (0,032)	0.08 (0,036)	0.13 (0,059)	0.16 (0,073)
150 (10,3)	0.06 (0,027)	0.06 (0,027)	0.08 (0,036)	0.09 (0,041)	0.14 (0,064)	0.17 (0,077)
200 (13,8)	0.06 (0,027)	0.07 (0,032)	0.08 (0,036)	0.09 (0,041)	0.15 (0,068)	0.19 (0,086)

Typical Condensation Rates In Steam Pipes Without Insulation						
PRESSURE, PSIG (BAR)	RATES IN POUNDS/HOUR (KG/HOUR) PER FOOT OF BARE PIPE AT 72°F (22°C) AMBIENT AIR					
	Pipe Diameter in Inches					
	3/4	1	1-1/2	2	3	4
1 (0,069)	0.11 (0,05)	0.15 (0,068)	0.21 (0,095)	0.25 (0,113)	0.38 (0,172)	0.46 (0,209)
5 (0,34)	0.14 (0,064)	0.16 (0,073)	0.22 (0,1)	0.26 (0,118)	0.41 (0,186)	0.50 (0,227)
10 (0,69)	0.15 (0,068)	0.18 (0,082)	0.24 (0,109)	0.29 (0,132)	0.44 (0,2)	0.53 (0,24)
25 (1,7)	0.17 (0,077)	0.22 (0,1)	0.31 (0,141)	0.36 (0,163)	0.53 (0,24)	0.65 (0,295)
50 (3,4)	0.22 (0,1)	0.27 (0,122)	0.39 (0,177)	0.46 (0,209)	0.66 (0,299)	0.83 (0,376)
75 (5,2)	0.26 (0,118)	0.31 (0,141)	0.45 (0,204)	0.54 (0,245)	0.77 (0,349)	1.04 (0,472)
100 (6,9)	0.29 (0,132)	0.35 (0,159)	0.50 (0,227)	0.61 (0,277)	0.86 (0,39)	1.11 (0,503)
125 (8,6)	0.32 (0,145)	0.39 (0,177)	0.55 (0,249)	0.68 (0,308)	0.94 (0,426)	1.23 (0,558)
150 (10,3)	0.35 (0,159)	0.42 (0,191)	0.60 (0,272)	0.74 (0,336)	1.03 (0,467)	1.33 (0,603)
200 (13,8)	0.40 (0,181)	0.49 (0,222)	0.69 (0,313)	0.81 (0,367)	1.19 (0,54)	1.50 (0,68)

Flow of Water Through Schedule 40 Steel Pipes																	
DISCHARGE		PRESSURE DROP PER 100 FEET AND VELOCITY IN SCHEDULE 40 PIPE FOR WATER AT 60°F															
Gallons per Minute	Cubic Ft. per Second	Velocity (Ft. per Sec.)	Pressure Drop (PSI)	Velocity (Ft. per Sec.)	Pressure Drop (PSI)	Velocity (Ft. per Sec.)	Pressure Drop (PSI)	Velocity (Ft. per Sec.)	Pressure Drop (PSI)	Velocity (Ft. per Sec.)	Pressure Drop (PSI)	Velocity (Ft. per Sec.)	Pressure Drop (PSI)	Velocity (Ft. per Sec.)	Pressure Drop (PSI)	Velocity (Ft. per Sec.)	Pressure Drop (PSI)
0.2	0.000446	1/8"		1/4"		3/8"		1/2"		3/4"		1"		1-1/4"		1-1/2"	
0.3	0.000668	1.13	1.86	0.616	0.359	0.504	0.159	0.317	0.061								
0.4	0.000891	1.69	4.22	0.924	0.903	0.672	0.345	0.422	0.086								
0.5	0.00111	2.26	6.98	1.23	1.61	0.840	0.539	0.528	0.167	0.301	0.033						
0.6	0.00134	2.82	10.5	1.54	2.39	1.01	0.751	0.633	0.240	0.361	0.041						
0.8	0.00178	3.39	14.7	1.85	3.29	1.34	1.25	0.844	0.408	0.481	0.102						
1	0.00223	4.52	25.0	2.46	5.44	1.68	1.85	1.06	0.600	0.602	0.155	0.371	0.048				
2	0.00446	2"		3.08	8.28	6.16	30.1	3.36	6.58	1.20	0.526	0.743	0.164	0.429	0.044		
3	0.00668			9.25	64.1	9.25	64.1	5.04	13.9	1.81	1.09	1.114	0.336	0.644	0.090	0.473	0.043
4	0.00891			12.33	111.2	6.72	23.9	4.22	7.42	2.41	1.83	1.49	0.565	0.858	0.150	0.630	0.071
5	0.01114			8.40	36.7	8.40	36.7	5.28	11.2	3.01	2.75	1.86	0.835	1.073	0.223	0.788	0.104
6	0.01337	0.574	0.044	2-1/2"		10.08	51.9	6.33	15.8	3.61	3.84	2.23	1.17	1.29	0.309	0.943	0.145
8	0.01782	0.765	0.073			13.44	91.1	8.45	27.7	4.81	6.60	2.97	1.99	1.72	0.518	1.26	0.241
10	0.02228	0.956	0.108	0.670	0.046	3"		10.56	42.4	6.02	9.99	3.71	2.99	2.15	0.774	1.58	0.361
15	0.03342	1.43	0.224	1.01	0.094	3-1/2"		9.03	21.6	9.03	21.6	5.57	6.36	3.22	1.63	2.37	0.755
20	0.04456	1.91	0.375	1.34	0.158	0.868	0.056	12.03	37.8	7.43	10.9	4.29	2.78	4.29	2.78	3.16	1.28
25	0.05570	2.39	0.561	1.68	0.234	1.09	0.083	0.812	0.041	4"		9.28	16.7	5.37	4.22	3.94	1.93
30	0.06684	2.87	0.786	2.01	0.327	1.30	0.114	0.974	0.056			11.14	23.8	6.44	5.92	4.73	2.72
35	0.07798	3.35	1.05	2.35	0.436	1.52	0.151	1.14	0.071	0.882	0.041	12.99	32.2	7.51	7.90	5.52	3.64
40	0.08912	3.83	1.35	2.68	0.556	1.74	0.192	1.30	0.095	1.01	0.052	14.85	41.5	8.59	10.24	6.30	4.65
45	0.1003	4.30	1.67	3.02	0.668	1.95	0.239	1.46	0.117	1.13	0.064			9.67	12.80	7.09	5.85
50	0.1114	4.78	2.03	3.35	0.839	2.17	0.288	1.62	0.142	1.26	0.076			10.74	15.66	7.88	7.15
60	0.1337	5.74	2.87	4.02	1.18	2.60	0.46	1.95	0.204	1.51	0.107	5"		12.89	22.2	9.47	10.21
70	0.1560	6.70	3.84	4.69	1.59	3.04	0.540	2.27	0.261	1.76	0.143	1.12	0.047			11.05	13.71
80	0.1782	7.65	4.97	5.36	2.03	3.47	0.687	2.60	0.334	2.02	0.180	1.28	0.060			12.62	17.59
90	0.2005	8.60	6.20	6.03	2.53	3.91	0.861	2.92	0.416	2.27	0.224	1.44	0.074	6"		14.20	22.0
100	0.2228	9.56	7.59	6.70	3.09	4.34	1.05	3.25	0.509	2.52	0.272	1.60	0.090	1.11	0.036	15.778	26.9
125	0.2785	11.97	11.76	8.38	4.71	5.43	1.61	4.06	0.769	3.15	0.415	2.01	0.135	1.39	0.055	19.72	41.4
150	0.3342	14.36	16.70	10.05	6.69	6.51	2.24	4.87	1.08	3.78	0.580	2.41	0.190	1.67	0.077		
175	0.3899	16.75	22.3	11.73	8.97	7.60	3.00	5.68	1.44	4.41	0.774	2.81	0.253	1.94	0.102		
200	0.4456	19.14	28.8	13.42	11.68	8.68	3.87	6.49	1.85	5.04	0.985	3.21	0.323	2.22	0.130	8"	
225	0.5013	---	---	15.09	14.63	9.77	4.83	7.30	2.32	5.67	1.23	3.61	0.401	2.50	0.162	1.44	0.043
250	0.557	---	---	---	---	10.85	5.93	8.12	2.84	6.30	1.46	4.01	0.495	2.78	0.195	1.60	0.051
275	0.6127	---	---	---	---	11.94	7.14	8.93	3.40	6.93	1.79	4.41	0.583	3.05	0.234	1.76	0.061
300	0.6684	---	---	---	---	13.00	8.36	9.74	4.02	7.56	2.11	4.81	0.683	3.33	0.275	1.92	0.072
325	0.7241	---	---	---	---	14.12	9.89	10.53	4.09	8.19	2.47	5.21	0.797	3.61	0.320	2.08	0.083
350	0.7798			---	---	---	---	11.36	5.51	8.82	2.84	5.62	0.919	3.89	0.367	2.24	0.095
375	0.8355			---	---	---	---	12.17	6.18	9.45	3.25	6.02	1.05	4.16	0.416	2.40	0.108
400	0.8912			---	---	---	---	12.98	7.03	10.08	3.68	6.42	1.19	4.44	0.471	2.56	0.121
425	0.9469			---	---	---	---	13.80	7.89	10.71	4.12	6.82	1.33	4.72	0.529	2.73	0.136
450	1.003	10"		---	---	---	---	14.61	8.80	11.34	4.60	7.22	1.48	5.00	0.590	2.89	0.151
475	1.059	1.93	0.054	---	---	---	---	---	---	11.97	5.12	7.62	1.64	5.27	0.653	3.04	0.166
500	1.114	2.03	0.059	---	---	---	---	---	---	12.60	5.65	8.02	1.81	5.55	0.720	3.21	0.182
550	1.225	2.24	0.071	---	---	---	---	---	---	13.85	6.79	8.82	2.17	6.11	0.861	3.53	0.219
600	1.337	2.44	0.083	---	---	---	---	---	---	15.12	8.04	9.63	2.55	6.66	1.02	3.85	0.258
650	1.448	2.64	0.097	---	---	---	---	---	---	---	---	10.43	2.98	7.22	1.18	4.17	0.301

- continued -

Flow of Water Through Schedule 40 Steel Pipes (continued)																			
DISCHARGE		PRESSURE DROP PER 100 FEET AND VELOCITY IN SCHEDULE 40 PIPE FOR WATER AT 60°F																	
Gallons per Minute	Cubic Ft. per Second	Velocity (Ft. per Sec.)	Pressure Drop (PSI)	Velocity (Ft. per Sec.)	Pressure Drop (PSI)	Velocity (Ft. per Sec.)	Pressure Drop (PSI)	Velocity (Ft. per Sec.)	Pressure Drop (PSI)	Velocity (Ft. per Sec.)	Pressure Drop (PSI)	Velocity (Ft. per Sec.)	Pressure Drop (PSI)	Velocity (Ft. per Sec.)	Pressure Drop (PSI)	Velocity (Ft. per Sec.)	Pressure Drop (PSI)		
		10"		12"		14"				5"		6"		8"					
700	1.560	2.85	0.112	2.01	0.047					---	---	---	---	11.23	3.43	7.78	1.35	4.49	0.343
750	1.671	3.05	0.127	2.15	0.054					---	---	---	---	12.03	3.92	8.33	1.55	4.81	0.392
800	1.782	3.25	0.143	2.29	0.061					---	---	---	---	12.83	4.43	8.88	1.75	5.13	0.443
850	1.894	3.46	0.160	2.44	0.068	2.02	0.042	---	---	---	---	---	---	13.64	5.00	9.44	1.96	5.45	0.497
900	2.005	3.66	0.179	2.58	0.075	2.13	0.047	---	---	---	---	---	---	14.44	5.58	9.99	2.18	5.77	0.554
950	2.117	3.86	0.198	2.72	0.083	2.25	0.052	---	---	---	---	---	---	15.24	6.21	10.55	2.42	6.09	0.613
1000	2.228	4.07	0.218	2.87	0.091	2.37	0.057			---	---	---	---	16.04	6.84	11.10	2.68	6.41	0.675
1100	2.451	4.48	0.260	3.15	0.110	2.61	0.068	16"		---	---	---	---	17.65	8.23	12.22	3.22	7.05	0.807
1200	2.674	4.88	0.306	3.44	0.128	2.85	0.800	2.18	0.042	---	---	---	---	---	---	13.33	3.81	7.70	0.948
1300	2.896	5.29	0.355	3.73	0.150	3.08	0.093	2.36	0.048	---	---	---	---	---	---	14.43	4.45	8.33	1.11
1400	3.119	5.70	0.409	4.01	0.171	3.32	0.107	2.54	0.055	---	---	---	---	---	---	15.55	5.13	8.98	1.28
1500	3.342	6.10	0.466	4.30	0.195	3.56	0.122	2.72	0.063	18"						16.66	5.85	9.62	1.46
1600	3.565	6.51	0.527	4.59	0.219	3.79	0.138	2.90	0.071							17.77	6.61	10.26	1.65
1800	4.010	7.32	0.663	5.16	0.276	4.27	0.172	3.27	0.088	2.58	0.050					19.99	8.37	11.54	2.08
2000	4.456	8.14	0.808	5.73	0.339	4.74	0.209	3.63	0.107	2.87	0.060	20"				22.21	10.3	12.82	2.55
2500	5.570	10.17	1.24	7.17	0.515	5.93	0.321	4.54	0.163	3.59	0.091							16.03	3.94
3000	6.684	12.20	1.76	8.60	0.731	7.11	0.451	5.45	0.232	4.30	0.129	3.46	0.075					19.24	5.59
3500	7.798	14.24	2.38	10.03	0.982	8.30	0.607	6.35	0.312	5.02	0.173	4.04	0.101	24"				22.44	7.56
4000	8.912	16.27	3.08	11.47	1.27	9.48	0.787	7.26	0.401	5.74	0.222	4.62	0.129			3.19	0.052	25.65	9.80
4500	10.03	18.31	3.87	12.90	1.60	10.67	0.990	8.17	0.503	6.46	0.280	5.20	0.162			3.59	0.065	28.87	12.2
5000	11.14	20.35	4.71	14.33	1.95	11.85	1.21	9.08	0.617	7.17	0.340	5.77	0.199			3.99	0.079	---	---
6000	13.37	24.41	6.74	17.20	2.77	14.23	1.71	10.89	0.877	8.61	0.483	6.93	0.280			4.79	0.111	---	---
7000	15.60	28.49	9.11	20.07	3.74	16.60	2.31	12.71	1.18	10.04	0.652	8.08	0.376			5.59	0.150	---	---
8000	17.82	---	---	22.93	4.84	18.96	2.99	14.52	1.51	11.47	0.839	9.23	0.488			6.38	0.192	---	---
9000	20.05	---	---	25.79	6.09	21.34	3.76	16.34	1.90	12.91	1.05	10.39	0.608			7.18	0.242	---	---
10,000	22.28	---	---	28.66	7.46	23.71	4.61	18.15	2.34	14.34	1.28	11.54	0.739			7.98	0.294	---	---
12,000	26.74	---	---	34.40	10.7	28.45	6.59	21.79	3.33	17.21	1.83	13.85	1.06			9.58	0.416	---	---
14,000	31.19	---	---	---	---	33.19	8.89	25.42	4.49	20.08	2.45	16.16	1.43			11.17	0.562	---	---
16,000	35.65	---	---	---	---	---	---	29.05	5.83	22.95	3.18	18.47	1.85			12.77	0.723	---	---
18,000	40.10	---	---	---	---	---	---	32.68	7.31	25.82	4.03	20.77	2.32			14.36	0.907	---	---
20,000	44.56	---	---	---	---	---	---	36.31	9.03	28.69	4.93	23.08	2.86			15.96	1.12	---	---

For pipe lengths other than 100 feet, the pressure drop is proportional to the length. Thus, for 50 feet of pipe, the pressure drop is approximately one half the value given in the table -- or 300 feet, three times the given value, etc.
 For calculations for pipe other than Schedule 40, see explanation on page 161.
 Velocity is a function of the cross sectional flow area; thus, it is constant for a given flow rate and is independent of pipe length.
 Extracted from Technical Paper No. 410, Flow of Fluids, with permission of Crane Co.

Flow of Air Through Schedule 40 Steel Pipes										
FREE AIR Q ^M	COMPRESSED AIR	PRESSURE DROP OF AIR IN POUNDS PER SQUARE INCH PER 100 FEET OF SCHEDULE 40 PIPE FOR AIR AT 100 POUNDS PER SQUARE INCH GAUGE PRESSURE AND 60°F TEMPERATURE								
		1/8"	1/4"	3/8"	1/2"	3/4"	1"	1-1/4"	1-1/2"	2"
Cubic Feet per Minute at 60°F and 14.7 psia	Cubic Feet per Minute at 60°F and 100 psig									
1	0.128	0.361	0.083	0.018						
2	0.256	1.31	0.285	0.064	0.020					
3	0.384	3.06	0.605	0.133	0.042					
4	0.513	4.83	1.04	0.226	0.071					
5	0.641	7.45	1.58	0.343	0.106	0.027				
6	0.769	10.6	2.23	0.408	0.148	0.037				
8	1.025	18.6	3.89	0.848	0.255	0.062	0.019			
10	1.282	28.7	5.96	1.26	0.356	0.094	0.029			
15	1.922	---	13.0	2.73	0.834	0.201	0.062			
20	2.563	---	22.8	4.76	1.43	0.345	0.102	0.026		
25	3.204	---	35.6	7.34	2.21	0.526	0.156	0.039	0.019	
30	3.845	---	---	10.5	3.15	0.748	0.219	0.055	0.026	
35	4.486	---	---	14.2	4.24	1.00	0.293	0.073	0.035	
40	5.126	---	---	18.4	5.49	1.30	0.379	0.095	0.044	
45	5.767	---	---	23.1	6.90	1.62	0.474	0.116	0.055	
50	6.408			28.5	8.49	1.99	0.578	0.149	0.067	0.019
60	7.690	2-1/2"		40.7	12.2	2.85	0.819	0.200	0.094	0.027
70	8.971			---	16.5	3.83	1.10	0.270	0.126	0.036
80	10.25	0.019		---	21.4	4.96	1.43	0.350	0.162	0.046
90	11.53	0.023		---	27.0	6.25	1.80	0.437	0.203	0.058
100	12.82	0.029	3"		33.2	7.69	2.21	0.534	0.247	0.070
125	16.02	0.044			---	11.9	3.39	0.825	0.380	0.107
150	19.22	0.062	0.021		---	17.0	4.87	1.17	0.537	0.151
175	22.43	0.083	0.028	3-1/2"	---	23.1	6.60	1.58	0.727	0.205
200	25.63	0.107	0.036		---	30.0	8.54	2.05	0.937	0.264
225	28.84	0.134	0.045	0.022		37.9	10.8	2.59	1.19	0.331
250	32.04	0.164	0.055	0.027		---	13.3	3.18	1.45	0.404
275	35.24	0.191	0.066	0.032		---	16.0	3.83	1.75	0.484
300	38.45	0.232	0.078	0.037		---	19.0	4.56	2.07	0.573
325	41.65	0.270	0.090	0.043	4"	---	22.3	5.32	2.42	0.673
350	44.87	0.313	0.104	0.050		---	25.8	6.17	2.80	0.776
375	48.06	0.356	0.119	0.057	0.030	---	29.6	7.05	3.20	0.887
400	51.26	0.402	0.134	0.064	0.034	---	33.6	8.02	3.64	1.00
425	54.47	0.452	0.151	0.072	0.038	---	37.9	9.01	4.09	1.13
450	57.67	0.507	0.168	0.081	0.042	---	---	10.2	4.59	1.26
475	60.88	0.562	0.187	0.089	0.047		---	11.3	5.09	1.40
500	64.08	0.623	0.206	0.099	0.052		---	12.5	5.61	1.55
550	70.49	0.749	0.248	0.118	0.062		---	15.1	6.79	1.87
600	76.90	0.887	0.293	0.139	0.073	5"	---	18.0	8.04	2.21
650	83.30	1.04	0.342	0.163	0.086		---	21.1	9.43	2.60
700	89.71	1.19	0.395	0.188	0.099	0.032		24.3	10.9	3.00
750	96.12	1.36	0.451	0.214	0.113	0.036		27.9	12.6	3.44
800	102.5	1.55	0.513	0.244	0.127	0.041		31.8	14.2	3.90
850	108.9	1.74	0.576	0.274	0.144	0.046	6"	35.9	16.0	4.40
900	115.3	1.95	0.642	0.305	0.160	0.051		40.2	18.0	4.91
950	121.8	2.18	0.715	0.340	0.178	0.057	0.023	---	20.0	5.47
1,000	128.2	2.40	0.788	0.375	0.197	0.063	0.025	---	22.1	6.06
1,100	141.0	2.89	0.948	0.451	0.236	0.075	0.030	---	26.7	7.29
1,200	153.8	3.44	1.13	0.533	0.279	0.089	0.035	---	31.8	8.63
1,300	166.6	4.01	1.32	0.626	0.327	0.103	0.041	---	37.3	10.1

- continued -

Flow of Air Through Schedule 40 Steel Pipes (continued)										
FREE AIR Q ^{FM}	COMPRESSED AIR	PRESSURE DROP OF AIR IN POUNDS PER SQUARE INCH PER 100 FEET OF SCHEDULE 40 PIPE FOR AIR AT 100 POUNDS PER SQUARE INCH GAUGE PRESSURE AND 60°F TEMPERATURE								
Cubic Feet per Minute at 60°F and 14.7 psia	Cubic Feet per Minute at 60°F and 100 psig	2-1/2"	3"	3-1/2"	4"	5"	6"	8"	10"	12"
1,400	179.4	4.65	1.52	0.718	0.377	0.119	0.047			11.8
1,500	192.2	5.31	1.74	0.824	0.431	0.136	0.054			13.5
1,600	205.1	6.04	1.97	0.932	0.490	0.154	0.061			15.3
1,800	230.7	7.65	2.50	1.18	0.616	0.193	0.075			19.3
2,000	256.3	9.44	3.06	1.45	0.757	0.237	0.094	0.023		23.9
2,500	320.4	14.7	4.76	2.25	1.17	0.366	0.143	0.035		37.3
3,000	384.5	21.1	6.82	3.20	1.67	0.524	0.204	0.051	0.016	
3,500	448.6	28.8	9.23	4.33	2.26	0.709	0.276	0.068	0.022	
4,000	512.6	37.6	12.1	5.66	2.94	0.919	0.358	0.088	0.028	12"
4,500	576.7	47.6	15.3	7.16	3.69	1.16	0.450	0.111	0.035	
5,000	640.8	---	18.8	8.85	4.56	1.42	0.552	0.136	0.043	0.018
6,000	769.0	---	27.1	12.7	6.57	2.03	0.794	0.195	0.061	0.025
7,000	897.1	---	36.9	17.2	8.94	2.76	1.07	0.262	0.082	0.034
8,000	1025	---	---	22.5	11.7	3.59	1.39	0.339	0.107	0.044
9,000	1153	---	---	28.5	14.9	4.54	1.76	0.427	0.134	0.055
10,000	1282	---	---	35.2	18.4	5.60	2.16	0.526	0.164	0.067
11,000	1410	---	---	---	22.2	6.78	2.62	0.633	0.197	0.081
12,000	1538	---	---	---	26.4	8.07	3.09	0.753	0.234	0.096
13,000	1666	---	---	---	31.0	9.47	3.63	0.884	0.273	0.112
14,000	1794	---	---	---	36.0	11.0	4.21	1.02	0.316	0.129
15,000	1922	---	---	---	---	12.6	4.84	1.17	0.364	0.148
16,000	2051	---	---	---	---	14.3	5.50	1.33	0.411	0.167
18,000	2307	---	---	---	---	18.2	6.96	1.68	0.520	0.213
20,000	2563	---	---	---	---	22.4	8.60	2.01	0.642	0.260
22,000	2820	---	---	---	---	27.1	10.4	2.50	0.771	0.314
24,000	3076	---	---	---	---	32.3	12.4	2.97	0.918	0.371
26,000	3332	---	---	---	---	37.9	14.5	3.49	1.12	0.435
28,000	3588	---	---	---	---	---	16.9	4.04	1.25	0.505
30,000	3845	---	---	---	---	---	19.3	4.64	1.42	0.520

Extracted from Technical Paper No. 410, Flow of Fluids, with permission of Crane Co.

Average Properties of Propane	
Formula	C ₃ H ₈
Boiling Point, °F (°C)	-44 (-42)
Specific Gravity of Gas (Air = 1.00)	1.53
Pounds per Gallon of Liquid at 60°F (16°C)	4.24
BTU per Gallon of Gas at 60°F (16°C)	91,547
BTU per Pound of Gas	21,591
BTU per Cubic Foot of Gas at 60°F (16°C)	2516
Cubic Feet of Vapor at 60°F (16°C) per Gallon of Liquid at 60°F (16°C)	36.39
Cubic Feet of Vapor at 60°F (16°C) per Pound of Liquid at 60°F (16°C)	8.547
Latent Heat of Vaporization at Boiling Point, BTU per Gallon	785.0
Combustion Data	
Cubic Feet of Air Required to Burn 1 Cubic Foot of Gas	23.86
Flash Point, °F (°C)	-156 (-104)
Ignition Temperature in Air, °F (°C)	920 to 1020 (493 to 549)
Maximum Flame Temperature in Air, °F (°C)	3595 (1979)
Limits of Inflammability, Percentage of Gas in Air Mixture	
at Lower Limit	2.4%
at Upper Limit	9.6%
Octane Number (ISO Octane = 100)	Over 100

Standard Domestic Propane Tank Specifications			
Capacity	Diameter	Length	Tank Weight
Gallons (Liters)	Inches (mm)	Inches (mm)	Pounds (Kg)
120 (454)	24 (610)	68 (1727)	288 (131)
150 (568)	24 (610)	84 (2134)	352 (160)
200 (757)	30 (762)	79 (2007)	463 (210)
250 (946)	30 (762)	94 (2387)	542 (246)
325 (1230)	30 (762)	119 (3023)	672 (305)
500 (1893)	37 (940)	119 (3023)	1062 (482)
1000 (3785)	41 (1041)	192 (4877)	1983 (900)

Approximate Vaporization Capacities of Propane Tanks		
BTU PER HOUR WITH 40% LIQUID IN DOMESTIC TANK SYSTEMS		
Tank Size Water Capacity	Prevailing Air Temperature	
	20°F (-7°C)	60°F (16°C)
120	235,008	417,792
150	290,304	516,096
200	341,280	606,720
250	406,080	721,920
325	514,100	937,900
500	634,032	1,127,168
1000	1,088,472	1,978,051

Orifice Capacities for Propane			
ORIFICE OR DRILL SIZE	ORIFICE CAPACITY BTU PER HOUR, 11-INCHES W.C.	ORIFICE OR DRILL SIZE	ORIFICE CAPACITY BTU PER HOUR, 11-INCHES W.C.
.008	519	51	36531
.009	656	50	39842
.010	812	49	43361
.011	981	48	46983
.012	1169	47	50088
80	1480	46	53296
79	1708	45	54641
78	2080	44	60229
77	2629	43	64369
76	3249	42	71095
75	3581	41	74924
74	4119	40	78029
73	4678	39	80513
72	5081	38	83721
71	5495	37	87860
70	6375	36	92207
69	6934	35	98312
68	7813	34	100175
67	8320	33	103797
66	8848	32	109385
65	9955	31	117043
64	10535	30	134119
63	11125	29	150366
62	11735	28	160301
61	12367	27	168580
60	13008	26	175617
59	13660	25	181619
58	14333	24	187828
57	15026	23	192796
56	17572	22	200350
55	21939	21	205525
54	24630	20	210699
53	28769	19	223945
52	32805	18	233466

BTU per cubic foot = 2516
 Specific Gravity = 1.52
 Pressure at orifice, inches of water column = 11
 Orifice Coefficient = 0.9

Pipe and Tubing Sizing												
PROPANE PIPE AND TUBING SIZING BETWEEN SINGLE OR SECOND STAGE LOW PRESSURE REGULATORS AND APPLIANCES												
Pipe or Tubing Length, Feet	Copper Tubing Size, Outside Diameter (Inside Diameter), Type L					Pipe or Tubing Length, Feet	Nominal Pipe Size, Outside Diameter (Inside Diameter), Schedule 40					
	3/8 (0.315)	1/2 (0.430)	5/8 (0.545)	3/4 (0.666)	7/8 (0.785)		1/2 (0.622)	3/4 (0.824)	1 (1.049)	1-1/4 (1.380)	1-1/2 (1.610)	2 (2.067)
10	49	110	206	348	536	10	291	608	1146	2353	3525	6789
20	34	76	151	239	368	20	200	418	788	1617	2423	4666
30	27	61	114	192	296	30	161	336	632	1299	1946	3747
40	23	52	97	164	253	40	137	282	541	1111	1665	3207
50	20	46	86	146	224	50	122	557	480	985	1476	2842
60	19	42	78	132	203	60	110	231	435	892	1337	2575
70	17	39	72	121	187	80	94	198	372	764	1144	2204
80	16	36	67	113	174	100	84	175	330	677	1014	1954
90	15	34	63	106	163	125	74	155	292	600	899	1731
100	14	32	59	100	154	150	67	141	265	544	815	1569
150	11	26	48	80								

To convert to capacities in cubic feet per hour, divide by 2.5
 Note: Maximum undiluted propane capacities listed are based on 11-inches w.c. setting and a 0.5-inch w.c. pressure drop - Capacities in 1,000 BTU per hour

Vapor Pressures of Propane							
Temperature	Pressure	Temperature	Pressure	Temperature	Pressure	Temperature	Pressure
°F (°C)	Psig (Bar)	°F (°C)	Psig (Bar)	°F (°C)	Psig (Bar)	°F (°C)	Psig (Bar)
130 (54)	257 (18)	70 (21)	109 (8)	20 (-7)	40 (2,8)	-20 (-29)	10 (0,69)
120 (49)	225 (16)	65 (18)	100 (6,9)	10 (-12)	31 (2)	-25 (-32)	8 (0,55)
110 (43)	197 (14)	60 (16)	92 (6)	0 (-17)	23 (2)	-30 (-34)	5 (0,34)
100 (38)	172 (12)	50 (10)	77 (5)	-5 (-21)	20 (1,4)	-35 (-37)	3 (0,21)
90 (32)	149 (10)	40 (4)	63 (4)	-10 (-23)	16 (1)	-40 (-40)	1 (0,069)
80 (27)	128 (9)	30 (-1)	51 (4)	-15 (-26)	13 (1)	-44 (-42)	0 (0)

Converting Volumes of Gas		
CFH TO CFH OR CFM TO CFM		
Multiply Flow of	By	To Obtain Flow of
Air	0.707	Butane
	1.290	Natural Gas
	0.808	Propane
Butane	1.414	Air
	1.826	Natural Gas
Natural Gas	1.140	Propane
	0.775	Air
	0.547	Butane
Propane	0.625	Propane
	1.237	Air
	0.874	Butane
	1.598	Natural Gas

BTU Comparisons		
COMMON FUELS	PER GALLON	PER POUND
Propane	91,547	21,591
Butane	102,032	21,221
Gasoline	110,250	20,930
Fuel Oil	134,425	16,960

Capacities of Spuds and Orifices																					
DRILL DESIGNATION	DIAMETER, INCHES	AREA, SQUARE INCHES	CAPACITIES IN CFH OF 0.6 GRAVITY HIGH PRESSURE NATURAL GAS AND AN ORIFICE COEFFICIENT OF 1.0																		
			Upstream Pressure, Psi Gauge																		
			1	2	3	4	5	6	7	8	9	10	12	14	16	18	20	25	30	40	50
80	0.0135	0.000143	1.61	2.26	2.76	3.17	3.52	3.84	4.13	4.40	4.65	4.88	5.31	5.65	6.05	6.44	6.84	7.82	8.80	10.8	12.8
79	0.0145	0.000163	1.85	2.61	3.18	3.65	4.06	4.43	4.77	5.07	5.36	5.63	6.12	6.52	6.98	7.43	7.89	9.02	10.2	12.5	14.7
1/64"	0.0156	0.000191	2.14	3.02	3.68	4.23	4.70	5.13	5.52	5.87	6.20	6.51	7.09	7.55	8.08	8.61	9.13	10.5	11.8	14.4	17.1
78	0.0160	0.000201	2.26	3.18	3.88	4.45	4.94	5.40	5.81	6.18	6.53	6.85	7.46	7.95	8.50	9.05	9.61	11.0	12.4	15.2	17.9
77	0.0180	0.000234	2.85	4.02	4.90	5.62	6.25	6.82	7.34	7.81	8.25	8.66	9.42	10.1	10.8	11.5	12.2	13.9	15.7	19.2	22.7
76	0.0200	0.000314	3.53	4.97	6.05	6.95	7.72	8.43	9.07	9.65	10.2	10.8	11.7	12.5	13.3	14.2	15.0	17.2	19.4	23.7	28.0
75	0.0210	0.000346	3.89	5.48	6.67	7.65	8.51	9.29	10.0	10.7	11.2	11.8	12.9	13.7	14.7	15.6	16.6	19.0	21.3	26.1	30.9
74	0.0225	0.000398	4.47	7.08	7.67	8.80	9.78	10.7	11.5	12.4	13.0	13.6	14.8	15.8	16.9	18.0	19.1	21.8	24.5	30.0	35.5
73	0.0240	0.000452	5.08	7.16	8.71	10.0	11.2	12.2	13.1	13.9	14.7	15.4	16.8	17.9	19.1	20.4	21.6	24.7	27.6	34.1	40.3
72	0.0250	0.000491	5.52	7.78	9.46	10.9	12.1	13.2	14.2	15.1	16.0	16.8	18.3	19.4	20.8	22.1	23.5	26.9	30.3	37.0	43.8
71	0.0260	0.000531	5.97	8.41	10.3	11.8	13.1	14.3	15.4	16.4	17.3	18.1	19.7	21.0	22.5	23.9	25.4	29.1	32.7	40.0	47.3
70	0.0280	0.000616	6.92	9.75	11.9	13.7	15.2	16.6	17.8	19.0	20.0	21.0	22.9	24.4	26.1	27.8	29.5	33.8	38.0	46.4	54.9
69	0.0292	0.000670	7.53	10.6	13.0	14.9	16.5	18.0	19.4	20.0	21.8	22.9	24.9	26.5	28.4	30.2	32.1	36.7	41.3	50.5	59.7
68	0.0310	0.000735	8.48	12.0	14.6	16.7	18.6	20.3	21.9	23.2	24.5	25.8	28.0	29.9	32.0	34.0	36.1	41.3	46.5	56.9	67.3
1/32"	0.0313	0.000765	8.59	12.2	14.8	17.0	18.8	20.6	22.1	23.5	24.9	26.1	28.4	30.3	32.4	34.5	36.6	41.9	47.1	57.7	68.2
67	0.0320	0.000804	9.03	12.8	15.5	17.8	19.8	21.6	23.3	24.7	26.1	27.4	29.9	31.8	34.0	36.2	38.5	44.0	49.5	60.6	71.7
66	0.0330	0.000855	9.60	13.6	16.5	18.9	21.1	23.0	24.7	26.3	27.6	29.2	31.8	33.8	36.2	38.5	40.9	46.8	52.7	64.4	76.2
65	0.0350	0.000962	10.8	15.3	18.6	21.3	23.7	25.9	27.8	29.6	31.3	32.8	35.7	38.1	40.7	43.4	46.0	52.6	59.2	72.5	85.7
64	0.0360	0.001018	11.5	16.2	19.7	22.6	25.1	27.4	29.4	31.3	33.1	34.7	37.8	40.3	42.4	45.9	48.7	55.7	62.7	76.7	90.7
63	0.0370	0.001075	12.1	17.1	20.8	23.8	26.5	28.9	31.1	33.1	34.9	36.7	39.9	42.5	45.5	48.4	51.4	58.8	66.2	81.0	95.8
62	0.0380	0.001134	12.8	18.0	21.9	25.1	27.9	30.5	32.8	34.9	36.8	38.7	42.1	44.8	48.0	51.1	54.2	62.0	69.8	85.4	101
61	0.0390	0.001195	13.5	19.0	23.1	26.5	29.4	32.1	34.6	36.8	38.8	40.8	44.4	47.3	50.6	53.8	57.1	65.4	73.6	90.0	107
60	0.0400	0.001257	14.2	19.9	24.3	27.8	30.9	33.8	36.4	38.7	40.8	42.9	46.7	49.7	53.2	56.6	60.1	68.7	77.4	94.7	112
59	0.0410	0.001320	14.9	20.9	25.5	29.2	32.5	35.5	38.2	40.6	42.9	45.0	49.0	52.2	55.8	59.5	63.1	72.2	81.3	99.5	118
58	0.0420	0.001385	15.6	22.0	26.7	30.7	34.1	37.2	40.0	42.6	45.0	47.2	51.4	54.8	58.6	62.4	66.2	75.7	85.3	105	124
57	0.0430	0.001452	16.3	23.0	28.0	32.1	35.7	39.0	42.0	44.7	47.2	49.5	53.9	57.4	61.4	65.4	69.4	79.4	89.4	110	130
56	0.0465	0.001698	19.1	26.9	32.8	37.6	41.8	45.6	49.1	52.2	55.1	57.9	63.0	67.1	71.8	76.5	81.2	92.8	105	128	152
3/64"	0.0469	0.00173	19.5	27.4	33.4	38.3	42.6	46.5	50.0	53.2	56.2	59.0	64.2	68.4	73.2	77.9	82.7	94.6	107	131	155
55	0.0520	0.00212	23.8	33.6	40.9	46.9	52.1	57.0	61.3	65.2	68.8	72.3	78.7	83.8	89.6	95.5	102	116	131	160	189
54	0.0550	0.00238	26.8	37.7	45.9	52.7	58.5	63.9	68.8	73.2	77.3	81.1	88.3	94.1	101	108	114	132	147	180	212
53	0.0595	0.00278	31.1	44.0	53.6	61.5	68.4	74.7	80.3	85.4	90.3	94.7	104	110	118	126	133	152	172	210	248
1/16"	0.0625	0.00307	34.5	48.6	59.2	67.9	75.5	82.5	88.8	94.4	99.7	105	114	122	130	139	147	168	189	232	274
52	0.0635	0.00317	35.6	50.2	61.1	70.1	78.0	85.1	91.6	97.4	103	108	118	126	134	143	152	174	196	239	283
51	0.0670	0.00353	39.7	55.9	68.0	78.1	86.8	94.8	102	109	115	121	131	140	150	159	169	193	218	266	315
50	0.0700	0.00385	43.3	61.0	74.2	85.2	94.7	104	112	119	125	132	143	153	163	174	184	211	237	290	343
49	0.0730	0.00419	47.1	66.4	80.8	92.7	103	113	121	129	136	143	156	166	178	189	201	229	258	316	374
48	0.0760	0.00454	51.0	71.9	87.5	101	112	122	132	140	148	155	169	180	192	205	217	249	280	342	405
5/64"	0.0781	0.00479	53.8	75.9	92.3	106	118	129	134	148	156	164	178	190	203	216	229	262	295	361	427
47	0.0785	0.00484	54.4	76.6	93.3	107	119	130	140	149	158	165	180	192	205	218	232	265	298	365	432
46	0.0810	0.00515	57.9	81.6	99.2	114	127	139	149	159	168	176	191	204	218	232	246	282	317	388	459
45	0.0820	0.00528	59.3	83.6	102	117	130	141	153	163	172	180	196	209	224	238	253	289	325	398	471
44	0.0860	0.00582	65.3	92.1	113	129	143	157	169	179	189	199	216	230	246	262	278	319	359	439	519
43	0.0890	0.00622	69.9	98.5	120	138	153	167	180	192	202	212	231	246	263	280	298	340	383	469	555
42	0.0935	0.00687	77.2	109	133	152	169	185	199	212	223	234	255	272	291	310	329	376	423	518	612
3/32"	0.0937	0.00690	77.5	110	133	153	170	186	200	212	224	235	256	273	292	311	350	378	425	520	615
41	0.0960	0.00724	81.3	115	140	161	178	195	210	223	235	247	269	287	306	326	346	396	446	546	645
40	0.0980	0.00754	84.7	120	146	167	186	203	218	232	245	257	280	298	319	340	361	413	464	568	672
39	0.0995	0.00778	87.4	124	150	172	192	209	225	239	253	265	289	308	329	351	372	426	479	585	693
38	0.1015	0.00809	90.9	128	156	179	199	218	234	249	263	276	300	320	342	365	387	443	498	610	721
37	0.1040	0.00849	95.4	135	164	188	209	228	246	261	276	290	315	336	359	383	406	464	523	640	757

- continued -

Capacities of Spuds and Orifices (continued)																					
DRILL DESIGNATION	DIAMETER, INCHES	AREA, SQUARE INCHES	CAPACITIES IN CFH OF 0.6 GRAVITY HIGH PRESSURE NATURAL GAS AND AN ORIFICE COEFFICIENT OF 1.0																		
			Upstream Pressure, Psi Gauge																		
			1	2	3	4	5	6	7	8	9	10	12	14	16	18	20	25	30	40	50
36	0.1065	0.00891	100	141	172	197	219	240	258	274	290	304	331	352	377	402	426	487	549	671	794
7/64"	0.1094	0.00940	106	149	182	208	231	253	272	289	305	321	349	372	398	424	449	514	579	708	838
35	0.1100	0.00950	107	151	183	210	234	255	275	292	309	324	353	376	402	428	454	520	585	716	847
34	0.1110	0.00968	109	154	187	214	238	260	280	298	315	330	359	383	410	436	463	530	596	729	863
33	0.1130	0.01003	113	159	194	222	247	270	290	309	326	342	372	396	424	452	480	549	618	756	894
32	0.1160	0.01057	119	168	204	234	260	284	306	325	343	360	392	418	447	476	505	578	651	796	942
31	0.1200	0.01131	127	179	218	250	278	304	327	348	367	386	420	447	478	510	541	619	696	852	1010
1/8"	0.1250	0.01227	138	195	237	272	302	330	355	377	399	418	456	485	519	553	587	671	756	924	1100
30	0.1285	0.01296	146	206	250	287	319	348	375	399	421	442	481	512	548	584	620	709	798	976	1160
29	0.1360	0.01433	164	230	280	322	357	390	420	447	472	495	539	575	615	655	695	795	893	1100	1300
28	0.1405	0.01549	174	246	299	343	381	416	448	476	503	528	575	612	655	698	740	847	954	1170	1380
9/64"	0.1406	0.01553	175	246	300	344	382	417	449	478	504	529	576	614	657	700	742	849	956	1170	1390
27	0.1440	0.01629	183	258	314	361	401	438	471	501	529	555	605	644	689	734	779	891	1010	1230	1460
26	0.1470	0.01697	191	269	327	376	417	456	491	522	551	579	630	671	718	764	811	928	1050	1280	1520
25	0.1495	0.01755	197	278	339	388	432	472	507	540	570	598	651	694	742	790	839	960	1080	1330	1570
24	0.1520	0.01815	204	288	350	402	446	490	525	558	589	619	674	718	768	818	867	992	1120	1370	1620
23	0.1540	0.01863	210	295	359	412	458	501	539	573	605	635	691	737	788	839	890	1020	1150	1410	1660
5/32"	0.1562	0.01917	216	304	370	424	472	515	554	589	623	653	711	758	811	863	916	1050	1180	1450	1710
22	0.1570	0.01936	218	307	373	428	476	520	560	595	629	660	713	765	819	872	925	1060	1200	1460	1730
21	0.1590	0.01986	223	315	383	440	488	534	574	611	645	677	737	785	840	894	949	1090	1230	1500	1770
20	0.1610	0.02036	229	323	393	451	501	547	589	626	661	694	756	805	861	917	973	1120	1260	1540	1820
19	0.1660	0.02164	243	343	417	479	532	581	625	665	703	738	803	855	915	975	1040	1190	1340	1630	1930
18	0.1695	0.02256	254	358	435	499	555	606	652	694	733	769	837	892	954	1020	1080	1240	1390	1700	2010
11/64"	0.1719	0.02320	261	368	447	513	571	623	671	713	753	790	861	917	981	1050	1110	1270	1430	1750	2070
17	0.1730	0.02351	264	373	453	520	578	632	680	723	763	801	872	929	994	1060	1130	1290	1450	1770	2100
16	0.1770	0.02461	277	390	475	545	605	661	711	756	799	839	913	973	1040	1110	1180	1350	1520	1860	2200
15	0.1800	0.02345	286	403	491	563	626	684	736	782	826	868	944	1010	1080	1150	1220	1400	1570	1920	2270
14	0.1820	0.02602	293	412	502	576	640	699	752	800	845	887	965	1030	1100	1180	1250	1430	1610	1960	2320
13	0.1850	0.02688	302	426	518	595	661	722	777	826	873	916	997	1060	1140	1210	1290	1470	1660	2030	2400
3/16"	0.1875	0.02761	310	437	532	611	679	742	798	849	896	941	1030	1100	1170	1250	1320	1510	1700	2080	2460
12	0.1890	0.02806	315	445	541	621	690	754	811	862	911	956	1050	1110	1190	1270	1340	1540	1730	2120	2500
11	0.1910	0.02865	322	454	552	634	704	770	828	881	930	976	1070	1140	1220	1290	1370	1570	1770	2160	2560
10	0.1930	0.02940	331	466	567	650	723	790	850	904	955	1010	1090	1170	1250	1330	1410	1610	1810	2220	2620
9	0.1960	0.03017	339	478	582	667	742	810	872	927	980	1030	1120	1200	1270	1360	1450	1650	1860	2280	2690
8	0.1990	0.03110	350	493	600	688	765	835	899	956	1010	1060	1160	1230	1320	1400	1490	1700	1920	2350	2770
7	0.2010	0.03173	357	503	612	702	780	852	917	975	1030	1090	1180	1260	1350	1430	1520	1740	1960	2390	2830
13/64"	0.2031	0.03241	364	513	625	717	797	870	937	996	1060	1110	1210	1290	1370	1460	1550	1780	2000	2450	2890
6	0.2040	0.03269	367	518	630	723	804	878	945	1010	1070	1120	1220	1300	1390	1480	1570	1790	2020	2470	2920
5	0.2055	0.03317	373	525	639	734	816	891	959	1020	1080	1130	1230	1320	1410	1500	1590	1820	2050	2500	2960
4	0.2090	0.03431	386	543	661	739	844	921	991	1060	1120	1170	1280	1360	1450	1550	1640	1880	2120	2590	2770
3	0.2130	0.03563	400	564	687	788	876	959	1030	1100	1160	1220	1330	1410	1510	1610	1710	1950	2200	2690	2830
7/32"	0.2187	0.03758	422	595	724	831	924	1010	1090	1160	1220	1280	1400	1490	1590	1700	1800	2060	2320	2830	2890
2	0.2210	0.03836	431	608	739	849	943	1030	1110	1180	1250	1310	1430	1520	1630	1730	1840	2100	2370	2890	2920
1	0.2280	0.04083	459	647	787	903	1010	1100	1180	1260	1330	1400	1520	1620	1730	1840	1950	2240	2520	3080	2960
A	0.2340	0.04301	483	681	829	951	1060	1160	1250	1330	1400	1470	1600	1700	1820	1940	2060	2360	2650	3240	3060
15/64"	0.2344	0.04314	485	683	831	954	1060	1160	1250	1330	1400	1470	1600	1710	1830	1950	2070	2360	2660	3250	3180
B	0.2380	0.04449	500	705	857	984	1100	1200	1290	1370	1450	1520	1650	1760	1880	2010	2130	2440	2740	3350	3350
C	0.2420	0.04600	517	725	879	1010	1130	1240	1330	1420	1500	1570	1710	1820	1950	2080	2200	2520	2840	3470	3420
D	0.2460	0.04733	534	733	891	1020	1140	1250	1340	1430	1510	1580	1720	1830	1960	2090	2220	2540	2860	3500	3460
E=1/4"	0.2500	0.04909	552	777	946	1090	1210	1320	1420	1510	1600	1680	1830	1940	2080	2210	2350	2690	3030	3700	4380
F	0.2570	0.05187	583	821	1000	1150	1280	1400	1500	1600	1690	1770	1930	2050	2200	2340	2480	2840	3200	3910	4620
G	0.2610	0.05350	601	847	1040	1190	1320	1440	1550	1650	1740	1830	1990	2120	2270	2410	2560	2930	3300	4030	4770
17/64"	0.2656	0.05542	623	878	1070	1230	1370	1490	1610	1710	1810	1890	2060	2190	2350	2500	2650	3030	3410	4180	4940
H	0.2660	0.05557	624	880	1070	1230	1370	1500	1610	1710	1810	1900	2070	2200	2350	2510	2660	3040	3420	4190	4950

- continued -



Capacities of Spuds and Orifices (continued)

DRILL DESIGNATION	DIAMETER, INCHES	AREA, SQUARE INCHES	CAPACITIES IN CFH OF 0.6 GRAVITY HIGH PRESSURE NATURAL GAS AND AN ORIFICE COEFFICIENT OF 1.0																		
			Upstream Pressure, Psi Gauge																		
			1	2	3	4	5	6	7	8	9	10	12	14	16	18	20	25	30	40	50
I	0.2720	0.005811	653	916	1120	1290	1430	1560	1680	1790	1890	1980	2160	2300	2460	2620	2780	3180	3580	4380	5180
J	0.2770	0.006026	677	957	1170	1340	1490	1620	1750	1860	1960	2060	2240	2390	2550	2720	2880	3300	3710	4540	5370
K	0.2810	0.006102	697	983	1200	1380	1530	1670	1800	1910	2020	2120	2300	2450	2630	2800	2970	3390	3820	4680	5530
L	0.2812	0.006113	698	984	1200	1380	1530	1670	1800	1910	2020	2120	2310	2460	2630	2800	2970	3400	3830	4680	5540
M	0.2900	0.006605	742	1050	1280	1460	1630	1780	1910	2030	2150	2250	2450	2610	2800	2980	3160	3610	4070	4980	5890
19/64"	0.2930	0.006835	768	1090	1320	1520	1680	1840	1980	2100	2220	2330	2540	2710	2890	3080	3270	3740	4210	5150	6090
N	0.2969	0.006922	778	1100	1340	1530	1710	1860	2000	2130	2250	2360	2570	2740	2930	3120	3310	3790	4260	5220	6170
5/16"	0.3020	0.007163	805	1140	1380	1590	1760	1930	2070	2210	2330	2440	2660	2830	3030	3230	3430	3920	4410	5400	6390
O	0.3125	0.007670	862	1220	1480	1700	1890	2060	2220	2360	2490	2620	2850	3030	3250	3460	3670	4200	4720	5780	6840
21/64"	0.3160	0.007843	881	1250	1520	1740	1930	2110	2270	2410	2550	2660	2910	3100	3320	3540	3750	4290	4830	5910	6990
P	0.3230	0.008194	920	1300	1580	1820	2020	2200	2370	2520	2660	2800	3040	3240	3470	3690	3920	4480	5050	6180	7300
Q	0.3281	0.008456	950	1340	1630	1870	2080	2270	2450	2600	2750	2890	3140	3350	3580	3810	4040	4630	5210	6370	7540
R	0.3320	0.008657	972	1370	1670	1920	2130	2330	2500	2660	2810	2950	3210	3420	3660	3900	4140	4740	5330	6520	7720
11/32"	0.3390	0.009026	1020	1430	1740	2000	2220	2430	2607	2780	2930	3080	3350	3570	3820	4070	4320	4940	5560	6800	8040
S	0.3437	0.009281	1050	1470	1790	2060	2290	2500	2690	2860	3020	3170	3450	3670	3930	4180	4440	5080	5720	6990	8270
T	0.3480	0.09511	1070	1510	1840	2110	2340	2530	2750	2930	3090	3240	3530	3760	4020	4290	4550	5200	5860	7170	8480
23/64"	0.3580	0.1006	1130	1600	1940	2230	2480	2710	2910	3100	3270	3430	3740	4000	4260	4530	4810	5500	6200	7580	8970
U	0.3594	0.1014	1140	1610	1960	2250	2500	2730	2930	3120	3300	3460	3770	4010	4290	4570	4850	5550	6240	7640	9040
3/8"	0.3680	0.1065	1200	1690	2050	2360	2620	2860	3080	3270	3460	3630	3950	4210	4500	4790	5050	5820	6550	8020	9480
V	0.3750	0.1105	1240	1750	2130	2450	2720	2970	3200	3400	3590	3770	4100	4370	4670	4980	5280	6040	6800	8330	9850
W	0.3770	0.1116	1260	1770	2150	2470	2750	3000	3230	3430	3630	3810	4140	4410	4720	5030	5340	6100	6870	8410	9950
25/64"	0.3860	0.1170	1320	1860	2260	2590	2900	3200	3380	3600	3800	3990	4340	4630	5000	5270	5590	6350	7200	8820	10,400
X	0.3960	0.1198	1350	1900	2310	2650	2950	3220	3460	3680	3890	4090	4450	4740	5100	5400	5730	6550	7380	9030	10,700
Y	0.3970	0.1238	1390	1960	2390	2740	3050	3330	3580	3810	4020	4220	4600	4900	5240	5580	5920	6770	7620	9330	11,100
Z	0.4040	0.1282	1440	2030	2470	2840	3150	3450	3710	3940	4160	4370	4760	5070	5420	5780	6130	7010	7890	9660	11,500
13/32"	0.4062	0.1295	1460	2060	2500	2870	3190	3480	3750	3990	4210	4420	4810	5120	5480	5840	6200	7090	7980	9760	11,600
27/64"	0.4130	0.1340	1510	2130	2590	2970	3300	3600	3870	4130	4350	4570	4970	5300	5670	6040	6400	7330	8250	10100	12,000
7/16"	0.4219	0.1398	1570	2220	2700	3100	3440	3760	4040	4300	4540	4770	5190	5530	5910	6300	6680	7650	8610	10600	12,500
29/64"	0.4375	0.1503	1690	2380	2900	3330	3700	4040	4350	4620	4880	5120	5580	5940	6360	6770	7200	8220	9250	11400	13,400
15/32"	0.4531	0.1613	1820	2560	3110	3570	4000	4230	4660	5000	5140	5500	5990	6380	6820	7270	7700	8820	9930	12200	14,400
31/64"	0.4687	0.1726	1940	2740	3330	3820	4250	4640	4990	5310	5610	5880	6410	6820	7300	7770	8300	9440	10,700	13000	15,400
1/2"	0.4844	0.1843	2070	3280	3550	4080	4530	4950	5330	5670	5990	6280	6840	7280	7790	8300	8800	10,100	11,400	13900	16,400
33/64"	0.5000	0.1964	2210	3110	3790	4350	4830	5280	5680	6340	6380	6690	7290	7760	8310	8850	9400	10,000	11,500	12,900	14,800
17/32"	0.5156	0.2088	2350	3310	4030	4620	5140	5610	6040	6420	6780	7120	7750	8250	8490	9400	10,000	11,500	12,900	15,800	18,600
35/64"	0.5313	0.2217	2490	3510	4280	4910	5450	5960	6410	6820	7200	7560	8230	8760	9370	9980	10,600	12,200	13,700	16700	19,800
9/16"	0.5469	0.2349	2640	3720	4530	5200	5780	6310	6790	7220	7630	8010	8720	9290	9930	10,600	11,300	12,900	14,500	17700	21,000
37/64"	0.5625	0.2485	2790	3940	4770	5500	6110	6680	7180	7640	8070	8470	9220	9820	10,500	11,200	11,900	13,600	15,300	18800	22,000
19/32"	0.5781	0.2625	2950	4160	5060	5810	6450	7050	7590	8070	8520	8950	9740	10,370	11,100	11,900	12,600	14,400	16,200	19800	23,400
39/64"	0.5938	0.2769	3110	4390	5340	6130	6810	7440	8000	8510	8990	9440	10,300	10,940	11,700	12,500	13,300	15,200	17,100	20900	24,700
5/8"	0.6094	0.2917	3280	4620	5620	6450	7170	7830	8430	8970	9470	9940	10,900	11,600	12,400	13,200	14,000	16,000	18,000	22000	26,000
41/64"	0.6250	0.3068	3450	4860	5910	6790	7540	8240	8870	9430	9960	10,500	11,400	12,200	13,000	13,900	14,700	16,800	18,900	23100	27,400
21/32"	0.6406	0.3223	3620	5110	6210	7130	7920	8660	9310	9910	10,500	11,000	12,000	12,800	13,700	14,600	15,400	17,700	19,900	24300	28,800
43/64"	0.6562	0.3382	3800	5360	6520	7480	8320	9080	9770	10,400	11,000	11,600	12,600	13,400	14,300	15,300	16,200	18,500	20,900	25500	30,200
11/16"	0.6719	0.3545	3980	5620	6830	7840	8720	9520	10,300	10,900	11,500	12,100	13,200	14,000	15,000	16,000	17,000	19,400	21,900	26700	31,600
23/32"	0.6875	0.3712	4170	5880	7150	8210	9130	9970	10,600	11,500	12,100	12,700	13,800	14,700	15,700	16,800	17,800	20,300	22,900	28000	33,100
3/4"	0.7188	0.4057	4560	6430	7820	8970	9970	10,900	11,800	12,500	13,200	13,900	15,100	16,100	17,200	18,300	19,400	22,200	25,000	30600	36,200
25/32"	0.7500	0.4418	4960	7000	8510	9770	10,900	11,900	12,800	13,600	14,400	15,100	16,400	17,500	18,700	19,900	21,200	24,200	27,200	33300	39,400
13/16"	0.7812	0.4794	5390	7590	9240	10,600	11,800	12,900	13,900	14,800	15,600	16,400	17,800	19,000	20,300	21,600	22,900	26,200	29,500	36100	42,800
27/32"	0.8125	0.5185	5830	8210	9990	11,500	12,800	14,000	15,000	16,000	16,900	17,700	19,300	20,500	22,000	23,400	24,800	28,400	32,000	39100	46,200
7/8"	0.8438	0.5591	6280	8850	10,800	12,400	13,800	15,000	16,200	17,200	18,200	19,100	20,800	22,100	23,700	25,200	26,700	30,600	34,400	42100	49,800
29/32"	0.8750	0.6013	6760	9520	11,600																

Viscosities of Typical Fluids vs. Temperature

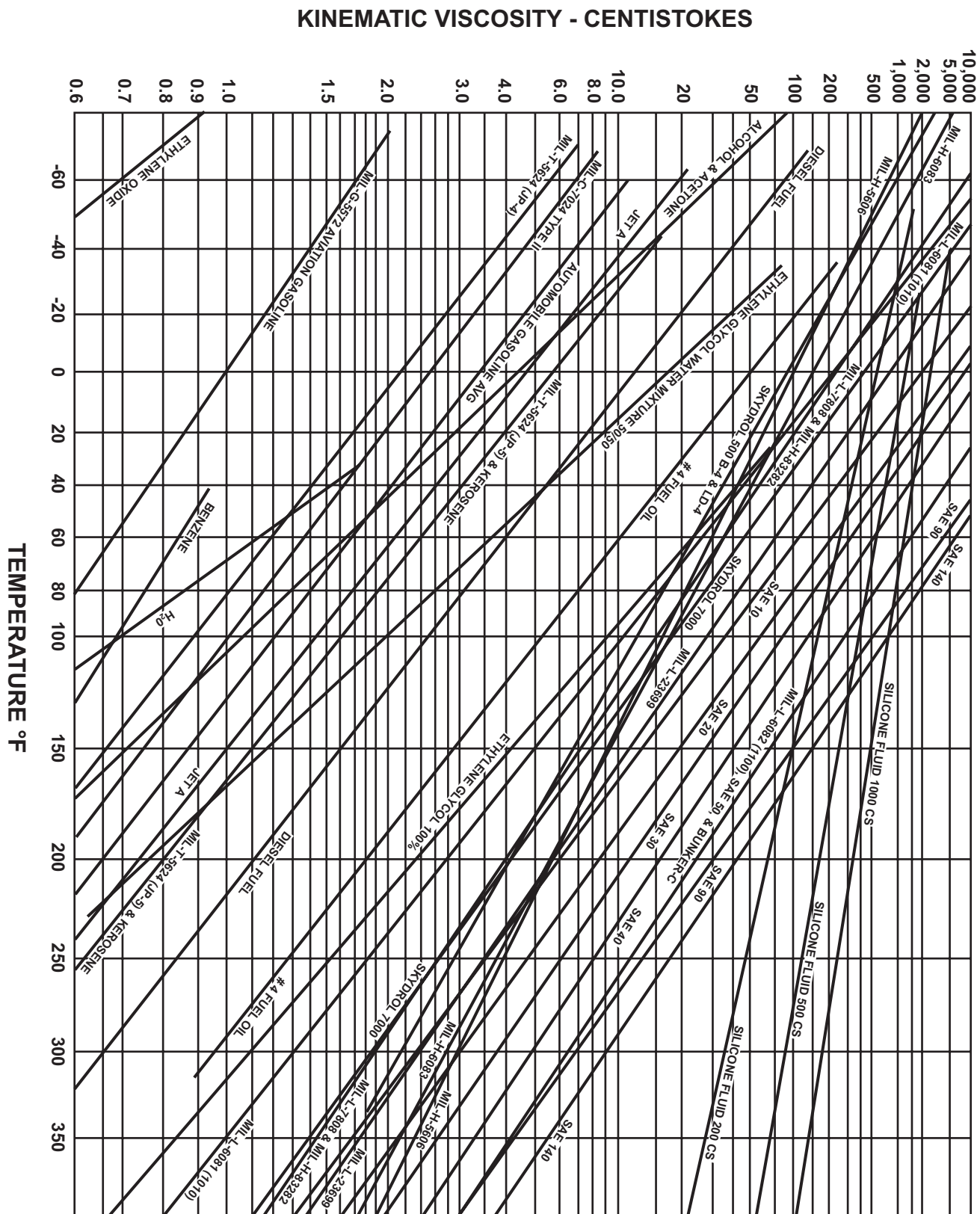

Specific Gravity of Typical Fluids vs. Temperature

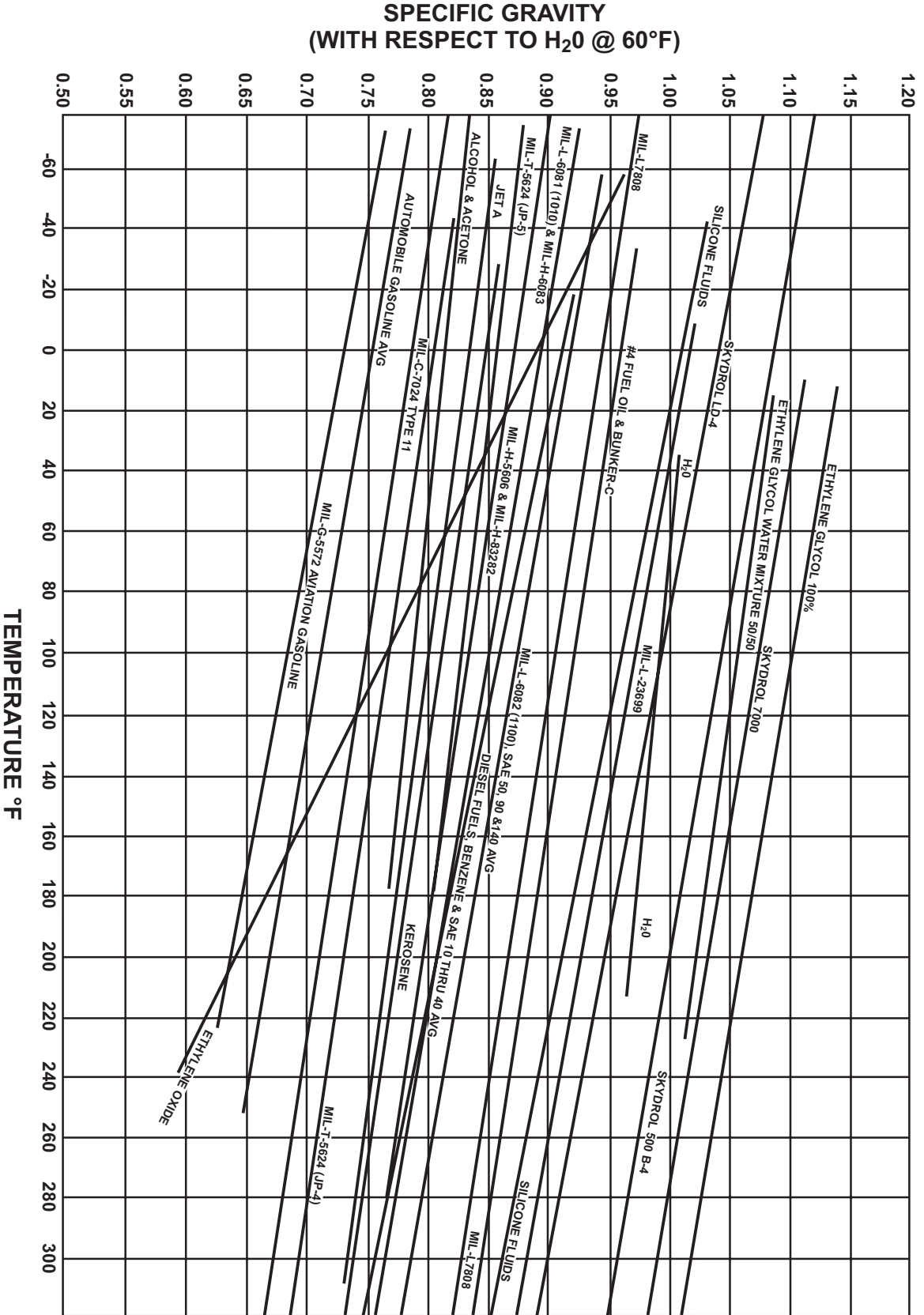

Effect of Inlet Swage On Critical Flow Cg Requirements

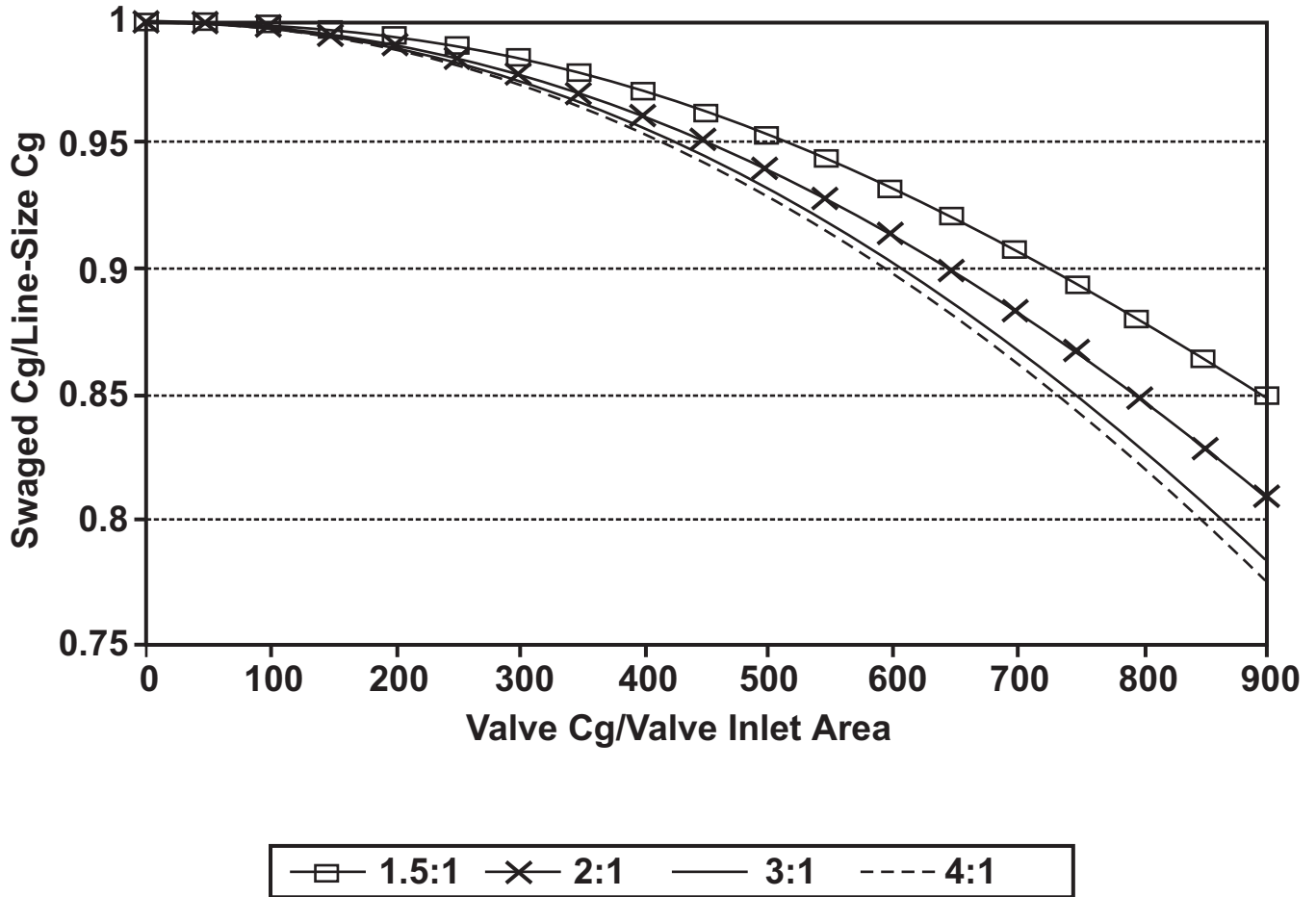

ANSI Face-To-Face Dimensions for Flanged Regulators						
BODY SIZE, INCHES	ANSI CLASS AND END CONNECTIONS (INCH DIMENSIONS ARE IN ACCORDANCE WITH ISA S4.01.1-1997)					
	125 FF (Cast Iron) 150 RF (Steel), Inches (mm)	250 RF (Cast Iron) 300 RF (Steel), Inches (mm)	150 RJT (Steel), Inches (mm)	300 RJT (Steel), Inches (mm)	600 RF (Steel), Inches (mm)	600 RJT (Steel), Inches (mm)
1	7.25 (184)	7.75 (197)	7.75 (197)	8.25 (210)	8.25 (210)	8.25 (210)
1-1/4	7.88 (200)	8.38 (213)	8.38 (213)	8.88 (225)	9.00 (229)	9.00 (229)
1-1/2	8.75 (223)	9.25 (235)	9.25 (235)	9.75 (248)	9.88 (251)	9.88 (251)
2	10.00 (254)	10.50 (267)	10.50 (267)	11.12 (283)	11.25 (286)	11.38 (289)
2-1/2	10.88 (276)	11.50 (292)	11.38 (289)	12.12 (308)	12.25 (311)	12.38 (314)
3	11.75 (299)	12.50 (318)	12.25 (311)	13.12 (333)	13.25 (337)	13.38 (340)
4	13.88 (352)	14.50 (368)	14.38 (365)	15.12 (384)	15.50 (394)	15.62 (397)
6	17.75 (451)	18.62 (473)	18.25 (464)	19.25 (489)	20.00 (508)	20.12 (511)
8	21.38 (543)	22.38 (568)	21.88 (556)	23.00 (584)	24.00 (610)	24.12 (613)
10	26.50 (673)	27.88 (708)	27.00 (686)	28.50 (724)	29.62 (752)	29.75 (756)
12	29.00 (737)	30.50 (775)	29.50 (749)	31.12 (790)	32.25 (819)	32.38 (822)
16	40.00 (1016)	41.62 (1057)	40.50 (1029)	42.25 (1073)	43.62 (1108)	43.75 (1111)

FF—Flat Face, RF—Raised Face, and RJT—Ring Type Joint

Seat Leakage Classifications (In Accordance with ANSI B16.104-1976)				
LEAKAGE CLASS DESIGNATION	MAXIMUM LEAKAGE ALLOWABLE	TEST MEDIUM	TEST PRESSURE	TESTING PROCEDURES REQUIRED FOR ESTABLISHING RATING
I	---	---	---	No test required provided user and supplier so agree.
II	0.5% of rated capacity	Air or water at 50 to 125°F (10 to 52°C)	45 to 60 psi (3.1 to 4.1 bar) or maximum operating differential, whichever is lower	Pressure applied to valve inlet, with outlet open to atmosphere or connected to a low head loss measuring device, full normal closing thrust provided by actuator.
III	0.1% of rated capacity	As above	As above	As above
IV	0.01% of rated capacity	As above	As above	As above
V	0.0005 ml per minute of water per inch (mm) of port diameter per psi (bar) differential	Water at 50 to 125°F (10 to 52°C)	Maximum service pressure drop across valve plug, not to exceed ANSI body rating. (100 psi (6.9 bar) pressure drop minimum)	Pressure applied to valve inlet after filling entire body cavity and connected piping with water and stroking valve plug closed. Use net specified maximum actuator thrust, but no more, even if available during test. Allow time for leakage flow to stabilize.
VI	Not to exceed amounts shown in following table based on port (orifice) diameter	Air or Nitrogen at 50 to 125°F (10 to 52°C)	50 psig (3.4 bar) or maximum rated differential pressure across valve plug, whichever is lower.	Actuator should be adjusted to operating conditions specified with full normal closing thrust applied to valve plug seat. Allow time for leakage flow to stabilize and use suitable measuring device.

Class VI Seat Leakage Allowable			
NOMINAL PORT DIAMETER		LEAK RATE	
Inches	Millimeters	ml per Minute	Bubbles per Minute ⁽¹⁾
1	25	0.15	1
1-1/2	38	0.30	2
2	51	0.45	3
2-1/2	64	0.60	4
3	76	0.90	6
4	102	1.70	11
6	152	4.00	27
8	203	6.75	45

1. Bubbles per minute as tabulated are an easily measured suggested alternative based on a suitable calibrated measuring device such as a 1/4-inch O.D. x 0.032-inch wall tube submerged in water to a depth of 1/8 inch to 1/4 inch. The tube end shall be cut square and smooth with no chamfers or burs and the tube axis shall be perpendicular to the surface of the water. Other apparatus may be constructed and the number of bubbles per minute may vary from those shown, as long as they correctly indicate the flow in ml per minute.

Standard Pressure-Temperature Ratings for ANSI Class 150 Valve Bodies⁽¹⁾

SERVICE TEMPERATURE °F (°C)	WORKING PRESSURE, PSIG (BAR)										
	LCB	LCC	WCB	WCC	WC6	WC9	CF8 or 304	CF8M or 316	CF3M or 316L	CG8M or 317	CF8C or 347
-20 to 100 (-29 to 38) 200 (93)	265 (18.3) 250 (17.2)	290 (20.0) 260 (17.9)	285 (19.7) 260 (17.9)	290 (20.0) 260 (17.9)	290 (20.0) 260 (17.9)	290 (20.0) 260 (17.9)	275 (19.0) 230 (13.8)	275 (19.0) 235 (16.2)	275 (19.0) 235 (16.2)	275 (19.0) 235 (16.2)	275 (19.0) 255 (17.6)
300 (149) 400 (204)	230 (15.9) 200 (13.8)	230 (15.9) 200 (13.8)	230 (15.9) 200 (13.8)	230 (15.9) 200 (13.8)	230 (15.9) 200 (13.8)	230 (15.9) 200 (13.8)	205 (14.1) 190 (13.1)	215 (14.8) 195 (13.4)	215 (14.8) 195 (13.4)	215 (14.8) 195 (13.4)	230 (15.9) 200 (13.8)
500 (260) 600 (316)	170 (11.7) 140 (9.65)	170 (11.7) 140 (9.65)	170 (11.7) 140 (9.65)	170 (11.7) 140 (9.65)	170 (11.7) 140 (9.65)	170 (11.7) 140 (9.65)	170 (11.7) 140 (9.65)	170 (11.7) 140 (9.65)	170 (11.7) 140 (9.65)	170 (11.7) 140 (9.65)	170 (11.7) 140 (9.65)
650 (343) 700 (371)	125 (8.62) ---	125 (8.62) ---	125 (8.62) 110 (7.58)	125 (8.62) 110 (7.58)	125 (8.62) 110 (7.58)	125 (8.62) 110 (7.58)	125 (8.62) 110 (7.58)	125 (8.62) 110 (7.58)	125 (8.62) 110 (7.58)	125 (8.62) 110 (7.58)	125 (8.62) 110 (7.58)

1. Table information is extracted from the Valve - Flanged, Threaded, and Welding End, ASME Standard B16.34-1996. These tables must be used in accordance with the ASME standard.

Standard Pressure-Temperature Ratings for ANSI Class 300 Valve Bodies⁽¹⁾

SERVICE TEMPERATURE °F (°C)	WORKING PRESSURE, PSIG (BAR)										
	LCB	LCC	WCB	WCC	WC6	WC9	CF8 or 304	CF8M or 316	CF3M or 316L	CG8M or 317	CF8C or 347
-20 to 100 (-29 to 38) 200 (93)	695 (47.9) 655 (45.2)	750 (51.7) 750 (51.7)	740 (51.0) 675 (46.5)	750 (51.7) 750 (51.7)	750 (51.7) 750 (51.7)	750 (51.7) 750 (51.7)	720 (49.6) 600 (41.4)	720 (49.6) 620 (42.7)	720 (49.6) 620 (42.7)	720 (49.6) 620 (42.7)	720 (49.6) 660 (45.5)
300 (149) 400 (204)	640 (44.1) 620 (42.7)	730 (50.3) 705 (48.6)	655 (45.2) 635 (43.8)	730 (50.3) 705 (48.6)	720 (49.6) 695 (47.9)	730 (50.3) 705 (48.6)	530 (36.5) 470 (32.4)	560 (38.6) 515 (35.5)	560 (38.6) 515 (35.5)	560 (38.6) 515 (35.5)	615 (42.4) 575 (39.6)
500 (260) 600 (316)	585 (40.3) 535 (36.9)	665 (45.9) 605 (41.7)	600 (41.4) 550 (37.9)	665 (45.9) 605 (41.7)	665 (45.9) 605 (41.7)	665 (45.9) 605 (41.7)	435 (30.0) 415 (28.6)	480 (33.1) 450 (31.1)	480 (33.1) 450 (31.1)	480 (33.1) 450 (31.1)	540 (37.2) 515 (35.5)
650 (343) 700 (371)	525 (36.2) ---	590 (40.7) ---	535 (36.9) 535 (36.9)	590 (40.7) 570 (39.3)	590 (40.7) 570 (39.3)	590 (40.7) 570 (39.3)	410 (28.3) 405 (27.9)	445 (30.7) 430 (29.6)	445 (30.7) 430 (29.6)	445 (30.7) 430 (29.6)	505 (34.8) 495 (34.1)

1. Table information is extracted from the Valve - Flanged, Threaded, and Welding End, ASME Standard B16.34-1996. These tables must be used in accordance with the ASME standard.

Standard Pressure-Temperature Ratings for ANSI Class 600 Valve Bodies⁽¹⁾

SERVICE TEMPERATURE °F (°C)	WORKING PRESSURE, PSIG (BAR)										
	LCB	LCC	WCB	WCC	WC6	WC9	CF8 or 304	CF8M or 316	CF3M or 316L	CG8M or 317	CF8C or 347
-20 to 100 (-29 to 38) 200 (93)	1390 1315	1500 1500	1480 1350	1500 1500	1500 1500	1500 1500	1440 1200	1440 1240	1440 1240	1440 1240	1440 1320
300 (149) 400 (204)	1275 1235	1455 1410	1315 1270	1455 1410	1445 1385	1455 1410	1080 995	1120 1025	1120 1025	1120 1025	1230 1145
500 (260) 600 (316)	1165 1065	1330 1210	1200 1095	1330 1210	1330 1210	1330 1210	930 875	955 905	955 905	955 905	1080 1025
650 (343) 700 (371)	1045 ---	1175 ---	1075 1065	1175 1135	1175 1135	1175 1135	860 850	890 870	890 870	890 870	1010 990

1. Table information is extracted from the Valve - Flanged, Threaded, and Welding End, ASME Standard B16.34-1996. These tables must be used in accordance with the ASME standard.

Special Pressure-Temperature Ratings for ANSI Class 150 NPT or BWE Valve Bodies⁽¹⁾

SERVICE TEMPERATURE °F (°C)	WORKING PRESSURE, PSIG (BAR)										
	LCB	LCC	WCB	WCC	WC6	WC9	CF8 or 304	CF8M or 316	CF3M or 316L	CG8M or 317	CF8C or 347
-20 to 100 (-29 to 38) 200 (93)	265 (18.3) 265 (18.3)	290 (20.0) 290 (20.0)	290 (20.0) 290 (20.0)	290 (20.0) 290 (20.0)	290 (20.0) 290 (20.0)	290 (20.0) 290 (20.0)	290 (20.0) 255 (17.6)	290 (20.0) 265 (18.3)	290 (20.0) 265 (18.3)	290 (20.0) 265 (18.3)	290 (20.0) 275 (19.0)
300 (149) 400 (204)	265 (18.3) 265 (18.3)	290 (20.0) 290 (20.0)	290 (20.0) 290 (20.0)	290 (20.0) 290 (20.0)	290 (20.0) 290 (20.0)	285 (19.7) 280 (19.3)	230 (15.9) 210 (14.5)	240 (16.5) 220 (15.2)	240 (16.5) 220 (15.2)	240 (16.5) 220 (15.2)	250 (17.2) 235 (16.2)
500 (260) 600 (316)	265 (18.3) 265 (18.3)	290 (20.0) 290 (20.0)	290 (20.0) 275 (19.0)	290 (20.0) 290 (20.0)	290 (20.0) 290 (20.0)	275 (19.0) 275 (19.0)	200 (13.8) 185 (12.8)	205 (14.1) 195 (13.4)	205 (14.1) 195 (13.4)	205 (14.1) 195 (13.4)	230 (15.9) 220 (15.2)
650 (343) 700 (371)	260 (17.9) ---	290 (20.0) ---	270 (18.6) 265 (18.3)	290 (20.0) 275 (19.0)	290 (20.0) 280 (19.3)	290 (20.0) 275 (19.0)	275 (19.0) 180 (12.4)	185 (12.8) 185 (12.8)	190 (13.1) 185 (12.8)	190 (13.1) 185 (12.8)	215 (14.8) 210 (14.5)

1. Table information is extracted from the Valve - Flanged, Threaded, and Welding End, ASME Standard B16.34-1996. These tables must be used in accordance with the ASME standard.

Special Pressure-Temperature Ratings for ANSI Class 300 NPT or BWE Valve Bodies⁽¹⁾

SERVICE TEMPERATURE °F (°C)	WORKING PRESSURE, PSIG (BAR)										
	LCB	LCC	WCB	WCC	WC6	WC9	CF8 or 304	CF8M or 316	CF3M or 316L	CG8M or 317	CF8C or 347
-20 to 100 (-29 to 38) 200 (93)	695 (47,9) 695 (47,9)	750 (51,7) 750 (51,7)	750 (51,7) 750 (51,7)	750 (51,7) 750 (51,7)	750 (51,7) 750 (51,7)	750 (51,7) 750 (51,7)	750 (51,7) 670 (46,2)	750 (51,7) 690 (47,6)	750 (51,7) 690 (47,6)	750 (51,7) 690 (47,6)	750 (51,7) 715 (49,3)
300 (149) 400 (204)	695 (47,9) 695 (47,9)	750 (51,7) 750 (51,7)	750 (51,7) 750 (51,7)	750 (51,7) 750 (51,7)	750 (51,7) 750 (51,7)	740 (51,0) 725 (50,0)	600 (41,4) 555 (38,3)	625 (43,1) 570 (39,3)	625 (43,1) 570 (39,3)	625 (43,1) 570 (39,3)	655 (45,2) 615 (42,4)
500 (260) 600 (316)	695 (47,9) 695 (47,9)	750 (51,7) 750 (51,7)	750 (51,7) 715 (49,3)	750 (51,7) 750 (51,7)	750 (51,7) 750 (51,7)	720 (49,6) 720 (49,6)	520 (35,9) 490 (33,8)	530 (36,5) 505 (34,8)	530 (36,5) 505 (34,8)	530 (36,5) 505 (34,8)	595 (41,0) 575 (39,6)
650 (343) 700 (371)	680 (46,9) ---	750 (51,7) ---	700 (48,3) 695 (47,9)	750 (51,7) 710 (49,0)	750 (51,7) 735 (50,7)	715 (49,3) 710 (49,0)	480 (33,1) 470 (32,4)	495 (34,1) 485 (33,4)	495 (34,1) 485 (33,4)	495 (34,1) 485 (33,4)	565 (39,0) 550 (37,9)

1. Table information is extracted from the Valve - Flanged, Threaded, and Welding End, ASME Standard B16.34-1996. These tables must be used in accordance with the ASME standard.

Special Pressure-Temperature Ratings for ANSI Class 600 NPT or BWE Valve Bodies⁽¹⁾

SERVICE TEMPERATURE °F (°C)	WORKING PRESSURE, PSIG (BAR)										
	LCB	LCC	WCB	WCC	WC6	WC9	CF8 or 304	CF8M or 316	CF3M or 316L	CG8M or 317	CF8C or 347
-20 to 100 (-29 to 38) 200 (93)	1390 1390	1500 1500	1500 1500	1500 1500	1500 1500	1500 1500	1500 1355	1500 1380	1500 1380	1500 1380	1500 1430
300 (149) 400 (204)	1390 1390	1500 1500	1500 1500	1500 1500	1500 1500	1485 1450	1200 1105	1250 1140	1250 1140	1250 1140	1310 1235
500 (260) 600 (316)	1390 1390	1500 1500	1500 1425	1500 1500	1500 1500	1440 1440	1035 975	1065 1005	1065 1005	1065 1005	1190 1145
650 (343) 700 (371)	1360 ---	1500 ---	1400 1390	1500 1425	1500 1465	1430 1425	960 945	985 970	985 970	985 970	1125 1105

1. Table information is extracted from the Valve - Flanged, Threaded, and Welding End, ASME Standard B16.34-1996. These tables must be used in accordance with the ASME standard.

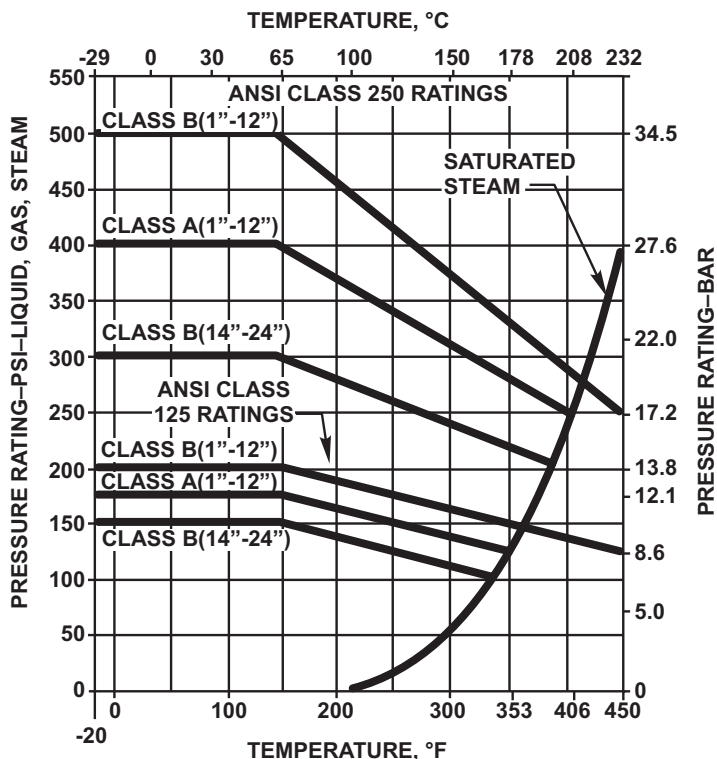

Diameter of Bolt Circles						
NOMINAL PIPE SIZE, INCHES	ANSI CLASS 125 (CAST IRON) OR CLASS 150 (STEEL) ⁽¹⁾	ANSI CLASS 250 (CAST IRON) OR CLASS 300 (STEEL) ⁽²⁾	ANSI CLASS 600	ANSI CLASS 900	ANSI CLASS 1500	ANSI CLASS 2500
1	3.12	3.50	3.50	4.00	4.00	4.25
1-1/4	3.50	3.88	3.88	4.38	4.38	5.12
1-1/2	3.88	4.50	4.50	4.88	4.88	5.75
2	4.75	5.00	5.00	6.50	6.50	6.75
2-1/2	5.50	5.88	5.88	7.50	7.50	7.75
3	6.00	6.62	6.62	7.50	8.00	9.00
4	7.50	7.88	8.50	9.25	9.50	10.75
5	8.50	9.25	10.50	11.00	11.50	12.75
6	39.50	10.62	11.50	12.50	12.50	14.50
8	11.75	13.00	13.75	15.50	15.50	17.25
10	14.25	15.25	17.00	18.50	19.00	21.75
12	17.00	17.75	19.25	21.00	22.50	24.38
14	18.75	20.25	20.75	22.00	25.00	---
16	21.25	22.50	23.75	24.25	27.75	---
18	22.75	24.75	25.75	27.00	30.50	---
20	25.00	27.00	28.50	29.50	32.75	---
24	29.50	32.00	33.00	35.50	39.00	---
30	36.00	39.25	---	---	---	---
36	42.75	46.00	---	---	---	---
42	49.50	52.75	---	---	---	---
48	56.00	60.75	---	---	---	---

1. Sizes 1 inch through 12 inch also apply to ANSI Class 150 bronze flanges.
2. Sizes 1 inch through 8 inch also apply to ANSI Class 300 bronze flanges.

Pressure/Temperature Ratings for ASTM A126 Cast Iron Valves

Wear and Galling Resistance Chart of Material Combinations														
MATERIAL	304 Stainless Steel	316 Stainless Steel	Bronze	Inconel	Monel	Hastelloy C	Nickel	Alloy 20	Type 416 Hard	Type 440 Hard	17-4PH	ENC ⁽¹⁾	Cr Plate	Al Bronze
304 Stainless Steel	P	P	F	P	P	F	P	P	F	F	F	F	F	F
316 Stainless Steel	P	P	F	P	P	F	P	P	F	F	F	F	F	F
Bronze	F	F	S	S	S	S	S	S	F	F	F	F	F	F
Inconel	P	P	S	P	P	F	F	F	F	F	F	F	F	S
Monel	P	P	S	P	P	F	F	F	F	F	F	F	F	S
Hastelloy C	F	F	S	F	F	F	P	P	F	F	F	F	S	S
Nickel	P	P	S	P	F	F	P	P	F	F	F	F	F	S
Alloy 20	P	P	S	F	F	F	P	P	F	F	F	F	F	S
Type 416 Hard	F	F	F	F	F	F	F	F	F	F	F	S	S	S
Type 440 Hard	F	F	F	F	F	F	F	F	S	F	S	S	S	S
17-4PH	F	F	F	F	F	F	F	F	F	S	P	S	S	S
ENC ⁽¹⁾	F	F	F	F	F	F	F	F	S	S	S	P	S	S
Cr Plate	F	F	F	F	F	S	S	S	S	S	S	S	P	S
Al Bronze	F	F	F	S	S	S	S	S	S	S	S	S	S	P

1. Electroless Nickel Coating
 S - Satisfactory
 F - Fair
 P - Poor

Equivalent Lengths of Pipe Fittings and Valves																				
TYPE OF FITTING OR VALVE	LENGTHS IN FEET OF STANDARD PIPE																			
	Nominal Pipe Size in Inches																			
	1/2	3/4	1	1-1/4	1-1/2	2	2-1/2	3	4	6	8	10	12	14 O.D.	16 O.D.	18 O.D.	20 O.D.	24 O.D.	30 O.D.	
Standard tee with entry or discharge through side	3.4	4.5	5.5	7.5	9.0	12	14	17	22	33	43	55	65	78	85	105	115	135	170	
Standard elbow or run ⁽¹⁾ of tee reduced 1/2 ⁽²⁾	1.7	2.2	2.7	3.7	4.3	5.5	6.5	8	12	16	20	26	31	36	42	47	52	64	80	
Medium sweep elbow or run ⁽¹⁾ of tee reduced 1/4 ⁽²⁾	1.3	1.8	2.3	3.0	3.7	4.6	5.4	6.8	9.0	14	18	22	26	30	35	40	43	55	67	
Long sweep elbow or run ⁽¹⁾ of standard tee or butterfly valve	1	1.3	1.7	2.3	2.7	3.5	4.2	5.3	7	11	14	17	20	23	26	31	34	41	52	
45° elbow	0.8	1.0	1.2	1.6	2.0	2.5	3.0	3.7	5.0	7.5	10	12	15	17	20	22	24	30	37	
Close return bend	3.7	5.1	6.2	8.5	10	13	15	19	24	37	49	62	75	86	100	110	125	150	185	
Globe valve, wide-open	0.6	22	27	40	43	45	65	82	120	170	240	290	340	400	440	500	550	680	850	
Angle valve, wide-open	8.2	11	14	18	21	28	33	42	56	85	112	145	165	190	220	250	280	340	420	
Swing check valve, wide-open	4.0	5.2	6.6	9.0	11	14	16	19	26	39	52	66	78	92	106	120	130	145	160	
Gate valve, wide-open, or slight bushing reduction	0.4	0.5	0.6	.08	0.9	1.2	1.3	1.7	2.3	3.5	4.5	5.7	6.7	8.0	9.0	11	12	14	17	

1. A fluid is said to flow through the run of a tee when the flow is straight through the tee with no change of direction.
 2. A tee is said to be reduced 1/4 if the internal area of the smaller connecting pipe is 25% less than the internal area of the larger connecting pipe.



SHARP ENTRANCE
LOSS = 0.9 VP

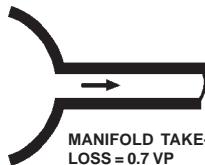

MANIFOLD TAKE-OFF
LOSS = 0.7 VP

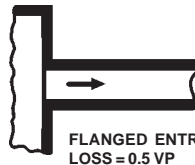

FLANGED ENTRANCE
LOSS = 0.5 VP

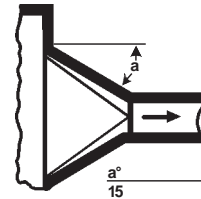

LOSS
 a° VP
 15 16
 30 17
 45 25
 60 35

Pipe Data: Carbon and Alloy Steel—Stainless Steel											
Nominal Pipe Size (Inches)	Outside Diameter (Inches)	Identification			Wall Thickness (t) (Inches)	Inside Diameter (d) (Inches)	Area of Metal (Square Inches)	Transverse Internal Area		Weight Pipe (Pounds per Foot)	Weight Water (Pounds per Foot of Pipe)
		Steel		Stainless Steel Schedule No.				(a) (Square Inches)	(A) (Square Feet)		
		Iron Pipe Size	Schedule No.								
1/8	0.405	10S	0.049	0.307	0.0548	0.0740	0.00051	0.19	0.032
		STD	40	40S	0.068	0.269	0.0720	0.0568	0.00040	0.24	0.025
		XS	80	80S	0.095	0.215	0.0925	0.0365	0.00025	0.31	0.016
1/4	0.540	10S	0.065	0.410	0.0970	0.1320	0.00091	0.33	0.057
		STD	40	40S	0.088	0.364	0.1250	0.1041	0.00072	0.42	0.045
		XS	80	80S	0.119	0.302	0.1574	0.0716	0.00050	0.54	0.031
3/8	0.675	10S	0.065	0.545	0.1246	0.2333	0.00162	0.42	0.101
		STD	40	40S	0.091	0.493	0.1670	0.1910	0.00133	0.57	0.083
		XS	80	80S	0.126	0.423	0.2173	0.1405	0.00098	0.74	0.061
1/2	0.840	5S	0.065	0.710	0.1583	0.3959	0.00275	0.54	0.172
		10S	0.083	0.674	0.1974	0.3568	0.00248	0.67	0.155
		STD	40	40S	0.109	0.622	0.2503	0.3040	0.00211	0.85	0.132
		XS	80	80S	0.147	0.546	0.3200	0.2340	0.00163	1.09	0.102
		...	160	...	0.187	0.466	0.3836	0.1706	0.00118	1.31	0.074
3/4	1.050	5S	0.065	0.920	0.2011	0.6648	0.00462	0.69	0.288
		10S	0.083	0.884	0.2521	0.6138	0.00426	0.86	0.266
		STD	40	40S	0.113	0.824	0.3326	0.5330	0.00371	1.13	0.231
		XS	80	80S	0.154	0.742	0.4335	0.4330	0.00300	1.47	0.188
		...	160	...	0.219	0.612	0.5698	0.2961	0.00206	1.94	0.128
1	1.315	5S	0.065	1.185	0.2553	1.1029	0.00766	0.87	0.478
		10S	0.109	1.097	0.4130	0.9452	0.00656	1.40	0.409
		STD	40	40S	0.133	1.049	0.4939	0.8640	0.00600	1.68	0.375
		XS	80	80S	0.179	0.957	0.6388	0.7190	0.00499	2.17	0.312
		...	160	...	0.250	0.815	0.8365	0.5217	0.00362	2.84	0.230
1-1/4	1.660	5S	0.065	1.530	0.3257	1.839	0.01277	1.11	0.797
		10S	0.109	1.442	0.4717	1.633	0.01134	1.81	0.708
		STD	40	40S	0.140	1.380	0.6685	1.495	0.01040	2.27	0.649
		XS	80	80S	0.191	1.278	0.8815	1.283	0.00891	3.00	0.555
		...	160	...	0.250	1.160	1.1070	1.057	0.00734	3.76	0.458
1-1/2	1.900	5S	0.065	1.770	0.3747	2.461	0.01709	1.28	1.066
		10S	0.109	1.682	0.6133	2.222	0.01543	2.09	0.963
		STD	40	40S	0.145	1.610	0.7995	2.036	0.01414	2.72	0.882
		XS	80	80S	0.200	1.500	1.068	1.767	0.01225	3.63	0.765
		...	160	...	0.281	1.338	1.429	1.406	0.00976	4.86	0.608
2	2.375	5S	0.065	2.245	0.4717	3.958	0.02749	1.61	1.72
		10S	0.109	2.157	0.7760	3.654	0.02538	2.64	1.58
		STD	40	40S	0.154	2.067	1.075	3.355	0.02330	3.65	1.45
		XS	80	80S	0.218	1.939	1.477	2.953	0.02050	5.02	1.28
		...	160	...	0.344	1.687	2.190	2.241	0.01556	7.46	0.97
...	0.436	1.503	2.656	1.774	0.01232	9.03	0.77		

Identification, wall thickness and weights are extracted from ANSI B36.10 and B39.19. The notations STD, XS, and XXS indicate Standard, Extra Strong, and Double Extra Strong pipe respectively. Transverse internal area values listed in "square feet" also represent volume in cubic feet per foot of pipe length.

- continued -

Pipe Data: Carbon and Alloy Steel—Stainless Steel (continued)

Nominal Pipe Size (Inches)	Outside Diameter (Inches)	Identification			Wall Thickness (t) (Inches)	Inside Diameter (d) (Inches)	Area of Metal (Square Inches)	Transverse Internal Area		Weight Pipe (Pounds per Foot)	Weight Water (Pounds per Foot of Pipe)
		Steel		Stainless Steel Schedule No.				(a) (Square Inches)	(A) (Square Feet)		
		Iron Pipe Size	Schedule No.								
2-1/2	2.875	5S	0.083	2.709	0.7280	5.764	0.04002	2.48	2.50
		10S	0.120	2.635	1.039	5.453	0.03787	3.53	2.36
		STD	40	40S	0.203	2.469	1.704	4.788	0.03322	5.79	2.07
		XS	80	80S	0.279	2.323	2.254	4.238	0.02942	7.66	1.87
		...	160	...	0.375	2.125	2.945	3.546	0.02463	10.01	1.54
		XXS	0.552	1.771	4.028	2.464	0.01710	13.69	1.07
3	3.500	5S	0.083	3.334	0.8910	8.730	0.06063	3.03	3.78
		10S	0.120	3.260	1.274	8.347	0.05796	4.33	3.62
		STD	40	40S	0.216	3.068	2.228	7.393	0.05130	7.58	3.20
		XS	80	80S	0.300	2.900	3.016	6.605	0.04587	10.25	2.86
		...	160	...	0.438	2.624	4.205	5.408	0.03755	14.32	2.35
		XXS	0.600	2.300	5.466	4.155	0.02885	18.58	1.80
3-1/2	4.000	5S	0.083	3.834	1.021	11.545	0.08017	3.48	5.00
		10S	0.120	3.760	1.463	11.104	0.07711	4.97	4.81
		STD	40	40S	0.226	3.548	2.680	9.886	0.06870	9.11	4.29
		XS	80	80S	0.318	3.364	3.678	8.888	0.06170	12.50	3.84
4	4.500	5S	0.083	4.334	1.152	14.75	0.10245	3.92	6.39
		10S	0.120	4.260	1.651	14.25	0.09898	5.61	6.18
		STD	40	40S	0.237	4.026	3.174	12.73	0.08840	10.79	5.50
		XS	80	80S	0.337	3.826	4.407	11.50	0.07986	14.98	4.98
		...	120	...	0.438	3.624	5.595	10.31	0.0716	19.00	4.47
		...	160	...	0.531	3.438	6.621	9.28	0.0645	22.51	4.02
		XXS	0.674	3.152	8.101	7.80	0.0542	27.54	3.38
5	5.563	5S	0.109	5.345	1.868	22.44	0.1558	6.36	9.72
		10S	0.134	5.295	2.285	22.02	0.1529	7.77	9.54
		STD	40	40	0.258	5.047	4.300	20.01	0.1390	14.62	8.67
		XS	80	80S	0.375	4.813	6.112	18.19	0.1263	20.78	7.88
		...	120	...	0.500	4.563	7.953	16.35	0.1136	27.04	7.09
		...	160	...	0.625	4.313	9.696	14.61	0.1015	32.96	6.33
6	6.625	5S	0.109	6.407	2.231	32.24	0.2239	7.60	13.97
		10S	0.134	6.357	2.733	31.74	0.2204	9.29	13.75
		STD	40	40S	0.280	6.065	5.581	28.89	0.2006	18.97	12.51
		XS	80	80S	0.432	5.761	8.405	26.07	0.1810	28.57	11.29
		...	120	...	0.562	5.501	10.70	23.77	0.1650	36.39	10.30
		...	160	...	0.719	5.018	13.32	21.15	0.1469	45.35	9.16
9	8.625	5S	0.109	8.407	2.916	55.51	0.3855	9.93	24.06
		10S	0.148	8.329	3.941	54.48	0.3784	13.40	23.61
		...	20	...	0.250	8.125	6.57	51.85	0.3601	22.36	22.47
		...	30	...	0.277	8.071	7.26	51.16	0.3553	24.70	22.17
		STD	40	40S	0.322	7.981	8.40	50.03	0.3474	28.55	21.70
		...	60	...	0.406	7.813	10.48	47.94	0.3329	35.64	20.77
		XS	80	80S	0.500	7.625	12.76	45.66	0.3171	43.39	19.78
		...	100	...	0.594	7.437	14.96	43.46	0.3018	50.95	18.83
		...	120	...	0.719	7.187	17.84	40.59	0.2819	60.71	17.59
		...	140	...	0.812	7.001	19.93	38.50	0.2673	67.76	16.68
10	10.750	5S	0.134	10.482	4.36	86.29	0.5992	15.19	37.39
		10S	0.165	10.420	5.49	85.28	0.5922	18.65	36.95
		...	20	...	0.250	10.250	8.24	82.52	0.5731	28.04	35.76
		...	30	...	0.307	10.136	10.07	80.69	0.5603	34.24	34.96
		STD	40	40S	0.365	10.020	11.90	78.86	0.5475	40.48	34.20
		XS	60	80S	0.500	9.750	16.10	74.66	0.5185	54.74	32.35
		...	80	...	0.594	9.562	18.92	71.84	0.4989	64.43	31.13
		...	100	...	0.719	9.312	22.63	68.13	0.4732	77.03	29.53
		...	120	...	0.844	9.062	26.24	64.53	0.4481	89.29	27.96
		XXS	140	...	1.000	8.750	30.63	60.13	0.4176	104.13	26.06
...	160	...	1.125	8.500	34.02	56.75	0.3941	115.64	24.59		

Identification, wall thickness and weights are extracted from ANSI B36.10 and B39.19. The notations STD, XS, and XXS indicate Standard, Extra Strong, and Double Extra Strong pipe respectively. Transverse internal area values listed in "square feet" also represent volume in cubic feet per foot of pipe length.

American Pipe Flange Dimensions						
ANSI CLASS FLANGE DIAMETER -- INCHES, PER ANSI B16.1, B16.5, AND B16.24						
Nominal Pipe Size	125 (Cast Iron) or 150 (Steel) ⁽¹⁾	250 (Cast Iron) or 300 (Steel) ⁽²⁾	600	900	1500	2500
1	4.25	4.88	4.88	5.88	5.88	6.25
1-1/4	4.62	5.25	5.25	6.25	6.25	7.25
1-1/2	5.00	6.12	6.12	7.00	7.00	8.00
2	6.00	6.50	6.50	8.50	8.50	9.25
2-1/2	7.00	7.50	7.50	9.62	9.62	10.50
3	7.50	8.25	8.25	9.50	10.50	12.00
4	9.00	10.00	10.75	11.50	12.25	14.00
5	10.00	11.00	13.00	13.75	14.75	16.50
6	11.00	12.50	14.00	15.00	15.50	19.00
8	13.50	15.00	16.50	18.50	19.00	21.75
10	16.00	17.50	20.00	21.50	23.00	26.50
12	19.00	20.50	22.00	24.00	26.50	30.00
14	21.00	23.00	23.75	25.25	29.50	---
16	23.50	25.50	27.00	27.75	32.50	---
18	25.00	28.00	29.25	31.00	36.00	---
20	27.50	30.50	32.00	33.75	38.75	---
24	32.00	36.00	37.00	41.00	46.00	---
30	38.75	43.00	---	---	---	---
36	46.00	50.00	---	---	---	---
42	53.00	57.00	---	---	---	---
48	59.50	65.00	---	---	---	---

1. Sizes 1-inch through 12-inch also apply to ANSI Class 150 bronze flanges.
2. Sizes 1-inch through 8-inch also apply to ANSI Class 300 bronze flanges.

American Pipe Flange Dimensions												
ANSI CLASS, NUMBER OF STUD BOLTS AND HOLE DIAMETER IN INCHES, PER ANSI B16.1, B16.5, AND B16.24												
Normal Pipe Size	125 (Cast Iron) or 150 (Steel) ⁽¹⁾		250 (Cast Iron) or 300 (Steel) ⁽²⁾		600		900		1500		2500	
	No.	Dia.	No.	Dia.	No.	Dia.	No.	Dia.	No.	Dia.	No.	Dia.
1	4	0.50	4	0.62	4	0.62	4	0.88	4	0.88	4	0.88
1-1/4	4	0.50	4	0.62	4	0.62	4	0.88	4	0.88	4	1.00
1-1/2	4	0.50	4	0.75	4	0.75	4	1.00	4	1.00	4	1.12
2	4	0.62	8	0.62	8	0.62	8	0.88	8	0.88	8	1.00
2-1/2	4	0.62	8	0.75	8	0.75	8	1.00	8	1.00	8	1.12
3	4	0.62	8	0.75	8	0.75	8	0.88	8	1.12	8	1.25
4	8	0.62	8	0.75	8	0.75	8	1.12	8	1.12	8	1.50
5	8	0.75	8	0.75	8	1.00	8	1.25	8	1.50	8	1.75
6	8	0.75	12	0.75	12	1.00	12	1.12	12	1.38	8	2.00
8	8	0.75	12	0.88	12	1.12	12	1.38	12	1.62	12	2.00
10	12	0.88	16	1.00	16	1.25	16	1.38	12	1.88	12	2.50
12	12	0.88	16	1.12	20	1.25	20	1.38	16	2.00	12	2.75
14	12	1.00	20	1.12	20	1.38	20	1.50	16	2.25	---	---
16	16	1.00	20	1.25	20	1.50	20	1.62	16	2.50	---	---
18	16	1.12	24	1.25	20	1.62	20	1.88	16	2.75	---	---
20	20	1.12	24	1.25	24	1.62	20	2.00	16	3.00	---	---
24	20	1.25	24	1.50	24	1.88	20	2.50	16	3.50	---	---
30	28	1.25	28	1.75	---	---	---	---	---	---	---	---
36	32	1.50	32	2.00	---	---	---	---	---	---	---	---
42	36	1.50	36	2.00	---	---	---	---	---	---	---	---
48	44	1.50	40	2.00	---	---	---	---	---	---	---	---

1. Sizes 1-inch through 12-inch also apply to ANSI Class 150 bronze flanges.
2. Sizes 1-inch through 8-inch also apply to ANSI Class 300 bronze flanges.

DIN Cast Steel Flange Standard—Nenndruck 16 (Nominal Pressure 16 Bar)							
NOMINAL BORE, mm	PIPE THICKNESS, mm	FLANGE, mm			BOLTING, mm		
		Outside Diameter	Thickness	Bolt Circle Diameter	Number of Bolts	Thread	Bolt Hold Diameter
10	6	90	16	60	4	M12	14
15	6	95	16	65	4	M12	14
20	6.5	105	18	75	4	M12	14
25	7	115	18	85	4	M12	14
32	7	140	18	100	4	M16	18
40	7.5	150	18	110	4	M16	18
50	8	165	20	125	4	M16	18
65	8	185	18	145	4	M16	18
80	8.5	200	20	160	8	M16	18
100	9.5	220	20	180	8	M16	18
125	10	250	22	210	8	M16	18
150	11	285	22	240	8	M20	23
175	12	315	24	270	8	M20	23
200	12	340	24	295	12	M20	23
250	14	405	26	355	12	M24	27
300	15	460	28	410	12	M24	27
350	16	520	30	470	16	M24	27
400	18	580	32	525	16	M27	30
500	21	715	36	650	20	M30	33
600	23	840	40	770	20	M33	36
700	24	910	42	840	24	M33	36
800	26	1025	42	950	24	M36	39
900	27	1125	44	1050	28	M36	39
1000	29	1255	46	1170	28	M39	42
1200	32	1485	52	1390	32	M45	48
1400	34	1685	58	1590	36	M45	48
1600	36	1930	64	1820	40	M52	56
1800	39	2130	68	2020	44	M52	56
2000	41	2345	70	2230	48	M56	62
2200	43	2555	74	2440	52	M56	62

DIN Cast Steel Flange Standard—Nenndruck 25 (Nominal Pressure 25 Bar)							
NOMINAL BORE, mm	PIPE THICKNESS, mm	FLANGE, mm			BOLTING, mm		
		Outside Diameter	Thickness	Bolt Circle Diameter	Number of Bolts	Thread	Bolt Hold Diameter
10	6	90	16	60	4	M12	14
15	6	95	16	65	4	M12	14
20	6.5	105	18	75	4	M12	14
25	7	115	18	85	4	M12	14
32	7	140	18	100	4	M16	18
40	7.5	150	18	110	4	M16	18
50	8	165	20	125	4	M16	18
65	8.5	185	22	145	8	M16	18
80	9	200	24	160	8	M16	18
100	10	235	24	190	8	M20	23
125	11	270	26	220	8	M24	27
150	12	300	28	250	8	M24	27
175	12	330	28	280	12	M24	27
200	12	360	30	310	12	M24	27
250	14	425	32	370	12	M27	30
300	15	485	34	430	16	M27	30
350	16	555	38	490	16	M30	33
400	18	620	40	550	16	M33	36
500	21	730	44	660	20	M33	36
600	23	845	46	770	20	M36	39
700	24	960	50	875	24	M39	42
800	26	1085	54	990	24	M45	48
900	27	1185	58	1090	28	M45	48
1000	29	1320	62	1210	28	M52	56
1200	32	1530	70	1420	32	M52	56
1400	34	1755	76	1640	36	M56	62
1600	37	1975	84	1860	40	M56	62
1800	40	2195	90	2070	44	M64	70
2000	43	2425	96	2300	48	M64	70

DIN Cast Steel Flange Standard–Nenndruck 40 (Nominal Pressure 40 Bar)							
NOMINAL BORE, mm	PIPE THICKNESS, mm	FLANGE, mm			BOLTING, mm		
		Outside Diameter	Thickness	Bolt Circle Diameter	Number of Bolts	Thread	Bolt Hold Diameter
10	6	90	16	60	4	M12	14
15	6	95	16	65	4	M12	14
20	6,5	105	18	75	4	M12	14
25	7	115	18	85	4	M12	14
32	7	140	18	100	4	M16	18
40	7,5	150	18	110	4	M16	18
50	8	165	20	125	4	M16	18
65	8,5	185	22	145	8	M16	18
80	9	200	24	160	8	M16	18
100	10	235	24	190	8	M20	23
125	11	270	26	220	8	M24	27
150	12	300	28	250	8	M24	27
175	13	350	32	295	12	M27	30
200	14	375	34	320	12	M27	30
250	16	450	38	385	12	M30	33
300	17	515	42	450	16	M30	33
350	19	580	46	510	16	M33	36
400	21	660	50	585	16	M36	39
450	21	685	50	610	20	M36	39
500	21	755	52	670	20	M39	42
600	24	890	60	795	20	M45	48
700	27	995	64	900	24	M45	48
800	30	1140	72	1030	24	M52	56
900	33	1250	76	1140	28	M52	56
1000	36	1360	80	1250	28	M52	56
1200	42	1575	88	1460	32	M56	62
1400	47	1795	98	1680	36	M56	62
1600	54	2025	108	1900	40	M64	70

DIN Cast Steel Flange Standard–Nenndruck 64 (Nominal Pressure 64 Bar)							
NOMINAL BORE, mm	PIPE THICKNESS, mm	FLANGE, mm			BOLTING, mm		
		Outside Diameter	Thickness	Bolt Circle Diameter	Number of Bolts	Thread	Bolt Hold Diameter
10	10	100	20	70	4	M12	14
15	10	105	20	75	4	M12	14
25	10	140	24	100	4	M16	18
32	12	155	24	110	4	M20	23
40	10	170	28	125	4	M20	22
50	10	180	26	135	4	M20	22
65	10	205	26	160	8	M20	22
80	11	215	28	170	8	M20	22
100	12	250	30	200	8	M24	26
125	13	295	34	240	8	M27	30
150	14	345	36	280	8	M30	33
175	15	375	40	310	12	M30	33
200	16	415	42	345	12	M33	36
250	19	470	46	400	12	M33	36
300	21	530	52	460	16	M33	36
350	23	600	56	525	16	M36	39
400	26	670	60	585	16	M39	42
500	31	800	68	705	20	M45	48
600	35	930	76	820	20	M52	56
700	40	1045	84	935	24	M52	56
800	45	1165	92	1050	24	M56	62
900	50	1285	98	1170	28	M56	62
1000	55	1415	108	1290	28	M64	70
1200	64	1665	126	1530	32	M72X6	78

DIN Cast Steel Flange Standard–Nenndruck 100 (Nominal Pressure 100 Bar)							
NOMINAL BORE, mm	PIPE THICKNESS, mm	FLANGE, mm			BOLTING, mm		
		Outside Diameter	Thickness	Bolt Circle Diameter	Number of Bolts	Thread	Bolt Hold Diameter
10	10	100	20	70	4	M12	14
15	10	105	20	75	4	M12	14
25	10	140	24	100	4	M16	18
32	12	155	24	110	4	M20	23
40	10	170	28	125	4	M20	22
50	10	195	30	145	4	M24	26
65	11	220	34	170	8	M24	26
80	12	230	36	180	8	M24	26
100	14	265	40	210	8	M27	30
125	16	315	40	250	8	M30	33
150	18	355	44	290	12	M30	33
175	20	385	48	320	12	M30	33
200	21	430	52	360	12	M33	36
250	25	505	60	430	12	M36	39
300	29	585	68	500	16	M39	42
350	32	655	74	560	16	M45	48
400	36	715	78	620	16	M45	48
500	44	870	94	760	20	M52	56
600	51	990	104	875	20	M56	62
700	59	1145	120	1020	24	M64	70

DIN Standards–DIN Cast Steel Valve Ratings ⁽¹⁾						
NOMINAL PRESSURE, (BAR)	PERMISSIBLE WORKING PRESSURE (BAR)					
	-10–120°C	200°C	250°C	300°C	350°C	400°C
16	16	14	13	11	10	8
25	25	22	20	17	16	13
40	40	35	32	28	24	21
64	64	50	45	40	36	32
100	100	80	70	60	56	50
160	160	130	112	96	90	80
250	250	200	175	150	140	125
320	320	250	225	192	180	160
400	400	320	280	240	225	200

1. Hydrostatic test pressure: 1.5 times rating at 20°C.

Drill Sizes for Pipe Taps			
NOMINAL PIPE SIZE (INCHES)	TAP DRILL SIZE (INCHES)	NOMINAL PIPE SIZE (INCHES)	TAP DRILL SIZE (INCHES)
1/8	11/32	1-1/2	1-23/32
1/4	7/16	2	2-3/16
3/8	19/32	2-1/2	2-9/16
1/2	23/32	3	3-3/16
3/4	15/16	4	4-3/16
1	1-5/32	5	5-5/16
1-1/4	1-1/2	6	6-5/16

Standard Twist Drill Sizes								
DESIGNATION	DIAMETER (IN.)	AREA (SQ. IN.)	DESIGNATION	DIAMETER (IN.)	AREA (SQ. IN.)	DESIGNATION	DIAMETER (IN.)	AREA (SQ. IN.)
1/2	0.5000	0.1963	3	0.213	0.03563	3/32	0.0938	0.00690
31/64	0.4844	0.1843	4	0.209	0.03431	42	0.0935	0.00687
15/32	0.4688	0.1726	5	0.2055	0.03317	43	0.0890	0.00622
29/64	0.4531	0.1613	6	0.204	0.03269	44	0.0860	0.00581
7/16	0.4375	0.1503	13/64	0.2031	0.03241	45	0.0820	0.00528
27/64	0.4219	0.1398	7	0.201	0.03173	46	0.0810	0.00515
Z	0.413	0.1340	8	0.199	0.03110	47	0.0785	0.00484
13/32	0.4063	0.1296	9	0.196	0.03017	5/64	0.0781	0.00479
Y	0.404	0.1282	10	0.1935	0.02940	48	0.0760	0.00454
Z	0.397	0.1238	11	0.191	0.02865	49	0.0730	0.00419
25/64	0.3906	0.1198	12	0.189	0.02806	50	0.0700	0.00385
W	0.386	0.1170	3/16	0.1875	0.02861	51	0.0670	0.00353
V	0.377	0.1116	13	0.185	0.02688	52	0.0635	0.00317
3/8	0.375	0.1104	14	0.182	0.02602	1/16	0.0625	0.00307
U	0.368	0.1064	15	0.1800	0.02554	53	0.0595	0.00278
23/64	0.3594	0.1014	16	0.1770	0.02461	54	0.0550	0.00238
T	0.358	0.1006	17	0.1730	0.02351	55	0.0520	0.00212
S	0.348	0.09511	11/64	0.1719	0.02320	3/64	0.0473	0.00173
11/32	0.3438	0.09281	18	0.1695	0.02256	56	0.0465	0.001698
R	0.339	0.09026	19	0.1660	0.02164	57	0.0430	0.001452
Q	0.332	0.08657	20	0.1610	0.02036	58	0.0420	0.001385
21/64	0.3281	0.08456	21	0.1590	0.01986	59	0.0410	0.001320
P	0.323	0.08194	22	0.1570	0.01936	60	0.0400	0.001257
O	0.316	0.07843	5/32	0.1563	0.01917	61	0.039	0.001195
5/16	0.3125	0.07670	23	0.1540	0.01863	62	0.038	0.001134
N	0.302	0.07163	24	0.1520	0.01815	63	0.037	0.001075
19/64	0.2969	0.06922	25	0.1495	0.01755	64	0.036	0.001018
M	0.295	0.06835	26	0.1470	0.01697	65	0.035	0.000962
L	0.29	0.06605	27	0.1440	0.01629	66	0.033	0.000855
9/32	0.2813	0.06213	9/64	0.1406	0.01553	67	0.032	0.000804
K	0.281	0.06202	28	0.1405	0.01549	1/32	0.0313	0.000765
J	0.277	0.06026	29	0.1360	0.01453	68	0.031	0.000755
I	0.272	0.05811	30	0.1285	0.01296	69	0.0292	0.000670
H	0.266	0.05557	1/8	0.1250	0.01227	70	0.028	0.000616
17/64	0.2656	0.05542	31	0.1200	0.01131	71	0.026	0.000531
G	0.261	0.05350	32	0.1160	0.01057	72	0.025	0.000491
F	0.257	0.05187	33	0.1130	0.01003	73	0.024	0.000452
E 1/4	0.2500	0.04909	34	0.1110	0.00968	74	0.0225	0.000398
D	0.246	0.04753	35	0.1100	0.00950	75	0.021	0.000346
C	0.242	0.04600	7/64	0.1094	0.00940	76	0.020	0.000314
B	0.238	0.04449	36	0.1065	0.00891	77	0.018	0.000254
15/64	0.2344	0.04314	37	0.1040	0.00849	78	0.016	0.000201
A	0.234	0.04301	38	0.1015	0.00809	1/64	0.0156	0.000191
1	0.228	0.04083	39	0.0995	0.00778	79	0.0145	0.000165
2	0.221	0.03836	40	0.0980	0.00754	80	0.0135	0.000143
7/32	0.2188	0.03758	41	0.0960	0.00724			

Note: Designations are in fractions of an inch, in standard twist drill letters, or in standard twist drill numbers, the latter being the same as steel wire gauge numbers.