

# FLC240 LED Floodlights

1/24

**we-ef**

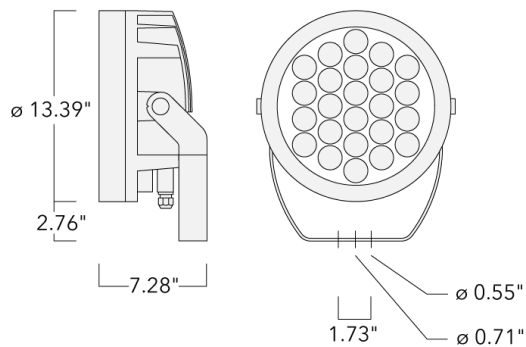

## Description

IP66. Class I. IK07. Marine-grade, die-cast aluminum alloy. 5CE superior corrosion protection including PCS hardware. Silicone CCG® Controlled Compression Gasket. Safety glass lens. One cable gland, second gland for through wiring on request. CAD-optimized optics for superior illumination and glare control. Integral driver, thermally separated. OLC® One LED Concept. Factory-installed LED circuit board. 0-10V Dimming on request. A maximum of one internal optical accessory. Optional 2200K version available, except [VNS] version, to be specified at time of order. Specify product with 7 Digit product code – Finish Color. Accessories, such as mounting, optical, and electrical, must be specified separately. Example: XXX-XXXX-9004 (Black) + XXX-XXXX (Accessory 1)

# FLC240 LED







## Floodlights

2/24

**we-ef**

## Specifications

### Material Specification

Body:	Marine-grade, die-cast aluminium alloy
Lens:	Safety glass lens
Colours:	 RAL9004 Black  RAL9007 Grey Metallic  RAL9016 White  RAL8019 Dark Bronze
 3G	Meets ANSI C136.31 - 3G Vibration Rating for Bridge and Overpass Applications.
 ETL	ETL, UL-1598 equivalent, CSA-C22.2#250.0. Suitable for Wet Locations.
 Quick Ship	Quickship features a one week ship time for Steplights and two week ship time for the rest of our Core products. All applicable information must be included for orders to be processed and colors must be in one of our 4 standard finishes. A maximum order quantity of 30 pieces applies.
Gasket:	Silicone CCG® Controlled Compression Gasket
Fasteners:	PCS Polymer Coated Stainless Steel Hardware
Ingress protection:	IP66
Impact protection:	IK07
Corrosion protection:	5CE
Surge protection:	Integral 10kV Surge Protector
Listings:	ETL, UL-1598, CSA-C22.2#250.0. Suitable for Wet Locations. Meets ANSI C136.31 - 3G Vibration Rating for Bridge and Overpass Applications.
Windage EPA (ft²):	1.176

### Electrical Specification

Power supply:	Integral [ECG] electronic driver 120V-277V. 0-10V dimmable, to be specified with order.
Power factor:	> 0.9
Driver / Ballast:	Integral EC electronic converter in thermally-separated compartment
Cable:	One cable entry, second cable entry on request. Request 0-10V to ensure control wires are connected.

### Lifetime

Ta=25°/40° L90B10 > 90000h

# FLC240 LED

## Floodlights

3/24



### Choices

Light Distributions	Nominal Lumen	Nominal Watt	Colour Temperatures	Colours
symmetric, wide beam [W]	5178	48	2700 K	RAL9004 Black
	5512	72		
symmetric, medium beam [M]	6180	104	3000 K	RAL9007 Grey Metallic
	6515			
symmetric, narrow beam [N]	7440	7517	4000 K	RAL9016 White
symmetric, very narrow beam [VN]	7920			
	8880			
symmetric, very narrow beam, 'sharp cut-off' [VNS]	9360	9516		RAL8019 Dark Bronze
	10130			
linear spread, very narrow beam [VN]	10800	11358		
	11971			
linear spread, very narrow beam, 'sharp cut-off'	13813			
wallwash				

# FLC240 LED

## Floodlights

4/24



### Configurations

#### Light Distributions





	Part ID	Light Source	Delivered Lumens	Rated Input Power	CRI	Weight	Link
	139-2251	LED-24/48W / 700 mA - 2700 K	5311.1	55	80	27.80	<a href="#">📄 ↗</a>
	139-1921	LED-24/48W / 700 mA - 3000 K	5599	55	80	27.80	<a href="#">📄 ↗</a>
	139-1922	LED-24/48W / 700 mA - 4000 K	6460.1	55	80	27.80	<a href="#">📄 ↗</a>
	139-2249	LED-24/72W / 1050 mA - 2700 K	7631.4	81	80	27.80	<a href="#">📄 ↗</a>
	139-1923	LED-24/72W / 1050 mA - 3000 K	8044	81	80	27.80	<a href="#">📄 ↗</a>
	139-1924	LED-24/72W / 1050 mA - 4000 K	9281.5	81	80	27.80	<a href="#">📄 ↗</a>
	139-2227	LED-24/104W / 1400 mA - 2700 K	9431.2	115	80	27.80	<a href="#">📄 ↗</a>
	139-1925	LED-24/104W / 1400 mA - 3000 K	9940.2	115	80	27.80	<a href="#">📄 ↗</a>
	139-1926	LED-24/104W / 1400 mA - 4000 K	11469.8	115	80	27.80	<a href="#">📄 ↗</a>
	139-2252	LED-24/48W / 700 mA - 2700 K	5598.1	55	80	27.80	<a href="#">📄 ↗</a>
	139-1812	LED-24/48W / 700 mA - 3000 K	5901.6	55	80	27.80	<a href="#">📄 ↗</a>
	139-1813	LED-24/48W / 700 mA - 4000 K	6809.2	55	80	27.80	<a href="#">📄 ↗</a>
	139-2152	LED-24/72W / 1050 mA - 2700 K	8043.9	81	80	27.80	<a href="#">📄 ↗</a>
	139-1818	LED-24/72W / 1050 mA - 3000 K	8478.7	81	80	27.80	<a href="#">📄 ↗</a>
	139-1819	LED-24/72W / 1050 mA - 4000 K	9783.1	81	80	27.80	<a href="#">📄 ↗</a>
	139-2228	LED-24/104W / 1400 mA - 2700 K	9893.1	115	80	27.80	<a href="#">📄 ↗</a>
	139-1824	LED-24/104W / 1400 mA - 3000 K	10427.1	115	80	27.80	<a href="#">📄 ↗</a>
	139-1825	LED-24/104W / 1400 mA - 4000 K	12031.5	115	80	27.80	<a href="#">📄 ↗</a>
	139-2253	LED-24/48W / 700 mA - 2700 K	5266.3	55	80	27.80	<a href="#">📄 ↗</a>
	139-1814	LED-24/48W / 700 mA - 3000 K	5551.8	55	80	27.80	<a href="#">📄 ↗</a>
	139-1815	LED-24/48W / 700 mA - 4000 K	6405.7	55	80	27.80	<a href="#">📄 ↗</a>
	139-2250	LED-24/72W / 1050 mA - 2700 K	7567.2	81	80	27.80	<a href="#">📄 ↗</a>
	139-1820	LED-24/72W / 1050 mA - 3000 K	7976.2	81	80	27.80	<a href="#">📄 ↗</a>
	139-1821	LED-24/72W / 1050 mA - 4000 K	9203.3	81	80	27.80	<a href="#">📄 ↗</a>
	139-2229	LED-24/104W / 1400 mA - 2700 K	9313.9	115	80	27.80	<a href="#">📄 ↗</a>
	139-1826	LED-24/104W / 1400 mA - 3000 K	9816.6	115	80	27.80	<a href="#">📄 ↗</a>
	139-1827	LED-24/104W / 1400 mA - 4000 K	11327.1	115	80	27.80	<a href="#">📄 ↗</a>
	139-2265	LED-24/48W / 700 mA - 2700 K	5541.6	55	80	27.80	<a href="#">📄 ↗</a>
	139-1816	LED-24/48W / 700 mA - 3000 K	5842	55	80	27.80	<a href="#">📄 ↗</a>
	139-1817	LED-24/48W / 700 mA - 4000 K	6740.5	55	80	27.80	<a href="#">📄 ↗</a>
	139-2272	LED-24/72W / 1050 mA - 2700 K	7962.7	81	80	27.80	<a href="#">📄 ↗</a>
	139-1822	LED-24/72W / 1050 mA - 3000 K	8393.1	81	80	27.80	<a href="#">📄 ↗</a>
	139-1823	LED-24/72W / 1050 mA - 4000 K	9684.4	81	80	27.80	<a href="#">📄 ↗</a>
	139-2278	LED-24/104W / 1400 mA - 2700 K	9981.4	115	80	27.80	<a href="#">📄 ↗</a>
	139-1828	LED-24/104W / 1400 mA - 3000 K	10520.1	115	80	27.80	<a href="#">📄 ↗</a>
	139-1829	LED-24/104W / 1400 mA - 4000 K	12138.8	115	80	27.80	<a href="#">📄 ↗</a>
	139-2266	LED-24/48W / 700 mA - 2700 K	4628.1	55	80	27.80	<a href="#">📄 ↗</a>
	139-1915	LED-24/48W / 700 mA - 3000 K	4926.6	55	80	27.80	<a href="#">📄 ↗</a>
	139-1916	LED-24/48W / 700 mA - 4000 K	5523.7	55	80	27.80	<a href="#">📄 ↗</a>
	139-2273	LED-24/72W / 1050 mA - 2700 K	6649.9	81	80	27.80	<a href="#">📄 ↗</a>
	139-1917	LED-24/72W / 1050 mA - 3000 K	7078.9	81	80	27.80	<a href="#">📄 ↗</a>
	139-1918	LED-24/72W / 1050 mA - 4000 K	7936.9	81	80	27.80	<a href="#">📄 ↗</a>

# FLC240 LED Floodlights

5/24



## Configurations

Light Distributions	Part ID	Light Source	Delivered Lumens	Rated Input Power	CRI	Weight	Link
 symmetric, very narrow beam, 'sharp cut-off' [VNS]	139-2280	LED-24/104W / 1400 mA - 2700 K	8250.1	115	80	27.80	<a href="#">📄 ↗</a>
	139-1919	LED-24/104W / 1400 mA - 3000 K	8782.4	115	80	27.80	<a href="#">📄 ↗</a>
	139-1920	LED-24/104W / 1400 mA - 4000 K	9847.1	115	80	27.80	<a href="#">📄 ↗</a>
 linear spread, very narrow beam [VN]	139-2265 139-1855	LED-24/48W / 700 mA - 2700 K	5281.3	55	80	27.80	<a href="#">📄 ↗</a>
	139-1816 139-1855	LED-24/48W / 700 mA - 3000 K	5567.6	55	80	27.80	<a href="#">📄 ↗</a>
	139-1817 139-1855	LED-24/48W / 700 mA - 4000 K	6423.8	55	80	27.80	<a href="#">📄 ↗</a>
	139-2272 139-1855	LED-24/72W / 1050 mA - 2700 K	7588.6	81	80	27.80	<a href="#">📄 ↗</a>
	139-1822 139-1855	LED-24/72W / 1050 mA - 3000 K	7998.8	81	80	27.80	<a href="#">📄 ↗</a>
	139-1823 139-1855	LED-24/72W / 1050 mA - 4000 K	9229.4	81	80	27.80	<a href="#">📄 ↗</a>
	139-2278 139-1855	LED-24/104W / 1400 mA - 2700 K	8376.8	115	80	27.80	<a href="#">📄 ↗</a>
	139-1828 139-1855	LED-24/104W / 1400 mA - 3000 K	9840.4	115	80	27.80	<a href="#">📄 ↗</a>
	139-1829 139-1855	LED-24/104W / 1400 mA - 4000 K	11354.6	115	80	27.80	<a href="#">📄 ↗</a>
	 linear spread, very narrow beam, 'sharp cut-off'	139-2266 139-1855	LED-24/48W / 700 mA - 2700 K	4522.1	55	80	27.80
139-1915 139-1855		LED-24/48W / 700 mA - 3000 K	4813.8	55	80	27.80	<a href="#">📄 ↗</a>
139-1916 139-1855		LED-24/48W / 700 mA - 4000 K	5397.2	55	80	27.80	<a href="#">📄 ↗</a>
139-2273 139-1855		LED-24/72W / 1050 mA - 2700 K	6497.5	81	80	27.80	<a href="#">📄 ↗</a>
139-1917 139-1855		LED-24/72W / 1050 mA - 3000 K	6916.7	81	80	27.80	<a href="#">📄 ↗</a>
139-1918 139-1855		LED-24/72W / 1050 mA - 4000 K	7755.1	81	80	27.80	<a href="#">📄 ↗</a>
139-2280 139-1855		LED-24/104W / 1400 mA - 2700 K	7990.8	115	80	27.80	<a href="#">📄 ↗</a>
139-1919 139-1855		LED-24/104W / 1400 mA - 3000 K	8506.4	115	80	27.80	<a href="#">📄 ↗</a>
139-1920 139-1855		LED-24/104W / 1400 mA - 4000 K	9537.6	115	80	27.80	<a href="#">📄 ↗</a>
 wallwash		139-2252 139-1854	LED-24/48W / 700 mA - 2700 K	5598.1	55	80	27.80
	139-1812 139-1854	LED-24/48W / 700 mA - 3000 K	4901.1	55	80	27.80	<a href="#">📄 ↗</a>









# FLC240 LED

## Floodlights



















6/24

**we-ef**

### Configurations

Light Distributions	Part ID	Light Source	Delivered Lumens	Rated Input Power	CRI	Weight	Link
 wallwash	139-1813 139-1854	LED-24/48W / 700 mA - 4000 K	5654.8	55	80	27.80	
	139-2152 139-1854	LED-24/72W / 1050 mA - 2700 K	6680.2	81	80	27.80	
	139-1818 139-1854	LED-24/72W / 1050 mA - 3000 K	7041.3	81	80	27.80	
	139-1819 139-1854	LED-24/72W / 1050 mA - 4000 K	8124.5	81	80	27.80	
	139-2228 139-1854	LED-24/104W / 1400 mA - 2700 K	8215.8	115	80	27.80	
	139-1824 139-1854	LED-24/104W / 1400 mA - 3000 K	8659.2	115	80	27.80	
	139-1825 139-1854	LED-24/104W / 1400 mA - 4000 K	9991.6	115	80	27.80	

### Related Families / FLC200 LED

Family		Dimensions	Wattage	Nominal Lumen	Links	
					Links	Download Data Sheet
FLC201 LED		2.95	6 W	615 -720		
FLC210 LED		5.90	6 -12 W	720 -1590		
FLC220 LED		7.48	12 -26 W	1295 -3453		
FLC230 LED		10.24	24 -52 W	2589 -6907		
FLC240 LED		13.39	48 -104 W	5178 -13813		
FLC260 LED		15.15	72 -155 W	7767 -20720		

# FLC240 LED

## Floodlights

7/24

**we-ef**

## Mounting Accessories

### Floodlight mounting bracket TA

■ **667-9310** TA1 Mounting bracket,  
gle (Ø 3 x 7.87)

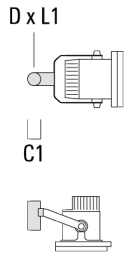

	<b>C1</b>	<b>D x L</b>	<b>Weight (lbs)</b>
■ <b>147-0096</b> TA1 Mounting bracket, gle (Ø 4.25 x 7.87)	5.12	4.25 x 7.87	16.53 lbs

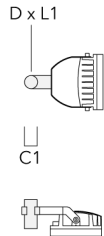

# FLC240 LED

## Floodlights

8/24



	C1	D x L	L	Weight (lbs)
■ <b>147-0024</b> TA2 Mounting bracket, ble* (Ø 4.25 x 7.87)	5.12	2.99 x 7.87	2.99	4.2 lbs lbs

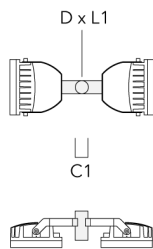

■ <b>147-0024</b> TA2-L Mounting bracket, ble (Ø 3.0 x 7.87)
---

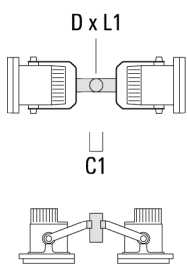



# FLC240 LED

## Floodlights

9/24



	<b>A</b>	<b>C1</b>	<b>D x L</b>	<b>Weight (lbs)</b>
■ <b>147-0105</b> TA2-L Mounting bracket, ble (Ø 3.0"x7.87" long)	±90°	16.54	2.99 x 7.87	35.49 lbs

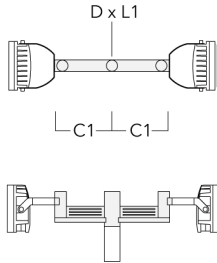

	<b>A</b>	<b>C1</b>	<b>D x L</b>	<b>Weight (lbs)</b>
■ <b>147-0148</b> TA2-L Mounting bracket, ble (Ø 4.25 x 7.87 long)	±90°	16.54	4.25 x 7.87	44.53 lbs

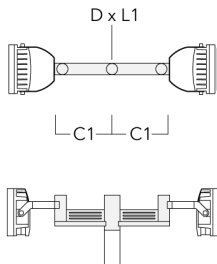

# FLC240 LED

## Floodlights

10/24



	<b>A</b>	<b>C1</b>	<b>D x L</b>	<b>Weight (lbs)</b>
■ <b>147-0025</b> TA3 Mounting bracket, ple (Ø 3.50 x 7.87)	±90°	25.59	3.50 x 7.87	39.46 lbs

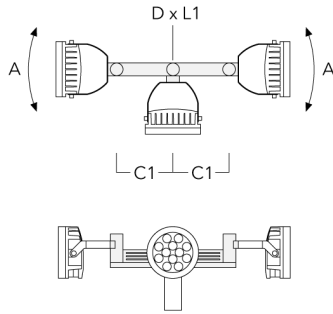

	<b>A</b>	<b>C1</b>	<b>D x L</b>	<b>Weight (lbs)</b>
■ <b>147-0098</b> TA3 Mounting bracket, ple (Ø 4.25 x 7.87)	±90°	25.59"	4.25 x 8	53.35 lbs lbs

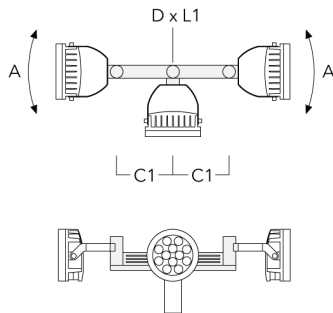

# FLC240 LED

## Floodlights

11/24



	<b>A</b>	<b>C1</b>	<b>D x L</b>	<b>Weight (lbs)</b>
■ <b>147-0099</b> TA4 Mounting bracket, d (Ø 3.50 x 7.87)	±90°	25.59	3.50 x 7.87	45.86 lbs lbs

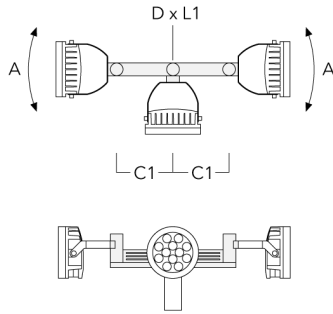

	<b>A</b>	<b>C1</b>	<b>D x L</b>	<b>Weight (lbs)</b>
■ <b>147-0100</b> TA4 Mounting bracket, d (Ø 4.25 x 7.87)	±9°	65.0	4.25 x 7.87	53.00 lbs

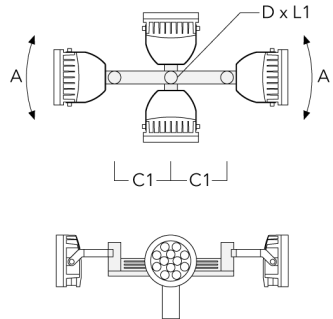

# FLC240 LED

## Floodlights

12/24



### Planted root

	D1	D2	D3	D4	H1	H2	M1	Weight (lbs)
■ <b>300-0461</b> Planted root ESV4	5.71	5.12	4.02	4.25	15.75	13.78	.31	15.54 lbs

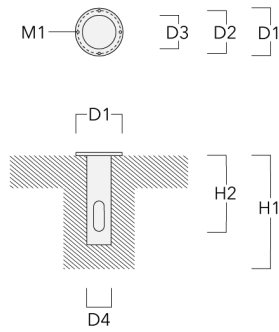

### Pole clamp TS

	D1	Weight (lbs)
■ <b>147-0543</b> TS1-2/M12 Pole clamp, gle (Ø 3"-3.5")	3.0-3.50	3.31 lbs

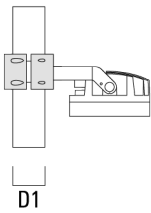
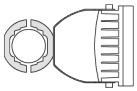

# FLC240 LED

## Floodlights

13/24



	D1	Weight (lbs)
■ <b>147-0526</b> TS1-2/M12 Pole clamp, gle (Ø 4.0"-4.5")	4.0-4.5	3.53 lbs

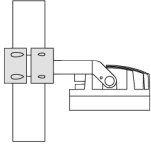
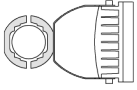

D1

	D1	Weight (lbs)
■ <b>147-0544</b> TS1-2/M12 Pole clamp, gle (Ø 4.5"-5.25")	4.5"-5.25"	3.75 lbs

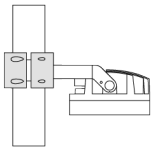
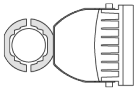

D1

# FLC240 LED

## Floodlights

14/24

**we-ef**

	D1	Weight (lbs)
■ <b>147-0545</b> TS2-2/M12 Pole clamp, ble (Ø 3"-3.5")	3.0"-3.5"	3.09 lbs lbs

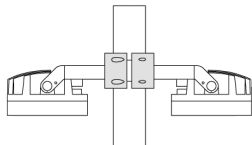
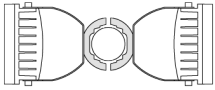

D1

	D1	Weight (lbs)
■ <b>147-0527</b> TS2-2/M16 Pole clamp, ble (Ø 4.0"-4.5")	4.0-4.50	3.31 lbs

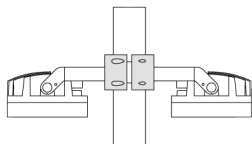
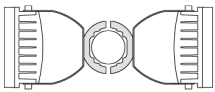

D1

# FLC240 LED

## Floodlights

15/24



	D1	Weight (lbs)
■ <b>147-0546</b> TS2-2/M16 Pole clamp, ble (Ø 4.5"-5.25")	4.50-5.25	3.53 lbs

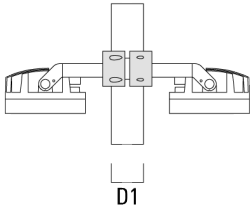
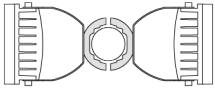

### Pole Mount Brackets PMB

	C1	C2	D1	D2	H1	H2	Weight (lbs)
■ <b>667-9341</b> PMB200-1 Pole mount bracket	1007.60	503.90	139.7	75.9x80+102.1x80	735.10	403.60	17.20 lbs

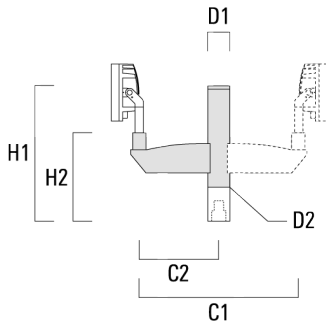

# FLC240 LED

## Floodlights

16/24



	C1	C2	D1	D2	H1	H2	Weight (lbs)
■ <b>667-9342</b> PMB200-2 Pole mount bracket	1007.60	503.90	139.7	75.9x80+102.1x80	735.10	403.60	25.90 lbs

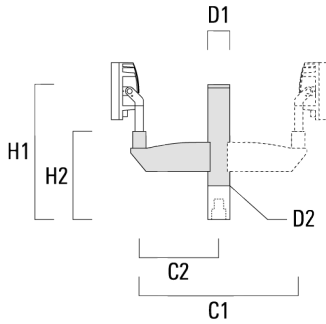

### Short post EM

	D1	D2	H1	M1	Weight (lbs)
■ <b>270-9038</b> EM1-M16 AL	6.3	5.12	7.87"	0.35"	4.85 lbs

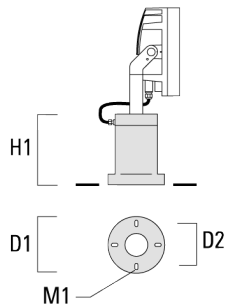



# FLC240 LED

## Floodlights

17/24

**we-ef**

667-9330 EM1-M16 AL

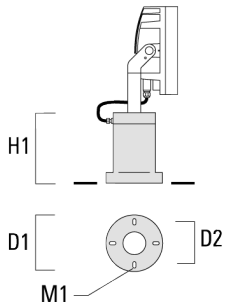

### Pole top caps KF

**Weight (lbs)**

669-9334 KF16-108/M16 Spigot Cap  
4.25")

2.00 lbs

# FLC240 LED

## Floodlights

18/24



	D1	Weight (lbs)
■ <b>669-9331</b> KF16-60/M16 Spigot Cap 2.36")	60x100	2.00 lbs

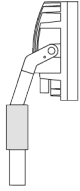

D1

	D1	Weight (lbs)
■ <b>669-9332</b> KF16-76/M16 Spigot Cap 3.0")	76 x 100	2.00 lbs

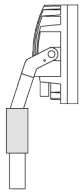

D1

# FLC240 LED

## Floodlights

19/24



■ **669-9333** KF16-89/M16 Spigot Cap  
3.5")

### Surface Mount Canopy SMC

	D1	D2	Weight (lbs)
■ <b>683-9329</b> SMC-200	10.83	9.25	15.4 lbs lbs

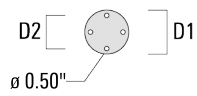

# FLC240 LED

## Floodlights

20/24

**we-ef**

### Wall Mount Bracket WMB

	C1	C2	D1	D2	H1	M1	M2	Weight (lbs)
■ <b>667-9339</b> WMB200 Wall mount bracket	515.10	119.90	235	200.2	288	26.7	1.9	9.10 lbs

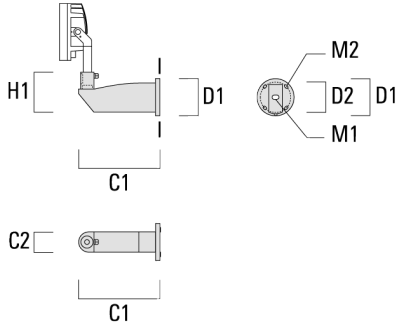

## Optical Accessories

### Softening Lens

	C1
■ <b>139-1856</b> IO-360-FLC240-LED	11.40

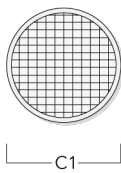

### Glare shield

# FLC240 LED

## Floodlights

21/24

**we-ef**

	<b>A</b>	<b>C1</b>
■ <b>139-1858</b> ES-FLC240-LED	7.87	13.62

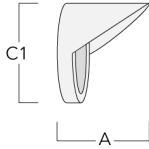

# FLC240 LED

## Floodlights

22/24

**we-ef**

	<b>A</b>	<b>C1</b>
■ <b>667-9279</b> ES-FLC240-LED	7.87	13.62

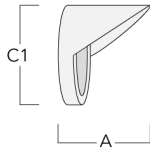

---

### Honeycomb louvre

	<b>C1</b>
■ <b>139-1857</b> Honeycomb Louvre IW	11.00

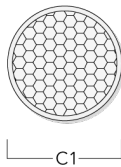

# FLC240 LED

## Floodlights

23/24

**we-ef**

### Linear spread lens

	<b>C1</b>
■ <b>139-1855</b> Linear spread lens IO	11.40

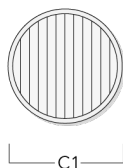

### Snoot

	<b>A</b>	<b>C1</b>
■ <b>139-1859</b> ET-FLC240-LED	7.1	11.50

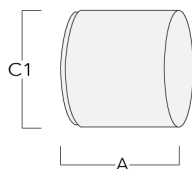

# FLC240 LED

## Floodlights

24/24

**we-ef**

	<b>A</b>	<b>C1</b>
■ <b>667-9280</b> ET-FLC240-LED	7.87	13.62

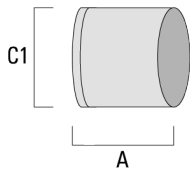

### Wallwash lens

	<b>C1</b>
■ <b>139-1854</b> IO-20-FLC240-LED	11.40

