

---

# **Fleetrite Collision Catalog**

**2019**



# Collision Parts Support Hotline

- For questions and additional support about accurately identifying the correct Fleetrite part number for hoods and bumpers, call or email the Fleetrite Collision Parts Support Hotline.
- This dedicated hotline is ready to answer questions, provide technical advice, and help to identify the correct hoods and bumpers for the application
- When calling the hotline, please have the following information available:
  - ✓ Vehicle Information: year, make and model
  - ✓ Contact Information: name, company, phone and email
- 1-888-390-6221
- 1-307-269-0102
- [support@collisionpartssupport.com](mailto:support@collisionpartssupport.com)

## Fleetrite Collision Catalog

# Table of Contents

<b>Collision Parts Hotline</b>	2	<b>Kenworth</b>	
<b>Freightliner</b>		T2000	22
Cascadia	4	T800	24
Century	6	W900	26
Columbia	8	T660	27
M2	10	T600	28
FLD & Sprinter	12	T300	29
<b>International</b>		<b>Peterbilt 379</b>	30
DuraStar	13	<b>Volvo VNL</b>	32
ProStar	15	<b>Mack</b>	
PayStar	17	CX	34
LoneStar	18	RD	35
WorkStar	19	<b>Bus</b>	
9900	20	IC Bus	36
7000	21	Blue Bird Bus	36
		Thomas C2 Bus	36

# Freightliner Cascadia 125" BBC

## PARTS

- Glass
- Hood
- Grille
- Lights
- Bumper



## QUESTIONS:

Is the OEM part number listed below? If yes, please continue with Fleetrite hood number listed. If not, please answer these questions:

1. What is the make, model and year?
2. What is the length of the hood? Measured straight down the center to the grille opening (as pictured to left).
  - › If the length is 50 inches long, you need: **FLTHCASL**

## HOODS

Long Hood (2008-2016)

### FLTHCASL

OEM Part Number:  
A17-15340-007,  
A17-15340-004

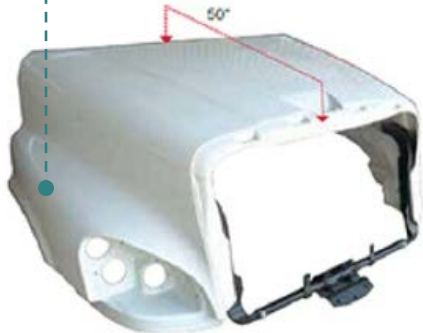

- Hinge bar included
- 2008-2016

## BUMPERS

Right, Inner  
**FLTBCCASFR**



Right, Outer  
**FLTBCCASOCR**

OEM Part Number:  
R21-27300-001



Left, Inner  
**FLTBCCASFL**



Left, Outer  
**FLTBCCASOCL**

OEM Part Number:  
L21-27300-000



Center, Inner  
**FLTBCCASCIP**

OEM Part Number:  
A21-28443-000



Center, Outer  
**FLTBCCASCOP**

OEM Part Number:  
A21-28446-002



Right, Inner  
**FLTBCCASICR**

OEM Part Number:  
R21-28619-003



Left, Inner  
**FLTBCCASICL**

OEM Part Number:  
L21-28619-002



## BUMPERS

Clad with Kit (2007-2016)



**FLTBCASC**

OEM Part Number: A21-28546-057



Painted Grey with No Fog Light Holes

**FLTBCASPGNOFL**

OEM Part Number: A21-28546-004, A21-28546-008

Painted Grey with Fog Light Holes



**FLTBCASPG**

OEM Part Number: A21-28546-054

## GRILLES

Chrome (2008-2016)

**FLTGFCASC**

OEM Part Number: A17-19112-011

Grille Hardware (2008-2016)

**FLTGHCASC**



## GLASS

One Piece Bent Windshield (2003-2004)

**FLTDW01000PK1**

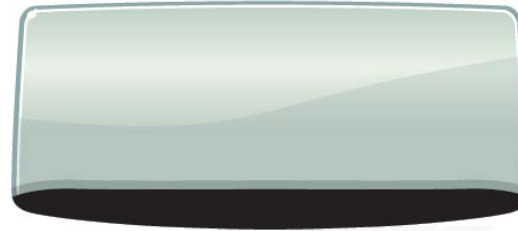

Driver Side Windshield (2008-2016)

**FLTDW01732PK1** (1 Pack)

**FLTDW01732PK4** (4 Pack)



Passenger Side Windshield (2008-2016)

**FLTDW01731PK1** (1 Pack)

**FLTDW01731PK4** (4 Pack)



## LIGHTS

Left Headlight (2008-2014)

**FLTHLFCASL**

OEM Part Number: A06-51907-002



Right Headlight (2008-2014)

**FLTHLFCASR**

OEM Part Number: A06-51907-003

Driver Side Fog Light

**FLTFLFCASL**

OEM Part Number: A06-51908-000



Passenger Side Fog Light

**FLTFLFCASR**

OEM Part Number: A06-51908-001

- Precision engineered and test fitted to ensure factory form and finish for every application
- Complies with FMVSS108

# Freightliner Century 120" BBC

## PARTS

- Hood
- Grille
- Lights
- Bumper

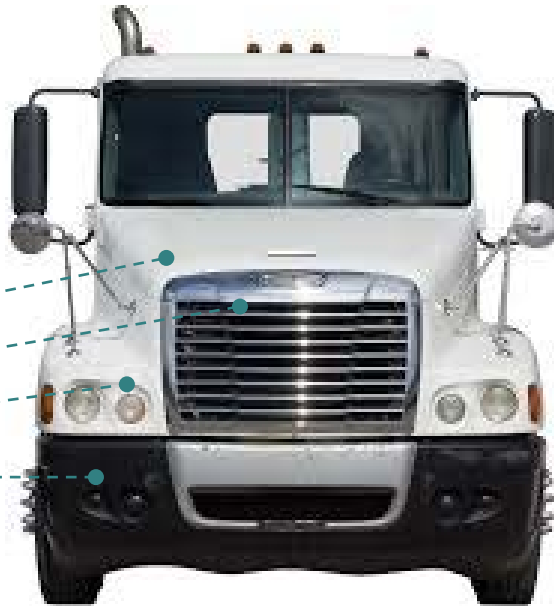

## QUESTIONS:

Is the OEM part number listed below? If yes, please continue with Fleetrите hood number listed. If not, please answer these questions:

1. What is the make, model and year?
2. What is the length of the hood? Measured straight down the center to the grille opening (as pictured below).
  - › If the length is 55 inches, has Hinge Bushings 41 inches apart, onlaid grille and year is within 1996-2002, you need: **FLTHCENC1202**
  - › If the length is 55 inches, has Hinge Bushings 6 inches apart, onlaid grille and year is within 2003-2005, you need: **FLTHCENC1201**
  - › If the length is 55 inches, has Hinge Bushings 6 inches apart, without fiberglass bar and year is 2005 and up, you need: **FLTHCENC120**

## HOODS

(1996-2002)

### FLTHCENC1202

OEM Part Number:  
A17-12701-002, A17-15420-000



- 1996-2002
- 41" hinge bushings
- Onlaid grille
- Round headlights

(2003-2005)

### FLTHCENC1201

OEM Part Number:  
A17-13154-000, A17-13154-004,  
A17-13154-006, A17-15365-000

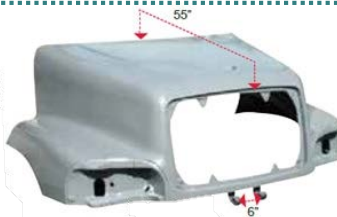

- 2003-2005
- 6" hinge bushings
- Onlaid grille
- Round headlights

(2005 and up)

### FLTHCENC120

OEM Part Number:  
A17-15092-002, A17-15092-007,  
A17-15092-008, A17-15092-010



- 2005 and up
- 6" hinge bushings
- Without fiberglass molding
- Torsion bar spring and larger chrome overlay grille
- Will not fit DD15

## BUMPERS

Chrome  
(2005-2016)  
**FLTBCENC**  
OEM Part Number:  
A21-26683-004



Left Extension,  
Fiberglass  
(1996-2005)  
**FLTBCENLP**  
OEM Part Number:  
A21-26684-000

Center,  
Fiberglass  
(1996-2005)  
**FLTBCENC**  
OEM Part Number:  
A21-28177-001,  
A21-26683-008

Right Extension,  
Fiberglass  
(1996-2005)  
**FLTBCENRP**  
OEM Part Number:  
A21-26684-001



- *Chrome and painted finish*
- *Lightweight aerodynamic design*

## GRILLES

Chrome  
(2005 and up)  
**FLTGFCENT**  
OEM Part Number:  
A17-16132-004

Grille Hardware  
(2005 and up)  
**FLTGHCENT**



## LIGHTS

Right Headlight  
(1996-2006)  
**FLTHLFCENR**  
OEM Part Number:  
A06-20711-001



Left Headlight  
(1996-2006)  
**FLTHLFCENL**  
OEM Part Number:  
A06-20711-000

\*\*Note: Confirm fit prior to painting. Painted parts cannot be returned.

# Freightliner Columbia 120" BBC

## PARTS

- Hood
- Grille
- Lights
- Bumper

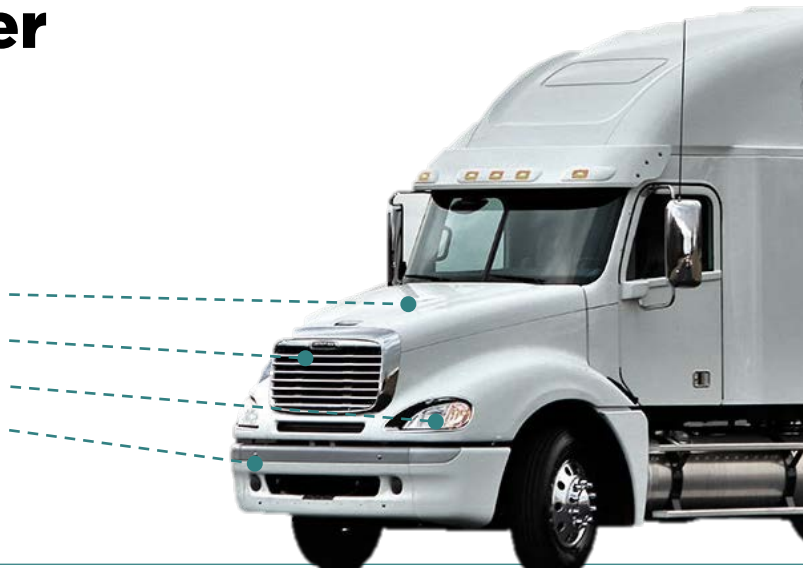

## QUESTIONS:

Is the OEM part number listed below? If yes, please continue with Fleetríte hood number listed. If not, please answer these questions:

1. What is the make, model and year?
2. What is the length of the hood? Measured straight down the center to the grille opening
3. Ask for a picture of the inside hood
  - › If the air cleaner connector is on the passenger side, you need **FLTHCOL3PC**
  - › If the air cleaner connector is on the driver side, you need **FLTHCOLRTM3**

## HOODS

RTM Bonded in 3 Pieces  
(2001-2007)

### FLTHCOL3PC

OEM Part Number:  
A17-16515-000, A17-16515-002



- 2001-2007
- Teardrop headlights
- Will not fit with short hood
- Lower horizontal air duct below grille
- Air cleaner connector on passenger side

## What is RTM?

*Resin Transfer Molding is a manufacturing process for a smooth finish*

RTM Bonded in 3 Pieces  
(2008 and up)

### FLTHCOLRTM3

OEM Part Number: A17-13575-001, A17-13575-005, A17-13575-006, A17-13575-007, A17-15064-001, A17-15549-000, A17-15549-002, A17-16515-000, A17-16515-002, A17-16953-000

- 2008 and up
- ForAir cleaner connector on the driver side
- DD15/16 LT engine
- With gas recirculation





## BUMPERS (2001-2016)

Chrome

**FLTBCOLB**

OEM Part Number: A21-26266-002



Center, Fiberglass

**FLTBCOLCP**

OEM Part Number:  
A21-26020-006, A21-26020-011



Left Extension,  
Fiberglass

**FLTBCOLLP**

OEM Part Number:  
A21-26021-004

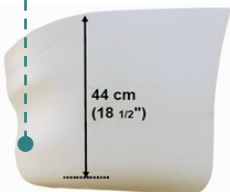

Right Extension,  
Fiberglass

**FLTBCOLRP**

OEM Part Number:  
A21-26021-005

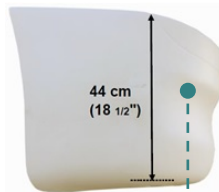

## GRILLES (2001 and up)

Chrome

**FLTGFCOLU**

OEM Part Number:  
A17-15251-003



Grille Hardware

**FLTGHCOLU**

### Bumpers:

- *Chrome and painted finish*
- *Lightweight aerodynamic design*

### Grilles:

- *Chromed ABS composite material for increased performance and durability*
- *Easy installation*
- *Precision engineered for OEM fit and replacement*

### Lights:

- *Precision engineered and test fitted to ensure factory form and finish for every application*
- *Complies with FMVSS108*

## LIGHTS

Left Headlight  
(1996-2004)

**FLTHLFCOLL**

OEM Part Number:  
A06-32496-006



Right Headlight  
(1996-2004)

**FLTHLFCOLR**

OEM Part Number:  
A06-32496-007



Fog Light,  
Yellow Lens

**FLTFLCOLY**

OEM Part Number:  
632497001

Fog Light,  
Clear Lens

**FLTFLCOLC**

OEM Part Number:  
A06-32497000



# Freightliner M2

## PARTS

- Hood
- Grille
- Lights
- Bumper



## QUESTIONS:

Is the OEM part number listed below? If yes, please continue with Fleetrite hood number listed. If not, please answer these questions:

1. What is the make, model and year?
2. Is the hood an M2 106 or M2 112? The M2 112 has two grille sections: larger on top and smaller on bottom.
3. What is the length of the hood? Measured straight down the center to the grille opening
  1. If the hood is 39" long, it is an M2 106 and four versions are available, listed below.
  2. If the hood is 43 1/2" long and has two grille sections, it is an M2 112 and four versions are available, listed below.
4. Does the hood have lights with a chrome bezel around?
5. Does it have a lower fiberglass band extension under the lower edge of the hood?

## 106 HOODS

With Bezel

### FLTHFLM2106B

OEM Part Number: A17-14802-000, A17-15459-000, A17-15459-002, A17-16394-004, A17-16639-000, A17-16903-000, A17-16908-004, A17-18190-000, A17-18196-004, A17-18197-004, A17-19133-002, A17-19218-001, A17-19218-012, A17-19133-012, A17-19133-022, A17-19133-032

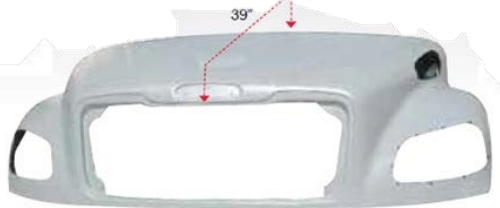

Without Bezel

### FLTHFLM2106NB

OEM Part Number: A17-15457-002, A17-16425-000, A17-16901-000, A17-16902-000, A17-18189-000, A17-19133-000, A17-19725-000

With Bezel, with  
Lower Extension

### FLTHFLM2106BX

OEM PART NUMBER  
A17-15460-002, A17-19133-006,  
A17-19133-038, A17-19218-003

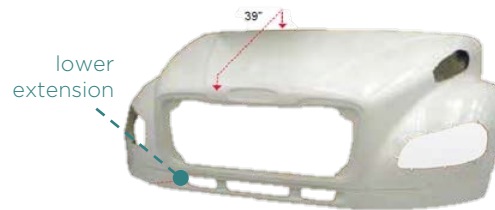

Without Bezel, with  
Lower Extension

### FLTHFLM2106LX

OEM Part Number:  
A17-15458-002,  
A17-19133-004

## 112 HOODS

With Bezel

### FLTHFLM2112B

OEM Part Number:  
A17-18200-010



Without Bezel

### FLTHFLM2112NB

With Bezel, With  
Lower Extension

### FLTHFLM2112BX

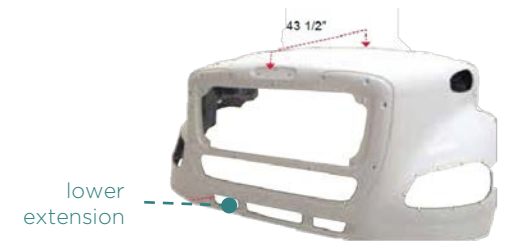

Without Bezel, with  
Lower Extension

### FLTHFLM2112LX

\*Confirm fit of all hoods prior to painting

BUMPERS

Center, Painted  
**FLTBFLM2CNTR**



3/16 FL - 106 Bumper  
Defrey with Install Kit  
**FLTBFLM2106WKT**



GRILLES

Black Surround with  
Lower Bug Screen  
**FLTGM2BLK**



Black & Chrome with  
Bug Screen  
**FLTGM2CHRBLK**

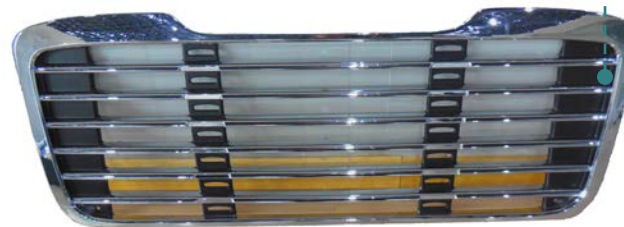

Chrome Surround with  
Lower Bug Screen  
**FLTGM2CHRO**



LIGHTS

Right Headlight  
**FLTHLFM2R**  
OEM Part Number:  
A06-51039-003



Left Headlight  
**FLTHLFM2L**  
OEM Part Number:  
A06-51039-002



- Precision engineered and test fitted to ensure factory form and finish for every application
- Complies with FMVSS108

## Freightliner FLD



PARTS  
Lights

### LIGHTS

Right Headlight  
(1989-2002)

**FLTHLFFLDR**

OEM Part Number:  
A06-20738-001



Left Headlight  
(1989-2002)

**FLTHLFFLDL**

OEM Part Number:  
A06-20738-001



## Freightliner Sprinter



PARTS  
Lights

### LIGHTS

Right Headlight with Fog Lamp  
(2003-2006)

**FLTHLSFLR**

OEM Part Number: 5104469AA



Left Headlight with Fog Lamp  
(2003-2006)

**FLTHLSFLL**

OEM Part Number: 5104510AA



Right Headlight without Fog Lamp  
(2003-2006)

**FLTHLSNFLR**

OEM Part Number: 5103599AA



Left Headlight without Fog Lamp  
(2003-2006)

**FLTHLSNFLL**

OEM Part Number: 5103598AA

Looking for specific parts? We'll help you move your fleet forward. Visit [Fleetrite.com](http://Fleetrite.com) for more information.

# International DuraStar

## PARTS

- Glass
- Hood
- Grille
- Lights
- Bumper



## QUESTIONS:

Is the OEM part number listed below? If yes, please continue with Fleetrите hood number listed. If not, please answer these questions:

1. What is the make, model and year?
2. What is the length of the hood? Measured straight down the center to the grille opening (as pictured to left).
3. If it is 41" and year is 2002-2009, you need **FLTHDUR**

## HOODS

41" for Models 4200/4300/4400

### FLTHDUR

OEM Part Number: 3807254C94



## BUMPERS



Front, Painted Gray

### FLTBDURPG

OEM Part Number: 3610930C3

Chrome with Large  
Tow Hook Hole

### FLTBDURC

OEM Part Number: 3610935C3



Painted Black

### FLTBDURP

OEM Part Number: 3610939C3



## GRILLES

Chrome

**FLTG3551015**

OEM Part Number:  
3551015C99



## GLASS

One Piece Encapsulated Windshield

**FLTDW01451PK1** (1 Pack)

**FLTDW01451PK4** (4 Pack)



## LIGHTS

Left Headlight

**FLTHL3765679**

OEM Part Number: 3765679C940



Right Headlight

**FLTHL3765680**

OEM Part Number: 3765680C94



Left Headlight Assembly

**FLTHL3565429**

OEM Part Number: 3765681C93



Right Headlight Assembly

**FLTHL3565430**

OEM Part Number: 3765682C93



# YOUR UPTIME IS OUR FIRST PRIORITY

Your fleet is more than a fleet. It drives your business forward. Count on Fleetrite to keep you ahead of the curve - even after a collision.

*The Quality Promise for all Fleetrite products:*

- Meet or exceed OEM specifications
- Navistar aftermarket quality approved
- Backed by a one-year unlimited warranty\*

*\*One year parts and labor coverage when installed at an authorized location. One year parts only coverage when installed at a non-authorized location.*

# International ProStar

## PARTS

- Glass
- Hood
- Grille
- Lights
- Bumper



## QUESTIONS:

Is the OEM part number listed below? If yes, please continue with Fleetrите hood number listed. If not, please answer these questions:

1. What is the make, model and year?
2. What is the length of the hood? Measured straight down the center to the grille opening (as pictured to left).
  - › If the length is less than 57 3/4", it is a short hood and we don't offer it at this time
  - › If the length is 57 3/4" and the year is 2008 and up, you need **FLTHPROSTAR**

## HOODS (2008 and up)

### FLTHPROSTAR

OEM Part Number:  
3858844C92

- 2008 and up
- Does not fit 15 LT engine
- Does not fit short hood



## BUMPERS (2008 and up)

Clad 15 with Box

### FLTBPROCLAD

OEM Part Number:  
6091235C97



Right

### FLTBPROR



Left

### FLTBPROL



## GRILLES

Chrome  
(2008 and up)  
**FLTG3612816**  
OEM Part Number:  
3612816C97

Grille Hardware  
(2008 and up)  
**FLTGH3612816**



**MAKE YOUR  
FIRST CHOICE  
FLEETRITE**

## GLASS

One Piece Encapsulated,  
Heated & Asymmetrical  
Windshield  
(2001-2016)

**FLTDW01765PK1** (1 Pack)  
**FLTDW01765PK4** (4 Pack)



One Piece Encapsulated,  
Asymmetrical Windshield  
(2001-2016)

**FLTDW01685PK1** (1 Pack)  
**FLTDW01685PK4** (4 Pack)  
OEM Part Number: 3554252C6



## LIGHTS 2008-2014

Left Headlight  
(2008-2014)

**FLTHL3596015**  
OEM Part Number: 3596015C94



Right Headlight  
(2008-2014)

**FLTHL3596016**  
OEM Part Number: 3596016C94





# International PayStar

PARTS  
Glass



## GLASS

1 Piece Encapsulated Asymmetrical Windshield (2006-2016)

**FLTDW01710PK1** (1 Pack)  
**FLTDW01710PK4** (4 Pack)  
OEM Part Number: 3714740C1



Passenger Side Encapsulated Asymmetrical Windshield (2006-2016)

**FLTDW01664PK1** (1 Pack)  
**FLTDW01664PK4** (4 Pack)  
OEM Part Number: 3714754C1



Driver Side Encapsulated Asymmetrical Windshield (2006-2016)

**FLTDW01665PK1** (1 Pack)  
**FLTDW01665PK4** (4 Pack)  
OEM Part Number: 3714753C1

1 Piece Encapsulated Asymmetrical Windshield (2000-2016)

**FLTDW01663PK1** (1 Pack)  
**FLTDW01663PK4** (4 Pack)



Passenger Door Glass (2007-2016)

**FLTDD10036PK1** (1 Pack)  
**FLTDD10036PK4** (4 Pack)  
OEM Part Number:

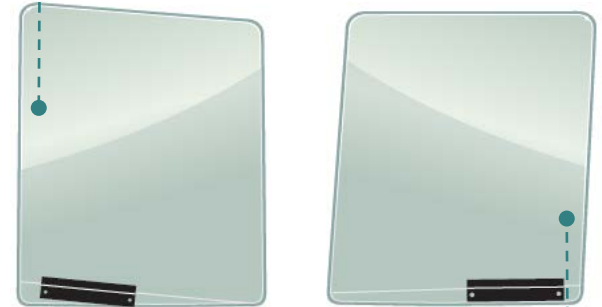

Driver Door Glass (2007-2016)

**FLTDD10037PK1** (1 Pack)  
**FLTDD10037PK4** (4 Pack)  
OEM Part Number:

Back Window, Tinted (2007-2016)

**FLTDB10038PK1** (1 Pack)  
**FLTDB10038PK4** (4 Pack)  
OEM Part Number: 403334C1

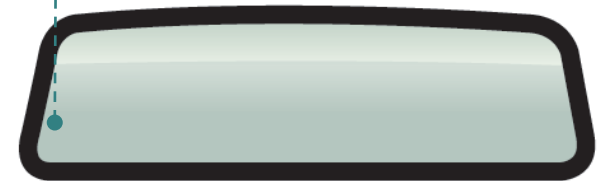



# International LoneStar

PARTS  
Glass



# MAKE YOUR FIRST CHOICE FLEETRITE

Your fleet is more than a fleet. It drives your business forward. Count on Fleetrite to keep you ahead of the curve - even after a collision.

*The Quality Promise for all Fleetrite products:*

- Meet or exceed OEM specifications
- Navistar aftermarket quality approved
- Backed by a one-year unlimited warranty\*

*\*One year parts and labor coverage when installed at an authorized location. One year parts only coverage when installed at a non-authorized location.*

## GLASS

Heated Solar  
Encapsulated Asymmetrical  
Windshield

**FLTDW01831PK1** (1 Pack)  
**FLTDW01831PK4** (4 Pack)

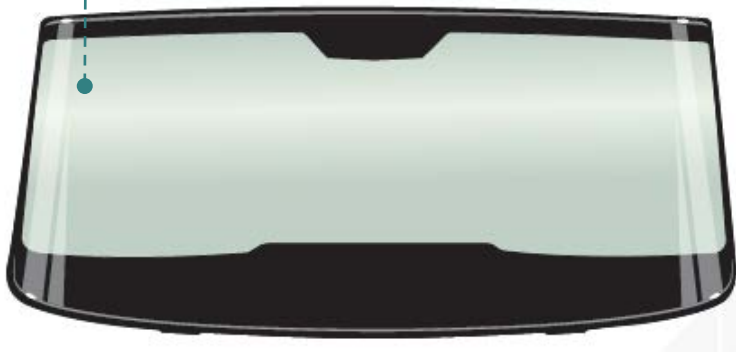

Solar Encapsulated  
Asymmetrical Windshield  
**FLTDW01770PK1** (1 Pack)  
**FLTDW01770PK4** (4 Pack)

OEM Part Number:  
3819510C2



# International WorkStar

PARTS  
Hood



## QUESTIONS:

Is the OEM part number listed below? If yes, please continue with Fleetrite hood number listed. If not, please answer these questions:

1. What is the make, model and year?
2. What is the length of the hood? Measured straight down the center to the grille opening (as pictured below).
3. If the hood does not have a spacer under the grille, you need **FLTHWRKS**
4. If the hood does have a spacer under the grille, you need **FLTHWRKL**

**\*\*Note: Hoods do not fit with MaxxForce engines**

## HOODS

Short, Modified Design, No Spacer Under Grille

### FLTHWRKS

OEM Part Number:  
2585819C93

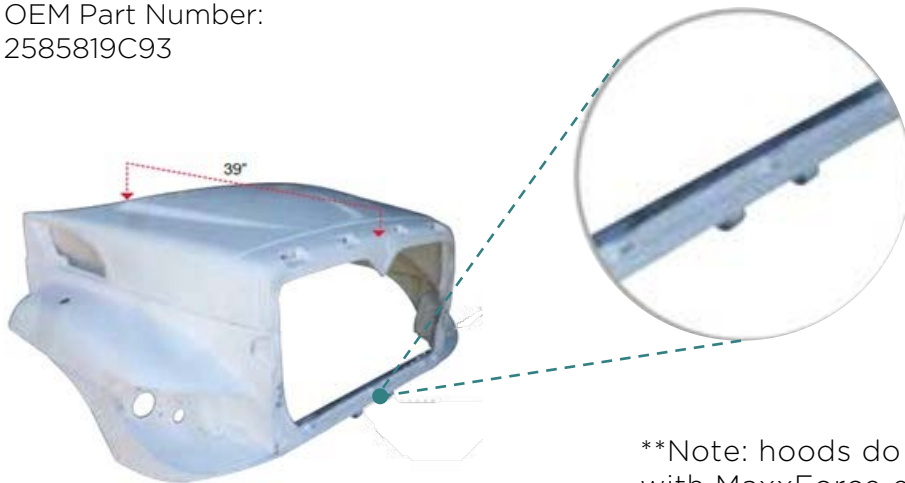

Long, Modified Design, Spacer Under Grille

### FLTHWRKL

OEM Part Number:  
2585821C93

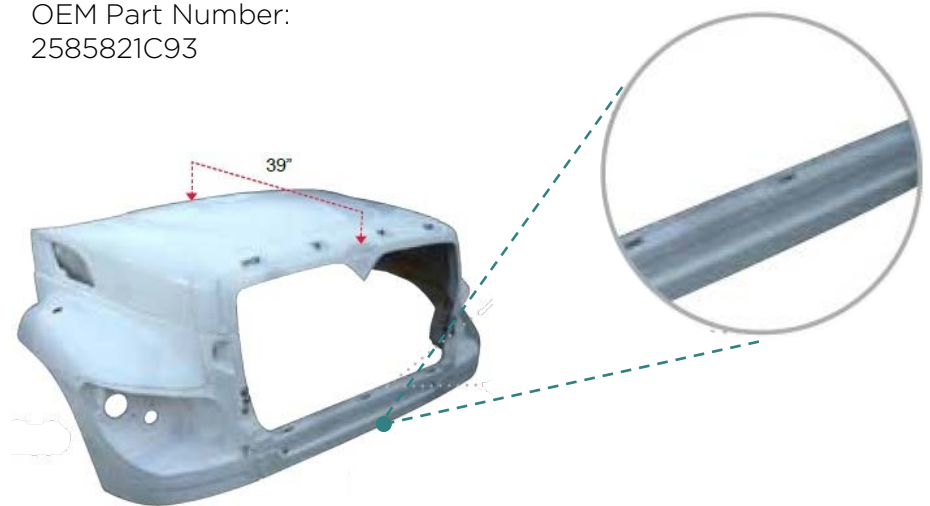

**\*\*Note: hoods do not fit with MaxxForce engines**

# International 9900



## PARTS

- Glass
- Hood

## QUESTIONS:

- Is the OEM part number listed below? If yes, please continue with Fleetrite hood number listed. If not, please answer these questions:
1. What is the make, model and year? (Hoods are 1999 and up)
  2. Does the truck have a curved windshield?
    - If yes, continue with questions
    - If no, hood will not fit
  3. What is the length of the hood? Measured straight down the center to the grille opening (as pictured below).
    - If length is 57", it is a short hood
      1. Does the truck have outboard air cleaners?
        - Yes → **FLTH9900S**
        - No → **FLT9900SNB**
    - If length is 67", it is a long hood
      1. Does the truck have outboard air cleaners?
        - Yes → **FLTH9900L**

## HOODS

### With Breather Cutouts

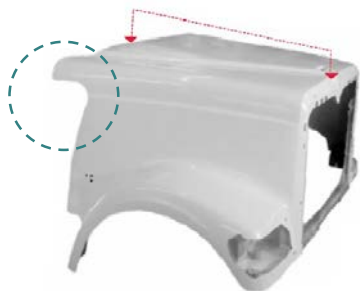

- 1999 and up
- Compatible with curved windshields only

Short, 57"  
**FLTH9900S**

OEM Part Number:  
3531924C91,  
3552478C93,  
3552478C94,  
3867439C94

Long, 67"  
**FLTH9900L**

### Without Breather Cutouts



- 1999 and up
- Compatible with curved windshields only

Short, 57"  
**FLTH9900SNB**

OEM Part Number:  
3867439C94,  
3531917C91,  
3524263C91

## GLASS

### Flat Windshield

**FLTDL04586PK1** (1 Pack)  
**FLTDL04586PK4** (4 Pack)

OEM Part Number:  
403339C1



# International 7000 Series

PARTS  
Hood



## QUESTIONS:

Is the OEM part number listed below? If yes, please continue with Fleetrите hood number listed. If not, please answer these questions:

1. What is the make, model and year?
2. What is the length of the hood? Measured straight down the center to the grille opening (as pictured below).
3. If the hood does not have a spacer under the grille, you need **FLTH737475**
4. If the hood does have a spacer under the grille, you need **FLTH7677**

## HOODS

Modified Design, Spacer Under Grille  
for Models 7600/7700

**FLTH7677**

OEM Part Number:  
2585821C93

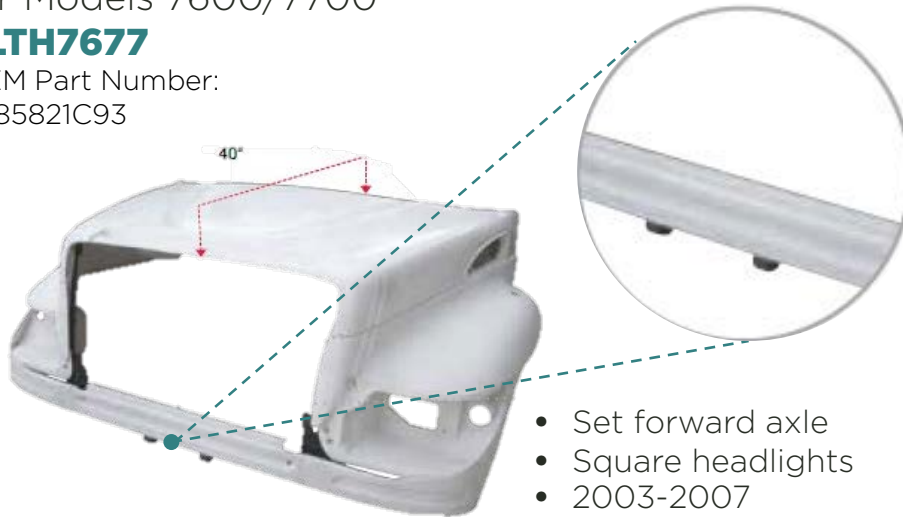

- Set forward axle
- Square headlights
- 2003-2007

Modified Design, No Spacer Under Grille  
For Models 7300/7400/7500

**FLTH737475**

OEM Part Number:  
3593649C2, 3537839C1



- Set forward axle
- Square headlights
- 2003-2007

# Kenworth T2000

## PARTS

- Hood
- Lights
- Bumper



## QUESTIONS:

Is the OEM part number listed below? If yes, please continue with Fleetrите hood number listed. If not, please answer these questions:

1. What is the make, model and year?
2. What is the length of the hood? Measured straight down the center to the grille opening (as pictured below).
3. If length is 61 1/2" and year is 1999-2010, you need **FLTHKENT2000**

## BUMPERS (2005-2016) \*see next page for 1996-2004

### FLTBT2000P5

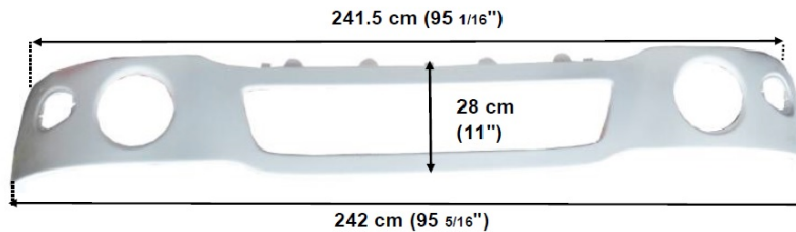

### Left Air Dam FLTBT2000LP5

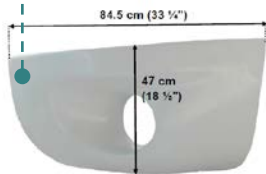

### Center FLTBT2000CP5

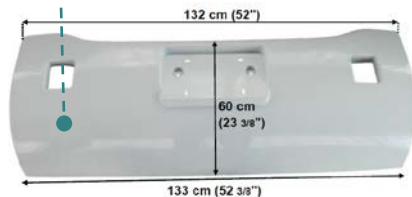

### Right Air Dam FLTBT2000RP5

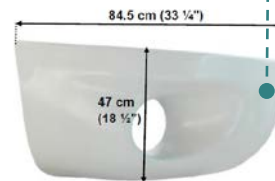

## HOODS

OE Design, 61.5"  
(1999-2010)

### FLTHKENT2000

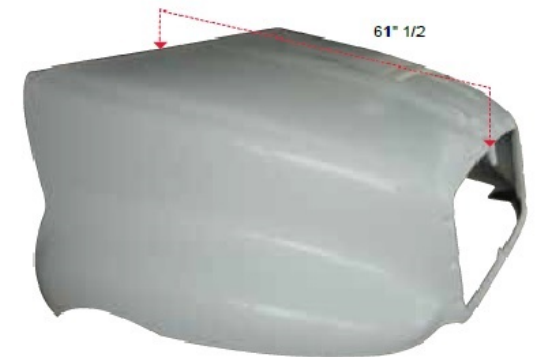

- Hood is separate from bumper
- 1999 to 2010

LIGHTS (1998-2010)

Left Headlight

**FLHLKWT2000L**

OEM Part Number: P54-1056-2



Right Headlight

**FLHLKWT2000R**

OEM Part Number: P54-1056-2R



BUMPERS (1996-2004)

Fiberglass

**FLTBT2000P**

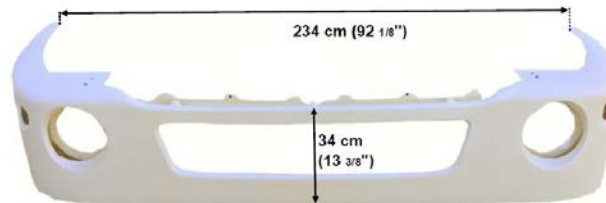

- *Lightweight aerodynamic design*

Right Air Dam

**FLTBT2000RP**



Left Air Dam

**FLTBT2000LP**



**YOUR FIRST CHOICE FOR ALL-MAKES PARTS**

# Kenworth T800

PARTS  
Hood  
Bumper



## QUESTIONS:

Is the OEM part number listed below? If yes, please continue with Fleetrite hood number listed. If not, please answer these questions

What is the make, model and year?

1. What is the length of the hood? Measured straight down the center to the grille opening
2. Is the windshield flat or curved?
  - a. Curved windshields: see below
  - b. Flat windshields: see next page
3. Does the hood have external air breathers?
4. Does the hood have full or short fenders?
5. How many bolt holes for the hinge mounting?

Additionally: Request a picture of the inside of the hood to differentiate inner reinforcements (see images below)

**Use the information gathered above to select the appropriate part from the specifications below**

## HOODS (for curved windshield)

60" (1996-2007)

### FLTHKENT800CW

OEM Part Number:  
K1461326, K1461295,  
K1461325

\*For 120 BBC only  
\*Will not fit hood with  
external air breather

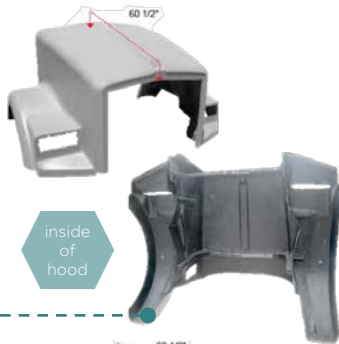

53" (1996-2007)

### FLTHKENT800S

OEM Part Number:  
K1461328, K1461329,  
L22910081033

\*For 112" BBC only  
\*3 bolt holes for hinge



60" with Plastic  
(1996-2007)

### FLTHKENT800CWP

OEM Part Number:  
L2911021220000,  
L2911771210000

**\*Metton replacement hood**  
\*For 120 BBC only

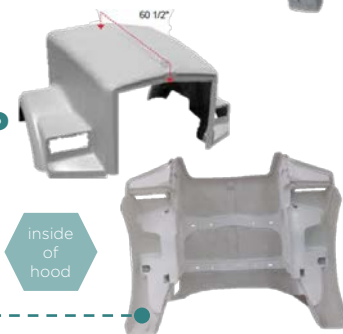

60.5" with Short Fenders  
(1996-2007)

### FLTHKENT800SF

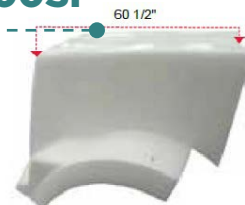

60.5" with External Air  
Breathers (1996-2016)

### FLTHKENT800CWF

OEM Part Number:  
K1461306, K1461307

\*3 bolt holes for hinge  
\*Fender extension has  
notch for breather



60.5" with External  
Air Breathers  
(2010-2016)

### FLTHKENT800FP

OEM Part Number:  
L29-11771210000SPL

**\*Metton replacement hood**  
\*5 bolt holes for hinge





**HOODS** (for flat windshield)

64" (1987-2007)  
**FLTHKENT800FW**  
 OEM Part Number:  
 K1461031, K1461052

\*Will not fit wide hood with single head lamp  
 \*Will not fit high hood

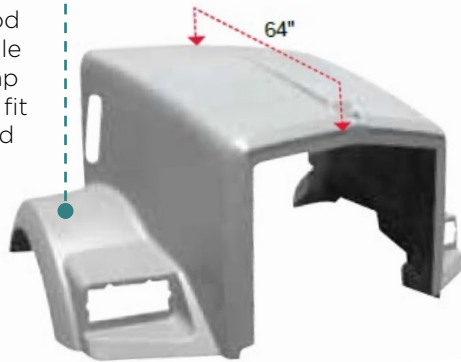

64" with External Air Breathers  
**FLTHKENT800FWF**  
 OEM Part Number:  
 K1461062, K1461074

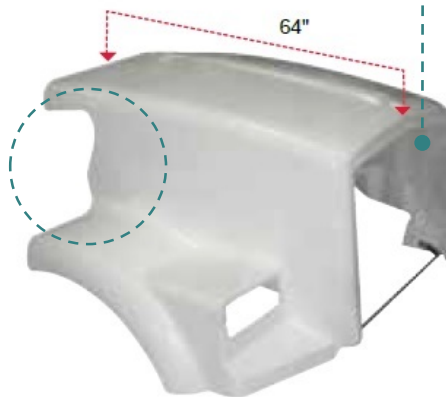

Confirm fit prior to painting, painted parts cannot be returned

**BUMPERS**

Right Extension without Fog Light (1998-2004)

**FLTBT800RP**



Left Extension without Fog Light (1998-2004)

**FLTBT800LP**



Center (1998-2007)  
 Aluminum: **FLTBT800A**  
 Steel: **FLTBT800CP**



Fiberglass with Fog Light (1987 and up)

**FLTBT800P**



Fiberglass without Fog Light (1987 and up)

**FLTBT800NLP**



# Kenworth W900

PARTS  
Hood  
Bumper



## QUESTIONS:

Is the OEM part number listed below? If yes, please continue with Fleetrите hood number listed. If not, please answer these questions:

1. What is the make, model and year?
2. What is the length of the hood? Measured straight down the center to the grille opening (as pictured below).
3. Is the windshield curved or flat?
  1. If flat → Length of hood should be 71" and the part you need is **FLTHKENW900LF**
  2. If curved → Length of hood should be 66"
    - If the original hood is from 1994-2002 and is made of regular fiberglass, the part you need is **FLTHKENW900LC**
    - If the original hood is from 2002 and up and is made of plastic, the part you need is **FLTHKENW900LCP**

## HOODS

### For Flat Windshield

71", Dual Breather  
Cutouts (1994-2016)  
**FLTHKENW900LF**  
OEM Part Number:  
K146-1138, K146-1135



### For Curved Windshield

66" (1994-2002)  
**FLTHKENW900LC**  
OEM Part Number: K146-1326  
66" (2002-2016)  
**FLTHKENW900LCP**  
OEM Part Number: L29-010002



## BUMPERS

Rectangular with Lights, 18.25"

### **FLTBW900S**

OEM Part Number: MA0510210-06



Note: Confirm fit prior to painting.  
Painted parts cannot be returned.

# Kenworth T660

PARTS  
Hood  
Grille  
Bumper



## QUESTIONS:

Is the OEM part number listed below? If yes, please continue with Fleetrite hood number listed. If not, please answer these questions:

1. What is the make, model and year?
2. What is the length of the hood? Measured straight down the center to the grille opening (as pictured below).
3. If length is 61 1/2" and year is 2008 and up, you need **FLTHKENT660**

## HOODS (2008 and up)

60", Modified Design  
**FLTHKENT660**  
OEM Part Number:  
K016QC



## BUMPERS (2008 and up)

Fiberglass, Left  
**FLTBT660LP**

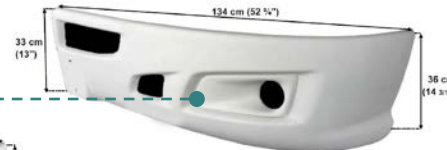

Fiberglass, Right  
**FLTBT660RP**

Mesh  
**FLTBT660M**

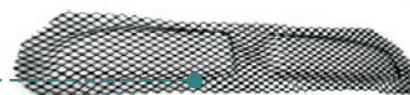

Bumper Support  
**FLTBT660H**

## GRILLES (2008 and up)

Full Assembly  
**FLTGKWFA**



Surround Only  
**FLTGKWSO**

# Kenworth T600

PARTS  
Hood  
Bumper



## QUESTIONS:

Is the OEM part number listed below? If yes, please continue with Fleetrite hood number listed. If not, please answer these questions:

1. What is the make, model and year?
2. What is the length of the hood? Measured straight down the center to the grille opening (as pictured below). Length should be 59".
3. Are the hood and fenders in one piece?
  - Yes: **FLTHKENT600D**
  - No: **FLTHKENT600**

## HOODS (1995-2016)

59", Aero 3 Piece

**FLTHKENT600**

OEM Part Number:  
K1461231

- 1995 and up
- Bolted Fenders



59", Aero Hood

**FLTHKENT600D**

- 1995 and up
- Short fender with light behind fender
- All 1 piece



## BUMPERS (1986-2016)

Plastic

**FLTBT600P**

OEM Part Number:  
K064-1468



Bumper Hardware  
**FLTBT600H**

# Kenworth T300

PARTS  
Hood  
Bumper



## QUESTIONS:

Is the OEM part number listed below? If yes, please continue with Fleetrите hood number listed. If not, please answer these questions:

1. What is the make, model and year?
2. What is the length of the hood? Measured straight down the center to the grille opening (as pictured below).
3. Does truck have a curved or flat windshield? If flat, our hood will not fit.
4. If length is 44", windshield is curved, and year is 1994-2009, you need **FLTHKENT300**

## HOODS (1994-2009)

44" for Curved Windshield

**FLTHKENT300**

OEM Part Number: K1461175

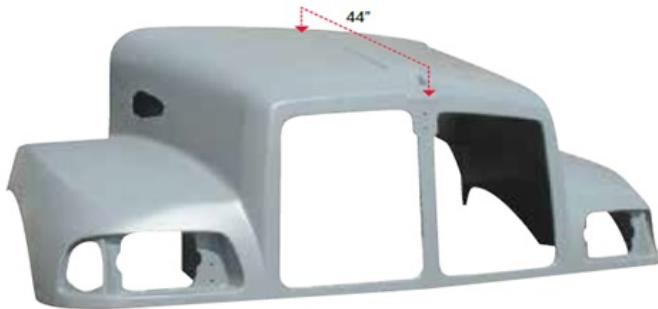

- Does not fit T370 with teardrop lights

## BUMPERS (1994-2009)

Center, Metal  
**FLTBT300S**



Left Extension  
**FLTBT300SL**

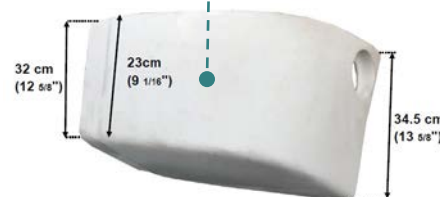

Right Extension  
**FLTBT300SR**

# Peterbilt 379

PARTS  
Hood  
Grille  
Bumper



## QUESTIONS:

Is the OEM part number listed below? If yes, please continue with Fleetrite hood number listed. If not, please answer these questions:

1. What is the make, model and year?
2. What is the length of the hood? Measured straight down the center to the grille opening (as pictured below).

## HOODS

Extended

62" without Grille

**FLTHPBL**

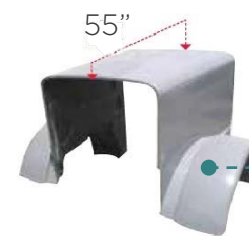
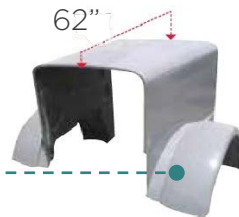

Short

55" without Grille

**FLTHPBS**

68" with Grille, Fiberglass

**FLTHPBLG**

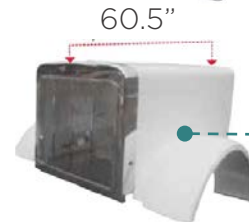
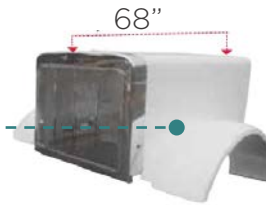

60.5" with Grille, Fiberglass

**FLTHPBSG**

68" with Grille, Aluminum with  
Fiberglass Fenders

**FLTHPBLWG**

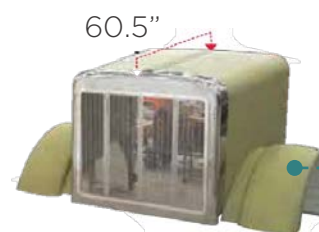
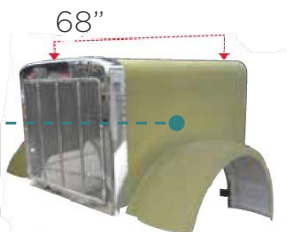

60.5" with Grille, Aluminum with  
Fiberglass Fenders

**FLTHPBSWG**

BUMPERS

16 Box Without Holes  
**FLTBPB16N**



18 3/16 Bumper Without Holes  
**FLTBPB379**



18 3/16 Box Without Holes  
**FLTBPB18N**



18 3/16 Bumper Box With Holes  
**FLTBPB18W**



20 3/16 Box Without Holes  
**FLTBPB20N**



GRILLES

Short  
**FLTGPBSG**



Extended  
**FLTGPBLG**

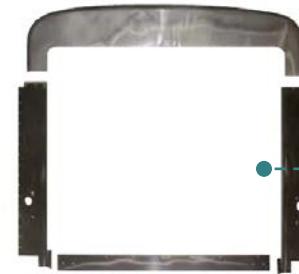

Trim Set, Stainless Steel  
Extended  
**FLTGPBLS**

Short  
**FLTGPBSS**

Set of 2 Pieces  
Short  
**FLTGPBBS2**



Extended  
**FLTGPBBLG**

25 pieces



Kit of Bolts  
**FLTGPBBOLT**

85 pieces

- Polished stainless to replace huck rivets

# Volvo VNL

## PARTS

- Hood
- Grille
- Lights
- Bumper



## QUESTIONS:

Is the OEM part number listed below? If yes, please continue with Fleetrите hood number listed. If not, please answer these questions:

1. What is the make, model and year
2. What is the length of the hood? Measured straight down the center to the grille opening (as pictured below).
  - If length is shorter than 56", it is a medium duty truck, not a VNL truck
  - If length is 55 3/4" or 56", it is a VNL truck
3. If the year is 2003 and up, and the length is 56", you need **FLTHVVNL3G**
4. If the year is earlier than 2003, and the length is 55 3/4", you need **FLTHVVNL**

## HOODS

VNL  
(1998-2002)  
**FLTHVVNL**

OEM Part Number:  
20377848,  
20377850

- 1998-2002
- Rectangular breather on right side



- 2003 and up
- Modified design

VNL 3<sup>rd</sup>  
Generation  
(2003 and up)  
**FLTHVVNL3G**

## BUMPERS

One Piece Fiberglass  
**FLTBVNL**

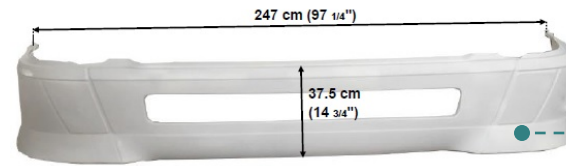
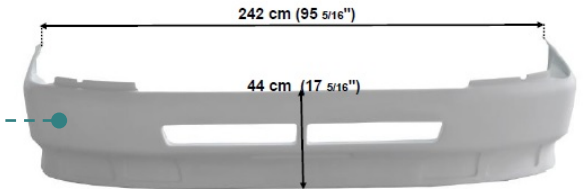

3<sup>rd</sup> Generation  
(2003-2016)  
**FLTBVNL3P**



### Note:

To confirm whether or not the truck is 3<sup>rd</sup> generation, look at the side air intake: If it has the shape of a boomerang or hockey stick, it is a VNL 3G



## GRILLES

Chrome  
(1996-2003)  
**FLTG VNLAC**  
OEM Part Number:  
8084221



Grille Hardware  
**FLTGHVNLAC**



Black & Chrome  
(2004 and up)  
**FLTG VNLBC**  
OEM Part Number:  
20505759

Black & Chrome  
Grille Hardware  
**FLTGHVNLBC**

## LIGHTS

Left Headlight  
(2004-2012)  
**FLTHLVNSL**  
OEM Part Number:  
82329124



Right Headlight  
(2004-2012)  
**FLTHLVNSR**  
OEM Part Number:  
82329127



**FITS YOUR NEEDS,  
TODAY AND  
TOMORROW.**

# Mack CX

## PARTS

Hood

Grille



## QUESTIONS:

Is the OEM part number listed below? If yes, please continue with Fleetrite hood number listed. If not, please answer these questions:

1. What is the make, model and year?
2. What is the length of the hood? Measured straight down the center to the grille opening (as pictured below).

→ If length is 56", you need **FLTHMKCX**

## HOODS (2002-2016)

SBA with Modified Design

**FLTHMKCX**



## GRILLES (2002 and up)

Chrome  
**FLTGMCX**

OEM Part Number:  
MF-580-M

Grille Hardware  
**FLTGHMCK**



**GREATER  
UPTIME  
MEANS  
FLEETRITE  
FIRST.**

# Mack RD

PARTS  
Hood



## QUESTIONS:

Is the OEM part number listed below? If yes, please continue with Fleetrite hood number listed. If not, please answer these questions:

1. What is the make, model and year?
2. What is the length of the hood? Measured straight down the center to the grille opening (as pictured below).
3. What is the length of the fender? (Measured as shown below)

→ If hood length is 57 1/2" and fenders are 13", you need **FLTHLMRDSF**  
 → If hood length is 57 1/2" and fenders are 17", you need **FLTHLMRDLF**

## HOODS (1989 and up)

Hood, Short Fender

**FLTHLMRDSF**

OEM Part Number:  
1QM5780, 1QM5832,  
1QM5835, 25119055,  
25136569, 25136352



- Fender of 13"
- Set Forward Axle
- If year is 1994 and up, you will need to cut out notch in left fender

Hood, Long Fender

**FLTHLMRDLF**

OEM Part Number:  
1QM-5780-1A

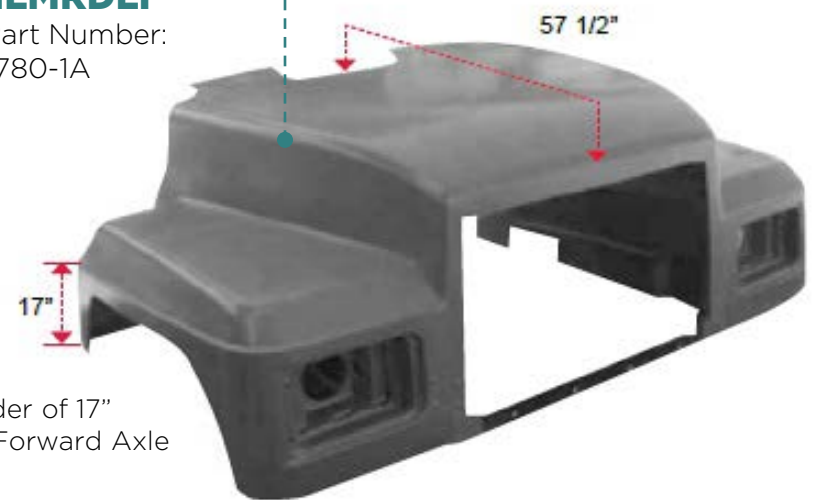

- Fender of 17"
- Set Forward Axle

## IC Bus



### GLASS

- 1 Piece Shaded Windshield  
**FLTDW016450PK1** (1 Pack)  
**FLTDW016450PK4** (4 Pack)



- 1 Piece Tinted Windshield  
**FLTDW01645PK1** (1 Pack)  
**FLTDW01645PK4** (1 Pack)



IC Bus is a Registered Trademark of Navistar, Inc.  
 Bus photo is for model identification purposes only.

## Blue Bird Bus



### LIGHTS

- Left Headlight  
**FLTHLBBL**  
 OEM Part Number:  
 0093659,  
 1623714,  
 8080014,  
 8082040



- Right Headlight  
**FLTHLBBR**  
 OEM Part Number:  
 0093660,  
 1623715,  
 8080015,  
 8082041



Blue Bird is a Registered Trademark of  
 Bus photo is for model identification purposes only.

## Thomas Bus C2



### GLASS

- 1 Piece, Encapsulated,  
 Asymmetrical, 6" Shade Bank  
 Windshield  
**FLTDW01752PK1** (1 Pack)  
**FLTDW01752PK4** (4 Pack)



Thomas Built Buses is a Registered Trademark of Daimler  
 Bus photo is for model identification purposes only.

