



Nice Choice. With thousands of cooking shows under our belts and countless products and recipes tested, we know how to create great stuff for the kitchen. Your instincts were right. This one's a keeper.

For ideas and inspiration, watch Food Network and visit us at FoodNetwork.com.
 Shop kohls.com/foodnetwork for more great products.

* Blender is not available in stores or online



12-cup food processor

instruction and recipe booklet

STYLE #219303

All recipes contained herein are provided courtesy
of Television Food Network G.P. and shall not be
reprinted, copied or redistributed without the prior
written consent of Television Food Network, G.P.
© 2008 Television Food Network G.P.
All rights reserved.

Food Network and the Food Network logo are service marks
or trademarks of Television Food Network, G.P.
© 2008 Television Food Network, G.P. All rights reserved.
Distributed by Kohl's Department Stores, Menomonee Falls, WI 53051
Made in China • RN #73277

[Shop kohls.com/foodnetwork](http://Shop.kohls.com/foodnetwork) for more great products.

apple pie

Dough:

- 2½ cups all-purpose flour
- ¼ cup sugar
- ¾ teaspoon fine salt
- ¼ cup shortening
- ½ cup cold unsalted butter, cubed
- 1 large egg
- ¼ cup very cold water

Filling:

- 1 lemon, zest finely grated and juiced
- 3 pounds baking apples
- ⅔ cup sugar, plus more for top
- ¼ teaspoon ground cinnamon
- Generous pinch of freshly grated nutmeg
- ¼ cup unsalted butter
- ½ teaspoon pure vanilla
- 2 to 3 tablespoons all-purpose flour
- 1 large egg, beaten



Dough:

1. Pulse flour, sugar and salt in food processor. Add shortening and butter and pulse until it resembles lumpy cornmeal. Beat egg and water together, add and pulse 2 to 3 times. Remove blade and bring dough together by hand. Divide into 2 discs. Wrap in plastic wrap; refrigerate 1 hour.

Filling:

1. Put lemon zest and juice in a large bowl. Peel, core and cut apples into eighths. Toss with lemon, sugar, cinnamon and nutmeg. Melt butter in skillet over high heat. Cook apples, stirring, until sugar dissolves, about 2 minutes. Cover, reduce heat to medium, and cook until apples are soft and juicy, 10-15 minutes. Add vanilla, sprinkle flour over fruit and mix. Cool.
2. Roll dough discs on a lightly floured workspace into two 12-inch circles. Layer between parchment paper and; refrigerate 15 minutes.
3. Heat oven to 425°F. Line 9-inch pie pan with dough leave in about a ½-inch of the crust over the edge. Mound filling slightly in center. Brush rim with some egg. Place other dough on top, trim as needed. Fold top dough under edge of bottom crust; press and flute to seal. Refrigerate 20 minutes.
4. Brush pie with egg, sprinkle with sugar and cut 6 slits in top. Bake on baking sheet for 15 minutes; reduce temperature to 375°F. Bake until golden brown, 50 minutes more. Serve.

Makes 8 servings.

little cheesecakes with strawberry sauce

Cheesecakes:

- 10 chocolate graham crackers, broken
- ¼ cup semisweet chocolate chips
- 3 tablespoons unsalted butter, melted
- 1 pound cream cheese, softened
- ¾ cup sugar
- 2 large eggs, room temperature
- 2 teaspoons pure vanilla
- 1 teaspoon grated orange zest

Sauce:

- 1 cup frozen strawberries, thawed
- 2 tablespoons sugar



Cheesecakes:

1. Preheat the oven to 325°F. Process the graham crackers and chocolate chips in a food processor until finely ground. Add the butter and pulse until the mixture is sandy and moist. Divide mixture evenly among 6 jumbo muffin cups, then press it evenly over the bottoms and about two-thirds of the way up the sides. Bake just until crusts are set, about 8 minutes.
2. In a clean food processor bowl, pulse the cream cheese, sugar, eggs, vanilla and orange zest until smooth. Divide the filling evenly among the muffin cups and bake until the rims are slightly puffed and the centers are almost set, about 30 minutes. Cool the cheesecakes in the cups on a rack, then refrigerate, uncovered, for at least 2 hours.

Sauce:

1. While cheesecakes are baking puree the strawberries with the sugar in a food processor or blender.
2. When you are ready to serve, run a small knife around the outside of the cheesecakes. Then use the knife to gently lift them from their molds. Transfer cheesecakes to dessert plates, spoon some sauce over each and serve.

Makes 6 servings.

important safeguards

When using electrical appliances, basic safety precautions should always be followed, including:

1. Read all instructions.
2. To protect against risk of electrical shock, do not put base, cord, or plug in water or other liquid.
3. Close supervision is necessary when any appliance is used by or near children.
4. Turn unit off and unplug from outlet when not in use, before putting on or taking off parts, and before cleaning. To disconnect, turn unit off, grasp plug, and pull out from wall outlet. Never yank on cord.
5. Avoid contacting moving parts. Keep fingers out of discharge opening.
6. Do not operate any appliance with a damaged cord or plug or after the appliance malfunctions or has been damaged in any manner.
7. The use of attachments not recommended or sold by the appliance manufacturer may cause fire, electric shock, or injury.
8. Do not use outdoors.
9. Do not let cord hang over edge of table or counter or touch hot surfaces.
10. Keep hands and utensils away from moving blades or disks while processing food to prevent the possibility of severe personal injury or damage to the food processor. A scraper may be used but only when the food processor is not running.
11. Blades are sharp. Handle carefully.
12. Be sure to insert or remove chopping blade and slice/shred disk by using hubs to avoid injury.
13. To avoid injury, never place chopping blade or slice/shred disk on base without first putting bowl properly in place. Make sure motor, disk, and/or chopping blade have stopped completely before removing cover.
14. Be certain cover is securely locked in place before operating appliance.
15. Never feed food into chute by hand. Always use the food pusher.
16. Do not operate this appliance in the presence of explosive and/or flammable fumes.
17. This appliance is intended for household use only, not for commercial or industrial use. Use for anything other than intended will void the warranty.

18. Do not attempt to defeat the cover interlock mechanism.
19. Do not leave the appliance unattended while it is running.

SAVE THESE INSTRUCTIONS.

almond snowball cookies

- 3/4 cup sliced almonds**
- 3/4 cup sugar**
- 3/4 cup unsalted butter, sliced and softened**
- 1/2 teaspoon pure vanilla**
- 1/8 teaspoon almond extract**
- 1 2/3 cups all-purpose flour**
- 1/2 teaspoon salt**
- 1 cup confectioners' sugar**



1. Pulse almonds and sugar in food processor until very fine. Add butter and process until smooth, 1 minute. Add vanilla and almond extract and pulse to combine. Pulse in flour and salt to make a soft dough. Turn out onto a large piece of waxed paper and roll into a 15 x 1 1/2 inch long log. Wrap and refrigerate 30 minutes.
2. Heat oven to 325°F. Line baking sheet with parchment paper. Cut dough into 1/2-inch pieces and roll by hand into balls. Space cookies evenly on baking sheets and bake until slightly golden, rotating pan once, 15 to 20 minutes. Put confectioners' sugar in a pie plate. Briefly cool cookies on a rack, then gently toss in confectioners' sugar until evenly coated. Cool on rack. Toss again in confectioners' sugar. Serve.

Makes 30 cookies.

walnut crumb topping

This all-purpose crumb topping is great over pies, muffins, crumbles and crisps. It's great to have a batch in the freezer to make impromptu desserts.

- 1 3/4 cups all-purpose flour**
- 3/4 cup sugar**
- 1/2 cup walnut pieces**
- 1 1/2 teaspoons ground cinnamon**
- 3/4 teaspoon ground allspice**
- Generous pinch of freshly grated nutmeg**
- 1/4 teaspoon fine salt**
- 10 tablespoons unsalted butter, melted**
- 1 1/2 teaspoons pure vanilla**

1. Pulse the flour with sugar, pecans, spices, and salt in the bowl of the food processor. With the motor running, drizzle butter and vanilla through the feed tube until mixture is moist. Remove blade, then squeeze mixture to make crumbs. Some should be large, some small. Use as desired.

Makes 3 cups.

chocolate fondue or frosting

This simple chocolate mix is great for dipping fruit or cookies when warm. Let it cool and then whip it up into an easy frosting.

6-oz. bittersweet or semisweet chocolate
¼ cup heavy cream

1. Break up the chocolate into pieces. Put in the processor and chop with the S-blade.
2. Heat the cream in a microwave-safe bowl or glass measuring cup. (Microwave 75% power until hot.) Pour the hot cream into the chocolate and process until smooth.

Makes 4 cups.

caramel-fudge sauce

4 ounces good quality bittersweet chocolate, broken in pieces
½ cup sugar
2 tablespoons light or dark corn syrup
2 tablespoons water
¾ cup heavy cream
4 tablespoons unsalted butter
1 teaspoon pure vanilla
Pinch salt

1. Finely chop chocolate up in processor with S-blade.
2. Combine sugar, corn syrup and water in medium saucepan. Cook over medium-high heat swirling the pan, but not stirring, until the sugar is amber in color, about 8 minutes. Pull pan from the heat and carefully whisk in the cream, butter, vanilla and salt. (Take care; it may spatter.)
3. With the processor running, pour the warm caramel into the chocolate and process until smooth. Serve sauce warm, or store in a sealed container in the refrigerator for up to 1 week. Reheat slowly.

Makes 1 cup.



other consumer safety information

This appliance is intended for indoor household use only.

Bottom Cover

To reduce the risk of fire and electric shock, do not attempt to remove the bottom cover. There are no user serviceable parts inside. Repair should be done only by authorized service personnel.

Before First Use

When unpacking the product and removing packing material, handle the chopping blade, and slice/shred disk carefully; they are very sharp.

Wash all parts except the base in warm, soapy water. Rinse them dry. These parts can also be placed in the dishwasher. Be sure to read this Recipe and Instruction Booklet, paying special attention to the sections on “Use” and “Care and Cleaning” to learn the correct methods for taking the unit apart and cleaning.

Short Power Supply Cord Information

A short power supply cord is provided to reduce the risk of becoming entangled in or tripping over a long cord. Extension cords may be used if care is exercised in their use. If an extension cord is used, the marked electrical rating of the extension cord should be at least as great as the electrical rating of the appliance. The cord should be arranged so that it will not drape over the countertop or tabletop where it can be pulled on by children or tripped over unintentionally. If the appliance is of the grounded type, the extension cord should be a grounding-type 3-wire cord.

Grounding Instructions

This appliance must be grounded while in use to protect the operator from electrical shock. The appliance is equipped with a 3-conductor cord and a 3-prong grounding-type plug to fit the proper grounding-type receptacle. The appliance has a plug that looks like sketch A. An adaptor, sketch B, should be used for connecting sketch A-type plug to two-ground receptacles. The grounding tab, which extends from the adaptor, must be connected to a permanent ground such as a properly grounded outlet box as shown in sketch C, using a metal screw. Do not modify the plug in any way.

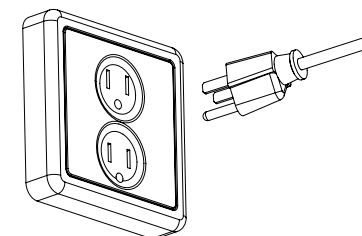

parts & features

1. Feed Tube Cover
2. Bowl Lid
3. Bowl
4. Center Post
5. Base
6. Control Panel
7. Storage Drawer
8. Drawer Handle
9. Food Pusher
10. Slice/Shred Disk
11. Thin Slice/Shred Disk
12. Blade Disk Stem
13. S-Blade

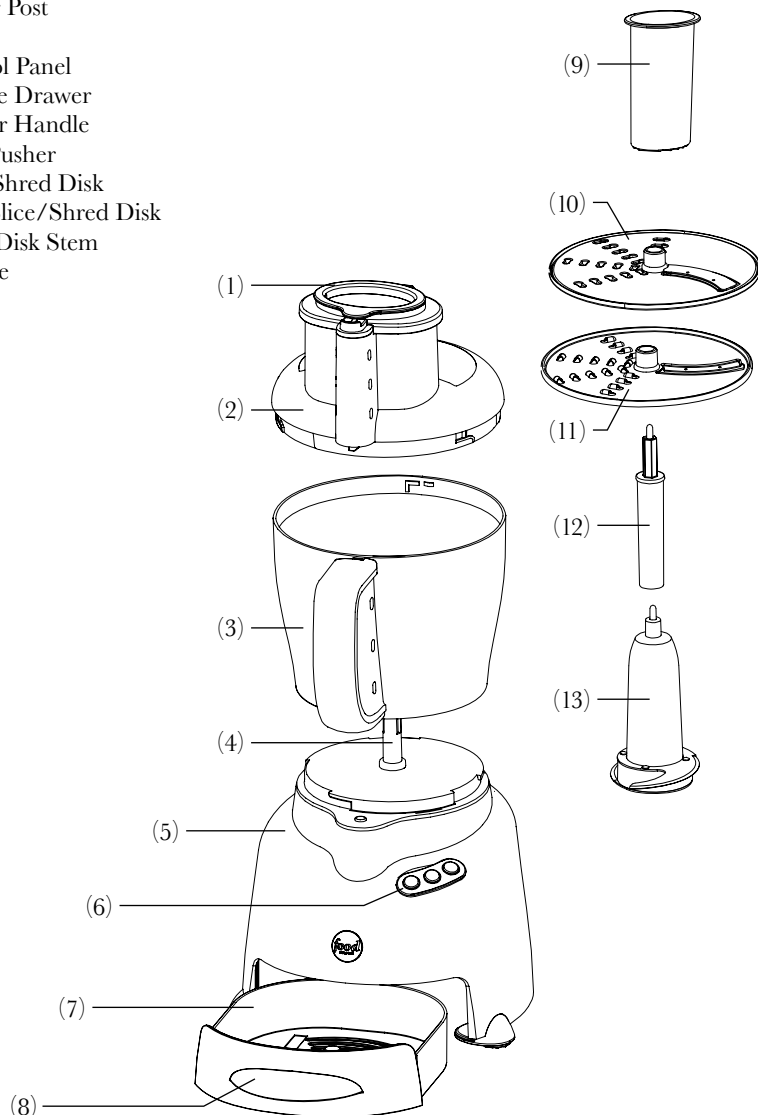

salmon burgers

- 1 ¼ pounds skinless salmon filets, very cold
- 1 large egg
- 1 shallot, minced
- 2 tablespoons chopped fresh flat-leaf parsley
- 1 tablespoon chopped fresh dill
- 2 teaspoons whole-grain mustard
- 2 teaspoons kosher salt, plus additional for grilling
- 1 teaspoon finely grated lemon zest
- Olive oil, for grilling
- Freshly ground black pepper, to taste
- 4 hamburger buns or English muffins, toasted
- Tomato slices, tartar sauce, mustard, or other condiments of your choice



1. Cut salmon into 1-inch cubes; freeze for 5 minutes. Process egg, shallot, parsley, dill, mustard, salt and lemon zest in processor until fairly smooth. Add half chilled salmon and pulse to make a chunky paste. Add remaining salmon and pulse 10 times to make a rough-textured mixture. Wet your hands with cool water and shape the mixture into 4 patties, each about ¾ inch thick. Place each patty on a square of waxed paper and refrigerate, lightly covered, for 30 minutes.
2. Heat a grill to medium-high heat. Brush patties with olive oil and season with salt and pepper. Pick each patty up by its paper and turn it oil-side down onto grill (the paper should peel right off). Cook without pressing, and don't move them until you see distinct grill marks, about 3 minutes. Brush lightly with olive oil and season with salt and pepper. Flip the patties and cook until burgers give just a bit when pressed, about 1 ½ minutes. Transfer the burgers to a platter, cover loosely with foil, and let rest for 2 minutes. Serve on buns with your favorite condiments.

Makes 4 servings.

pesto

- 2 cups fresh basil leaves, washed
- 2 cloves garlic, smashed
- ¼ cup pine nuts
- ½ cup extra-virgin olive oil
- ½ cup freshly grated Parmesan cheese
- ½ teaspoon kosher salt
- Freshly ground black pepper, to taste

1. Put basil, garlic and pine nuts in the bowl of the food processor. Pulse until coarsely chopped. With the food processor running, gradually add the olive oil and process until smooth. Transfer to a large bowl and stir in the cheese. Season with salt and some black pepper to taste.

Makes about 4 servings.

Cooks' Note: Instead of basil, try 1 cup each parsley and fresh spinach, 2 tablespoons fresh rosemary leaves, and 2 tablespoons fresh thyme. Substitute walnuts for pine nuts.

Cooks' Note: Instead of basil, try 1 cup each parsley and fresh spinach, 2 tablespoons fresh rosemary leaves, and 2 tablespoons fresh thyme. Substitute walnuts for pine nuts.

tuscan bean dip

- 1 small baguette, thinly sliced
- 4 cloves garlic
- 1½ teaspoons kosher salt, plus additional for seasoning
- 2 sprigs fresh rosemary
- ¼ cup extra-virgin olive oil
- Pinch crushed red pepper
- 1 15-ounce can cannellini beans, rinsed and drained
- Crisp vegetables, for dipping (optional)

1. Preheat oven to 400°F. Lay bread on a baking sheet. Rub each slice with a clove of garlic and sprinkle with a pinch of salt; reserve garlic clove. Toast bread in oven, about 8 minutes.
2. Chop garlic cloves. Strip leaves from rosemary and chop. Cook garlic in the olive oil in a small skillet over medium-high heat until golden, about 3 minutes. Pull from heat, stir in rosemary and red pepper and cool slightly.
3. Puree beans, 1½ teaspoons salt, and all but a teaspoon of the rosemary oil in processor until smooth. Transfer to bowl and drizzle with rosemary oil. Serve with toasts and, if desired, raw vegetables.

Makes about 4 servings.

spring garden potato salad

- 2 pounds small red-skinned potatoes
- 5 medium carrots, peeled
- 1 bunch (about 8) radishes
- ⅔ cup dry white vermouth
- 3 cloves garlic, smashed
- Kosher salt, plus additional 2 ½ teaspoons for seasoning
- 1 sprig fresh thyme
- 1 bay leaf
- ½ English cucumber
- 1 cup grape or cherry tomatoes, halved
- 3 scallions (white and green parts), thinly sliced
- ½ cup mayonnaise
- 2½ tablespoons white wine vinegar
- ⅓ cup minced mixed herbs, such as fresh parsley, dill or tarragon
- Freshly ground black pepper, to taste

1. Use the slicing blade to thinly slice potatoes. Repeat with carrots, then radishes. Keep each vegetable separate.
2. Put 8 cups water, vermouth, garlic, salt, thyme, bay leaf, and potatoes in a large saucepan and bring to a boil. Add carrots, reduce heat, and cook until vegetables are tender, but not mushy, 5 minutes. Stir in radishes, then drain vegetables in a colander in sink. Remove and discard the garlic, thyme and bay leaf. Cool.
3. Slice cucumber. Toss salad with cucumber, tomatoes and scallions. Fold herbs into salad. Whisk mayonnaise and vinegar together and fold into salad. Season with 2 ½ teaspoons kosher salt and pepper to taste. Serve.

Makes 8 servings.



Control Panel

Off:

To turn unit off, press OFF button. No lights should then be lit on control panel.

On:

When the ON button is pressed, the indicator will glow. Unit will run continuously until OFF button is pressed.

Pulse:

Press and hold PULSE button for bursts of power. The light on PULSE will glow when button is held down and when released the light will go out.

Note: Do not attempt to chop ice in this food processor; it will damage container and dull the chopping blade. This unit will not whip cream, beat egg whites to a desirable volume, grind coffee beans or spices with high oil content, or slice or shred hard-cooked eggs, marshmallows, or soft cheeses.

IMPORTANT: For your protection, this unit has an interlock system. The processor won't operate unless the bowl is properly locked onto base and cover is properly locked onto the bowl, be sure to attach the bowl to the base before attaching the food chute lid on the bowl lid, bowl lid is also on the lock position. Do not attempt to operate the unit without the bowl lid, bowl and food chute lid being correctly in place. Be sure base is on a flat, dry and clean surface before you begin processing.

assembly & use

How to Assemble the Bowl

1. Align the base and bowl (Fig. 1), then align the bowl handle with the mark on the base, turn the bowl counterclockwise until it clicks into the base.
2. The bowl handle should be aligned with the mark on the base.

Note: There is only one position for the bowl to lock onto the base. The food processor will not operate unless the bowl is securely locked onto the base.

How to Lock the Cover

1. Open the food chute lid.
2. Place the cover onto the bowl, align the mark on the cover and the mark on the bowl.
3. Twist the cover counterclockwise towards LOCK until it clicks into the bowl, then the mark on the cover should be aligned with the mark on the bowl. (Fig. 2)

Note: When cover is locked into position, the safety mechanism on the cover and bowl will align with each other. The food processor will not operate unless the cover is securely locked onto the bowl.

How to Lock the Food Chute Lid

1. Grasp the removable loop, rotate the food chute lid to make the removable loop fit into the food chute. (Fig. 3)
2. Push down the removable loop into the food chute. (Fig. 4)
3. Push on the tab of removable loop to latch the food chute lid onto the food chute. (Fig. 5)

Note: The food processor will not operate unless the food chute lid is latched onto the food chute.

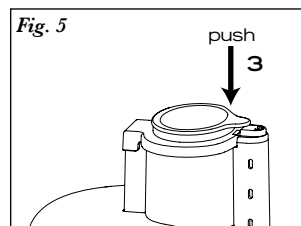
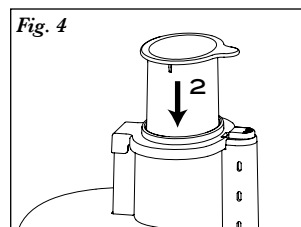
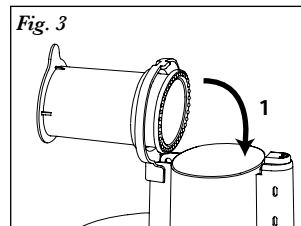
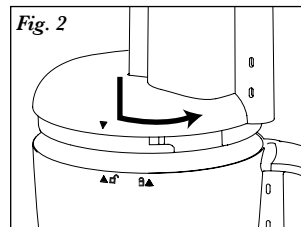
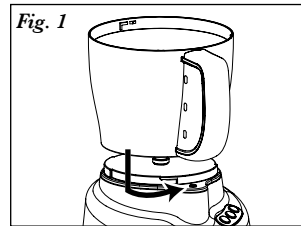

romesco sauce

This classic Spanish sauce is great with grilled shrimp, vegetables, pork or chicken.

- 1 small ancho chile, stemmed and seeded
- ¼ cup extra-virgin olive oil
- ¼ cup whole blanched almonds
- ½ medium onion, thinly sliced
- 2 cloves garlic, smashed
- 2 teaspoons kosher salt, plus additional for seasoning
- Freshly ground black pepper, to taste
- 2 teaspoons pimenton (Spanish paprika)
- ¾ cup roughly chopped jarred, drained piquillo or red peppers
- ½ slice stale white bread, roughly torn
- 2 tablespoons sherry vinegar

1. Toast chile in small dry skillet over medium-high heat, turning until fragrant, 1 minute. Soak chile in hot water until soft. Drain and chop.
2. Heat olive oil in a skillet over medium heat. Add almonds and cook, stirring, until toasted, 3 minutes. Transfer almonds to a plate, leaving oil in skillet. Add chile, onion, garlic, 2 teaspoons salt and pepper. Cook, stirring, until onions brown, 3 minutes. Add paprika and cook until fragrant, 1 minute. Pulse onion mixture, almonds, piquillo peppers, bread and vinegar in a food processor until coarse. Season with salt and pepper. Serve.

Makes about 2 cups.

potato gratin

- 1 large clove garlic, smashed
- 2 tablespoons unsalted butter
- 2¼ pounds (about 6) waxy potatoes, peeled
- 2 cups low-sodium chicken broth
- 2 teaspoons chopped fresh thyme
- 2½ teaspoons kosher salt
- Freshly ground black pepper, to pepper
- Pinch freshly grated nutmeg
- ½ to 1 cup grated cheese, such as Parmesan or cheddar

1. Heat oven to 350°F. Rub garlic all over the inside of a casserole. Smear some of the butter all over the inside of the dish. Mince what is left of the garlic.
2. Using the thin slice disk attachment of the processor, slice the potatoes. Transfer slices to a saucepan with garlic, remaining butter, broth, thyme, salt, pepper to taste, and nutmeg. Bring to a boil over medium-high heat and cook, stirring, until the mixture thickens slightly, 1 to 2 minutes. Transfer mixture to prepared pan and shake pan to distribute potatoes evenly. Bake, uncovered, occasionally spooning some of the liquid over the top, until the potatoes are fork-tender, about 50 minutes. Sprinkle the cheese over the top and bake until brown and bubbly, about 15 minutes more. Remove from the oven and set aside 10 minutes before serving.

Makes 6-8 servings.



crustless spinach & feta pies

Pies:

- 1 (10-ounce) package frozen spinach, thawed
- 1 tablespoon extra-virgin olive oil
- 4 scallions, thinly sliced
- 3 large eggs
- ¾ cup half-and-half
- 1 tablespoon plain bread crumbs
- 2 teaspoons crumbled dried mint
- 1¼ teaspoons kosher salt
- Freshly ground black pepper, to taste
- Pinch cayenne pepper
- Generous pinch of freshly grated nutmeg
- ⅓ cup crumbled feta cheese

Tomato Salad:

- 12 ounces mixed small tomatoes
- 2 to 3 pepperoncini, stemmed and chopped
- 2 tablespoons chopped kalamata olives
- 2 tablespoons extra-virgin olive oil
- 1 tablespoon freshly squeezed lemon juice
- ¼ teaspoon dried oregano
- Kosher salt and freshly ground black pepper, to taste

1. Pies: Heat oven to 400°F. Squeeze spinach dry. Heat olive oil in skillet over medium-high heat. Add spinach and scallions; cook, stirring, until very dry, 4 minutes. (Drain in colander, if needed.) Brush four 6 oz. ramekins with some olive oil and set on a baking sheet.
2. Put spinach mixture, eggs, half-and-half, bread crumbs, mint, salt, black and cayenne peppers, and nutmeg in a food processor and pulse until fine. Remove blade and stir in feta. Divide mixture evenly among ramekins. Bake until set around the edges but slightly soft in center, 20 minutes. Turn oven off, leaving pies to set, about 5 minutes more.
3. Toss salad ingredients together. Run a knife around each ramekin and invert onto plates. Serve with salad.

Makes 4 servings.

ham salad

- 1 small red onion, minced
- 1 pound cooked ham, cut into large pieces
- 2 ribs celery, quartered
- 6 cornichon or gherkin pickles
- 1 pickled jalapeño, seeded and stemmed
- 2 scallions (white and green parts), minced
- ⅓ cup mayonnaise
- 2 tablespoons Dijon mustard
- ¼ teaspoon freshly ground black pepper
- 1 bunch watercress, clean, stems trimmed
- 1 bunch arugula, clean, stems trimmed
- 8 slices sourdough bread, toasted

1. Soak onion in cold water for 10 minutes; drain, pat dry and put in large bowl. Pulse ham in food processor until chunky; add to onion. Pulse celery, pickles, and jalapeño in the processor until chopped; add to ham.
2. Add scallions to the ham mixture along with mayonnaise, mustard and pepper. Refrigerate, covered, until thoroughly chilled, about 1 hour.
3. Toss watercress and arugula together and divide among 4 plates. Top with ham salad and serve with the toasts.

Makes 4 servings.

Cook's Note: This is just the thing to make with leftover holiday ham. (We don't recommend deli ham as a stand-in.) Our favorite smoked ham is neither too salty nor watery. Better hams still have a bone and most of their skin intact.

How to Open the Food Chute Lid

Note: Before opening the food chute lid, turn the unit off and unplug the cord.

1. Pull up the movable loop and slide the release button out. (Fig. 6)
2. Pull back the food chute lid and movable loop. (Fig. 7)

How to Chop

Note: Make sure the unit is turned off and unplugged before use. Process the food into pieces about 1 inch (2.5cm) large in advance.

1. Lock the bowl onto base.
2. Grasp the chopping blade by its center shaft and slide it down onto the center post. (Fig. 8)
3. Place food into bowl and lock cover onto bowl.
4. Lock the food chute lid. Insert food pusher into removable loop.
5. Plug the cord into an electric outlet. Use the "Food Guide" (on pages 12-14) to prepare food for chopping.
6. Press PULSE to run unit (or press ON for continuous processing). When pulsing, hold the PULSE position for about 2-3 seconds, check result, repeat for desired consistency.
7. When finished processing, release from PULSE position, or if you were using continuous ON, press OFF, allowing the chopping blade to stop rotating.
8. Take out the food pusher, then open the food chute lid, twist the food chute/cover towards the unlock position to remove the cover.
9. Grasp the chopping blade by its shaft and remove. Unlock the bowl by turning it clockwise towards the UNLOCK and lift it off. Empty the processed food.

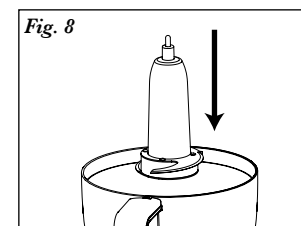
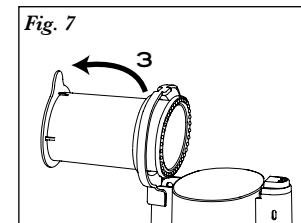
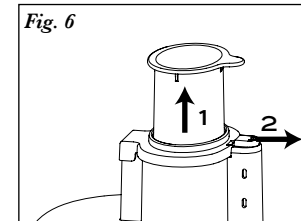

Note: Maximum dry capacity is 12 cups. Maximum liquid capacity is 3-4 cups.

How to Slice or Shred

Note: Make sure the unit is turned off and unplugged before use. Use food pusher when processing food – never use hand to push food directly. Let unit do the work, heavy pressure will not speed operation. Do not use the processor continuously for more than 3 minutes at a time. Allow a rest period of 5 minutes between working cycles.

Processing Large Food

1. Lock the bowl onto base. (see “How to Assemble the Bowl” on page 8.)
2. Slide the disk stem down onto the center post of the base, then grasp the slice/shred disk. With the desired side facing up for either slicing or shredding, push it down onto the disk stem. (Fig. 9)
3. Lock cover onto bowl.
4. Fill the food chute with a large piece of food. (Fig. 10) Lock the food chute lid. (See “How to Lock the Food Chute Lid” on page 10.) Use the “Food Guide” (on pages 12-14) to help you prepare food for slice/shred processing.
5. Slide the food pusher into the removable loop, plug the cord into an electric outlet.
6. Firmly press on the ON speed button, then press down lightly but firmly on food pusher. (Fig. 11)
7. When food chute is empty, press OFF, allow the disk to stop rotating, open the food chute lid. Twist the food chute/cover towards UNLOCK to remove the cover.

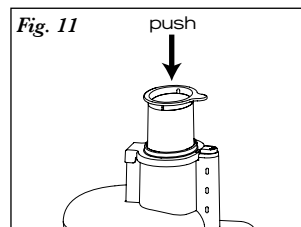
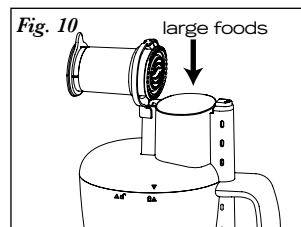
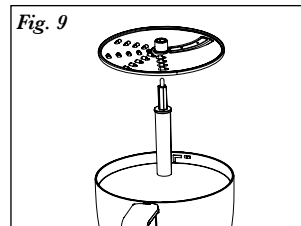

tomato ricotta pizzas

Dough:

- 1 cup tepid water
- 3 tablespoons extra-virgin olive oil, plus as needed
- 2 teaspoons sugar
- 1 ½ teaspoons kosher salt
- 3 cups all-purpose flour, plus as needed
- 2 ½ teaspoons (1 package) active dry yeast

Topping:

- 4 ripe (2 pounds) red tomatoes
- 3 cloves garlic, minced
- 2 tablespoons extra-virgin olive oil
- 2 teaspoons kosher salt
- Freshly ground black pepper, to taste
- 2 cups fresh ricotta cheese, room temperature
- 5 to 6 sprigs fresh basil, oregano, parsley or a mix, leaves stripped and torn



Dough:

1. Stir water, 3 tablespoons oil, sugar and salt in a liquid measuring cup to dissolve sugar. Pulse flour and yeast in a food processor. Add liquid, pulsing to make a rough dough. Pull dough together into a ball. Turn onto a work surface dusted with flour. Knead until smooth and elastic, 10 minutes. (Add a little flour if needed to prevent sticking.) Shape into a ball. Put in a lightly oiled bowl and turn to coat with oil. Cover with plastic wrap; rise at room temperature until double in size, about 1 hour. Punch dough down, knead briefly, shape into a ball, cover, and let rise until soft and puffy, about 45 minutes.

Topping:

1. Grate or slice tomatoes on large hole grater. (If very juicy, drain lightly in a strainer.) Add garlic and oil and season with salt and pepper.
2. Heat oven to 425°F. Divide dough in half and form one portion into a round. Brush pizza screen or crisper with oil, place round on top. Top with half of the tomato; bake until golden and crisp, about 15 minutes. Top with spoonfuls of cheese and a sprinkling of herbs. Serve. Repeat with remaining ingredients.

Makes two 12-inch pies.

chimichurri sauce

- 6 cloves garlic, sliced
- 2 shallots, sliced
- 2 cups packed fresh flat-leaf parsley
- ½ cup fresh oregano leaves
- 1 heaping tablespoon kosher salt
- 1 teaspoon crushed red pepper
- 1 cup extra-virgin olive oil
- ½ cup red wine vinegar
- ¼ cup water

1. Pulse the garlic, shallots, parsley, oregano, salt and red pepper in a food processor until roughly chopped.
2. Add the oil, vinegar and water and pulse to make a textured sauce. Transfer to a serving bowl.

Makes about 2 ½ cups.

confetti coleslaw

- 1 small head red cabbage
- 5 medium carrots
- 2 tablespoons kosher salt
- 3 tablespoons cider vinegar
- 3 tablespoons honey
- 2 tablespoons Dijon mustard
- 1 tablespoon celery seeds
- 4 teaspoons kosher salt
- Freshly ground black pepper, to taste
- 1/3 cup extra-virgin olive oil
- 2 Granny Smith apples
- 6 scallions (white and green parts), sliced
- 1 bunch watercress

1. Use the slicing blade of the food processor to cut the cabbage. Shred carrots with the large grater. Toss both with salt in colander; place in sink until vegetables wilt, 1 to 4 hours. Rinse mixture thoroughly in cold water; dry in a salad spinner.
2. Blend vinegar, honey, mustard, celery seeds, salts and pepper with S-blade in processor. Gradually drizzle in olive oil to make a smooth, slightly thick dressing.
3. Quarter, core and shred the apples. Toss cabbage mixture with apples, scallions and about 1/2 cup of the dressing. Refrigerate until chilled, about 1 hour. When ready to serve, toss watercress with remaining dressing. Add to slaw and serve.

Makes 6 servings.

cornmeal-buttermilk biscuits

- 1 1/3 cups all-purpose flour
- 2/3 cup yellow cornmeal
- 2 1/2 teaspoons baking powder
- 1 heaping teaspoon sugar
- 1 teaspoon fine salt
- 1/4 teaspoon baking soda
- 6 tablespoons cold unsalted butter, sliced into tablespoon-size pieces
- 3/4 cup buttermilk

1. Heat oven to 450°F. Pulse flour, cornmeal, baking powder, sugar, salt and baking soda in processor. Add 2 tablespoons butter and pulse until no visible pieces remain. Pulse in remaining 4 tablespoons butter just until they are in pea-size pieces. Lightly pulse in buttermilk to make a shaggy, loose dough.
2. Turn dough onto a lightly floured work surface and pat into a rectangle about 1/2 inch thick. (Don't worry if dough doesn't all come together.) Fold dough in thirds, like a business letter, and pat into an 8 x 5-inch rectangle—about 3/4 inch thick. Using a 2 to 3-inch round biscuit cutter, cut 6 biscuits and place on baking sheet. Press scraps together and cut 2 more biscuits. Bake until tops are lightly browned, about 15 minutes. Serve warm.

Makes 8 biscuits.



Processing Long and Thin Food

1. Lock the bowl onto base. (See “How to Assemble the Bowl” on page 8.)
2. Slide the disk stem down onto the center post of the base, then grasp the slice/shred disk. With the desired side facing up for either slicing or shredding, push it down onto the disk stem. (Fig. 12)
3. Lock cover onto bowl. (See “How to Lock the Cover” on page 8.)
4. Lock the food chute lid. (See “How to Lock the Food Chute Lid” on page 8.)
5. Fill the removable loop with long and thin food. Insert food pusher into removable loop. (Fig. 13)
6. Firmly press on the ON speed button, then press down lightly but firmly on food pusher.
7. When finished processing, press OFF, allow the disk to stop rotating, open the food chute lid. Twist the food chute/cover towards UNLOCK to remove the cover.

Note: Open the food chute lid first before locking or unlocking the cover.

Processing Liquids

1. Hot liquids (less than 140°F) and hot foods can be processed in the bowl.
2. Be sure to process small amounts of liquids – 2 cups or less at a time. Larger amounts may leak from the bowl.

Note: Maximum liquid capacity is 3 cups. Liquid cannot be filled over central pole of bowl or liquid will leak during operation.

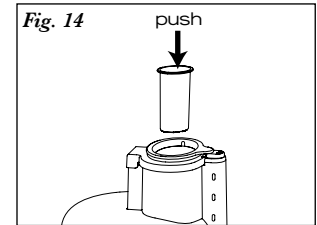
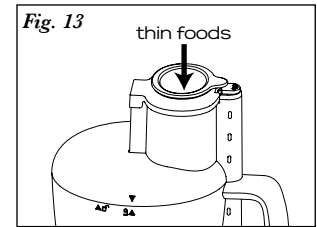
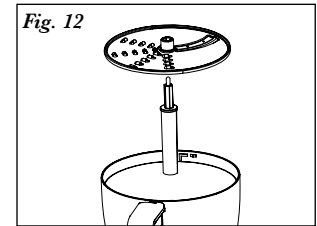



CHOPPING GUIDE		
Food	Amount	Directions
Baby Food	Up to 4 cups (1000ml)	Add up to 4 cups (1000ml) cooked vegetables and/or meat to bowl, along with 1/4 cup (60ml) liquid per cup of solid food, process continuously to desired fineness.
Bread Crumbs	Up to 5 slices	Cut either fresh or dry bread slices into 1 1/2-2" (3.75 & 5cm) pieces. Add to bowl and process to fine crumbs.
Cookie/Cracker Crumbs	Up to 5 cups (1250ml)	Use for crumbing graham crackers, chocolate or vanilla wafers. Break larger crackers into 1 1/2-2" (3.75 & 5cm) pieces. Add to bowl and process until fine.
Cranberries, Minced	3 cups (750ml)	Pulse to chop to desired fineness. Can also add sugar to make cranberry relish.
Eggs, Chopped	Up to 12	Peel, dry and halve hard-cooked eggs. Add to bowl. Pulse to chop, checking fineness after 4-5 pulses.
Garlic, Minced	Up to 12	Be sure bowl is dry. Drop clove(s) down food chute while unit is running.
Meat, Chopped (Raw Or Cooked)	Up to 3 cups (800g)	Cut the meat into 1" (2.54cm) cubes. Add to bowl and pulse to chop.
Mushrooms, Chopped	Up to 12 medium	Halve large ones and add to bowl. Pulse to desired fineness.
Nuts, Chopped	2 cups (300ml)	Add to bowl and pulse to chop.
Onions, Chopped	Up to 2 large	Quarter, and add to bowl. Pulse 1 or 2 times to coarsely chop. For green onions, up to 2 cups (500ml) cut into 1" (2.54cm) pieces.
Parmesan or Romano Cheese, Grated	Up to 1-1/2 cups (375ml)	Allow cheese to reach room temperature. Cut into 1" (2.54cm) cubes. Add to bowl and pulse to coarse chop; process continuously to finely grate.
Parsley, Chopped	Up to 2 cups (500ml)	Add to bowl and pulse to chop to desired fineness, about 10-15 seconds. Process other herbs in same manner (basil, cilantro, mint).
Pepper, Green, Red, Yellow Chopped	Up to 1 pepper	Cut into 1" (2.54cm) pieces. Add to bowl and pulse to chop.
Soups, Pureed Or Creamed	2 cups (500ml)	Add up to 2 cups hot (less than 140°F) vegetable soup for pureeing and creaming. Process to desired smoothness.

This food processor was designed for cooks, by cooks. We took all the features we loved from all the processors we've used over the years and put them together to make this one. We love it, and we hope you will too.

A food processor is invaluable to any serious cook. We use ours for everything from dips, salsas and salad dressings to pie crusts and granitas. This processor is your kitchen workhorse. It'll chop vegetables for soup, shred cabbage for coleslaw, mix up bread dough, and puree chickpeas into hummus. You can even use it for creamy sauces like mayonnaise or ranch dressing.

Some tips for food processor perfection:

- The feed tube on your processor is extra-wide, so you won't have to spend as much time pre-cutting food to fit.
- Your shredding disk will even shred cheese for pizza or quesadillas. Use the big-holed side for cheddar, jack or mozzarella; use the small-holed side for Parmesan. Chill soft cheeses in the freezer for about half an hour before putting them through the shredder.
- Save leftover bread and buzz it with the S-blade for instant homemade breadcrumbs. Add spices or fresh or dried herbs for a quick hit of flavor.
- Pitted olives, garlic and lemon juice make for a flavorful tapenade or quick bruchetta topping. Or add cheddar cheese, pimientos and mayonnaise for a super-quick pimiento cheese spread.
- When you're making a salad dressing, be sure to add the oil slowly, pulsing in between additions, so that it gets a chance to emulsify (become creamy). Chop up the flavor base (garlic, shallots, anchovies, whatever) first, then add your acid, then the oil.
- Add softened butter and flavorings (herbs, cheese, shallots or spices) to the bowl and process them together for a quick compound butter that'd be great on steaks or chops.
- Use your processor for instant summer classics from gazpacho to ceviche.
- And with a food processor, it's incredibly easy to make homemade pie dough and biscuits. The S-blade cuts butter into tiny bits; the pulse function keeps them cool. You'll have tender, flaky dough in no time.
- Or, use your processor for quick crumb crusts with graham crackers or even saltines. Even our cheesecake recipe on page 26 is a snap with a food processor.
- Or use it for glazes, frostings (from cream cheese to buttercream) or crumb toppings for crumbles, pies, or strudels.

The recipes on the next few pages will put you well on the way to food processor success.

warranty & customer service

What does your warranty cover? Any defect in material or workmanship.

For how long after the original purchase? Two years.

What will we do? Provide you with a new one.

How do you make a warranty claim?

- Save your receipt.
- Properly pack your unit. We recommend using the original carton and packing materials.
- Return the product to your nearest Kohl's store or call Customer Assistance at 1-877-342-4337 (1-877-34-CHEFS).

What is not covered by your warranty?

- Parts subject to wear, including, without limitation, glass parts, glass containers, cutter/strainer, blades, seals, gaskets, clutches, motor brushes, and/or agitators, etc.
- Commercial use or any other use not found in printed directions.
- Damage from misuse, abuse, or neglect, including failure to clean product regularly in accordance with manufacturer's instructions.

How does state law relate to this warranty?

- This warranty gives you specific legal rights, and you may also have other rights which vary from state to state or province to province.
- This warranty is in lieu of any other warranty or condition, whether express or implied, written or oral, including, without limitation, any statutory warranty or condition of merchantability or fitness for a particular purpose.
- Kohl's, Food Network and the product manufacturer expressly disclaim all responsibility for special, incidental and consequential damages or losses caused by use of this appliance. Any liability is expressly limited to an amount equal to the purchase price paid whether a claim, however instituted, is based on contract, indemnity, warranty, tort (including negligence), strict liability, or otherwise. Some states or provinces do not allow this exclusion or limitation of incidental or consequential losses so the foregoing disclaimer may not apply to you.

If you have a claim under this warranty, please call our Customer Assistance number. For faster service, please have the model, type and series numbers ready for the operator to assist you. These numbers can be found on the bottom of your appliance.

CHOPPING GUIDE (cont.)		
<i>Food</i>	<i>Amount</i>	<i>Directions</i>
Squash (Butternut), Pumpkin or Sweet Potatoes Pureed	Up to 5 cups (1250ml), 1" (2.54cm) cubes	Add 1/4 cup (60ml) of cooking liquid per cup of food. Pulse to finely chop then process continuously to puree.
Strawberries, Pureed	2 cups (500ml)	Hull and halve large berries. Add to bowl and pulse to chop. Process continuously to puree.
Tomatoes, Chopped	4 medium	Quarter tomatoes. Add up to 4 and pulse to desired size.

SLICING GUIDE	
<i>Food</i>	<i>Directions</i>
Apple	Halve and stack horizontally in chute. Use firm pressure.
Cabbage/Lettuce	Halve head, cut to fit chute.
Carrots	Cut to fit chute.
Celery	Remove string. Pack chute for best results.
Cucumber	Cut to fit chute if necessary.
Mushrooms	Stack chute with mushrooms on their sides for lengthwise slices.
Onions	Halve and fill chute, positioning onions upright for coarsely chopped results.
Peaches/Pears	Halve and core. Position upright in chute and slice using light pressure.
Peppers, Green, Red, Yellow Etc.	Halve and seed. Fit pepper up bottom of chute, squeezing slightly to fit if necessary. Cut large ones into quarters or strips, depending on desired results. Slice using moderate pressure.
Pepperoni	Cut into 3" (8cm) lengths. Remove inedible casing.
Potatoes	Peel if desired. Position in chute, cutting large potatoes in halves.
Strawberries	Hull. Arrange berries on their sides for lengthwise slices.
Tomatoes	Use small tomatoes for whole slices, halve if necessary. Use gentle, but firm pressure.
Turnips	Peel. Cut turnips to fit chute.
Zucchini	Slice off ends. Use small squash for whole slices; halve larger ones to fit chute.

SHREDDING GUIDE	
Food	Directions
Cabbage	Use shredding disk for very fine cabbage or slaw. Cut into pieces to fit chute. Shred using light pressure. Empty bowl as cabbage reaches disk.
Carrots	Position in chute and shred.
Cheese, Cheddar	Cheese must be well chilled. Cut to fit chute.
Cheese, Mozzarella	Cut to fit chute. Cheese must be chilled in freezer for 30 minutes prior to shredding. Use light pressure.
Potatoes	Cut to fit chute.
Zucchini	Cut to fit chute, either lengthwise or horizontally.

Note: S-blade can be used to knead dough.

Note: Do not attempt to sharpen the cutting edges of the chopping blade or the reversible disk. They are permanently sharpened at the factory and will be ruined by attempted sharpening.

1. Before cleaning, be sure the unit is switched off and the cord is unplugged.
2. Whenever possible, rinse parts immediately after processing for easy cleanup.
3. Wipe the base, control knob, and feet with a damp cloth and dry thoroughly. Stubborn spots can be removed by rubbing with a damp cloth and a mild, non-abrasive cleaner. Do not immerse the base in liquid.
4. All removable parts except the storage drawer can be washed by hand or in a dishwasher, top rack. The storage drawer can be cleaned using a damp cloth.
 - If washing by hand, wash in warm, sudsy water; rinse, and dry thoroughly. If necessary, use a small nylon bristle brush to thoroughly clean the bowl and food chute/cover; this type of brush will also help prevent cutting yourself on the chopping blade and slice/shred disk.
 - If washing in a dishwasher, place removable parts on the top rack only – not in or near the utensil basket.
5. Do not use rough scouring pads or cleansers on any plastic or metal parts.
6. Do not fill the bowl with boiling water or place any of the parts in boiling water. Some foods, such as carrots, may temporarily stain the bowl. To remove stains, make a paste of 2 tablespoons (30ml) baking soda and 1 tablespoon (15ml) warm water. Apply the paste to the stains and rub with a cloth. Rinse in sudsy water and dry.

Dishwasher-safe Parts

The following parts are dishwasher-safe:

- Bowl Lid
- Bowl
- Center Post
- Food Pusher
- Slice/Shred Disk
- Thin Slice/Shred Disk
- Blade Disk Stem
- S-Blade