



VAN SOLUTIONS

For Full-size Vans, Minivans, Sprinter Vans, Cube Vans, Walk-in Vans and Work Trailers.

WEATHER GUARD® VAN SOLUTIONS

**SURE. YOUR VEHICLE IS YOUR
A WORKING TOOL ESSENTIAL TO
SO OF COURSE YOU COME TO
GUARD VAN SOLUTIONS FOR THE
FLEXIBLE, CUSTOMIZABLE, LONG
VAN INTERIORS IN THE BUSINE**

We also believe your van is your customers' first clue as to how you will perform on the job. It's all about how you present your business the first time. Every time. Organized design communicates professionalism. Our priority is to design our bulkheads, ladder racks and storage systems to be the most efficient, customized, simple solutions for your specific needs. Perhaps that's why for more than thirty years, the best contractors in every business have brought their expertise and high standards to every jobsite in WEATHER GUARD Van Solutions.

LIVELIHOOD.
D EVERY JOB.
WEATHER
THE MOST
NG-LASTING
SS.

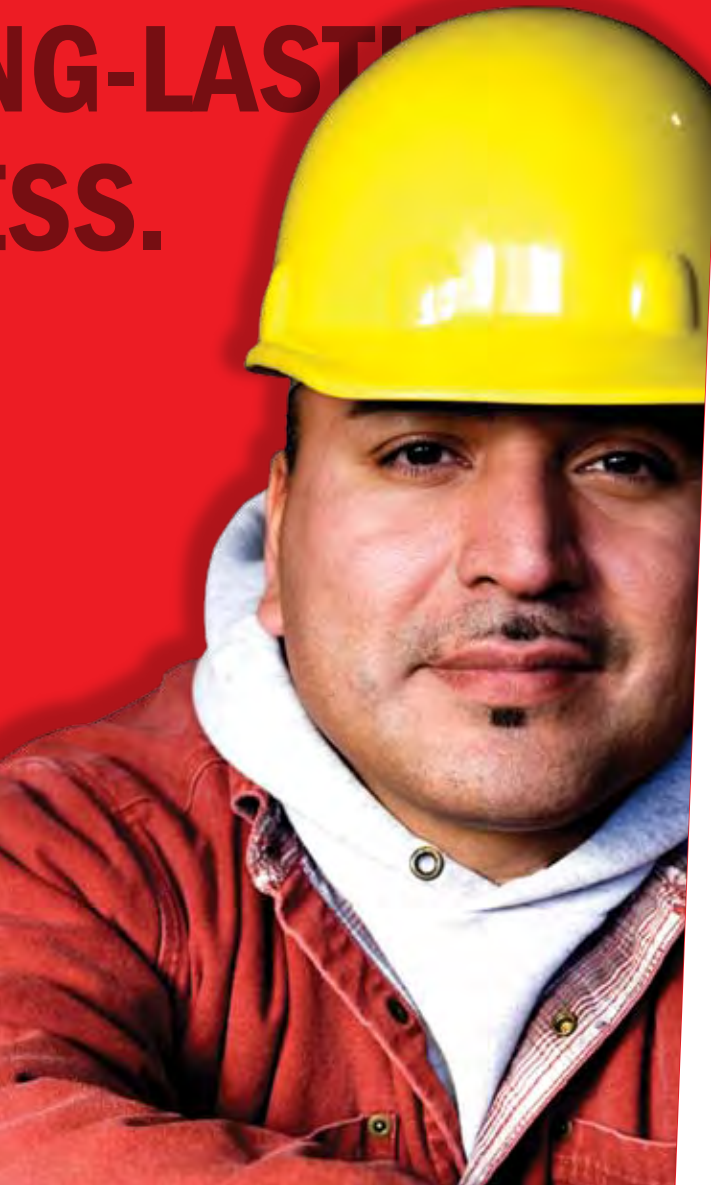

TABLE OF CONTENTS

BULKHEADS	02 - 07
Full-Size Van Bulkheads	05
Sprinter Van Bulkheads	06
Minivan Bulkheads	06
Bulkhead Accessories	07
SHELVING	08 - 13
Welded E-Z Cube Shelving	10
Knockdown Jumbo Shelving	11
Knockdown Shelving Accessories	12 - 13
SPECIALTY STORAGE	14 - 23
Small Storage	16 - 18
Accessories	19
PACK RAT® Drawer Units	20 - 21
ITEMIZER® Drawer Units	22
BED RAT® Sliding Platform	23
ROOF RACKS	24 - 35
EZ-GLIDE™ System Racks	26 - 27
Quick Clamp Racks	28 - 29
All-Purpose Racks	30 - 32
Safari Rack	33
Sliding Ladder Rack	34
Rack Accessories	34
Roof Rack Fitting Guide	35
SOLUTIONS BY PROFESSION	36 - 41
General Service	36
Contractor	37
Plumber/HVAC	38
Electrician	39
Telecom/Parcel Delivery	40
Locksmith	41
FITTING GUIDES BY VEHICLE	42 - 43
Full-Size Van Fitting Guide	42
Sprinter Van Fitting Guide	42
Minivan Fitting Guide	43
VEHICLE SOLUTIONS	44 - 45

For more detailed product information please review the product installation manuals at www.weatherguard.com.

weather guard

BULKHEADS





IN AN ACCIDENT, IT'S THE ONLY THING STANDING BETWEEN YOU AND AN AIRBORNE RECIPROCATING SAW. THE ONLY THING KEEPING SOME THUG FROM THOUSANDS OF DOLLARS WORTH OF TOOLS. THAT'S WHY WE NEVER STOP THINKING ABOUT HOW TO MAKE A BETTER BULKHEAD.

We use 16-gauge steel for durability, security, and accident protection. Our bulkheads are powder-coated white to keep the interior of your van brighter. In the last year, we've reduced the number of models to make choices simpler, installation faster, and instruction sheets easier to follow. Even the DOG HATCH™ door for long length material is made big enough for ease of use, but too small for an intruder to gain access.

weather guard

BULKHEADS

**NEW
DESIGN!**

Our Full-size van, Sprinter van and Minivan bulkheads allow you to separate the driver compartment from the cargo area for maximum protection against shifting loads. They're available in a variety of styles so you can choose the right one for your specific needs.

EASY INSTALLATION

with sidewall and roof mounting brackets.

16-GAUGE STEEL

is used for strength and durability.

NEW VERTICAL PANEL DESIGN

reduces ambient noise levels.



PROVIDES IMPROVED HEATING AND COOLING EFFICIENCY

in the passenger area.

EXCLUSIVE 9" x 12" DOG HATCH™ DOOR

allows easy loading of long materials by utilizing the floor space in front of the bulkhead.

UNIVERSAL FIT

among Full-size vans:
- GM '97 to current
- Ford '96 to current
- Dodge '02 and older

<p>Model Ship Wt. 86500-3-01 82 lbs.</p>	<p>SCREEN BULKHEAD FOR FULL-SIZE VANS</p>
<p>Offers extensive rear and side visibility while providing occupant protection and cargo security.</p>	

<p>Model Ship Wt. 86510-3-01 82 lbs.</p>	<p>LEXAN WINDOW BULKHEAD FOR FULL-SIZE VANS</p>
<p>Offers unobstructed visibility of the cargo area, side door and rear door. Delivers full driver and cargo protection and maximizes HVAC efficiency in the passenger area.</p>	

<p>Model Ship Wt. 86520-3-01 86 lbs.</p>	<p>SOLID BULKHEAD FOR FULL-SIZE VANS</p>
<p>Provides maximum occupant protection, cab climate control and security from front cab break-ins.</p> <p>To convert this Bulkhead into a swing door, order the 86555-3-01 Hinge Kit.</p>	

<p>Model Ship Wt. 86500-3-01 82 lbs. (Bulkhead) 86555-3-01 4 lbs. (Hinge Kit)</p>	<p>SWING DOOR BULKHEAD FOR FULL-SIZE VANS</p>
<p>Features a mid-mounted, lockable hinged door that provides easy access to and from the cargo area.</p> <p>Order both the Bulkhead and Hinge Kit to create the swing door.</p>	

<p>Model Ship Wt. 86300-3-01 82 lbs.</p>	<p>SLIDING DOOR BULKHEAD FOR FULL-SIZE VANS</p>
<p>Features a lockable, smooth-rolling, ball-bearing-mounted sliding door that optimizes cargo capacity and allows for easy access to and from the cargo area.</p>	

<p>Model Ship Wt. ① 86001-3-01 35 lbs. (Driver's Side) ② 86002-3-01 35 lbs. (Passenger Side)</p>	<p>DRIVER, PASSENGER PANELS FOR FULL-SIZE VANS</p>
<p>Provides protection while offering unobstructed access to the cargo area. Driver and passenger side panels are available separately, or can be installed together to create a pass-through.</p>	

Model 85500-3-01	Ship Wt. 100 lbs.	SCREEN BULKHEAD FOR SPRINTER VANS
<p>Offers a large area for accessory mounts and holders while providing safety and security for occupants and cargo.</p> <p>All Sprinter Bulkheads will fit either standard or high-roof Sprinter vans.</p>		

Model 85500-3-01 (Bulkhead)	Ship Wt. 100 lbs.	SWING DOOR BULKHEAD FOR SPRINTER VANS
Model 85555-3-01 (Hinge Kit)	Ship Wt. 4 lbs.	
<p>Allows for fast and simple access to the cargo area with a lockable swing door.</p> <p>All Sprinter Bulkheads will fit either standard or high-roof Sprinter vans.</p> <p>Order both the Bulkhead and Hinge Kit to create the swing door.</p>		

Model 88500-3-01	Ship Wt. 60 lbs.	SCREEN BULKHEAD FOR MINIVANS
<p>Offers rear and side visibility while retaining the safety of the front seat occupants and the security of the cargo.</p> <p>Universally fits Chevy Uplander, Ford Freestar and Dodge Grand Caravan.</p>		



BULKHEAD ACCESSORIES

WEATHER GUARD® Bulkhead Accessories let you create a custom storage solution that securely organizes the items you need to locate quickly and easily.



Model	Description	Ship Wt.	Model	Description	Ship Wt.
1	8880-3 Literature Holder	10 lbs.	5	8873-3-01 Ext. Cord Brkt. (3)	2 lbs.
2	8870-3 Literature Holder	11 lbs.	6	8877-3 Practice Holder	4 lbs.
3	8875 Hard Hat Bracket*	2 lbs.	7	8876-3 First Aid Kit Tray	2 lbs.
4	8866 Fire Extinguisher	6 lbs.	8	8865 Safety Reflector Kit	11 lbs.

*Hard hat not included



SHELVING





WHY IS IT THAT EVERY TIME YOU OPEN THE DOORS OF YOUR VAN, IT LOOKS DIFFERENT? THAT THING THAT WAS OVER HERE YESTERDAY IS UP THERE TODAY. YOU CAN'T FIND WHAT YOU NEED AND THE CLOCK IS TICKING. IT'S TIME FOR A CUSTOMIZED SHELVING SYSTEM FOR YOUR VAN.

We offer an endless number of shelving configurations because we know how small a 4' x 8' space can feel. Built of heavy-gauge steel, our shelving is available in different heights, lengths and depths to make sure your van is configured for the way you work. Taller shelf units now have tapered end panels, so they fit closer to the wall and free up more of your precious floor space. Shelving from WEATHER GUARD® Van Solutions belongs in your van, because more organization and efficiency belong in your business.



WELDED E-Z CUBE SHELVING

**NEW
DESIGN!**

Our fully arc-welded shelving units are pre-assembled and ready to install, providing a heavy-duty storage solution. The tapered end panels allow the unit to sit snugly against the wall for maximum floor space. Constructed of 12, 17, 18 and 20-gauge steel these shelves are finished with our signature bright white powder coat for a durable, professional-looking appearance.

TAPERED END PANEL DESIGN

allows a close fit to the van wall and additional cargo space in the middle of the van.

FULLY ARC WELDED

for durable construction and no assembly.

BOTTOM SHELF IS PRE-PUNCHED

for E-Z installation of accessory cabinets on page 16.



MIDDLE TWO SHELVES ARE PRE-PUNCHED

for E-Z Bin Dividers.

HEMMED SHELVES

provide extra strength and a lip in front of the shelf for load retention.

BOTTOM RETAINER LIP

is made of 12-gauge steel and is pre-punched for the E-Z attachment of an accessory shelf door on page 12.



E-Z Bin Dividers mount to two middle shelves.

E-Z CUBE FOR FULL-SIZE VANS

Model	Height	Length	Depth Top Shelf	Depth Bottom Shelf	Shelves	Ship Wt.
9400-3-01	43 ³ / ₄ "	42"	11 ¹ / ₄ "	13 ³ / ₄ "	4	76 lbs.
9452-3-01	43 ³ / ₄ "	51"	11 ¹ / ₄ "	13 ³ / ₄ "	4	90 lbs.

WELDED STACK UNIT

Model	Height	Length	Depth	Shelves	Dividers	Ship Wt.
8230-3-01	30"	36"	12"	3	6	25 lbs.



Designed to mount to the floor or on top of the Wheel Well Base Cabinet. Dividers are welded in place.

① E-Z BIN DIVIDERS

Model	Dividers	Ship Wt.
8401-3-01	8	18 lbs.
8402-3-01	4	9 lbs.

WHEEL WELL BASE CABINET

Model	Height	Length	Depth	Ship Wt.
8141-3-01	13 ³ / ₄ "	42 ³ / ₄ "	15"	49 lbs.



Designed to fit over the wheel well and provide a flat, sturdy foundation for Shelf Units, Parts Cabinets or Drawer Units.

KNOCKDOWN JUMBO SHELVING

**NEW
DESIGN!**

For the ultimate in flexibility, WEATHER GUARD® Knockdown Shelving lets you create a system designed specifically for the way you work. Constructed of 18-gauge steel and finished in our exclusive bright white powder coat, these shelves are easy to assemble and provide the perfect foundation for a customized van storage solution.

STEEL SHELF DIVIDERS

are included and adjustable on 3" centers.

3" LIPS

contain shelf contents during transportation.

EFFORTLESS CONFIGURATION



Interlocks with bayonet-type clips in the end panels allowing easy pre-assembly configuration before securing with nuts and bolts in pre-drilled holes.



SHELVING IS PRE-PUNCHED

for easy attachment of accessory shelf doors on page 12.

SHELVES

are available in 3 depths and 4 heights to create any configuration.

TAPERED END PANEL DESIGN

allows a close fit to the van wall and additional cargo space in the middle of the van (on certain units).

30" TALL SHELF UNITS

Model	Height	Length	Depth	Shelves	Dividers	Ship Wt.
8320-3-01	30 1/4"	30 1/4"	14"	2	8	38 lbs.
8332-3-01	30 1/4"	36 1/4"	14"	2	8	42 lbs.
8342-3-01	30 1/4"	42 1/4"	14"	2	8	45 lbs.
8352-3-01	30 1/4"	51 1/4"	14"	2	8	51 lbs.

TAPERED 43 3/4" TALL SHELF UNITS

Model	Height	Length	Depth	Shelves	Dividers	Ship Wt.
8433-3-01	43 3/4"	36 1/4"	14"	3	12	61 lbs.
8443-3-01	43 3/4"	42 1/4"	14"	3	12	66 lbs.
8453-3-01	43 3/4"	51 1/4"	14"	3	12	76 lbs.
8463-3-01	43 3/4"	60 1/4"	14"	3	12	88 lbs.

43 3/4" TALL SHELF UNITS

Model	Height	Length	Depth	Shelves	Dividers	Ship Wt.
8380-3-01	43 3/4"	42 1/4"	18"	3	12	88 lbs.
8381-3-01	43 3/4"	51 1/4"	18"	3	12	94 lbs.
8390-3-01	43 3/4"	42 1/4"	24"	3	12	128 lbs.
8391-3-01	43 3/4"	51 1/4"	24"	3	12	158 lbs.

TAPERED 57 1/2" TALL SHELF UNITS

Model	Height	Length	Depth	Shelves	Dividers	Ship Wt.
8474-3-01	57 1/2"	42 1/4"	14"	3	12	76 lbs.
8475-3-01	57 1/2"	51 1/4"	14"	3	12	85 lbs.
8476-3-01	57 1/2"	69 1/4"	14"	3	12	112 lbs.

59 1/2" TALL SHELF UNITS

Model	Height	Length	Depth	Shelves	Dividers	Ship Wt.
8383-3-01	59 1/2"	42 1/4"	18"	3	12	94 lbs.
8384-3-01	59 1/2"	51 1/4"	18"	3	12	100 lbs.
8385-3-01	59 1/2"	69 1/4"	18"	3	12	135 lbs.
8393-3-01	59 1/2"	42 1/4"	24"	3	12	156 lbs.
8394-3-01	59 1/2"	51 1/4"	24"	3	12	171 lbs.
8395-3-01	59 1/2"	69 1/4"	24"	3	12	207 lbs.

RACK UNITS 1" LIP

Model	Height	Length	Depth	Shelves	Ship Wt.
8314-3-01	30 1/4"	18"	12 1/4"	4	22 lbs.
8415-3-01	43 3/4"	18"	12 1/4"	5	26 lbs.

KNOCKDOWN SHELVING ACCESSORIES

Outfit your Knockdown Shelving Unit to fit your equipment. From bin dividers to extra shelves, WEATHER GUARD® Van Solutions has the accessories you need to secure your gear.



1 SHELF DOORS

Turn any shelf unit into a cabinet with a locking paddle handle latch; made of 12-gauge steel.

Model	Height	Length	Used With	Ship Wt.
8500-3-01	10 1/2"	29"	30 1/4" L Shelf Units	11 lbs.
8501-3-01	10 1/2"	35"	36 1/4" L Shelf Units	13 lbs.
8502-3-01	10 1/2"	41"	42 1/4" L Shelf Units	17 lbs.
8503-3-01	10 1/2"	50"	51 1/4" L Shelf Units	20 lbs.
8504-3-01	10 1/2"	59"	60 1/4" L Shelf Units	23 lbs.
8505-3-01	10 1/2"	68"	69 1/4" L Shelf Units	25 lbs.

2 BACK PANELS

Attach to the back of Shelf Units to prevent items from falling behind shelves; made of 20-gauge steel.

Model	Used With	Height	Length	Ship Wt.
8933-3-01	30 1/4" Shelf	14 1/2"	29 1/2"	6 lbs.
8934-3-01	36 1/4" Shelf	14 1/2"	35 1/2"	7 lbs.
8935-3-01	42 1/4" Shelf	14 1/2"	41 1/2"	7 lbs.
8937-3-01	51 1/4" Shelf	14 1/2"	50 1/2"	9 lbs.
8938-3-01	60 1/4" Shelf	14 1/2"	59 1/2"	10 lbs.
8939-3-01	69 1/4" Shelf	14 1/2"	68 1/2"	12 lbs.

3 EXTRA SHELF - 3" LIP

Pre-punched 3" on-center divider slots.

Model	Length	Depth	Dividers	Ship Wt.
8030-3-01	30 1/4"	14"	4	13 lbs.
8036-3-01	36 1/4"	14"	4	14 lbs.
8042-3-01	42 1/4"	14"	4	17 lbs.
8051-3-01	51 1/4"	14"	4	20 lbs.
8060-3-01	60 1/4"	14"	4	26 lbs.
8069-3-01	69 1/4"	14"	4	26 lbs.
8070-3-01	42 1/4"	18"	4	19 lbs.
8071-3-01	51 1/4"	18"	4	21 lbs.
8072-3-01	69 1/4"	18"	4	27 lbs.
8080-3-01	42 1/4"	24"	4	27 lbs.
8081-3-01	51 1/4"	24"	4	34 lbs.
8082-3-01	69 1/4"	24"	4	45 lbs.
8090-3-01	30 1/4"	12"	4	12 lbs.
8091-3-01	36 1/4"	12"	4	14 lbs.
8092-3-01	42 1/4"	12"	4	16 lbs.
8093-3-01	51 1/4"	12"	4	18 lbs.
8094-3-01	60 1/4"	12"	4	22 lbs.
8095-3-01	69 1/4"	12"	4	24 lbs.

4 END PANELS (PAIR)

Create your own Shelf Units with End Panels listed below and shelves listed above.

Model	Height	Depth	Ship Wt.
8957-3-01	23 1/2"	14"	15 lbs.
8958-3-01	30 1/4"	14"	17 lbs.
8345-3-01	37"	14"	21 lbs.
8959-3-01	43 3/4"	14"	23 lbs.
8950-3-01	43 3/4" tapered	14"	20 lbs.
8951-3-01	57 1/2" tapered	14"	30 lbs.

5 RETAINER LIPS

Mount at floor level to prevent materials from rolling into cargo area. They are pre-drilled to accept accessory shelf doors.

Model	Used For	Ship Wt.
8800-3-01	30 1/4" L Shelf Units	5 lbs.
8801-3-01	36 1/4" L Shelf Units	5 lbs.
8802-3-01	42 1/4" L Shelf Units	6 lbs.
8803-3-01	51 1/4" L Shelf Units	7 lbs.
8804-3-01	60 1/4" L Shelf Units	7 lbs.
8805-3-01	69 1/4" L Shelf Units	8 lbs.

6 EXTRA FLAT SHELF - 1" LIP

Allows larger opening between shelves. 1-inch lip can be turned up or down. (No dividers included)

Model	Length	Depth	Ship Wt.
8810-3-01	30 1/4"	14"	14 lbs.
8811-3-01	36 1/4"	14"	16 lbs.
8812-3-01	42 1/4"	14"	17 lbs.
8813-3-01	51 1/4"	14"	21 lbs.
8814-3-01	60 1/4"	14"	24 lbs.
8815-3-01	69 1/4"	14"	27 lbs.

BIN DIVIDERS

Model	Description	Height	Length	Ship Wt.
7 8119	Short Bin Dividers (4)	3"	12"	3 lbs.
8114	Short Bin Dividers (4)	3"	14"	3 lbs.
8117-3-01	Short Bin Dividers (4)	3"	17 1/2"	4 lbs.
8118-3-01	Short Bin Dividers (4)	3"	23 1/2"	6 lbs.
8 8112-3-01	Tall Bin Dividers (6)	6 1/2"	13 1/2"	6 lbs.
8115-3-01	Sloped Bin Dividers (6) (Not shown)	3" to 6 1/2"	13 1/2"	4 lbs.
9 8113-3-01	Flat Shelf Bin Dividers (6)	6 1/2"	13 3/4"	7 lbs.

END PANEL ACCESSORIES

Model	Description	Ship Wt.
10 8873-3-01	Extension Cord Brackets (3)	2 lbs.
11 8875	Hard Hat Bracket (Hard hat is not included)	2 lbs.
12 8866	Fire Extinguisher	6 lbs.
13 8841	Shelf Mat (Trim to Fit)	1 lb.
14 7601	T-Mounting Bracket (2)	1 lb.
7604	Mounting Spacers (6) (Not shown)	2 lbs.

CABINET MOUNTING KITS

Use with Drawer Units and Parts Cabinets on page 16. Allows cabinets to be mounted on shelves with 3" lips. (Not shown)

Model	Used For	Ship Wt.
7220	14" D Shelf Units	1 lb.
8078-3-01	18" D Shelf Units	3 lbs.
8088-3-01	24" D Shelf Units	4 lbs.

SHELF CENTER SUPPORTS (PAIR)

Used for extra support. Can be cut down for different height shelves.

Model	Height	Ship Wt.
8817-3-01	60"	12 lbs.

15 BIN BOXES (CARDBOARD)

Model	Height	Width	Depth	Quantity	Ship Wt.
8125	7"	5"	13"	25	11 lbs.

SPECIALTY STORAGE





EVERY TIME YOU LOSE FIVE MINUTES LOOKING FOR A TOOL. EVERY TIME THE GUY YOU SEND TO THE VAN FOR SOMETHING COMES BACK AND SAYS, "I CAN'T FIND IT." EVERY TIME YOU COME ACROSS DISORGANIZATION, WEATHER GUARD® VAN SOLUTIONS HAS THE ANSWER.

The WEATHER GUARD Van Solutions line is designed to customize and organize your van for efficiency. Drawer units and parts cabinets help you keep track of the loose tools and parts so essential to your job, every day. PACK RAT® Drawer Units and BED RAT® Sliding Platforms organize heavy inventory and preserve floor space for loose payload. No matter what your business, there is a custom van interior waiting to shave steps, minutes and cost off every job you take.



DRAWER UNITS

	Model	Drawers	Height	Width	Depth	Ship Wt.
①	8905-3	9	24"	12 1/2"	11 3/4"	46 lbs.
②	8914-3	4	24"	17"	18"	54 lbs.
③	8904-3	4	24"	17"	11 3/4"	48 lbs.
④	8903-3	3	18"	17"	11 3/4"	36 lbs.
⑤	8902-3	2	12"	17"	11 3/4"	27 lbs.
⑥	8901-3	4	12"	17"	11 3/4"	33 lbs.
⑦	8913-3	3	5 1/2"	32 1/2"	11 3/4"	24 lbs.

Drawer Units will require the separate purchase of a Cabinet Mounting Kit when mounting to shelves with 3" lips. See page 13.



PARTS CABINETS

	Model	Drawers	Height	Width	Depth	Ship Wt.
①	8909-3	9	12"	17"	11 3/4"	28 lbs.
②	8918-3	18	12"	32 1/2"	11 3/4"	54 lbs.
③	8908-3	8	8 1/2"	22 1/4"	11 3/4"	24 lbs.
④	8906-3	6	4 1/2"	32 1/2"	11 3/4"	18 lbs.

Each drawer comes with 2 dividers. Parts Cabinets will require the separate purchase of a Cabinet Mounting Kit when mounting to shelves with 3" lips, except for 8918-3. See page 13.



DRAWER DIVIDERS

Model	Use With	Ship Wt.
8907-3	8902-3 8903-3 8904-3	2 lbs.
8896-3	8913-3	2 lbs.
8897-3	8914-3	2 lbs.
8898-3	8901-3	2 lbs.
8899-3	8905-3	2 lbs.

Comes with a rubber mat. Includes dividers for one drawer only.



STEEL WORK TOP

Model	Length	Depth	Ship Wt.
① 8867-3-01	42 1/2"	18"	2 lbs.

For mounting to top of Cabinet Base and Drawer Units.

ALSO PICTURED:

Model	Description
8901-3	Drawer Unit
8902-3	Drawer Unit
8141-3-01	Wheel Well Base Cabinet



LOCKABLE CABINETS & CATV BOXES

	Model	Shelves	Height	Width	Depth	Ship Wt.
①	8310-3	2	24"	17"	18"	54 lbs.
②	8311-3	2	18"	17"	11 3/4"	29 lbs.
③	8312-3	1	24"	17"	11 3/4"	33 lbs.
④	8313-3	N/A	20"	20"	17 1/2"	25 lbs.
⑤	8316-3	4	21"	20"	14"	43 lbs.

Models 8310-3, 8311-3 and 8312-3 have removable shelves.



PARTS BOXES

	Model	Height	Width	Depth	Ship Wt.
①	8930-3	3"	18"	12"	8 lbs.
②	8931-3	15 3/4"	21 1/4"	12 3/4"	28 lbs.



Parts Boxes shown with Slide Out Cabinet (8931-3) above are not included and need to be ordered separately.

DOOR TRAY

Model	Trays	Height	Width	Ship Wt.
8470-3	3	21 3/4"	20 1/4"	19 lbs.



Includes nine dividers.

LITERATURE HOLDERS

	Model	Bins	Height	Width	Depth	Ship Wt.
①	8880-3	4	15"	13"	6 1/2"	10 lbs.
②	8870-3	6	15"	13"	4 3/4"	11 lbs.
③	8361-3	3	36"	6"	12"	16 lbs.



STRONG BOX

Model	Height	Width	Depth	Ship Wt.
9036-3	16"	36 3/4"	19 3/4"	93 lbs.



High-security box for the inside of a van that features 1/4" plate steel around the lid opening and the Watchman® IV Lock System.

FILE BOXES

	Model	Item	Height	Width	Depth	Ship Wt.
①	8861-3	File Box	15 1/2"	13 1/4"	18"	33 lbs.
	8860-3	Cup Holder	3"	13"	4"	2 lbs.
②	8878-3	File Box	15"	9 1/4"	20 1/4"	24 lbs.

File Boxes mount between the seats of Full-size vans and Minivans and are designed for holding hanging file folders. Features include clipboard clamp, a keyed lock, a sliding tray and a quick release mounting plate, allowing the box to be removed from the van.



① For Full-size vans

② For Minivans

TANK RACKS

	Model	Tanks	Height	Width	Depth	Ship Wt.
①	8881-3	2-30 lbs. 1-50 lbs.	40"	15 1/2"	8"	27 lbs.
②	8895-3	3-50 lbs.	45 1/2"	15 1/2"	8"	31 lbs.
③	8882-3	4-30 lbs.	48 1/2"	13"	8"	31 lbs.

Tank Racks are designed to hold refrigerant tanks of various sizes and provide convenient transport inside your van. Straps are provided for each tank.



①

②

③

TANK HOLDER

Model	Height	Width	Depth	Ship Wt.
8894-3	12 3/4"	7"	7"	5 lbs.

This Tank Holder mounts to the floor of cargo vans and will allow any size refrigerant tank to be strapped in place and held securely for transport.



WIRE SPOOL RACK

Model	Height	Width	Depth	Ship Wt.
8868-3	42 1/2"	19 3/4"	16 1/4"	37 lbs.

The Wire Spool Rack is designed to hold a variety of sizes of wire spools, providing convenient transport inside your van. Spools are mounted on easy-to-remove spindles that simply drop into place on the rack.



WINDOW SCREENS

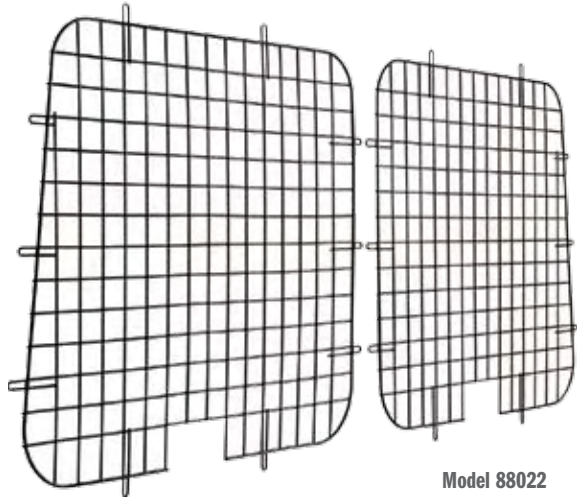

Model 88022

Model	Van Type	Van Type	Quantity	Description	Ship Wt.
88021	'92 & Newer Ford	Full-size	2	Side Door - Hinged	8
88022	'92 & Newer Ford	Full-size	2	Rear Door - Hinged	8
88023	'92 & Newer Ford	Full-size	1	Side Door - Sliding	8
88026	'96 & Newer GM	Full-size	2	Side Door - Sliding	8
88027	'96 & Newer GM	Full-size	2	Side Door - Hinged	7
88028	'96 & Newer GM	Full-size	2	Rear Door - Hinged	8
88029	Ford Freestar	Minivan	1	Rear Door - Hatch	8
88031	Ford Freestar	Minivan	2	Rear Side Windows	6
88032	Ford Freestar	Minivan	2	Side Door - Sliding	7
88033	Chevy/Dodge	Minivan	1	Rear Door - Hatch	6
88034	Chevy Uplander	Minivan	2	Rear Side Windows	6
88035	Chevy Uplander	Minivan	2	Side Door - Sliding	9
88036	Dodge Grand Caravan	Minivan	2	Rear Side Windows	7
88037	Dodge Grand Caravan	Minivan	2	Side Door - Sliding	6
88038	Dodge Sprinter	Sprinter	1	Side Door - Sliding	8
88039	Dodge Sprinter	Sprinter	2	Rear Door - Hinged	8

VAN FLOOR MATS

Model	Van Type	Ship Wt.
89015	'96 & newer GM 135" wheel base	55 lbs.
89017	'92 & newer Ford standard wheel base	60 lbs.
89050	'85 & newer GM Astro/Safari	50 lbs.
89011	70" x 124" rectangular, must be cut to fit any style vans	55 lbs.

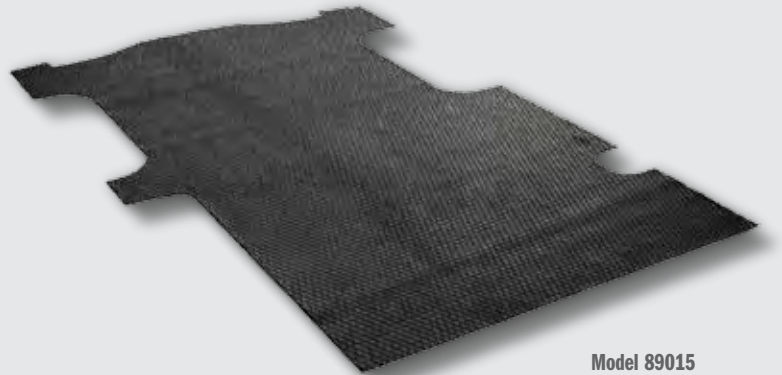

Model 89015

CARAVAN CV FLOOR COVERS

Model	Van Type	Ship Wt.
88530-5-01	Designed exclusively for the 2004 & newer Dodge Caravan CV	70 lbs.

Designed to cover seating wells in the van floor.
Made of 14-gauge steel.

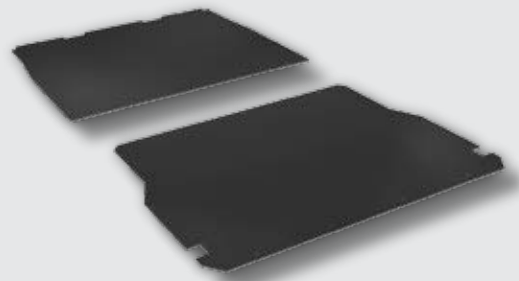

PACK RAT® DRAWER UNITS

Have your equipment waiting for you as soon as you open the door. These heavy-duty pull-out drawer units can be mounted inside the side or rear doors. They offer easy access to hundreds of pounds of tools and supplies while leaving floor space open for hauling materials or moving in and out of the vehicle.

14-GAUGE STEEL

on top and sides allows for a 750 lb. load rating when evenly distributed on top of unit.

12-GAUGE STEEL SKIDS

and full width ribs underneath and inside the unit add extra strength.

ANTI-SKID STRIPS

provide traction for wet and muddy boots.

ONE-TOUCH PUSHBUTTON LATCH ASSEMBLY

allows for one hand operation.



Model 338-3

SMOOTH ROLLING DRAWER

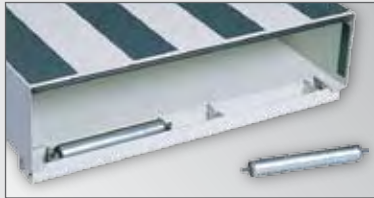

Provides trouble-free operation and can carry up to 425 lbs. of equipment.

EASY MAINTENANCE



Drawers are completely removable.

DIVIDER ACCESSORIES

Model	Description	Ship Wt.
300	Set of 6	4 lbs.
For model 304-3, 305-3, 306-3, 307-3, 308-3, 312-3		
302	Set of 6	6 lbs.
For model 301-3, 303-3, 334-3, 335-3, 336-3, 337-3, 338-3		

EXTRA WIDE COMPARTMENT, 9" HIGH, 48" LONG DRAWER UNIT

Model 304-3
30" Wide
2 Compartments
6 Dividers
Ship Wt. 220 lbs.

Smaller Compartment
5" H x 9 3/4" W x 45" L
Larger Compartment
5" H x 19 1/2" W x 45" L



EXTRA WIDE COMPARTMENT, 12 1/2" HIGH, 48" LONG DRAWER UNIT

Model 334-3
30" Wide
2 Compartments
6 Dividers
Ship Wt. 245 lbs.

Smaller Compartment
8 1/2" H x 9 3/4" W x 45" L
Larger Compartment
8 1/2" H x 19 1/2" W x 21" L



**9" HIGH, 24" LONG
DRAWER UNIT**

Model 312-3
30" Wide
3 Compartments
12 Dividers
Ship Wt. 151 lbs.



Each Drawer Compartment Measures
5" H x 9 3/4" W x 21" L

**12 1/2" HIGH, 24" LONG
DRAWER UNITS**

Model 301-3
30" Wide
3 Compartments
12 Dividers
Ship Wt. 169 lbs.



Model 303-3
39 3/4" Wide
4 Compartments Wide
12 Dividers
Ship Wt. 217 lbs.



Each Drawer Compartment Measures
8 1/2" H x 9 3/4" W x 21" L

**9" HIGH, 48" LONG
DRAWER UNITS**

Model 305-3
10 1/4" Wide
1 Compartment
6 Dividers
Ship Wt. 106 lbs.

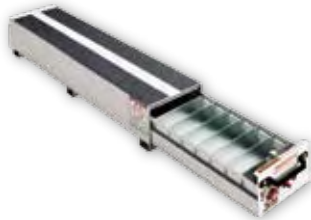

Model 306-3
20" Wide
2 Compartments
12 Dividers
Ship Wt. 179 lbs.



Model 307-3
30" Wide
3 Compartments
18 Dividers
Ship Wt. 247 lbs.



Model 308-3 (White)
Model 308-5 (Black)
39 3/4" Wide
4 Compartments
24 Dividers
Ship Wt. 322 lbs.



Each Drawer Compartment Measures
5" H x 9 3/4" W x 45" L

**12 1/2" HIGH, 48" LONG
DRAWER UNITS**

Model 335-3
10 1/4" Wide
1 Compartment
6 Dividers
Ship Wt. 130 lbs.



Model 336-3
20" Wide
2 Compartments
12 Dividers
Ship Wt. 210 lbs.



Model 337-3
30" Wide
3 Compartments
18 Dividers
Ship Wt. 294 lbs.



Model 338-3 (White)
Model 338-5 (Black)
39 3/4" Wide
4 Compartments
24 Dividers
Ship Wt. 383 lbs.



Each Drawer Compartment Measures
8 1/2" H x 9 3/4" W x 45" L

ITEMIZER® DRAWER UNITS

This exclusive, lightweight aluminum storage solution conveniently increases your storage space by placing small equipment at your fingertips without the need to crawl inside the van. Drawer dividers provide an extensive array of organizing options.

SPRING LATCH DRAWERS
carry up to 75 lbs. of equipment each.

UNITS CAN BE STACKED
as needed for additional storage.

ROLLER MOUNTED DRAWERS
glide open to full extension.

ADJUSTABLE DRAWER DIVIDERS
offer greater flexibility.



ANTI-SKID STRIPS
provides traction for wet and muddy boots.

LOCK MOUNT
is provided for installation of optional camlock.

Model 318-3

LATERAL DRAWER UNITS

Model 314-3
1 Drawer
Ship Wt. 26 lbs.
Unit Measures
6 3/4" H x 12 1/4" W x 49" L

Model 316-3
2 Drawer Lateral
Ship Wt. 55 lbs.
Unit Measures
6 3/4" H x 24" W x 49" L

Model 317-3
3 Drawer Lateral
Ship Wt. 85 lbs.
Unit Measures
6 3/4" H x 36" W x 49" L

Model 318-3
4 Drawer Lateral
Ship Wt. 110 lbs.
Unit Measures
6 3/4" H x 48" W x 49" L



Each Drawer Compartment Measures
4 1/4" H x 10 1/2" W x 46 1/2" L

STACKED DRAWER UNITS

Model 326-3
2 Drawer Stacked
Ship Wt. 48 lbs.
Unit Measures
12 1/4" H x 12 1/4" W x 49" L

Model 327-3
3 Drawer Stacked
Ship Wt. 71 lbs.
Unit Measures
17 3/4" H x 12 1/4" W x 49" L

Model 328-3
4 Drawer Stacked
Ship Wt. 92 lbs.
Unit Measures
23 1/2" H x 12 1/4" W x 49" L



Each Drawer Compartment Measures
4 1/4" H x 10 1/2" W x 46 1/2" L

BED RAT® SLIDING PLATFORM

Extend your van's workspace and bring heavy loads to you, instead of bending in to get them, with this sliding platform. Sized to fit your work needs, BED RAT Sliding Platforms are available for both side and rear door openings.

LIGHTWEIGHT EXTRUDED ALUMINUM RAILS

glide smoothly on heavy-duty ball bearings.

70% EXTENSION

for easy access of stored materials and tools.

750 LB. TOTAL CAPACITY

when weight is evenly distributed on the platform.

10 1/2" HIGH SIDE PANELS

are made from steel and help keep materials on the deck.



Decking material is not included. 3/4" plywood is recommended.

<p>Dimensions 4 3/4" H x 22" W x 54" L</p>	<p>FOR FULL-SIZE VAN SIDE DOOR</p>
<p>Model 3100 Perfect for curb side loading and unloading from the side door of Full-size vans. Ship Wt. 97 lbs.</p>	

<p>Dimensions 4 3/4" H x 44 3/4" W x 68" L</p>	<p>FOR FULL-SIZE VAN & MINIVAN REAR DOOR</p>
<p>Model 3200 Fits all Minivans and Full-size vans. Ship Wt. 123 lbs.</p>	

<p>Dimensions 4 3/4" H x 44 3/4" W x 80" L</p>	<p>FOR FULL-SIZE VAN REAR DOOR</p>
<p>Model 3300 Ideal for Full-size standard wheel base vans. Ship Wt. 141 lbs.</p>	

<p>Dimensions 4 3/4" H x 44 3/4" W x 90" L</p>	<p>FOR LONG WHEEL BASE FULL-SIZE VAN REAR DOOR</p>
<p>Model 3400 Fits all Full-size long wheel base and extended vans. Ship Wt. 155 lbs.</p>	



ROOF RACKS





**IT DOESN'T FIT INSIDE
YOUR VAN. BUT YOU'VE
ABSOLUTELY GOT TO HAVE
IT ON THE JOB. IT HAS TO
GO ON TOP AND STAY
PUT. BUT IT NEEDS TO BE
EASY TO ACCESS. YOU
NEED A WEATHER GUARD®
ROOF RACK.**

WEATHER GUARD Van Solutions offers a variety of roof racks to address every trade, every business, every need. Our standard designs accommodate ladders and long material – all the oversized items you need to carry. Conduit and pipe carriers ensure the right stock is always available. Our premium aluminum Quick Clamp Racks make oversized work materials easy to handle. Make your life simpler. Make your choice WEATHER GUARD Van Solutions.

weather guard

THE EZ-GLIDE™ SYSTEM

The quickest, easiest and safest drop-down ladder rack system available. With just a twist of a lever, EZ-GLIDE System gently delivers your ladder to the right spot for back-saving loading and unloading. When the work is done, another twist is all it takes to have the ladder packed away and ready to roll.

LONG-LASTING DESIGN

with lightweight aluminum frame keeps rust at bay for a long-lasting, professional appearance. Rust-proof stainless steel fasteners and non-metallic bushings eliminate bi-metal corrosion.

WEATHER GUARD® VAN SOLUTIONS TRADEMARKED RED TIPS

show the world that you work with the highest quality equipment available.

STOW AND SECURE

interlocking ladder supports ensure ladders stay in place when stowed. Ladders can be padlocked for added security.

MULTI-USE DESIGN

will accommodate extension ladders and certain step ladders.

STEP LADDERS

Models 251, 252, 253, 255, 256, 257, 281, 283, 285, 287 will accept a 6' and 8' step ladder with a bottom width not exceeding 27". Repositioning of the ladder stops is required if the bottom width of the ladder is between 25" and 27". An accessory cross member may be required depending on the distance between the front and rear cross members.



EZ-GLIDE SYSTEM HYDRAULIC CYLINDER

provides a smooth, quiet and effortless descent. Zero-impact drop reduces noise and equipment wear.

ERGONOMIC DRIVE ARM

telescoping lever extends to fit your reach. Extra-strength handle, lever and hinge hardware provide maximum durability and ease of use.

EZ-GLIDE™ SYSTEM RACKS

FOR FULL-SIZE VANS

Model Ship Wt.

251 62 lbs.

252 62 lbs.

Mounts to rain gutters

FOR MINIVANS

Model Ship Wt.

253 67 lbs.

Bolts through the roof

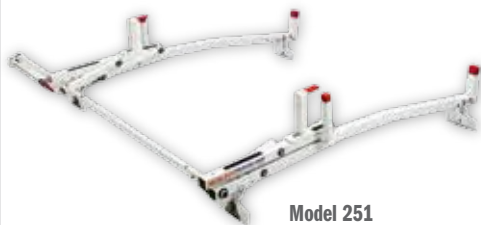

Model 251

The essential EZ-GLIDE System rack comes with a drop-down system on the passenger side and a standard ladder rack on the driver's side. Maximum ladder weight of 75 lbs. per drop-down assembly.

DRIVER'S SIDE DROP-DOWN KIT

FOR FULL-SIZE VANS

Model Ship Wt.

255 45 lbs.

Fits model 251, 252, 253

FOR SPRINTER VANS

Model Ship Wt.

286 63 lbs.

Fits model 280

287 54 lbs.

Fits model 285



Model 255

The driver's side drop-down kit is universal and fits the EZ-GLIDE System racks by unbolting the driver side end posts and bolting the kit in place. Maximum ladder weight of 75 lbs. per drop-down assembly.

DRIVER'S SIDE CLAMP KIT

Model Ship Wt.
254 14 lbs.
Fits model 251, 252, 253



The driver's side clamp kit is universal and fits the EZ-GLIDE System racks by unbolting the driver side end posts and bolting the kit in place.

RETROFIT KITS FOR QUICK CLAMP RACKS

PASSENGER SIDE
Model Ship Wt.
256 47 lbs.
Fits model 234, 236



Model 256

DRIVER SIDE
Model Ship Wt.
257 47 lbs.
Fits model 234, 236

Upgrade your current Quick Clamp Rack to the safety and convenience of the EZ-GLIDE System drop-down ladder system. Fits model 234-3 and model 236-3 Quick Clamp Racks.

ACCESSORY CROSS MEMBERS

Model Ship Wt.
2511 14 lbs.
Fits model 251
2521 14 lbs.
Fits model 252
2531 13 lbs.
Fits model 253



Model 2511

For use when your van length or load requirements require a cross member. Each of our cross members are vehicle specific and attach easily to any of our Full-size van or Minivan racks.

ACCESSORIES

Model	Description	Ship Wt.
1	Warning Light Holder	3 lbs.
2	Mirror Holder	3 lbs.
3	Mirror	2 lbs.
4	Velcro Straps	1 lb.
2505	KUV Mounting Brackets	9 lbs.



SPRINTER VAN EZ-GLIDE™ SYSTEM RACKS

Model Ship Wt.
280 80 lbs.
For Sprinter vans high roof, passenger side. Includes rear slide down system
285 70 lbs.
For Sprinter vans standard roof, passenger side. Does not include rear slide down system



Model 280

These unique racks utilize the same professional-grade EZ-GLIDE System as our Full-size van and Minivan models, with added features designed specifically for Sprinter vans. An added slide down system lowers the ladder an additional 2 ft. after the drop-down rotation.

8' AND 10' HIGH CUBE EZ-GLIDE™ SYSTEM RACKS

Model Ship Wt.
281 66 lbs.
For 8' high Cube vans passenger side
283 66 lbs.
For 8' high Cube vans driver side
282 75 lbs.
For 10' high Cube vans passenger side. Includes rear slide down system
284 75 lbs.
For 10' high Cube vans driver side. Includes rear slide down system



Model 282

Engineered for 8' and 10' high Cube vans with flat roofs. These racks feature the same drop-down system that lowers the ladder to an easy to reach position for easy loading and unloading. An added slide down system on the 10' High Cube Racks lowers the ladder an additional 2 ft. after the drop-down rotation.

ALUMINUM QUICK CLAMP RACKS FOR FULL-SIZE VANS

Our Quick Clamp Racks are engineered to make loading and unloading your ladder an easy, one-person operation. Lean the front of the ladder against the front hook and swing the back up onto the rack. Close the gas spring assisted Quick Clamp and you're ready to roll.

**WEATHER GUARD®
VAN SOLUTIONS
TRADEMARKED
RED TIPS**

show the world that you work with the highest quality equipment available.

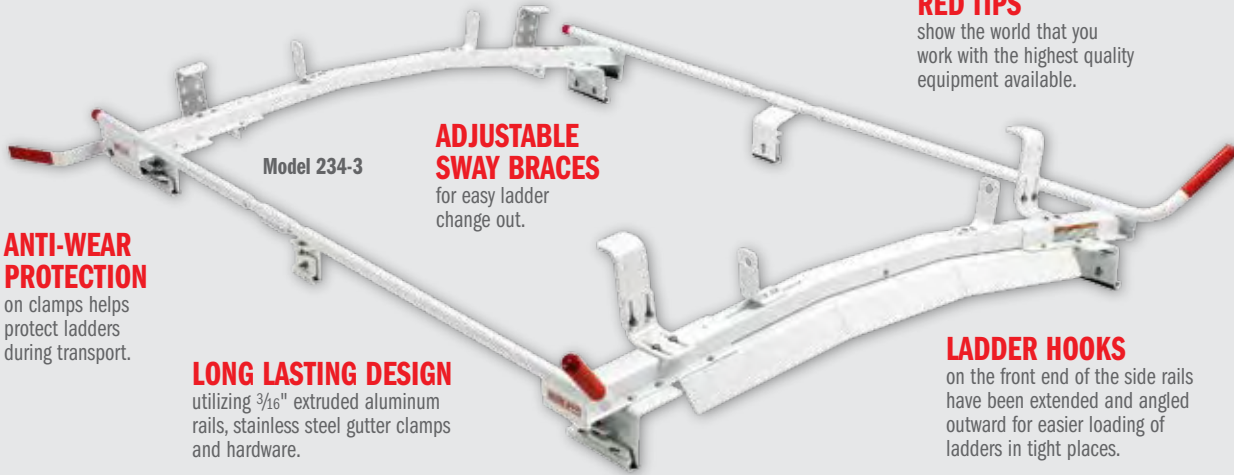

Model 234-3

**ADJUSTABLE
SWAY BRACES**
for easy ladder change out.

**ANTI-WEAR
PROTECTION**
on clamps helps protect ladders during transport.

LONG LASTING DESIGN
utilizing 3/4" extruded aluminum rails, stainless steel gutter clamps and hardware.

LADDER HOOKS
on the front end of the side rails have been extended and angled outward for easier loading of ladders in tight places.

GUTTER CLAMPS



Mounting leg attaches to the van with a stainless steel gutter clamp painted brite white.

QUICK CLAMP



Patented Quick Clamp Rack clamping mechanism can be locked with a padlock for security.

ADDITIONAL SUPPORT



Center mounting leg provides additional support and stability.

QUICK CLAMP RACKS FOR FULL-SIZE VANS

Model	Description	Ship Wt.
234-3	Dual Clamp on the street and curb side	76 lbs.
236-3	Single Clamp on the curb side only	73 lbs.

ACCESSORY CROSS MEMBER FOR FULL-SIZE VANS

Model	Ship Wt.
233-3	21 lbs. <small>Fits model 234-3, 236-3</small>



Works with model 234-3 and 236-3 Quick Clamp Racks to accommodate short ladders and provide additional support.

ALUMINUM QUICK CLAMP RACKS FOR MINIVANS

Offering the same easy loading and unloading as our Full-size rack, our Quick Clamp Racks for Minivans offer easy access in tight places and special elastomer mounting pads that provide a weather tight seal around the mounting bases.

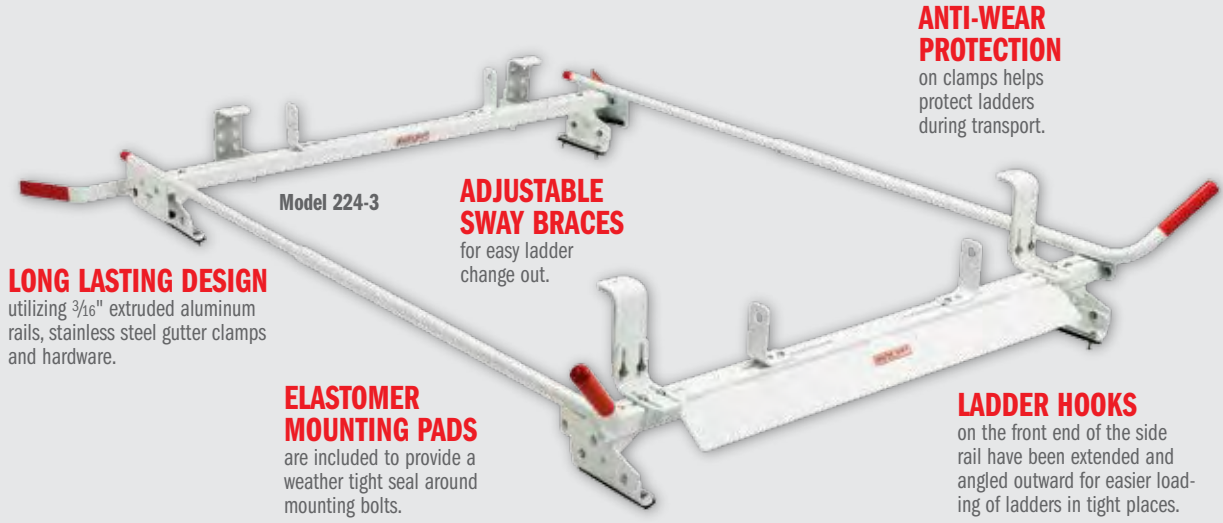

Model 224-3

ADJUSTABLE SWAY BRACES
for easy ladder change out.

ANTI-WEAR PROTECTION
on clamps helps protect ladders during transport.

LONG LASTING DESIGN
utilizing 3/16" extruded aluminum rails, stainless steel gutter clamps and hardware.

ELASTOMER MOUNTING PADS
are included to provide a weather tight seal around mounting bolts.

LADDER HOOKS
on the front end of the side rail have been extended and angled outward for easier loading of ladders in tight places.

MOUNTING BASES



Designed to rotate and to easily adjust to the contours of the van roof.

QUICK CLAMP



Patented Quick Clamp Rack clamping mechanism can be locked with a padlock for security.

QUICK CLAMP RACKS FOR MINIVANS

Model	Description	Ship Wt.
223-3	Single clamp on the curb side only	41 lbs.
224-3	Dual clamp on the street and curb side	46 lbs.

ACCESSORY CROSS MEMBER FOR MINIVANS

Model	Ship Wt.
225-3	16 lbs. <small>Fits model 223-3, 224-3</small>



Works with model 223-3 and 224-3 Quick Clamp Racks to accommodate short ladders and provide additional support.

ALL-PURPOSE RACKS

Versatile and rugged, our All-Purpose Racks create a space for all the long equipment you need to carry. Available in aluminum or steel, WEATHER GUARD® Roof Racks offer a number of different mounting and accessory options.

**WEATHER GUARD VAN SOLUTIONS
TRADEMARKED RED TIPS**
tell everyone that you work with the best.

STAINLESS STEEL HARDWARE
stands tough against time and weather.

VELCRO STRAPS
assist in securing your ladder for transport.

ANTI-WEAR PROTECTION
on cross members protect ladders and building materials during transport.

AVAILABLE FINISHES
include durable bright white, black or clear coat.

ADDITIONAL CROSS MEMBERS
can be added for longer material and ladders.



LADDER GUIDE

Model	Length	Width	Ship Wt.
240-3	148 1/2"	16" - 24"	34 lbs.

- Ladder Guide makes it easier to load an extension ladder from the rear of the van by guiding it into position.
- This aluminum product is finished with bright white powder coat.
- Attaches to the cross members on a roof rack.
- Adjustable to the width of the extension ladder being installed.
- Designed to be installed on model 205-3/205-5, 215-3/215-5, 216-3/216-5, 209-3, 219-3, 229-3, 211 and 213 racks only.

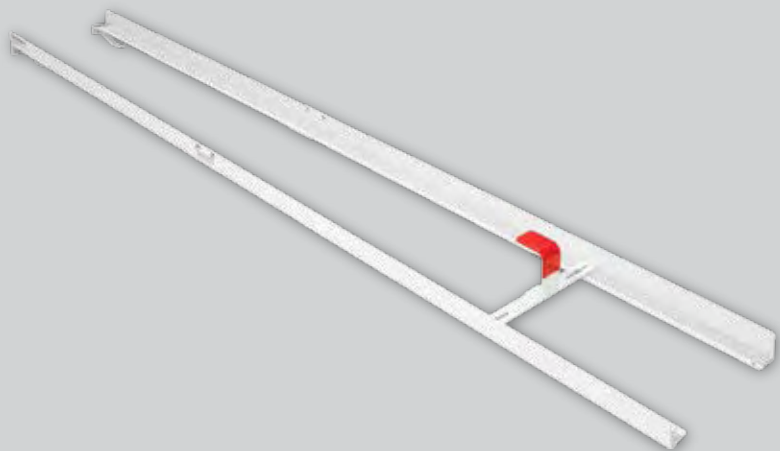

POWDER COATED ALUMINUM RACK FOR FULL-SIZE VANS

Model	Description	Ship Wt.
209-3	2 Cross Member Rack	31 lbs.
219-3	3 Cross Member Rack	43 lbs.
229-3	3 Cross Member Rack	43 lbs.
2095-3	Accessory Cross Member	20 lbs.
2097-3	Accessory Cross Member	20 lbs.

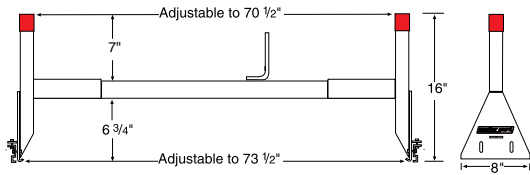

Model 209-3



This All-Purpose Rack is designed to clamp to roof gutters. It features extruded aluminum cross members with a double tube design for maximum carrying capacity.

CLEAR COAT ALUMINUM RACK FOR FULL-SIZE VANS

Model	Description	Ship Wt.
211	2 Cross Member Rack	36 lbs.
213	3 Cross Member Rack	50 lbs.
2136	Accessory Cross Member	21 lbs.

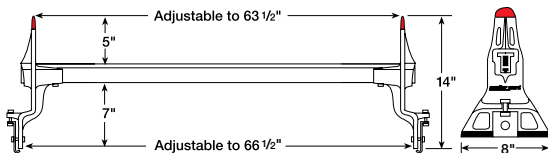

Model 211



This All-Purpose Rack has cast aluminum mounting legs that have been engineered with load bearing capabilities in mind.

POWDER COATED ALUMINUM RACK FOR MINIVANS

Model	Description	Ship Wt.
218-3	2 Cross Member Rack	25 lbs.
222-3	Accessory Cross Member	13 lbs.

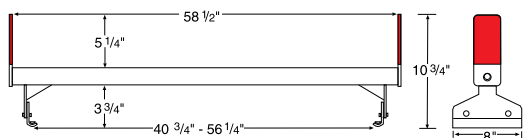

Model 218-3



This All-Purpose Rack has a specially designed mounting leg that fully adjusts to the contour of the van roof, for secure through-the-roof mounting.

POWDER COATED HEAVY DUTY STEEL RACK FOR FULL-SIZE VANS

Model (white)	Description	Ship Wt.
205-3	2 Cross Member Rack	42 lbs.
215-3	3 Cross Member Rack	63 lbs.
216-3	3 Cross Member Rack	63 lbs.
2055-3	Accessory Cross Member	26 lbs.
2056-3	Accessory Cross Member	23 lbs.

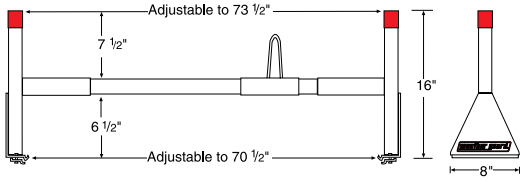

Model 205-3



**ALSO AVAILABLE IN BLACK:
MODELS 205-5, 215-5, 216-5,
2055-5, 2056-5.**

This All-Purpose Rack features cross members made of 14-gauge steel tubing. Mounting base is extra-wide 12-gauge steel for superior attachment strength to the gutter.

POWDER COATED LITE DUTY STEEL RACK FOR FULL-SIZE VANS

Model	Description	Ship Wt.
207-3	2 Cross Member Rack	52 lbs.
217-3	3 Cross Member Rack	73 lbs.
2076-3	3 Cross Member Rack	72 lbs.
2077-3	Accessory Cross Member	27 lbs.
2078-3	Accessory Cross Member	26 lbs.

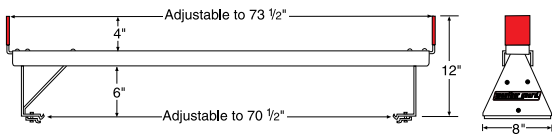

Model 207-3



This All-Purpose Rack features cross members made of 12-gauge formed steel. Mounting base is extra-wide 7-gauge steel for superior attachment strength to the gutter.

POWDER COATED STEEL RACK FOR ASTRO/SAFARI MINIVANS

Model	Description	Ship Wt.
220-3	2 Cross Member Rack	24 lbs.
221-3	Accessory Cross Member	11 lbs.

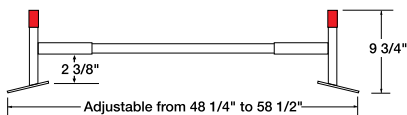

Model 220-3



This All-Purpose Rack features cross members made of 14-gauge steel tubing cross members and a specially designed mounting base for secure through-the-roof mounting.

SAFARI RACK FOR FULL-SIZE VANS

Excellent for hauling all types of materials, the Safari Rack easily accommodates 4-foot wide loads and distributes the weight evenly over eight cross members to protect the roof of the van. The OVAL RAIL DESIGN side rail is unique to WEATHER GUARD® Van Solutions.

VELCRO STRAPS

assist in securing your ladder for transport.

FRONT & REAR CROSS MEMBERS

extend over the ends of the van for protection when loading ladders and other long materials.

CROSS MEMBERS

are constructed of 13-gauge, 1 1/4" x 1 1/4" square steel tubing and spread the load evenly to protect long, fragile materials.



ANTI-WEAR PROTECTION

on cross members helps protect ladders and building materials during transport.

STAINLESS STEEL MOUNTING BRACKETS

are extra wide for superior attachment strength to the gutter.

AIR FOIL

eliminates wind noise and mounts to the front of the cross member.

CENTER LEG



Adjustable center mounting leg with bolt-on gutter clamp. Accommodates both Ford & GM vans and provides additional support and stability.

TIE DOWNS



Tie downs may be bolted on anywhere along the side rail where it is most convenient.

Model	Length	Width	Ship Wt.
210-3	150 3/4"	64"	205 lbs.

For Full-size vans only. Length from front to rear cross member is 140".

SLIDING LADDER RACK

Our new Sliding Ladder Rack provides quick and easy ladder storage inside your van, enclosed trailer or cube van. Rugged and durable, this rack fits 8-foot step, extension or multi-position ladders and can be mounted to the roof or side panel.

UNIVERSAL MOUNTING BRACKET
adjusts to different vehicles.

ROOF MOUNTING BRACKET
is provided for horizontal installation.

TENSION CORD GUIDE
prevents cords from tangling.

ADJUSTABLE CRADLE
accommodates different types of ladders.

SAFETY CABLE
secures ladder in place.

3-PIECE RAIL ASSEMBLY
accepts up to an 8' ladder.

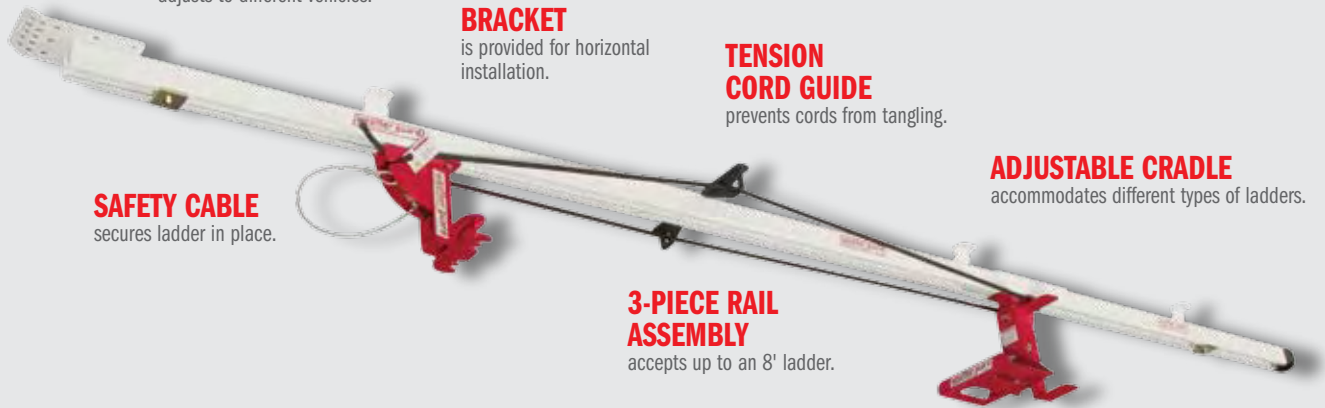

MOUNTING BRACKETS



Roof mounting brackets for easy installation.

SIDE MOUNT



Includes side mounting capabilities.

Model	Ship Wt.
250	27 lbs.

ALUMINUM CONDUIT CARRIER

Model	Description	Length	Width	Height	Ship Wt.
1 237	Conduit Carrier	121 1/2"	11"	6"	40 lbs.
2 238	Extension	6"	11"	6"	4 lbs.



Keep your conduit safe, secure and clean with our lightweight and durable Conduit Carrier.

MAKE-YOUR-OWN CONDUIT CARRIER

Model	Ship Wt.
239	4 lbs.

PVC not included. Separately purchase a section of standard 6" PVC (9ASTM D2665) plastic drain pipe. Coordinate the length of the PVC with the length of conduit you'll be carrying.



ROOF RACK FITTING GUIDE

FULL-SIZE VANS	FORD		GM		DODGE	DODGE SPRINTER	
EZ-Glide™ Rack p. 26-27	'92 & newer	'96 & newer	'95 & older	'02 & older	High roof	Standard roof	
251-3-01	X						
252-3-01		X					
280					X		
285							X
Aluminum Quick Clamp Racks p. 28-29							
234-3	X	X	X	X			
263-3	X	X	X	X			
Aluminum All-Purpose Racks p. 31							
209-3	X	X	X	X			
219-3			X	X			
229-3	X	X					
2095-3			X	X			
2097-3	X	X					
211	X	X	X	X			
213	X	X					
2136	X	X					
Steel All-Purpose Racks p. 32							
205-3/205-5	X	X	X	X			X
215-3/215-5			X	X			X
216-3/216-5	X	X					
2055-3/2055-5			X	X			X
2056-3/2056-5	X	X					
207-3	X	X	X	X			
217-3			X	X			
2076-3	X	X					
2077-3			X	X			
2078-3	X	X					
Safari Rack p. 33							
210	X	X	X	X			
MINIVANS							
EZ-Glide Rack p. 26-27	'03 & older Windstar	'04 & newer Freestar	'05 & older Astro/Safari	'06 & newer Uplander	Grand Caravan CV		
253	X	X	X	X			X
Aluminum Quick Clamp Racks p. 32							
223-3	X	X	X	X			X
224-3	X	X	X	X			X
Aluminum All-Purpose Racks p. 31							
218-3	X	X	X	X			X
222-3	X	X	X	X			X
Steel All-Purpose Racks p. 33							
220-3			X				



GENERAL SERVICE

For a wide range of applications, our General Service packages are a great starting point when planning your van's storage needs. This package offers a work top, various open and enclosed storage spaces and literature holders for a complete overall set-up that is easily reconfigured as your needs change. You can also customize this package with a host of other WEATHER GUARD® Van Solutions storage components.

Model	Description	Quantity
1 86500-3-01	Screen Bulkhead	1
2 9400-3-01	42" x 14" Welded Shelf Unit	1
3 8401-3-01	Dividers	1
4 9452-3-01	51" x 14" Welded Shelf Unit	1
5 8401-3-01	Dividers	1
6 8918-3	18 Drawer Parts Cabinet	1
7 8141-3-01	42" Wheel Well Cabinet	1
8 8867-3-01	Work Top	1
9 8314-3-01	4 Shelf Rack Unit	1
10 8361-3	Literature Holder	1
11 8902-3	2 Drawer Unit	2

Package Ship Wt. 496

FULL-SIZE VAN PACKAGE # 600-3001

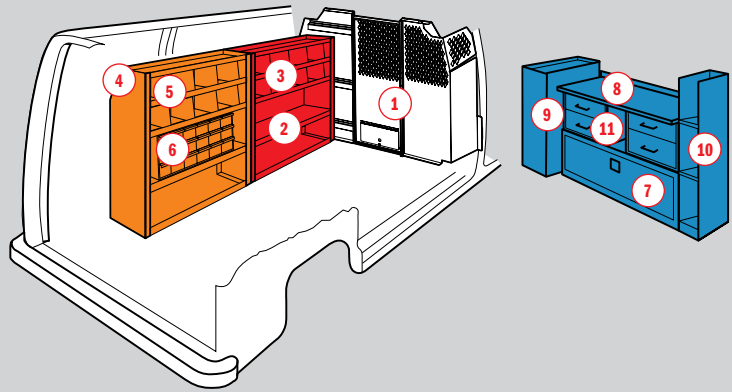

Model	Description	Quantity
1 85500-3-01	Screen Bulkhead	1
2 85555-3-01	Swing Door Hinge Kit	1
3 8867-3-01	Work Top	1
4 8361-3	Literature Holder	1
5 8901-3	4 Drawer Unit	1
6 8902-3	2 Drawer Unit	1
7 8311-3	Lockable Cabinet	2
8 8476-3-01	69" x 14" Tapered Shelf Unit	1
9 8805-3-01	Retainer Lip	1
10 8463-3-01	60" x 14" Tapered Shelf Unit	1
11 8804-3-01	Retainer Lip	1

Package Ship Wt. 463

SPRINTER VAN PACKAGE # 600-3011

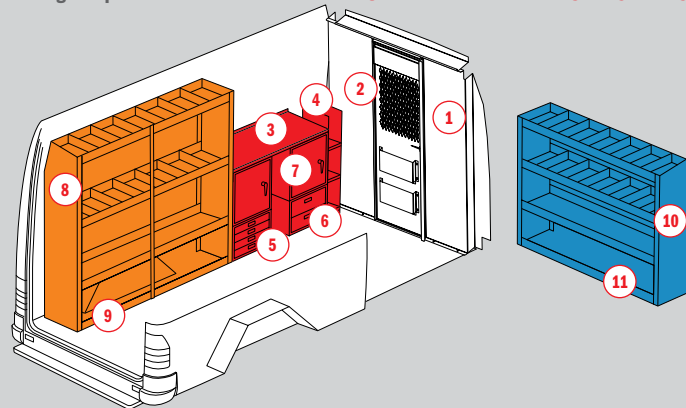

Model	Description	Quantity
1 8383-3-01	42" x 18" Shelf Unit	1
2 8802-3-01	Retainer Lip	1
3 8901-3	4 Drawer Unit	1
4 8902-3	2 Drawer Unit	1
5 8918-3	18 Drawer Parts Cabinet	1
6 8385-3-01	69" x 18" Shelf Unit	1
7 8072-3-01	Accessory Shelf	1
8 8805-3-01	Retainer Lip	1
9 8873-3-01	Extension Cord Brackets (3)	1
10 8875	Hard Hat Bracket	1
11 8078-3	Cabinet Mounting Brackets	3
12 8383-3-01	42" x 18" Shelf Unit	1
13 8502-3-01	Shelf Door	2
14 8936-3-01	Back Panel	2
15 8385-3-01	69" x 18" Shelf Unit	1
16 8072-3-01	Accessory Shelf	1
17 8805-3-01	Retainer Lip	1

Package Ship Wt. 709

CUBE VAN PACKAGE # 600-3021

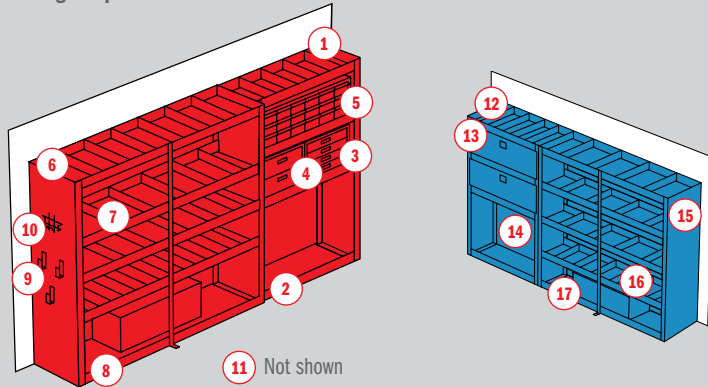

Model	Description	Quantity
1 85500-3-01	Screen Bulkhead	1
2 8875	Hard Hat Bracket	1
3 8320-3-01	30" x 14" Shelf Unit	1
4 8342-3-01	42" x 14" Shelf Unit	1
5 8918-3	18 Drawer Parts Cabinet	1
6 8332-3-01	36" x 14" Shelf Unit	1
7 8501-3-01	Shelf Door	1
8 8934-3-01	Back Panel	1

Package Ship Wt. 259

MINIVAN PACKAGE # 600-3031

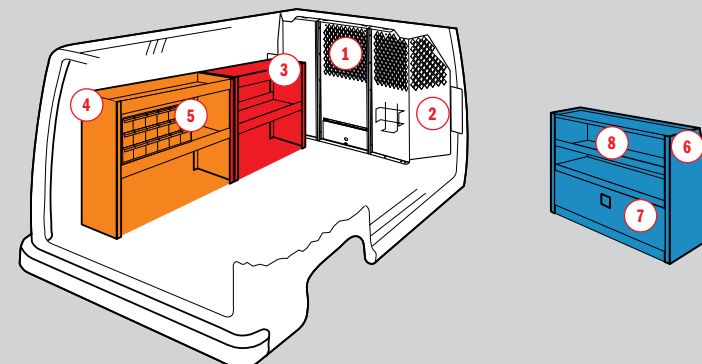

PLUMBER/HVAC

Our Plumber/HVAC packages cater to the wide range of equipment needed for your work. From small fittings to routers, there is a shelf, cabinet or drawer that will have it secured and ready to use. A window bulkhead provides full view of the cargo area while reducing noise in the driver's cab and retaining HVAC flow. All WEATHER GUARD Van Solutions packages are customizable and can be tailored to meet your specific storage needs with an extensive array of accessory components.

FULL-SIZE VAN PACKAGE # 600-3002

Package Ship Wt. 442

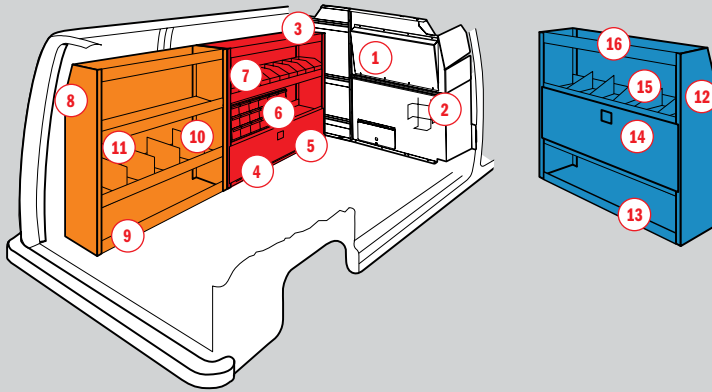

	Model	Description	Quantity
1	86510-3-01	Window Bulkhead	1
2	8875	Hard Hat Bracket	1
3	8443-3-01	42" x 14" Tapered Shelf Unit	1
4	8802-3-01	Retainer Lip	1
5	8502-3-01	Shelf Door	1
6	8918-3	18 Drawer Parts Cabinet	1
7	8125	25 Cardboard Bin Boxes	1
8	8453-3-01	51" x 14" Tapered Shelf Unit	1
9	8803-3-01	Retainer Lip	1
10	8112-3-01	Tall Dividers	1
11	8937-3-01	Back Panel	1
12	8453-3-01	51" x 14" Tapered Shelf Unit	1
13	8803-3-01	Retainer Lip	1
14	8503-3-01	Shelf Door	1
15	8937-3-01	Back Panel	1
16	8115-3-01	Sloped Dividers	1

SPRINTER VAN PACKAGE # 600-3012

Package Ship Wt. 587

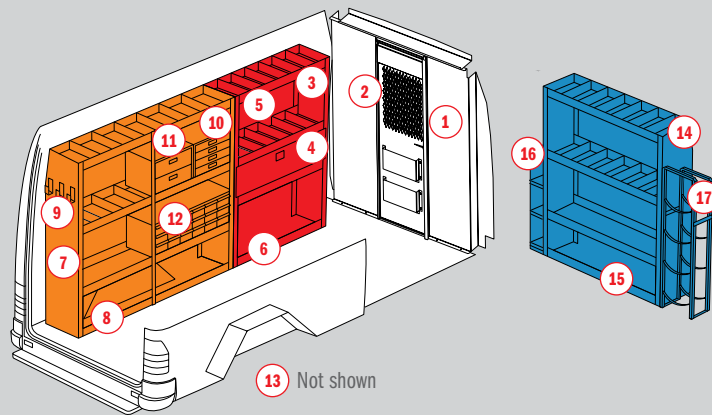

	Model	Description	Quantity
1	85550-3-01	Screen Bulkhead	1
2	85555-3-01	Swing Door Hinge Kit	1
3	8474-3-01	42" x 14" Tapered Shelf Unit	1
4	8502-3-01	Shelf Door	1
5	8935-3-01	Back Panel	1
6	8802-3-01	Retainer Lip	1
7	8476-3-01	69" x 14" Tapered Shelf Unit	1
8	8805-3-01	Retainer Lip	1
9	8873-3-01	Extension Cord Brackets (3)	1
10	8901-3	4 Drawer Unit	1
11	8902-3	2 Drawer Unit	1
12	8918-3	18 Drawer Parts Cabinet	1
13	7220	Cabinet Mounting Brackets	2
14	8475-3-01	51" x 14" Tapered Shelf Unit	1
15	8803-3-01	Retainer Lip	1
16	8361-3	Literature Holder	1
17	8882-3	Refrigerant Tank Holder	1

CUBE VAN PACKAGE # 600-3022

Package Ship Wt. 806

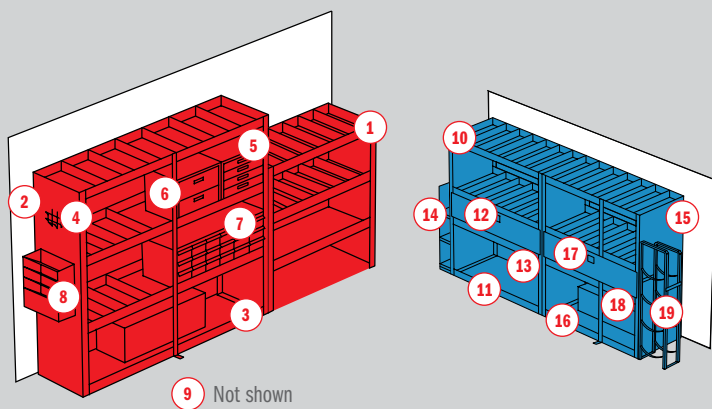

	Model	Description	Quantity
1	8380-3-01	42" x 18" Shelf Unit	1
2	8385-3-01	69" x 18" Shelf Unit	1
3	8805-3-01	Retainer Lip	1
4	8875	Hard Hat Bracket	1
5	8901-3	4 Drawer Unit	1
6	8902-3	2 Drawer Unit	1
7	8918-3	18 Drawer Parts Cabinet	1
8	8880-3	Literature Holder	1
9	8078-3-01	Cabinet Mounting Brackets	3
10	8393-3-01	42" x 24" Shelf Unit	1
11	8802-3-01	Retainer Lip	1
12	8502-3-01	Shelf Door	1
13	8935-3-01	Back Panel	1
14	8361-3	Literature Holder	1
15	8394-3-01	51" x 24" Shelf Unit	1
16	8803-3-01	Retainer Lip	1
17	8503-3-01	Shelf Door	1
18	8937-3-01	Back Panel	1
19	8882-3	Refrigerant Tank Holder	1

YOU MAY ALSO NEED:



ALL-PURPOSE RACK Page 31



PACK RAT® Page 20

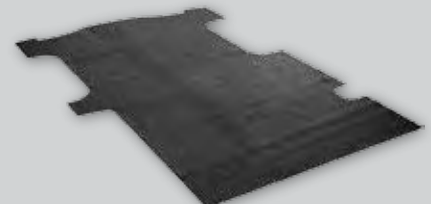

FLOOR MAT Page 19

CONTRACTOR

We know that contractors need the flexibility to adjust their storage to fit the job. Our shelving units have the strength and durability to carry the heavy tools and supplies you need. They are also quickly adjustable to meet future work demands. The screen bulkhead combines full rear visibility with occupant protection. Since all WEATHER GUARD® Van Solutions packages are customizable, you can create a van solution with storage systems that your work requires now and in the future.

	Model	Description	Quantity
1	86500-3-01	Screen Bulkhead	1
2	8443-3-01	42" x 14" Tapered Shelf Unit	1
3	8453-3-01	51" x 14" Tapered Shelf Unit	1
4	8453-3-01	51" x 14" Tapered Shelf Unit	1

Package Ship Wt. 300

FULL-SIZE VAN PACKAGE # 600-3003

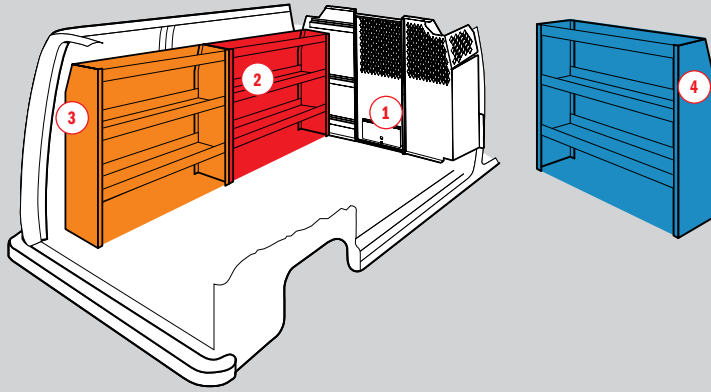

	Model	Description	Quantity
1	85500-3-01	Screen Bulkhead	1
2	85555-3-01	Swing Door Hinge Kit	1
3	8475-3-01	51" x 14" Tapered Shelf Unit	1
4	8476-3-01	69" x 14" Tapered Shelf Unit	1
5	8476-3-01	69" x 14" Tapered Shelf Unit	1

Package Ship Wt. 413

SPRINTER VAN PACKAGE # 600-3013

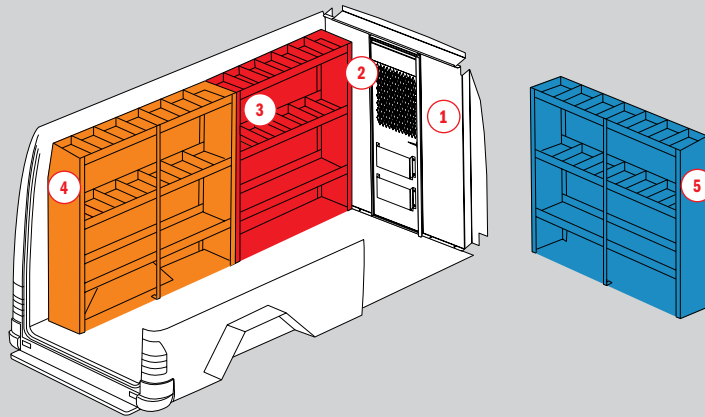

	Model	Description	Quantity
1	8391-3-01	51" x 24" Shelf Unit	1
2	8918-3	18 Drawer Parts Cabinet	1
3	8903-3	3 Drawer Unit	1
4	8311-3	Lockable Cabinet	1
5	8391-3-01	51" x 24" Shelf Unit	1
6	8805-3-01	Retainer Lip	1
7	8088-3-01	Cabinet Mounting Brackets	3

Package Ship Wt. 748

CUBE VAN PACKAGE # 600-3023

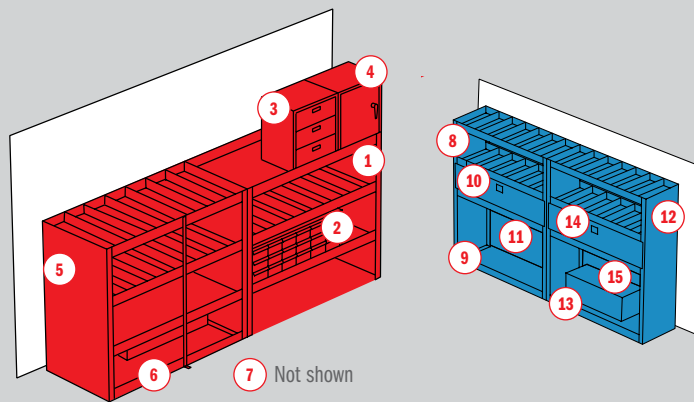

8	8384-3-01	51" x 18" Shelf Unit	1
9	8803-3-01	Retainer Lip	1
10	8503-3-01	Shelf Door	1
11	8937-3-01	Back Panel	1
12	8384-3-01	51" x 18" Shelf Unit	1
13	8803-3-01	Retainer Lip	1
14	8503-3-01	Shelf Door	1
15	8937-3-01	Back Panel	1

YOU MAY ALSO NEED:

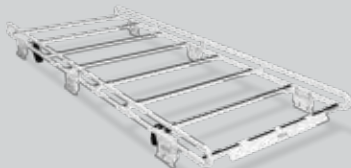

SAFARI RACK Page 33



STRONG BOX Page 17

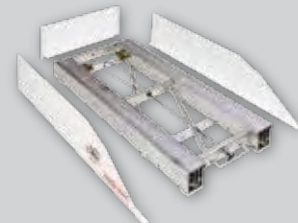

BED RAT® Page 23

ELECTRICIAN

Our Electrician packages start with 45 individual drawers for all of your assorted hardware, and finish with a convenient hard hat holder. In between you'll find sectioned, open and enclosed shelf space to provide a home for all of the equipment you need to get your job done. WEATHER GUARD Van Solutions custom configurations also allow you to incorporate other specialty equipment you may need, such as Wire Spool Racks or roof-top Conduit Carriers.

FULL-SIZE VAN PACKAGE # 600-3004

Package Ship Wt. 547

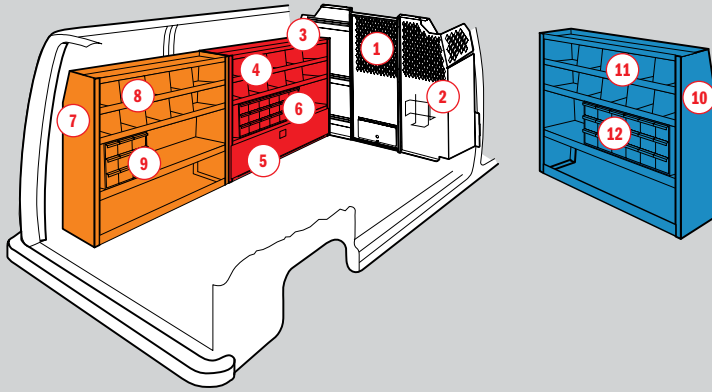

	Model	Description	Quantity
1	86500-3-01	Screen Bulkhead	1
2	8875	Hard Hat Bracket	1
3	9400-3-01	42" x 14" Welded Shelf	1
4	8401-3-01	Dividers	1
5	8502-3-01	Shelf Door	1
6	8918-3	18 Drawer Parts Cabinet	1
7	9452-3-01	51" x 14" Welded Shelf	1
8	8401-3-01	Dividers	1
9	8909-3	9 Drawer Parts Cabinet	1
10	9452-3-01	51" x 14" Welded Shelf	1
11	8401-3-01	Dividers	1
12	8918-3	18 Drawer Parts Cabinet	1

SPRINTER VAN PACKAGE # 600-3014

Package Ship Wt. 605

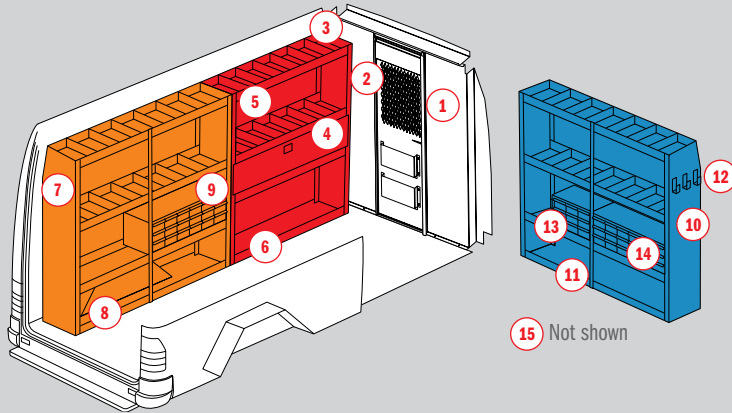

	Model	Description	Quantity
1	85500-3-01	Screen Bulkhead	1
2	85555-3-01	Swing Door Hinge Kit	1
3	8475-3-01	51" x 14" Tapered Shelf Unit	1
4	8503-3-01	Shelf Door	1
5	8937-3-01	Back Panel	1
6	8803-3-01	Retainer Lip	1
7	8476-3-01	69" x 14" Tapered Shelf Unit	1
8	8805-3-01	Retainer Lip	1
9	8918-3	18 Drawer Parts Cabinet	1
10	8476-3-01	69" x 14" Tapered Shelf Unit	1
11	8805-3-01	Retainer Lip	1
12	8873-3-01	Extension Cord Brackets (3)	1
13	8909-3	9 Drawer Parts Cabinet	1
14	8918-3	18 Drawer Parts Cabinet	1
15	7220	Cabinet Mounting Brackets	1

CUBE VAN PACKAGE # 600-3024

Package Ship Wt. 894

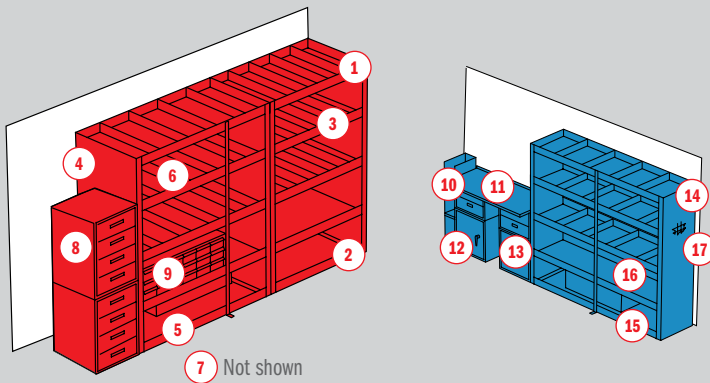

	Model	Description	Quantity
1	8393-3-01	42" x 24" Shelf Unit	1
2	8802-3-01	Retainer Lip	1
3	8080-3-01	Accessory Shelf	1
4	8394-3-01	51" x 24" Shelf Unit	1
5	8803-3-01	Retainer Lip	1
6	8081-3-01	Accessory Shelf	1
7	8088-3-01	Cabinet Mounting Brackets	1
8	8914-3	4 Drawer Unit	2
9	8918-3	18 Drawer Parts Cabinet	1
10	8361-3	Literature Holder	1
11	8867-3-01	Work Top	1
12	8311-3	Lockable Cabinet	2
13	8902-3	2 Drawer Unit	2
14	8385-3-01	69" x 18" Shelf Unit	1
15	8805-3-01	Retainer Lip	1
16	8072-3-01	Accessory Shelf	1
17	8875	Hard Hat Bracket	1

YOU MAY ALSO NEED:

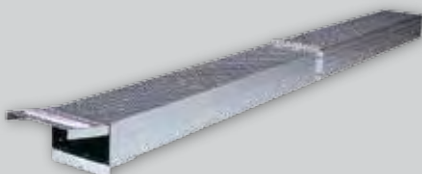

CONDUIT CARRIER Page 34



WIRE SPOOL RACK Page 18

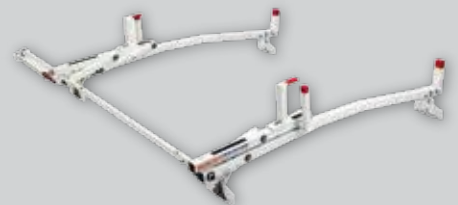

EZ-GLIDE™ SYSTEM Page 26

TELECOM/ PARCEL DELIVERY

Our Telecommunications packages have storage for the various equipment you need for cable and telephone services. Connectors and other small items have a home in parts drawers, while monitors can be locked securely away in larger cabinets. Open shelving provides convenient access for parcel delivery needs. Remember, all of WEATHER GUARD® Van Solutions packages are customizable with an extensive list of accessory components that can be mixed and matched to suit your needs.

	Model	Description	Quantity
1	86510-3-01	Window Bulkhead	1
2	8875	Hard Hat Bracket	1
3	8873-3-01	Extension Cord Brackets (3)	1
4	9400-3-01	42" x 14" Welded Shelf	1
5	8401-3-01	Dividers	1
6	8141-3-01	42" Wheel Well Cabinet	1
7	8316-3	CATV Cabinet	2
8	8141-3-01	42" Wheel Well Cabinet	1
9	8230-3-01	Welded Stack Unit	1
10	8361-3	Literature Holder	1
11	8880-3	Literature Holder	2
12	8918-3	18 Drawer Parts Cabinet	1

Package Ship Wt. 479

FULL-SIZE VAN PACKAGE # 600-3005

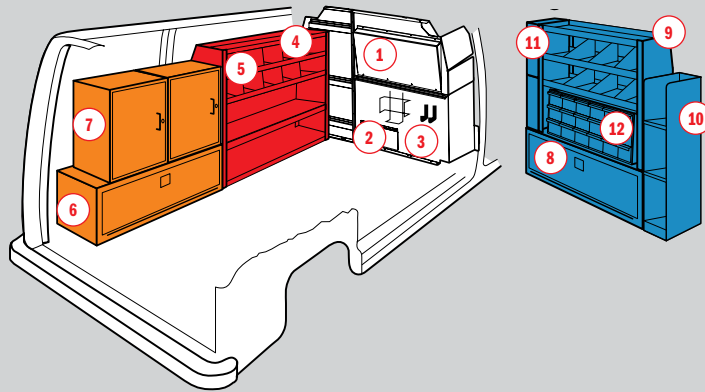

	Model	Description	Quantity
1	85500-3-01	Screen Bulkhead	1
2	85555-3-01	Swing Door Hinge Kit	1
3	8383-3-01	42" x 18" Shelf Unit	1
4	8385-3-01	69" x 18" Shelf Unit	1
5	8476-3-01	69" x 14" Tapered Shelf Unit	1

Package Ship Wt. 445

SPRINTER VAN PACKAGE # 600-3015

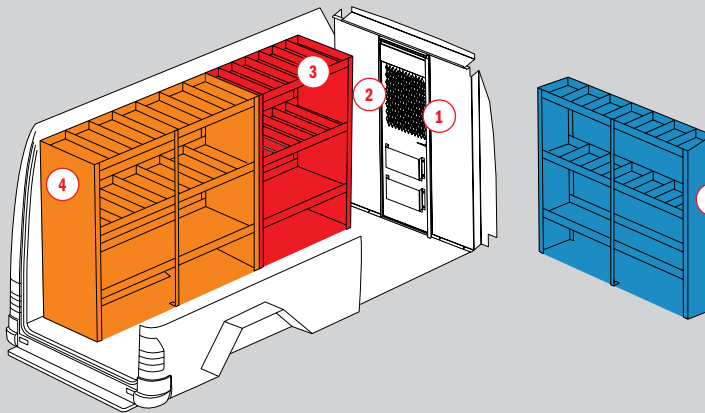

	Model	Description	Quantity
1	8384-3-01	51" x 18" Shelf Unit	1
2	8803-3-01	Retainer Lip	1
3	8684-3-01	51" x 18" Shelf Unit	1
4	8803-3-01	Retainer Lip	1
5	8394-3-01	51" x 24" Shelf Unit	1
6	8803-3-01	Retainer Lip	1
7	8394-3-01	51" x 24" Shelf Unit	1
8	8803-3-01	Retainer Lip	1
9	8875	Hard Hat Bracket	1

Package Ship Wt. 572

CUBE VAN PACKAGE # 600-3025

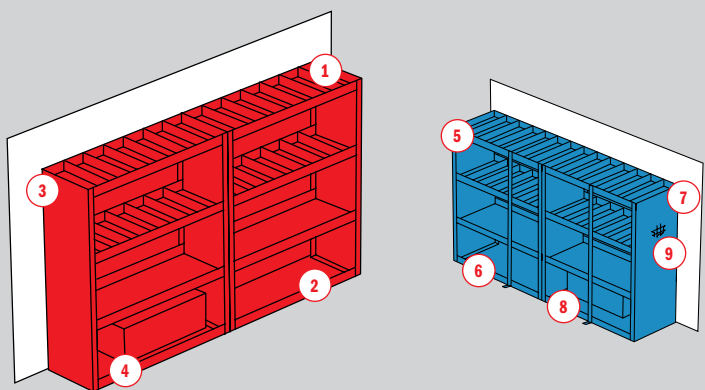

YOU MAY ALSO NEED:



QUICK CLAMP RACK Page 28



WIRE SPOOL RACK Page 18



CABLE TV BOXES Page 17

LOCKSMITH

Our Locksmith packages provide small storage units and a spacious workspace for cutting keys and repairing locks. Literature holders keep catalogs accessible and your paperwork looking clean and professional. Lockable cabinets keep sensitive tools from the wrong hands. As with the rest of WEATHER GUARD Van Solutions storage systems, all trade packages are completely customizable to fit your specific needs.

FULL-SIZE VAN PACKAGE # 600-3006

Package Ship Wt. 713

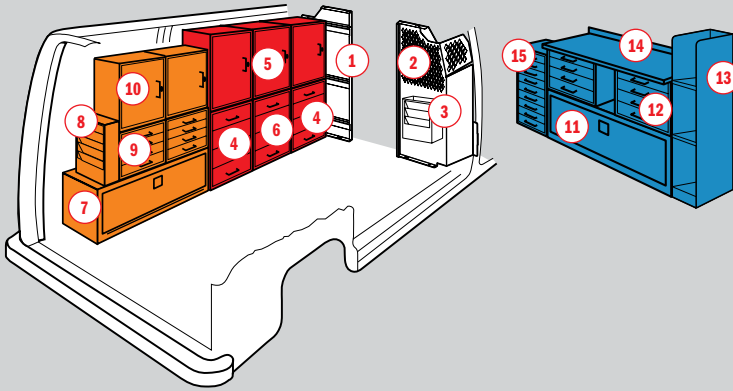

	Model	Description	Quantity
1	86001-3-01	Driver Side Bulkhead Panel	1
2	86002-3-01	Passenger Side Bulkhead Panel	1
3	8880-3	Literature Holder	1
4	8914-3	4 Drawer Unit	2
5	8312-3	Lockable Cabinet	3
6	8904-3	4 Drawer Unit	1
7	8141-3-01	42" Wheel Well Cabinet	1
8	8870-3	Literature Holder	1
9	8901-3	4 Drawer Unit	2
10	8311-3	Lockable Cabinet	2
11	8141-3-01	42" Wheel Well Cabinet	1
12	8901-3	4 Drawer Unit	2
13	8361-3	Literature Holder	1
14	8867-3-01	Work Top	1
15	8905-3	9 Drawer Unit	1

SPRINTER VAN PACKAGE # 600-3016

Package Ship Wt. 587

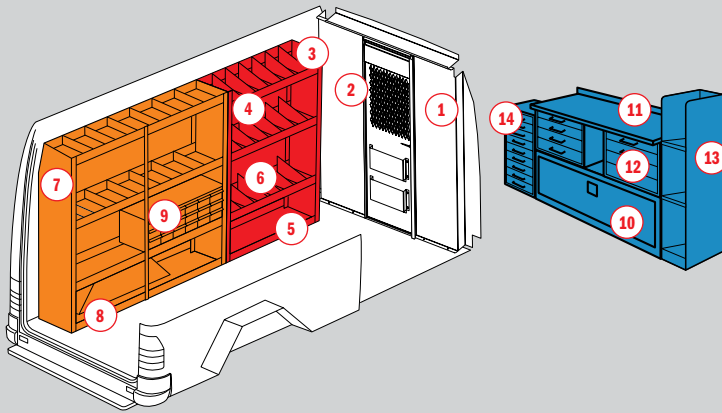

	Model	Description	Quantity
1	85500-3-01	Screen Bulkhead	1
2	85555-3-01	Swing Door Hinge Kit	1
3	8474-3-01	42" x 14" Tapered Shelf Unit	1
4	8935-3-01	Back Panel	3
5	8802-3-01	Retainer Lip	1
6	8115-3-01	Sloped Dividers	3
7	8476-3-01	69" x 14" Tapered Shelf Unit	1
8	8805-3-01	Retainer lip	1
9	8918-3	18 Drawer Parts Cabinet	1
10	8141-3-01	42" Wheel Well Cabinet	1
11	8867-3-01	Work Top	1
12	8901-3	4 Drawer Unit	2
13	8361-3	Literature Holder	1
14	8905-3	9 Drawer Unit	1

CUBE VAN PACKAGE # 600-3026

Package Ship Wt. 916

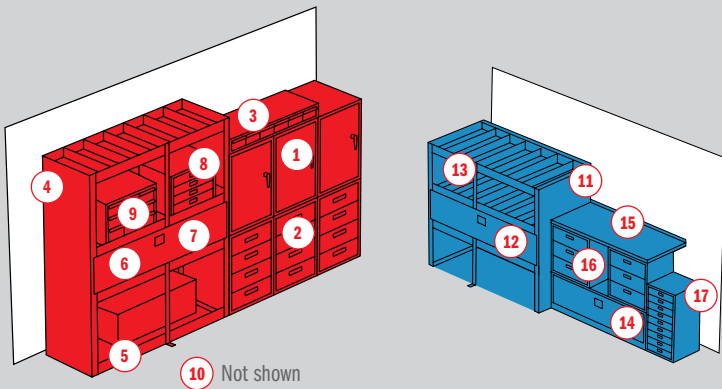

	Model	Description	Quantity
1	8310-3	Lockable Cabinet	3
2	8914-3	4 Drawer Unit	3
3	8906-3	6 Drawer Parts Cabinet	1
4	8384-3-01	51" x 18" Shelf Unit	1
5	8803-3-01	Retainer Lip	1
6	8503-3-01	Shelf Door	1
7	8937-3-01	Back Panel	1
8	8901-3	4 Drawer Unit	1
9	8909-3	9 Drawer Parts Cabinet	1
10	8078-3-01	Cabinet Mounting Brackets	2
11	8391-3-01	51" x 24" Shelf Unit	1
12	8503-3-01	Shelf Door	1
13	8937-3-01	Back Panel	1
14	8141-3-01	42" Wheel Well Cabinet	1
15	8867-3-01	Work Top	1
16	8903-3	3 Drawer Unit	2
17	8905-3	9 Drawer Unit	1

YOU MAY ALSO NEED:

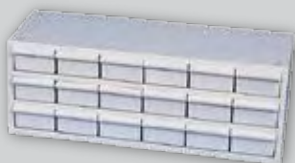

PARTS CABINETS Page 16



FILE BOX Page 18



PARTS BOXES Page 17

FULL-SIZE VAN GM INTERIOR DIMENSIONS

The dimensions shown in this guide refer to the 2007 model year Full-size Chevy Express/GMC Savana. Dimensions printed in blue refer to the 135" wheel base vans, dimensions printed in red refer to the 155" wheel base vans. Dimensions printed in black are common to both. You should always measure your van carefully to make sure the equipment you choose will fit properly.

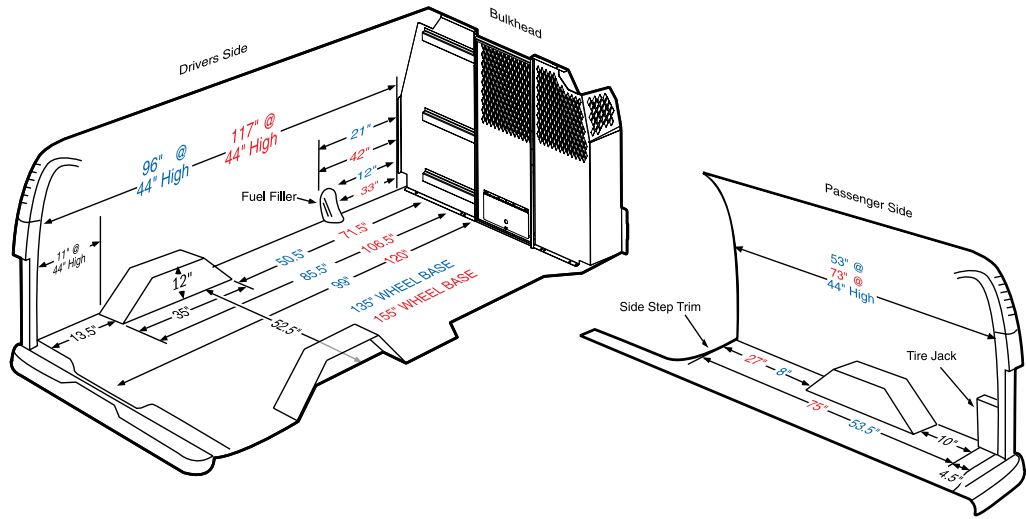

FULL-SIZE VAN FORD INTERIOR DIMENSIONS

The dimensions shown in this guide refer to the 2007 model year Full-size Ford Econoline vans. Dimensions printed in blue refer to standard wheel base vans, dimensions printed in red refer to extended wheel base vans. Dimensions printed in black are common to both. You should always measure your van carefully to make sure the equipment you choose will fit properly.

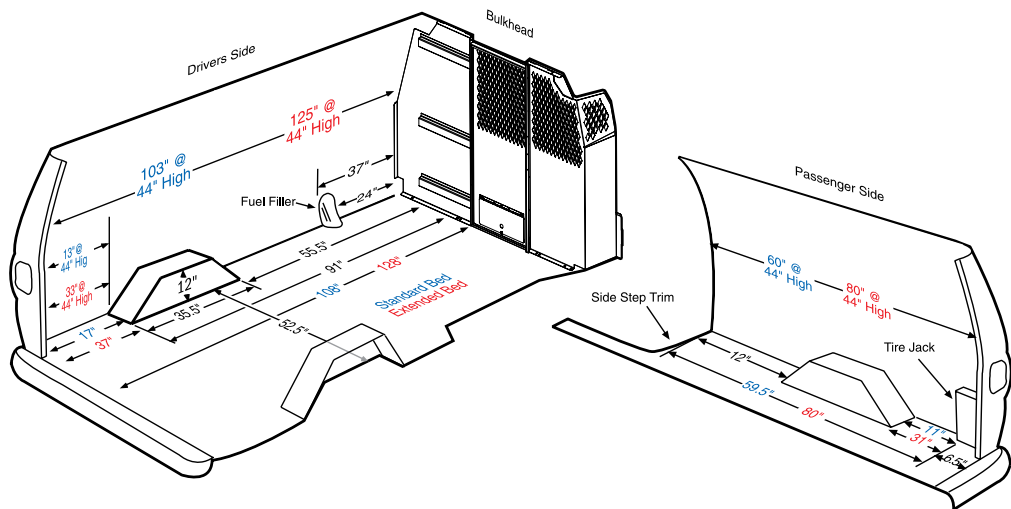

DODGE SPRINTER VAN INTERIOR DIMENSIONS

The dimensions shown in this guide refer to the 2006 model year Sprinter vans. Dimensions printed in blue refer to 118" wheel base vans, dimensions printed in red refer to the 140" wheel base vans and dimensions printed in orange refer to the 158" wheel base vans. Dimensions printed in black are common to all. You should always measure your van carefully to make sure the equipment you choose will fit properly.

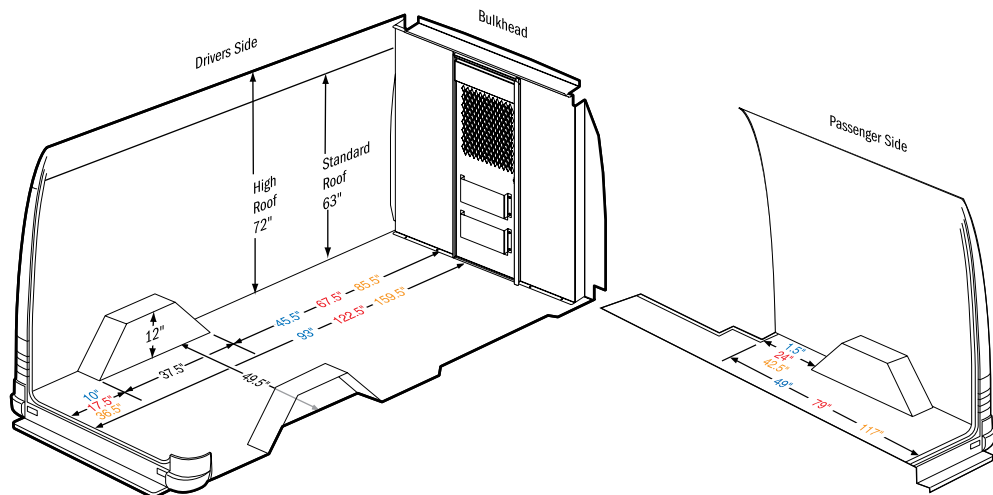

MINIVAN CHEVY UPLANDER INTERIOR DIMENSIONS

The dimensions shown in this guide refer to the 2006 Chevy Uplander. You should always measure your van carefully to make sure the equipment you choose will fit properly.

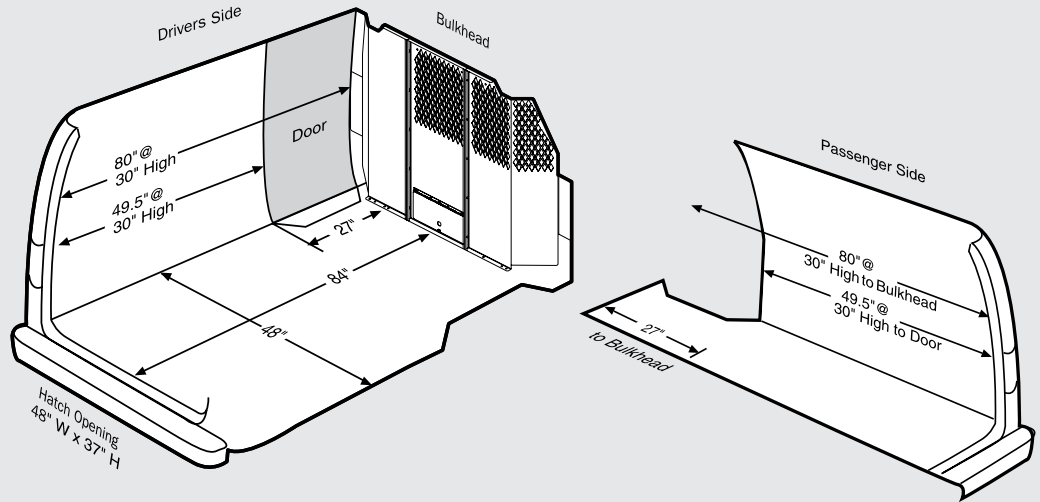

MINIVAN DODGE GRAND CARAVAN CV INTERIOR DIMENSIONS

The dimensions shown in this guide refer to the 2006 Dodge Grand Caravan CV. You should always measure your van carefully to make sure the equipment you choose will fit properly.

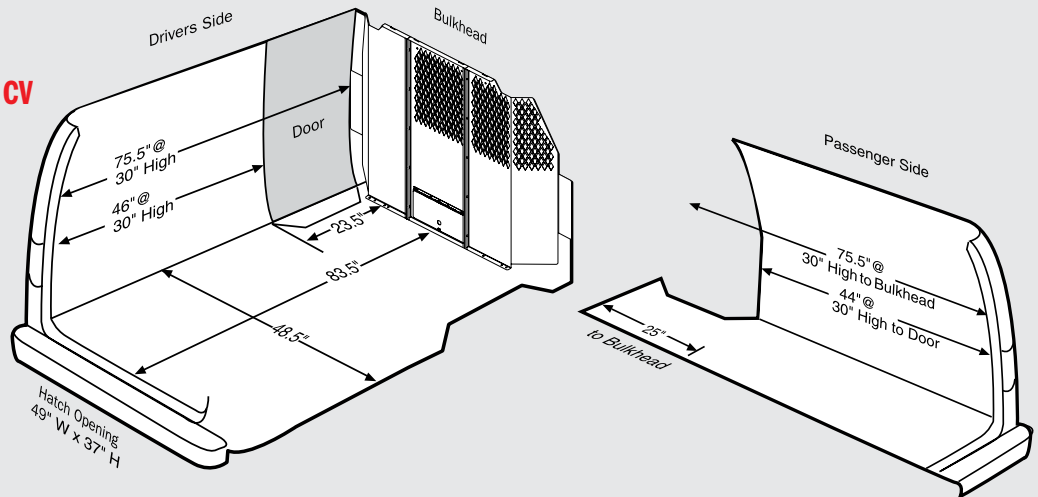

MINIVAN FORD FREESTAR INTERIOR DIMENSIONS

The dimensions shown in this guide refer to the 2006 Ford Freestar. You should always measure your van carefully to make sure the equipment you choose will fit properly.

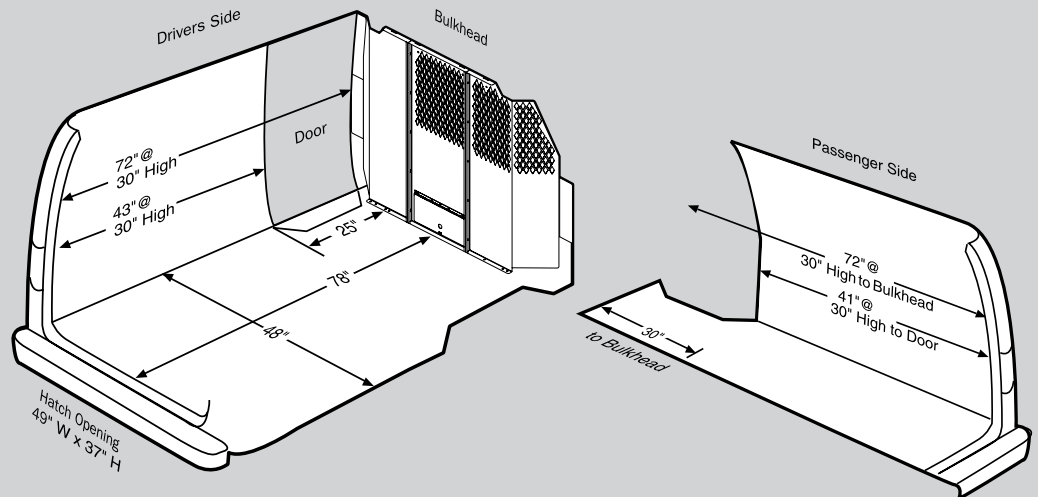

YOUR VAN. YOUR PLAN.



TO HELP YOU PLAN YOUR MOBILE STORAGE, OUR EXCLUSIVE, INTERACTIVE VEHICLE SOLUTIONS™ SOFTWARE PUTS THE WORLD OF WEATHER GUARD® VAN SOLUTIONS AT YOUR FINGERTIPS.

Your van needs to reflect your own individual way of working. Now you can design a storage system around your business and working style with our WEATHER GUARD® VEHICLE SOLUTIONS software. It's easy, fast, and flexible. Here's how:

- Select from almost every make of van, back to the 2000 model year.
- Create a storage system unique to your needs with the simple, easy-to-use customization palette.
- Have total placement control of every feature you choose.
- Watch the software render your plan in 3D for easy evaluation.
- Save your design online and go back to it later if you change your mind or have a new idea.
- Submit a pricing request online, or print out a parts list and 3D drawings to take to your distributor.
- Easy-to-use interface with no measuring, product or advanced technical knowledge necessary.



Check out www.weatherguard.com/vs today

You spend all day in your van. So isn't it about time you design your van so it can be your best tool? Create unexpected efficiencies with WEATHER GUARD VEHICLE SOLUTIONS software.

weather guard

DISTRIBUTED BY:



LIMITED WARRANTY

Our limited warranty guarantees that WEATHER GUARD® Products will be free from defects in material and workmanship for a period of (3) years from the date of purchase by the original retail purchaser. Please call our customer service department toll free at 1.800.456.7865 with any questions or comments.

DO NOT use these products for storing or transporting flammables, explosives, hazardous materials or waste, such as gasoline, solvents, gun powder, dynamite, gases or any tanks, torches or gas powered equipment. These products are intended and safe for storing and transporting small tools and other non-combustible, non-flammable materials. Any modifications made to, or unintended use of these products may create a dangerous condition causing death, serious bodily injury or property damage.

NOTICE

Any modification or unintended use of these products shall immediately void all manufacturers warranties. Manufacturer disclaims all liability for injuries to persons or property resulting from any modification to, or unintended use of these products.

Designs are subject to change without notice. WEATHER GUARD, PACK RAT, ITEMIZER, RED TIPS on Ladder Racks, RED PUSHBUTTON on storage units, BED RAT, and WATCHMAN are U.S. registered trademarks of Knaack Manufacturing Company. EZ-GLIDE System, DOG HATCH, VEHICLE SOLUTIONS are also trademarks of Knaack Manufacturing Company. WEATHER GUARD and PACK RAT are all registered trademarks of Knaack Mfg. Co. in Canada and U.K. WATCHMAN is a registered trademark and WEATHER GUARD is a trademark of Knaack Mfg. Co. in Australia. WATCHMAN and WEATHER GUARD are registered trademarks of Knaack Mfg. Co. in New Zealand. All rights reserved. WEATHER GUARD Products are protected by one or more of the following patents: U.S. 5145087, 5308126, 4509787, 4573731, 4618083, D-346355, D-346994, D-353574, 5829654; Canada 1218968, 1224230, 1235100 and U.K. 2233036; other patents pending.

For U.S. Terms and Conditions of Sale please reference form number 78-1117. For Canada Terms and Conditions of Sale please reference form number 78-1145.



EMERSONTM
Professional Tools