

AUDIOVOX[®]
DRIVEN BY DICE ELECTRONICS

MEDIA BRIDGE
MULTIMEDIA INTEGRATION KIT

for select Audi and Volkswagen vehicles in CDC emulation

Installation Guide/User manual

Made for



iPod



iPhone

Copyrights and Trademarks

Copyright 2012 Audiovox Electronics Corporation

The Audiovox and Audiovox Driven by DICE Electronics logos are trademarks of Audiovox Electronics Corporation

iPod and iPhone are trademarks of Apple, Inc.

All Trademarks and Logos are the property of their respective owners.

All rights reserved.

Printed in China.

Table of Contents

Warning and safety	4	Basic Operation and Settings	21
Product registration	5	iPod Browsing Modes	22
MediaBridge kit contents	6	Controlling the MediaBridge USB memory source	23
Identifying your MediaBridge kit	7	Bluetooth & MAT	24
Supported iPod models.....	8	Paring MediaBridge with your cell phone	25
Note to Installer	9	Answering / making a phone call	25
Connection Diagram	10	Playing music from a cell phone	25
Installation	11	Accessing the auxiliary input	26
A-MBR-1500-AUD Connector	14	Internet Radio Applications	27
A-MBR-1501-AVW R1 Connector	15	Firmware Update	31
A-MBR-1501-AVW R2 Connector.....	16	Troubleshooting	32
A-MBR-1501-AVW R2 Modification	17	Warranty	34
A-MBR-1502-AVW Connector.....	18		
iPod content browsing and charging	19		
iPod locked/unlocked settings	20		

Warning and safety!

Please read these instructions carefully before proceeding. Failure to follow instructions may result in improper operation or injury. Neither Audiovox nor Apple Inc., its regional offices, distributors or resellers take any responsibility for any damage or injury as a result of using the integration kit.

- Do not open, disassemble or alter the interface in any way.
- Do not insert anything into the casing.
- Do not cut or try to alter cables in any way and always use the correct connections.
- Only operate unit when stationary or ask passengers to operate it for you.
- Do not allow the Apple iPod/iPhone to distract you from driving.
- Exercise good judgement and keep your eyes on the road at all times.
- Do not expose unit to extreme temperatures, humidity or shock.
- Keep the unit and iPod/iPhone away from fluids.
- Keep away from children! - Interface components may contain small parts, can be broken or disassembled and components may become loose from vibration and heat. Small components and packaging materials may be a choking hazard when handled by children.



Congratulations on your purchase!

Thank you for purchasing this integration kit. Please review this booklet before operating the unit. This interface was designed and manufactured to seamlessly integrate with your vehicle's factory audio system.

Product registration

We recommend registering your Audiovox product so you can receive news about important firmware updates and have unlimited access to our online support system.

To register your Audiovox product, please complete the following steps:

1. Visit <http://www.audiovoxproducts.com>
2. Look up and save the serial number of the product.
3. Complete the product registration form.
4. Submit the form.
5. Save the registration sheet in a safe place for future reference.

If you are unable to complete the registration via internet, please call Audiovox at 1-800-645-4994.



Prior to installation make sure the module's firmware is up to date to ensure compatibility with the latest features and enhancements. Please refer to page 31 to update firmware.

MediaBridge kit contents



MediaBridge
module



user manual

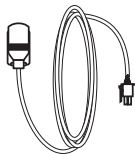

microphone

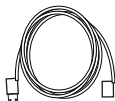

USB
extension

Optional accessory:



Cradle
(A-DCR-150-USB)

For more accessories, visit www.audiovoxproducts.com

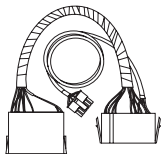

A-MBR-1500-AUD
connector



A-MBR-1501-AVW
R1 connector



A-MBR-1501-AVW
R2 connector

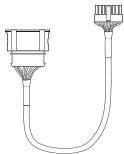

A-MBR-1502-AVW
connector

Only one of these cables is included with each kit!

Identifying your MediaBridge kit

A-MBR-1500-AUD, A-MBR-1501-AVW, A-MBR-1502-AVW.

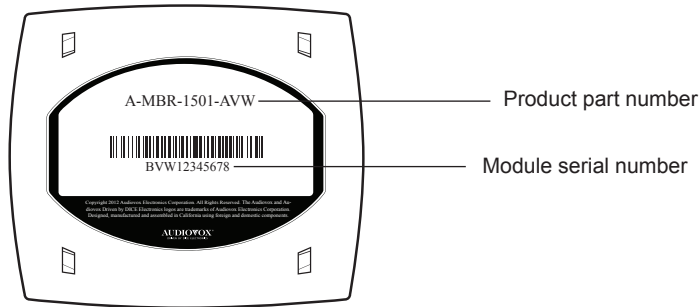

Supported iPod models and firmware version requirements

Model	Firmware / OS Version
1G nano	1.3.1
iPod 5G	1.3
2G nano	1.1.3
iPod classic	1.1.2
3G nano	1.1.3
iPod touch	iOS 3.1.3
iPhone	iOS 3.1.3
iPhone 3G	iOS 4.2.1
4G nano	1.0.4
120 GB classic	2.0.1
2G touch	iOS 4.2.1
iPhone 3GS	iOS 5

Model	Firmware / OS Version
160 GB classic	2.0.4
5G nano	1.0.2
3G touch	iOS 5
iPhone 4	iOS 5
iPhone 4S	iOS 5
4G touch	iOS 5
6G nano	1.2

Attention installer! Please read the following!

Audiovox strongly recommends that the unit be installed in an easily accessible place!

DO NOT PLACE IT BEHIND THE RADIO AND DO NOT HIDE UNDER CARPET!

Whether the unit is professionally or self installed, put the module where you, the end user can get to it easily in the future. (Have the installer show you where the interface module is installed.)

Installing the module behind the radio will make it difficult to:

- Add possible future upgrades, changing software, adding new features, improving operation;
- Access the AUX input on the module to attach any audio device;
- Access the DIP switches located on the module;
- Remove the unit in case of failure.

MAKE SURE THAT THE MODULE IS IN AN ACCESSIBLE PLACE!

Connection diagram

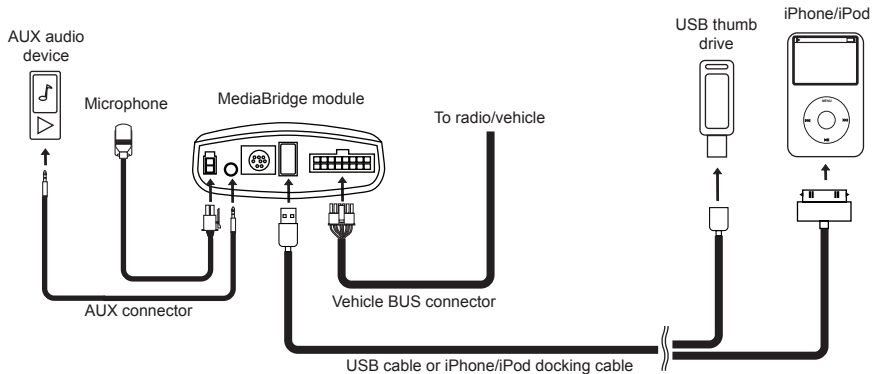

*Only connect an iPod to the standard USB port using an iPod USB cable. Improper connection can cause permanent damage to iPod/SIRIUS module.

Installation

1. Verify compatibility

2. Disconnect battery

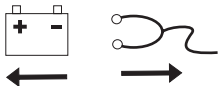

3. Remove radio from car

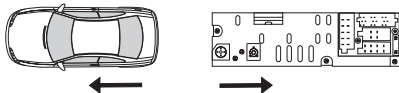

4. Install MediaBridge cable

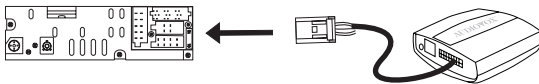

5. Route kit to glove box or other accessible location

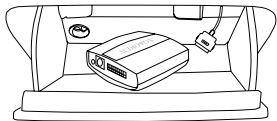

6. Connect battery & test



7. Complete install by re-installing radio

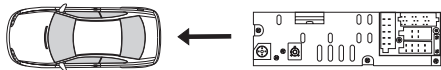

Some radios will enter an anti-theft security mode and will lock requiring the radio's security code to be entered to unlock it. This code can be requested from the vehicle's dealership.

Vehicle BUS Connector - A-MBR-1500-AUD Connector

You can access the CD changer connector located on the back of the radio. Unplug the factory connection if present and plug the A-MBR-1500-AUD connector into the receptacle. The connector should securely lock. Ground wire **MUST** be connected to a stable grounding point.

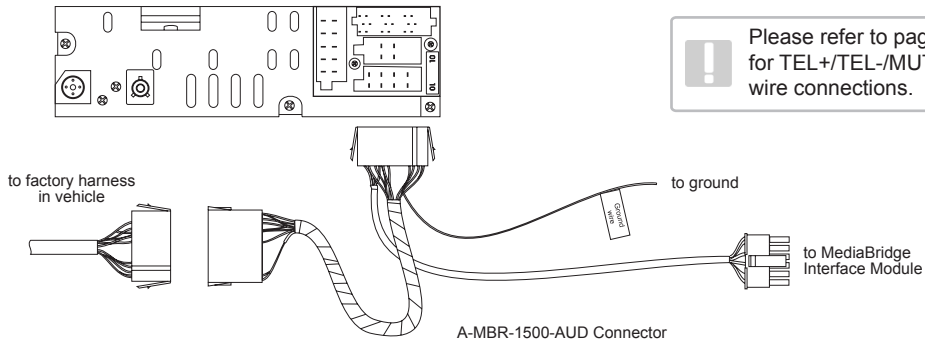

Vehicle BUS Connector - A-MBR-1501-AVW R1 Connector

You can access the CD changer connector located on the back of the radio. Unplug the factory connection if present and plug the A-MBR-1501-AVW R1 connector into the receptacle. The connector should securely lock. Ground wire **MUST** be connected to a stable grounding point.

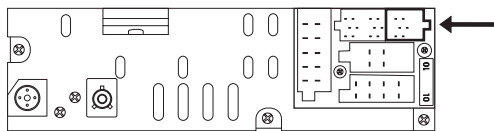

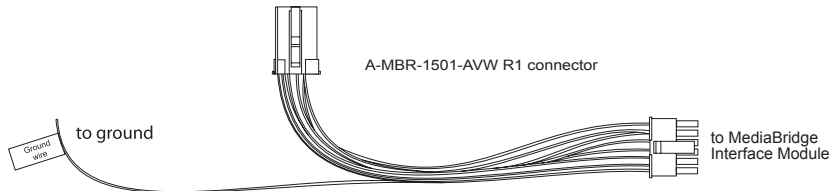

Please refer to page 12
for TEL+/TEL-/MUTE
wire connections.

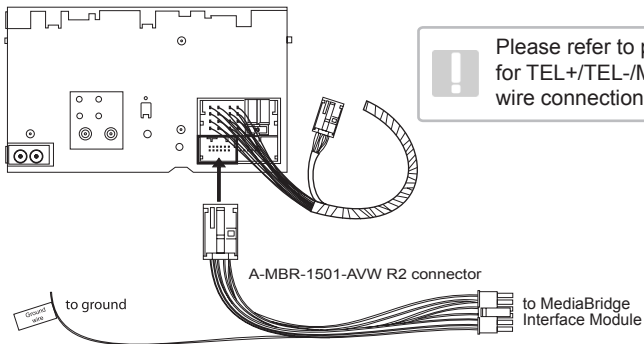

Vehicle BUS Connector - A-MBR-1501-AVW R2 Connector

You can access the CD changer connector located on the back of the radio. Unplug the factory connection if present and plug the A-MBR-1501-AVW R2 connector into the receptacle. The connector should securely lock. Ground wire **MUST** be connected to a stable grounding point.



 Please refer to page 12 for TEL+/TEL-/MUTE wire connections.

A-MBR-1501-AVW R2 Modification

If vehicle is equipped with factory satellite radio and it is to be retained, the harness modification illustrated below is required. **NOTE:** This modification will only work for VW vehicles.

- 1 Disconnect main radio harness and locate SAT connector. Remove it from main harness by pressing on the release tab of the SAT connector.

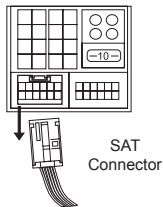

- 2 Slide out the inner part of the SAT connector from plastic housing.

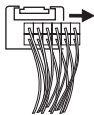

- 3 Disassemble the A-MBR-1501-AVW R2 connector the same way as the factory SAT connector.



- 4 Remove the SAT wires from the factory connector by releasing the pins with a small screw driver or ball point pen.



- 5 Relocate wires to A-MBR-1501-AVW R2 connector keeping the same order and location.

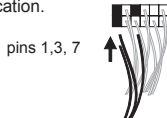

- 6 Put plastic connector covers back on. Insert A-MBR-1501-AVW R2 connector to factory VW main harness.

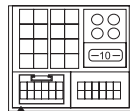

A-MBR-1501-AVW R2 connector

- 7 Connect ground wire to chassis of radio.

Vehicle BUS Connector - A-MBR-1502-AVW Connector

The connection for this is made at the external CD-changer connection in certain Audi/VW vehicles. On VW models, the connection is usually in the trunk (does not apply to vehicles that came with a CD-changer built in to the radio). For Audi vehicles, the connection is inside the glove box, standard with navigation radios and/or single-CD radios (also does not apply for vehicles that came with a CD-changer built in to the radio). The external CD-changer cannot be retained.

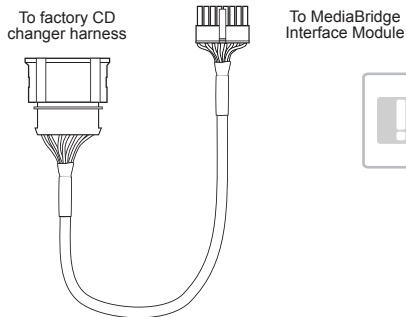

Please refer to page 12
for TEL+/TEL-/MUTE
wire connections.

Operating MediaBridge as an audio source

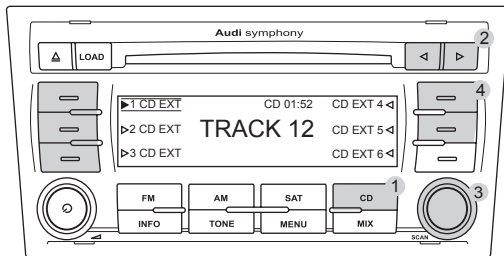

- 1 Radio source selector (CDC / MediaBridge)
- 2 Press for Next / Previous track, hold to rewind or fast forward.
- 3 Turn to change track
- 4 Press to change DISC

iPod content browsing

MediaBridge has iPod music browsing which allows you to playback songs based on different modes of selection. When a Playlist has been selected and then Artist mode is accessed, only Artists within the Playlist will be selectable. When an Artist has been selected and then Album mode is accessed, only Albums by the selected Artist will be selectable. Refer to the diagram on the right to see how the iPod browsing mode hierarchy works. If your iPod music playback selection seems limited, to access more of your music find your iPods main Playlist in Playlist mode or select a song on the iPod itself.



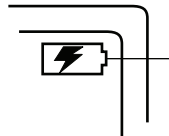

Charging

The interface automatically charges the battery of the iPod when connected and your vehicle ignition key is in the ACC/ON position.



Charging may be shown by an icon that appears on the upper right corner of the iPod screen. May vary by model.

iPod locked/unlocked settings and features

	iPod hold ON	iPod hold OFF
		
Radio control	✓	Limited
iPod control	✗	✓
	Before connecting the iPod to the module, turn the hold switch ON to fully control and browse the songs from the wireless remote. The iPod is locked in this state.	Before connecting the iPod to the module, turn the hold switch OFF to fully control and browse the songs from iPod. Browsing capabilities are limited from the wireless remote.

Note: Setting the iPod's hold switch must be done prior to connecting it to the dock cable.
 iPod nano 6th generation will always be in locked mode since it does not have a lock switch.

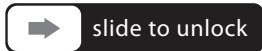

For iPod touch and iPhone, when the screen is not active (as shown on the left), the iPod/iPhone is locked (Press the power button to lock the iPhone/iPod Touch).

Basic operation and settings

Accessing the MediaBridge as the audio source:

Much like the radio's AM/FM tuner, satellite radio or CD audio sources, the MediaBridge is integrated to be part of the vehicle's audio system. To access the MediaBridge source, press the CD button. Pressing this button repeatedly will cycle through sources present in the vehicle (CD > MediaBridge).

MediaBridge source selection:

The MediaBridge adds additional audio sources including iPod and auxiliary audio input. To cycle between these sources, use the TRACK buttons within the first 5 seconds of accessing the MediaBridge as the audio source.

TRACK 1 = USB/iPod

TRACK 2 = Bluetooth

TRACK 5 = Auxiliary audio source

Note: The MediaBridge source being selected is announced with a spoken message. Please wait one second after pressing a button to select a source to hear the spoken announcement.

MediaBridge Gain Settings

Select DISC 3 to change default volume level; use track up/down to adjust between Min and Max. Use TRACK up/down to cycle settings:

TRACK 1 = min. volume

TRACK 26 = default volume

TRACK 32 = max volume

Select DISC 1 to apply settings and resume audio playback. Use TRACK up/down to select MediaBridge audio source.

DISC 2, 4, 5 and 6 are NOT selectable because they have no settings available.

iPod Browsing Modes

In CDC Emulation, you can browse the content on your iPod by various modes: song, playlist, artist, album, podcast and audiobook. Each DISC button has a mode assigned to it as illustrated below.

- Press DISC button to select mode, then use next/previous track buttons to browse contents within the selected mode.



DISC 3, 5 and 6 iPod browsing modes are only available when the iPod is locked.

Icon Legends



Controlling the MediaBridge USB memory source

- Select DISC 1, then use the TUNE/TRACK buttons to change from song to song.
- Select DISC 2 to access Folders and use the TUNE/TRACK buttons to navigate through the folders on your USB flash drive.
- The MediaBridge unit will recognize the first 8 levels of folders, with up to 200 accessible folders within each folder. Only the first 1000 files will be read in each folder, the rest will be ignored.
- Songs play in order of when they were added to the flash drive.

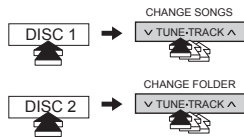

Bluetooth & MAT (Music Announcer Technology) configuration

To alter voice announcement and Bluetooth pairing settings select Bluetooth as your audio source, press the DISC button that corresponds to the feature you want to configure, and then use track or channel UP/DOWN to browse through configuration options:

- **DISC 1, 2 or 3** should be selected if you want to control Bluetooth audio streaming playback.
- **DISC 4** controls the Autoconnect feature. Available options are Enable and Disable. This controls whether or not the MediaBridge will reconnect automatically when phone becomes disconnected. Only the most recently paired device will be reconnected automatically.
- **DISC 5** controls the paired devices memory. There is only one option. Tune or change tracks to clear the listing of paired devices with the MediaBridge and put module into discoverable mode.
- **DISC 6** controls MAT setting. Available options are Default, Extended, Phone only, and Off (refer to the chart below).

Options	Function
Default	Reset MAT back to factory default configuration
Extended	Turn on ALL MAT feature
Phone only	Turn on the phone relative MAT only
Off	Turn off MAT completely

Pairing MediaBridge with your cell phone via Bluetooth

1. Turn on the Bluetooth feature on your cell phone.
2. Select MediaBridge as your audio source from your radio, then select Bluetooth mode.
3. Search device from your cell phone.
4. Select MediaBridge from device list and enter password "0000" to connect.

Note: MediaBridge is only discoverable for Bluetooth pairing for the first 60 seconds after selecting Bluetooth mode within the MediaBridge. Listen for an announcement saying "MediaBridge Discoverable". Please perform pairing while the vehicle is parked. Bluetooth devices remain paired 30 seconds after exiting MediaBridge mode, within this time active audio streams and phone calls aren't audible on the phone but can be resumed by re-entering MediaBridge mode.

Answering / Making a phone call

- To answer an incoming call, press the button that tunes to the next track or channel.
- To reject an incoming call or terminate an active call, press the button that tunes to the previous track or channel.
- To make an outgoing call, dial on the phone like you would normally.



Phone calls interrupt any music/ audio that is currently playing on the radio while MediaBridge is the selected audio source.

Playing music from a cell phone through MediaBridge via Bluetooth

1. Enter Bluetooth mode on MediaBridge.
2. Make sure your cell phone is paired with MediaBridge.
3. Select and play a song from your cell phone's music player.

Note: Some cell phones require you to manually select the option to play music via (A2DP) Bluetooth Streaming. Song information is shown on the radio display if your phone supports AVRCP1.3.

4. Use Track UP/DOWN to skip tracks / FF / RW songs on the AVRCP compatible phone.

Accessing the auxiliary input

- An auxiliary audio device can be connected to the MediaBridge unit through its 1/8" headphone jack.
- In AUX mode, music is controlled only through the auxiliary audio device.
- Audio equalizer setting can be adjusted while in auxiliary mode by selecting DISC 1-4 and using seek/track/tune buttons to increase or decrease levels. DISC numbers and corresponding settings are shown on the right chart.

TIP: Ensure the volume is turned up on your Auxiliary device.

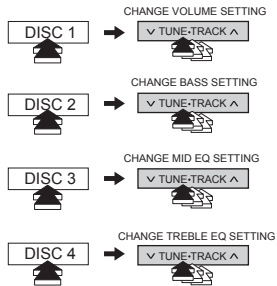
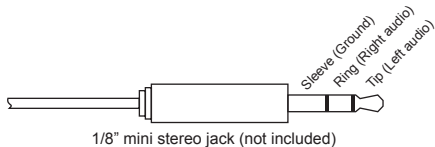

Internet Radio Application support (iPhone/iPod touch)

This kit includes support for internet radio streaming apps available on the iTunes® Store. Thousands of stations can be streamed through data connections. Supported apps include Livio Car Internet Radio, Pandora, iHeart Radio and more. Supported features such as text display on screen, and next/previous track functions will vary by app.

To learn more about each app specifically, please visit the website for the app you need information about.

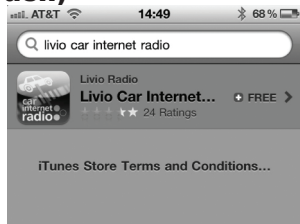

Data connection requirements (3G/4G/WiFi)

Users must have an active wireless data connection in order to stream music from an app while in the car. Data connections including "3G" or "4G" through wireless carriers, or a third party wireless Internet access point connected to your mobile device through WiFi will work. Because this app requires a data connection, it will only work on connected devices such as the iPhone and iPod touch.

Controlling Internet Radio Apps

NOTE: The following features may not be supported by all apps. For demonstration purposes the following examples will show the features for the Livio Car Internet Radio app.

The app must be active on the screen of the device. To do so, simply tap the app's icon and it will load.

Next/previous TRACK buttons execute application specific features such as skipping stream or cycling between station presets. **DISC (1-6) buttons** are associated with station presets when used with the Livio Car Internet Radio application.

iPhone operating system iOS5 enabled application developers to share the “now playing” screen information. For example, when using the Pandora App, you will see artist, album and song information on the radio's screen. When using an application that doesn't implement this feature, or running iOS4, only the name of the application will be shown.

Please note that although iOS 4 (4.2.1) is supported on iPhone 3G and iTouch 2nd generation, applications do not run in the background. As such, loading the app takes longer than on devices where the app is present in the background.



If your listening experience is interrupted by a call, under most conditions, the app will resume playback at the end of the call.

Music playback apps running on your iPhone are sent to background automatically when the home button of the phone is pressed, but the music playback itself is not stopped.

To resume playback of your iPod music library, stop Livio playback by tapping on the screen below the Livio Radio logo. An icon representing “stop” will show on the main Livio screen. Press the home button to send the application to the background. (Other apps may need to be terminated manually. Please see next page.)

A few seconds after this, the iPod music playback application will reinitialize itself and become active again if the iPod was locked when it was connected to the kit. (This is indicated by an Accessory Connected message being shown when the iPod icon is tapped.)

If the iPod was in unlocked state when it was connected to the kit, press the play button on the iPod application.

Terminate (kill) the App

If you need to terminate (kill) the app please follow the steps below:

1. Double-tap on the home button of the iPhone to bring up the list of running apps. If you don't see the app's icon right away, swipe the screen left or right to locate it. Note: If you do not see such task bar but rather a music control popup then you have an iOS device that does not support background run of apps, therefore this section is not applicable to you.
2. Press and hold the icon of the app until a red minus icon shows.
3. Tap the red minus icon shown on top of the app.
4. This will close the app.
5. In a few seconds, the iPod music playback app should reinitialize itself and become active again. This can be verified by going back to the list of running apps and swiping the screen until the music control section is shown. The iPod app icon next to the music control sections shows that iPod is your audio source.

Internet Radio App settings

Many radio stations offer lower bitrates. Selecting streams with a lower bitrate will reduce data usage and may reduce stream interruptions during the drive. For example with the Livio Car Internet Radio app, to adjust bitrates manually, users can: Go to the Setting menu of the device, select the Livio Radio settings the change the Maximum Bitrate Filter and set it to 64K. Other settings such as Buffer time and Reliability filter may also help in getting a more stable connection.

Updating firmware (Mac OS illustrated)



Connect module via mini USB



Device specifications and update selection

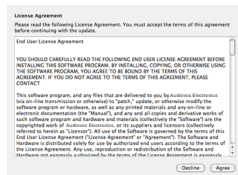

License Agreement (click Agree to proceed)

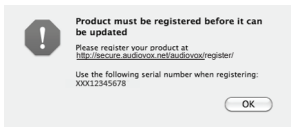

Product registration notification

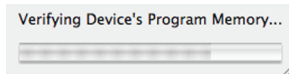

Firmware update progress

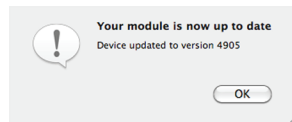

Module updated successfully!

The above screen shots are for illustration purposes only.

Troubleshooting

Problem	Solution
iPod does not charge.	Check all connections. See if iPod charges while connected to computer or wall charger. You may need to reset the iPod.
Music is distorted or sound level is too low with iPod connected.	Make sure all EQ and BASS boost options are turned off on your iPod. GAIN settings can be adjusted on your MediaBridge.
Why is the interface not controlling the iPod/USB drive?	Please make sure that the USB connection is not loose. Make sure that an iPod case is not preventing the dock connector from being fully seated. Disconnect and reconnect the device. If iPod is not responding please try resetting it. USB device must also be FAT16/32 format and contain supported MP3, WMA or AAC content.
What size of USB flash drive should I use?	Large capacities are supported, however up to 4GB is recommended for optimal user experience.
No audio from iPod source.	Try selecting a different track or use DISC 2 (Playlist Mode). Verify proper connection to iPod/interface. Check for compatibility. Older iPod models don't support USB audio.

Problem	Solution
Cannot select the interface.	Check DIP switch settings. With the ignition OFF disconnect vehicle harness from module for a few seconds and reconnect. Verify that the correct button is used to access the interface.
Radio/ steering wheel controls do not operate iPod.	Reset iPod and make sure the most recent iPod firmware is installed. Check vehicle user manual on how steering wheel controls work, long presses may toggle alternate function.

**AUDIOVOX®****12 MONTH LIMITED WARRANTY**

AUDIOVOX ELECTRONICS CORP. (the Company) warrants to the original retail purchaser of this product that should this product or any part thereof, under normal use and conditions, be proven defective in material or workmanship within 12 months from the date of original purchase, such defect(s) will be repaired or replaced with reconditioned product (at the Company's option) without charge for parts and repair labor. A game controller, if supplied, is similarly warranted for ninety (90) days.

To obtain repair or replacement within the terms of this Warranty, the product is to be delivered with proof of warranty coverage (e.g. dated bill of sale), specification of defect(s), transportation prepaid, to the Company at the address shown below.

This Warranty does not extend to the elimination of externally generated static or noise, to correction of antenna problems, to costs incurred for installation, removal or reinstallation of the product, or to damage to digital memory/media devices, gaming devices, discs, speakers, accessories, or vehicle electrical systems.

This Warranty does not apply to any product or part thereof which, in the opinion of the Company, has suffered or been damaged through alteration, improper installation, mishandling, misuse, neglect, accident, or by removal or defacement of the factory serial number/bar code label(s). THE EXTENT OF THE COMPANY'S LIABILITY UNDER THIS WARRANTY IS LIMITED TO THE REPAIR OR REPLACEMENT PROVIDED ABOVE AND, IN NO EVENT, SHALL THE COMPANY'S LIABILITY EXCEED THE PURCHASE PRICE PAID BY PURCHASER FOR THE PRODUCT.

This Warranty is in lieu of all other express warranties or liabilities. ANY IMPLIED WARRANTIES, INCLUDING ANY IMPLIED WARRANTY OF MERCHANTABILITY, SHALL BE LIMITED TO THE DURATION OF THIS WRITTEN WARRANTY. ANY ACTION FOR BREACH OF ANY WARRANTY HEREUNDER INCLUDING ANY IMPLIED WARRANTY OF MERCHANTABILITY MUST BE BROUGHT WITHIN A PERIOD OF 24 MONTHS FROM DATE OF ORIGINAL PURCHASE. IN NO CASE SHALL THE COMPANY BE LIABLE FOR ANY CONSEQUENTIAL OR INCIDENTAL DAMAGES FOR BREACH OF THIS OR ANY OTHER WARRANTY. No person or representative is authorized to assume for the Company any liability other than expressed herein in connection with the sale of this product.

Some states do not allow limitations on how long an implied warranty lasts or the exclusion or limitation of incidental or consequential damage so the above limitations or exclusions may not apply to you. This Warranty gives you specific legal rights and you may also have other rights which vary from state to state.

Installation notes:

Installed by:

Installed date:

Other notes:

Illustration:

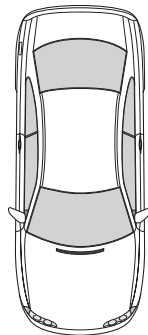

Audi and Volkswagen compatible integration
for iPhone, Internet Radio, Bluetooth, AUX and SIRIUS.
www.audiovoxproducts.com

OMA-MBR-1500-AUD-062012
OMA-MBR-1501-AVW-062012
OMA-MBR-1502-AVW-062012



For Customer Service
Visit Our Website At
www.audiovoxproducts.com
Product Information, Photos,
FAQ's, Owner's Manuals



AUDIOVOX
ELECTRONICS CORP.

150 Marcus Blvd., Hauppauge, New York 11788
©2012 Made in China • Fabriqué en Chine • Hecho en China



SAVE ENVIRONMENT
PLEASE RECYCLE

ECONOMISER L'ENVIRONNEMENT
RECYCLEZ S'IL VOUS PLAÎT
EXCEPTO EL AMBIENTE
RECICLE POR FAVOR